



Test Report No.: RF2305WDG0021-1



# TEST REPORT

|           |  |
|-----------|--|
| Applicant | Harman International Industries, Inc.      |
| Address   | 30001 Cabot Drive Novi, Michigan 48377 USA |

|                                      |  |
|--------------------------------------|--|
| Manufacturer or Supplier             | Harman International Industries, Inc.      |
| Address                              | 30001 Cabot Drive Novi, Michigan 48377 USA |
| Product                              | Portable Bluetooth Speaker                 |
| Brand Name                           | JBL  |
| Model                                | TOYOTA JBL FLEX                            |
| Additional Models & Model Difference | N/A  |
| Date of tests                        | Jun. 15, 2023 ~ Jul. 10, 2023              |

the tests have been carried out according to the requirements of the following standards:

**FCC Part 15, Subpart C, Section 15.247**

**CONCLUSION: The submitted sample was found to COMPLY with the test requirement**

Tested by Eric Fang  
Project Engineer / EMC Department

Approved by Glyn He  
Assistant Manager / EMC Department

Date: Aug. 04, 2023

This report is governed by, and incorporates by reference, the Conditions of Testing as posted at the date of issuance of this report at <http://www.bureauveritas.com/home/about-us/our-business/cps/about-us/terms-conditions/> and is intended for your exclusive use. Any copying or replication of this report to or for any other person or entity, or use of our name or trademark, is permitted only with our prior written permission. This report sets forth our findings solely with respect to the test samples identified herein. The results set forth in this report are not indicative or representative of the quality or characteristics of the lot from which a test sample was taken or any similar or identical product unless specifically and expressly noted. Our report includes all of the tests requested by you and the results thereof based upon the information that you provided to us. Measurement uncertainty is only provided upon request for accredited tests. Statements of conformity are based on simple acceptance criteria without taking measurement uncertainty into account, unless otherwise requested in writing. You have 60 days from date of issuance of this report to notify us of any material error or omission caused by our negligence or if you require measurement uncertainty; provided, however, that such notice shall be in writing and shall specifically address the issue you wish to raise. A failure to raise such issue within the prescribed time shall constitute your unqualified acceptance of the completeness of this report, the tests conducted and the correctness of the report contents



## TABLE OF CONTENTS

|  |           |
|--|-----------|
| RELEASE CONTROL RECORD .....                                     | 5         |
| <b>1 SUMMARY OF TEST RESULTS.....</b>                            | <b>6</b>  |
| <b>2 MEASUREMENT UNCERTAINTY .....</b>                           | <b>6</b>  |
| <b>3 GENERAL INFORMATION .....</b>                               | <b>7</b>  |
| 3.1 GENERAL DESCRIPTION OF EUT.....                              | 7         |
| 3.2 DESCRIPTION OF TEST MODES.....                               | 8         |
| 3.2.1 CONFIGURATION OF SYSTEM UNDER TEST .....                   | 9         |
| 3.2.2 TEST MODE APPLICABILITY AND TESTED CHANNEL DETAIL.....     | 9         |
| 3.3 GENERAL DESCRIPTION OF APPLIED STANDARDS.....                | 11        |
| 3.4 DESCRIPTION OF SUPPORT UNITS.....                            | 11        |
| 3.5 CONFIGURATION OF SYSTEM UNDER TEST.....                      | 11        |
| 3.6 DUTY CYCLE OF TESET SIGNAL .....                             | 12        |
| <b>4 TEST TYPES AND RESULTS.....</b>                             | <b>13</b> |
| 4.1. CONDUCTED EMISSION MEASUREMENT .....                        | 13        |
| 4.1.1 LIMITS OF CONDUCTED EMISSION MEASUREMENT .....             | 13        |
| 4.1.2 TEST INSTRUMENTS.....                                      | 13        |
| 4.1.3 TEST PROCEDURES .....                                      | 14        |
| 4.1.4 DEVIATION FROM TEST STANDARD .....                         | 14        |
| 4.1.5 TEST SETUP.....  | 15        |
| 4.1.6 EUT OPERATING CONDITIONS .....                             | 15        |
| 4.1.7 TEST RESULTS.....  | 16        |
| 4.2. RADIATED EMISSION AND BANDEDGE MEASUREMENT .....            | 18        |
| 4.2.1 LIMITS OF RADIATED EMISSION AND BANDEDGE MEASUREMENT ..... | 18        |
| 4.2.2 TEST INSTRUMENTS.....                                      | 19        |
| 4.2.3 TEST PROCEDURES .....                                      | 20        |
| 4.2.4 DEVIATION FROM TEST STANDARD .....                         | 21        |
| 4.2.5 TEST SETUP.....  | 21        |
| 4.2.6 EUT OPERATING CONDITIONS .....                             | 22        |
| 4.2.7 TEST RESULTS.....  | 23        |
| 4.3 NUMBER OF HOPPING FREQUENCY USED.....                        | 31        |
| 4.3.1 LIMIT OF HOPPING FREQUENCY USED .....                      | 31        |
| 4.3.2 TEST SETUP.....  | 31        |
| 4.3.3 TEST INSTRUMENTS.....                                      | 31        |
| 4.3.4 TEST PROCEDURES .....                                      | 32        |



**Test Report No.: RF2305WDG0021-1**

|       |   |    |
|-------|---|----|
| 4.3.5 | DEVIATION FROM TEST STANDARD .....                | 32 |
| 4.3.6 | TEST RESULTS.....                                 | 32 |
| 4.4   | DWELL TIME ON EACH CHANNEL .....                  | 35 |
| 4.4.1 | LIMIT OF DWELL TIME USED .....                    | 35 |
| 4.4.2 | TEST SETUP .....                                  | 35 |
| 4.4.3 | TEST INSTRUMENTS.....                             | 35 |
| 4.4.4 | TEST PROCEDURES .....                             | 35 |
| 4.4.5 | DEVIATION FROM TEST STANDARD .....                | 36 |
| 4.4.6 | TEST RESULTS.....                                 | 36 |
| 4.5   | CHANNEL BANDWIDTH.....                            | 39 |
| 4.5.1 | LIMITS OF CHANNEL BANDWIDTH .....                 | 39 |
| 4.5.2 | TEST SETUP .....                                  | 39 |
| 4.5.3 | TEST INSTRUMENTS.....                             | 39 |
| 4.5.4 | TEST PROCEDURE.....                               | 39 |
| 4.5.5 | DEVIATION FROM TEST STANDARD .....                | 39 |
| 4.5.6 | EUT OPERATING CONDITION.....                      | 39 |
| 4.5.7 | TEST RESULTS.....                                 | 40 |
| 4.6   | HOPPING CHANNEL SEPARATION .....                  | 44 |
| 4.6.1 | LIMIT OF HOPPING CHANNEL SEPARATION .....         | 44 |
| 4.6.2 | TEST SETUP .....                                  | 44 |
| 4.6.3 | TEST INSTRUMENTS.....                             | 44 |
| 4.6.4 | TEST PROCEDURES .....                             | 44 |
| 4.6.5 | DEVIATION FROM TEST STANDARD .....                | 44 |
| 4.6.6 | TEST RESULTS.....                                 | 45 |
| 4.7   | CONDUCTED OUTPUT POWER .....                      | 49 |
| 4.7.1 | LIMITS OF CONDUCTED OUTPUT POWER MEASUREMENT..... | 49 |
| 4.7.2 | TEST SETUP .....                                  | 49 |
| 4.7.3 | TEST INSTRUMENTS.....                             | 49 |
| 4.7.4 | TEST PROCEDURES .....                             | 49 |
| 4.7.5 | DEVIATION FROM TEST STANDARD .....                | 49 |
| 4.7.6 | EUT OPERATING CONDITION.....                      | 50 |
| 4.7.7 | TEST RESULTS.....                                 | 50 |
| 4.8   | OUT OF BAND EMISSION MEASUREMENT .....            | 52 |
| 4.8.1 | LIMITS OF OUT OF BAND EMISSION MEASUREMENT .....  | 52 |
| 4.8.2 | TEST INSTRUMENTS.....                             | 52 |
| 4.8.3 | TEST PROCEDURE.....                               | 52 |
| 4.8.4 | DEVIATION FROM TEST STANDARD .....                | 52 |



**BUREAU  
VERITAS**

**Test Report No.: RF2305WDG0021-1**

|          |   |           |
|----------|---|-----------|
| 4.8.5    | EUT OPERATING CONDITION.....  | 52        |
| 4.8.6    | TEST RESULTS.....   | 52        |
| <b>5</b> | <b>PHOTOGRAPHS OF THE TEST CONFIGURATION .....</b>  | <b>57</b> |
| <b>6</b> | <b>APPENDIX A - MODIFICATIONS RECORDERS FOR ENGINEERING CHANGES TO THE<br/>EUT BY THE LAB .....</b> | <b>58</b> |



Test Report No.: RF2305WDG0021-1

## RELEASE CONTROL RECORD

| ISSUE NO.       | REASON FOR CHANGE | DATE ISSUED   |
|-----------------|-------------------|---------------|
| RF2305WDG0021-1 | Original release  | Aug. 04, 2023 |

## 1 SUMMARY OF TEST RESULTS

The EUT has been tested according to the following specifications:

| APPLIED STANDARD: FCC Part 15, Subpart C |   |        |                                |
|--|---|--------|--------------------------------|
| STANDARD SECTION                         | TEST TYPE AND LIMIT   | RESULT | REMARK                         |
| 15.207                                   | AC Power Conducted Emission   | PASS   | Meet the requirement of limit. |
| 15.247(a)(1)(iii)                        | Number of Hopping Frequency Used  | PASS   | Meet the requirement of limit. |
| 15.247(a)(1)(iii)                        | Dwell Time on Each Channel  | PASS   | Meet the requirement of limit. |
| 15.247(a)(1)                             | 1. Hopping Channel Separation<br>2. Spectrum Bandwidth of a Frequency Hopping Sequence Spread Spectrum System | PASS   | Meet the requirement of limit. |
| 15.247(b)                                | Conducted Output Power  | PASS   | Meet the requirement of limit. |
| 15.247(d)&15.209                         | Transmitter Radiated Emission   | PASS   | Meet the requirement of limit. |
| 15.247(d)                                | Out of band Emission Measurement  | PASS   | Meet the requirement of limit. |
| 15.203                                   | Antenna Requirement   | PASS   | No antenna connector is used.  |

## 2 MEASUREMENT UNCERTAINTY

Where relevant, the following measurement uncertainty levels have been estimated for tests performed on the EUT as specified in CISPR 16-4-2:

| MEASUREMENT         | FREQUENCY     | UNCERTAINTY |
|---------------------|---------------|-------------|
| Conducted emissions | 9kHz~30MHz    | 2.68dB      |
| Radiated emissions  | 9KHz ~ 30MHz  | 2.80dB      |
|                     | 30MHz ~ 1GMHz | 4.24dB      |
|                     | 1GHz ~ 18GHz  | 4.76dB      |
|                     | 18GHz ~ 40GHz | 4.50dB      |

This uncertainty represents an expanded uncertainty expressed at approximately the 95% confidence level using a coverage factor of k=2.

### 3 GENERAL INFORMATION

#### 3.1 GENERAL DESCRIPTION OF EUT

|                              |   |
|------------------------------|---|
| <b>PRODUCT</b>               | Portable Bluetooth Speaker  |
| <b>MODEL NO.</b>             | TOYOTA JBL FLEX   |
| <b>ADDITIONAL MODELS</b>     | N/A   |
| <b>FCC ID</b>                | 2AHPN-FLEX1G  |
| <b>POWER SUPPLY</b>          | DC 7.5V From Battery or DC 5V From USB Host Unit or Powered from Dock |
| <b>MODULATION TECHNOLOGY</b> | FHSS  |
| <b>MODULATION TYPE</b>       | GFSK, $\pi/4$ DQPSK, 8DPSK  |
| <b>OPERATING FREQUENCY</b>   | 2402MHz~2480MHz   |
| <b>NUMBER OF CHANNEL</b>     | 79  |
| <b>PEAK OUTPUT POWER</b>     | 3.373mW (Max. Measured)   |
| <b>ANTENNA TYPE</b>          | PCB Antenna, 2.46dBi Gain   |
| <b>I/O PORTS</b>             | Refer to user's manual  |
| <b>CABLE SUPPLIED</b>        | USB-A to USB-C Line: Shielded, Detachable 1m                          |
| <b>ACCESSORY</b>             | N/A   |

#### NOTES:

1. For a more detailed features description, please refer to the manufacturer's specifications or the user's manual.
2. For the test results, the EUT had been tested with all conditions. But only the worst case was shown in test report.
3. Please refer to the EUT photo document (Reference No.: 2305WDG0021-3) for detailed product photo.

### 3.2 DESCRIPTION OF TEST MODES

79 channels are provided to this EUT:

| CHANNEL | FREQ.<br>(MHz) | CHANNEL | FREQ.<br>(MHz) | CHANNEL | FREQ.<br>(MHz) | CHANNEL | FREQ.<br>(MHz) |
|---------|----------------|---------|----------------|---------|----------------|---------|----------------|
| 0       | 2402           | 20      | 2422           | 40      | 2442           | 60      | 2462           |
| 1       | 2403           | 21      | 2423           | 41      | 2443           | 61      | 2463           |
| 2       | 2404           | 22      | 2424           | 42      | 2444           | 62      | 2464           |
| 3       | 2405           | 23      | 2425           | 43      | 2445           | 63      | 2465           |
| 4       | 2406           | 24      | 2426           | 44      | 2446           | 64      | 2466           |
| 5       | 2407           | 25      | 2427           | 45      | 2447           | 65      | 2467           |
| 6       | 2408           | 26      | 2428           | 46      | 2448           | 66      | 2468           |
| 7       | 2409           | 27      | 2429           | 47      | 2449           | 67      | 2469           |
| 8       | 2410           | 28      | 2430           | 48      | 2450           | 68      | 2470           |
| 9       | 2411           | 29      | 2431           | 49      | 2451           | 69      | 2471           |
| 10      | 2412           | 30      | 2432           | 50      | 2452           | 70      | 2472           |
| 11      | 2413           | 31      | 2433           | 51      | 2453           | 71      | 2473           |
| 12      | 2414           | 32      | 2434           | 52      | 2454           | 72      | 2474           |
| 13      | 2415           | 33      | 2435           | 53      | 2455           | 73      | 2475           |
| 14      | 2416           | 34      | 2436           | 54      | 2456           | 74      | 2476           |
| 15      | 2417           | 35      | 2437           | 55      | 2457           | 75      | 2477           |
| 16      | 2418           | 36      | 2438           | 56      | 2458           | 76      | 2478           |
| 17      | 2419           | 37      | 2439           | 57      | 2459           | 77      | 2479           |
| 18      | 2420           | 38      | 2440           | 58      | 2460           | 78      | 2480           |
| 19      | 2421           | 39      | 2441           | 59      | 2461           |         |                |

#### 3.2.1





### 3.2.1 CONFIGURATION OF SYSTEM UNDER TEST

Please see section 5 photograph of the test configuration for reference.

### 3.2.2 TEST MODE APPLICABILITY AND TESTED CHANNEL DETAIL

Pre-Scan has been conducted to determine the worst-case mode from all possible combinations between available modulations, data rates, power supply voltage range and antenna ports. Following channel(s) was (were) selected for the final test as listed below:

| EUT CONFIGURE MODE | APPLICABLE TO |       |     |      | DESCRIPTION               |
|--------------------|---------------|-------|-----|------|---------------------------|
|                    | RE<1G         | RE≥1G | PLC | APCM |                           |
| A                  | √             | √     | √   | √    | AC 120V 60Hz with BT link |

Where **RE<1G**: Radiated Emission below 1GHz      **RE≥1G**: Radiated Emission above 1GHz  
**PLC**: Power Line Conducted Emission      **APCM**: Antenna Port Conducted Measurement

#### RADIATED EMISSION TEST (BELOW 1 GHz):

- Pre-Scan has been conducted to determine the worst-case mode from all possible combinations between available modulations, X axis, antenna ports (if EUT with antenna diversity architecture) and packet type.
- Following channel(s) was (were) selected for the final test as listed below.

| EUT CONFIGURE MODE | AVAILABLE CHANNEL | TESTED CHANNEL | MODULATION TECHNOLOGY | MODULATION TYPE | PACKET TYPE |
|--------------------|-------------------|----------------|-----------------------|-----------------|-------------|
| A                  | 0 to 78           | 39             | FHSS                  | GFSK            | DH5         |

For the test results, only the worst case was shown in test report.

#### RADIATED EMISSION TEST (ABOVE 1 GHz):

- Pre-Scan has been conducted to determine the worst-case mode from all possible combinations between available modulations, X axis, antenna ports (if EUT with antenna diversity architecture) and packet type.
- Following channel(s) was (were) selected for the final test as listed below.

| EUT CONFIGURE MODE | AVAILABLE CHANNEL | TESTED CHANNEL | MODULATION TECHNOLOGY | MODULATION TYPE | PACKET TYPE |
|--------------------|-------------------|----------------|-----------------------|-----------------|-------------|
| A                  | 0 to 78           | 0, 39, 78      | FHSS                  | GFSK            | DH5         |
|                    | 0 to 78           | 0, 39, 78      | FHSS                  | 8DPSK           | 3DH5        |

**POWER LINE CONDUCTED EMISSION TEST:**

- Pre-Scan has been conducted to determine the worst-case mode from all possible combinations between available modulations, antenna ports (if EUT with antenna diversity architecture), and packet types.
- Following channel(s) was (were) selected for the final test as listed below.

| EUT CONFIGURE MODE | AVAILABLE CHANNEL | TESTED CHANNEL | MODULATION TECHNOLOGY | MODULATION TYPE | PACKET TYPE |
|--------------------|-------------------|----------------|-----------------------|-----------------|-------------|
| A                  | 0 to 78           | Hopping        | FHSS                  | GFSK            | DH5         |

**ANTENNA PORT CONDUCTED MEASUREMENT:**

- This item includes all test value of each mode, but only includes spectrum plot of worst value of each mode.
- Pre-Scan has been conducted to determine the worst-case mode from all possible combinations between available modulations, antenna ports (if EUT with antenna diversity architecture), and packet types.
- Following channel(s) was (were) selected for the final test as listed below.

| EUT CONFIGURE MODE | AVAILABLE CHANNEL | TESTED CHANNEL | MODULATION TECHNOLOGY | MODULATION TYPE | PACKET TYPE |
|--------------------|-------------------|----------------|-----------------------|-----------------|-------------|
| A                  | 0 to 78           | 0, 39, 78      | FHSS                  | GFSK            | DH5         |
|                    | 0 to 78           | 0, 39, 78      | FHSS                  | 8DPSK           | 3DH5        |

**TEST CONDITION:**

| APPLICABLE TO | ENVIRONMENTAL CONDITIONS | TEST VOLTAGE (SYSTEM) | TESTED BY |
|---------------|--------------------------|-----------------------|-----------|
| RE<1G         | 25deg. C, 55%RH          | AC 120V 60Hz          | Jelly     |
| RE≥1G         | 25deg. C, 55%RH          | AC 120V 60Hz          | Jelly     |
| PLC           | 25deg. C, 55%RH          | AC 120V 60Hz          | Vincent   |
| APCM          | 25deg. C, 60%RH          | AC 120V 60Hz          | Vincent   |

### 3.3 GENERAL DESCRIPTION OF APPLIED STANDARDS

The EUT is a RF Product. According to the specifications of the manufacturer, it must comply with the requirements of the following standards:

- FCC Part 15, Subpart C. Section 15.247**
- KDB 558074 D01 15.247 Meas Guidance v05r02**
- ANSI C63.10-2013**

All test items have been performed and recorded as per the above standards.

### 3.4 DESCRIPTION OF SUPPORT UNITS

The EUT has been tested as an independent unit together with other necessary accessories or support units. The following support units or accessories were used to form a representative test configuration during the tests.

| NO. | PRODUCT   | BRAND | MODEL NO. | SERIAL NO.   | FCC ID     | REMARK  |
|-----|-----------|-------|-----------|--------------|------------|---------|
| 1   | iPhone 6s | Apple | ML7F2CH/A | C6KQKXLAGRY8 | BCG-E2946A | BV Lab. |
| 2   | Adapter   | Apple | A1299     | 090471-11    | N/A        |         |
| 3   | Adapter   | N/A   | MDY-03-EC | N/A          | N/A        |         |

| NO. | SIGNAL CABLE DESCRIPTION OF THE ABOVE SUPPORT UNITS |
|-----|---|
| 1-3 | N/A   |

### 3.5 CONFIGURATION OF SYSTEM UNDER TEST

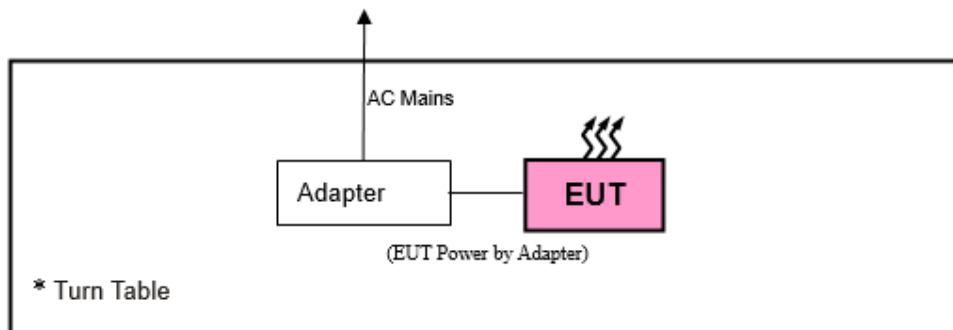



**BUREAU  
VERITAS**

Test Report No.: RF2305WDG0021-1

### 3.6 DUTY CYCLE OF TESET SIGNAL

| Test Mode  | Packet Type | On Time (ms) | Period (ms) | Duty Cycle (%) | 1/T Min. VBW (KHz) | VBW Setting |
|------------|-------------|--------------|-------------|----------------|--------------------|-------------|
| BDR(GFSK)  | DH5         | 2.873        | 3.748       | 76.7           | 0.348              | 500Hz       |
| EDR(8DPSK) | 3DH5        | 2.879        | 3.751       | 76.8           | 0.347              | 500Hz       |

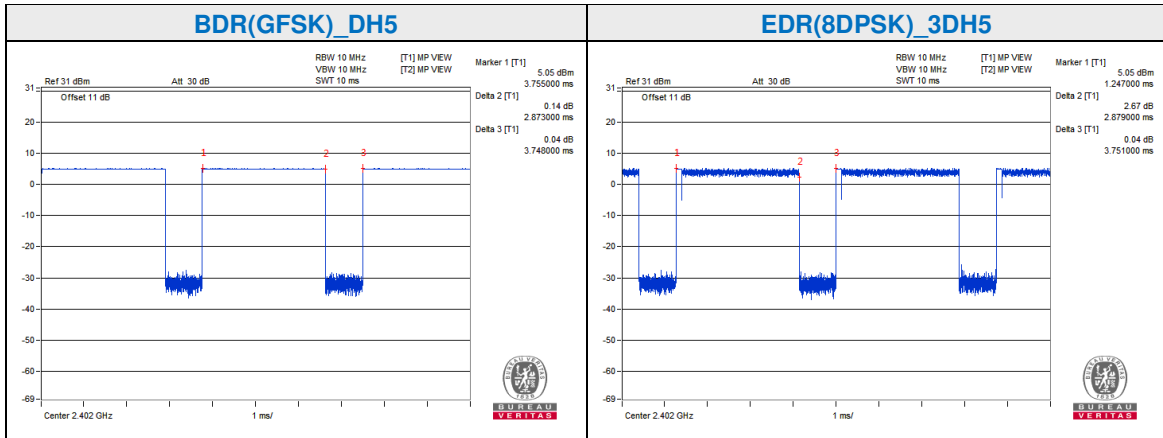

**Bureau Veritas Shenzhen Co., Ltd.  
Dongguan Branch**

No. 96, Guantai Road (Houjie Section), Houjie  
Town, Dongguan City, Guangdong Province.  
523942. People's Republic of China.

Tel: +86 769 8998 2098  
Fax: +86 769 8593 1080  
Email: [customerservice.dg@bureauveritas.com](mailto:customerservice.dg@bureauveritas.com)

## 4 TEST TYPES AND RESULTS

### 4.1. CONDUCTED EMISSION MEASUREMENT

#### 4.1.1 LIMITS OF CONDUCTED EMISSION MEASUREMENT

| FREQUENCY OF EMISSION (MHz) | CONDUCTED LIMIT (dB $\mu$ V) |          |
|-----------------------------|------------------------------|----------|
|                             | Quasi-peak                   | Average  |
| 0.15 ~ 0.5                  | 66 to 56                     | 56 to 46 |
| 0.5 ~ 5                     | 56                           | 46       |
| 5 ~ 30                      | 60                           | 50       |

- NOTES:**
1. The lower limit shall apply at the transition frequencies.
  2. The limit decreases in line with the logarithm of the frequency in the range of 0.15 to 0.50MHz.
  3. All emanations from a class A/B digital device or system, including any network of conductors and apparatus connected thereto, shall not exceed the level of field strengths specified above.

#### 4.1.2 TEST INSTRUMENTS

| Equipment                | Manufacturer  | Model No.       | Serial No.     | Next Cal.   |
|--------------------------|---------------|-----------------|----------------|-------------|
| EMI Test Receiver        | Rohde&Schwarz | ESR7            | 101494         | Jan. 10,24  |
| Artificial Mains Network | Rohde&Schwarz | ENV216          | 101173         | Jan. 11,24  |
| Artificial Mains Network | Rohde&Schwarz | ESH3-Z5         | 100317         | Jan. 10,24  |
| V-LISN (CISPR 25)        | SCHWARZBECK   | NNBM 8124-200   | 8124-200 05857 | Jun. 14, 24 |
| V-LISN (CISPR 25)        | SCHWARZBECK   | NNBM 8124-200   | 8124-200 05858 | Jun. 14, 24 |
| Voltage probe            | SCHWARZBECK   | TK 9421         | TK 9421-176    | Jul. 27, 23 |
| Coaxial RF Cable         | SUHNER        | RG 223/U-CE     | C2310066DG     | Jul. 24, 23 |
| Test software            | ADT           | ADT_Cond_V7.3.7 | N/A            | N/A         |

- NOTES:**
1. The test was performed in shielded room 543.
  2. The calibration interval of the above test instruments is 12 months. And the calibrations are traceable to CEPREI/CHINA, GRGT/CHINA and NIM/CHINA.



#### 4.1.3 TEST PROCEDURES

- a. The EUT was placed 0.4 meters from the conducting wall of the shielded room with EUT being connected to the power mains through a line impedance stabilization network (LISN). Other support units were connected to the power mains through another LISN. The two LISNs provide 50 ohm/ 50uH of coupling impedance for the measuring instrument.
- b. Both lines of the power mains connected to the EUT were checked for maximum conducted interference.
- c. The frequency range from 150kHz to 30MHz was searched. Emission levels under (Limit - 20dB) was not recorded.

**NOTE:** All modes of operation were investigated and the worst-case emissions are reported.

#### 4.1.4 DEVIATION FROM TEST STANDARD

No deviation.

#### 4.1.5 TEST SETUP

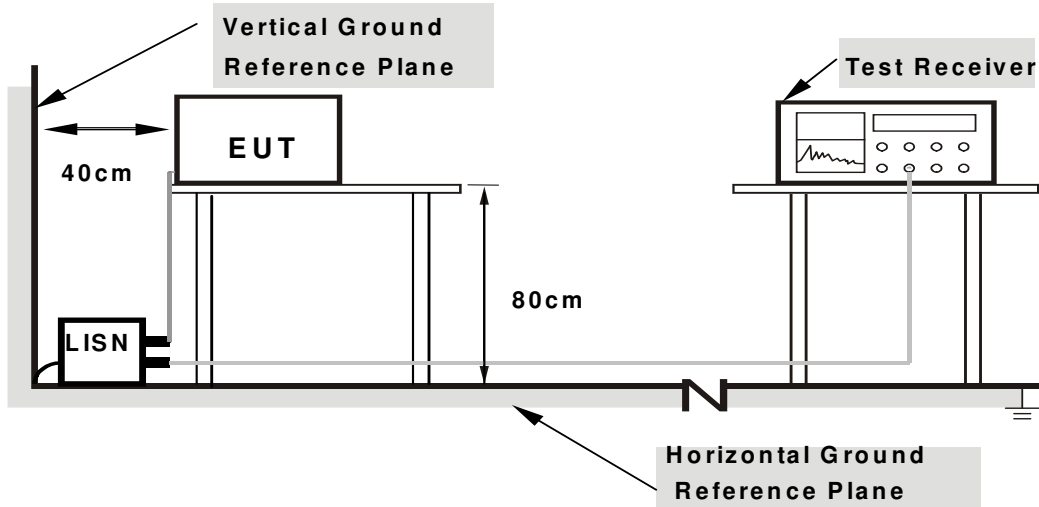

- Note:**
1. Support units were connected to second LISN.
  2. Both of LISNs (AMN) are 80 cm from EUT and at least 80 from other units and other metal planes

For the actual test configuration, please refer to the attached file (Test Setup Photo).

#### 4.1.6 EUT OPERATING CONDITIONS

- a. Turned on the power and connected of all equipment.
- b. EUT was operated according to the type used was description in manufacturer's specifications or the User's Manual.

### 4.1.7 TEST RESULTS

**CONDUCTED WORST-CASE DATA:**

|              |      |                      |      |
|--------------|------|----------------------|------|
| <b>PHASE</b> | Line | <b>6dB BANDWIDTH</b> | 9kHz |
|--------------|------|----------------------|------|

| No | Freq. [MHz] | Corr. Factor (dB) | Reading Value [dB (uV)] |       | Emission Level [dB (uV)] |       | Limit [dB (uV)] |       | Margin (dB) |        |
|----|-------------|-------------------|-------------------------|-------|--------------------------|-------|-----------------|-------|-------------|--------|
|    |             |                   | Q.P.                    | AV.   | Q.P.                     | AV.   | Q.P.            | AV.   | Q.P.        | AV.    |
| 1  | 0.31387     | 10.16             | 27.11                   | 15.36 | 37.27                    | 25.52 | 59.87           | 49.87 | -22.60      | -24.35 |
| 2  | 0.44925     | 10.20             | 28.92                   | 19.65 | 39.12                    | 29.85 | 56.89           | 46.89 | -17.77      | -17.04 |
| 3  | 1.25250     | 10.25             | 25.58                   | 16.37 | 35.83                    | 26.62 | 56.00           | 46.00 | -20.17      | -19.38 |
| 4  | 2.86350     | 10.30             | 30.90                   | 20.99 | 41.20                    | 31.29 | 56.00           | 46.00 | -14.80      | -14.71 |
| 5  | 11.94900    | 10.71             | 24.94                   | 15.18 | 35.65                    | 25.89 | 60.00           | 50.00 | -24.35      | -24.11 |
| 6  | 16.10250    | 10.79             | 31.98                   | 20.46 | 42.77                    | 31.25 | 60.00           | 50.00 | -17.23      | -18.75 |

- REMARKS:**
1. Q.P. and AV. are abbreviations of quasi-peak and average individually.
  2. "-": The Quasi-peak reading value also meets average limit and measurement with the average detector is unnecessary.
  3. The emission levels of other frequencies were very low against the limit.
  4. Margin value = Emission level - Limit value
  5. Correction factor = Insertion loss + Cable loss
  6. Emission Level = Correction Factor + Reading Value.

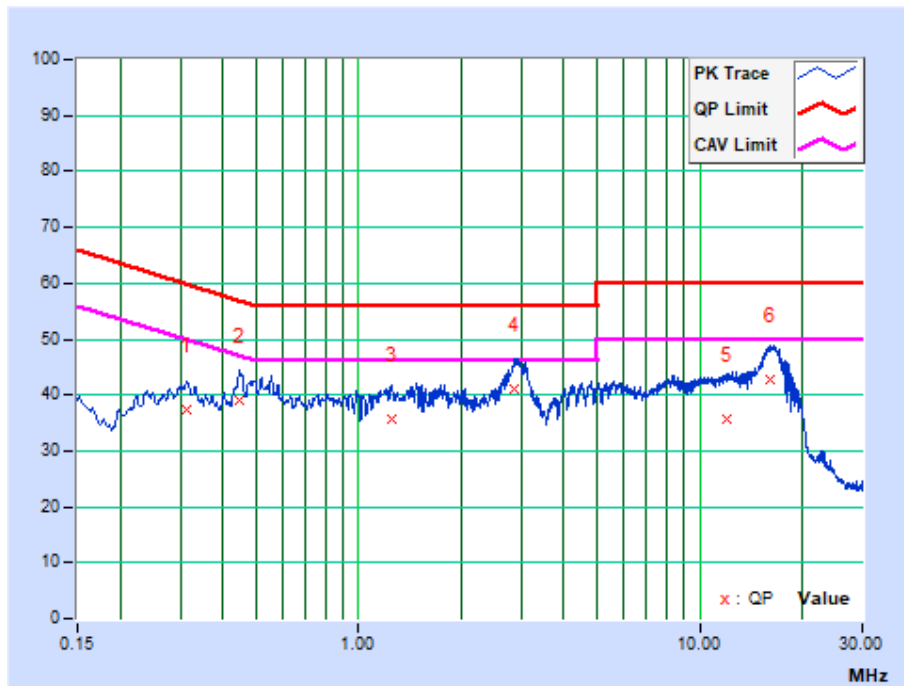



|              |         |                      |      |
|--------------|---------|----------------------|------|
| <b>PHASE</b> | Neutral | <b>6dB BANDWIDTH</b> | 9kHz |
|--------------|---------|----------------------|------|

| No | Freq. [MHz] | Corr. Factor (dB) | Reading Value [dB (uV)] |       | Emission Level [dB (uV)] |       | Limit [dB (uV)] |       | Margin (dB) |        |
|----|-------------|-------------------|-------------------------|-------|--------------------------|-------|-----------------|-------|-------------|--------|
|    |             |                   | Q.P.                    | AV.   | Q.P.                     | AV.   | Q.P.            | AV.   | Q.P.        | AV.    |
| 1  | 0.31387     | 10.14             | 28.47                   | 13.43 | 38.61                    | 23.57 | 59.87           | 49.87 | -21.26      | -26.30 |
| 2  | 0.53786     | 10.18             | 27.80                   | 13.90 | 37.98                    | 24.08 | 56.00           | 46.00 | -18.02      | -21.92 |
| 3  | 0.85200     | 10.20             | 25.61                   | 14.28 | 35.81                    | 24.48 | 56.00           | 46.00 | -20.19      | -21.52 |
| 4  | 2.91525     | 10.29             | 29.31                   | 22.00 | 39.60                    | 32.29 | 56.00           | 46.00 | -16.40      | -13.71 |
| 5  | 4.53075     | 10.37             | 22.57                   | 11.97 | 32.94                    | 22.34 | 56.00           | 46.00 | -23.06      | -23.66 |
| 6  | 16.06875    | 11.15             | 26.98                   | 12.72 | 38.13                    | 23.87 | 60.00           | 50.00 | -21.87      | -26.13 |

- REMARKS:**
1. Q.P. and AV. are abbreviations of quasi-peak and average individually.
  2. "-": The Quasi-peak reading value also meets average limit and measurement with the average detector is unnecessary.
  3. The emission levels of other frequencies were very low against the limit.
  4. Margin value = Emission level - Limit value
  5. Correction factor = Insertion loss + Cable loss
  6. Emission Level = Correction Factor + Reading Value.

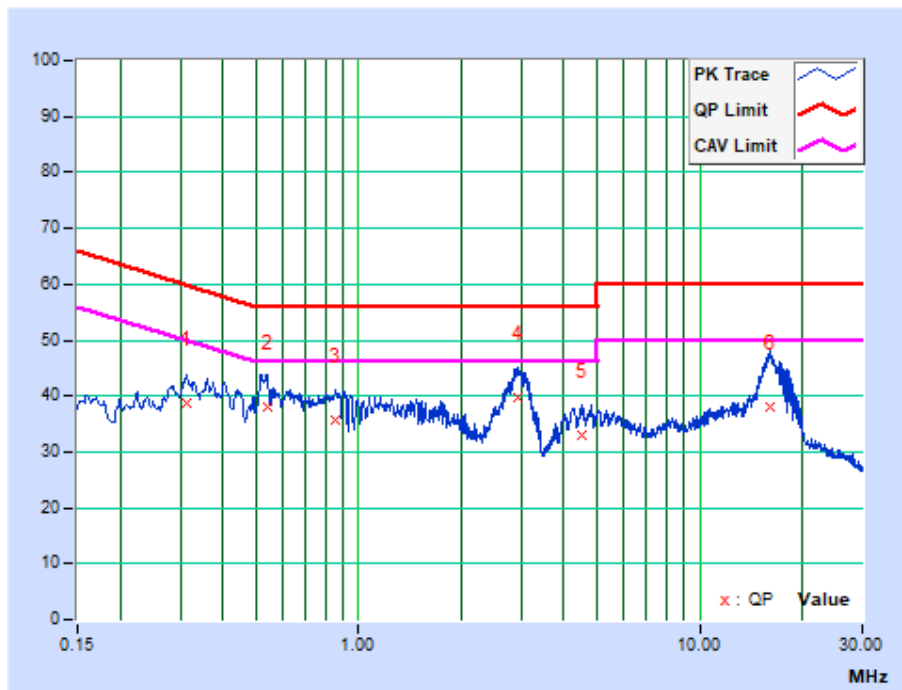

## 4.2. RADIATED EMISSION AND BANDEDGE MEASUREMENT

### 4.2.1 LIMITS OF RADIATED EMISSION AND BANDEDGE MEASUREMENT

Radiated emissions which fall in the restricted bands, as defined in Section 15.205(a), must also comply with the radiated emission limits specified in Section 15.209(a). Other emissions shall be at least 20dB below the highest level of the desired power.

| FREQUENCIES (MHz) | FIELD STRENGTH (microvolts/meter) | MEASUREMENT DISTANCE (meters) |
|-------------------|-----------------------------------|-------------------------------|
| 0.009 ~ 0.490     | 2400/F(kHz)                       | 300                           |
| 0.490 ~ 1.705     | 24000/F(kHz)                      | 30                            |
| 1.705 ~ 30.0      | 30                                | 30                            |
| 30 ~ 88           | 100                               | 3                             |
| 88 ~ 216          | 150                               | 3                             |
| 216 ~ 960         | 200                               | 3                             |
| Above 960         | 500                               | 3                             |

#### NOTES:

1. The lower limit shall apply at the transition frequencies.
2. Emission level (dBuV/m) = 20 log Emission level (uV/m).
3. As shown in 15.35(b), for frequencies above 1000MHz, the field strength limits are based on average detector, however, the peak field strength of any emission shall not exceed the maximum permitted average limits, specified above by more than 20dB under any condition of modulation.



Test Report No.: RF2305WDG0021-1

#### 4.2.2 TEST INSTRUMENTS

| Equipment                           | Manufacturer  | Model No.                | Serial No.  | Next Cal.   |
|-------------------------------------|---------------|--------------------------|-------------|-------------|
| EMI Test Receiver                   | Rohde&Schwarz | ESU40                    | 100449      | Jan. 10, 24 |
| Signal and Spectrum Analyzer        | Rohde&Schwarz | FSV7                     | 102331      | May. 09, 24 |
| Active Loop Antenna (9KHz -30MHz)   | SCHWARZBECK   | FMZB 1519B               | 1519B-045   | Apr. 27, 24 |
| Amplifier (9KHz -1GHz)              | Burgeon       | BPA-530                  | 100210      | Mar. 06, 24 |
| Trilog-Broadband Antenna(20M-2G)    | SCHWARZBECK   | VULB 9168                | 01282       | Aug. 21, 23 |
| Horn Antenna (1GHz -18GHz)          | ETS -Lindgren | 3117                     | 00062558    | Apr. 27, 24 |
| Horn Antenna (18GHz -40GHz)         | SCHWARZBECK   | BBHA 9170                | BBHA9170147 | Apr. 28, 24 |
| 3m Semi-anechoic Chamber            | ETS-LINDGREN  | 9m*6m*6m                 | NSEMC003    | May 22, 24  |
| Test Software                       | ADT           | ADT_Radiated_V7.6.15.9.2 | N/A         | N/A         |
| Broadband Preamplifier (1GHz~18GHz) | SCHWARZBECK   | BBV9718                  | 305         | Apr. 26, 24 |
| Pre-Amplifier (18GHz-40GHz)         | EMCI          | EMC 184045               | 980102      | Jan. 16, 24 |
| BLUETOOTH TESTER                    | Rohde&Schwarz | CBT32                    | 100811      | N/A         |

#### NOTES:

1. The test was performed in 966 Chamber.
2. The calibration interval of the above test instruments is 12 months and the calibrations are traceable to CEPREI/CHINA, GRGT/CHINA and NIM/CHINA.
3. The horn antenna is used only for the measurement of emission frequency above 1 GHz if tested.
4. The FCC Site Registration No. is 749762.

#### 4.2.3 TEST PROCEDURES

- a. The EUT was placed on the top of a rotating table 1.5 meters (above 1GHz) and 0.8 meters (below 1GHz) above the ground at a 3 meters semi-anechoic chamber. The table was rotated 360 degrees to determine the position of the highest radiation.
- b. The EUT was set 3 meters away from the interference-receiving antenna, which was mounted on the top of a variable-height antenna tower.
- c. For below 1GHz was used bilog antenna, and above 1GHz was used horn antenna, and its height is varied from one meter to four meters above the ground to determine the maximum value of the field strength. Both horizontal and vertical polarizations of the antenna are set to make the measurement.
- d. For each suspected emission, the EUT was arranged to its worst case and then the antenna was tuned to heights from 1 meter to 4 meters and the rotatable table was turned from 0 degrees to 360 degrees to find the maximum reading.
- e. The test-receiver system was set to Peak Detect Function and Specified Bandwidth with Maximum Hold Mode.
- f. For below 30MHz, a loop antenna with its vertical plane is placed 3m from the EUT and rotated about its vertical axis for maximum response at each azimuth about the EUT. And the centre of the loop shall be 1.3m above the ground.
- g. During the test, each emission was maximized by: having the EUT continuously working, investigated all operating modes, rotated about all 3 axis (X, Y & Z) and considered typical configuration to obtain worst position, manipulating interconnecting cables, For battery operated equipment, the equipment tests shall be performed using fresh batteries. The turntable was rotated to maximize the emission level.

#### NOTES:

1. The resolution bandwidth and video bandwidth of test receiver/spectrum analyzer is 120kHz for Quasi-peak detection at frequency below 1GHz.
2. The resolution bandwidth of test receiver/spectrum analyzer is 1 MHz and video bandwidth is 3MHz for Peak detection at frequency above 1GHz.
3. The resolution bandwidth of test receiver/spectrum analyzer is 1MHz and the video bandwidth is  $\geq 1/T$  (Duty cycle < 98%) for Average detection (AV) at frequency above 1GHz.
4. All modes of operation were investigated and the worst-case emissions are reported.
5. The testing of the EUT was performed on all 3 orthogonal axes; the worst-case test configuration was reported on the file test setup photo.

#### 4.2.4 DEVIATION FROM TEST STANDARD

No deviation.

#### 4.2.5 TEST SETUP

##### Below 30MHz test setup

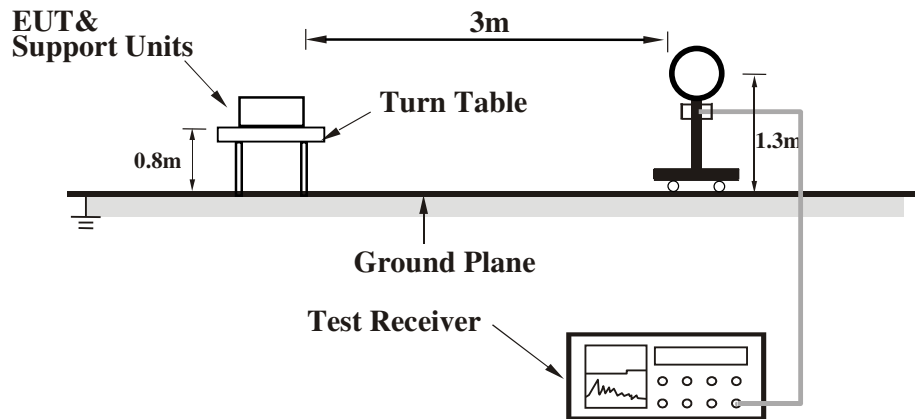

##### Below 1GHz test setup

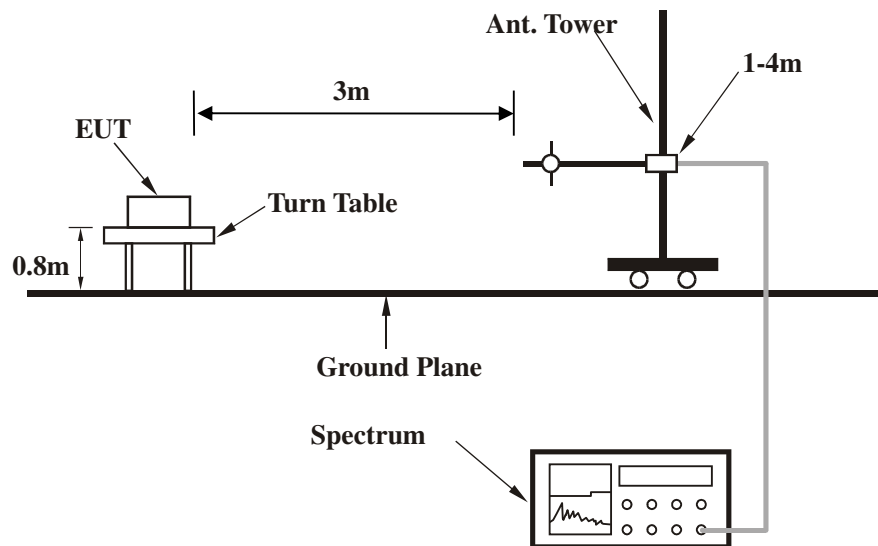

**Note:** For the actual test configuration, please refer to the attached file (Test Setup Photo).

### Above 1GHz test setup

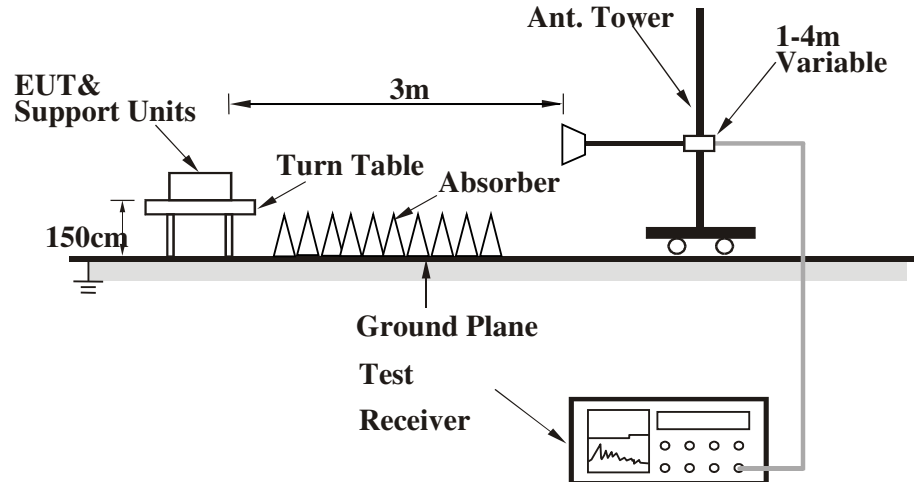

**Note:** For the actual test configuration, please refer to the attached file (Test Setup Photo).

#### 4.2.6 EUT OPERATING CONDITIONS

- Set the EUT under full load condition and placed them on a testing table.
- Set the transmitter part of EUT under transmission condition continuously at specific channel frequency.
- The necessary accessories enable the EUT in full functions.

### 4.2.7 TEST RESULTS

#### BELOW 1GHz WORST-CASE DATA:

#### GFSK DH5

|                        |             |                              |                 |
|------------------------|-------------|------------------------------|-----------------|
| <b>CHANNEL</b>         | Channel 39  | <b>DETECTOR<br/>FUNCTION</b> | Quasi-Peak (QP) |
| <b>FREQUENCY RANGE</b> | 9KHz ~ 1GHz |                              |                 |

| ANTENNA POLARITY & TEST DISTANCE: HORIZONTAL AT 3 M |                |                               |                   |                |                          |                            |                        |                                 |
|---|----------------|-------------------------------|-------------------|----------------|--------------------------|----------------------------|------------------------|---------------------------------|
| NO.   | FREQ.<br>(MHz) | EMISSION<br>LEVEL<br>(dBuV/m) | LIMIT<br>(dBuV/m) | MARGIN<br>(dB) | ANTENNA<br>HEIGHT<br>(m) | TABLE<br>ANGLE<br>(Degree) | RAW<br>VALUE<br>(dBuV) | CORRECTIO<br>N FACTOR<br>(dB/m) |
| 1   | 45.54          | 15.85 QP                      | 40.00             | -24.15         | 2.00 H                   | 232                        | 32.35                  | -16.50                          |
| 2   | 166.79         | 13.36 QP                      | 43.50             | -30.14         | 2.00 H                   | 265                        | 29.85                  | -16.49                          |
| 3   | 350.22         | 22.52 QP                      | 46.00             | -23.48         | 2.00 H                   | 157                        | 35.14                  | -12.62                          |
| 4   | 432.61         | 24.05 QP                      | 46.00             | -21.95         | 2.00 H                   | 276                        | 34.62                  | -10.57                          |
| 5   | 580.29         | 21.94 QP                      | 46.00             | -24.06         | 2.00 H                   | 287                        | 29.05                  | -7.11                           |
| 6   | 715.53         | 25.43 QP                      | 46.00             | -20.57         | 2.00 H                   | 261                        | 29.83                  | -4.40                           |

#### REMARKS:

1. Emission level (dBuV/m) = Raw Value (dBuV) + Correction Factor (dB/m).
2. Correction Factor (dB/m) = Antenna Factor (dB/m) + Cable Factor (dB).
3. The emission levels of other frequencies were greater than 20dB margin.
4. 9KHz~30MHz have been test and test data more than 20dB margin.
5. Margin value = Emission level – Limit value

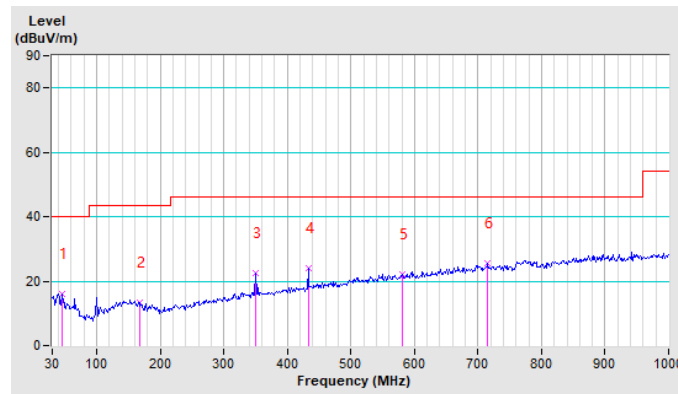

|                        |             |                              |                 |
|------------------------|-------------|------------------------------|-----------------|
| <b>CHANNEL</b>         | Channel 39  | <b>DETECTOR<br/>FUNCTION</b> | Quasi-Peak (QP) |
| <b>FREQUENCY RANGE</b> | 9KHz ~ 1GHz |                              |                 |

| ANTENNA POLARITY & TEST DISTANCE: VERTICAL AT 3 M |                |                               |                   |                |                          |                            |                        |                                 |
|---|----------------|-------------------------------|-------------------|----------------|--------------------------|----------------------------|------------------------|---------------------------------|
| NO.   | FREQ.<br>(MHz) | EMISSION<br>LEVEL<br>(dBuV/m) | LIMIT<br>(dBuV/m) | MARGIN<br>(dB) | ANTENNA<br>HEIGHT<br>(m) | TABLE<br>ANGLE<br>(Degree) | RAW<br>VALUE<br>(dBuV) | CORRECTIO<br>N FACTOR<br>(dB/m) |
| 1   | 39.33          | 14.78 QP                      | 40.00             | -25.22         | 1.00 V                   | 205                        | 31.30                  | -16.52                          |
| 2   | 166.79         | 14.62 QP                      | 43.50             | -28.88         | 1.00 V                   | 224                        | 31.11                  | -16.49                          |
| 3   | 261.62         | 13.03 QP                      | 46.00             | -32.97         | 1.00 V                   | 237                        | 28.78                  | -15.75                          |
| 4   | 373.54         | 16.20 QP                      | 46.00             | -29.80         | 1.00 V                   | 250                        | 28.28                  | -12.08                          |
| 5   | 482.36         | 19.90 QP                      | 46.00             | -26.10         | 1.00 V                   | 264                        | 29.20                  | -9.30                           |
| 6   | 642.47         | 23.92 QP                      | 46.00             | -22.08         | 1.00 V                   | 277                        | 29.61                  | -5.69                           |

**REMARKS:**

1. Emission level (dBuV/m) = Raw Value (dBuV) + Correction Factor (dB/m).
2. Correction Factor (dB/m) = Antenna Factor (dB/m) + Cable Factor (dB).
3. The emission levels of other frequencies were greater than 20dB margin.
4. 9KHz~30MHz have been test and test data more than 20dB margin.
5. Margin value = Emission level – Limit value

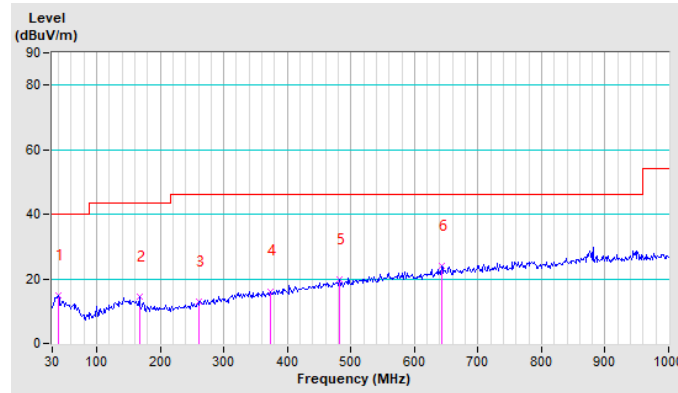





ABOVE 1GHz DATA

BT\_GFSK

|                        |              |                          |              |
|------------------------|--------------|--------------------------|--------------|
| <b>CHANNEL</b>         | TX Channel 0 | <b>DETECTOR FUNCTION</b> | Peak (PK)    |
| <b>FREQUENCY RANGE</b> | 1GHz ~ 25GHz |                          | Average (AV) |

**ANTENNA POLARITY & TEST DISTANCE : HORIZONTAL AT 3 M**

| NO. | FREQ. (MHz) | EMISSION LEVEL (dBuV/m) | LIMIT (dBuV/m) | MARGIN (dB) | ANTENNA HEIGHT (m) | TABLE ANGLE (Degree) | RAW VALUE (dBuV) | CORRECTION FACTOR (dB/m) |
|-----|-------------|-------------------------|----------------|-------------|--------------------|----------------------|------------------|--------------------------|
| 1   | 2390.00     | 44.16 PK                | 74.00          | -29.84      | 1.50 H             | 44                   | 41.47            | 2.69                     |
| 2   | 2390.00     | 34.56 AV                | 54.00          | -19.44      | 1.50 H             | 44                   | 31.87            | 2.69                     |
| 3   | *2402.00    | 106.23 PK               |                |             | 1.50 H             | 44                   | 103.50           | 2.73                     |
| 4   | *2402.00    | 105.95 AV               |                |             | 1.50 H             | 44                   | 103.22           | 2.73                     |
| 5   | 4804.00     | 50.91 PK                | 74.00          | -23.09      | 1.80 H             | 82                   | 42.70            | 8.21                     |
| 6   | 4804.00     | 41.20 AV                | 54.00          | -12.80      | 1.80 H             | 82                   | 32.99            | 8.21                     |
| 7   | #7206.00    | 51.26 PK                | 74.00          | -22.74      | 1.92 H             | 85                   | 41.73            | 9.53                     |
| 8   | #7206.00    | 40.32 AV                | 54.00          | -13.68      | 1.92 H             | 85                   | 30.79            | 9.53                     |

**ANTENNA POLARITY & TEST DISTANCE : VERTICAL AT 3 M**

| NO. | FREQ. (MHz) | EMISSION LEVEL (dBuV/m) | LIMIT (dBuV/m) | MARGIN (dB) | ANTENNA HEIGHT (m) | TABLE ANGLE (Degree) | RAW VALUE (dBuV) | CORRECTION FACTOR (dB/m) |
|-----|-------------|-------------------------|----------------|-------------|--------------------|----------------------|------------------|--------------------------|
| 1   | 2390.00     | 45.10 PK                | 74.00          | -28.90      | 1.60 V             | 31                   | 42.41            | 2.69                     |
| 2   | 2390.00     | 35.50 AV                | 54.00          | -18.50      | 1.60 V             | 31                   | 32.81            | 2.69                     |
| 3   | *2402.00    | 107.42 PK               |                |             | 1.60 V             | 31                   | 104.69           | 2.73                     |
| 4   | *2402.00    | 106.25 AV               |                |             | 1.60 V             | 31                   | 103.52           | 2.73                     |
| 5   | 4804.00     | 51.77 PK                | 74.00          | -22.23      | 1.05 V             | 85                   | 43.56            | 8.21                     |
| 6   | 4804.00     | 41.28 AV                | 54.00          | -12.72      | 1.05 V             | 85                   | 33.07            | 8.21                     |
| 7   | #7206.00    | 48.94 PK                | 74.00          | -25.06      | 1.00 V             | 96                   | 39.41            | 9.53                     |
| 8   | #7206.00    | 37.99 AV                | 54.00          | -16.01      | 1.00 V             | 96                   | 28.46            | 9.53                     |

REMARKS:

1. Emission level (dBuV/m) = Raw Value (dBuV) + Correction Factor (dB/m).
2. Correction Factor (dB/m) = Antenna Factor (dB/m) + Cable Factor (dB).
3. The emission levels of other frequencies were greater than 20dB margin.
4. Margin value = Emission level – Limit value.
5. " \* ": Fundamental frequency.
6. " # ": The radiated frequency is out of the restricted band.



Test Report No.: RF2305WDG0021-1

|                        |               |                              |              |
|------------------------|---------------|------------------------------|--------------|
| <b>CHANNEL</b>         | TX Channel 39 | <b>DETECTOR<br/>FUNCTION</b> | Peak (PK)    |
| <b>FREQUENCY RANGE</b> | 1GHz ~ 25GHz  |                              | Average (AV) |

**ANTENNA POLARITY & TEST DISTANCE : HORIZONTAL AT 3 M**

| NO. | FREQ.<br>(MHz) | EMISSION<br>LEVEL<br>(dBuV/m) | LIMIT<br>(dBuV/m) | MARGIN<br>(dB) | ANTENNA<br>HEIGHT<br>(m) | TABLE<br>ANGLE<br>(Degree) | RAW<br>VALUE<br>(dBuV) | CORRECTION<br>FACTOR<br>(dB/m) |
|-----|----------------|-------------------------------|-------------------|----------------|--------------------------|----------------------------|------------------------|--------------------------------|
| 1   | *2441.00       | 107.00 PK                     |                   |                | 1.50 H                   | 95                         | 104.14                 | 2.86                           |
| 2   | *2441.00       | 106.89 AV                     |                   |                | 1.50 H                   | 95                         | 104.03                 | 2.86                           |
| 3   | 4882.00        | 51.29 PK                      | 74.00             | -22.71         | 1.06 H                   | 52                         | 42.54                  | 8.75                           |
| 4   | 4882.00        | 40.26 AV                      | 54.00             | -13.74         | 1.06 H                   | 52                         | 31.51                  | 8.75                           |
| 5   | 7323.00        | 51.29 PK                      | 74.00             | -22.71         | 1.70 H                   | 52                         | 41.69                  | 9.60                           |
| 6   | 7323.00        | 40.32 AV                      | 54.00             | -13.68         | 1.70 H                   | 52                         | 30.72                  | 9.60                           |

**ANTENNA POLARITY & TEST DISTANCE : VERTICAL AT 3 M**

| NO. | FREQ.<br>(MHz) | EMISSION<br>LEVEL<br>(dBuV/m) | LIMIT<br>(dBuV/m) | MARGIN<br>(dB) | ANTENNA<br>HEIGHT<br>(m) | TABLE<br>ANGLE<br>(Degree) | RAW<br>VALUE<br>(dBuV) | CORRECTION<br>FACTOR<br>(dB/m) |
|-----|----------------|-------------------------------|-------------------|----------------|--------------------------|----------------------------|------------------------|--------------------------------|
| 1   | *2441.00       | 96.36 PK                      |                   |                | 1.34 V                   | 56                         | 93.50                  | 2.86                           |
| 2   | *2441.00       | 96.00 AV                      |                   |                | 1.34 V                   | 56                         | 93.14                  | 2.86                           |
| 3   | 4882.00        | 53.26 PK                      | 74.00             | -20.74         | 1.69 V                   | 52                         | 44.51                  | 8.75                           |
| 4   | 4882.00        | 40.26 AV                      | 54.00             | -13.74         | 1.69 V                   | 52                         | 31.51                  | 8.75                           |
| 5   | 7323.00        | 52.39 PK                      | 74.00             | -21.61         | 1.08 V                   | 44                         | 42.79                  | 9.60                           |
| 6   | 7323.00        | 40.29 AV                      | 54.00             | -13.71         | 1.08 V                   | 44                         | 30.69                  | 9.60                           |

**REMARKS:**

1. Emission level (dBuV/m) = Raw Value (dBuV) + Correction Factor (dB/m).
2. Correction Factor (dB/m) = Antenna Factor (dB/m) + Cable Factor (dB).
3. The emission levels of other frequencies were greater than 20dB margin.
4. Margin value = Emission level – Limit value.
5. " \* ": Fundamental frequency.

|                        |               |                              |              |
|------------------------|---------------|------------------------------|--------------|
| <b>CHANNEL</b>         | TX Channel 78 | <b>DETECTOR<br/>FUNCTION</b> | Peak (PK)    |
| <b>FREQUENCY RANGE</b> | 1GHz ~ 25GHz  |                              | Average (AV) |

| ANTENNA POLARITY & TEST DISTANCE : HORIZONTAL AT 3 M |                |                               |                   |                |                          |                            |                        |                                |
|--|----------------|-------------------------------|-------------------|----------------|--------------------------|----------------------------|------------------------|--------------------------------|
| NO.  | FREQ.<br>(MHz) | EMISSION<br>LEVEL<br>(dBuV/m) | LIMIT<br>(dBuV/m) | MARGIN<br>(dB) | ANTENNA<br>HEIGHT<br>(m) | TABLE<br>ANGLE<br>(Degree) | RAW<br>VALUE<br>(dBuV) | CORRECTION<br>FACTOR<br>(dB/m) |
| 1  | *2480.00       | 106.38 PK                     |                   |                | 1.05 H                   | 202                        | 103.41                 | 2.97                           |
| 2  | *2480.00       | 105.53 AV                     |                   |                | 1.05 H                   | 202                        | 102.56                 | 2.97                           |
| 3  | 2483.50        | 47.73 PK                      | 74.00             | -26.27         | 1.05 H                   | 202                        | 44.75                  | 2.98                           |
| 4  | 2483.50        | 35.58 AV                      | 54.00             | -18.42         | 1.05 H                   | 202                        | 32.60                  | 2.98                           |
| 5  | 4960.00        | 51.29 PK                      | 74.00             | -22.71         | 1.05 H                   | 92                         | 41.99                  | 9.30                           |
| 6  | 4960.00        | 41.29 AV                      | 54.00             | -12.71         | 1.05 H                   | 92                         | 31.99                  | 9.30                           |
| 7  | 7440.00        | 51.29 PK                      | 74.00             | -22.71         | 1.08 H                   | 62                         | 41.63                  | 9.66                           |
| 8  | 7440.00        | 40.35 AV                      | 54.00             | -13.65         | 1.08 H                   | 62                         | 30.69                  | 9.66                           |
| ANTENNA POLARITY & TEST DISTANCE : VERTICAL AT 3 M   |                |                               |                   |                |                          |                            |                        |                                |
| NO.  | FREQ.<br>(MHz) | EMISSION<br>LEVEL<br>(dBuV/m) | LIMIT<br>(dBuV/m) | MARGIN<br>(dB) | ANTENNA<br>HEIGHT<br>(m) | TABLE<br>ANGLE<br>(Degree) | RAW<br>VALUE<br>(dBuV) | CORRECTION<br>FACTOR<br>(dB/m) |
| 1  | *2480.00       | 106.62 PK                     |                   |                | 1.09 V                   | 6                          | 103.65                 | 2.97                           |
| 2  | *2480.00       | 106.27 AV                     |                   |                | 1.09 V                   | 6                          | 103.30                 | 2.97                           |
| 3  | 2483.50        | 58.65 PK                      | 74.00             | -15.35         | 1.09 V                   | 6                          | 55.67                  | 2.98                           |
| 4  | 2483.50        | 39.46 AV                      | 54.00             | -14.54         | 1.09 V                   | 6                          | 36.48                  | 2.98                           |
| 5  | 4960.00        | 47.88 PK                      | 74.00             | -26.12         | 1.80 V                   | 51                         | 38.58                  | 9.30                           |
| 6  | 4960.00        | 39.48 AV                      | 54.00             | -14.52         | 1.80 V                   | 51                         | 30.18                  | 9.30                           |
| 7  | 7440.00        | 51.29 PK                      | 74.00             | -22.71         | 1.62 V                   | 90                         | 41.63                  | 9.66                           |
| 8  | 7440.00        | 42.00 AV                      | 54.00             | -12.00         | 1.62 V                   | 90                         | 32.34                  | 9.66                           |

**REMARKS:**

1. Emission level (dBuV/m) = Raw Value (dBuV) + Correction Factor (dB/m).
2. Correction Factor (dB/m) = Antenna Factor (dB/m) + Cable Factor (dB).
3. The emission levels of other frequencies were greater than 20dB margin.
4. Margin value = Emission level – Limit value.
5. " \* " : Fundamental frequency.



BT\_8DPSK

|                        |              |                          |              |
|------------------------|--------------|--------------------------|--------------|
| <b>CHANNEL</b>         | TX Channel 0 | <b>DETECTOR FUNCTION</b> | Peak (PK)    |
| <b>FREQUENCY RANGE</b> | 1GHz ~ 25GHz |                          | Average (AV) |

**ANTENNA POLARITY & TEST DISTANCE : HORIZONTAL AT 3 M**

| NO. | FREQ. (MHz) | EMISSION LEVEL (dBuV/m) | LIMIT (dBuV/m) | MARGIN (dB) | ANTENNA HEIGHT (m) | TABLE ANGLE (Degree) | RAW VALUE (dBuV) | CORRECTION FACTOR (dB/m) |
|-----|-------------|-------------------------|----------------|-------------|--------------------|----------------------|------------------|--------------------------|
| 1   | 2390.00     | 47.80 PK                | 74.00          | -26.20      | 1.60 H             | 199                  | 45.11            | 2.69                     |
| 2   | 2390.00     | 38.00 AV                | 54.00          | -16.00      | 1.60 H             | 199                  | 35.31            | 2.69                     |
| 3   | *2402.00    | 105.84 PK               |                |             | 1.59 H             | 199                  | 103.11           | 2.73                     |
| 4   | *2402.00    | 102.36 AV               |                |             | 1.59 H             | 199                  | 99.63            | 2.73                     |
| 5   | 4804.00     | 50.35 PK                | 74.00          | -23.65      | 1.05 H             | 51                   | 42.14            | 8.21                     |
| 6   | 4804.00     | 41.25 AV                | 54.00          | -12.75      | 1.05 H             | 51                   | 33.04            | 8.21                     |
| 7   | #7206.00    | 51.29 PK                | 74.00          | -22.71      | 1.06 H             | 92                   | 41.76            | 9.53                     |
| 8   | #7206.00    | 40.32 AV                | 54.00          | -13.68      | 1.06 H             | 92                   | 30.79            | 9.53                     |

**ANTENNA POLARITY & TEST DISTANCE : VERTICAL AT 3 M**

| NO. | FREQ. (MHz) | EMISSION LEVEL (dBuV/m) | LIMIT (dBuV/m) | MARGIN (dB) | ANTENNA HEIGHT (m) | TABLE ANGLE (Degree) | RAW VALUE (dBuV) | CORRECTION FACTOR (dB/m) |
|-----|-------------|-------------------------|----------------|-------------|--------------------|----------------------|------------------|--------------------------|
| 1   | 2390.00     | 47.15 PK                | 74.00          | -26.85      | 1.60 V             | 29                   | 44.46            | 2.69                     |
| 2   | 2390.00     | 36.44 AV                | 54.00          | -17.56      | 1.60 V             | 29                   | 33.75            | 2.69                     |
| 3   | *2402.00    | 106.83 PK               |                |             | 1.60 V             | 29                   | 104.10           | 2.73                     |
| 4   | *2402.00    | 103.59 AV               |                |             | 1.60 V             | 29                   | 100.86           | 2.73                     |
| 5   | 4804.00     | 51.43 PK                | 74.00          | -22.57      | 1.00 V             | 92                   | 43.22            | 8.21                     |
| 6   | 4804.00     | 41.29 AV                | 54.00          | -12.71      | 1.00 V             | 92                   | 33.08            | 8.21                     |
| 7   | #7206.00    | 51.29 PK                | 74.00          | -22.71      | 1.92 V             | 10                   | 41.76            | 9.53                     |
| 8   | #7206.00    | 43.20 AV                | 54.00          | -10.80      | 1.92 V             | 10                   | 33.67            | 9.53                     |

**REMARKS:**

1. Emission level (dBuV/m) = Raw Value (dBuV) + Correction Factor (dB/m).
2. Correction Factor (dB/m) = Antenna Factor (dB/m) + Cable Factor (dB).
3. The emission levels of other frequencies were greater than 20dB margin.
4. Margin value = Emission level – Limit value.
5. " \* ": Fundamental frequency.
6. " # ": The radiated frequency is out of the restricted band.

|                        |               |                              |              |
|------------------------|---------------|------------------------------|--------------|
| <b>CHANNEL</b>         | TX Channel 39 | <b>DETECTOR<br/>FUNCTION</b> | Peak (PK)    |
| <b>FREQUENCY RANGE</b> | 1GHz ~ 25GHz  |                              | Average (AV) |

| ANTENNA POLARITY & TEST DISTANCE : HORIZONTAL AT 3 M |                |                               |                   |                |                          |                            |                        |                                |
|--|----------------|-------------------------------|-------------------|----------------|--------------------------|----------------------------|------------------------|--------------------------------|
| NO.  | FREQ.<br>(MHz) | EMISSION<br>LEVEL<br>(dBuV/m) | LIMIT<br>(dBuV/m) | MARGIN<br>(dB) | ANTENNA<br>HEIGHT<br>(m) | TABLE<br>ANGLE<br>(Degree) | RAW<br>VALUE<br>(dBuV) | CORRECTION<br>FACTOR<br>(dB/m) |
| 1  | *2441.00       | 105.32 PK                     |                   |                | 1.50 H                   | 160                        | 102.46                 | 2.86                           |
| 2  | *2441.00       | 103.20 AV                     |                   |                | 1.50 H                   | 160                        | 100.34                 | 2.86                           |
| 3  | 4882.00        | 52.36 PK                      | 74.00             | -21.64         | 1.00 H                   | 52                         | 43.61                  | 8.75                           |
| 4  | 4882.00        | 43.20 AV                      | 54.00             | -10.80         | 1.00 H                   | 52                         | 34.45                  | 8.75                           |
| 5  | 7323.00        | 52.36 PK                      | 74.00             | -21.64         | 1.00 H                   | 220                        | 42.76                  | 9.60                           |
| 6  | 7323.00        | 40.32 AV                      | 54.00             | -13.68         | 1.00 H                   | 220                        | 30.72                  | 9.60                           |
| ANTENNA POLARITY & TEST DISTANCE : VERTICAL AT 3 M   |                |                               |                   |                |                          |                            |                        |                                |
| NO.  | FREQ.<br>(MHz) | EMISSION<br>LEVEL<br>(dBuV/m) | LIMIT<br>(dBuV/m) | MARGIN<br>(dB) | ANTENNA<br>HEIGHT<br>(m) | TABLE<br>ANGLE<br>(Degree) | RAW<br>VALUE<br>(dBuV) | CORRECTION<br>FACTOR<br>(dB/m) |
| 1  | *2441.00       | 107.66 PK                     |                   |                | 1.80 V                   | 95                         | 104.80                 | 2.86                           |
| 2  | *2441.00       | 104.32 AV                     |                   |                | 1.80 V                   | 95                         | 101.46                 | 2.86                           |
| 3  | 4882.00        | 51.23 PK                      | 74.00             | -22.77         | 1.95 V                   | 40                         | 42.48                  | 8.75                           |
| 4  | 4882.00        | 40.32 AV                      | 54.00             | -13.68         | 1.95 V                   | 40                         | 31.57                  | 8.75                           |
| 5  | 7323.00        | 52.39 PK                      | 74.00             | -21.61         | 1.06 V                   | 52                         | 42.79                  | 9.60                           |
| 6  | 7323.00        | 38.90 AV                      | 54.00             | -15.10         | 1.06 V                   | 52                         | 29.30                  | 9.60                           |

**REMARKS:**

1. Emission level (dBuV/m) = Raw Value (dBuV) + Correction Factor (dB/m).
2. Correction Factor (dB/m) = Antenna Factor (dB/m) + Cable Factor (dB).
3. The emission levels of other frequencies were greater than 20dB margin.
4. Margin value = Emission level – Limit value.
5. " \* " : Fundamental frequency.

|                        |               |                              |              |
|------------------------|---------------|------------------------------|--------------|
| <b>CHANNEL</b>         | TX Channel 78 | <b>DETECTOR<br/>FUNCTION</b> | Peak (PK)    |
| <b>FREQUENCY RANGE</b> | 1GHz ~ 25GHz  |                              | Average (AV) |

| ANTENNA POLARITY & TEST DISTANCE : HORIZONTAL AT 3 M |                |                               |                   |                |                          |                            |                        |                                |
|--|----------------|-------------------------------|-------------------|----------------|--------------------------|----------------------------|------------------------|--------------------------------|
| NO.  | FREQ.<br>(MHz) | EMISSION<br>LEVEL<br>(dBuV/m) | LIMIT<br>(dBuV/m) | MARGIN<br>(dB) | ANTENNA<br>HEIGHT<br>(m) | TABLE<br>ANGLE<br>(Degree) | RAW<br>VALUE<br>(dBuV) | CORRECTION<br>FACTOR<br>(dB/m) |
| 1  | *2480.00       | 104.97 PK                     |                   |                | 1.04 H                   | 200                        | 102.00                 | 2.97                           |
| 2  | *2480.00       | 101.21 AV                     |                   |                | 1.04 H                   | 200                        | 98.24                  | 2.97                           |
| 3  | 2483.50        | 51.29 PK                      | 74.00             | -22.71         | 1.04 H                   | 200                        | 48.31                  | 2.98                           |
| 4  | 2483.50        | 41.29 AV                      | 54.00             | -12.71         | 1.04 H                   | 200                        | 38.31                  | 2.98                           |
| 5  | 4960.00        | 52.36 PK                      | 74.00             | -21.64         | 1.65 H                   | 220                        | 43.06                  | 9.30                           |
| 6  | 4960.00        | 39.88 AV                      | 54.00             | -14.12         | 1.65 H                   | 220                        | 30.58                  | 9.30                           |
| 7  | 7440.00        | 52.39 PK                      | 74.00             | -21.61         | 1.08 H                   | 96                         | 42.73                  | 9.66                           |
| 8  | 7440.00        | 40.20 AV                      | 54.00             | -13.80         | 1.08 H                   | 96                         | 30.54                  | 9.66                           |
| ANTENNA POLARITY & TEST DISTANCE : VERTICAL AT 3 M   |                |                               |                   |                |                          |                            |                        |                                |
| NO.  | FREQ.<br>(MHz) | EMISSION<br>LEVEL<br>(dBuV/m) | LIMIT<br>(dBuV/m) | MARGIN<br>(dB) | ANTENNA<br>HEIGHT<br>(m) | TABLE<br>ANGLE<br>(Degree) | RAW<br>VALUE<br>(dBuV) | CORRECTION<br>FACTOR<br>(dB/m) |
| 1  | *2480.00       | 108.29 PK                     |                   |                | 1.39 V                   | 322                        | 105.32                 | 2.97                           |
| 2  | *2480.00       | 104.75 AV                     |                   |                | 1.39 V                   | 322                        | 101.78                 | 2.97                           |
| 3  | 2483.50        | 52.81 PK                      | 74.00             | -21.19         | 1.39 V                   | 322                        | 49.83                  | 2.98                           |
| 4  | 2483.50        | 38.54 AV                      | 54.00             | -15.46         | 1.39 V                   | 322                        | 35.56                  | 2.98                           |
| 5  | 4960.00        | 51.39 PK                      | 74.00             | -22.61         | 1.84 V                   | 252                        | 42.09                  | 9.30                           |
| 6  | 4960.00        | 40.26 AV                      | 54.00             | -13.74         | 1.84 V                   | 252                        | 30.96                  | 9.30                           |
| 7  | 7440.00        | 53.10 PK                      | 74.00             | -20.90         | 1.08 V                   | 69                         | 43.44                  | 9.66                           |
| 8  | 7440.00        | 41.28 AV                      | 54.00             | -12.72         | 1.08 V                   | 69                         | 31.62                  | 9.66                           |

**REMARKS:**

1. Emission level (dBuV/m) = Raw Value (dBuV) + Correction Factor (dB/m).
2. Correction Factor (dB/m) = Antenna Factor (dB/m) + Cable Factor (dB).
3. The emission levels of other frequencies were greater than 20dB margin.
4. Margin value = Emission level – Limit value.
5. " \* " : Fundamental frequency.

### 4.3 NUMBER OF HOPPING FREQUENCY USED

#### 4.3.1 LIMIT OF HOPPING FREQUENCY USED

At least 15 channels frequencies, and should be equally spaced.

#### 4.3.2 TEST SETUP

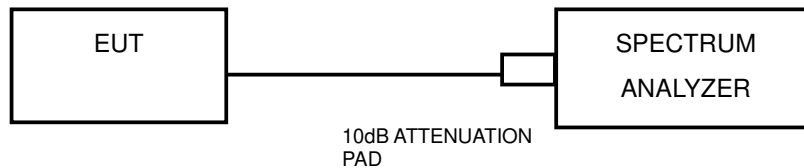

#### 4.3.3 TEST INSTRUMENTS

| Equipment                        | Manufacturer  | Model No.                     | Serial No.  | Next Cal.   |
|----------------------------------|---------------|-------------------------------|-------------|-------------|
| Power Sensor                     | Keysight      | U2021XA                       | MY57320002  | Jan. 11, 24 |
| Power Meter                      | Anritsu       | ML2495A                       | 1139001     | Aug. 22, 23 |
| Power Sensor                     | Anritsu       | MA2411B                       | 1531155     | Aug. 22, 23 |
| Digital Multimeter               | FLUKE         | 15B                           | A1220010DG  | N/A         |
| Humid & Temp Programmable Tester | Haida         | HD-225T                       | 110807201   | Nov. 02, 23 |
| Oscilloscope                     | Agilent       | DSO9254A                      | MY51260160  | Jul. 27, 23 |
| Signal and Spectrum Analyzer     | Rohde&Schwarz | FSV40                         | 101094      | Jan. 11, 24 |
| Signal Generator                 | Agilent       | N5183A                        | MY50140980  | Jul. 20, 23 |
| MXG-B RF Vector Signal Generator | Keysight      | N5182B                        | MY56200288  | Jul. 20, 23 |
| BLUETOOTH TESTER                 | Rohde&Schwarz | CBT32                         | 100811      | N/A         |
| Attenuator                       | MINI          | BW-S10W2+                     | S130129FGE2 | N/A         |
| DC Source                        | Keysight      | E3642A                        | MY56146098  | N/A         |
| Test software                    | ADT           | ADT_RF Test Software V6.6.5.3 | N/A         | N/A         |

**NOTE:** 1. The test was performed in RF Test Shielded Room .  
 2. The calibration interval of the above test instruments is 12 months and the calibrations are traceable to CEPREI/CHINA, GRGT/CHINA and NIM/CHINA.



#### 4.3.4 TEST PROCEDURES

- a. Check the calibration of the measuring instrument (SA) using either an internal calibrator or a known signal from an external generator.
- b. Turn on the EUT and connect its antenna terminal to measurement via a low loss cable. Then set it to any one measured frequency within its operating range and make sure the instrument is operated in its linear range.
- c. Set the SA on MaxHold Mode, and then keep the EUT in hopping mode. Record all the signals from each channel until each one has been recorded.
- d. Set the SA on View mode and then plot the result on SA screen.
- e. Repeat above procedures until all frequencies measured were completed.

#### 4.3.5 DEVIATION FROM TEST STANDARD

No deviation.

#### 4.3.6 TEST RESULTS

There are 79 hopping frequencies in the hopping mode. Please refer to next two pages for the test result. On the plots, it shows that the hopping frequencies are equally spaced.





Test Report No.: RF2305WDG0021-1

GFSK

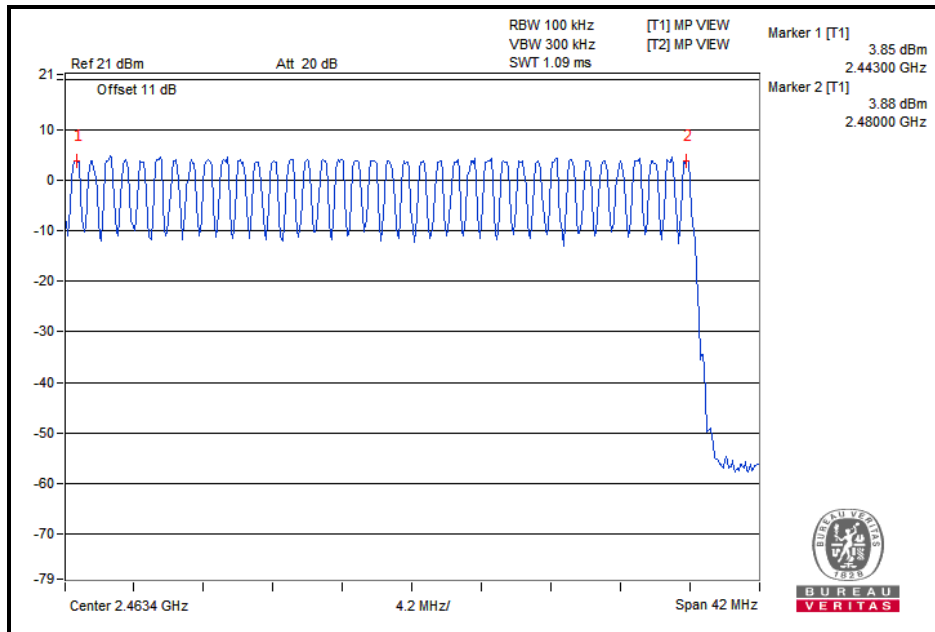
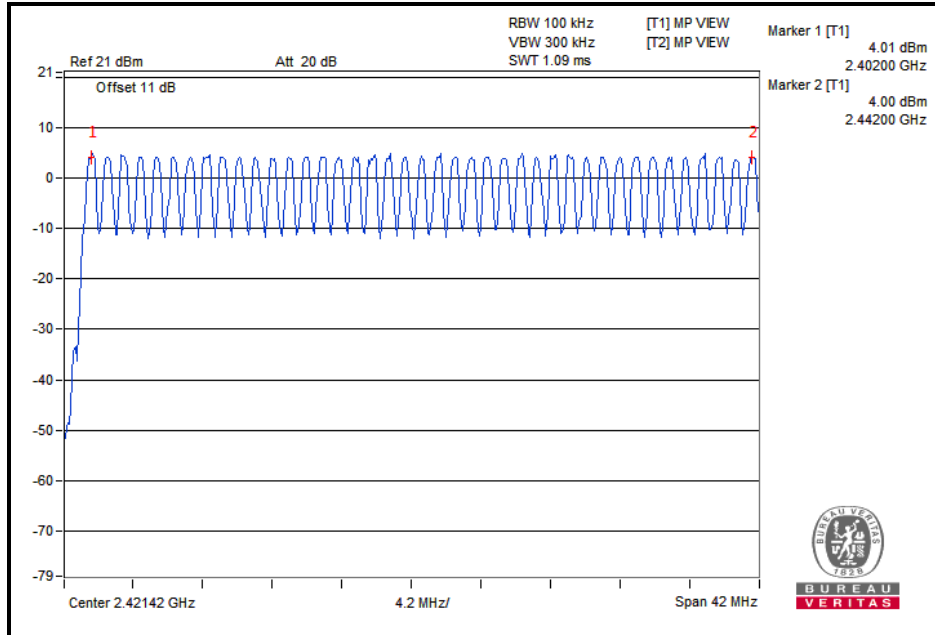

Bureau Veritas Shenzhen Co., Ltd.  
Dongguan Branch

No. 96, Guantai Road (Houjie Section), Houjie  
Town, Dongguan City, Guangdong Province.  
523942, People's Republic of China.

Tel: +86 769 8998 2098  
Fax: +86 769 8593 1080  
Email: [customerservice.dg@bureauveritas.com](mailto:customerservice.dg@bureauveritas.com)



Test Report No.: RF2305WDG0021-1

8DPSK

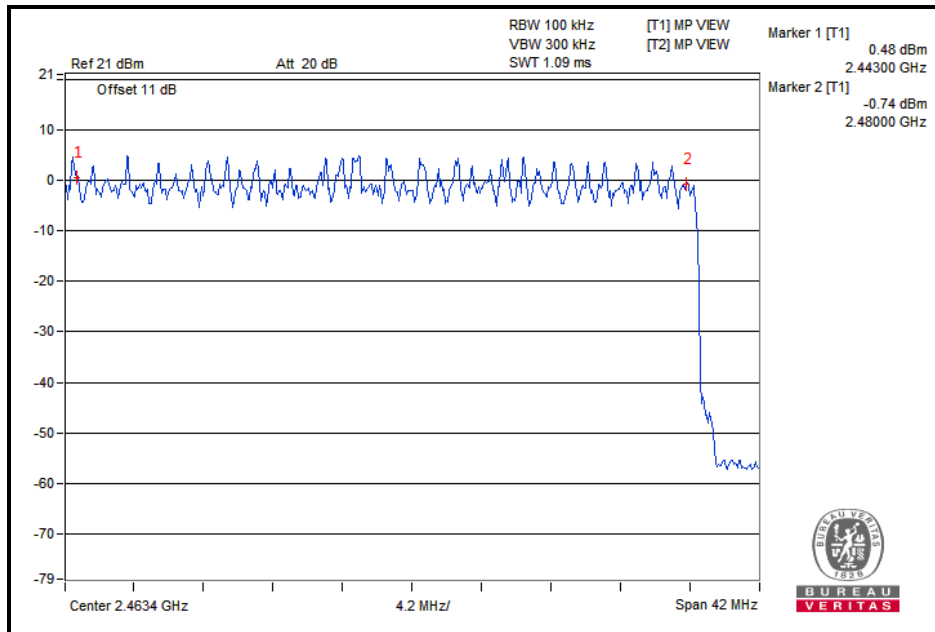
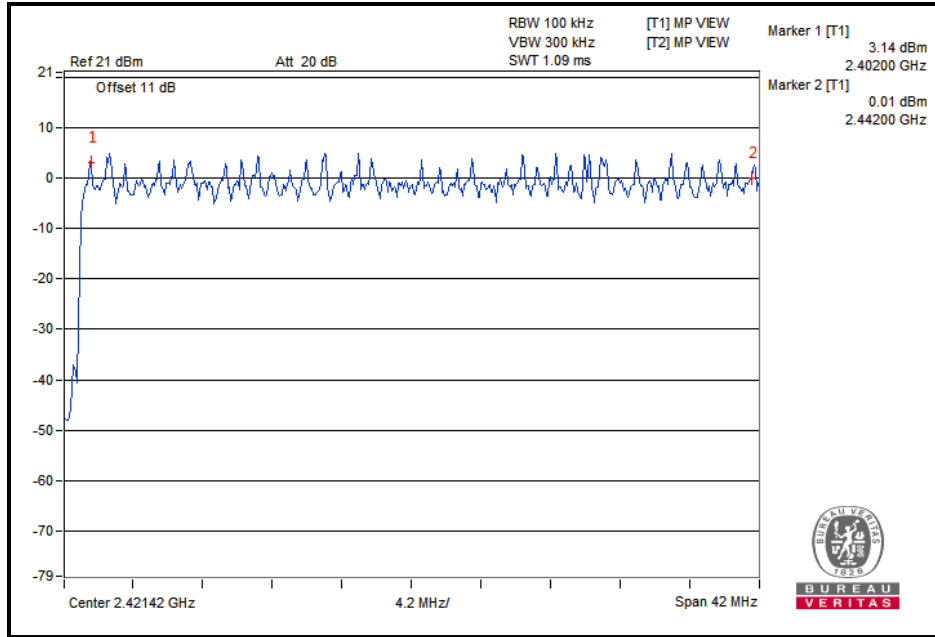

Bureau Veritas Shenzhen Co., Ltd.  
Dongguan Branch

No. 96, Guantai Road (Houjie Section), Houjie  
Town, Dongguan City, Guangdong Province.  
523942, People's Republic of China.

Tel: +86 769 8998 2098  
Fax: +86 769 8593 1080  
Email: [customerservice.dg@bureauveritas.com](mailto:customerservice.dg@bureauveritas.com)

#### 4.4 DWELL TIME ON EACH CHANNEL

##### 4.4.1 LIMIT OF DWELL TIME USED

The average time of occupancy on any channel shall not be greater than 0.4 seconds within a period of 0.4 seconds multiplied by the number of hopping channels employed.

##### 4.4.2 TEST SETUP

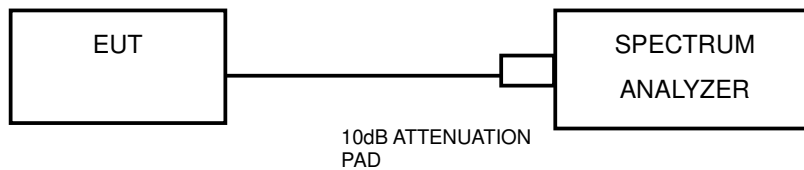

##### 4.4.3 TEST INSTRUMENTS

Refer to section 4.3.3 to get information of above instrument.

##### 4.4.4 TEST PROCEDURES

- a. Check the calibration of the measuring instrument (SA) using either an internal calibrator or a known signal from an external generator.
- b. Turn on the EUT and connect its antenna terminal to measurement via a low loss cable. Then set it to any one measured frequency within its operating range and make sure the instrument is operated in its linear range.
- c. Adjust the center frequency of SA on any frequency be measured and set SA to zero span mode. And then, set RBW and VBW of spectrum analyzer to proper value.
- d. Measure the time duration of one transmission on the measured frequency. And then plot the result with time difference of this time duration.
- e. Repeat above procedures until all different time-slot modes have been completed.

#### 4.4.5 DEVIATION FROM TEST STANDARD

No deviation.

#### 4.4.6 TEST RESULTS

##### GFSK

| Mode | Number of Hopping Channel | Number of transmission in a period(channel number*0.4 sec) |                  |                  |                   | Length of transmission time (msec) | Result (msec) | Limit (msec) | PASS / FAIL |
|------|---------------------------|--|------------------|------------------|-------------------|------------------------------------|---------------|--------------|-------------|
|      |                           | period (sec)   | sweep time (sec) | times in a sweep | times in a period |                                    |               |              |             |
| DH1  | 79                        | 31.6   | 5                | 51               | 322.32            | 0.42                               | 135.374       | 400          | PASS        |
| DH3  | 79                        | 31.6   | 5                | 25               | 158               | 1.71                               | 270.18        | 400          | PASS        |
| DH5  | 79                        | 31.6   | 5                | 17               | 107.44            | 2.992                              | 321.46        | 400          | PASS        |

##### 8DPSK

| Mode | Number of Hopping Channel | Number of transmission in a period(channel number*0.4 sec) |                  |                  |                   | Length of transmission time (msec) | Result (msec) | Limit (msec) | PASS / FAIL |
|------|---------------------------|--|------------------|------------------|-------------------|------------------------------------|---------------|--------------|-------------|
|      |                           | period (sec)   | sweep time (sec) | times in a sweep | times in a period |                                    |               |              |             |
| 3DH1 | 79                        | 31.6   | 5                | 51               | 322.32            | 0.444                              | 143.11        | 400          | PASS        |
| 3DH3 | 79                        | 31.6   | 5                | 25               | 158               | 1.7                                | 268.6         | 400          | PASS        |
| 3DH5 | 79                        | 31.6   | 5                | 17               | 107.44            | 2.944                              | 316.303       | 400          | PASS        |

**NOTE:** Test plots of the transmitting time slot are shown on next page.



BUREAU VERITAS

Test Report No.: RF2305WDG0021-1

### GFSK



Bureau Veritas Shenzhen Co., Ltd.  
Dongguan Branch

No. 96, Guantai Road (Houjie Section), Houjie  
Town, Dongguan City, Guangdong Province.  
523942, People's Republic of China.

Tel: +86 769 8998 2098  
Fax: +86 769 8593 1080  
Email: [customerservice.dg@bureauveritas.com](mailto:customerservice.dg@bureauveritas.com)

**8DPSK**



## 4.5 CHANNEL BANDWIDTH

### 4.5.1 LIMITS OF CHANNEL BANDWIDTH

For frequency hopping system operating in the 2400-2483.5MHz, If the 20dB bandwidth of hopping channel is greater than 25kHz, two-thirds 20dB bandwidth of hopping channel shall be a minimum limit for the hopping channel separation.

### 4.5.2 TEST SETUP

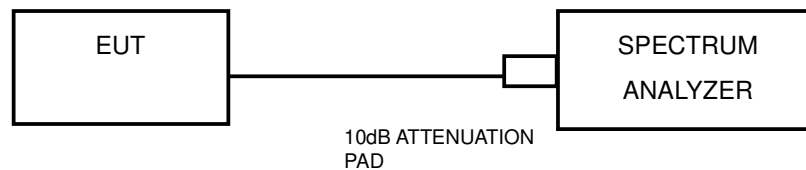

### 4.5.3 TEST INSTRUMENTS

Refer to section 4.3.3 to get information of above instrument.

### 4.5.4 TEST PROCEDURE

- a. Check the calibration of the measuring instrument using either an internal calibrator or a known signal from an external generator.
- b. Turn on the EUT and connect it to measurement instrument. Then set it to any one convenient frequency within its operating range. Set a reference level on the measuring instrument equal to the highest peak value.
- c. Measure the frequency difference of two frequencies that were attenuated 20dB from the reference level. Record the frequency difference as the emission bandwidth.
- d. Repeat above procedures until all frequencies measured were complete.

### 4.5.5 DEVIATION FROM TEST STANDARD

No deviation.

### 4.5.6 EUT OPERATING CONDITION

The software provided by client to enable the EUT under transmission condition continuously at lowest, middle and highest channel frequencies individually.

### 4.5.7 TEST RESULTS

#### GFSK

| CHANNEL | CHANNEL FREQUENCY (MHz) | 20dB BANDWIDTH (MHz) |
|---------|-------------------------|----------------------|
| 0       | 2402                    | 0.96                 |
| 39      | 2441                    | 0.96                 |
| 78      | 2480                    | 0.96                 |

#### CH 0

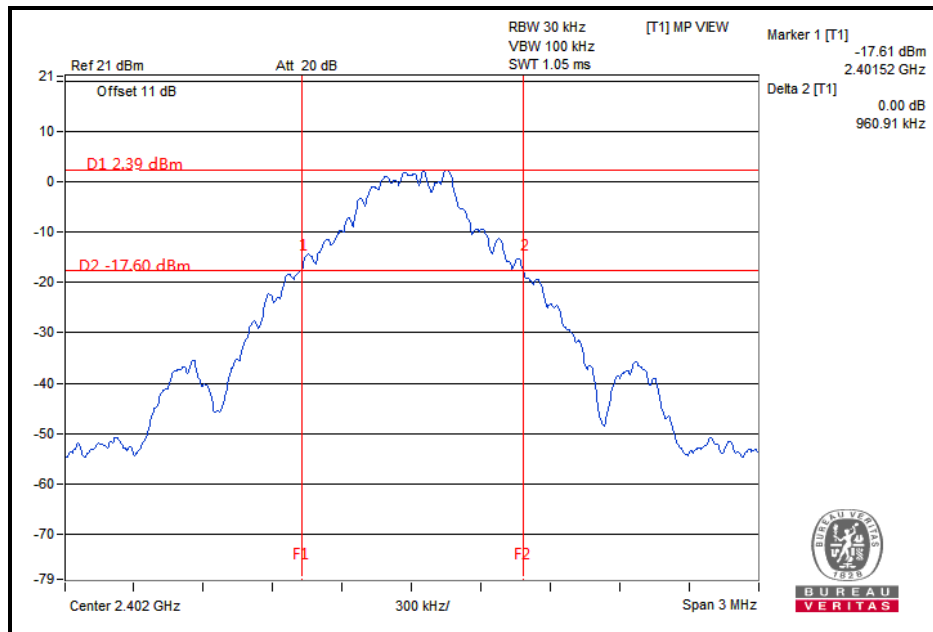



CH 39

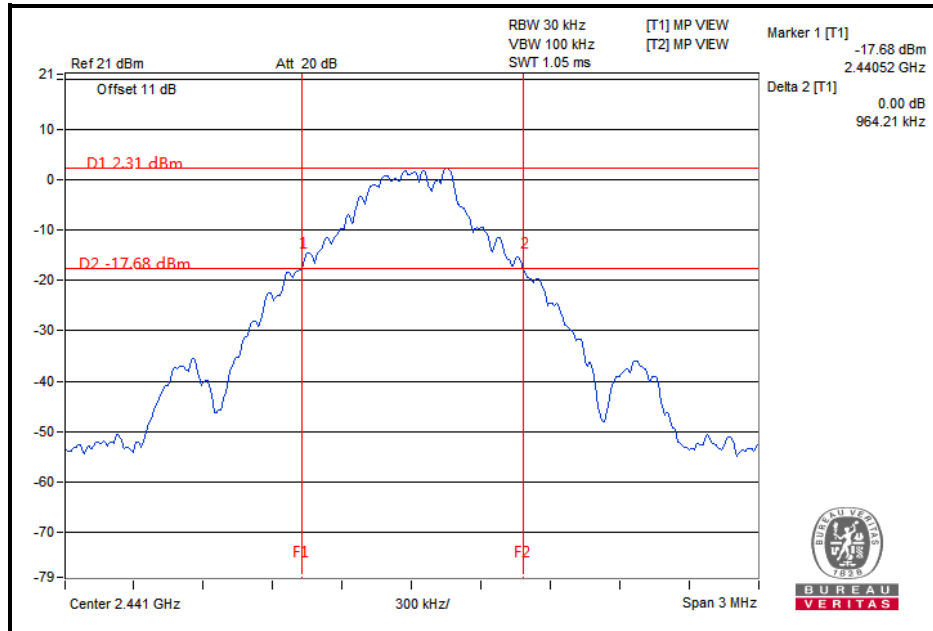

CH 78

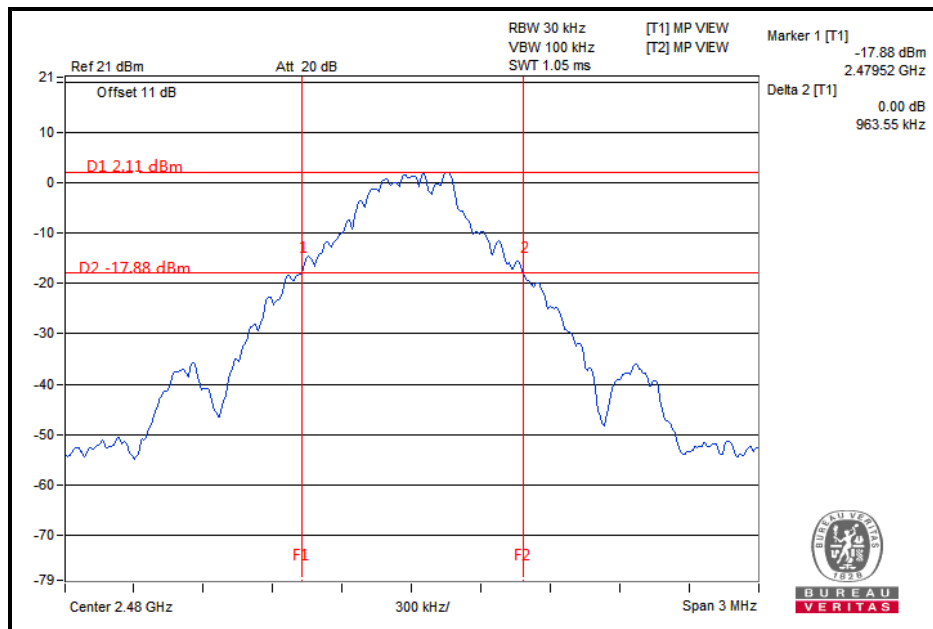

**8DPSK**

| CHANNEL | CHANNEL FREQUENCY (MHz) | 20dB BANDWIDTH (MHz) |
|---------|-------------------------|----------------------|
| 0       | 2402                    | 1.26                 |
| 39      | 2441                    | 1.26                 |
| 78      | 2480                    | 1.26                 |

**CH 0**

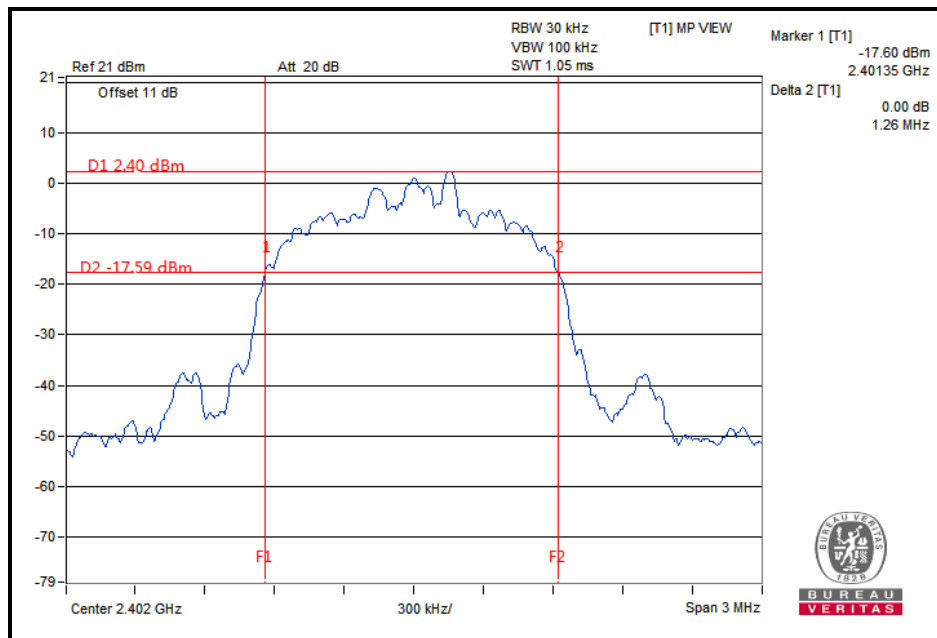

CH 39

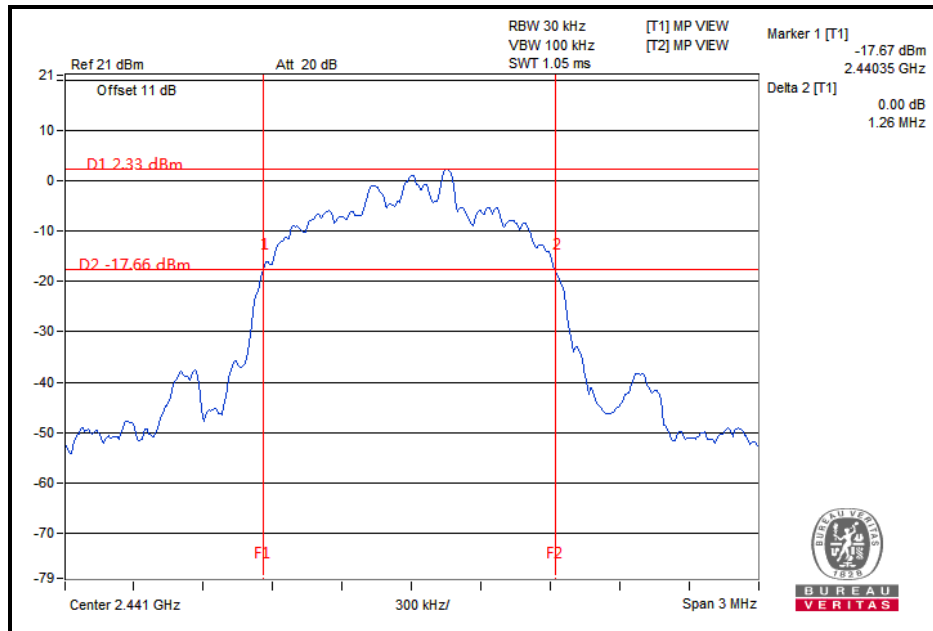

CH 78

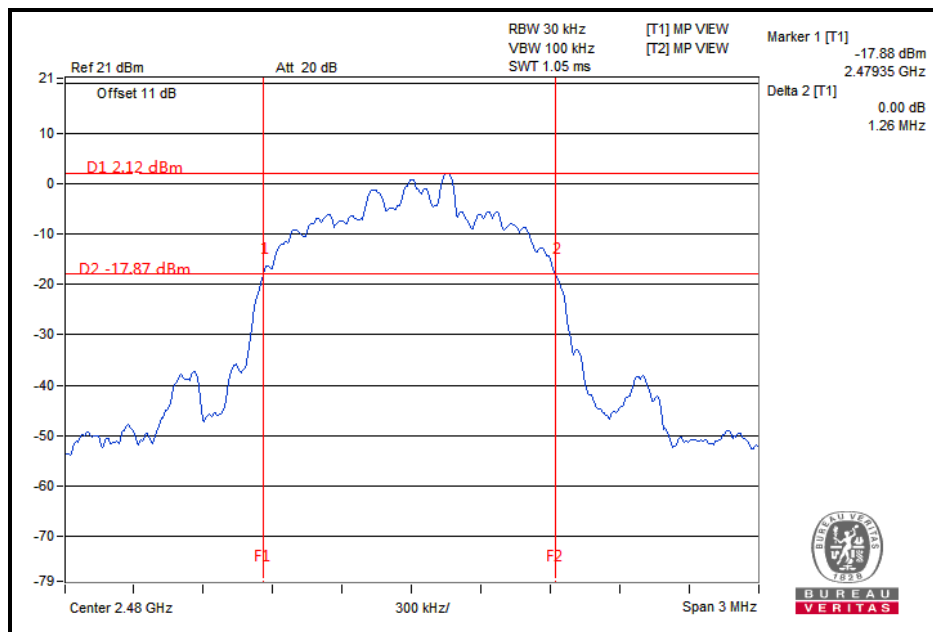

## 4.6 HOPPING CHANNEL SEPARATION

### 4.6.1 LIMIT OF HOPPING CHANNEL SEPARATION

At least 25kHz or two-third of 20dB hopping channel bandwidth (whichever is greater).

### 4.6.2 TEST SETUP

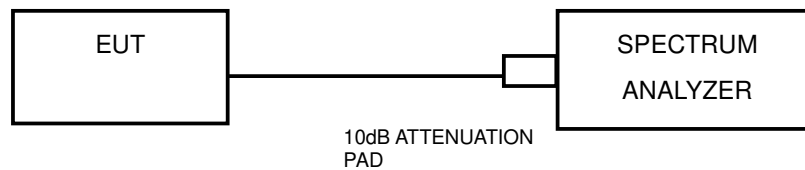

### 4.6.3 TEST INSTRUMENTS

Refer to section 4.3.3 to get information of above instrument.

### 4.6.4 TEST PROCEDURES

1. Check the calibration of the measuring instrument using either an internal calibrator or a known signal from an external generator.
2. Turn on the EUT and connect it to measurement instrument. Then set it to any one convenient frequency within its operating range.
3. By using the MaxHold function record the separation of two adjacent channels.
4. Measure the frequency difference of these two adjacent channels by SA MARK function. And then plot the result on SA screen.
5. Repeat above procedures until all frequencies measured were complete.

### 4.6.5 DEVIATION FROM TEST STANDARD

No deviation.

### 4.6.6 TEST RESULTS

#### GFSK

| CHANNEL | FREQUENCY (MHz) | ADJACENT CHANNEL SEPARATION (MHz) | 20dB BANDWIDTH (MHz) | MINIMUM LIMIT (MHz) | PASS / FAIL |
|---------|-----------------|-----------------------------------|----------------------|---------------------|-------------|
| 0       | 2402            | 1.00                              | 0.96                 | 0.64                | PASS        |
| 39      | 2441            | 1.00                              | 0.96                 | 0.64                | PASS        |
| 78      | 2480            | 1.00                              | 0.96                 | 0.64                | PASS        |

**NOTE:** The minimum limit is two-third 20dB bandwidth.

#### CH 0

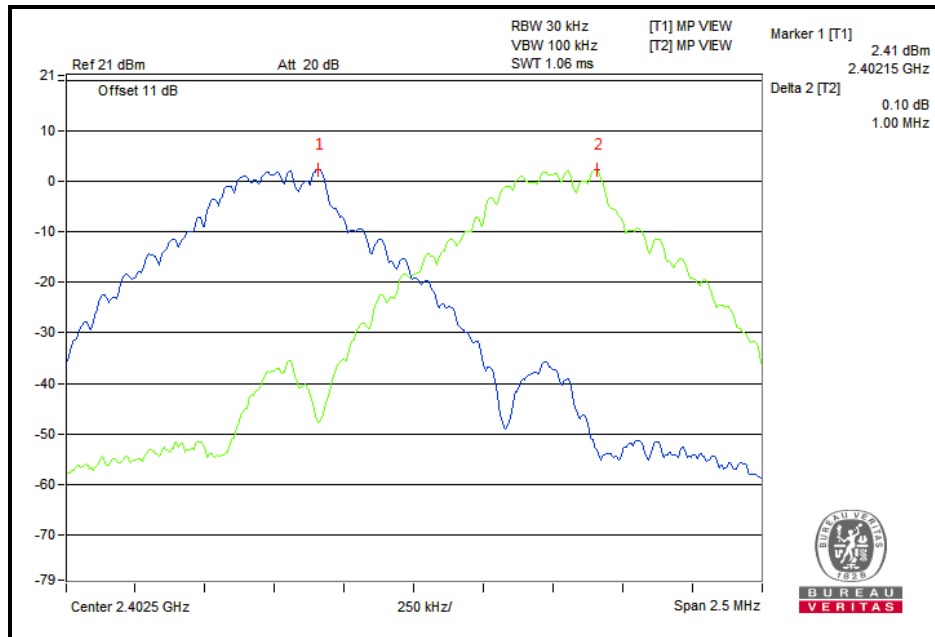

CH 39

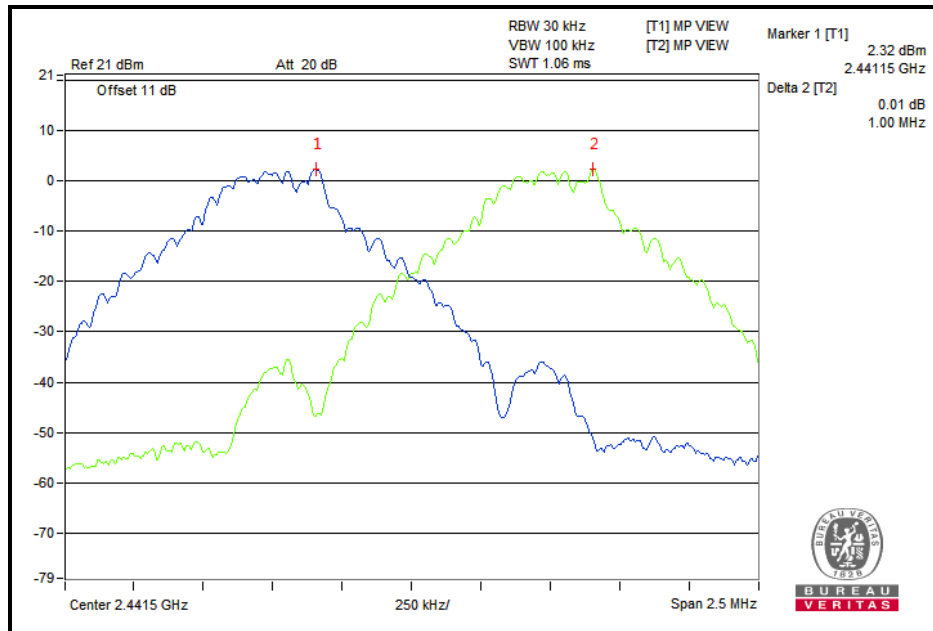

CH 78

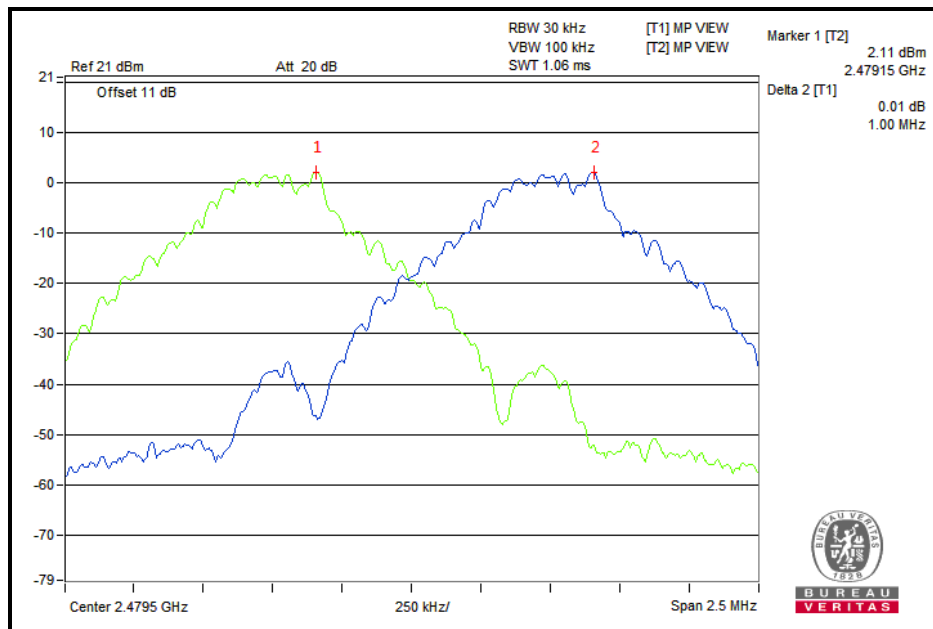

**8DPSK**

| CHANNEL | FREQUENCY (MHz) | ADJACENT CHANNEL SEPARATION (MHz) | 20dB BANDWIDTH (MHz) | MINIMUM LIMIT (MHz) | PASS / FAIL |
|---------|-----------------|-----------------------------------|----------------------|---------------------|-------------|
| 0       | 2402            | 1.00                              | 1.26                 | 0.84                | PASS        |
| 39      | 2441            | 1.00                              | 1.26                 | 0.84                | PASS        |
| 78      | 2480            | 1.00                              | 1.26                 | 0.84                | PASS        |

**NOTE:** The minimum limit is two-third 20dB bandwidth.

**CH 0**

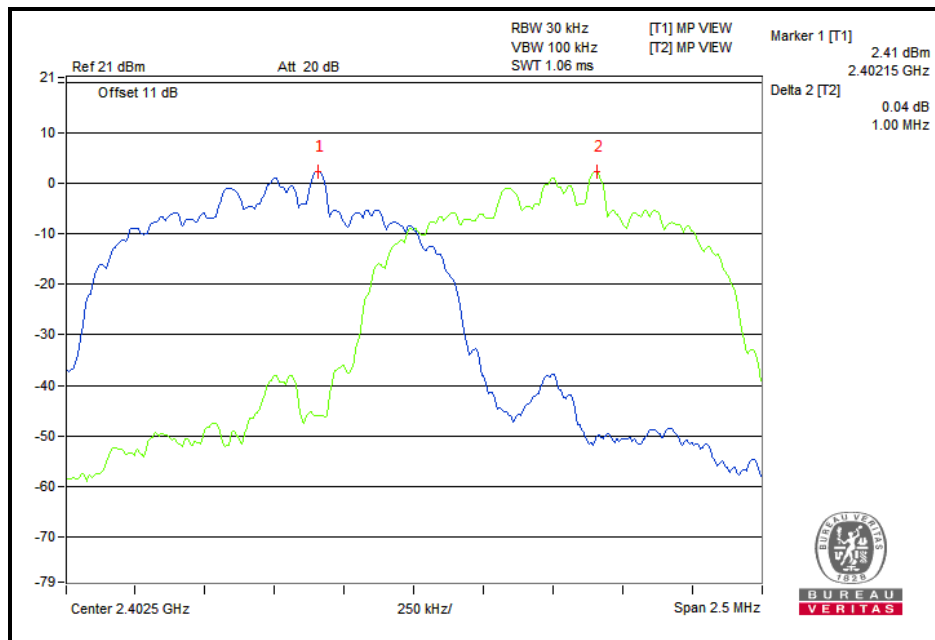

CH 39

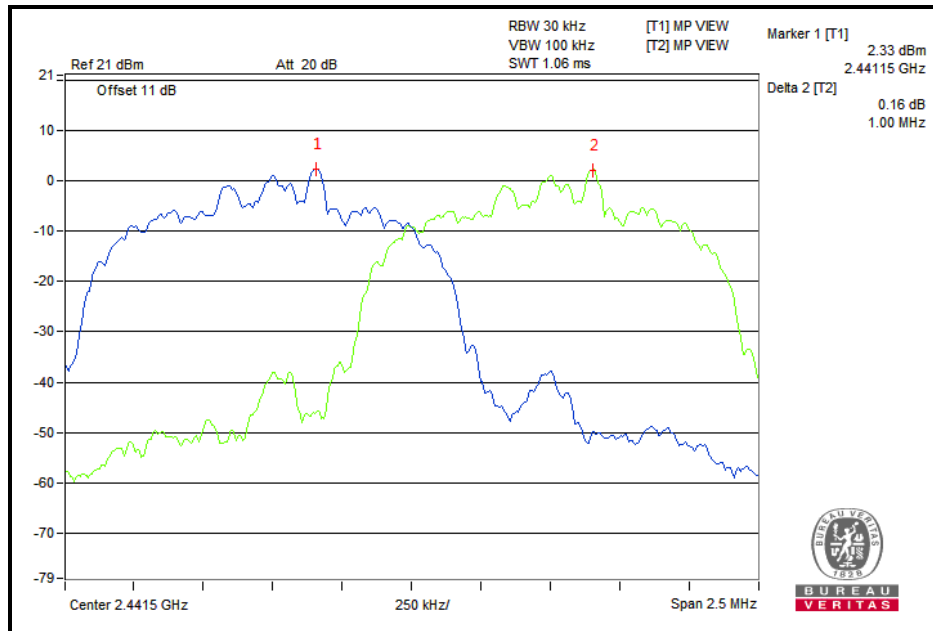

CH 78

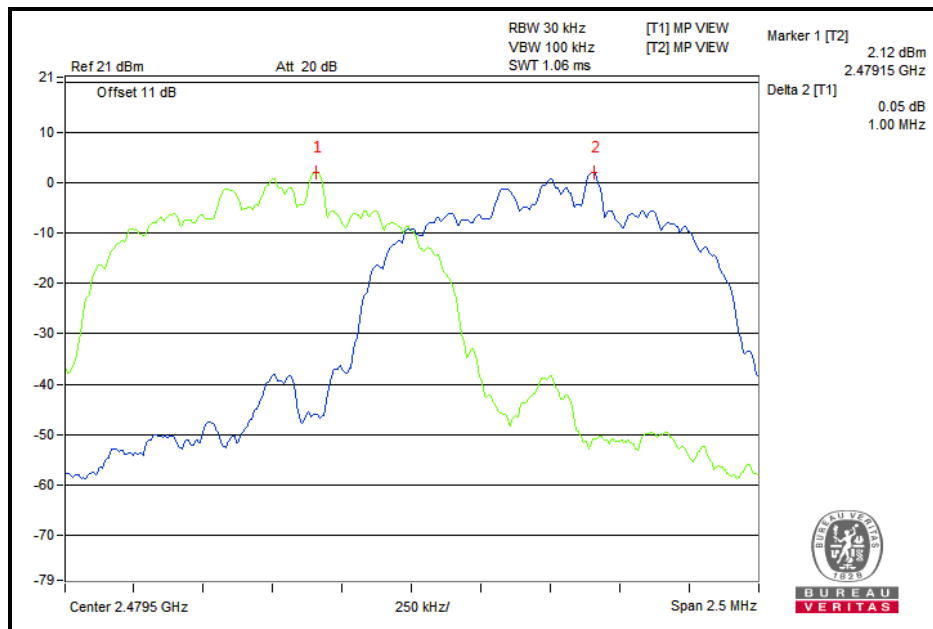



## 4.7 CONDUCTED OUTPUT POWER

### 4.7.1 LIMITS OF CONDUCTED OUTPUT POWER MEASUREMENT

The Maximum Output Power Measurement is 125mW.

### 4.7.2 TEST SETUP

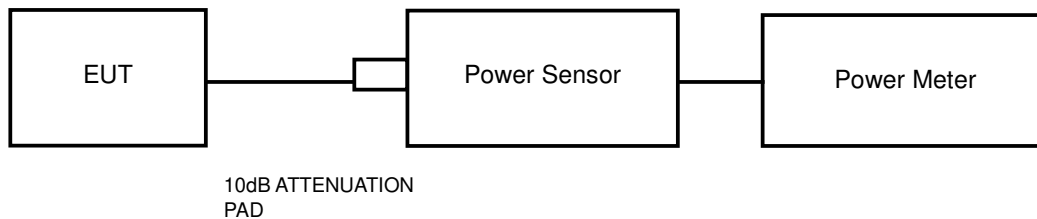

### 4.7.3 TEST INSTRUMENTS

Refer to section 4.3.3 to get information of above instrument.

### 4.7.4 TEST PROCEDURES

A peak power sensor was used on the output port of the EUT. A power meter was used to read the response of the peak power sensor and set the detector to PEAK. Record the power level.

An average power sensor was used on the output port of the EUT. A power meter was used to read the response of the average power sensor and set the detector to AVERAGE. Record the power level.

### 4.7.5 DEVIATION FROM TEST STANDARD

No deviation.

#### 4.7.6 EUT OPERATING CONDITION

The software provided by client to enable the EUT under transmission condition continuously at lowest, middle and highest channel frequencies individually.

#### 4.7.7 TEST RESULTS

##### MAXIMUM PEAK OUTPUT POWER

###### GFSK

| CHANNEL | CHANNEL FREQUENCY (MHz) | PEAK POWER (dBm) | PEAK POWER (mW) | PEAK POWER LIMIT (mW) | PASS/FAIL |
|---------|-------------------------|------------------|-----------------|-----------------------|-----------|
| 0       | 2402                    | 5.28             | 3.373           | 125                   | PASS      |
| 39      | 2441                    | 4.95             | 3.126           | 125                   | PASS      |
| 78      | 2480                    | 4.76             | 2.992           | 125                   | PASS      |

###### 8DPSK

| CHANNEL | CHANNEL FREQUENCY (MHz) | PEAK POWER (dBm) | PEAK POWER (mW) | PEAK POWER LIMIT (mW) | PASS/FAIL |
|---------|-------------------------|------------------|-----------------|-----------------------|-----------|
| 0       | 2402                    | 5.22             | 3.327           | 125                   | PASS      |
| 39      | 2441                    | 5.12             | 3.251           | 125                   | PASS      |
| 78      | 2480                    | 4.93             | 3.112           | 125                   | PASS      |

**AVERAGE OUTPUT POWER(FOR REFERENCE)**

**GFSK**

| CHANNEL | CHANNEL FREQUENCY (MHz) | AVERAGE POWER (dBm) | AVERAGE POWER (mW) |
|---------|-------------------------|---------------------|--------------------|
| 0       | 2402                    | 5.16                | 3.281              |
| 39      | 2441                    | 4.89                | 3.083              |
| 78      | 2480                    | 4.52                | 2.831              |

**8DPSK**

| CHANNEL | CHANNEL FREQUENCY (MHz) | AVERAGE POWER (dBm) | AVERAGE POWER (mW) |
|---------|-------------------------|---------------------|--------------------|
| 0       | 2402                    | 2.74                | 1.879              |
| 39      | 2441                    | 2.45                | 1.758              |
| 78      | 2480                    | 2.10                | 1.622              |



## 4.8 OUT OF BAND EMISSION MEASUREMENT

### 4.8.1 LIMITS OF OUT OF BAND EMISSION MEASUREMENT

Below  $-20\text{dB}$  of the highest emission level of operating band (in 100KHz RBW).

### 4.8.2 TEST INSTRUMENTS

Refer to section 4.3.3 to get information of above instrument.

### 4.8.3 TEST PROCEDURE

The transmitter output was connected to the spectrum analyzer via a low loss cable. of Spectrum Analyzer was set RBW to 100 kHz and VBW to 300 kHz with suitable frequency span including 100 MHz bandwidth from band edge. Detector = PEAK and Trace mode = Max Hold. The band edges was measured and recorded.

### 4.8.4 DEVIATION FROM TEST STANDARD

No deviation.

### 4.8.5 EUT OPERATING CONDITION

The software provided by client to enable the EUT under transmission condition continuously at lowest, middle and highest channel frequencies individually.

### 4.8.6 TEST RESULTS

The spectrum plots are attached on the following images. D1 line indicates the highest level. D2 line indicates the 20dB offset below D1. It shows compliance to the requirement.



BUREAU VERITAS

Test Report No.: RF2305WDG0021-1

GFSK

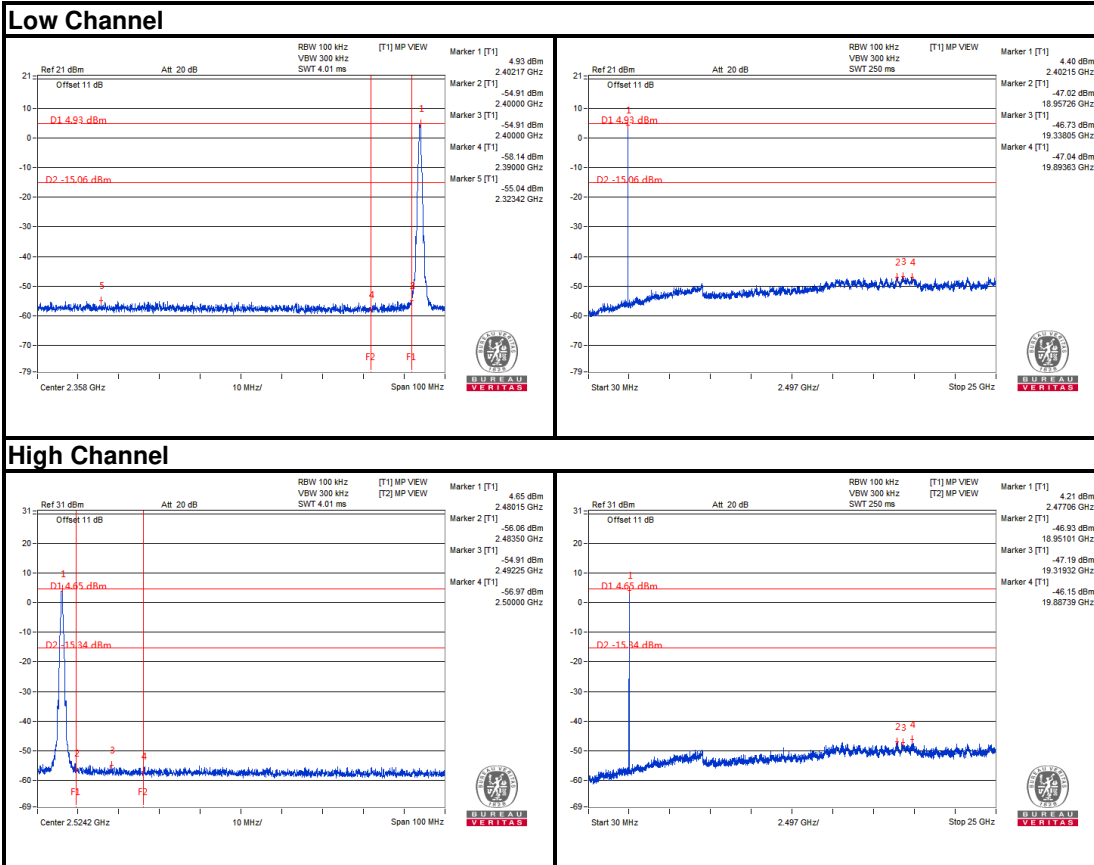

Bureau Veritas Shenzhen Co., Ltd.  
Dongguan Branch

No. 96, Guantai Road (Houjie Section), Houjie Town, Dongguan City, Guangdong Province. 523942. People's Republic of China.

Tel: +86 769 8998 2098  
Fax: +86 769 8593 1080  
Email: [customerservice.dg@bureauveritas.com](mailto:customerservice.dg@bureauveritas.com)



BUREAU VERITAS

Test Report No.: RF2305WDG0021-1

8DPSK

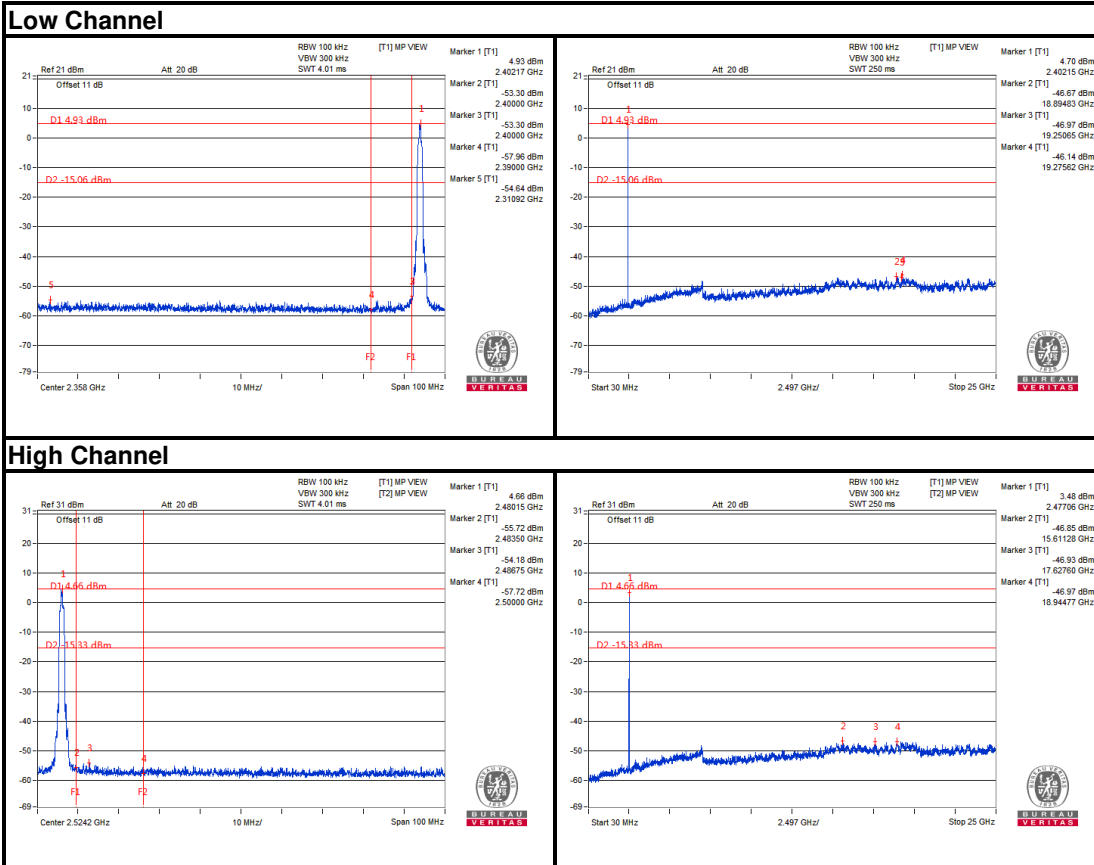

Bureau Veritas Shenzhen Co., Ltd.  
Dongguan Branch

No. 96, Guantai Road (Houjie Section), Houjie  
Town, Dongguan City, Guangdong Province.  
523942, People's Republic of China.

Tel: +86 769 8998 2098  
Fax: +86 769 8593 1080  
Email: [customerservice.dg@bureauveritas.com](mailto:customerservice.dg@bureauveritas.com)



BUREAU VERITAS

Test Report No.: RF2305WDG0021-1

GFSK

### Hopping on Low Channel

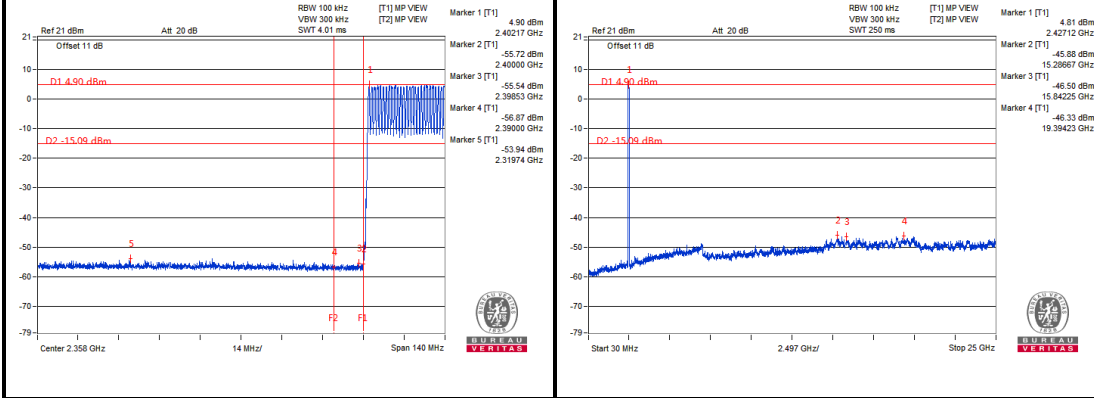

### Hopping on High Channel

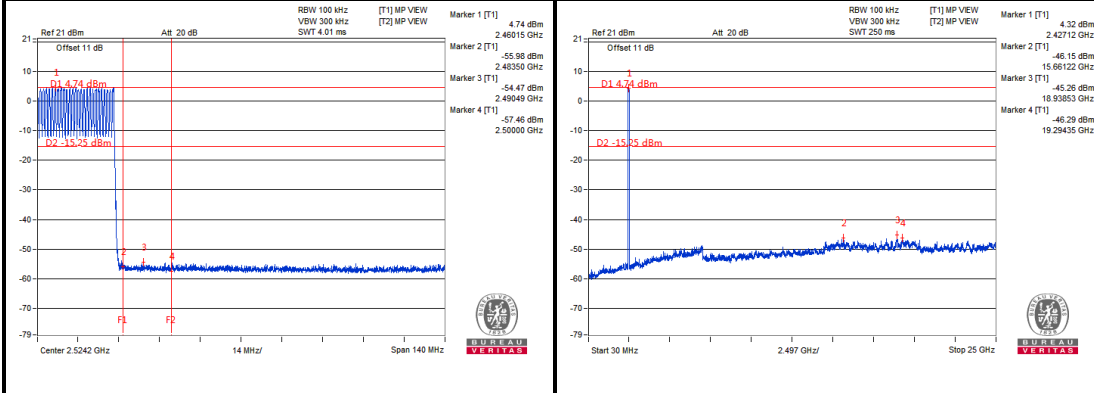

Bureau Veritas Shenzhen Co., Ltd.  
Dongguan Branch

No. 96, Guantai Road (Houjie Section), Houjie  
Town, Dongguan City, Guangdong Province.  
523942. People's Republic of China.

Tel: +86 769 8998 2098  
Fax: +86 769 8593 1080  
Email: [customerservice.dg@bureauveritas.com](mailto:customerservice.dg@bureauveritas.com)



8DPSK

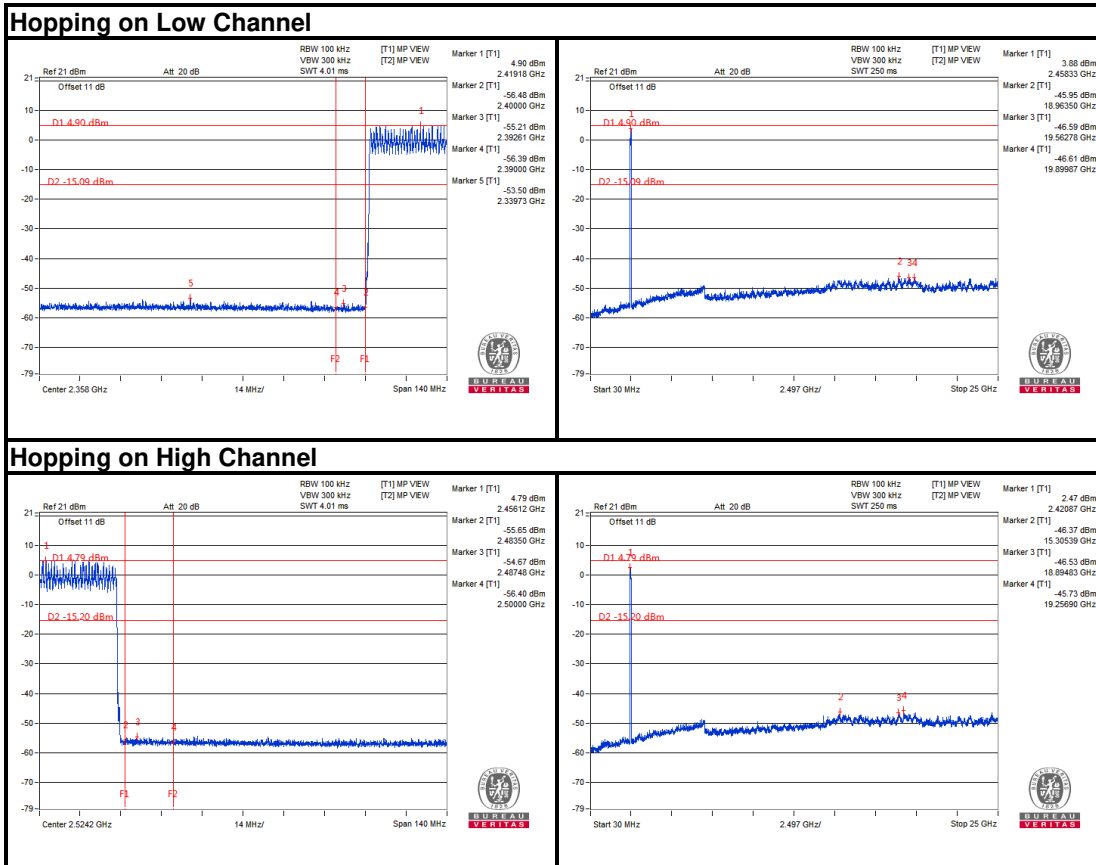





Test Report No.: RF2305WDG0021-1

## 5 PHOTOGRAPHS OF THE TEST CONFIGURATION

Please refer to the attached file (Test Setup Photo).



Test Report No.: RF2305WDG0021-1

## 6 APPENDIX A - MODIFICATIONS RECORDERS FOR ENGINEERING CHANGES TO THE EUT BY THE LAB

No any modifications are made to the EUT by the lab during the test.

---END---