

Antenna Gain Information

Model: INFO3.5 CSM MY20

Design verification of the
Dual Band Bluetooth/WLAN Antenna in
GM 3.5 DV2 sample

1. Change History

| Name | Date | Document Version | Reason for change |
|------|------|------------------|-------------------|
|------|------|------------------|-------------------|

| | | | |
|--------------|------------|---|-----------------|
| Alexey Defer | 10.10.2017 | 1 | Initial version |
| | | | |
| | | | |
| | | | |
| | | | |
| | | | |
| | | | |
| | | | |

Index

- 1. Change History 2**
- 2. Scope..... 4**
- 3. Measurement 4**
 - 3.1. DUT 4
 - 3.2. Setup for measurement of matching 4
 - 3.3. Reference point measurement 5
 - 3.4. Setup for radiated measurement 6
 - 3.5. Explaining of DUT position during measurement..... 7
 - 3.6. Antenna placement during the measurement 8
 - 3.7. Matching of the antenna..... 9
 - 3.8. Antenna diagrams 12
 - 3.9. Antenna efficiency and gain 19
- 4. Conclusion 20**

2. Scope

The document provides measurements und results of the performance of a PCB antenna .
The antenna was investigated regarding to:

- Matching at 50 Ohm
- Radiation efficiency
- Maximum antenna gain

3. Measurement

3.1. DUT

Figure 1 shows Head Unit assembly, the BT/WLAN antenna is located directly below the black plastic cover .



Figure 1: Head Unit assembly

3.2. Setup for measurement of matching

For matching measurement is used Network Analyser N5242A (NWA). The NWA is full 2-Port calibrated, the phase and loss of semi rigid cables are removed with "Port extension" function. Nominal test power of both ports is -15 dBm.

3.3. Reference point measurement

The reference point of all measurements is the pad of BT/WLAN module. The trace loss between module and antenna is included in antenna gain and efficiency.

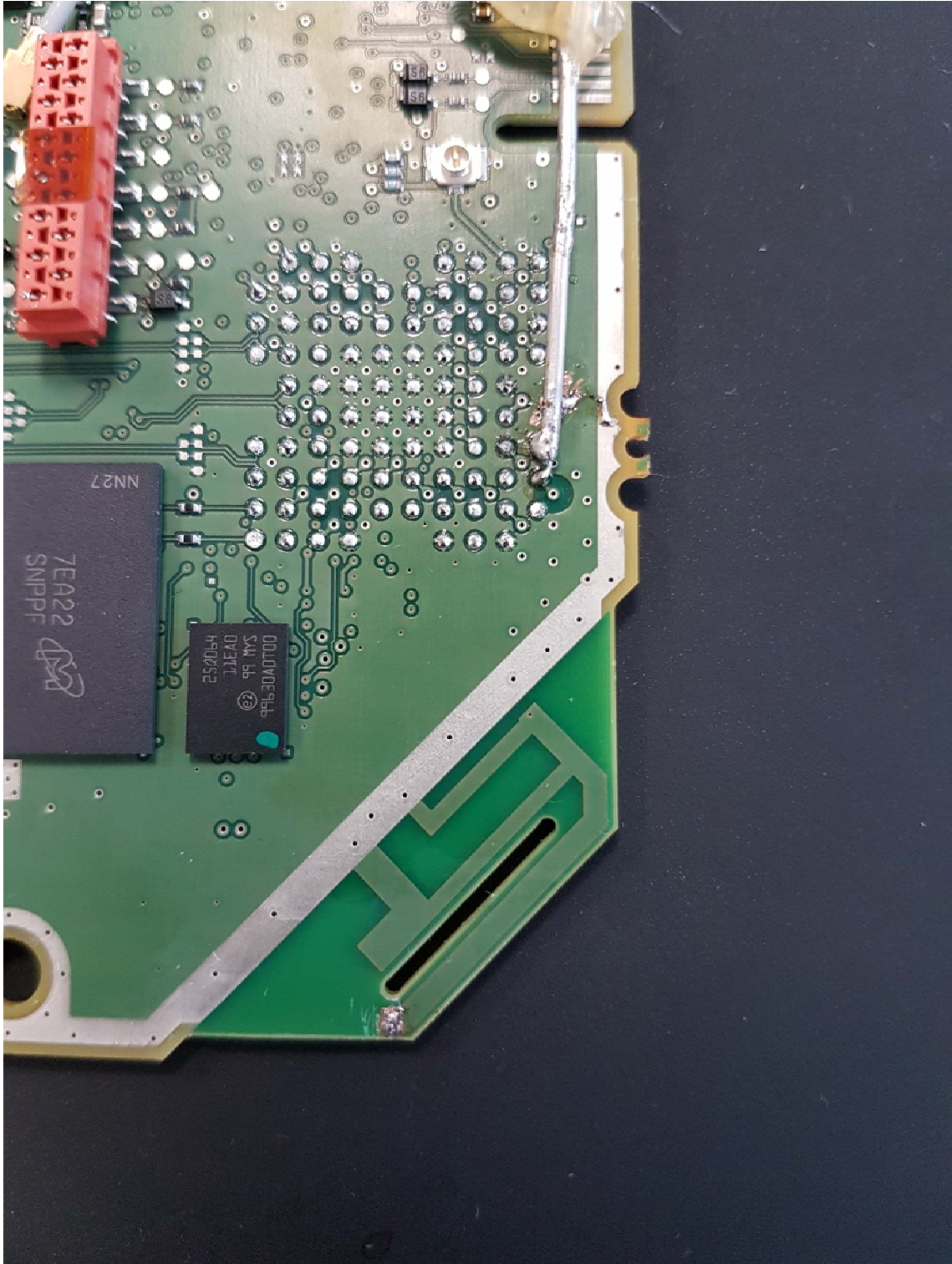

3.4. Setup for radiated measurement

The radiated measurement is made in semi anechoic chamber, is showed in picture below. DUT is fixed on rotation table that rotates around two axes Z (azimuth) and X (elevation). By sweeping azimuth and elevation angles from -90° to 90° and from 90° to 270° respectively it is possible to measure antenna diagram in front half sphere. The test antenna is fixed in mast and can rotate around axis between two fixed angles 0° and 90° . So it is possible to measure antenna diagram for vertical and horizontal polarization. Distance between DUT and test antenna is 3m.

DUT rotation during measurement are explained in 3.5

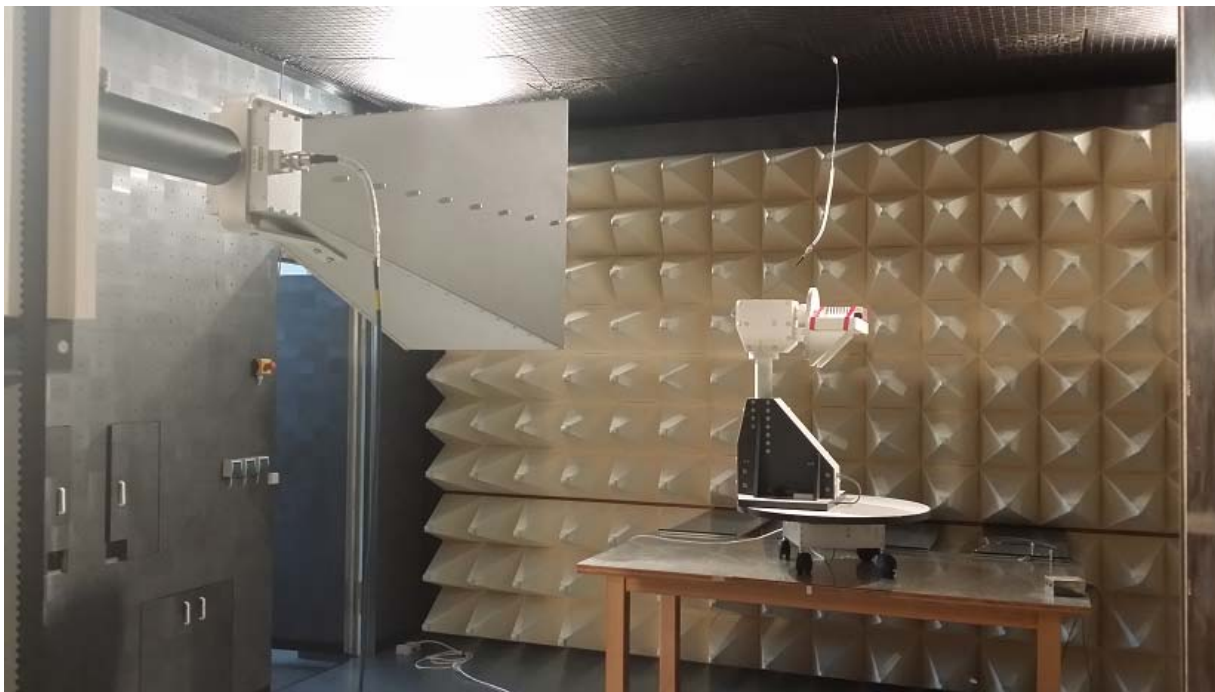

3.5. Explaining of DUT position during measurement

The following pictures were taken during the performance measurement of an another antenna in the past. However the placement of the desired antenna is the same as shown below.

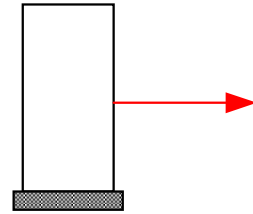
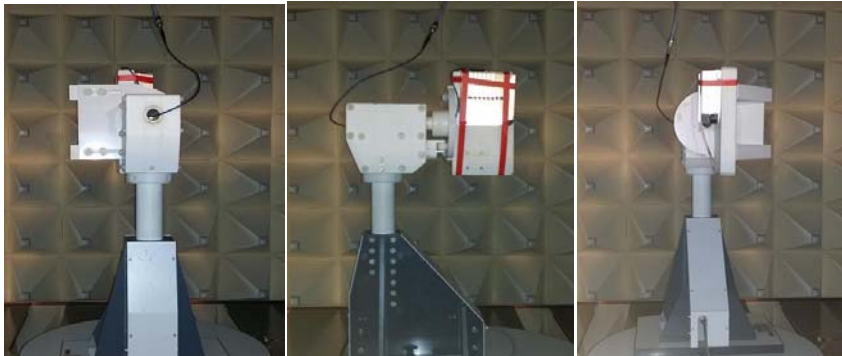

Radiation direction

Fixed elevation angle 270°, Azimuth angle is swept from -90° to 90°
The pictures show position of DUT for -90°, 0° and 90°

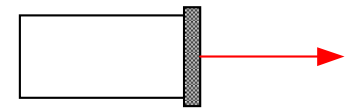

Radiation direction

Fixed elevation angle 180°, Azimuth angle is swept from -90° to 90°
The pictures show position of DUT for -90°, 0° and 90°

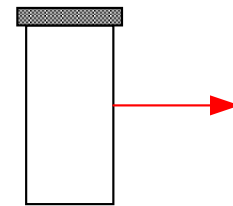
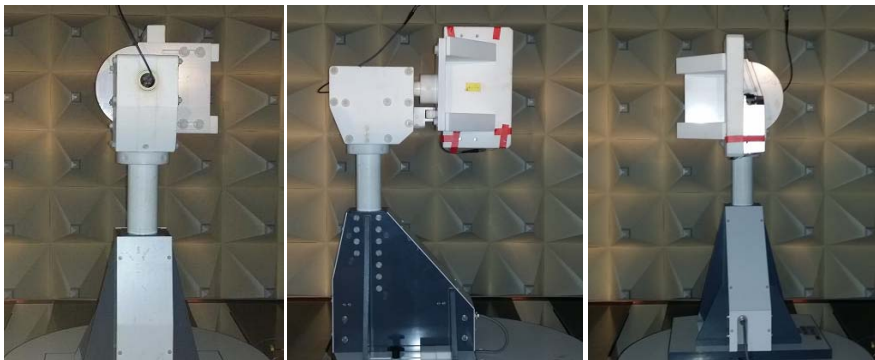

Radiation direction

Fixed elevation angle 90°, Azimuth angle is swept from -90° to 90°
The pictures show position of DUT for -90°, 0° and 90°

3.6. Antenna placement during the measurement

HORIZONTAL:

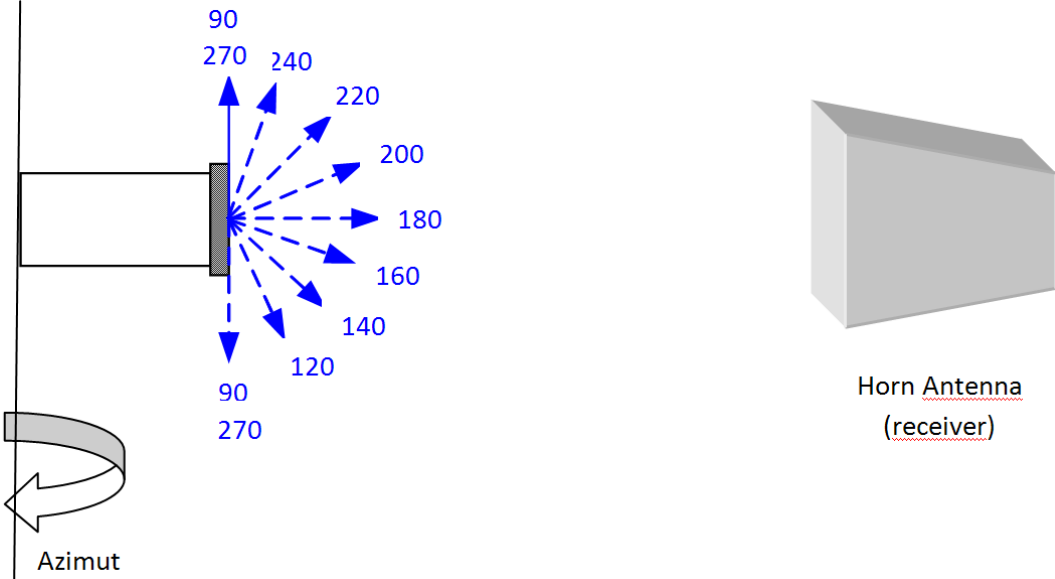

Figure 2: Placement of the desired antenna with respect to the Test Antenna

3.7. Matching of the antenna

The matching of the 2,4 GHz band and 5GHz antenna of both Samples is shown in the following figures (s. Figure 3 and Figure 4).

Original

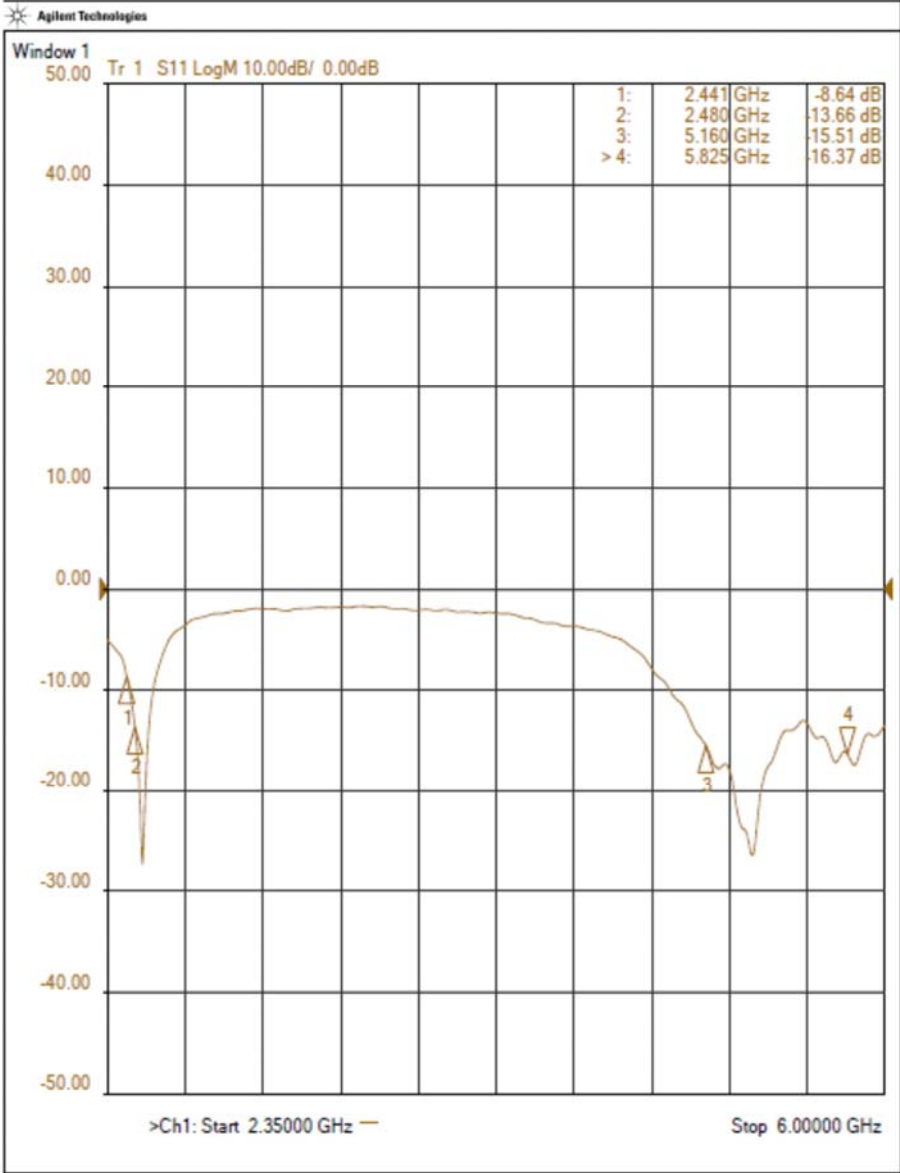
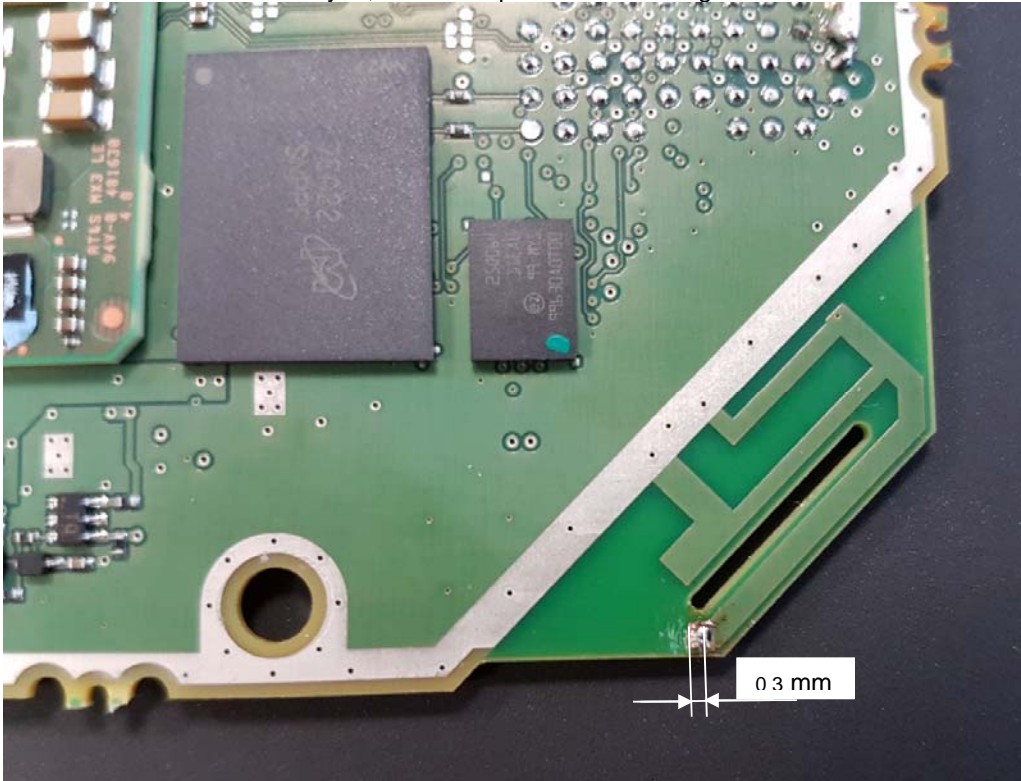

Figure 3: Antenna matching of original antenna in both bands

The matching in 2G4 band doesn't fulfill the customer requirement, because the antenna is too short.

Modification of the antenna

The antenna was extended by 0,3 mm to improve the matching.



Modified antenna

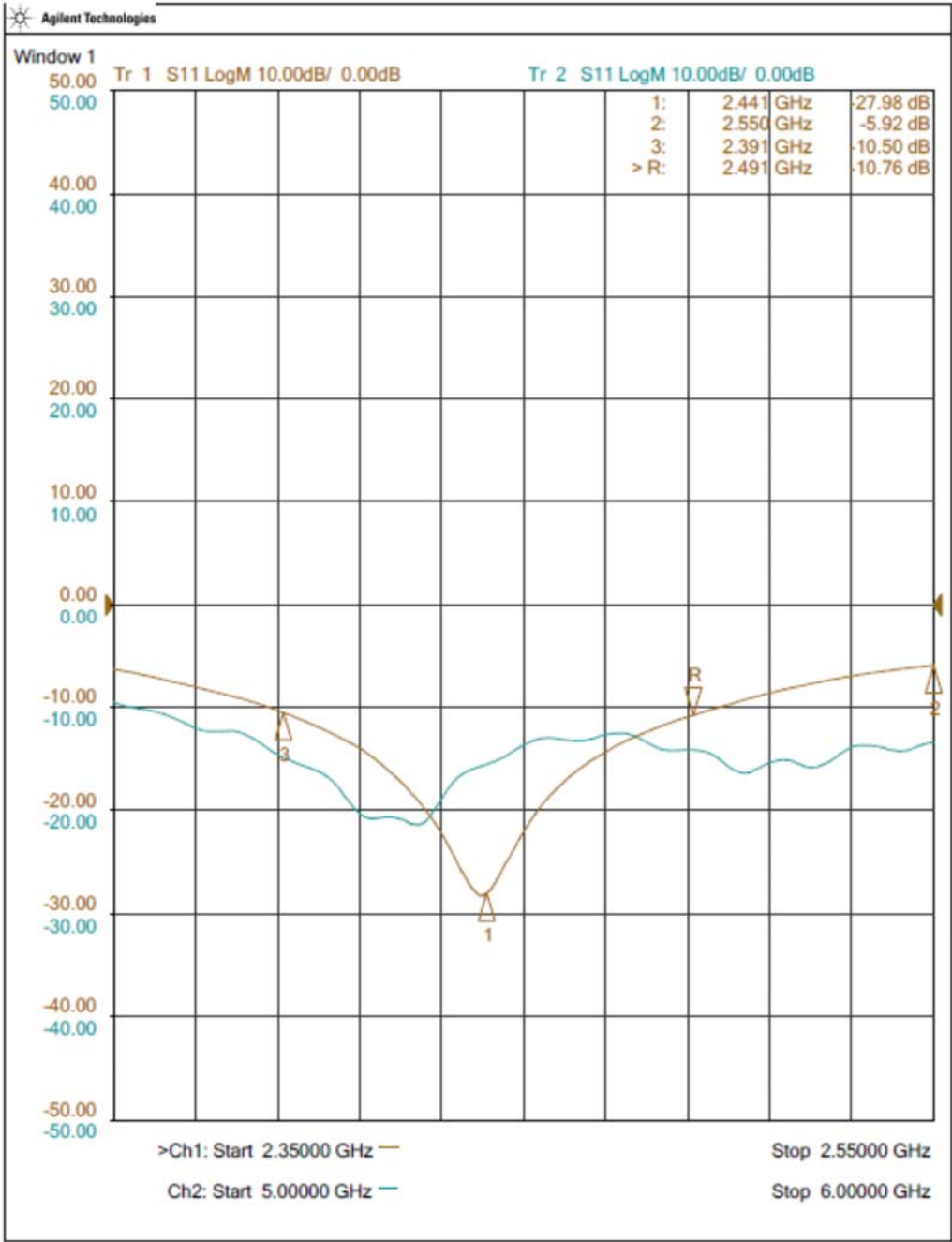
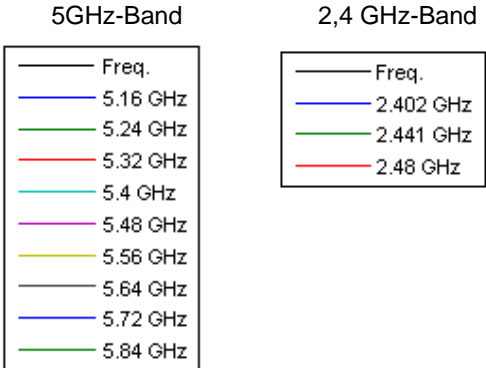

Figure 4: Antenna matching of modified antenna 2 in both bands

3.8. Antenna diagrams

In this section, both WLAN and Bluetooth antennas are represented in 2-D antenna diagrams for various Azimuth/Elevation cut planes for 3m distance between DUT and the test antenna . The free space loss of 3 m distance is about 50 dB in 2,4 GHz Band and about 57 dB in 5GHz Band. The 0 dBi circle in diagram corresponds to the transmitting power of an isotropic radiator in distance of 3m.

The Frequency color in the Diagrams is distributed as followed:



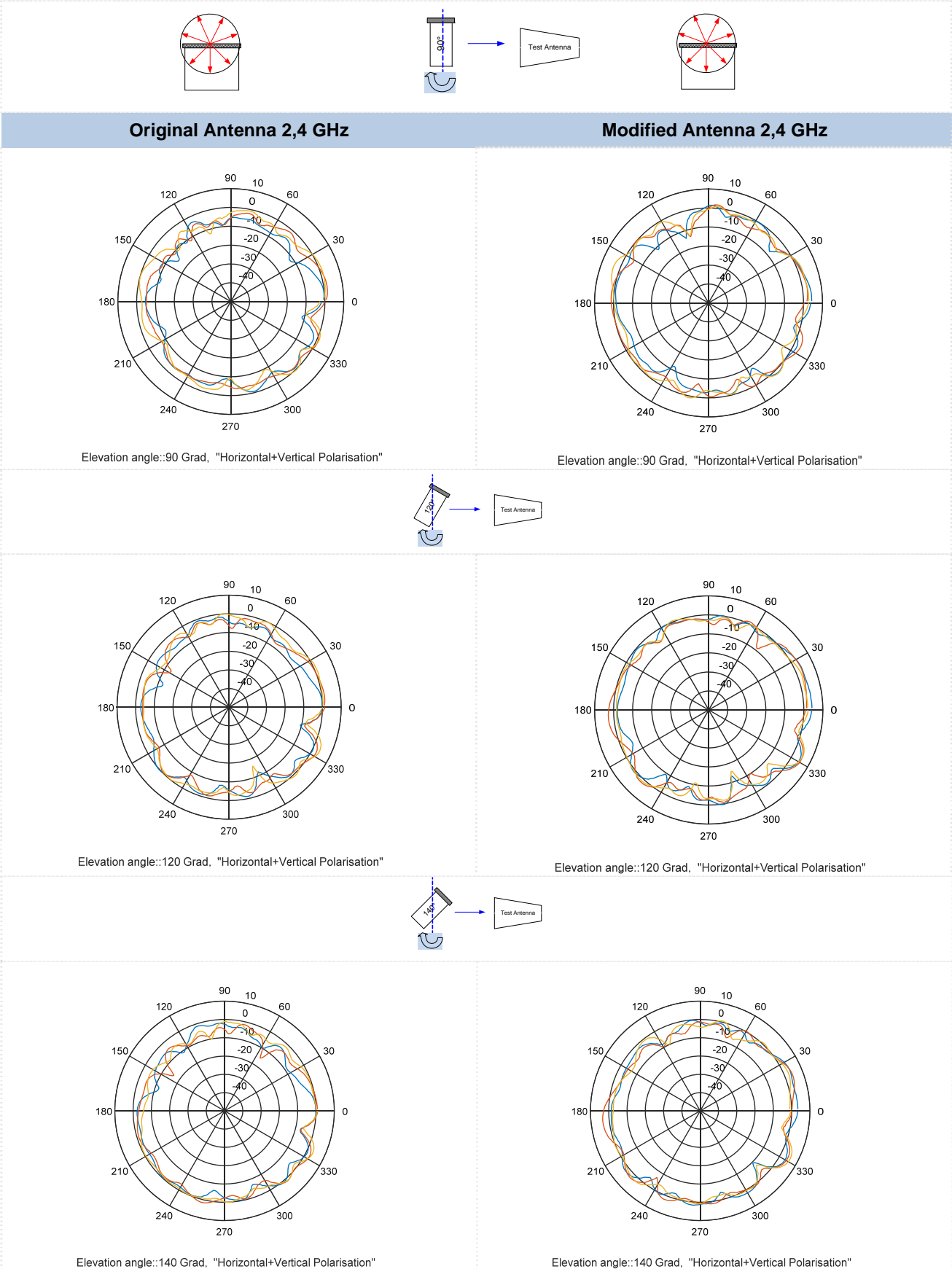

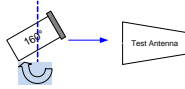

Elevation angle::160 Grad, "Horizontal+Vertical Polarisation"

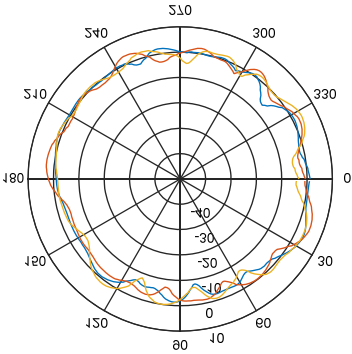
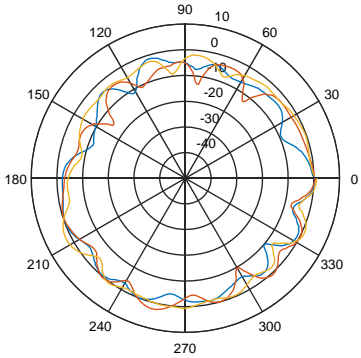

Elevation angle::160 Grad, "Horizontal+Vertical Polarisation"

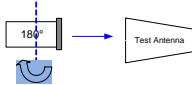

Elevation angle::180 Grad, "Horizontal+Vertical Polarisation"

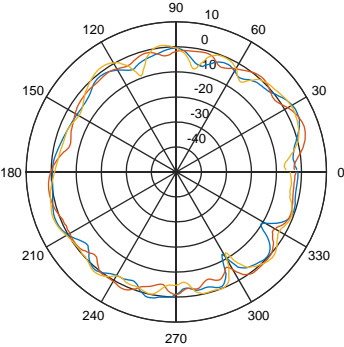
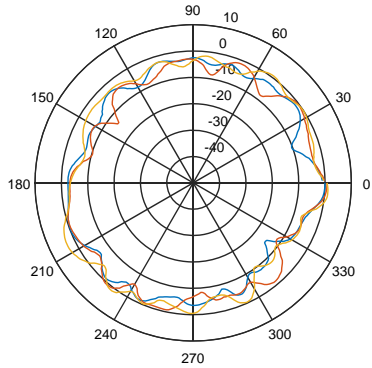

Elevation angle::180 Grad, "Horizontal+Vertical Polarisation"

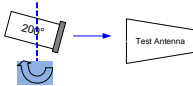

Elevation angle::200 Grad, "Horizontal+Vertical Polarisation"

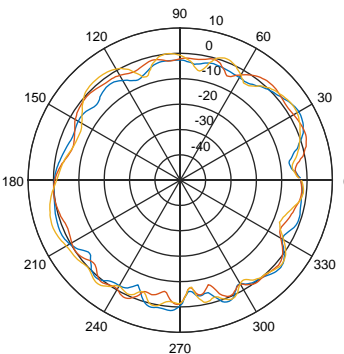
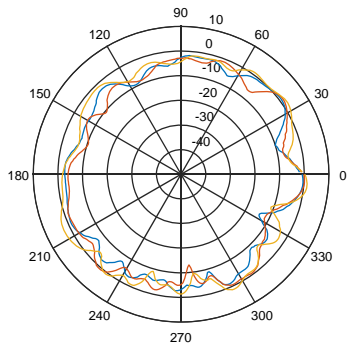

Elevation angle::200 Grad, "Horizontal+Vertical Polarisation"

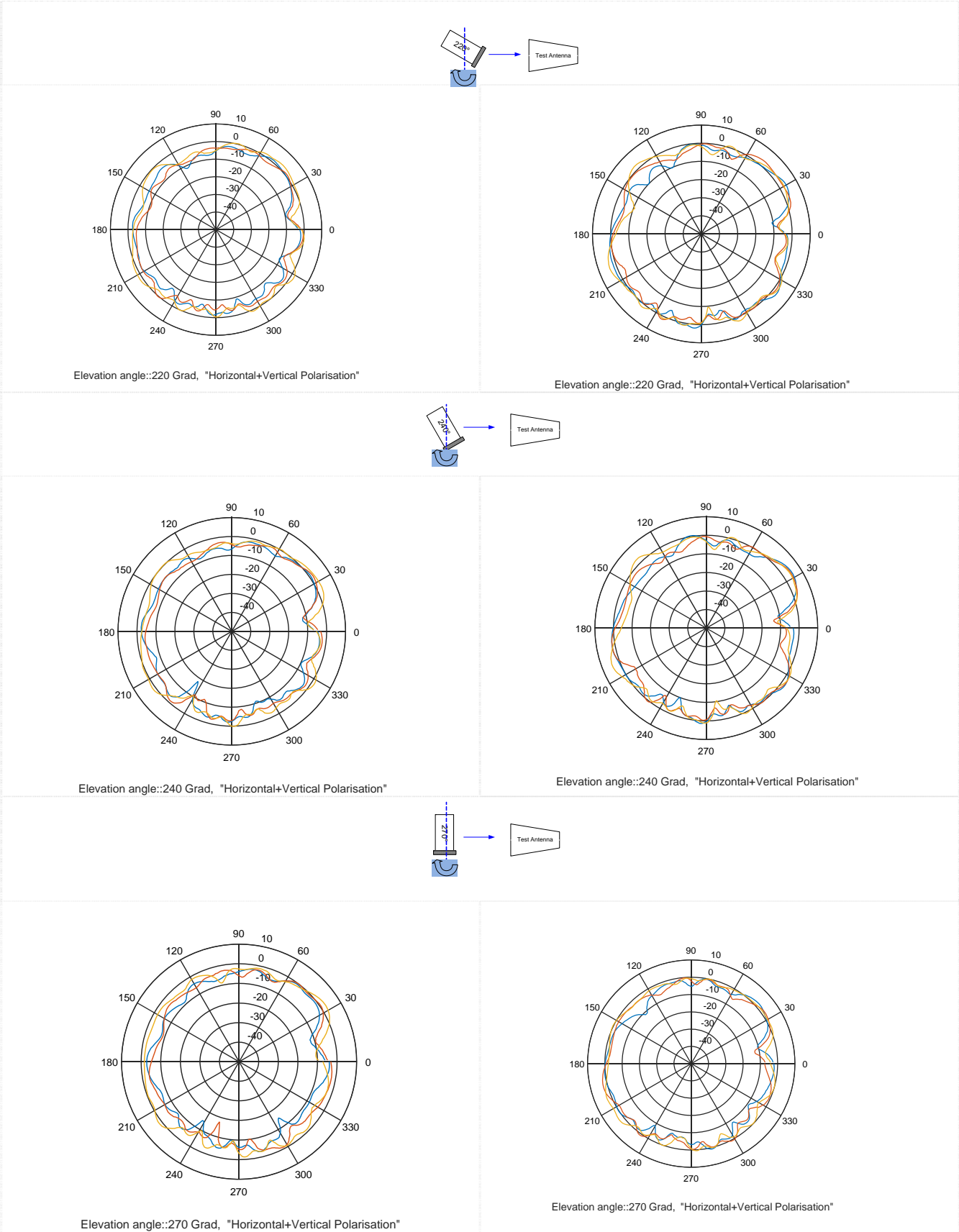

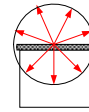
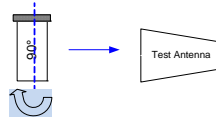
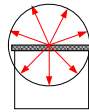

Original Antenna 5 GHz **Modified Antenna 5 GHz**

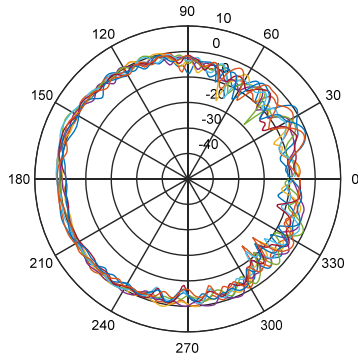

Elevation angle::90 Grad. "Horizontal+Vertical Polarisation"

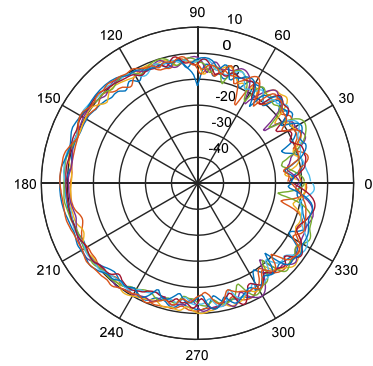

Elevation angle::90 Grad. "Horizontal+Vertical Polarisation"

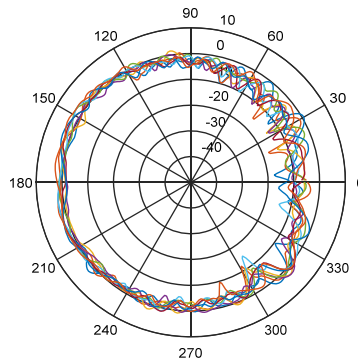
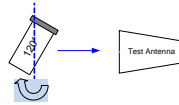

Elevation angle::120 Grad. "Horizontal+Vertical Polarisation"

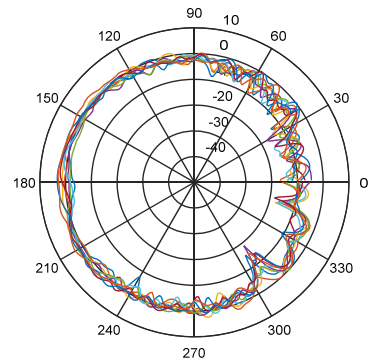

Elevation angle::120 Grad. "Horizontal+Vertical Polarisation"

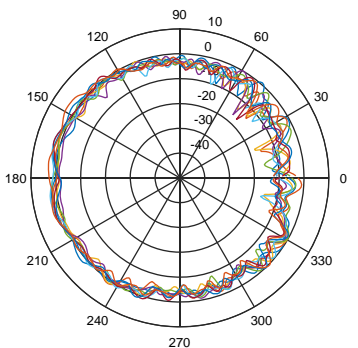
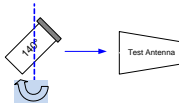

Elevation angle::140 Grad. "Horizontal+Vertical Polarisation"

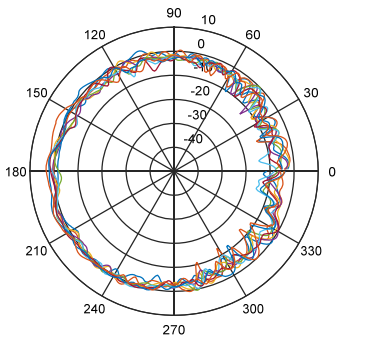

Elevation angle::140 Grad. "Horizontal+Vertical Polarisation"

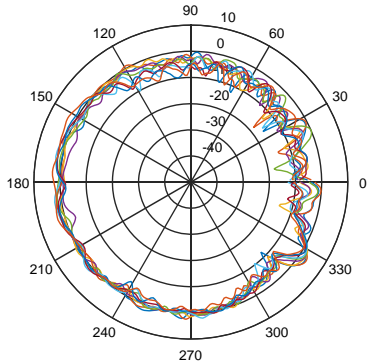
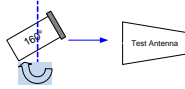

Elevation angle::160 Grad, "Horizontal+Vertical Polarisation"

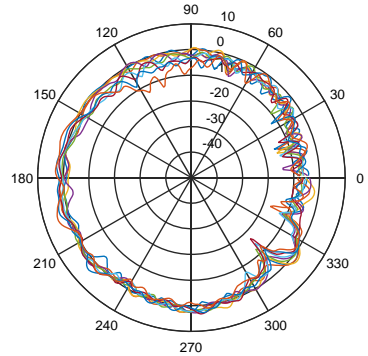

Elevation angle::160 Grad, "Horizontal+Vertical Polarisation"

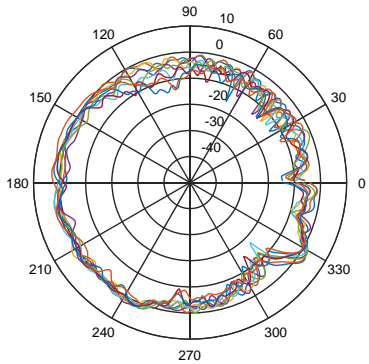
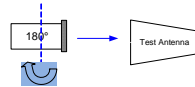

Elevation angle::180 Grad, "Horizontal+Vertical Polarisation"

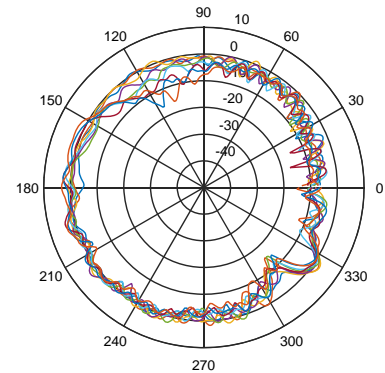

Elevation angle::180 Grad, "Horizontal+Vertical Polarisation"

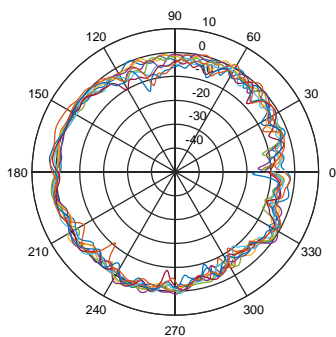
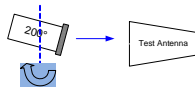

Elevation angle::200 Grad, "Horizontal+Vertical Polarisation"

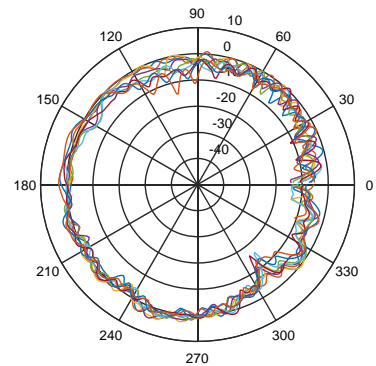

Elevation angle::200 Grad, "Horizontal+Vertical Polarisation"

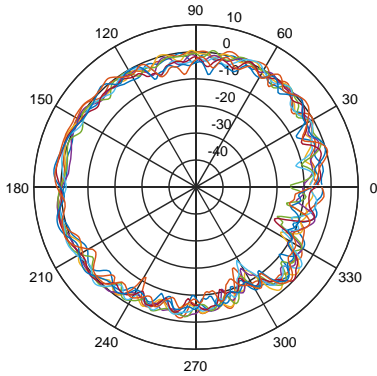
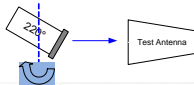

Elevation angle::220 Grad, "Horizontal+Vertical Polarisation"

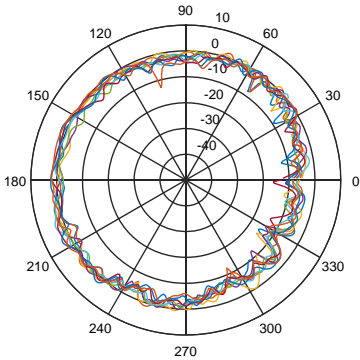

Elevation angle::220 Grad, "Horizontal+Vertical Polarisation"

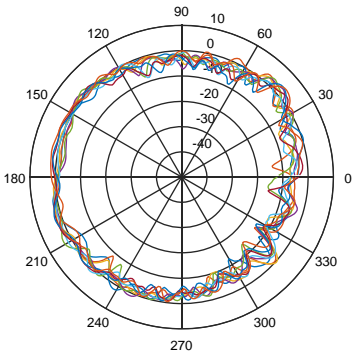
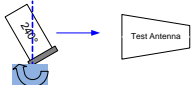

Elevation angle::240 Grad, "Horizontal+Vertical Polarisation"

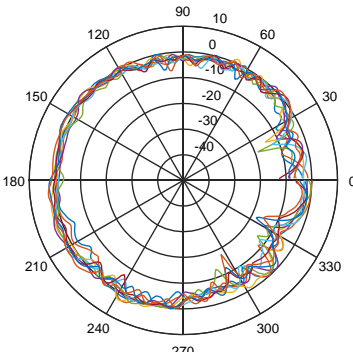

Elevation angle::240 Grad, "Horizontal+Vertical Polarisation"

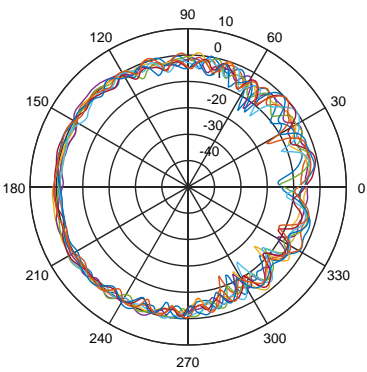

Elevation angle::270 Grad, "Horizontal+Vertical Polarisation"

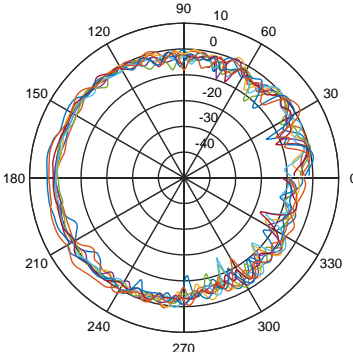

Elevation angle::270 Grad, "Horizontal+Vertical Polarisation"

3.9. Antenna efficiency and gain

Note: The efficiency of antenna is the efficiency of system antenna + feed. It means the reflection loss affects the efficiency of the antenna. Lower reflection loss leads to lower efficiency of the antenna.

Original Antenna

5 GHz band

| Frequency (MHz) | Efficiency (%) | Average Gain (dB) | Max Gain (dBi) |
|-----------------|----------------|-------------------|----------------|
| 5160 | 54 | -2.68 | 4,00 |
| 5240 | 58 | -2.37 | 4,17 |
| 5320 | 56 | -2.52 | 4,02 |
| 5400 | 57 | -2.44 | 3,39 |
| 5480 | 55 | -2.60 | 3,88 |
| 5560 | 53 | -2.76 | 3,67 |
| 5640 | 53 | -2.76 | 3,79 |
| 5720 | 53 | -2.76 | 3,67 |
| 5840 | 57 | -2.44 | 4,00 |

2,4 GHz band

| Frequency (MHz) | Efficiency (%) | Average Gain (dB) | Max Gain (dBi) |
|-----------------|----------------|-------------------|----------------|
| 2402 | 44 | -3.57 | 2,36 |
| 2441 | 51 | -2.92 | 3,23 |
| 2480 | 68 | -1.68 | 5,21 |

Modified Antenna

5 GHz band

| Frequency (MHz) | Efficiency (%) | Average Gain (dB) | Max Gain (dBi) |
|-----------------|----------------|-------------------|----------------|
| 5160 | 54 | -2.67 | 4,15 |
| 5240 | 62 | -2,07 | 4,39 |
| 5320 | 66 | -1.80 | 4,57 |
| 5400 | 60 | -2,22 | 4,03 |
| 5480 | 56 | -2.52 | 3,55 |
| 5560 | 56 | -2.52 | 3,5 |
| 5640 | 57 | -2.44 | 4,07 |
| 5720 | 61 | -2,15 | 4,22 |
| 5840 | 61 | -2,15 | 5,05 |

2,4 GHz band

| Frequency (MHz) | Efficiency (%) | Average Gain (dB) | Max Gain (dBi) |
|-----------------|----------------|-------------------|----------------|
| 2402 | 74 | -1.3 | 5,85 |
| 2441 | 75 | -1.25 | 4,87 |
| 2480 | 81 | -0.92 | 5,98 |

4. Conclusion

The antenna provides a good matching and efficiency in both 2,4 GHz and 5 GHz bands after extension by 0,3 mm.