

TOYOTA SMART CONNECT
OWNER'S MANUAL

TABLE OF CONTENTS

Table of Contents.....	2
1 Basic operation.....	5
1.1 Home screen.....	5
Status icons.....	5
1.2 Basic function.....	7
Home button.....	7
Volume control buttons.....	8
Toggle switch.....	8
Control by touch gestures.....	8
1.3 Steering wheel controls.....	9
Volume up/down button.....	9
Seek next/previous button.....	9
Mode button.....	10
Telephone button.....	10
Voice recognition button.....	10
1.4 Keyboard.....	10
Changing keyboard layout.....	11
Entering accented characters.....	12
2 Settings.....	13
2.1 Devices.....	13
Adding a Bluetooth® device.....	13
Reconnecting to a device.....	15
Removing a device.....	16
Bluetooth profiles.....	17
2.2 Sound settings.....	18
Equalization & sound positioning.....	19
2.3 System settings.....	20
Language settings.....	21
Display settings.....	21
2.4 Wi-Fi®.....	22
Connecting to a Wi-Fi network.....	23
Detailed Wi-Fi settings.....	23
Specification.....	24
2.5 Radio settings.....	24

3	Media	26
3.1	FM / DAB radio.....	26
	Overview	26
	Selecting a radio station	28
	RDS (Radio Data System)	31
3.2	USB	32
	Connecting a device.....	32
	Audio Playback.....	32
	Browsing	33
	Compatible Extensions.....	35
3.3	Bluetooth®.....	35
	Playback	35
	Browsing	36
3.4	Projection.....	36
	Playback	36
	Browsing	37
4	Phone.....	39
4.1	Favourites.....	39
	Adding a contact.....	39
	Placing a call.....	40
	Removing a favourite.....	41
4.2	Recent call list	41
4.3	Contact list.....	42
4.4	Keypad	43
4.5	Receiving calls	44
4.6	During a call	45
4.7	Short message function	47
5	Projection.....	49
5.1	Establishing an Apple CarPlay connection.....	49
5.2	Establishing an Android Auto connection	51
5.3	Reconnecting to wireless Apple CarPlay or Android Auto	53
6	Navigation.....	55
6.1	Map.....	55
6.2	Navigating to a destination.....	55
7	Services	57
7.1	Services home.....	57

7.2	Services details	57
8	Rear view monitor system	59
8.1	Screen description	59
8.2	Rear view monitor precautions	60
	Area displayed on the screen	60
8.3	Camera	61
	Differences between the screen and the road	62
	Approaching three-dimensional objects	64
	Things you should know	66
9	Software updates	69
9.1	Overview	69
9.2	Checking for updates manually	69
9.3	Installing the software update	70
	Downloading the update	70
	Installing the update	72
10	Certification	73
	Radio Equipment Directive – Declaration of Conformity	73
	Bluetooth	76

1 BASIC OPERATION

1.1 HOME SCREEN

When the power switch is turned to ACC or ON, the initial screen will be displayed and the system will begin operating. After a few seconds, the caution screen will be displayed. By selecting "Accept" or after 5 seconds, the HOME screen will be displayed.

The HOME screen provides an overview of the current system status and provides access to various functions.

[HOME_MINIPLAYER]

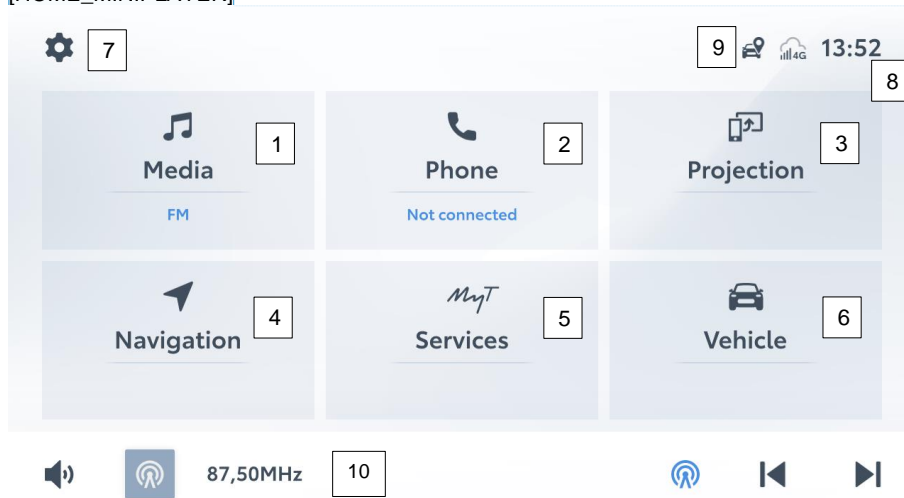

Comentado [DV(1): Annotations to be made

1	Media playback and source selection Current selected media source is shown
2	Phone menu Device currently connected for handsfree telephony is shown
3	Android Auto or Apple CarPlay Device currently connected for Android Auto or Apple CarPlay is shown
4	Navigation
5	MyT Services
6	Vehicle information screens
7	Settings menu
8	Clock ¹
9	Status indicators - refer to section 0
10	Miniplayer showing currently playing media content and controls.

¹: refer to vehicle owner's manual for instruction on how to adjust the clock

STATUS ICONS

[HOME_STATUS_ICON]



1	Privacy mode status
2	Connectivity status
3	Reception level of the connected device
4	Remaining battery charge
5	Clock

NOTE:

The number of status icons that can be displayed differs depending on the displayed screen.

PRIVACY MODE

Privacy mode settings allows to disable any sharing of personal data. Some functions might be unavailable when privacy mode is enabled. Privacy mode setting can be adjusted from the services (see section 7).

Icon	Description
	Privacy mode disabled
	Privacy mode enabled

CONNECTIVITY STATUS

The system requires connectivity to use various functions such as navigation, services and software updates. A dedicated mobile network connection is foreseen. As alternative, Wi-Fi can be used. The connectivity icon indicates current connection status of the system.

Icon	Description
	Wi-Fi® connection established Signal strength is indicated
	Mobile network connection established Signal strength and network type (4G/3G/2G) are indicated
	No connection (system is offline)



PHONE RECEPTION LEVEL

The level of reception may differ from the level displayed on the phone. The level of reception may not be displayed depending on the connected device. "R" is displayed in the icon when the phone is in roaming condition.

Icon	Description
	Excellent reception level
	Poor reception level

REMAINING BATTERY CHARGE

When a phone is connected via Bluetooth®, the remaining battery charge is displayed. The amount displayed may differ from the amount displayed on the connected device. The amount of battery charge left may not be displayed depending on the type of the device connected.

Icon	Description
	Full battery
	Empty battery

1.2 BASIC FUNCTION

Operation of the Multimedia system can be performed using the side buttons ①,②,③, using the touchscreen ④ or the control buttons on the steering wheel.

[DEVICE_HARDKEYS]

Comentado [DV(2): Need new asset for this

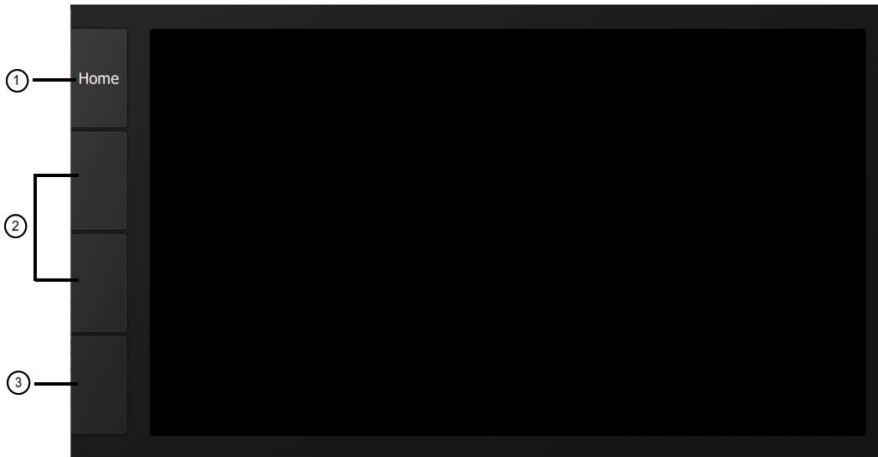

NOTE:

If the Multimedia System is OFF, press any button ①,②,③ or touch the screen ④ to turn ON. The audio is muted after turning ON.

HOME BUTTON

The table below summarizes the ① HOME button functions:

Button action	Action
Short press (< 1.5s)	Go to HOME screen. No action if reverse camera is ON
Long press (at 1.5s)	Turn off display and mute media playback. No action if reverse camera is ON or during active phone call
Long press (at 6 s)	Option to restart the Multimedia System

VOLUME CONTROL BUTTONS

Press the buttons ② +/- to adjust the volume. Refer to the table below for more information:

Button Action	Action
Short Press	Decrease/increase volume of current source* by one-step
Long Press	Decrease/increase volume of current source* continuously until button release or until minimum/maximum volume is reached

*Current source includes:

- Media source (FM / DAB / USB / Bluetooth® and Projection)
- Phone ring
- Phone call
- Navigation announcements
- Voice recognition feedback
- Traffic announcements

TOGGLE SWITCH

Press the button ③  to switch between the current screen and Apple CarPlay/Android Auto.

Button Action	Action
Short Press	If in Apple CarPlay or Android Auto: display previous screen Otherwise: display Apple CarPlay or Android Auto

CONTROL BY TOUCH GESTURES

The following table summarizes the touch gestures that are recognized by the Multimedia System. Permissible touch gestures can vary based on the active screen.

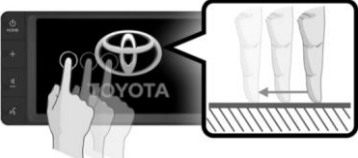
Operation method	Outline	Main use
[DEVICE_TAP] 	Tap Quickly Touch and release once	Selecting an item on the screen
[DEVICE_DRAG] 	Drag Touch the screen with your finger, and move to the desired position	Scrolling through lists Moving the map screen
[DEVICE_FLICK]	Flick Quickly move the screen by flicking with your finger	Scrolling through lists

Comentado [DV(3)]: Asset to be created

Comentado [DV(4)]: Asset to be created

Comentado [DV(5)]: Asset to be created



NOTE:

Do not apply pressure when touching the screen. Screen damage could result if excessive pressure is applied.
 Only use your fingers to touch the screen.
 Wipe off fingerprints using a soft cleaning cloth.
 Using chemical cleaners may damage the screen.

1.3 STEERING WHEEL CONTROLS

The Multimedia System can be controlled by using the following steering wheel buttons:
 [DEVICE_SWC]

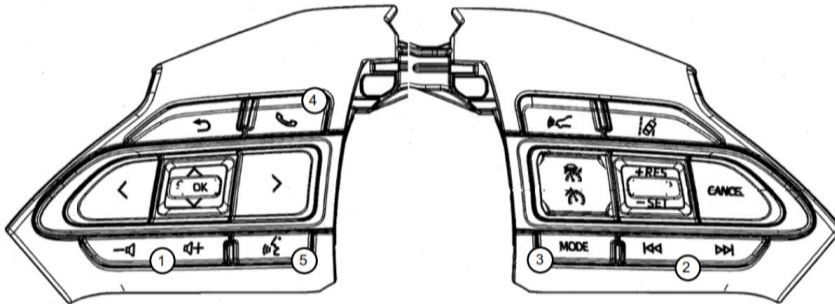

Comentado [DV(6): Need to extract from MM19 manual

NOTE:

If the Multimedia System is OFF, press any steering wheel button to turn it ON. Please note that an audio source will remain muted.

VOLUME UP/DOWN BUTTON

The volume buttons ① can be used to adjust the audio volume level for the Multimedia System. Refer to the table below for more information:

Button Action	Action
Short Press	Decrease/Increase volume of current source by one step
Long Press	Decrease/Increase volume of current source continuously until button release or until minimum/maximum volume is reached

SEEK NEXT/PREVIOUS BUTTON

The seek next/previous buttons ② can be used to change radio stations and active tracks. Refer to the table below for more information:

Button Action	Action
---------------	--------

Short Press	Select next/previous station position for radio Perform seek up/down operation in FM manual tuning mode Select next/previous track while playing USB, Bluetooth® and Projection mode content
Long Press	/

MODE BUTTON

The Mode button ③ allows to cycle through all of the audio modes and control audio playback functions. Refer to the table below for more information.

Button Action	Action
Short Press	Audio sources are cycled in sequence (FM, DAB, Bluetooth®, USB Projection). Inactive sources will be skipped.
Long Press	Mute/Unmute or Pause/Resume audio depending on the current source. When receiving a call: mute/unmute phone ring sound.

TELEPHONE BUTTON

The telephone button ④ allows to accept phone calls or end an active phone call. Refer to the table below for more information:

Button Action	Action
Short Press	When receiving a phone call: accept the call During a phone call: reject the call When viewing a contact or text message: start call to contact
Long Press	/

VOICE RECOGNITION BUTTON

Press the voice recognition button ⑤ for voice commands. A device supporting this feature needs to be connected for Bluetooth, Apple CarPlay or Android Auto. Refer to the table below for more information:

Button Action	Action
Short Press	Start or stop voice recognition session
Long Press	If no phone is connected, make system visible to pair from the phone

1.4 KEYBOARD

The keyboard can be used to enter data or perform a search operation.

[KEYBOARD]

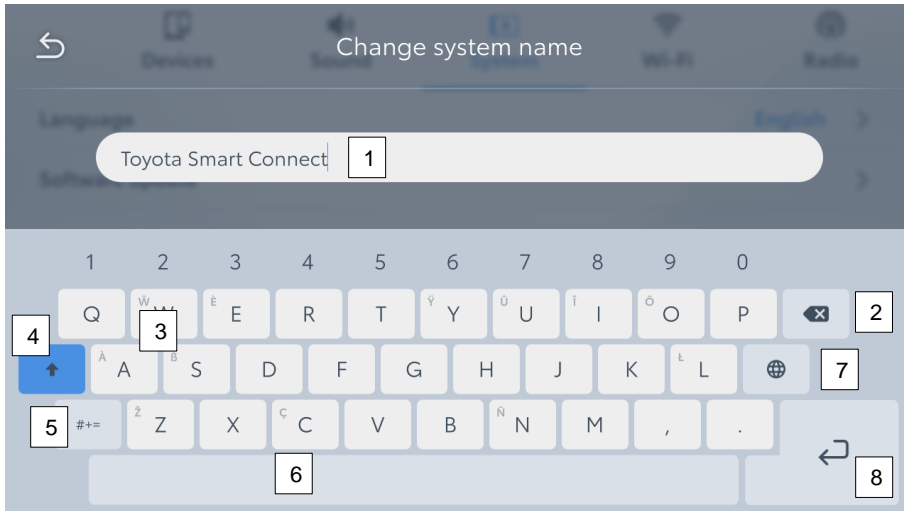

1	Text field. Entered character(s) will be displayed
2	Erase one character. Select and hold to continue erasing characters
3	Enter desired characters
4	Enter characters in lower case or in upper case.
5	Switch to special character keyboard
6	Make a space on cursor
7	Change keyboard layout
8	Enter / search

CHANGING KEYBOARD LAYOUT

1. Press .
2. Select the desired keyboard layout.

[KEYBOARD_LAYOUT]

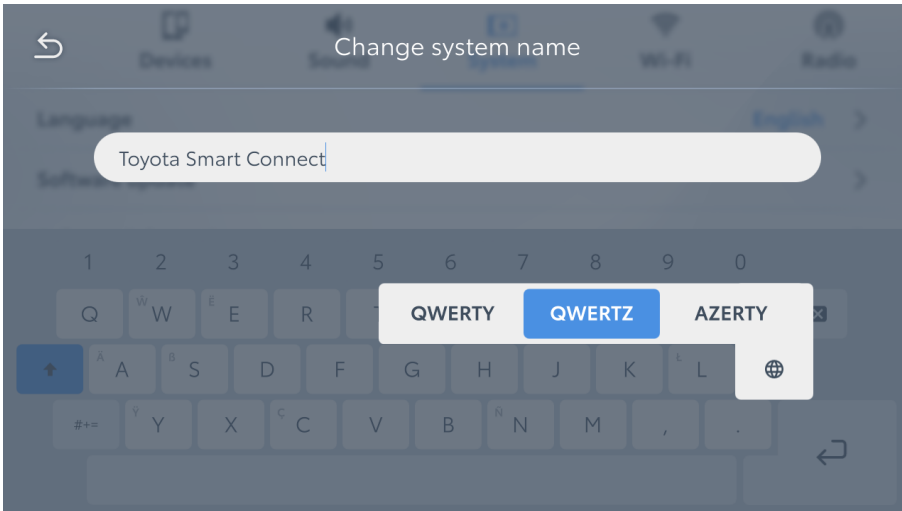

NOTE:

Depending on the current screen, some keyboard layouts may not be available

ENTERING ACCENTED CHARACTERS

To enter a accented character, use the following steps.

- 1) Long press on a particular key which contains an accented character in the top right corner. The list of available accented characters will appear.
- 2) Select the desired accented character to enter it into the input field.

KEYBOARD_ACCENT

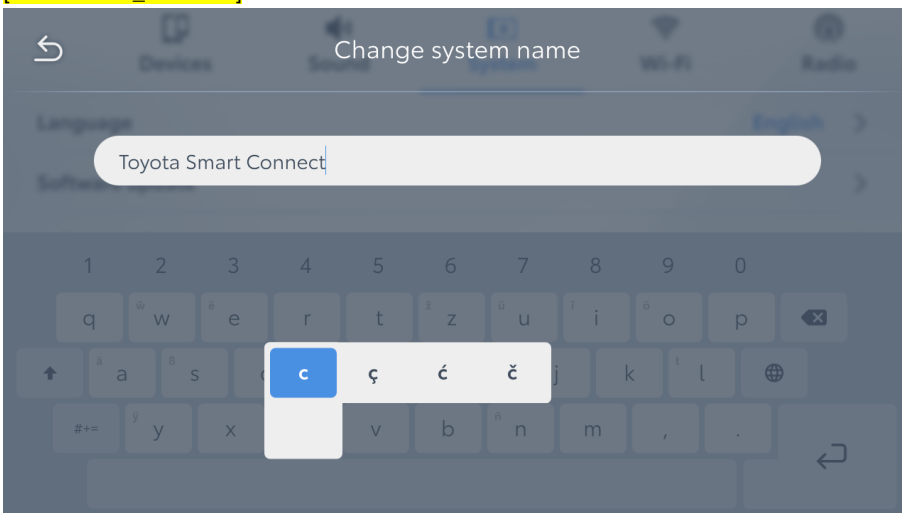

2 SETTINGS

Touch the  icon on the HOME screen to display the settings selection screen. In this menu, you can access following functions:

- Devices
- Sound settings
- System settings
- Wi-Fi settings
- Radio settings

2.1 DEVICES

Device settings provides access to settings for Bluetooth® and Apple CarPlay/Android Auto capable devices.

Touch the  icon on the HOME screen to display the settings selection screen and touch the "Devices" tab to access device settings.

NOTE:

To use the hands-free system, it is necessary to register a Bluetooth® phone with the system. Once the phone has been registered, it is possible to use the hands-free system. When an Apple CarPlay connection is established, Bluetooth® handsfree functions will become unavailable and any connected Bluetooth® handsfree devices will be disconnected. When connecting to Android Auto, a Bluetooth® connection will be made automatically.

ADDING A BLUETOOTH® DEVICE

To pair a compatible Bluetooth® device from the "Devices" tab, follow the steps below:

1. Enable Bluetooth, if required.

BLUETOOTH

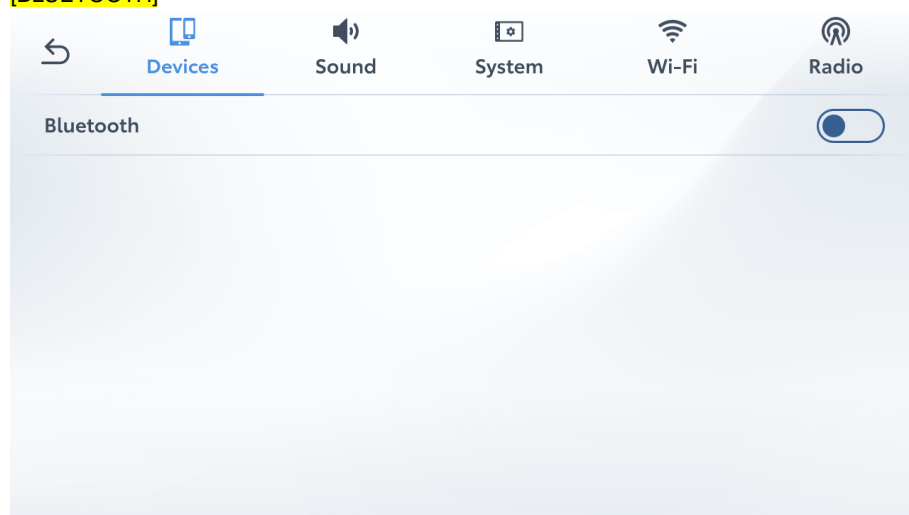

2. Touch "Scan" to start searching for devices that can be paired. Ensure the device to be paired is set as visible. The system searches for Bluetooth® devices for a maximum of 25 seconds.
3. In the list of Bluetooth® devices select the device you want to pair.

[BLUETOOTH_AVAILABLE_DEVICES]

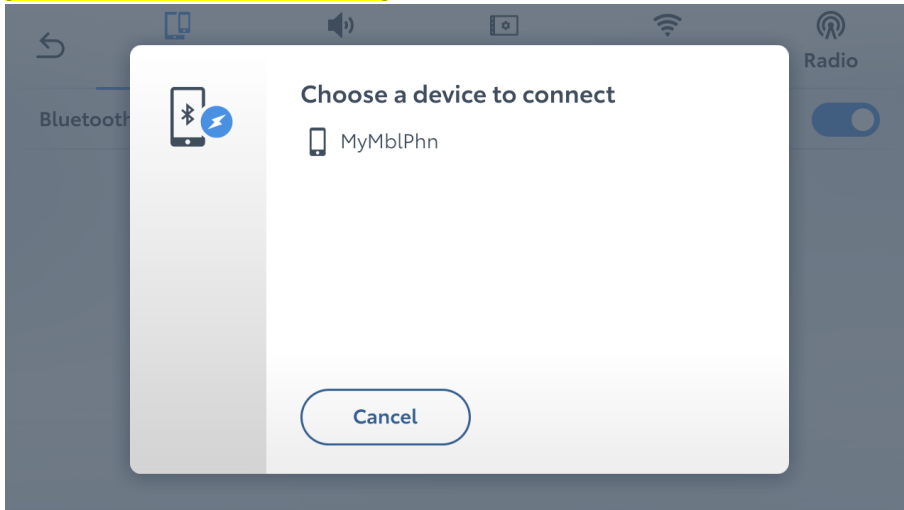

4. Touch "Pair" to begin the pairing process. Once this is completed, the device will connect for "Phone" and "Media", if supported.
5. If the device supports Apple CarPlay or Android Auto via wireless connection, the system will automatically ask to connect.

[BLUETOOTH_PROJECTION_POPUP]

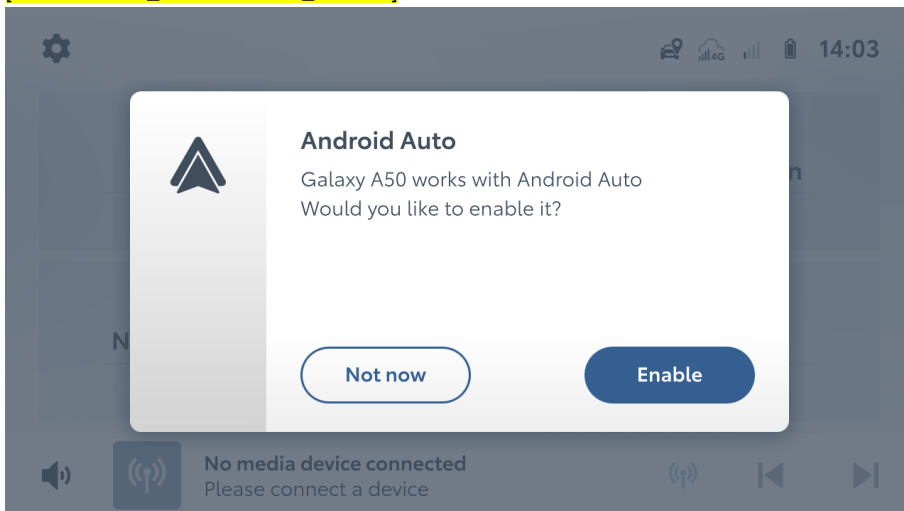

NOTE

A maximum of 12 devices can be paired.

RECONNECTING TO A DEVICE

AUTO-RECONNECTION AT START-UP

After start-up, the system shall automatically attempt to reconnect to the previously connected device. In case this device is not available, the system shall try to reconnect to the other devices in the device list.

RECONNECTING TO A DEVICE MANUALLY

To reconnect to a device manually, from the “Devices” settings, select a device from the device list.

[BLUETOOTH_RECONNECT]

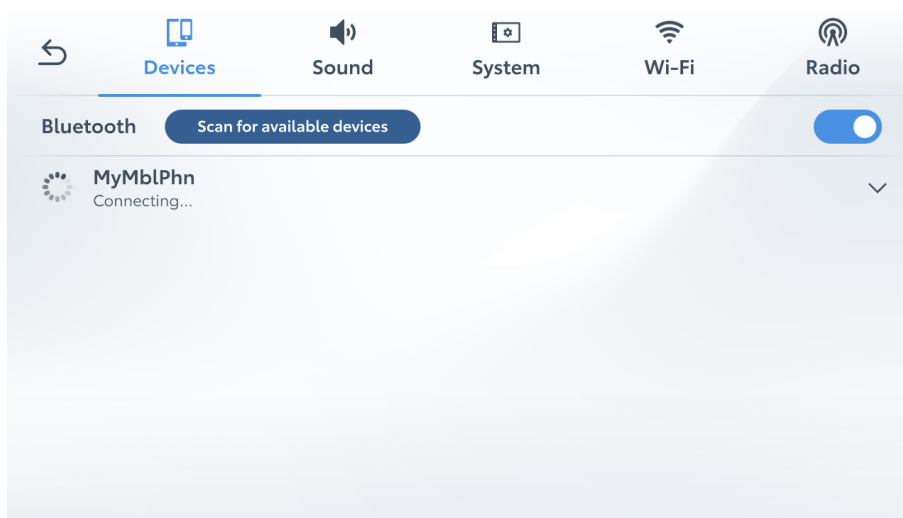

The system will attempt to connect the device for all available functions.

CONNECTING/DISCONNECTING A SPECIFIC FUNCTION

To reconnect to a device manually, from the “Devices” tab and follow next steps:

1. Press the ∨ icon on the desired device to expand the device settings.

[BLUETOOTH_RECONNECT_FUNCTION]

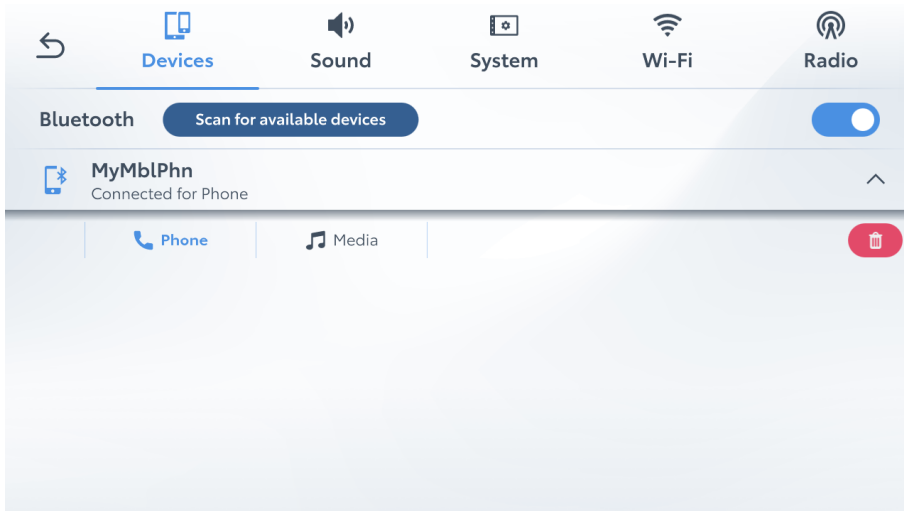

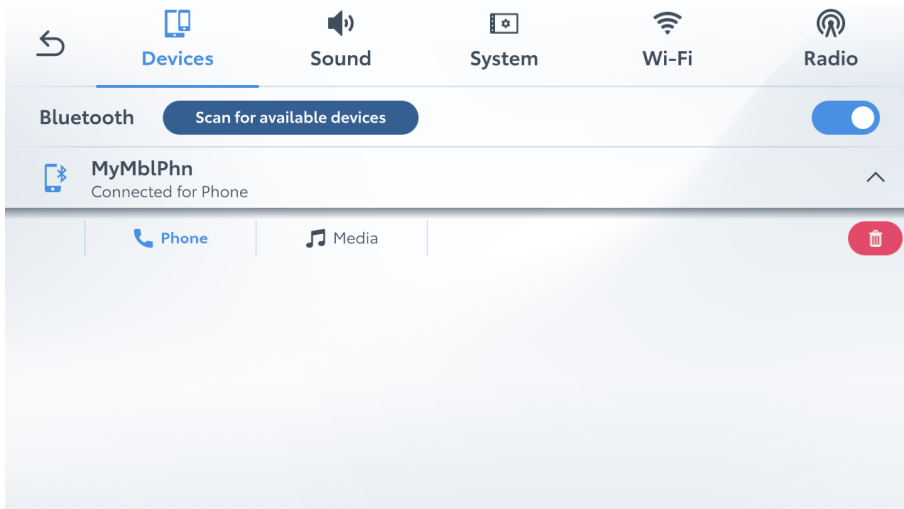

2. Select the desired function to connect.

[BLUETOOTH_RECONNECT_FUNCTION_ALL]



REMOVING A DEVICE

This operation cannot be performed while driving. To remove a device from device list, follow the following steps:

1. Go to "Devices" settings.
2. Press the  icon on the desired device to expand the device settings.
3. Select  icon to remove it from the memorized list.

[BLUETOOTH_REMOVE]

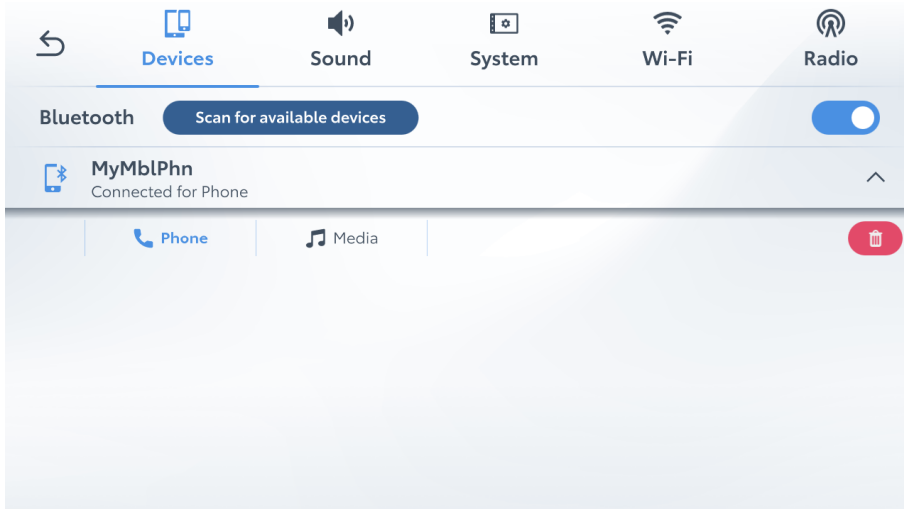

4. Select "Confirm" to delete the device.

[BLUETOOTH_REMOVE_POPUP]

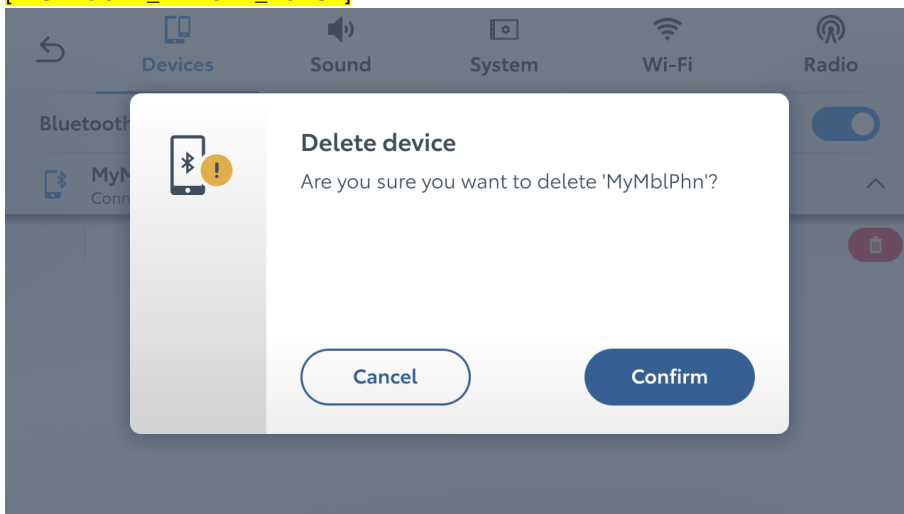

5. The device will be disconnected and deleted from the list.

NOTE

When deleting a Bluetooth® phone, the contact list, call history & stored favourites will be deleted from the system's memory.

BLUETOOTH PROFILES

This system supports the following services.

- Bluetooth® core specification: recommended Ver. 5.2
- HFP (Hands Free Profile): recommended Ver. 1.7

- This is a profile to allow hands-free phone calls using a cellular phone. It has outgoing and incoming call functions.
- PBAP (Phone Book Access Profile): recommended Ver. 1.2
 - This is a profile to transfer phonebook data.
- MAP (Message Access Profile): recommended Ver.1.4
 - This is a profile to use phone message functions.
- A2DP (Advanced Audio Distribution Profile): recommended Ver. 1.6
 - This is a profile to transmit stereo audio or high quality sound to the audio/visual system.
- AVRCP (Audio/Video Remote Control Profile): recommended Ver. 1.6
 - This is a profile to allow remote control the A/V equipment.
- DID (Device ID 1.3): recommended Ver 1.3
- SPP (Serial Port Profile): recommended Ver 1.2
 - These profile is used for other functions such as Apple CarPlay/Android Auto

NOTE

- This system is not guaranteed to operate with all Bluetooth® devices.
- If your cellular phone does not support HFP, registering the Bluetooth® phone or using PBAP or MAP profiles individually will not be possible.
- If the connected Bluetooth® device version is older than recommended or incompatible, the Bluetooth® device function may not work properly.

2.2 SOUND SETTINGS

Touch the  icon on the HOME screen and touch the tab "Sound" to access sound settings.

SETTINGS_SOUND

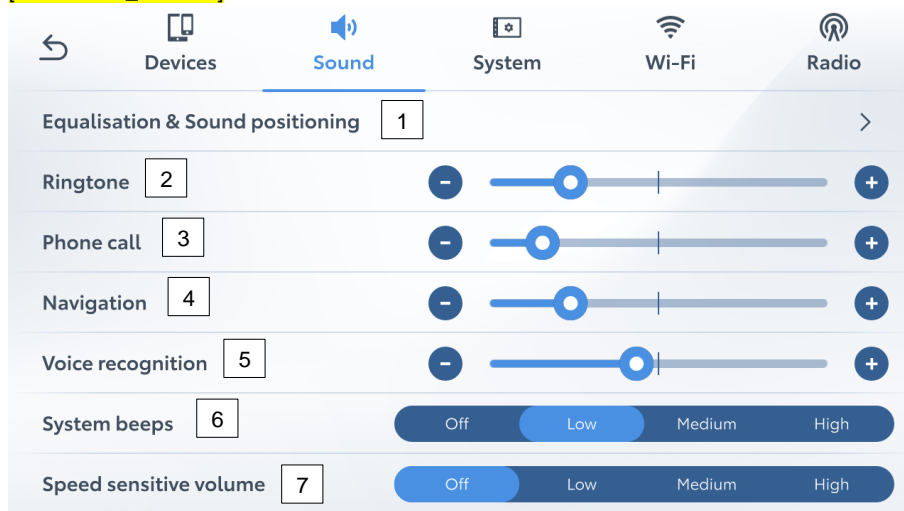

1	Access advanced equalization settings
2	Adjust the volume of incoming phone call ringtone

3	Adjust the volume of phone calls
4	Adjust the volume of navigation announcements
5	Adjust the volume of voice recognition feedback
6	Adjust settings for system beeps ¹
7	Adjust settings for speed sensitive ² volume

¹: Low / Medium / High setting not available for JBL speaker systems.

²: This system adjusts to the optimum volume and tone quality according to vehicle speed to compensate for increased road noise, wind noise or other noises while driving.

EQUALIZATION & SOUND POSITIONING

FOR VEHICLES WITH STANDARD SPEAKER SYSTEM:

[SETTINGS_SOUND_EQ_INT]

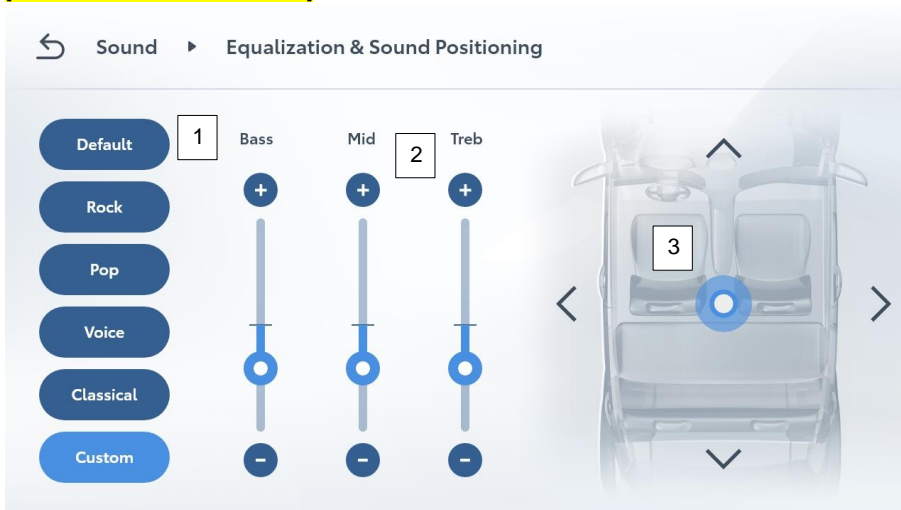



1	Select one of the equalization presets (Rock, pop, voice or classical) by touching the icon or apply custom equalization using the Custom preset option
2	Select custom equalizations for Bass, Mid and Treble by dragging the slider up and down
3	Touch and drag the ● icon to adjust the sound balance towards the front, rear, left or right ¹

¹: Front/rear setting is not be available for some speaker systems.

FOR VEHICLES EQUIPPED WITH JBL SOUND SYSTEM:

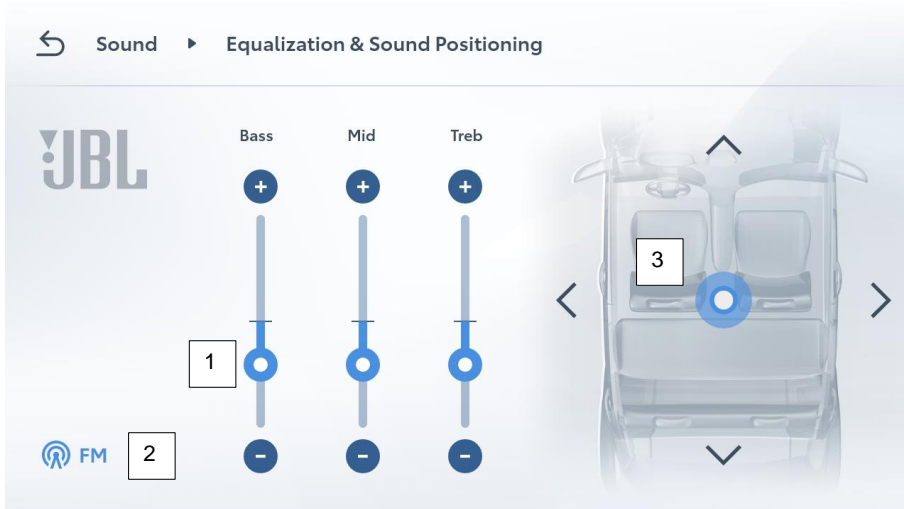
[SETTINGS_SOUND_EQ_JBL]



1	Touch the  icon to adjust Bass, Mid and Treble by dragging the slider up and down
2	Indicates the media source currently selected. Separate equalizer settings can be set for different media sources
3	Touch and drag the  icon to adjust the sound balance towards the front, rear, left or right

2.3 SYSTEM SETTINGS

Touch the  icon on the HOME screen and touch "System" tab to access system settings.

SETTINGS_SYSTEM

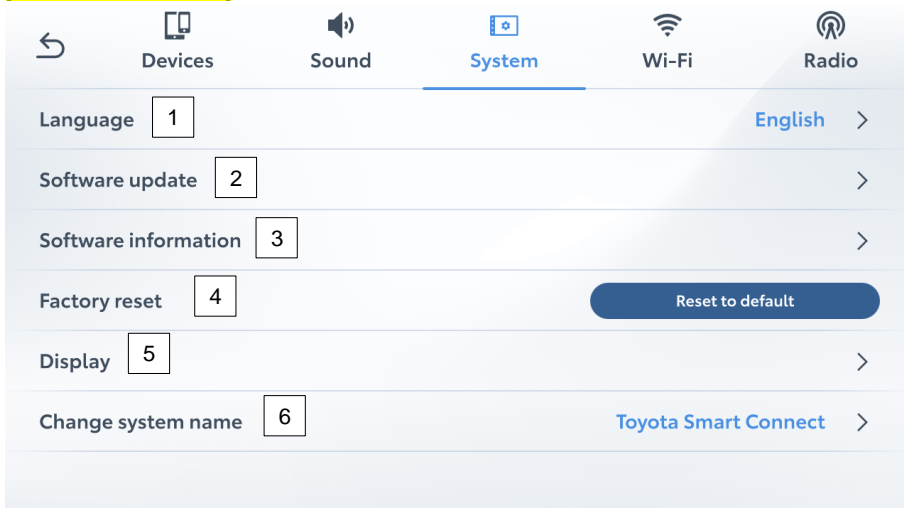

1	Go to language settings
2	Manage software updates (refer to section 9)
3	Access software information of the multimedia system
4	Press "Reset to default" to change all settings to factory default settings. This action will delete all user information, settings, paired devices and tuner favourites. The system will restart to complete the reset.
5	Go to display settings
6	Change the system name for Bluetooth®

LANGUAGE SETTINGS

Language settings can be used to select the current system language.

The selected language will take effect immediately and all screens will be adjusted to the newly selected language.

The following languages are supported by the Multimedia System:

Czech	Finnish	Hungarian	Portuguese	Spanish
Danish	French	Italian	Romanian	Swedish
Dutch	German	Norwegian	Russian	Turkish
English	Greek	Polish	Slovak	Ukrainian

DISPLAY SETTINGS



Display settings can be used to adjust the following items:

- Display brightness
- Theme

The system will detect day/night mode based on instrument panel illumination state and light sensor input.

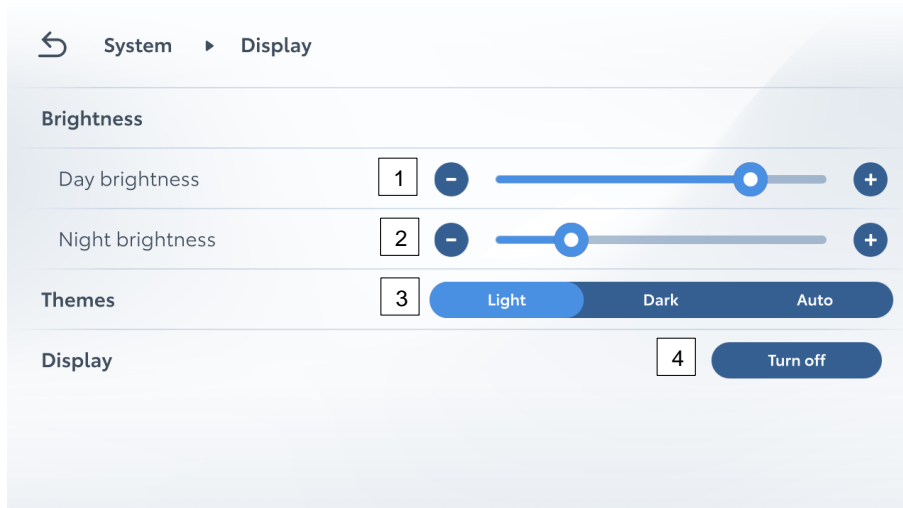
SETTINGS_SYSTEM_DISPLAY



1	Touch +/- or drag  icon to adjust display brightness in day mode ¹
2	Touch +/- or drag  icon to adjust display brightness in night mode ¹
3	Select "Light/Dark/Auto" mode for the theme. In "Auto" setting, Light/Dark is selected automatically based on day/night mode
4	Turn off the display. Touch the screen or any hard key to turn on again

¹: Setting might not apply immediately if system is currently in different mode

2.4 WI-FI®

Touch the  icon on the HOME screen to display the settings selection screen and touch the Wi-Fi® tab to access Wi-Fi® settings.

Wi-Fi® can be used to connect the system to a wireless network. If connected, all features requiring connectivity will use Wi-Fi® instead of built-in mobile network connectivity.

When Wi-Fi® is turned on, the system will automatically try to reconnect to the last connected network.

NOTE:

When Wi-Fi® is turned on, wireless projection (Android Auto & Apple CarPlay) cannot be used.

SETTINGS_WIFI

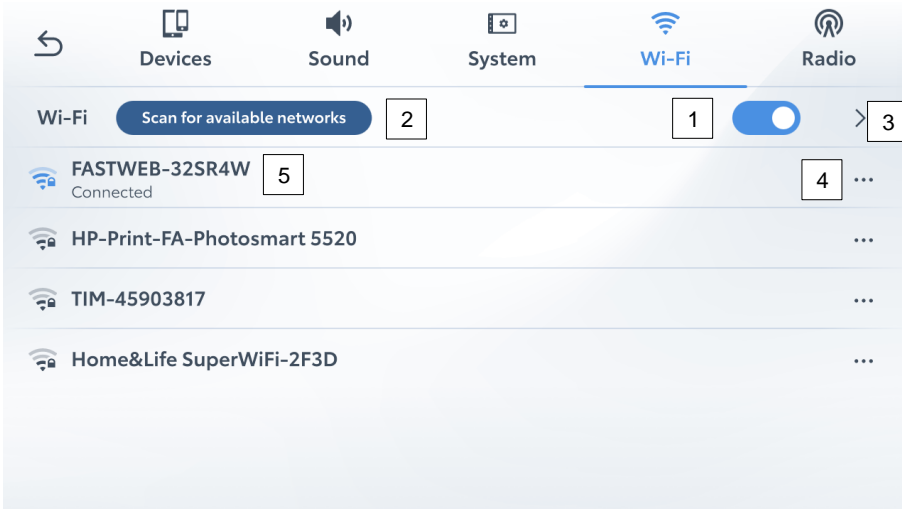

1	Enable/disable Wi-Fi® functionality
2	Scan for Wi-Fi® networks
3	Advanced Wi-Fi® settings
4	Provides information about the network (security type, IP address). Forget/Connect/Disconnect selected Wi-Fi® network
5	List of available Wi-Fi® networks.

CONNECTING TO A WI-FI NETWORK

In case of first time connection to a secured network, you will be required to enter the password.

Press the desired Wi-Fi® network and enter the password. The following screen will be displayed.

[SETTINGS_WIFI_PWD]

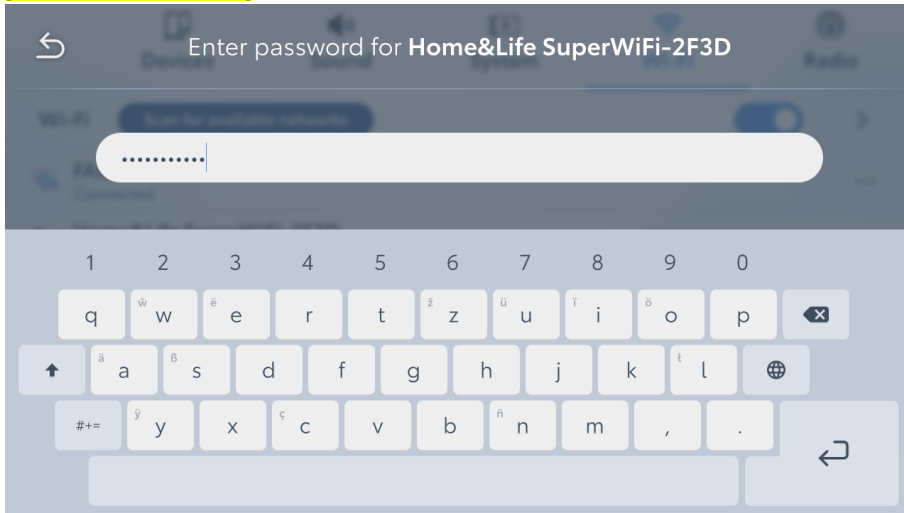

DETAILED WI-FI SETTINGS

To enter detailed Wi-Fi® settings, press > in Wi-Fi® settings screen.

[SETTINGS_WIFI_ADVANCED]

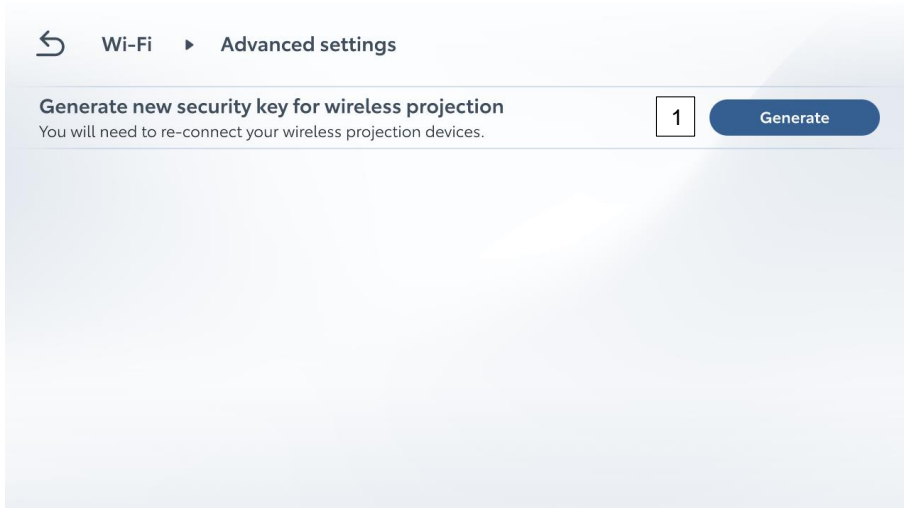

1 | Generate new security key for wireless Android Auto/Apple CarPlay. This will

disconnect any connected wireless projection device.

SPECIFICATION

Communication standards:

- 2.4 GHz Spectrum Capabilities
- 5 GHz Spectrum Capabilities
- Wi-Fi CERTIFIED™ a
- Wi-Fi CERTIFIED™ ac
- Wi-Fi CERTIFIED™ b
- Wi-Fi CERTIFIED™ g
- Wi-Fi CERTIFIED™ n

Security:

- Protected Management Frames
- WPA2™-Personal
- WPA3™-Personal
- WPA™-Personal (for station mode only)

2.5 RADIO SETTINGS

Touch the  icon on the HOME screen to display the settings selection screen and touch the "Radio" tab to access FM / DAB settings.

SETTINGS_RADIO

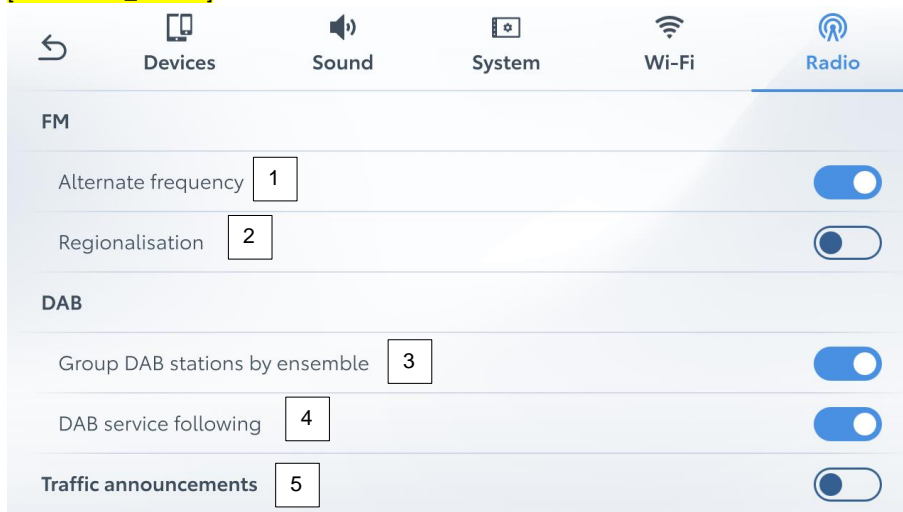

1	Enable / disable the FM alternative frequency function
2	Enable / disable switching to a broadcasting station within the same local program network (only available when alternate frequency is enabled)
3	Set the order of DAB station list by "ensemble" or "alphabetically sorted"
4	Enable / disable DAB-FM and DAB-DAB service linking
5	Enable / disable traffic announcements in both FM and DAB

To learn more about these settings, refer to section 3.1.

3 MEDIA

Touch the "MEDIA" button on the HOME screen to display the currently playing media content and change between media sources:

- FM
- DAB
- USB
- Bluetooth®
- Projection: Apple CarPlay or Android Auto

You can also touch the miniplayer from HOME screen to display media content.

[HOME_MINIPLAYER_2]

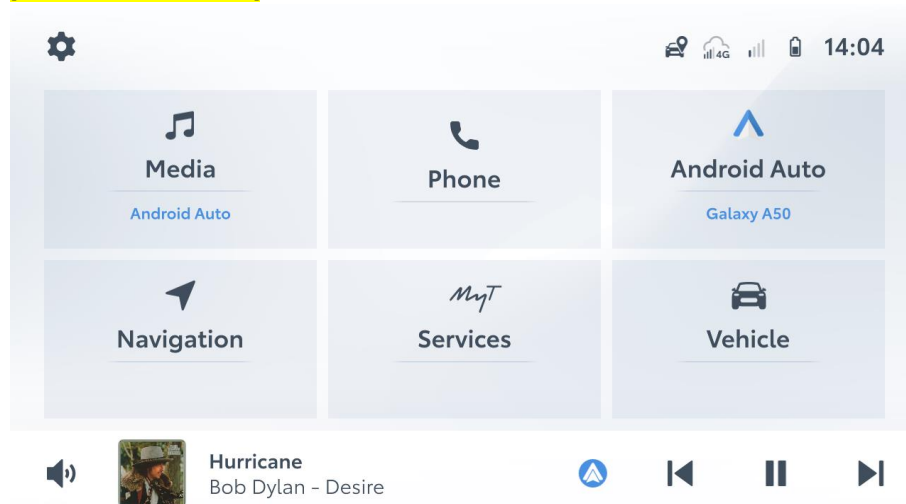

3.1 FM / DAB RADIO

Touch the "MEDIA" button on the HOME screen to access FM / DAB radio by selecting one of the two tabs.

OVERVIEW

FM:

[MEDIA_FM]



1	Tuned station or frequency
2	Enable/disable manual tuning control
3	Radio station text
4	Favourites tab
5	Available stations list tab

DAB:

[MEDIA_DAB_ENSEMBLE]

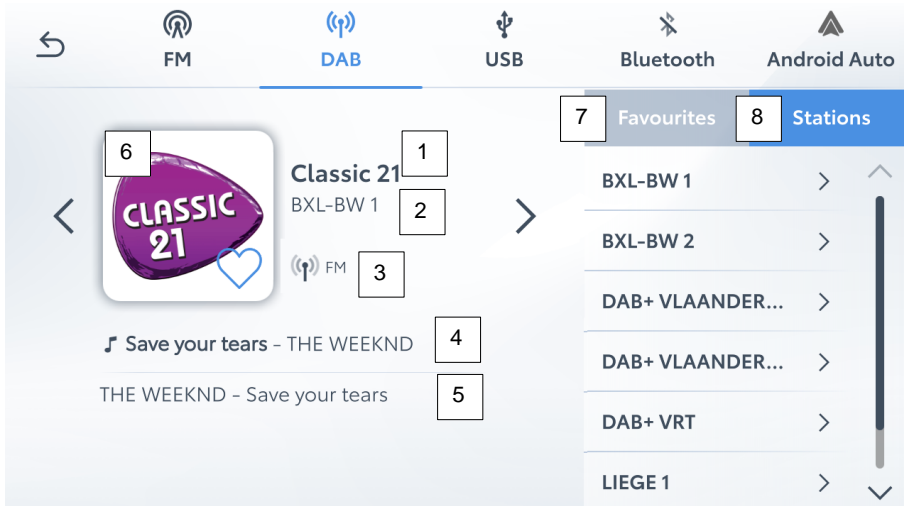

1	Tuned station name
2	Tuned station ensemble
3	FM link information
4	Song/artist of current song

5	Radio station text
6	Station logo
7	Available stations list tab
8	Favourites list tab

SELECTING A RADIO STATION

To select a radio station, use any of the following options:

STATION LIST

Select “Stations” to go to station list, from where you can select the desired station from a list of detected radio stations.

[MEDIA_DAB_STATION]

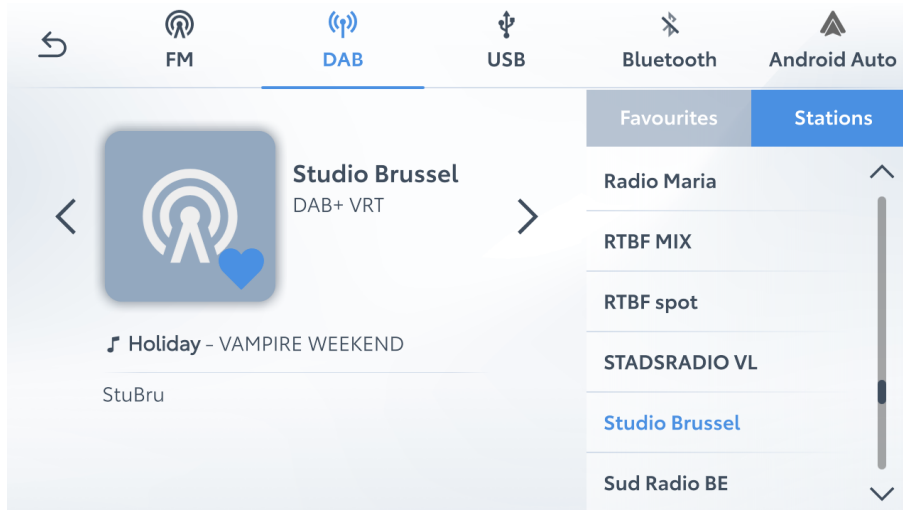

For DAB, the stations can be grouped by ensemble. To enable/disable this option, refer to section 2.5.

FAVOURITES LIST



Select “Favourites” to go to the favourites list.

Storing a favourite

There are two ways to store a station into the favourites list:

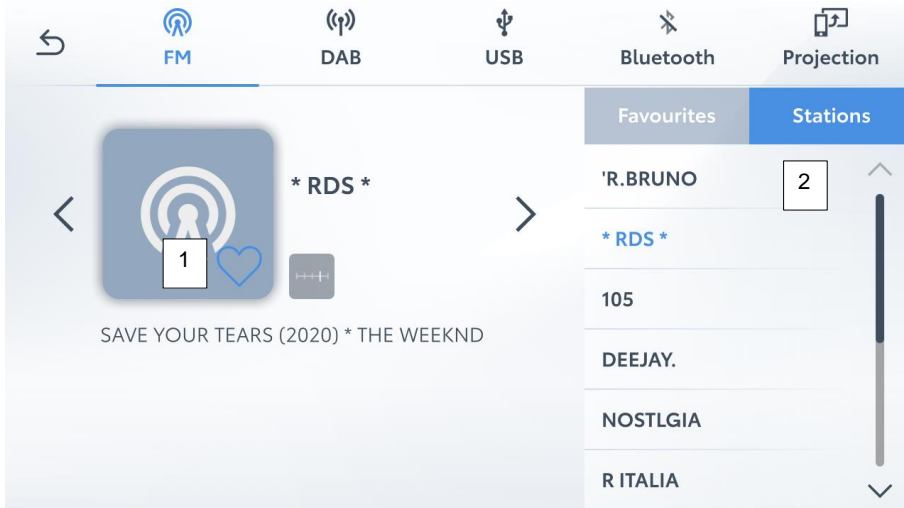
[MEDIA_FM_FAV]



- | | |
|---|---|
| 1 | From the currently playing station, touch  on the station logo to add a station to favourites list |
| 2 | From the station list, touch and hold on a station name and touch  to add to favourites. |



Reordering the favourite list

Select  and drag to modify the order within your favourites stations

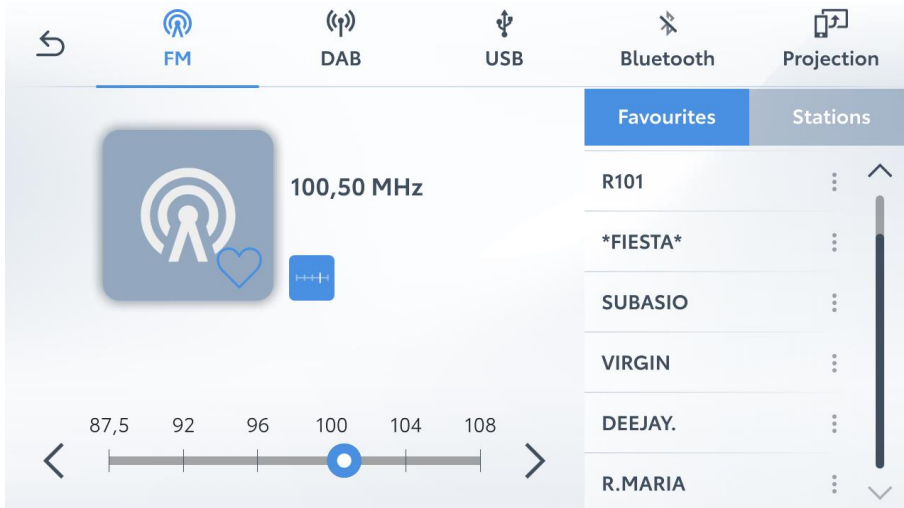
[MEDIA_FM_DRAG]



Removing a favourite

To remove a favourite, untick the  icon from the currently playing station or touch and hold on a favourite and touch .

[MEDIA_FM_FAV_REMOVE]

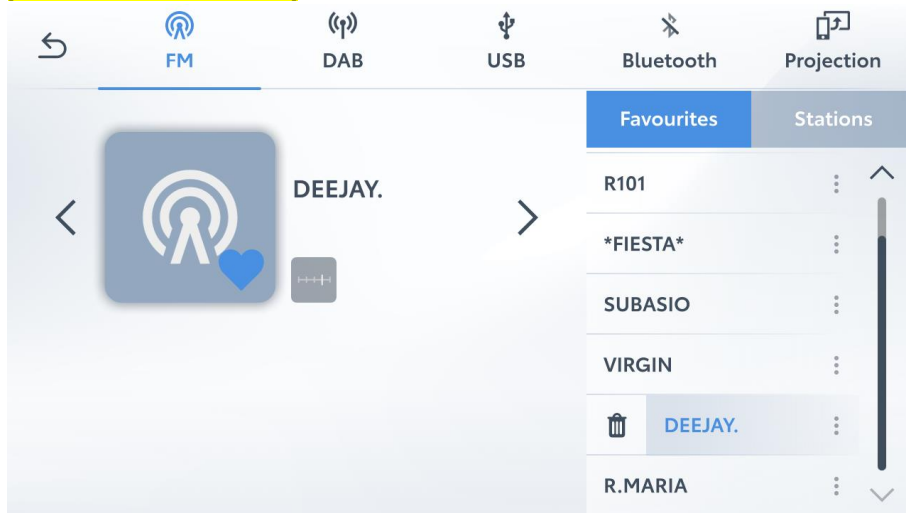

MANUAL TUNING (FM ONLY)

In manual tuning mode, you tune the radio to a specific frequency.

[MEDIA_FM_TUNING]

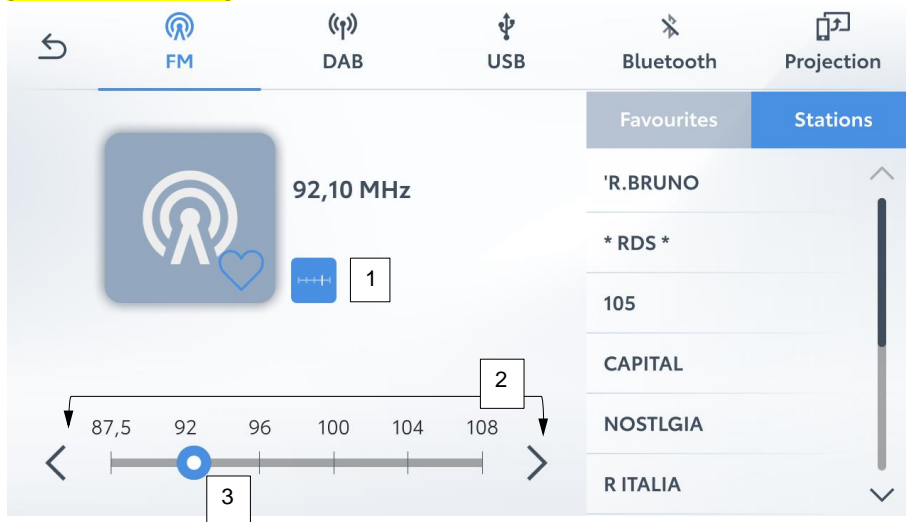

1	Access manual tuning.
2	Increase/decrease the frequency with one step.

	Touch and hold to start a seek operation. The radio will scroll through the frequencies until a radio station is found.
3	Drag the tuner slider  left or right to the desired frequency.

RDS (RADIO DATA SYSTEM)

The Radio Data System transmits station information and allows advanced radio features, described in this section. Depending on the availability of RDS infrastructure, the service may not be available.

To enable/disable these features, see section 0.

ALTERNATIVE FREQUENCY (FM ONLY)

This feature enables the radio to automatically switch to the best available frequency for your selected station.

REGIONALISATION (FM ONLY)

OFF mode: For switching over to a broadcasting station within the same RDS network, convenient for following the appropriate stations in a wide region.

ON mode: For switching over to a broadcasting station within the same local program network. To enable/disable this feature, see section 0. Regionalisation will automatically be deactivated when Alternative Frequency is disabled.

DAB SERVICE FOLLOWING

This feature enables the radio to automatically switch to the best available frequency for your selected service.

If no alternative DAB broadcast is available, the radio will perform FM linking if the same station is available on FM band. When FM linking is active, this is indicated by the  icon.

NOTE:

If an alternative FM or DAB broadcast does not exist, audio playback will be muted.

TRAFFIC ANNOUNCEMENT (FM/DAB)

When enabled, the tuner will automatically seek a station that regularly broadcasts traffic information and broadcast the station when the traffic information program starts. Traffic information also functions when listening to a different media source.

[TRAFFIC_ANNOUNCEMENT_DIALOG]

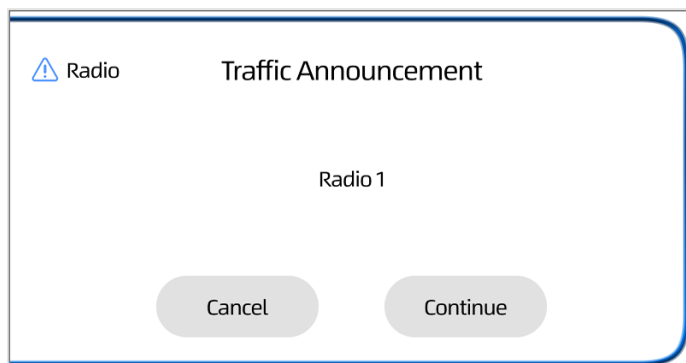

When a Traffic Announcement occurs, a notification message will alert you with the option to “Continue” or “Cancel”.

- Touching “Continue” clears the notification and proceeds with the Traffic Announcement. Once the announcement is completed, the system will go back to the Media source active before the Traffic Announcement.
- Touching “Cancel” clears the notification and the system will go back to the Media source active before the Traffic Announcement.

Press volume +/- while the Traffic Announcement is active to adjust the volume. This volume is memorized for subsequent Traffic Announcements.

3.2 USB

CONNECTING A DEVICE

To connect a USB/iPod device, connect a compatible device to the USB port.

[IP_USB_PORT]

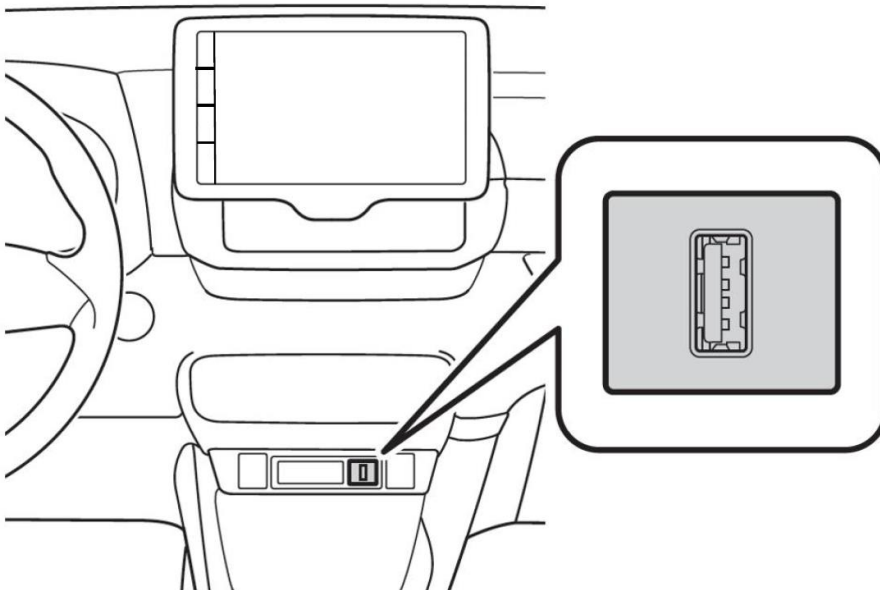

AUDIO PLAYBACK

To playback audio from USB storage or iPod, follow these steps.

1. Touch the “MEDIA” button on the HOME screen.
2. Select the “USB” tab from the available media sources.

[MEDIA_USB]

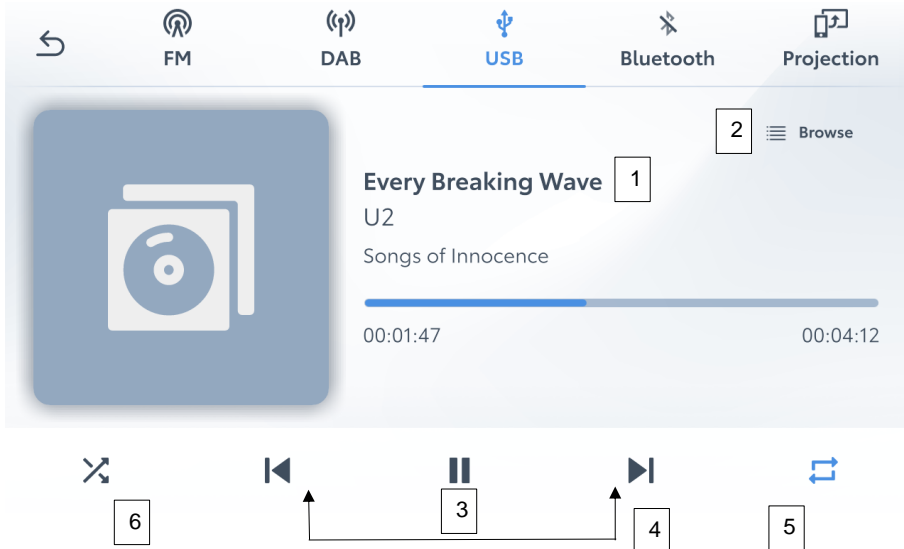

1	Currently playing track info (song/artist/album)
2	Browse through the media content of the connected device
3	Play/pause
4	Play the previous/next file
5	Cycle through the repeat track / repeat all / repeat off modes
6	Toggle shuffle function on/off

BROWSING

Touch the "Browse" button on the USB media screen to access media files on the USB device.

[MEDIA_USB_BROWSE1]

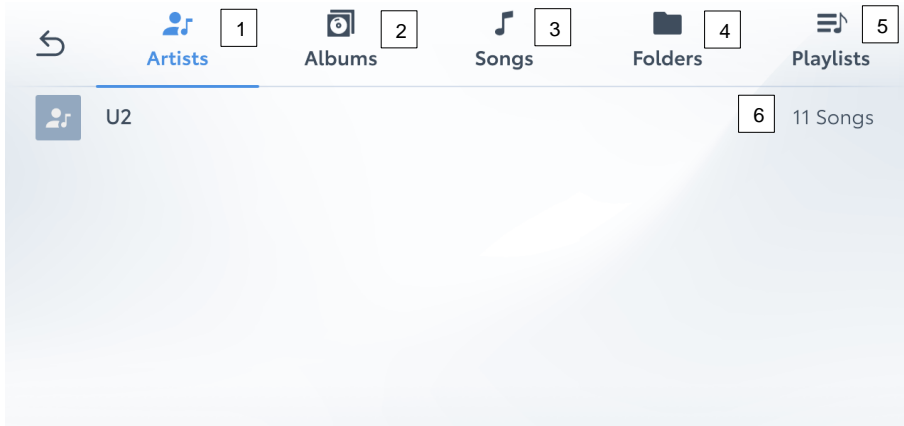

[MEDIA_IPOD_BROWSE]

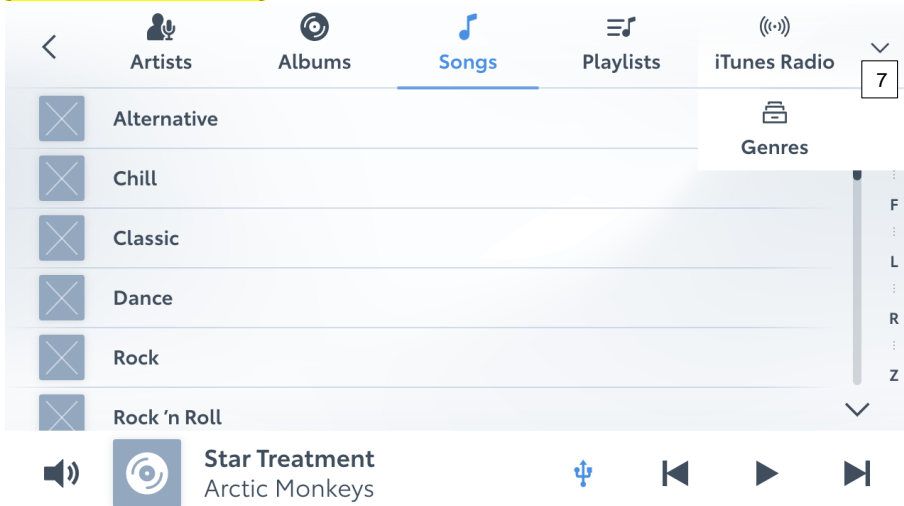

1	Display media sorted by artist. Playing a song from one artist will play all the available songs until another artist is selected.
2	Display media sorted by album. Selecting one, will play it entirely until another album is selected
3	Display all available songs sorted alphabetically
4	Access media from the folder structure on the device
5	Display available playlists on the device
6	Number of available songs for every artist/album/folder/playlist
7	Current active playback will always be displayed in the miniplayer. Touch the miniplayer to go back to the playback screen.
8	Select to adjust shown category

COMPATIBLE EXTENSIONS

The following table lists the types of media files than are supported by this multimedia system.

Format	Extension
WMA	.wma
MP3	.mp3
AAC	.m4a
FLAC	.flac
LPCM	.wav

3.3 BLUETOOTH®

Toyota Smart Connect is equipped with Bluetooth®, a technology that enables you to play music from your device. If your device does not support Bluetooth®, the Bluetooth® audio system will not function.

To use this function, a device must be connected for “Media” profile. Refer to section 2.1 for more details.

NOTE:

Depending on the version of Bluetooth® supported by your device, some functions may not be available.

PLAYBACK

To playback audio from a Bluetooth® device, follow these steps.

1. Touch the “MEDIA” button on the HOME screen.
2. Select “Bluetooth” tab from the available media sources.

[MEDIA_BT]

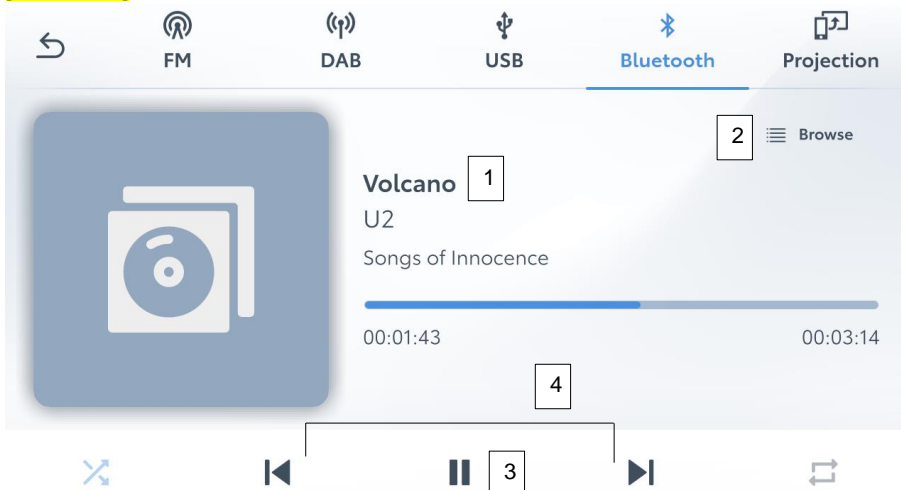

6

5

1	Currently playing track info (song/artist/album)
2	Browse through the media content of the connected device
3	Play/pause
4	Play the previous/next file
5	Cycle through the repeat track / repeat all / repeat off modes
6	Toggle shuffle function on/off

BROWSING

Touch the “Browse” button on the Bluetooth® media screen to access media files inside the connected device.

[MEDIA_BT_BROWSE]

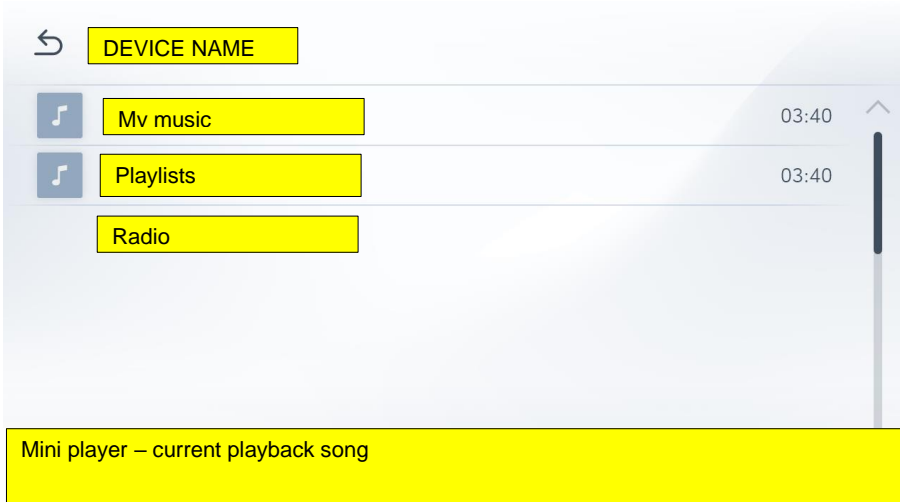

3.4 PROJECTION

Touch the tab “Projection” or Apple CarPlay / Android Auto (in case your device is already connected with the system) to access media on your mobile phone.

A connection can be established by connecting your device to the USB port or wirelessly as explained in section 5.

PLAYBACK

[MEDIA_PROJ]

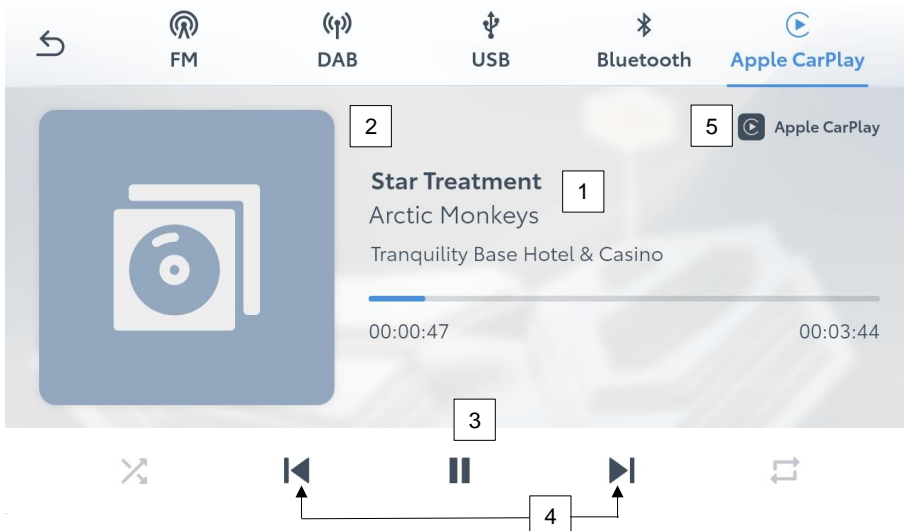

1	Currently playing track info (song/artist/album)
2	Shortcut to Apple CarPlay / Android Auto screen
3	Play / pause current playback
4	Play previous / next song or track
5	Browse through the media content of the connected device

BROWSING

Browsing is supported for Apple CarPlay devices only. It allows browsing through media content stored on the device. Media content provided by other apps (eg. streaming services) cannot be browsed.

[MEDIA_PROJ_BROWSE]

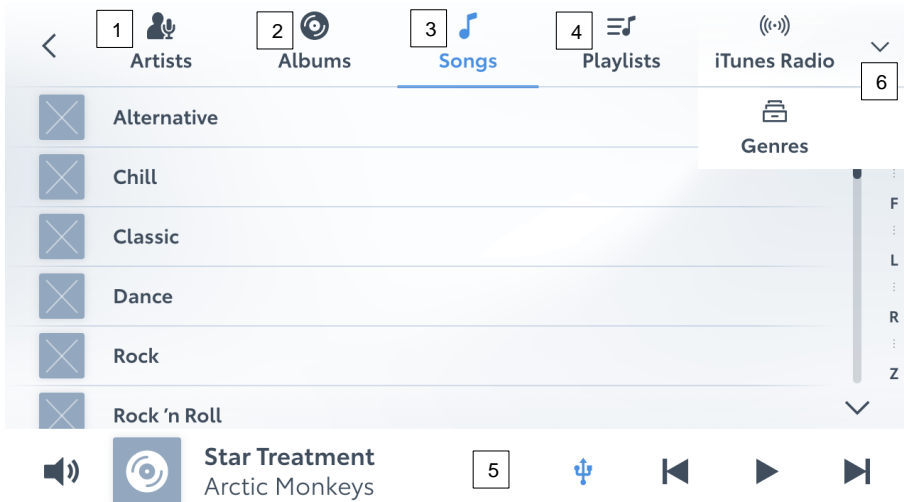

Comentado [DV(7)]: Screen will be updated in navi software (browse button is available for carplay)

Comentado [DV(8R7)]: TBC whether Android Auto / Apple CarPlay is the same (can we use one screenshot?)

Comentado [DV(9R7)]: Android Auto is same as carplay, only browser button is not there (so use carplay screenshot)

1	Display media sorted by artist. Playing a song from one artist will play all the available songs until another artist is selected.
2	Display media sorted by album. Selecting one, will play it entirely until another album is selected
3	Display all available songs sorted alphabetically
4	Display available playlists on the device
5	Current active playback will always be displayed in the miniplayer. Touch the miniplayer to go back to the playback screen.
6	Select to adjust shown category

4 PHONE

Touch the “PHONE” button on the HOME screen to access the device currently connected. This section is only applicable for devices connected via Bluetooth®. To connect a phone via Bluetooth®, refer to section 2.10.

NOTE:

- While driving, do not operate a cellular-phone.
- Your audio unit is fitted with Bluetooth® antennas. People with implantable cardiac pacemakers, cardiac resynchronization therapy-pacemakers or implantable cardioverter defibrillators should maintain a reasonable distance between themselves and the Bluetooth® antennas. The radio waves may affect the operation of such devices.
- Do not leave your cellular phone in the vehicle. The temperature inside may rise to a level that could damage the phone.

NOTE:

When a phone is connected over Android Auto™ or Apple CarPlay, the functions described in this chapter are replaced by the smartphone’s interface.

NOTE:

Depending on the version of Bluetooth® supported by your device, some functions may not be available.

NOTE:

When pairing your phone for the first time, you will receive a pop-up message in order to allow access to contacts and messages.

4.1 FAVOURITES

The favourite list allows you to store and call phone numbers from the recent call and contact list. Touch “Favourites” if you are in a tab different from the favourites.

ADDING A CONTACT

There are two ways to add a phone number to the favourites list.

FROM THE CONTACTS LIST

1. Choose the contact you want to add to favourites.
2. Touch  to add the contact to your favourites.

[PHONE_CONTACT_FAV]

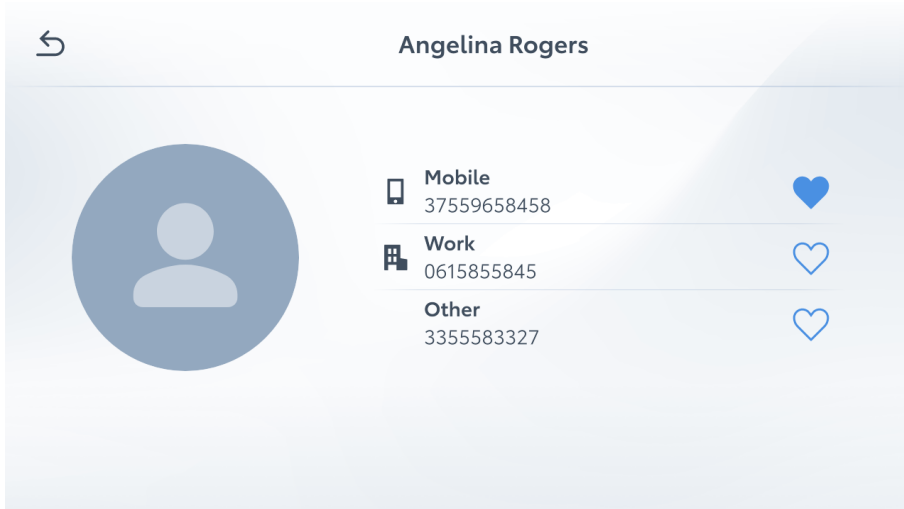

FROM THE RECENT CALL LIST

1. From the recent call list, long-press on a contact.
2. Touch  to add the contact to your favourites.

[PHONE_RECENT_FAV]

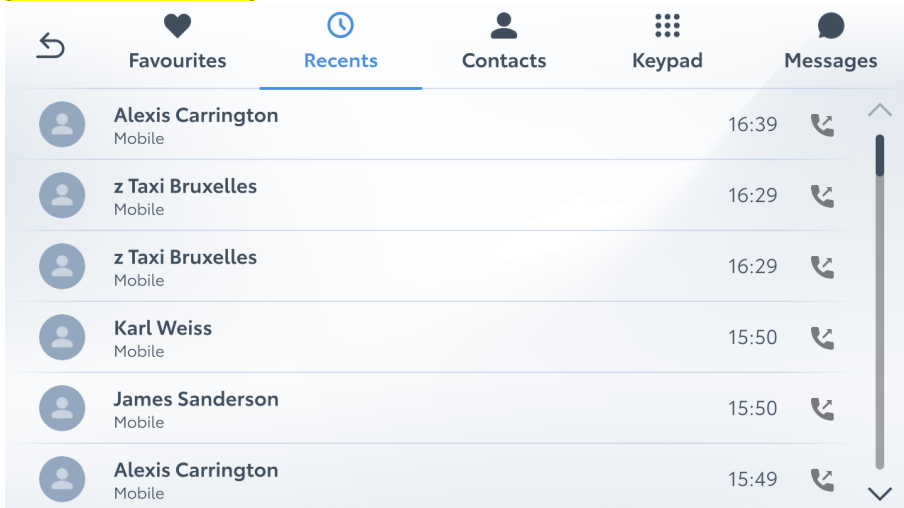



PLACING A CALL

To place a call from the favourites list, touch one of the favourites. A call will be initiated immediately.

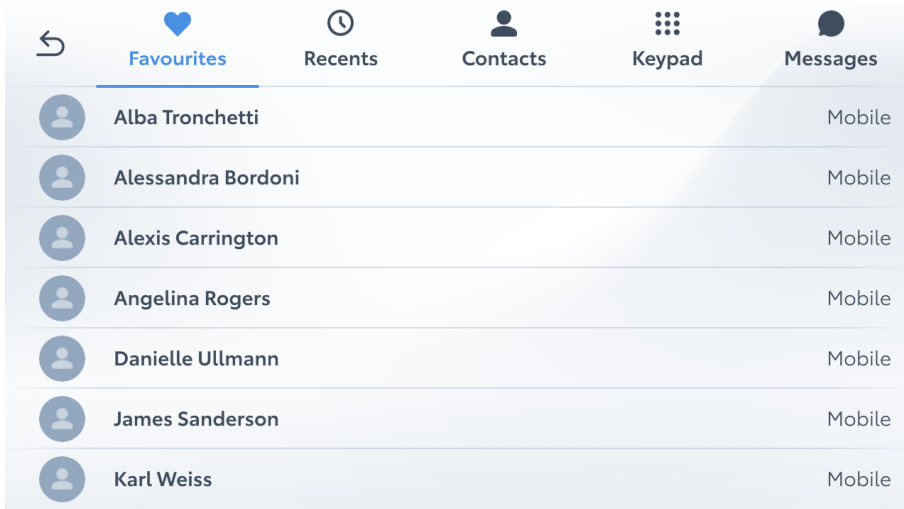
[PHONE_CONTACT_LIST_FAV]



REMOVING A FAVOURITE

To remove a favourite, untick the  icon from the contact or touch and hold on a favourite and select .

[PHONE_CONTACT_FAV_REMOVE]

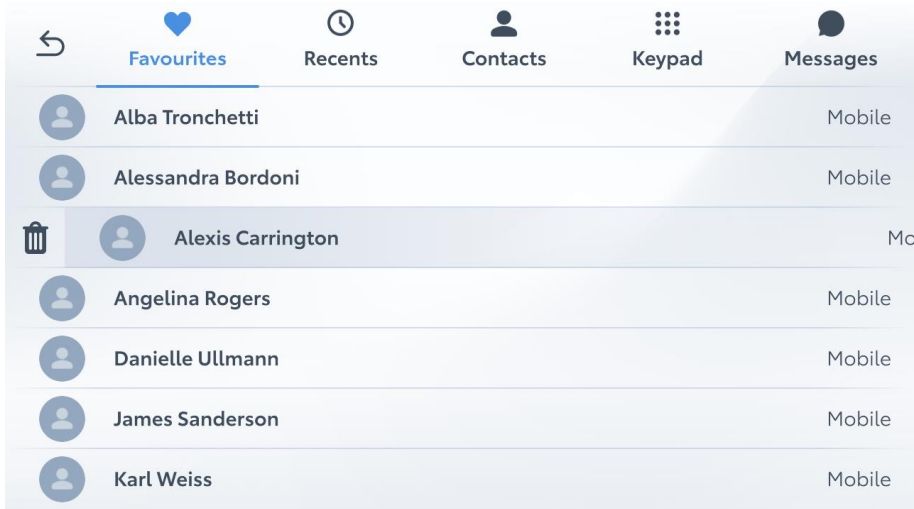

Comentado [DV(10): Better to use icon without background color

4.2 RECENT CALL LIST



The recent call list shows a history of previously received, dialled and missed calls. To place a call using "Recent":

1. Touch "Recent" if you are in a tab different from the recent call history
2. Touch the name of the person / phone number you want to call. The call will be started.

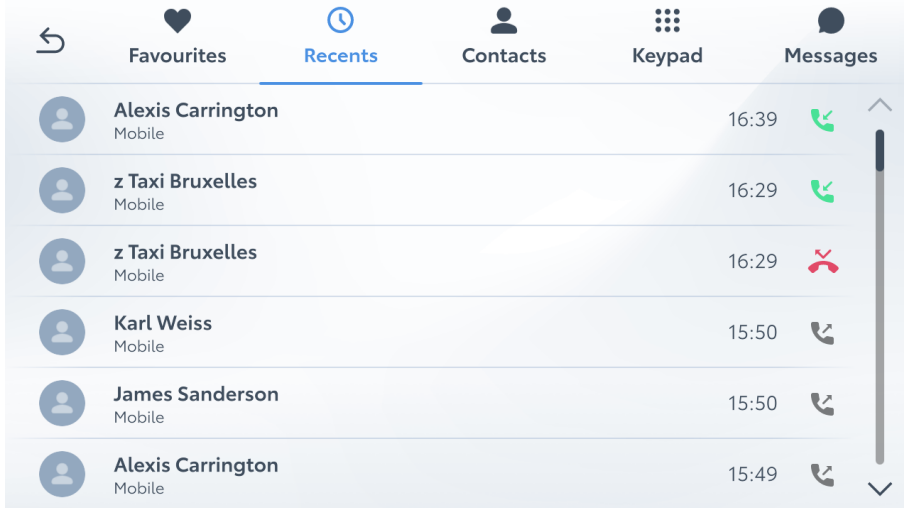
[PHONE_RECENT_LIST]



The icons of call type are displayed as below:

	Missed call
	Received call
	Outgoing call

Comentado [DV(11): Icons without background required

By long-pressing one of the contacts in the recent call list, you can add it to your favourites.

4.3 CONTACT LIST

The contact list synchronizes with the phonebook data of the connected phone. To call through the contact list:

1. Touch "Contacts" if you are in a tab different than contacts.
2. Select the name of the person you want to call. The contact details will be shown.

[PHONE_CONTACT_FAV]

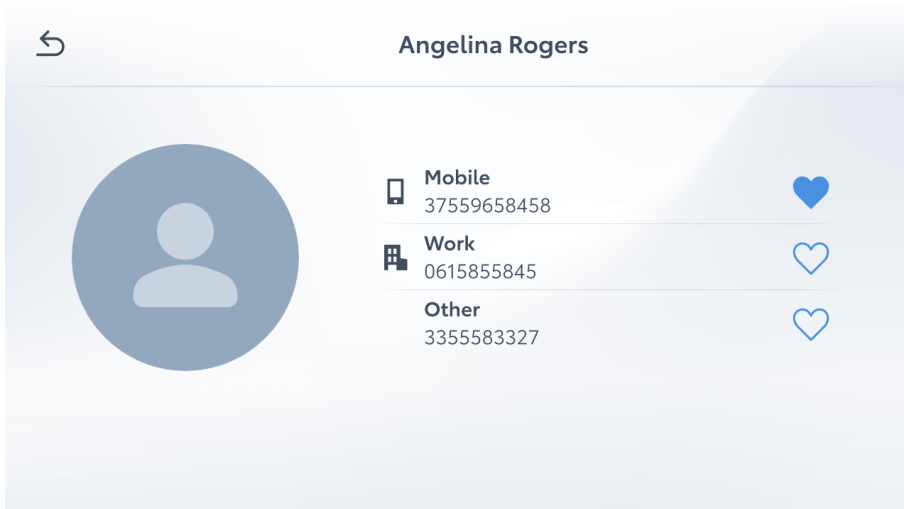

3. Select the phone number to dial the contact. If there are 2 or more phone numbers, select the desired number in the list.

A phone number can be added to the favourites by touching the  icon.

4.4 KEYPAD

To place a call using the keypad:

1. Touch "Keypad" if you are in a tab different than keypad.
2. Enter the phone number using the keys available.

[PHONE_KEYPAD]

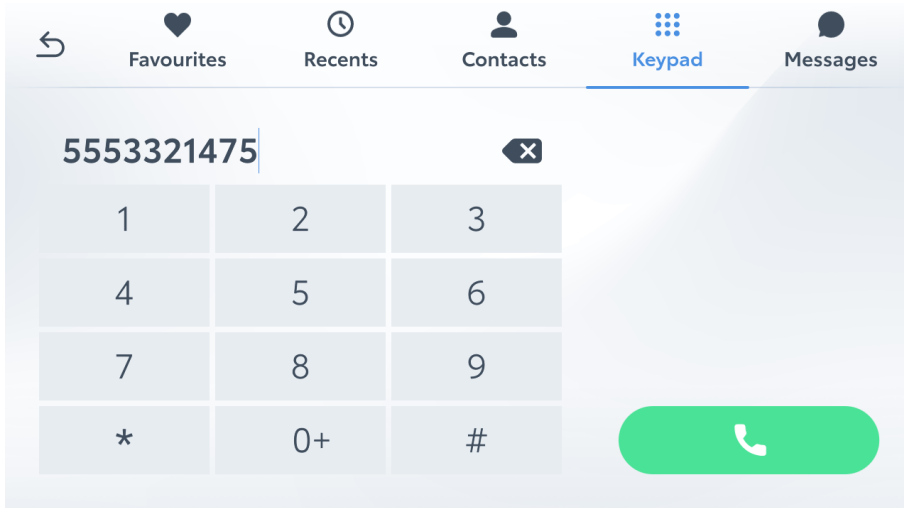

3. Touch  to start the call.

4.5 RECEIVING CALLS

When a paired device receives a call, following screen is displayed and a ringtone will be played.

The volume of the ringtone can be adjusted from the settings menu (see section 2.2) or using the volume +/- keys.

[PHONE_INCOMING_CALL]

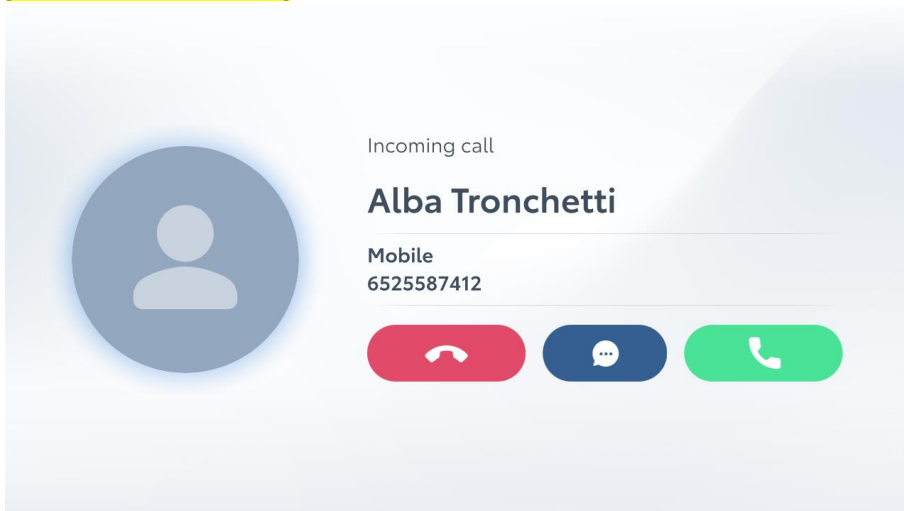

Touch  to Accept the call

Touch  to Reject the call

Touch  to reject the call and reply with one of the pre-programmed text messages.

[PHONE_AUTOMATIC_ANSWER]

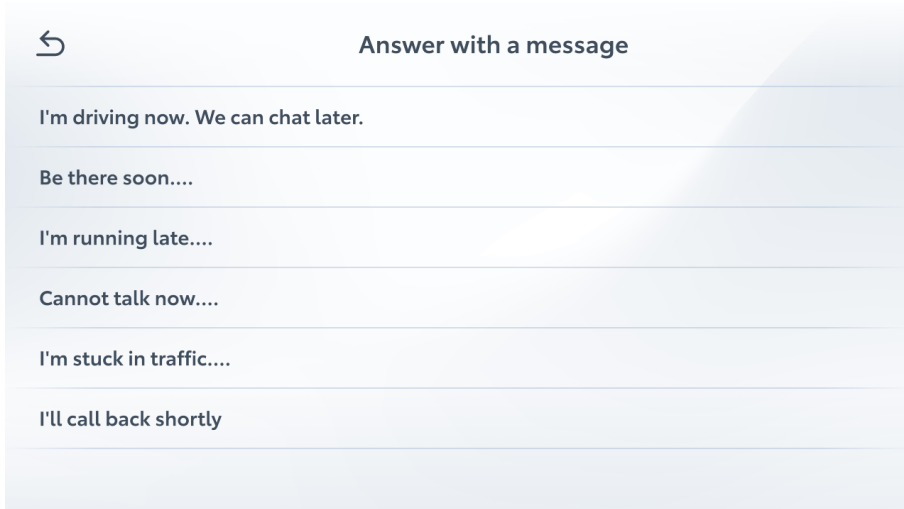

4.6 DURING A CALL

While talking on an active call, the following screen is displayed:

[PHONE_ACTIVE_CALL]

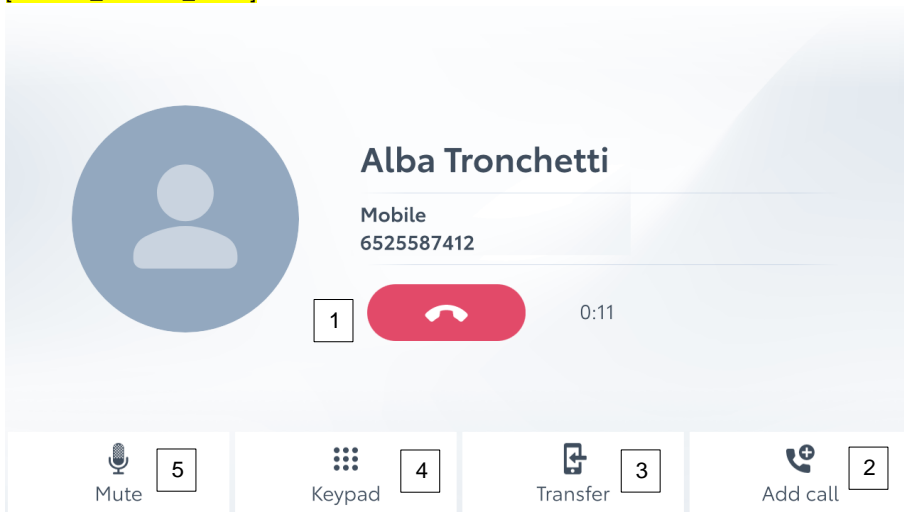



Comentado [DV(12): TBC, there should be merge function as well for conf call, but it's not correct in these screenshots

In case a second call is ongoing, the following screen is displayed:

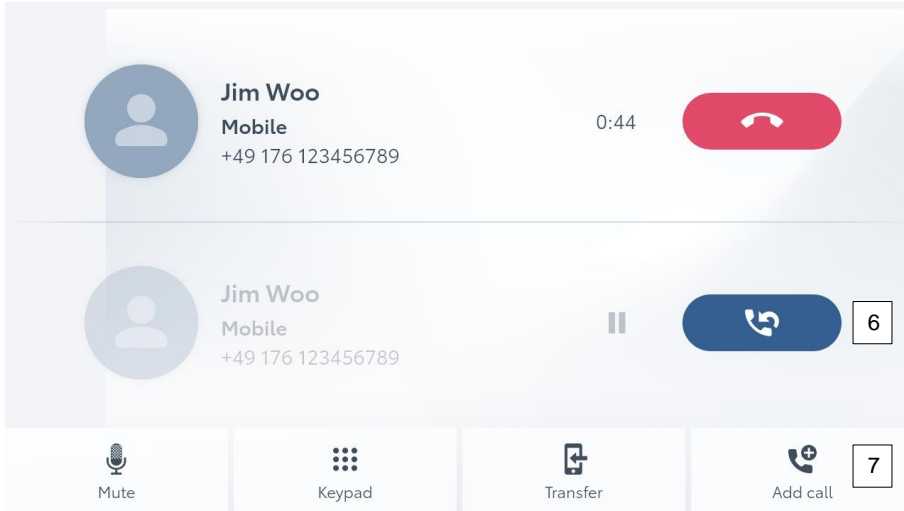
[PHONE_SECOND_CALL]



1	Touch  to hang up the phone. The  button on the steering wheel can also be pressed to hang up the phone.
2	Dial a second number
3	Switch from handsfree call to a cellular phone call
4	Open the keypad to send a tone
5	Mute your voice to the other party. The icon will be highlighted during mute mode. To cancel muting your voice, select this icon again
6	Switch to a call on hold. This will put active call on hold.
7	Combine both calls into a conference call

When returning to HOME screen during a call, call information is shown in the miniplayer.

[HOME_ACTIVE_CALL]

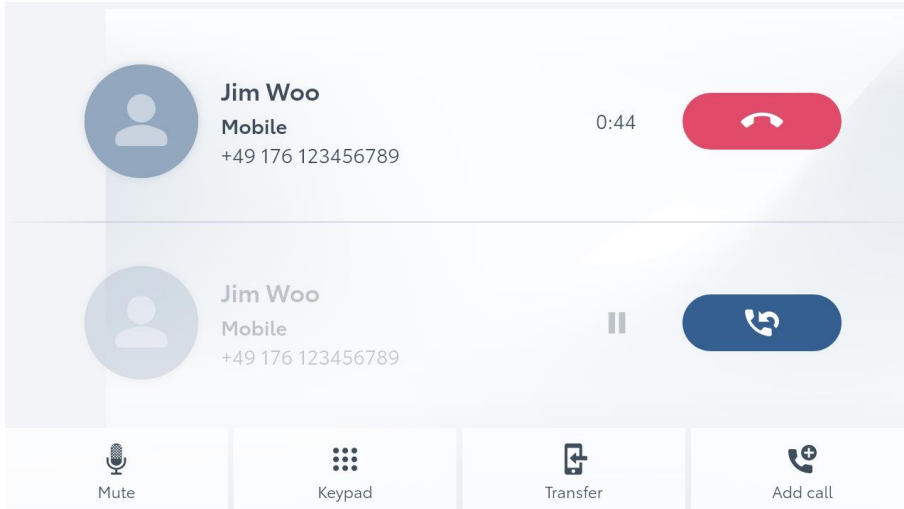

To return the call window, press the “PHONE” button or press the miniplayer area.

4.7 SHORT MESSAGE FUNCTION

Toyota Smart Connect supports display of received text messages. When a new message is received, a pop-up will be displayed.

To view a message through the message list:

1. Touch “PHONE” button on HOME screen.
2. Touch “Messages” tab if you are in any other screen different from messages.
3. Select the number or contact from which you want to show the message. Unread messages are indicated in the list.

[PHONE_MESSAGE_LIST]

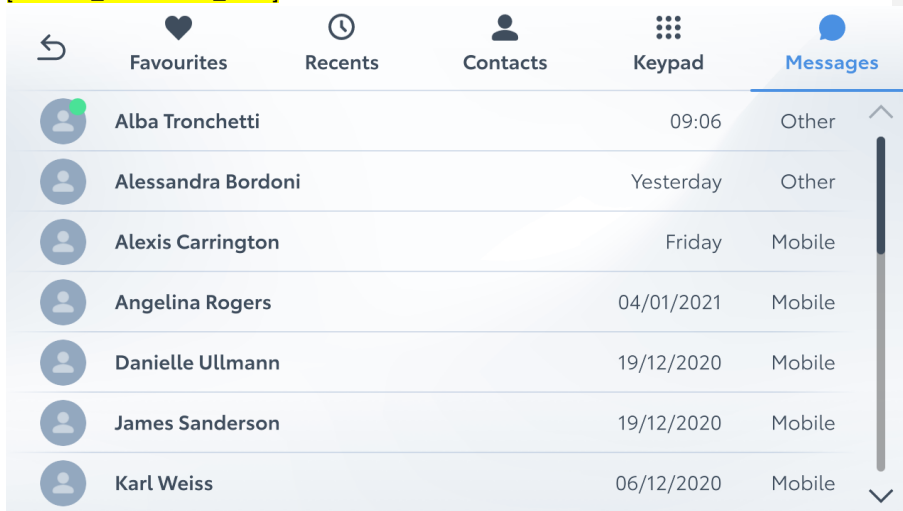

4. A screen showing the message will be displayed.

[PHONE_MESSAGE]

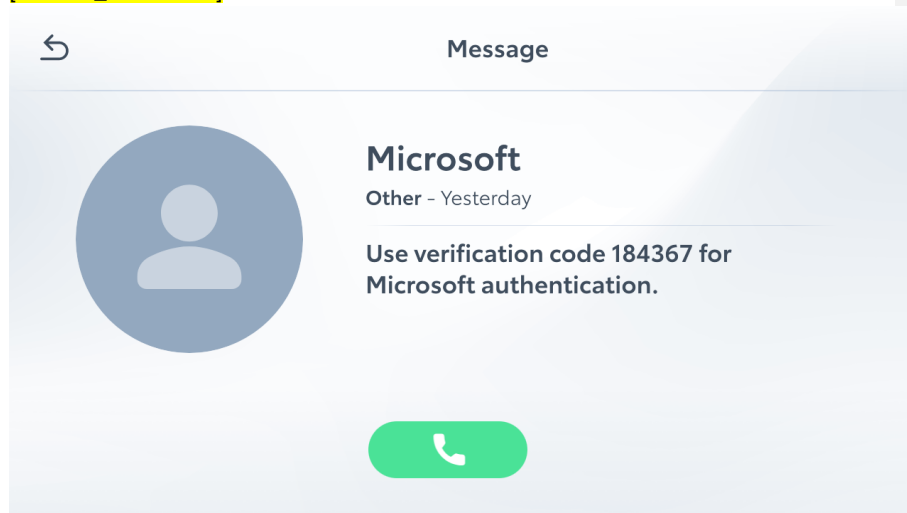

5. Touch  to call the sender directly from the message.

NOTE:

Display of text messages will be blocked while the vehicle is in motion.

5 PROJECTION

Apple CarPlay and Android Auto allows you to connect your phone to the Multimedia System both through USB or wirelessly. Touch the “PROJECTION” button on the HOME screen to access your phone through the Multimedia System.

NOTE:

When an Apple CarPlay/Android Auto connection is established, some system functions will be replaced by similar Apple CarPlay/Android Auto functions or will become unavailable.

NOTE:

By downloading and using each publication, you agree to their terms of use. Data for these functions is transmitted using the internet and may incur charges. For information about data transmission fees, contact your cellular service provider.

NOTE:

To use Apple CarPlay or Android Auto wirelessly, ensure Bluetooth® and Wi-Fi® are turned ON on the phone.

5.1 ESTABLISHING AN APPLE CARPLAY CONNECTION

NOTE:

To use Apple CarPlay, an Apple iPhone (iOS ver.11 or later) is required
For details, refer to <https://www.apple.com/ios/carplay>

Connecting to an Apple CarPlay device can be done using a wired or wireless connection.

Wired connection

Connect a compatible device to the USB port. Apple CarPlay will start automatically.

NOTE

For best performance and compatibility, ensure that you use a USB cable certified or approved by the manufacturer.

Follow the instructions on the phone to enable wireless Apple CarPlay connection as well.

Wireless connection

1. Pair a compatible device via Bluetooth (see section 2.1).
2. When the system detects the device supports Apple CarPlay, a pop-up will appear

[PROJECTION_AC_POPUP]

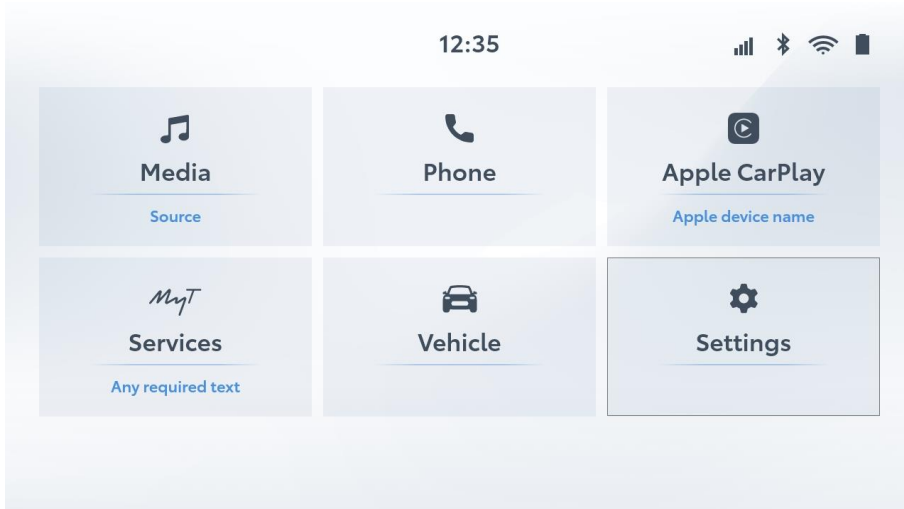

3. Click "Enable" to start wireless Apple CarPlay

Follow the instructions on the phone to activate and launch Apple CarPlay.

After successful connection, Apple CarPlay will be available on the HOME screen.

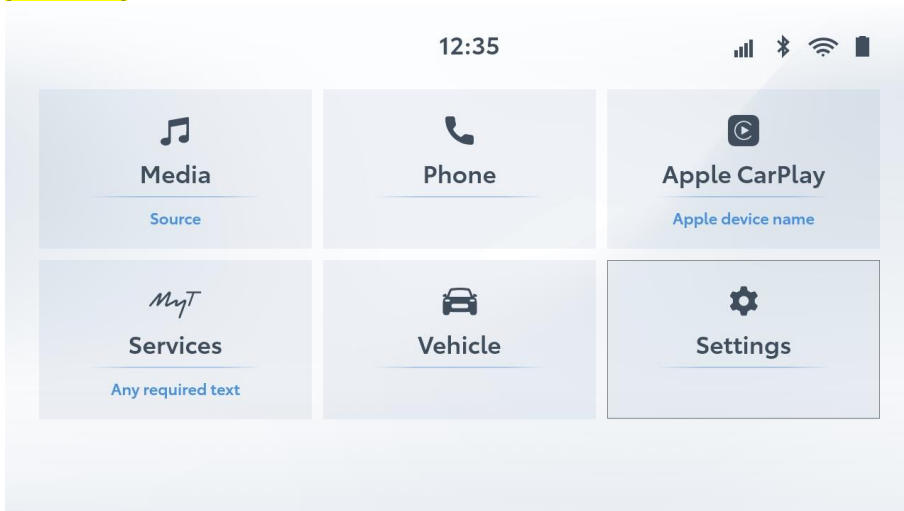

[HOME_AC]

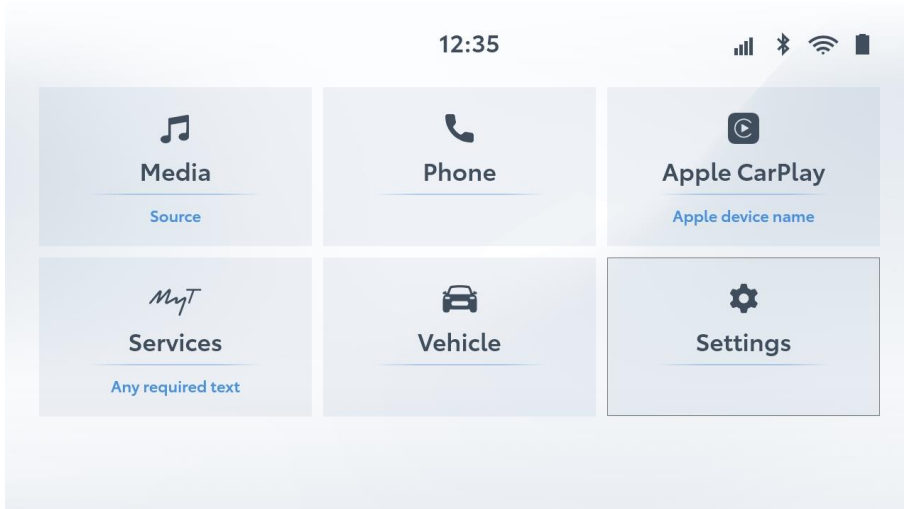

Touch the Apple CarPlay icon  to launch Apple CarPlay.

[PROJECTION_AC_HOME]



To exit the Apple CarPlay screen, short press the  or  button to go to home or previous screen, respectively. Apple CarPlay will continue running in the background.

5.2 ESTABLISHING AN ANDROID AUTO CONNECTION

NOTE:

Android Auto is not made available in some countries or areas.
To use Android Auto, an Android device is required with Android OS ver. 5.0 or higher which support Android Auto and have the Android Auto application installed.
For wireless connection with Android Auto, additional requirements apply.
For details, refer to <https://www.android.com/auto/>

Connecting to an Android Auto device can be done using a wired or wireless connection.

Wired connection

Connect a compatible device to the USB port. Android Auto will start automatically.

NOTE

For best performance and compatibility, ensure that you use a USB cable certified or approved by the manufacturer.

Connecting an Android Auto device will cause it to be paired to the Multimedia System automatically.

Wireless connection

1. Pair a compatible device via Bluetooth (see section 2.1).
2. When the system detects the device supports Android Auto, a pop-up will appear.

[PROJECTION_AA_POPUP]

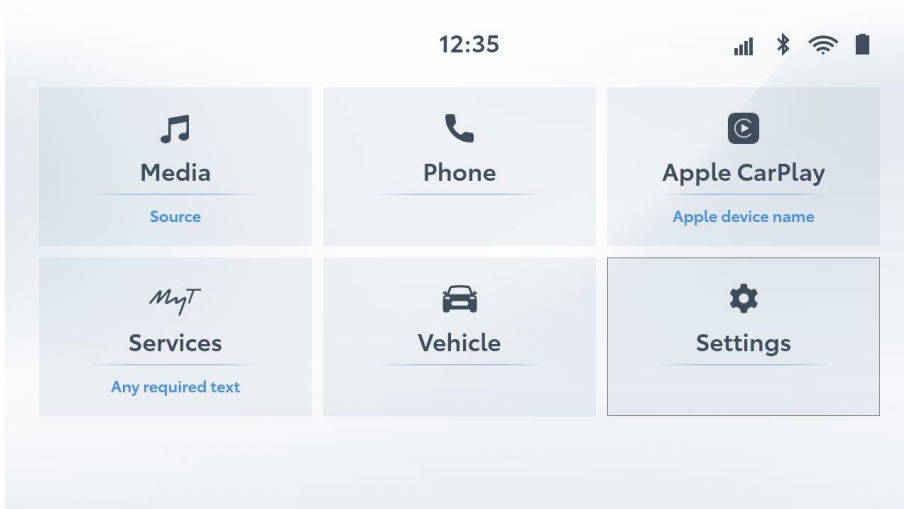

3. Click "Enable" to start wireless Android Auto.



If the Android Auto application is not installed, the device may prompt you to download the Android Auto application and other required applications. Ensure the Parking Brake is engaged and follow the instructions on the phone to activate and launch Android Auto.

NOTE:
Above steps are only required when launching Android Auto from the device the first time

The "PROJECTION" button will be updated to display the Android Auto feature now available. Touch the Android Auto button  on the HOME screen to launch Android Auto.

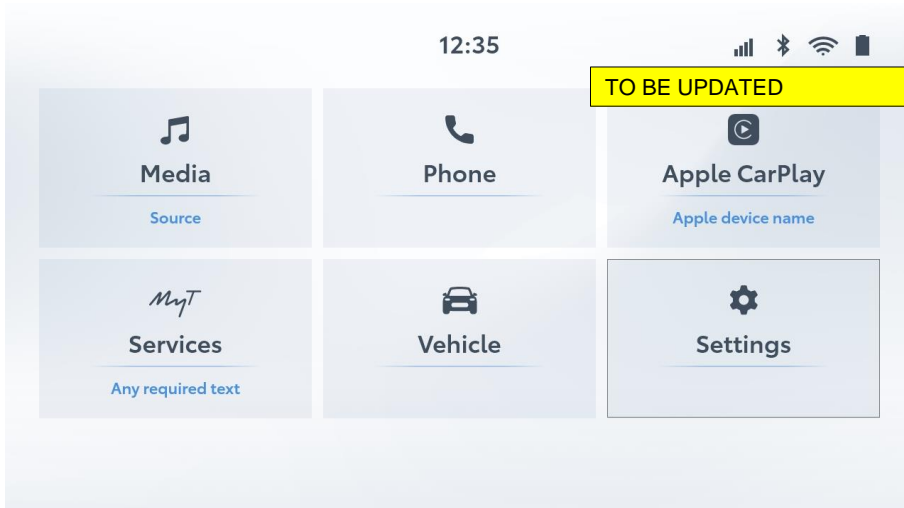
[HOME_AA]



To exit the Android Auto screen, short press the  or  button to go to home or previous screen, respectively. Android Auto will continue running in the background.

[PROJECTION_AA_HOME]

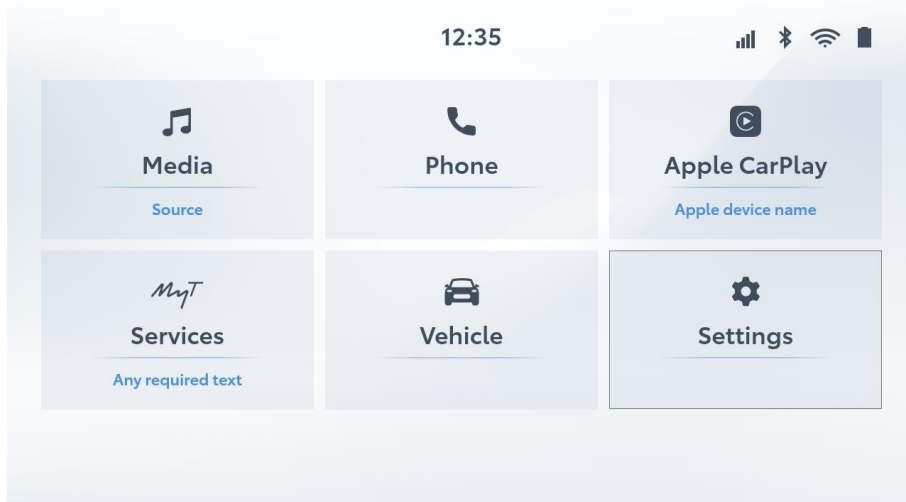

5.3 RECONNECTING TO WIRELESS APPLE CARPLAY OR ANDROID AUTO

After start-up or whenever connection was lost, the system shall automatically re-connect to the previously connected device, if available.

To manually reconnect to Apple CarPlay or Android Auto, connect to the device from the settings menu as explained in section 2.1, or from the HOME screen:

1. Press the "PROJECTION" button
2. A pop-up will appear with previously connected devices

[PROJECTION_RECONNECT_POPUP]

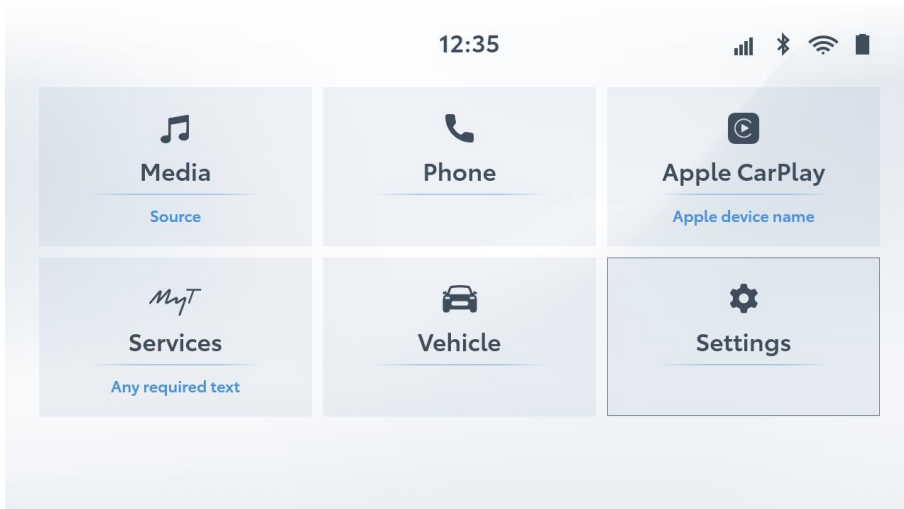

3. Select the device to connect for Apple CarPlay or Android Auto.

6 NAVIGATION

Touch the "NAVIGATION" button on the HOME screen to access the navigation system.

NOTE:

In order to use the navigation function, connectivity should be available.

NOTE:

Design and content of the navigation function might deviate from what is described in this section

6.1 MAP

The map display consists of the following functions:

NAVI_MAP

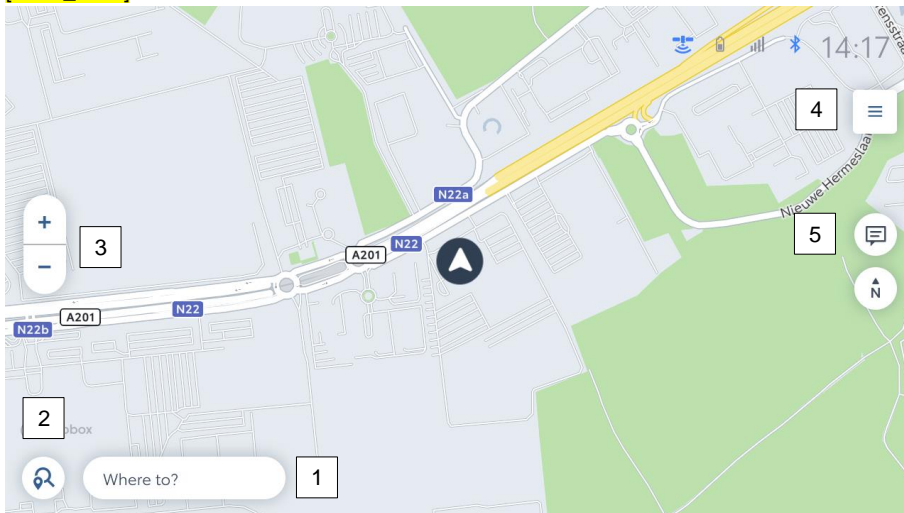

1	Search bar. Press on this section to bring up the keyboard. You can search any destination via this keyboard.
2	Point of Interest (POI) bar with quick access icons. You can click on any of the icons and the search results will be shown
3	Use these buttons to Zoom in and out from the map.
4	Access the navigation settings
5	Use this button to report a road event like speed camera or report navigation related issues

6.2 NAVIGATING TO A DESTINATION

When navigating to a destination, the following functions are displayed:

NAVI_DESTINATION

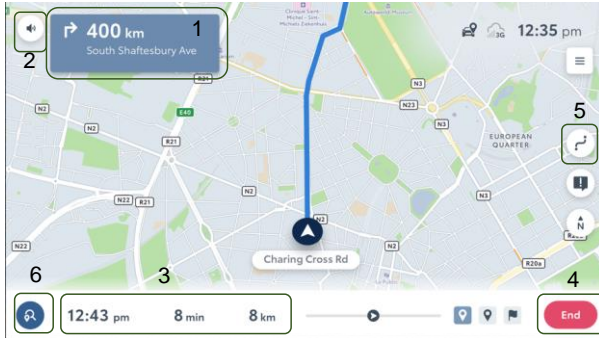

1	Turn-by-turn guidance. Details of the next manoeuvre will be displayed here.
2	Mute the voice guidance. Press again to unmute.
3	Route info section. This section shows arrival time to destination, remaining time, distance.
4	End the current trip
5	Show the route overview. Press the button again to come back to default view
6	Search additional destinations

7 SERVICES

Touch the “SERVICES” button on the HOME screen to access the Toyota Smart Connect Services.

NOTE:

In order to use the connected services, connectivity should be available.

NOTE:

To use Toyota Smart Connect services, the user needs to have the MyT app on their phone and accept the smart services subscriptions. Afterwards, the user needs to connect the user profile with the car. Refer to the help section in the MyT app and Toyota Smart Connect system for a step-by-step guide.

7.1 SERVICES HOME

The services home page provides an overview of the services and user profile settings

[MYT_HOME]

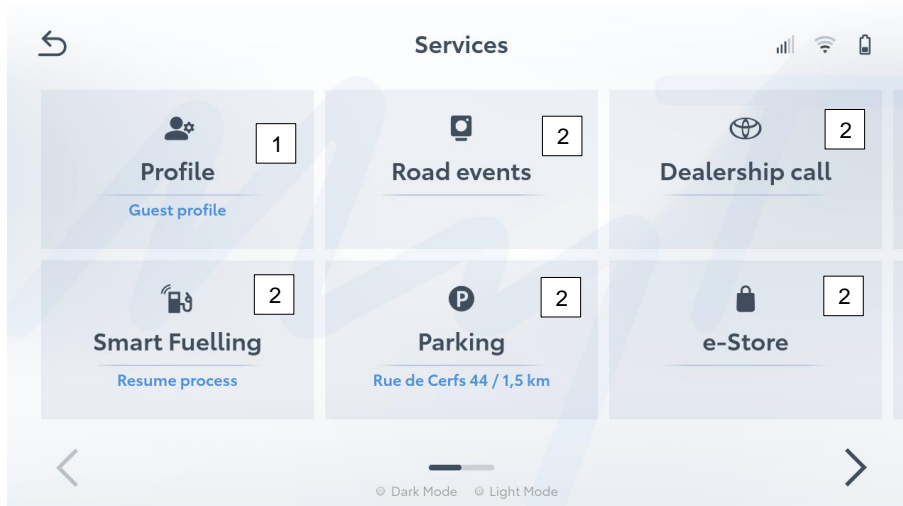

- | | |
|---|---|
| 1 | User profile and Settings section
Access to change all service and profile related settings |
| 2 | Example of smart connect services which are available to use.
Access to view the service details |

7.2 SERVICES DETAILS

The service details page provides detailed information about the service and how to use it.

NOTE:

The content of the smart connect service details page can vary from service to service.

NOTE:

The content of a smart connect service can vary from country to country depending on the regulations.

[MYT_SERVICES_EXAMPLE]

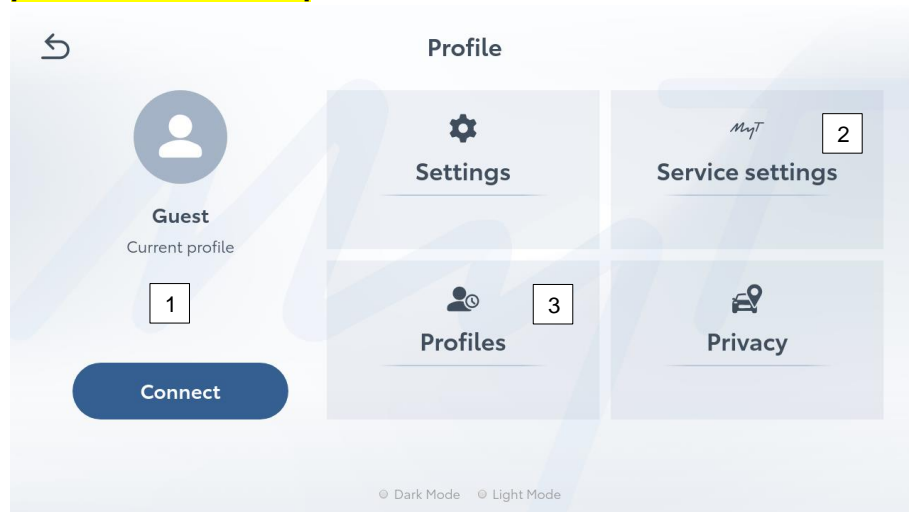

1	Service explanation
2	Benefits of using the service
3	Tutorial on how to use the service

8 REAR VIEW MONITOR SYSTEM

The rear view monitor system assists the driver by displaying an image of the view behind the vehicle with fixed guide lines on the screen while backing up, for example while parking.

Comentado [DV(13): For pictures we need to define the solution still

PRECAUTION

The rear view monitor system is a supplemental device intended to assist the driver when backing up. When backing up, be sure to visually check all around the vehicle both directly and using the mirrors before proceeding. If you do not, you may hit another vehicle, and could possibly cause an accident. Pay attention to the following precautions when using the rear view monitor system:

- Never depend on the rear view monitor system entirely when backing up. The image and the position of the guide lines displayed on the screen may differ from the actual state.
- Use caution, just as you would when backing up any vehicle.
- Be sure to back up slowly, depressing the brake pedal to control vehicle speed.
- The instructions given are only guidelines. When and how much to turn the steering wheel will vary according to traffic conditions, road surface conditions, vehicle condition, etc. when parking. It is necessary to be fully aware of this before using the rear view monitor system.
- When parking, be sure to check that the parking space will accommodate your vehicle before manoeuvring into it. Do not use rear view monitor system in the following cases:
 - On icy or slick road surfaces, or in snow
 - When using tyre chains or emergency tyres
 - When the back door is not closed completely
 - On roads that are not flat or straight, such as curves or slopes.
- In low temperatures, the screen may darken or the image may become faint. The image could distort when the vehicle is moving, or you may become unable to see the image on the screen. Be sure to visually check all around the vehicle both directly and using the mirrors before proceeding.
- If the tyre sizes are changed, the position of the fixed guide lines displayed on the screen may change.
- The camera uses a special lens. The distances between objects and pedestrians that appear in the image displayed on the screen will differ from the actual distances

8.1 SCREEN DESCRIPTION

The rear view monitor system screen will be displayed if the shift lever is shifted to the "R" position while the engine switch is ON.

[RVC1]

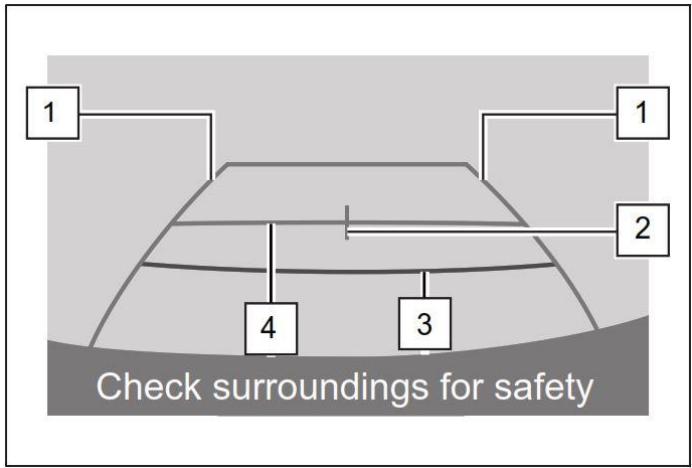

1	Vehicle width guide lines	Displays a guide path when the vehicle is being backed straight up. The displayed width is wider than the actual vehicle width.
2	Vehicle centre guide line	This line indicates the estimated vehicle centre on the ground.
3	Distance guide line	Shows distance behind the vehicle. Displays a point approximately 0.5 m (1.5 ft.) (red) from the edge of the bumper.
4	Distance guide line	Shows distance behind the vehicle. Displays a point approximately 1 m (3 ft.) (blue) from the edge of the bumper.

The rear view monitor system is cancelled when the shift lever is shifted into any position other than the "R" position.

8.2 REAR VIEW MONITOR PRECAUTIONS

AREA DISPLAYED ON THE SCREEN

The rear view monitor system displays an image of the view from the bumper of the rear area of the vehicle.

[RVC2]

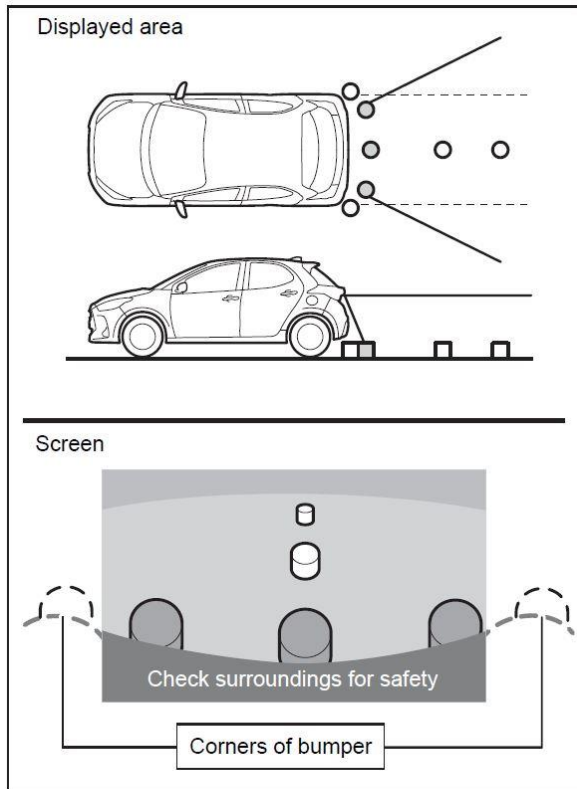

- The area displayed on the screen may vary according to vehicle orientation conditions.
- Objects which are close to either corner of the bumper or under the bumper cannot be displayed.
- The camera uses a special lens. The distance of the image that appears on the screen differs from the actual distance.
- Items which are located higher than the camera may not be displayed on the monitor.

8.3 CAMERA

The camera for the rear view monitor system is located as shown in the illustration.

[RVC3]

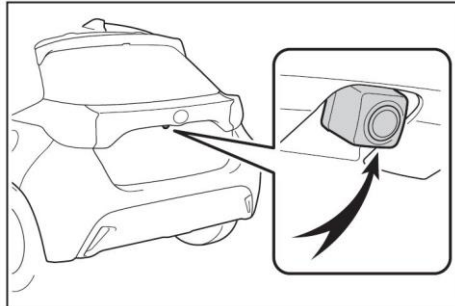

If dirt or foreign matter (such as water droplets, snow, mud etc.) is adhering to the camera, it cannot transmit a clear image. In this case, flush it with a large quantity of water and wipe the camera lens clean with a soft and wet cloth.

NOTE

The rear view monitor system may not operate properly in the following cases.

- If the back of the vehicle is hit, the position and mounting angle of the camera may change.
- As the camera has a water proof construction, do not detach, disassemble or modify it. This may cause incorrect operation.
- When cleaning the camera lens, flush the camera with a large quantity of water and wipe it with a soft and wet cloth. Strongly rubbing the camera lens may cause the camera lens to be scratched and unable to transmit a clear image.
- Do not allow organic solvent, car wax, window cleaner or a glass coating to adhere to the camera. If this happens, wipe it off as soon as possible.
- If the temperature changes rapidly, such as when hot water is poured on the vehicle in cold weather, the system may not operate normally.
- When washing the vehicle, do not apply intensive bursts of water to the camera or camera area. Doing so may result in the camera malfunctioning.
- Do not expose the camera to strong impact as this could cause a malfunction. If this happens, have the vehicle inspected by your Toyota dealer or another duly qualified and equipped professional as soon as possible.

DIFFERENCES BETWEEN THE SCREEN AND THE ROAD

- The distance guide lines and the vehicle width guide lines may not actually be parallel with the dividing lines of the parking space, even when they appear to be so. Be sure to check visually.
- The distances between the vehicle width guide lines and the left and right dividing lines of the parking space may not be equal, even when they appear to be so. Be sure to check visually.
- The distance guide lines give a distance guide for flat road surfaces. In any of the following situations, there is a margin of error between the fixed guide lines on the screen and the actual distance /course on the road.

When the ground behind the vehicle slopes up sharply

The distance guide lines will appear to be closer to the vehicle than the actual distance. Because of this, objects will appear to be farther away than they actually are. In the same way,

there will be a margin of error between the guide lines and the actual distance/course on the road.

[RVC4]

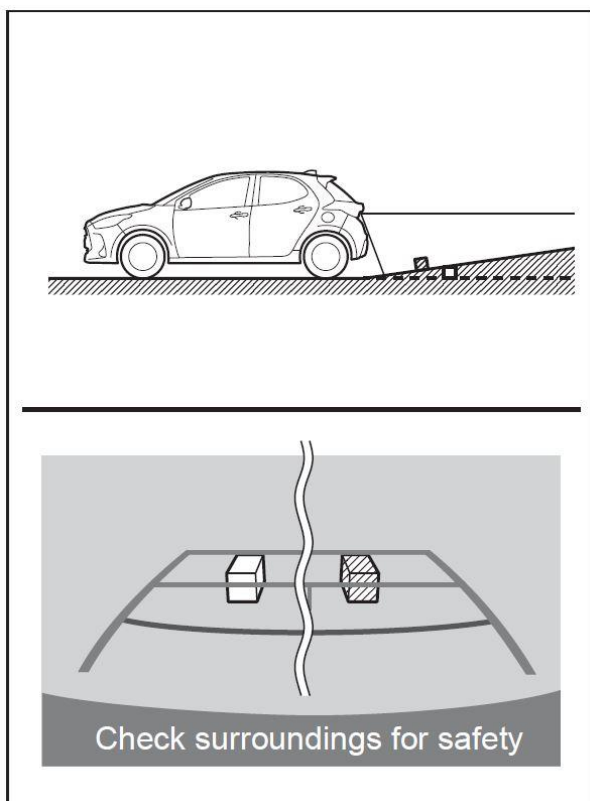

When the ground behind the vehicle slopes down sharply

The distance guide lines will appear to be farther from the vehicle than the actual distance. Because of this, objects will appear to be closer than they actually are. In the same way, there will be a margin of error between the guide lines and the actual distance/course on the road.

[RVC5]

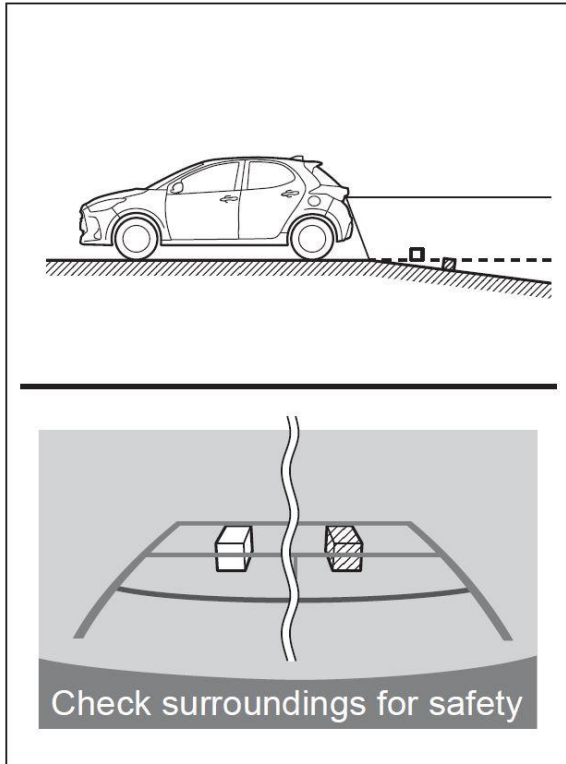

When any part of the vehicle sags

When any part of the vehicle sags due to the number of passengers or the distribution of the load, there is a margin of error between the fixed guide lines on the screen and the actual distance/ course on the road.

[RVC6]

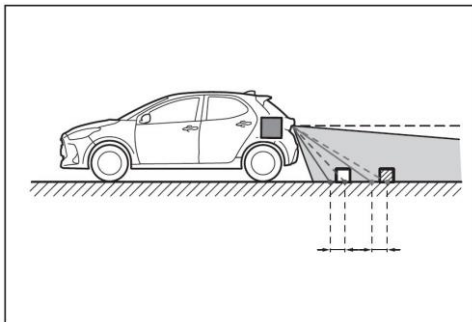

APPROACHING THREE-DIMENSIONAL OBJECTS

The distance guide lines are displayed according to flat surfaced objects (such as the road). It is not possible to determine the position of three-dimensional objects (such as vehicles)

using the vehicle width guide lines and distance guide lines. When approaching a three-dimensional object that extends outward (such as the flatbed of a truck), be careful of the following.

Vehicle width guide lines

Visually check the surroundings and the area behind the vehicle. In the case shown below, the truck appears to be outside of the vehicle width guide lines and the vehicle does not look as if it hits the truck. However, the rear body of the truck may actually cross over the vehicle width guide lines. In reality if you back up as guided by the vehicle width guide lines, the vehicle may hit the truck.

[RVC7]

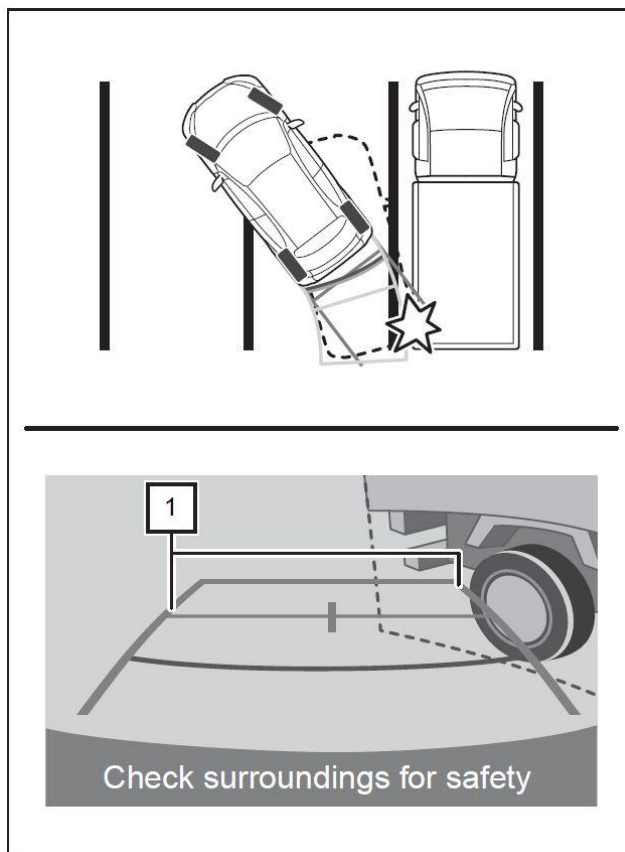

Distance guide lines

Visually check the surroundings and the area behind the vehicle. On the screen, it appears that a truck is parking at point 2. However, in reality if you back up to point 1, you will hit the truck. On the screen, it appears that 1 is closest and 3 is farthest away. However, in reality, the distance to 1 and 3 is the same, and 2 is farther than 1 and 3.

[RVC8]

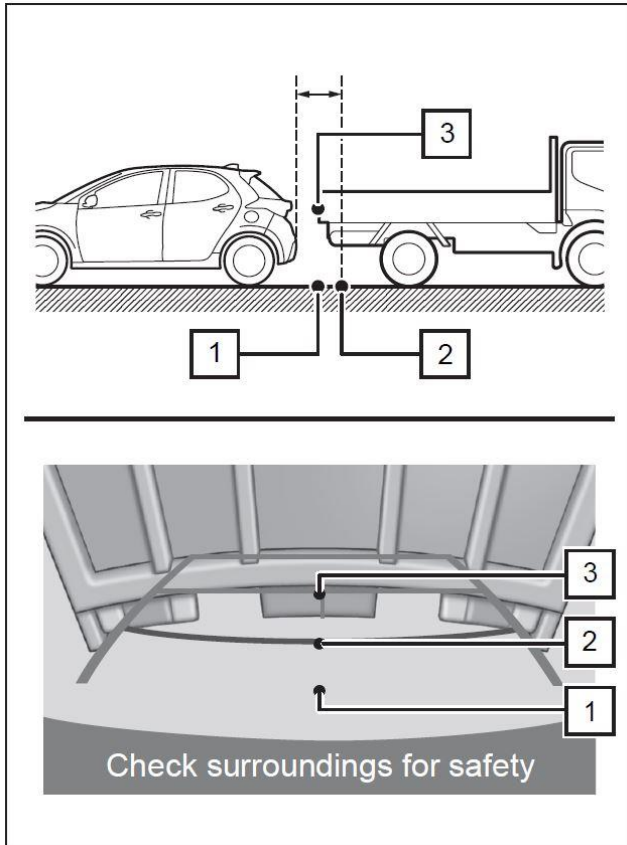

THINGS YOU SHOULD KNOW

If you notice any of the following symptoms, refer to the likely cause and the solution, and re-check.

If the symptom is not resolved by the solution, have the vehicle inspected by your Toyota dealer or another duly qualified and equipped professional.

Symptom	Likely cause	Solution
The image is difficult to see	<ul style="list-style-type: none"> - The vehicle is in a dark area - The temperature around the lens is either high or low - The outside temperature is low - There are water droplets on the camera - It is raining or humid foreign matter (mud etc.) is adhering to the camera - Sunlight or headlights are 	Back up while visually checking the vehicle's surroundings. (Use the monitor again once conditions have been improved.)

	shining directly into the camera - The vehicle is under fluorescent lights, sodium lights, mercury lights etc.	
The image is blurry	Dirt or foreign matter (such as water droplets, snow, mud etc.) is adhering to the camera.	Flush the camera with a large quantity of water and wipe the camera lens clean with a soft and wet cloth.
The image is out of alignment	The camera or surrounding area has received a strong impact.	Have the vehicle inspected by your Toyota dealer or another duly qualified and equipped professional.
The fixed guide lines are very far out of alignment	The camera position is out of alignment.	Have the vehicle inspected by your Toyota dealer or another duly qualified and equipped professional.
	- The vehicle is tilted (there is a heavy load on the vehicle, tyre pressure is low due to a tyre puncture, etc.) - The vehicle is used on an incline.	If this happens due to these causes, it does not indicate a malfunction. Back up while visually checking the vehicle's surroundings.

9 SOFTWARE UPDATES

Toyota Smart Connect supports Over-The-Air software updates to ensure the device is up-to-date with latest features and improvements.

NOTE:

In order to use the Over-The-Air software update function, connectivity should be available.

9.1 OVERVIEW

The system will automatically check for updates. When a new update is available, a popup will be shown.

[NEW_UPDATE_POPUP]

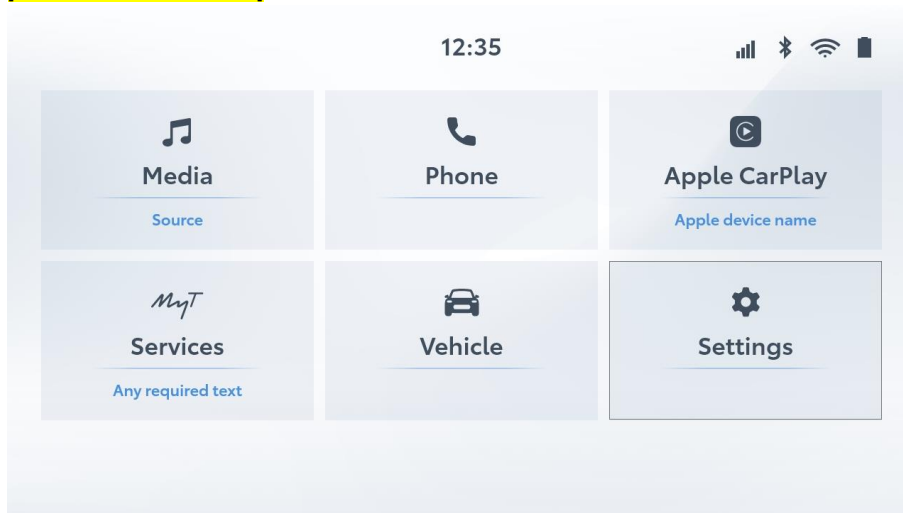

NOTE:

Automatic checks for updates are disabled when privacy mode is enabled.

Press "Install now" to proceed to the software update menu to start the installation. To postpone the update, press "Later".

9.2 CHECKING FOR UPDATES MANUALLY

To check for software updates manually, follow the next steps:

1. Touch the  icon on the HOME screen.
2. Touch the tab "System" if you are in any tab different from system.

[SETTINGS_SYSTEM]

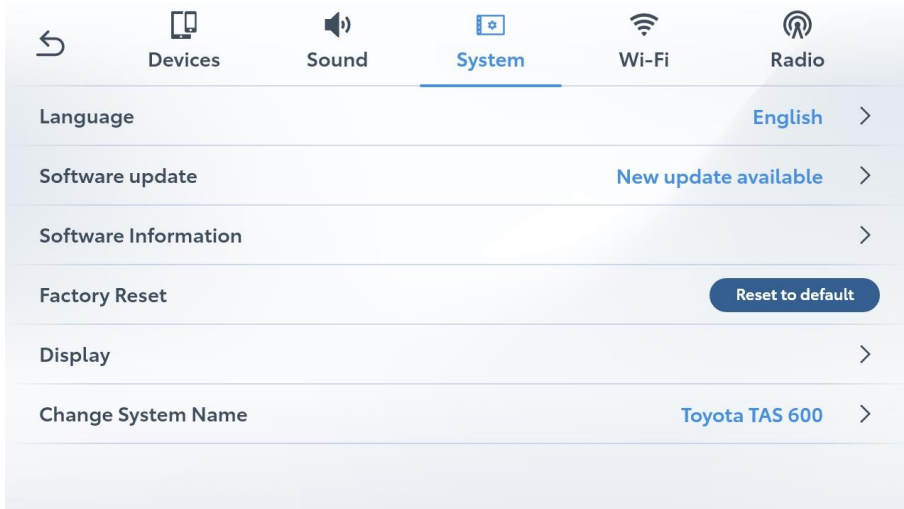

3. Touch “Software update” to access the software update screen.

[SYSTEM_SW_UPDATE]

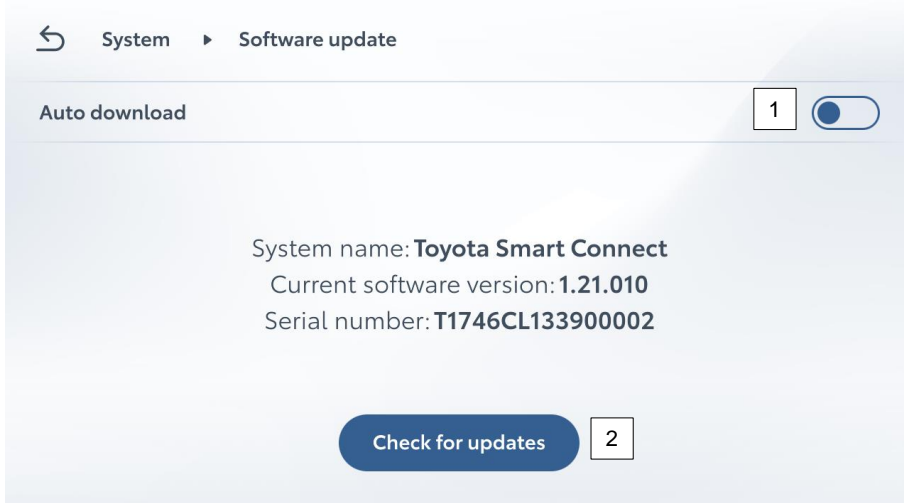

1	Enable to automatically download a new software update when available. The system will still request confirmation before starting installation of the update.
2	Check for new software updates manually.

9.3 INSTALLING THE SOFTWARE UPDATE

DOWNLOADING THE UPDATE

Before installing the software update, the software package must be downloaded.

If a software update package is available, following screen will be displayed:

[SYSTEM_SW_UPDATE_DOWNLOAD]

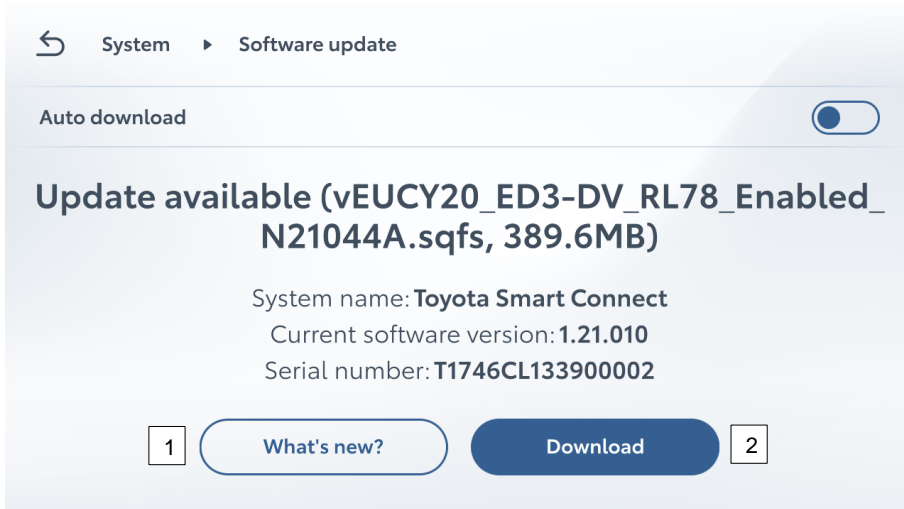

1	Learn about the update details (version, download size and changes)
2	Start download process

During the download, the system can still be used. A popup will appear when the download is completed.

[SYSTEM_SW_UPDATE_DOWNLOAD_POPUP]

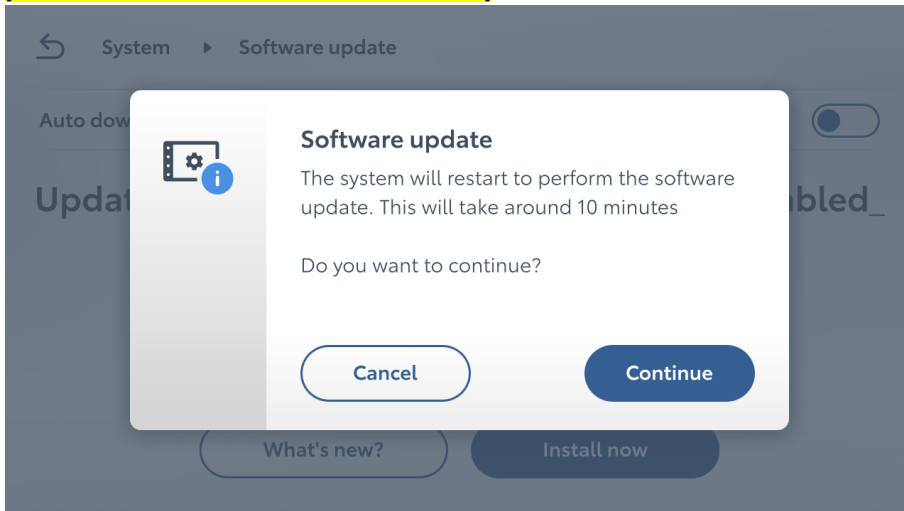

Press "Install now" to proceed to the software update menu to start the installation. To postpone the installation, press "Later".

INSTALLING THE UPDATE

NOTE:

During the installation, the system cannot be used. The installation takes around 10min. This may vary based on the update content.

CAUTION:

Do not turn off the engine during the software update to avoid draining the vehicle battery.

When the software update is ready to be installed, the following screen will be displayed:

[SYSTEM_SW_UPDATE_INSTALL]

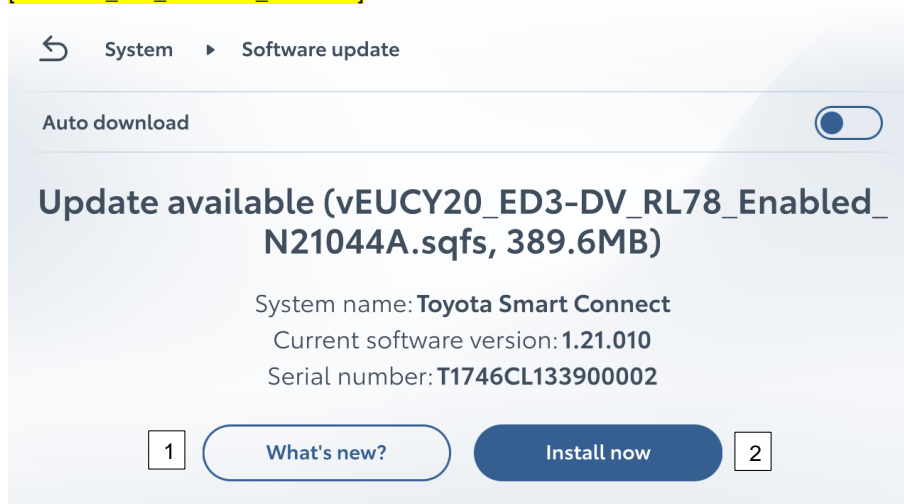

1	Learn about the update details (version, download size and changes)
2	Start the installation

To start the installation, ensure the ignition is turned ON. After installation is completed, the system will restart.

10 CERTIFICATION

RADIO EQUIPMENT DIRECTIVE – DECLARATION OF CONFORMITY

English:

Hereby, Harman Becker Automotive Systems GmbH declares that the radio equipment type **CY20 DA UPPER and CY20 DA LOWER** is in compliance with Directive 2014/53/EU. The full text of the EU declaration of conformity is available at the following internet Address: (*1)

Bulgarian:

С настоящото Harman Becker Automotive Systems GmbH декларира, че този тип радиосъоръжение **CY20 DA UPPER and CY20 DA LOWER** е в съответствие с Директива 2014/53/ЕС. Цялостният текст на ЕС декларацията за съответствие може да се намери на следния интернет адрес: (*1)

Spanish:

Por la presente, Harman Becker Automotive Systems GmbH declara que el tipo de equipo radioeléctrico **CY20 DA UPPER and CY20 DA LOWER** es conforme con la Directiva 2014/53/UE. El texto completo de la declaración UE de conformidad está disponible en la dirección Internet siguiente: (*1)

Czech:

Tímto Harman Becker Automotive Systems GmbH prohlašuje, že typ rádiového zařízení **CY20 DA UPPER AND CY20 DA LOWER** je v souladu se směrnicí 2014/53/EU. Úplné znění EU prohlášení o shodě je k dispozici na této internetové adrese: (*1)

Danish:

Hermed erklærer Harman Becker Automotive Systems GmbH, at radioudstyrstypen **CY20 DA UPPER AND CY20 DA LOWER** er i overensstemmelse med direktiv 2014/53/EU. EU-overensstemmelseserklæringens fulde tekst kan findes på følgende internetadresse: (*1)

German:

Hiermit erklärt Harman Becker Automotive Systems GmbH, dass das Gerät mit Funkfunktion **CY20 DA UPPER AND CY20 DA LOWER** der Richtlinie 2014/53/EU entspricht. Der vollständige Text der EU-Konformitätserklärung ist unter der folgenden Internetadresse verfügbar: (*1)

Estonian:

Käesolevaga deklareerib Harman Becker Automotive Systems GmbH, et käesolev raadioseadme tüüp **CY20 DA UPPER AND CY20 DA LOWER** vastab direktiivi 2014/53/EL nõuetele. ELi vastavusdeklaratsiooni täielik tekst on kättesaadav järgmisel internetiaadressil: (*1)

Greek:

Με την παρούσα ο/η Harman Becker Automotive Systems GmbH, δηλώνει ότι ο ραδιοεξοπλισμός **CY20 DA UPPER AND CY20 DA LOWER** πληροί την οδηγία 2014/53/ΕΕ.

Το πλήρες κείμενο της δήλωσης συμμόρφωσης ΕΕ διατίθεται στην ακόλουθη ιστοσελίδα στο διαδίκτυο: (*1)

French:

Le soussigné, Harman Becker Automotive Systems GmbH, déclare que l'équipement radioélectrique du type **CY20 DA UPPER AND CY20 DA LOWER** est conforme à la directive 2014/53/UE. Le texte complet de la déclaration UE de conformité est disponible à l'adresse internet suivante: (*1)

Croatian:

Harman Becker Automotive Systems GmbH ovime izjavljuje da je radijska oprema tipa **CY20 DA UPPER AND CY20 DA LOWER** u skladu s Direktivom 2014/53/EU. Cjeloviti tekst EU izjave o sukladnosti dostupan je na sljedećoj internetskoj adresi: (*1)

Italian:

Il fabbricante, Harman Becker Automotive Systems GmbH, dichiara che il tipo di apparecchiatura radio **CY20 DA UPPER AND CY20 DA LOWER** è conforme alla direttiva 2014/53/UE. Il testo completo della dichiarazione di conformità UE è disponibile al seguente indirizzo Internet: (*1)

Latvian:

Ar šo Harman Becker Automotive Systems GmbH deklarē, ka radioiekārta **CY20 DA UPPER AND CY20 DA LOWER** atbilst Direktīvai 2014/53/ES. Pilns ES atbilstības deklarācijas teksts ir pieejams šādā interneta vietnē: (*1)

Lithuanian:

Aš, Harman Becker Automotive Systems GmbH, patvirtinu, kad radijo įrenginių tipas **CY20 DA UPPER AND CY20 DA LOWER** atitinka Direktyvą 2014/53/ES. Visas ES atitikties deklaracijos tekstas prieinamas šiuo interneto adresu: (*1)

Hungarian:

Harman Becker Automotive Systems GmbH igazolja, hogy a **CY20 DA UPPER AND CY20 DA LOWER** típusú rádióberendezés megfelel a 2014/53/EU irányelvnek. Az EU-megfelelőségi nyilatkozat teljes szövege elérhető a következő internetes címen: 2014.5.22. L 153/104 Az Európai Unió Hivatalos Lapja HU: (*1)

Maltese:

B'dan, Harman Becker Automotive Systems GmbH, niddikjara li dan it-tip ta' tagħmir tar-radju **CY20 DA UPPER AND CY20 DA LOWER** huwa konformi mad-Direttiva 2014/53/UE. It-test kollu tad-dikjarazzjoni ta' konformità tal-UE huwa disponibbli f'dan l-indirizz tal-Internet li ġej: (*1)

Dutch:

Hierbij verklaar ik, Harman Becker Automotive Systems GmbH, dat het type radioapparatuur **CY20 DA UPPER AND CY20 DA LOWER** conform is met Richtlijn 2014/53/EU. De volledige tekst van de EU-conformiteitsverklaring kan worden geraadpleegd op het volgende internetadres: (*1)

Polish:

Harman Becker Automotive Systems GmbH niniejszym oświadcza, że typ urządzenia radiowego **CY20 DA UPPER AND CY20 DA LOWER** jest zgodny z dyrektywą 2014/53/UE. Pełny tekst deklaracji zgodności UE jest dostępny pod następującym adresem internetowym: (*1)

Portuguese:

O(a) abaixo assinado(a) Harman Becker Automotive Systems GmbH declara que o presente tipo de equipamento de rádio **CY20 DA UPPER AND CY20 DA LOWER** está em conformidade com a Diretiva 2014/53/UE. O texto integral da declaração de conformidade está disponível no seguinte endereço de Internet: (*1)

Romanian:

Prin prezenta, Harman Becker Automotive Systems GmbH declară că tipul de echipamente radio **CY20 DA UPPER AND CY20 DA LOWER** este în conformitate cu Directiva 2014/53/UE. Textul integral al declarației UE de conformitate este disponibil la următoarea adresă internet: (*1)

Slovak:

Harman Becker Automotive Systems GmbH týmto vyhlasuje, že rádiové zariadenie typu **CY20 DA UPPER AND CY20 DA LOWER** je v súlade so smernicou 2014/53/EÚ. Úplné EÚ vyhlásenie o zhode je k dispozícii na tejto internetovej adrese: (*1)

Slovenian:

Harman Becker Automotive Systems GmbH potrjuje, da je tip radijske opreme **CY20 DA UPPER AND CY20 DA LOWER** skladen z Direktivo 2014/53/EU. Celotno besedilo izjave EU o skladnosti je na voljo na naslednjem spletnem naslovu: (*1)

Finnish:

Harman Becker Automotive Systems GmbH vakuuttaa, että radiolaitetyyppi **CY20 DA UPPER AND CY20 DA LOWER** on direktiivin 2014/53/EU mukainen. EU-vaatimustenmukaisuusvakuutuksen täysimittainen teksti on saatavilla seuraavassa internetosoitteessa: (*1)

Swedish:

Härmed försäkras Harman Becker Automotive Systems GmbH att denna typ av radioutrustning **CY20 DA UPPER AND CY20 DA LOWER** överensstämmer med direktiv 2014/53/EU. Den fullständiga texten till EU-försäkran om överensstämmelse finns på följande webbadress: (*1)

Address: (*1)



(*1) <http://www.harman.com/compliance>

Bluetooth: 2400 - 2483,5 MHz <10 dBm

WLAN: 2400 - 2483,5 MHz <20 dBm
WLAN: 5725 - 5875 MHz <20 dBm

Manufacturer:

Harman Becker Automotive Systems GmbH
Becker-Goering-Strasse 16
76307 Karlsbad,
Germany

BLUETOOTH

Bluetooth approval for **CY20 DA UPPER** and **CY20 DA LOWER**



Bluetooth®
Qualified Design
ID number D051790

FCC § 15.19 Labelling requirements

This device complies with part 15 of the FCC Rules and Innovation, Science and Economic Development Canada (ISED) license-exempt RSS standard(s). Operation is subject to the following two conditions:

- (1) This device may not cause harmful interference, and
- (2) this device must accept any interference received, including interference that may cause undesired operation.

FCC § 15.21 Information to user

Changes or modifications not expressly approved by the party responsible for compliance could void the user's authority to operate the equipment.

- For a Class B digital device or peripheral, the instructions furnished to the user shall include the following or similar statement, placed in a prominent location in the text of the manual:

NOTE: This equipment has been tested and found to comply with the limits for a Class B digital device, pursuant to part 15 of the FCC Rules. These limits are designed to provide reasonable protection against harmful interference in a residential installation. This equipment generates, uses and can radiate radio frequency energy and, if not installed and used in accordance with the instructions, may cause harmful interference to radio communications. However, there is no guarantee that interference will not occur in a particular installation. If this equipment does cause harmful interference to radio or television reception, which can be determined by turning the equipment off and on, the user is encouraged to try to correct the interference by one or more of the following measures:

- Reorient or relocate the receiving antenna.*
- Increase the separation between the equipment and receiver.*
- Connect the equipment into an outlet on a circuit different from that to which the receiver is connected.*
- Consult the dealer or an experienced radio/TV technician for help.*

RF Exposure Requirements

To comply with FCC RF exposure compliance requirements, the device must be installed to provide a separation distance of at least 20 cm from all persons.

ISED CANADA Statements

Le présent appareil est conforme aux CNR d' Innovation, Sciences et Développement économique Canada applicables aux appareils radio exempts de licence. L'exploitation est autorisée aux deux conditions suivantes : (1) l'appareil ne doit pas produire de brouillage, et (2) l'utilisateur de l'appareil doit accepter tout brouillage radioélectrique subi, même si le brouillage est susceptible d'en compromettre le fonctionnement.

RF Exposure Requirements

This equipment complies with Canada radiation exposure limits set forth for an uncontrolled environment. This equipment should be installed and operated with minimum distance 20cm between the radiator and your body.

Déclaration d'exposition aux radiations:

Cet équipement est conforme aux limites d'exposition aux rayonnements du Canada établies pour un environnement non contrôlé. Cet équipement doit être installé et utilisé avec un minimum de 20 cm de distance entre la source de rayonnement et votre corps.

*The mentioned statements and paragraphs in this document will be placed in a prominent location in the final user manual.