

## FCC / ISED RF Test Report

**Report No.:** FCC\_IC\_RF\_SL21022601-HAR-284\_R1 INT NA 3B\_5G\_Rev 1.0

**FCC ID:** 2AHPN-BE2862

**ISED ID:** 6434C-BE2862

**Model:** R1 INT NA 3B MY22

**Received Date:** 3/15/2021

**Test Date:** 4/15/2021-7/8/2021

**Issued Date:** 8/22/2021

**Applicant:** HARMAN INTERNATIONAL

**Address:** 30001 Cabot Drive, Novi, MI 48377, USA

**Manufacturer:** HARMAN INTERNATIONAL

**Address:** 30001 Cabot Drive, Novi, MI 48377, USA

**Issued By:** Bureau Veritas Consumer Products Services, Inc.

**Lab Address:** 775 Montague Expressway, Milpitas, CA 95035, USA

**FCC Test Site Reg No.:** 540430

**ISED# / CAB identifier:** 4842D



This report is for your exclusive use. Any copying or replication of this report to or for any other person or entity, or use of our name or trademark, is permitted only with our prior written permission. This report sets forth our findings solely with respect to the test samples identified herein. The results set forth in this report are not indicative or representative of the quality or characteristics of the lot from which a test sample was taken or any similar or identical product unless specifically and expressly noted. Our report includes all of the tests requested by you and the results thereof based upon the information that you provided to us. You have 60 days from date of issuance of this report to notify us of any material error or omission caused by our negligence, provided, however, that such notice shall be in writing and shall specifically address the issue you wish to raise. A failure to raise such issue within the prescribed time shall constitute your unqualified acceptance of the completeness of this report, the tests conducted and the correctness of the report contents. Unless specific mention, the uncertainty of measurement has been explicitly taken into account to declare the compliance or non-compliance to the specification. The report must not be used by the client to claim product certification, approval, or endorsement by A2LA or any government agencies.

## Table of Contents

<b>Release Control Record .....</b>	<b>4</b>
<b>1 Certificate of Conformity .....</b>	<b>5</b>
<b>2 Summary of Test Results .....</b>	<b>6</b>
2.1 Measurement Uncertainty.....	6
2.2 Modification Record.....	6
<b>3 General Information .....</b>	<b>7</b>
3.1 General Description of EUT .....	7
3.2 Description of Operation Modes .....	8
3.2.1 Test Mode Applicability and Tested Channel Detail .....	10
3.3 Description of Support Units .....	11
3.3.1 Duty Cycle of Test Signal .....	12
3.4 General Description of Applied Standard .....	14
<b>4 Test Types and Results .....</b>	<b>15</b>
4.1 Antenna Requirement.....	15
4.2 Radiated Emission and Bandedge Measurement .....	16
4.2.1 Limits of Radiated Emission Measurement .....	16
4.2.2 Test Instruments .....	17
4.2.3 Test Procedure.....	17
4.2.4 Deviation from Test Standard .....	18
4.2.5 Test Setup.....	19
4.2.6 EUT Operating Condition .....	19
4.2.7 Test Results .....	20
4.3 Transmit Power Measurement.....	51
4.3.1 Limits of Transmit Power Measurement .....	<b>Error! Bookmark not defined.</b>
4.3.2 Test Setup.....	52
4.3.3 Test Instruments .....	52
4.3.4 Test Procedure.....	52
4.3.5 Deviation from Test Standard .....	53
4.3.6 EUT Operating Condition .....	53
4.3.7 Test Results .....	54
4.4 26dB Bandwidth & 6dB Bandwidth Measurement.....	56
4.4.1 Limits of 6 dB Bandwidth Measurement .....	56
4.4.2 Test Setup.....	56
4.4.3 Test Instruments .....	56
4.4.4 Test Procedure.....	56
4.4.5 Test Results .....	57
4.5 Peak Power Spectral Density Measurement.....	72
4.5.1 Limits of Peak Power Spectral Density Measurement.....	<b>Error! Bookmark not defined.</b>
4.5.2 Test Setup.....	<b>Error! Bookmark not defined.</b>
4.5.3 Test Instruments .....	<b>Error! Bookmark not defined.</b>
4.5.4 Test Procedure.....	<b>Error! Bookmark not defined.</b>
4.5.5 Deviation from Test Standard .....	<b>Error! Bookmark not defined.</b>
4.5.6 EUT Operating Condition .....	<b>Error! Bookmark not defined.</b>
4.5.7 Test Results .....	<b>Error! Bookmark not defined.</b>
4.6 Frequency Stability Measurement .....	89
4.6.1 Limits of Frequency Stability Measurement .....	89
4.6.2 Test Setup.....	89
4.6.3 Test Instruments .....	89
4.6.4 Test Procedure.....	89
4.6.5 Deviation from Test Standard .....	89
4.6.6 EUT Operating Condition .....	89
4.6.7 Test Results .....	90

<b>5</b>	<b>Pictures of Test Arrangements.....</b>	<b>91</b>
	<b>Appendix – Information on the Testing Laboratories .....</b>	<b>92</b>



### Release Control Record

Issue No.	Description	Date Issued
FCC_RF_SL21022601-HAR-284_5G	Original release	7/9/2021
FCC_IC_RF_SL21022601-HAR-284_R1 INT NA 3B_5G_Rev 1.0	Update Section 4.3, 4.4, 4.5	8/22/2021

## 1 Certificate of Conformity

**Product:** Automotive Infotainment Unit

**Brand:** HARMAN

**Model:** R1 INT NA 3B MY22

**Sample Status:** Final Product

**Applicant:** HARMAN INTERNATIONAL

**Test Date:** 4/15/2021-7/9/2021

**Standard:** 47 CFR FCC Part 15, Subpart E (Section 15.407)  
RSS-247 Issue 2 (2017-02)  
RSS-Gen Issue 5 (2019-03)  
789033 D02 General UNII Test Procedures New Rules v02r01  
ANSI C63.10:2013

The above equipment has been tested by **Bureau Veritas Consumer Products Services, Inc. Milpitas Branch**, and found compliance with the requirement of the above standards. The test record, data evaluation & Equipment Under Test (EUT) configurations represented herein are true and accurate accounts of the measurements of the sample's EMC characteristics under the conditions specified in this report.

**Prepared by :**  , **Date:** 8/22/2021  
Jude Semana / Test Engineer

**Approved by :** Gary Chou , **Date:** 8/22/2021  
Gary Chou/ Engineer Reviewer

## 2 Summary of Test Results

47 CFR FCC Part 15, Subpart E (Section 15.407), RSS-247 ; RSS-Gen				
Standard Section		Test Item	Result	Remarks
15.203		Antenna Requirement	Pass	Antenna connector is PCB. (The device is professionally installed)
15.407 (b)(6)	RSS-Gen 8.8	AC Power Conducted Emissions	N/A	N/A
15.407 (b)(1/2/3/4(i/ii)/6)	RSS-247	Radiated Emissions & Band Edge Measurement	Pass	Meet the requirement of limit.
15.407 (a)(1/2/3)	RSS-247	Max Average Transmit Power	Pass	Meet the requirement of limit.
-	RSS-Gen 6.6	Occupied Bandwidth	Pass	Meet the requirement of limit.
15.407 (e)	RSS-247	6 dB Emission Bandwidth	Pass	Meet the requirement of limit. (U-NII-3 only)
15.407 (a)(1/2/3)	RSS-247	Peak Power Spectral Density	Pass	Meet the requirement of limit.
15.407(g)		Frequency Stability	Pass	Meet the requirement of limit.

Note: The EUT is DC powered.

### 2.1 Measurement Uncertainty

Where relevant, the following measurement uncertainty levels have been estimated for tests performed on the EUT as specified in CISPR 16-4-2:

Measurement	Frequency	Expanded Uncertainty (k=2) (±)
Conducted Emissions at mains ports	150kHz ~ 30MHz	3.51dB
Radiated Emissions up to 1 GHz	30MHz ~ 1GHz	3.73dB
Radiated Emissions above 1 GHz	1GHz ~ 6GHz	4.64dB
	6GHz ~ 18GHz	4.82dB
	18GHz ~ 40GHz	4.91dB

### 2.2 Modification Record

There were no modifications required for compliance.

### 3 General Information

#### 3.1 General Description of EUT

Product	Automotive Infotainment Unit
Brand	HARMAN
Test Model	R1 INT NA 3B MY22
Status of EUT	Final Product
Power Supply Rating	12Vdc
Modulation Type	256QAM, 64QAM, 16QAM, QPSK, BPSK for OFDM
Modulation Technology	DSSS, OFDM
Transfer Rate	802.11a: up to 54Mbps 802.11n: up to 300Mbps 802.11ac: up to 433Mbps
Operating Frequency	5180~5240MHz, 5745~5825MHz
Number of Channel	5180~5240MHz: 4 channels for 802.11a, 802.11n,11ac (20MHz) 2 channels for 802.11n,11ac (40MHz) 1 channel for 802.11ac (80MHz) 5745~5825MHz: 5 channels for 802.11a, 802.11n,11ac (20MHz) 2 channels for 802.11n,11ac (40MHz) 1 channel for 802.11ac (80MHz)
Antenna Type	PCB Antenna 5180~5240MHz: 2.65 dBi 5745~5825MHz: 1.51 dBi
Antenna Connector	U.FL

Note:

1. The EUT provides one completed transmitter and one receiver.

Modulation Mode	Tx Function
802.11a	1TX
802.11n	1TX
802.11ac	1TX

### 3.2 Description of Operation Modes

#### FOR 5180 ~ 5240MHz

4 channels are provided for 802.11a, 802.11n (20MHz), 802.11ac(20MHz):

Channel	Frequency	Channel	Frequency
36	5180 MHz	44	5220 MHz
40	5200 MHz	48	5240 MHz

2 channels are provided for, 802.11n (40MHz), 802.11 ac (40MHz):

Channel	Frequency	Channel	Frequency
38	5190 MHz	46	5230 MHz

1 channels are provided for, 802.11ac (80MHz):

Channel	Frequency	Channel	Frequency
38	5210 MHz	-	-

#### FOR 5745 ~ 5825MHz:

5 channels are provided for 802.11a, 802.11n (20MHz), 802.11ac (20MHz):

Channel	Frequency	Channel	Frequency
149	5745MHz	161	5805MHz
153	5765MHz	165	5825MHz
157	5785MHz		

2 channels are provided for 802.11n (40MHz), 802.11ac(40MHz):

Channel	Frequency	Channel	Frequency
151	5755MHz	159	5795MHz

1 channels are provided for 802.11ac(80MHz):

Channel	Frequency	Channel	Frequency
155	5775MHz	--	--



Power setting is as below:

802.11a		802.11n, ac(20MHz)	
Channel	Power Setting	Channel	Power Setting
36	9	36	9
40	9	40	9
48	9	48	9
149	9	149	9
157	9	157	9
165	9	165	9
802.11n, ac(40MHz)		802.11ac(80MHz)	
Channel	Power Setting	Channel	Power Setting
38	9	38	
46	9	155	
151	9	48	
159	9	-	-

1. The above EUT information is declared by manufacturer and for more detailed features description, please refer to the manufacturer's specifications or user's manual.

### 3.2.1 Test Mode Applicability and Tested Channel Detail

EUT Configure Mode	Applicable To				Description
	RE $\geq$ 1G	RE<1G	PLC	APCM	
A	√	√	-	√	Powered 12Vdc Battery

Where **RE $\geq$ 1G**: Radiated Emission above 1GHz      **RE<1G**: Radiated Emission below 1GHz  
**PLC**: Power Line Conducted Emission      **APCM**: Antenna Port Conducted Measurement

**NOTE:**

1. The EUT had been pre-tested on the positioned of each 3 axis. The worst case was found when positioned on **X-plane**.
2. "-" means no effect.

#### **Radiated Emission Test (Above 1GHz):**

- Pre-Scan has been conducted to determine the worst-case mode from all possible combinations between available modulations, data rates and antenna ports (if EUT with antenna diversity architecture).
- Following channel(s) was (were) selected for the final test as listed below.

EUT Configure Mode	Mode	FREQ. Band (MHz)	Available Channel	Tested Channel	Modulation Technology	Modulation Type
-	802.11a	5180-5240	36 to 48	36, 40, 48	OFDM	BPSK
-	802.11n (HT20)		36 to 48	36, 40, 48	OFDM	BPSK
-	802.11n (HT40)		38 to 46	38, 46	OFDM	BPSK
-	802.11ac (VHT80)		42	42	OFDM	BPSK
-	802.11a	5745-5825	149 to 165	149, 157, 165	OFDM	BPSK
-	802.11n (HT20)		149 to 165	149, 157, 165	OFDM	BPSK
-	802.11n (HT40)		151 to 159	151, 159	OFDM	BPSK
-	802.11ac (VHT80)		155	155	OFDM	BPSK

#### **Radiated Emission Test (Below 1GHz):**

- Pre-Scan has been conducted to determine the worst-case mode from all possible combinations between available modulations, data rates and antenna ports (if EUT with antenna diversity architecture).
- Following channel(s) was (were) selected for the final test as listed below.

EUT Configure Mode	Mode	FREQ. Band (MHz)	Available Channel	Tested Channel	Modulation Technology	Modulation Type
-	802.11a	5180-5320	36 to 64	40	OFDM	BPSK
-	802.11a	5745-5825	149 to 165	157	OFDM	BPSK

**Power Line Conducted Emission Test:**

- Pre-Scan has been conducted to determine the worst-case mode from all possible combinations between available modulations, data rates and antenna ports (if EUT with antenna diversity architecture).
- Following channel(s) was (were) selected for the final test as listed below.

EUT Configure Mode	Mode	FREQ. Band (MHz)	Available Channel	Tested Channel	Modulation Technology	Modulation Type
-	802.11a	5180-5320	36 to 64	62	OFDM	BPSK
-	802.11a	5745-5825	149 to 165	149	OFDM	BPSK

**Antenna Port Conducted Measurement:**

- This item includes all test value of each mode, but only includes spectrum plot of worst value of each mode.
- Pre-Scan has been conducted to determine the worst-case mode from all possible combinations between available modulations, data rates and antenna ports (if EUT with antenna diversity architecture).
- Following channel(s) was (were) selected for the final test as listed below.

EUT Configure Mode	Mode	FREQ. Band (MHz)	Available Channel	Tested Channel	Modulation Technology	Modulation Type
-	802.11a	5180-5240	36 to 48	36, 40, 48	OFDM	BPSK
-	802.11n (HT20)		36 to 48	36, 40, 48	OFDM	BPSK
-	802.11ac (VHT20)		36 to 48	36, 40, 48	OFDM	BPSK
-	802.11n (HT40)		38 to 46	38, 46	OFDM	BPSK
-	802.11ac (VHT40)		38 to 46	38, 46	OFDM	BPSK
-	802.11ac (VHT80)		42	42	OFDM	BPSK
-	802.11a	5745-5825	149 to 165	149, 157, 165	OFDM	BPSK
-	802.11n (HT20)		149 to 165	149, 157, 165	OFDM	BPSK
-	802.11ac (VHT20)		149 to 165	149, 157, 165	OFDM	BPSK
-	802.11n (HT40)		151 to 159	151, 159	OFDM	BPSK
-	802.11ac (VHT40)		151 to 159	151, 159	OFDM	BPSK
-	802.11ac (VHT80)		155	155	OFDM	BPSK

**Test Condition:**

Applicable To	Environmental Conditions	Input Power	Tested By
RE≥1G	25deg. C, 65%RH	12Vdc	Jude Semana
RE<1G	25deg. C, 65%RH	12Vdc	Jude Semana
APCM	21deg. C, 60%RH	12Vdc	Jude Semana

**3.3 Description of Support Units**

The EUT has been tested as an independent unit together with other necessary accessories or support units. The following support units or accessories were used to form a representative test configuration during the tests.

ID	Product	Brand	Model No.	Serial No.	FCC ID	Remarks
A.	Laptop	Acer	Aspire 3	N/A	N/A	Provided by Lab

ID	Descriptions	Qty.	Length (m)	Shielding (Yes/No)	Cores (Qty.)	Remarks
1.	USB	1	1m	No	0	Connect from EUT to Laptop

### 3.3.1 Duty Cycle of Test Signal

#### **MODULATION TYPE: BPSK**

If Duty cycle of test signal is < 98 %, duty factor is required.

802.11a: Duty cycle = 73.82%

802.11n (HT20): Duty cycle = 76.64%

802.11n (HT40): Duty cycle = 76.64%

802.11ac (VHT20): Duty cycle = 73.95%

802.11ac (VHT40): Duty cycle = 64.44%

802.11ac (VHT80): Duty cycle = 50.41%



### **3.4 General Description of Applied Standard**

The EUT is a RF Product. According to the specifications of the manufacturer, it must comply with the requirements of the following standards:

**47 CFR FCC Part 15, Subpart E (Section 15.407)**

**Canada RSS-247 Issue 2 (2017-02)**

**Canada RSS-Gen Issue 5 (2019-03)**

**789033 D02 General UNII Test Procedures New Rules v02r01**

**ANSI C63.10:2013**

All test items have been performed and recorded as per the above standards.

#### 4 Test Types and Results

##### 4.1 Antenna Requirement

Spec	Requirement	Applicable
15.203	<p>An intentional radiator shall be designed to ensure that no antenna other than that furnished by the responsible party shall be used with the device.</p> <p>Antenna requirement must meet at least one of the following:</p> <ul style="list-style-type: none"> <li>a) Antenna must be permanently attached to the device.</li> <li>b) The antenna must use a unique type of connector to attach to the device.</li> <li>c) Device must be professionally installed. The installer shall be responsible for ensuring that the correct antenna is employed by the device.</li> </ul>	<input checked="" type="checkbox"/>
Remark	The EUT uses a PCB antenna	
Result	<input checked="" type="checkbox"/> PASS <input type="checkbox"/> FAIL	

## 4.2 Radiated Emission and Bandedge Measurement

### 4.2.1 Limits of Radiated Emission Measurement

Radiated emissions which fall in the restricted bands must comply with the radiated emission limits specified as below table.

Frequencies (MHz)	Field Strength (microvolts/meter)	Measurement Distance (meters)
0.009 ~ 0.490	2400/F(kHz)	300
0.490 ~ 1.705	24000/F(kHz)	30
1.705 ~ 30.0	30	30
30 ~ 88	100	3
88 ~ 216	150	3
216 ~ 960	200	3
Above 960	500	3

**NOTE:**

- The lower limit shall apply at the transition frequencies.
- Emission level (dBuV/m) = 20 log Emission level (uV/m).
- For frequencies above 1000MHz, the field strength limits are based on average detector, however, the peak field strength of any emission shall not exceed the maximum permitted average limits, specified above by more than 20dB under any condition of modulation.

Limits of unwanted emission out of the restricted bands

Applicable To		Limit	
789033 D02 General UNII Test Procedure New Rules v02r01		Field Strength at 3m	
		PK:74 (dBµV/m)	AV:54 (dBµV/m)
Frequency Band	Applicable To	EIRP Limit	Equivalent Field Strength at 3m
5150~5250 MHz	15.407(b)(1)	PK:-27 (dBm/MHz)	PK:68.2(dBµV/m)
5250~5350 MHz	15.407(b)(2)		
5470~5725 MHz	15.407(b)(3)		
5725~5850 MHz	<input checked="" type="checkbox"/> 15.407(b)(4)(i)	PK:-27 (dBm/MHz) <sup>*1</sup> PK:10 (dBm/MHz) <sup>*2</sup> PK:15.6 (dBm/MHz) <sup>*3</sup> PK:27 (dBm/MHz) <sup>*4</sup>	PK: 68.2(dBµV/m) <sup>*1</sup> PK:105.2 (dBµV/m) <sup>*2</sup> PK: 110.8(dBµV/m) <sup>*3</sup> PK:122.2 (dBµV/m) <sup>*4</sup>
	<input type="checkbox"/> 15.407(b)(4)(ii)	Emission limits in section 15.247(d)	
*1 beyond 75 MHz or more above of the band edge.		*2 below the band edge increasing linearly to 10 dBm/MHz at 25 MHz above.	
*3 below the band edge increasing linearly to a level of 15.6 dBm/MHz at 5 MHz above.		*4 from 5 MHz above or below the band edge increasing linearly to a level of 27 dBm/MHz at the band edge.	

**Note:**

The following formula is used to convert the equipment isotropic radiated power (eirp) to field strength:

$$E = \frac{1000000 \sqrt{30P}}{3} \mu\text{V/m, where P is the eirp (Watts).}$$



#### 4.2.2 Test Instruments

DESCRIPTION & MANUFACTURER	MODEL NO.	SERIAL NO.	DATE OF CALIBRATION	DUE DATE OF CALIBRATION
EMI Receiver , Rohde and Schwarz	ESW44	1328.4100K-1016 62-MH	10/23/2020	10/23/2021
Biconilog Antenna , Sunol	JB6	A111717	9/4/2020	9/4/2021
Horn Antenna , ETS-Lindgren	3117	218554	7/24/2020	7/24/2021
Pre-Amplifier , RF-Lambda	RAMP00M50GA	18040300055	10/1/2020	10/1/2021
Spectrum Analyzer, Keysight	N9030B	MY57140597	06/15/2020	06/15/2021
Environmental Chamber, Micro Precision	Test Equity 1007H	61201	12/16/2020	12/16/2021

#### 4.2.3 Test Procedure

##### For Radiated emission below 30MHz

- The EUT was placed on the top of a rotating table 0.8 meters above the ground at a 3 meter chamber room. The table was rotated 360 degrees to determine the position of the highest radiation.
- The EUT was set 3 meters away from the interference-receiving antenna, which was mounted on the top of a variable-height antenna tower.
- Parallel, perpendicular, and ground-parallel orientations of the antenna are set to make the measurement.
- For each suspected emission, the EUT was arranged to its worst case and the rotatable table was turned from 0 degrees to 360 degrees to find the maximum reading.
- The test-receiver system was set to Quasi-Peak Detect Function and Specified Bandwidth with Maximum Hold Mode.

##### NOTE:

- The resolution bandwidth and video bandwidth of test receiver/spectrum analyzer is 9kHz at frequency below 30MHz.

##### For Radiated emission above 30MHz

- The EUT was placed on the top of a rotating table 0.8 meters (for 30MHz ~ 1GHz) / 1.5 meters (for above 1GHz) above the ground at 3 meter chamber room for test. The table was rotated 360 degrees to determine the position of the highest radiation.
- The EUT was set 3 meters away from the interference-receiving antenna, which was mounted on the top of a variable-height antenna tower.
- The height of antenna is varied from one meter to four meters above the ground to determine the maximum value of the field strength. Both horizontal and vertical polarizations of the antenna are set to make the measurement.
- For each suspected emission, the EUT was arranged to its worst case and then the antenna was tuned to heights from 1 meter to 4 meters and the rotatable table was turned from 0 degrees to 360 degrees to find the maximum reading.
- The test-receiver system was set to quasi-peak detect function and specified bandwidth with maximum hold mode when the test frequency is below 1 GHz.
- The test-receiver system was set to peak and average detects function and specified bandwidth with maximum hold mode when the test frequency is above 1 GHz. If the peak reading value also meets

average limit, measurement with the average detector is unnecessary.

**Note:**

1. The resolution bandwidth and video bandwidth of test receiver/spectrum analyzer is 120kHz for Quasi-peak detection (QP) at frequency below 1GHz.
2. The resolution bandwidth of test receiver/spectrum analyzer is 1 MHz and the video bandwidth is 3 MHz for Peak detection (PK) at frequency above 1GHz.
3. The resolution bandwidth of test receiver/spectrum analyzer is 1MHz and the video bandwidth is  $\geq 1/T$  (Duty cycle  $< 98\%$ ) or 10Hz (Duty cycle  $\geq 98\%$ ) for Average detection (AV) at frequency above 1GHz.
4. All modes of operation were investigated and the worst-case emissions are reported.

**For Band edge Measurement**

789033 D02 General U-NII Test Procedures New Rules v02r01, II.F. Method SA-1

1. For average emissions measurements, follow the procedures described in section II.G.6., "Procedures for Average Unwanted Emissions Measurements above 1000 MHz", except for the following changes:
2. Set RBW=100 kHz
3. Set VBW=300 kHz
4. Perform a band-power integration across the 1 MHz bandwidth in which the band-edge emission level is to be measured.

4.2.4 Deviation from Test Standard

No deviation.

#### 4.2.5 Test Setup

##### For Radiated emission 30MHz to 1GHz

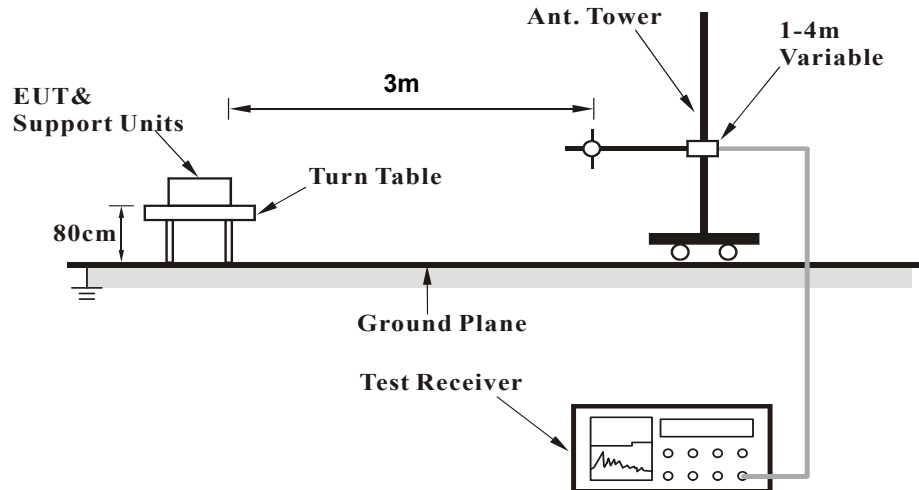

##### For Radiated emission above 1GHz

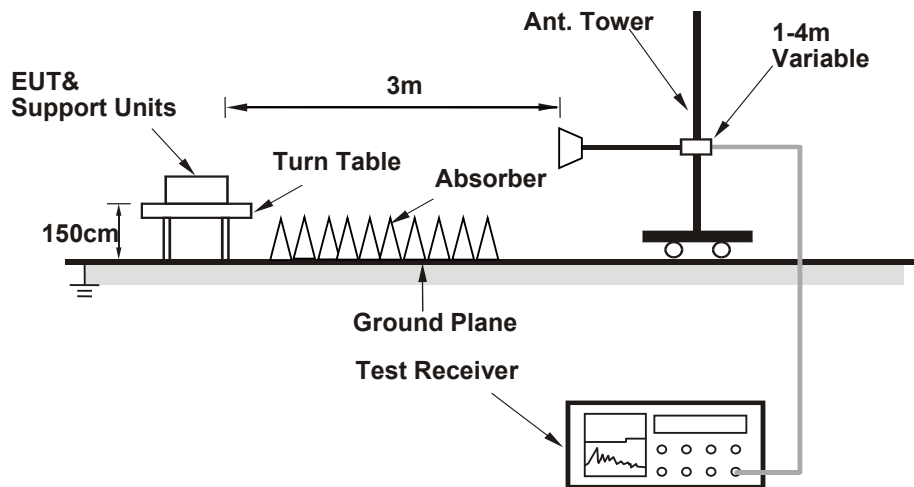

For the actual test configuration, please refer to the attached file (Test Setup Photo).

#### 4.2.6 EUT Operating Condition

- a. Placed the EUT on the testing table.
- b. Prepared notebooks to act as communication partner and placed it outside of testing area.
- c. The communication partner connected with EUT via a USB cable and ran a test program (provided by manufacturer) to enable EUT under transmission condition continuously at specific channel frequency.
- d. The necessary accessories enable the system in full functions.

#### 4.2.7 Test Results

##### Below 1GHz Worst-Case Data:

<b>CHANNEL</b>	802.11n Channel 40	<b>DETECTOR FUNCTION</b>	Quasi Peak
<b>FREQUENCY RANGE</b>	30MHz – 1GHz		

Antenna Polarity & Test Distance: Vertical and Horizontal at 3m										
No.	Frequency (MHz)	Polarization (H/V)	Reading QP [dB(uV)]	Factor [dB(1/m)]	Level QP [dB(uV/m)]	LimitQP dB(uV/m)	Margin QP [dB]	Height (cm)	Angle (Deg)	Pass/Fail
1	40.151	V	11.8	18.4	30.2	40	-9.8	105.7	348.5	Pass
2	111.474	V	18	18.7	36.7	43.5	-6.8	100	121.6	Pass
3	47.561	V	16.2	14	30.2	40	-9.8	114	184	Pass
4	247.444	H	15.8	18.3	34.1	46	-11.9	112	237.4	Pass
5	983.065	V	7	30.9	37.9	54	-16.1	100.3	333.6	Pass
6	711.885	H	3.6	28.4	32	46	-14	133.1	47.8	Pass

#### REMARKS:

1. Emission level (dBuV/m) = Raw Value (dBuV) + Cable Loss (dB) + AF (dB)
2. AF (dB/m) = Antenna Factor (dB/m) – Pre-amplifier Gain (dB).
3. Margin = Level (dBuV/m) - Limit value(dBuV/m)

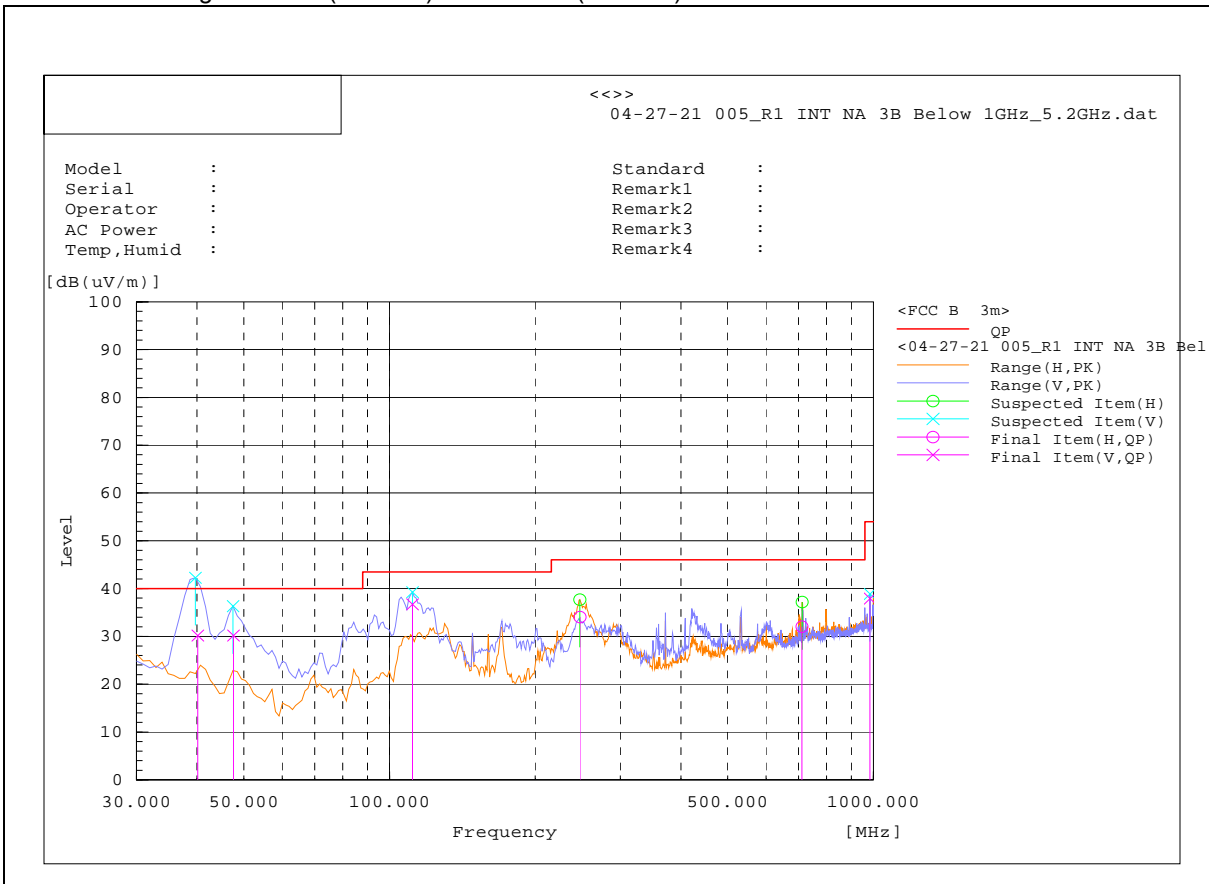

**Below 1GHz Worst-Case Data:**

<b>CHANNEL</b>	802.11ac Channel 157	<b>DETECTOR FUNCTION</b>	Quasi Peak
<b>FREQUENCY RANGE</b>	30MHz – 1GHz		

Antenna Polarity & Test Distance: Vertical and Horizontal at 3m										
No.	Frequency (MHz)	Polarization (H/V)	Reading QP [dB(uV)]	Factor [dB(1/m)]	Level QP [dB(uV/m)]	Limit\QP dB(uV/m)	Margin QP [dB]	Height (cm)	Angle (Deg)	Pass/Fail
1	40.962	V	14.4	17.9	32.3	40	-7.7	107.8	359.9	Pass
2	47.578	V	17.9	14	31.9	40	-8.1	100.2	187.5	Pass
3	128.733	V	5	19.6	24.6	43.5	-18.9	104.8	305.5	Pass
4	712.034	V	4.9	28.1	33	46	-13	100.5	358.7	Pass
5	248.391	H	15.2	18.3	33.5	46	-12.5	139.8	75.3	Pass
6	111.298	V	18	18.7	36.7	43.5	-6.8	108.8	136.3	Pass

**REMARKS:**

1. Emission level (dBuV/m) = Raw Value (dBuV) + Cable Loss (dB) + AF (dB)
2. AF (dB/m) = Antenna Factor (dB/m) – Pre-amplifier Gain (dB).
3. Margin = Level (dBuV/m) - Limit value(dBuV/m)

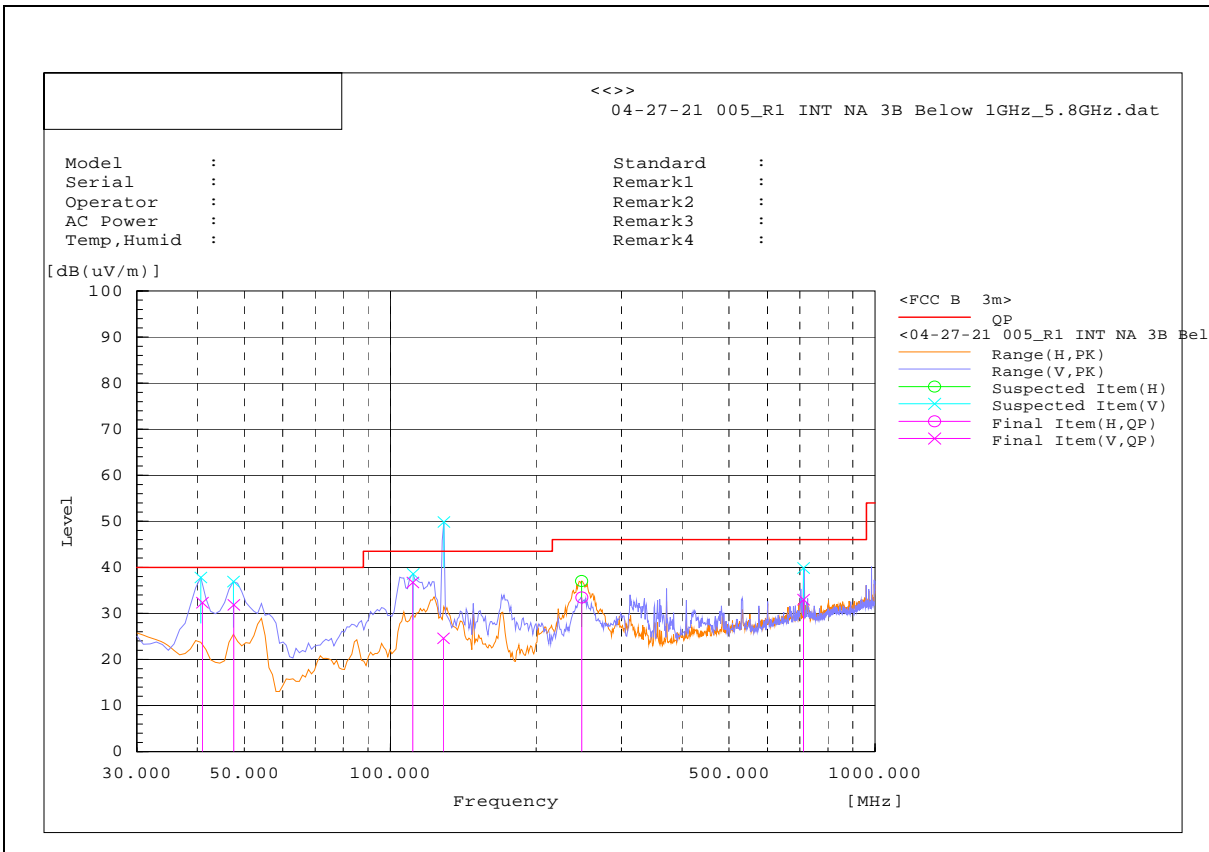

**Above 1GHz Test Data:**

1GHz-40GHz – 802.11a – 5180MHz

ANTENNA POLARITY & test distance: HORIZONTAL& Vertical at 3 m									
Frequency [MHz]	Pol	Reading [dB(uV)]	Factor [dB(1/m)]	Measurement Type	Level [dB(uV/m)]	Limit [dB(uV/m)]	Margin [dB]	Height [cm]	Angle [deg]
10362.15	V	40.8	5.1	Average	45.9	54	-8.1	162.4	151.6
15540.05	H	30.8	11.7	Average	42.5	54	-11.5	100.6	78.9
1943.888	V	42.4	-12.4	Average	30	54	-24	152.4	213.3
10362.15	V	54.6	5.1	Peak	59.7	74	-14.3	162.4	151.6
15540.05	H	44.1	11.7	Peak	55.8	74	-18.2	100.6	78.9
1943.888	V	62.6	-12.4	Peak	50.2	74	-23.8	152.4	213.3

1GHz-40GHz – 802.11a – 5200MHz

ANTENNA POLARITY & test distance: HORIZONTAL& Vertical at 3 m									
Frequency [MHz]	Pol	Reading [dB(uV)]	Factor [dB(1/m)]	Measurement Type	Level [dB(uV/m)]	Limit [dB(uV/m)]	Margin [dB]	Height [cm]	Angle [deg]
10401.18	H	42.6	5.2	Average	47.8	54	-6.2	173.6	314
15599.5	H	28.9	12	Average	40.9	54	-13.1	101.9	79.2
3191.595	V	37.9	-9.4	Average	28.5	54	-25.5	143.6	67.7
10401.18	H	54.5	5.2	Peak	59.7	74	-14.3	173.6	314
15599.5	H	42.3	12	Peak	54.3	74	-19.7	101.9	79.2
3191.595	V	56.4	-9.4	Peak	47	74	-27	143.6	67.7

1GHz-40GHz – 802.11a – 5240MHz

ANTENNA POLARITY & test distance: HORIZONTAL& Vertical at 3 m									
Frequency [MHz]	Pol	Reading [dB(uV)]	Factor [dB(1/m)]	Measurement Type	Level [dB(uV/m)]	Limit [dB(uV/m)]	Margin [dB]	Height [cm]	Angle [deg]
10483.18	H	44.6	5.3	Average	49.9	54	-4.1	128.1	35.3
15726.56	H	25.9	12.2	Average	38.1	54	-15.9	100.7	337.7
3196.291	V	38.1	-9.4	Average	28.7	54	-25.3	317.6	120.4
10483.18	H	58.6	5.3	Peak	63.9	74	-10.1	128.1	35.3
15726.56	H	40.2	12.2	Peak	52.4	74	-21.6	100.7	337.7
3196.291	V	56	-9.4	Peak	46.6	74	-27.4	317.6	120.4

1GHz-40GHz – 802.11n(HT20) – 5180MHz

ANTENNA POLARITY & test distance: HORIZONTAL& Vertical at 3 m									
Frequency [MHz]	Pol	Reading [dB(uV)]	Factor [dB(1/m)]	Measurement Type	Level [dB(uV/m)]	Limit [dB(uV/m)]	Margin [dB]	Height [cm]	Angle [deg]
10360.48	H	40.8	5.1	Average	45.9	54	-8.1	102.1	0.4
15533.85	H	26	11.6	Average	37.6	54	-16.4	104.3	72.5
2125.857	V	42.6	-12.5	Average	30.1	54	-23.9	163.5	2.3
10360.48	H	52.5	5.1	Peak	57.6	74	-16.4	16.4	102.1
15533.85	H	40.9	11.6	Peak	52.5	74	-21.5	21.5	104.3
2125.857	V	57.8	-12.5	Peak	45.3	74	-28.7	28.7	163.5

1GHz-40GHz – 802.11n(HT20) – 5200MHz

ANTENNA POLARITY & test distance: HORIZONTAL& Vertical at 3 m									
Frequency [MHz]	Pol	Reading [dB(uV)]	Factor [dB(1/m)]	Measurement Type	Level [dB(uV/m)]	Limit [dB(uV/m)]	Margin [dB]	Height [cm]	Angle [deg]
10404.43	H	44.6	5.2	Average	49.8	54	-4.2	131	77.1
2127.911	V	42	-12.5	Average	29.5	54	-24.5	192.4	11.9
6390.479	V	32.6	-2.5	Average	30.1	54	-23.9	163.9	282.7
10404.43	H	57.9	5.2	Peak	63.1	74	-10.9	131	77.1
2127.911	V	58.8	-12.5	Peak	46.3	74	-27.7	192.4	11.9
6390.479	V	45.1	-2.5	Peak	42.6	74	-31.4	163.9	282.7

1GHz-40GHz – 802.11n(HT20) – 5240MHz

ANTENNA POLARITY & test distance: HORIZONTAL& Vertical at 3 m									
Frequency [MHz]	Pol	Reading [dB(uV)]	Factor [dB(1/m)]	Measurement Type	Level [dB(uV/m)]	Limit [dB(uV/m)]	Margin [dB]	Height [cm]	Angle [deg]
10480.87	H	43.2	5.3	Average	48.5	54	-5.5	100.6	84.3
15719.01	H	26.7	12.2	Average	38.9	54	-15.1	107.6	39.5
2127.676	V	44.1	-12.5	Average	31.6	54	-22.4	121.7	208.4
10480.87	H	56.3	5.3	Peak	61.6	74	-12.4	100.6	84.3
15719.01	H	38.3	12.2	Peak	50.5	74	-23.5	107.6	39.5
2127.676	V	61.5	-12.5	Peak	49	74	-25	121.7	208.4

1GHz-40GHz – 802.11ac(VHT20) – 5180MHz

ANTENNA POLARITY & test distance: HORIZONTAL& Vertical at 3 m									
Frequency [MHz]	Pol	Reading [dB(uV)]	Factor [dB(1/m)]	Measurement Type	Level [dB(uV/m)]	Limit [dB(uV/m)]	Margin [dB]	Height [cm]	Angle [deg]
10361.53	H	45.4	5.1	Average	50.5	54	-3.5	100	79.1
3190.417	V	38.3	-9.4	Average	28.9	54	-25.1	128.7	300.6
2125.144	H	41.7	-12.5	Average	29.2	54	-24.8	214.4	178.5
10361.53	H	58.2	5.1	Peak	63.3	74	-10.7	100	79.1
3190.417	V	50.2	-9.4	Peak	40.8	74	-33.2	128.7	300.6
2125.144	H	55.5	-12.5	Peak	43	74	-31	214.4	178.5

1GHz-40GHz – 802.11ac(VHT20) – 5200MHz

ANTENNA POLARITY & test distance: HORIZONTAL& Vertical at 3 m									
Frequency [MHz]	Pol	Reading [dB(uV)]	Factor [dB(1/m)]	Measurement Type	Level [dB(uV/m)]	Limit [dB(uV/m)]	Margin [dB]	Height [cm]	Angle [deg]
10401.08	H	42.2	5.2	Average	47.4	54	-6.6	100.6	86.4
3187.281	V	38.3	-9.4	Average	28.9	54	-25.1	173.4	358.7
15611.61	H	25	12	Average	37	54	-17	136.4	353.2
10401.08	H	57.5	5.2	Peak	62.7	74	-11.3	100.6	86.4
3187.281	V	54.3	-9.4	Peak	44.9	74	-29.1	173.4	358.7
15611.61	H	36.4	12	Peak	48.4	74	-25.6	136.4	353.2

1GHz-40GHz – 802.11ac(VHT20) – 5240MHz

ANTENNA POLARITY & test distance: HORIZONTAL& Vertical at 3 m									
Frequency [MHz]	Pol	Reading [dB(uV)]	Factor [dB(1/m)]	Measurement Type	Level [dB(uV/m)]	Limit [dB(uV/m)]	Margin [dB]	Height [cm]	Angle [deg]
10477.34	H	43.3	5.3	Average	48.6	54	-5.4	100.3	62
6997.648	V	31.2	-1.3	Average	29.9	54	-24.1	213.9	279
5243.438	H	37.2	-5.4	Average	31.8	54	-22.2	163.6	0
10477.34	H	56.6	5.3	Peak	61.9	74	-12.1	100.3	62
6997.648	V	43.3	-1.3	Peak	42	74	-32	213.9	279
5243.438	H	49.1	-5.4	Peak	43.7	74	-30.3	163.6	0



1GHz-40GHz – 802.11n(HT40) – 5190MHz

ANTENNA POLARITY & test distance: HORIZONTAL& Vertical at 3 m									
Frequency [MHz]	Pol	Reading [dB(uV)]	Factor [dB(1/m)]	Measurement Type	Level [dB(uV/m)]	Limit [dB(uV/m)]	Margin [dB]	Height [cm]	Angle [deg]
10387.42	H	39.9	5.1	Average	45	54	-9	122.4	72.3
3191.424	H	39.3	-9.4	Average	29.9	54	-24.1	199.5	251.2
4252.385	V	39	-7.4	Average	31.6	54	-22.4	111.2	239.2
10387.42	H	54.8	5.1	Peak	59.9	74	-14.1	122.4	72.3
3191.424	H	54.4	-9.4	Peak	45	74	-29	199.5	251.2
4252.385	V	51.1	-7.4	Peak	43.7	74	-30.3	111.2	239.2

1GHz-40GHz – 802.11n(HT40) – 5230MHz

ANTENNA POLARITY & test distance: HORIZONTAL& Vertical at 3 m									
Frequency [MHz]	Pol	Reading [dB(uV)]	Factor [dB(1/m)]	Measurement Type	Level [dB(uV/m)]	Limit [dB(uV/m)]	Margin [dB]	Height [cm]	Angle [deg]
10467.26	H	37.4	5.3	Average	42.7	54	-11.3	122.4	9.5
2126.489	V	48	-12.5	Average	35.5	54	-18.5	199.4	181.6
3198.828	V	38.5	-9.4	Average	29.1	54	-24.9	100.4	0
10467.26	H	50.8	5.3	Peak	56.1	74	-17.9	122.4	9.5
2126.489	V	64.5	-12.5	Peak	52	74	-22	199.4	181.6
3198.828	V	53.6	-9.4	Peak	44.2	74	-29.8	100.4	0

1GHz-40GHz – 802.11ac(VHT40) – 5190MHz

ANTENNA POLARITY & test distance: HORIZONTAL& Vertical at 3 m									
Frequency [MHz]	Pol	Reading [dB(uV)]	Factor [dB(1/m)]	Measurement Type	Level [dB(uV/m)]	Limit [dB(uV/m)]	Margin [dB]	Height [cm]	Angle [deg]
10378.56	H	40.9	5.1	Average	46	54	-8	111.1	65.1
3193.642	V	39.3	-9.4	Average	29.9	54	-24.1	146.3	193.5
6993.257	V	31	-1.3	Average	29.7	54	-24.3	101.9	287.2
10378.56	H	54.2	5.1	Peak	59.3	74	-14.7	111.1	65.1
3193.642	V	58.4	-9.4	Peak	49	74	-25	146.3	193.5
6993.257	V	43.8	-1.3	Peak	42.5	74	-31.5	101.9	287.2

1GHz-40GHz – 802.11ac(VHT40) – 5230MHz

ANTENNA POLARITY & test distance: HORIZONTAL& Vertical at 3 m									
Frequency [MHz]	Pol	Reading [dB(uV)]	Factor [dB(1/m)]	Measurement Type	Level [dB(uV/m)]	Limit [dB(uV/m)]	Margin [dB]	Height [cm]	Angle [deg]
3191.83	V	42.6	-9.4	Average	33.2	54	-20.8	128.3	181.7
10458.52	H	35.2	5.3	Average	40.5	54	-13.5	131.5	4.4
2127.276	V	42.1	-12.5	Average	29.6	54	-24.4	76.1	358.3
3191.83	V	57.2	-9.4	Peak	47.8	74	-26.2	128.3	181.7
10458.52	H	49.7	5.3	Peak	55	74	-19	131.5	4.4
2127.276	V	62.1	-12.5	Peak	49.6	74	-24.4	76.1	358.3

1GHz-40GHz – 802.11ac(VHT80) – 5210MHz

ANTENNA POLARITY & test distance: HORIZONTAL& Vertical at 3 m									
Frequency [MHz]	Pol	Reading [dB(uV)]	Factor [dB(1/m)]	Measurement Type	Level [dB(uV/m)]	Limit [dB(uV/m)]	Margin [dB]	Height [cm]	Angle [deg]
10438.85	H	35.5	5.3	Average	40.8	54	-13.2	143.7	307.5
3188.218	V	39.4	-9.4	Average	30	54	-24	144.1	174
1752.188	V	42.2	-14.5	Average	27.7	54	-26.3	195.5	356.8
10438.85	H	46.7	5.3	Peak	52	74	-22	143.7	307.5
3188.218	V	57.4	-9.4	Peak	48	74	-26	144.1	174
1752.188	V	60	-14.5	Peak	45.5	74	-28.5	195.5	356.8

1GHz-40GHz – 802.11a – 5745MHz

ANTENNA POLARITY & test distance: HORIZONTAL& Vertical at 3 m									
Frequency [MHz]	Pol	Reading [dB(uV)]	Factor [dB(1/m)]	Measurement Type	Level [dB(uV/m)]	Limit [dB(uV/m)]	Margin [dB]	Height [cm]	Angle [deg]
11497.6	H	34.4	6.1	Average	40.5	54	-13.5	122.6	104.8
2125.35	V	46.6	-12.5	Average	34.1	54	-19.9	200	175.9
3194.587	V	37.8	-9.4	Average	28.4	54	-25.6	199.3	359.9
11497.6	H	48.1	6.1	Peak	54.2	74	-19.8	122.6	104.8
2125.35	V	64.8	-12.5	Peak	52.3	74	-21.7	200	175.9
3194.587	V	53.5	-9.4	Peak	44.1	74	-29.9	199.3	359.9

1GHz-40GHz – 802.11a – 5785MHz

ANTENNA POLARITY & test distance: HORIZONTAL& Vertical at 3 m									
Frequency [MHz]	Pol	Reading [dB(uV)]	Factor [dB(1/m)]	Measurement Type	Level [dB(uV/m)]	Limit [dB(uV/m)]	Margin [dB]	Height [cm]	Angle [deg]
11569.25	H	37	6.2	Average	43.2	54	-10.8	111.7	11
2131.707	V	45.2	-12.5	Average	32.7	54	-21.3	183.2	178.8
3193.687	V	38.7	-9.4	Average	29.3	54	-24.7	100.9	235.7
11569.25	H	50.4	6.2	Peak	56.6	74	-17.4	111.7	11
2131.707	V	65.6	-12.5	Peak	53.1	74	-20.9	183.2	178.8
3193.687	V	52.3	-9.4	Peak	42.9	74	-31.1	100.9	235.7

1GHz-40GHz – 802.11a – 5825MHz

ANTENNA POLARITY & test distance: HORIZONTAL& Vertical at 3 m									
Frequency [MHz]	Pol	Reading [dB(uV)]	Factor [dB(1/m)]	Measurement Type	Level [dB(uV/m)]	Limit [dB(uV/m)]	Margin [dB]	Height [cm]	Angle [deg]
11647.2	H	37.5	6.2	Average	43.7	54	-10.3	100.4	103.5
2131.289	V	44.2	-12.5	Average	31.7	54	-22.3	107.9	205.2
3185.054	V	38.5	-9.4	Average	29.1	54	-24.9	188.1	175
11647.2	H	51	6.2	Peak	57.2	74	-16.8	100.4	103.5
2131.289	V	62	-12.5	Peak	49.5	74	-24.5	107.9	205.2
3185.054	V	59.2	-9.4	Peak	49.8	74	-24.2	188.1	175

1GHz-40GHz – 802.11n(HT20) – 5745MHz

ANTENNA POLARITY & test distance: HORIZONTAL& Vertical at 3 m									
Frequency [MHz]	Pol	Reading [dB(uV)]	Factor [dB(1/m)]	Measurement Type	Level [dB(uV/m)]	Limit [dB(uV/m)]	Margin [dB]	Height [cm]	Angle [deg]
11490.78	H	38.8	6.1	Average	44.9	54	-9.1	102	324.4
3196.536	V	40.5	-9.4	Average	31.1	54	-22.9	130.7	351.5
2120.864	V	41.7	-12.5	Average	29.2	54	-24.8	108.8	95.1
11490.78	H	51.9	6.1	Peak	58	74	-16	102	324.4
3196.536	V	57.9	-9.4	Peak	48.5	74	-25.5	130.7	351.5
2120.864	V	52.1	-12.5	Peak	39.6	74	-34.4	108.8	95.1

1GHz-40GHz – 802.11n(HT20) – 5785MHz

ANTENNA POLARITY & test distance: HORIZONTAL& Vertical at 3 m									
Frequency [MHz]	Pol	Reading [dB(uV)]	Factor [dB(1/m)]	Measurement Type	Level [dB(uV/m)]	Limit [dB(uV/m)]	Margin [dB]	Height [cm]	Angle [deg]
11571.06	H	39.3	6.2	Average	45.5	54	-8.5	100.5	80.6
3197.386	V	39.9	-9.4	Average	30.5	54	-23.5	146.6	262.4
2127.511	V	43	-12.5	Average	30.5	54	-23.5	135.6	181
11571.06	H	52.4	6.2	Peak	58.6	74	-15.4	100.5	80.6
3197.386	V	54	-9.4	Peak	44.6	74	-29.4	146.6	262.4
2127.511	V	63.3	-12.5	Peak	50.8	74	-23.2	135.6	181

1GHz-40GHz – 802.11n(HT20) – 5825MHz

ANTENNA POLARITY & test distance: HORIZONTAL& Vertical at 3 m									
Frequency [MHz]	Pol	Reading [dB(uV)]	Factor [dB(1/m)]	Measurement Type	Level [dB(uV/m)]	Limit [dB(uV/m)]	Margin [dB]	Height [cm]	Angle [deg]
11651.17	H	40.1	6.2	Average	46.3	54	-7.7	100.6	72.6
2124.02	V	45.7	-12.5	Average	33.2	54	-20.8	121.5	352.6
3185.601	V	38.3	-9.4	Average	28.9	54	-25.1	196.1	0
11651.17	H	52.3	6.2	Peak	58.5	74	-15.5	100.6	72.6
2124.02	V	61.3	-12.5	Peak	48.8	74	-25.2	121.5	352.6
3185.601	V	54.3	-9.4	Peak	44.9	74	-29.1	196.1	0

1GHz-40GHz – 802.11ac(VHT20) – 5745MHz

ANTENNA POLARITY & test distance: HORIZONTAL& Vertical at 3 m									
Frequency [MHz]	Pol	Reading [dB(uV)]	Factor [dB(1/m)]	Measurement Type	Level [dB(uV/m)]	Limit [dB(uV/m)]	Margin [dB]	Height [cm]	Angle [deg]
11491.57	H	38.9	6.1	Average	45	54	-9	107.3	81.6
2127.412	V	44.6	-12.5	Average	32.1	54	-21.9	0	0.3
3184.976	V	40	-9.4	Average	30.6	54	-23.4	199.4	235.4
11491.57	H	51.8	6.1	Peak	57.9	74	-16.1	107.3	81.6
2127.412	V	61.8	-12.5	Peak	49.3	74	-24.7	0	0.3
3184.976	V	57.4	-9.4	Peak	48	74	-26	199.4	235.4

1GHz-40GHz – 802.11ac(VHT20) – 5785MHz

ANTENNA POLARITY & test distance: HORIZONTAL& Vertical at 3 m									
Frequency [MHz]	Pol	Reading [dB(uV)]	Factor [dB(1/m)]	Measurement Type	Level [dB(uV/m)]	Limit [dB(uV/m)]	Margin [dB]	Height [cm]	Angle [deg]
11573.93	H	37.8	6.2	Average	44	54	-10	102	325.7
2129.693	V	43.2	-12.5	Average	30.7	54	-23.3	163	0
3197.657	V	37.4	-9.4	Average	28	54	-26	102	294.6
11573.93	H	50.9	6.2	Peak	57.1	74	-16.9	102	325.7
2129.693	V	60.9	-12.5	Peak	48.4	74	-25.6	163	0
3197.657	V	51.8	-9.4	Peak	42.4	74	-31.6	102	294.6

1GHz-40GHz – 802.11ac(VHT20) – 5825MHz

ANTENNA POLARITY & test distance: HORIZONTAL& Vertical at 3 m									
Frequency [MHz]	Pol	Reading [dB(uV)]	Factor [dB(1/m)]	Measurement Type	Level [dB(uV/m)]	Limit [dB(uV/m)]	Margin [dB]	Height [cm]	Angle [deg]
11649.89	H	38.6	6.2	Average	44.8	54	-9.2	100	64
2127.202	V	44.3	-12.5	Average	31.8	54	-22.2	152.6	0
3186.34	V	38.2	-9.4	Average	28.8	54	-25.2	195.5	359.9
11649.89	H	50.6	6.2	Peak	56.8	74	-17.2	100	64
2127.202	V	61.4	-12.5	Peak	48.9	74	-25.1	152.6	0
3186.34	V	54.5	-9.4	Peak	45.1	74	-28.9	195.5	359.9

1GHz-40GHz – 802.11n(HT40) – 5755MHz

ANTENNA POLARITY & test distance: HORIZONTAL& Vertical at 3 m									
Frequency [MHz]	Pol	Reading [dB(uV)]	Factor [dB(1/m)]	Measurement Type	Level [dB(uV/m)]	Limit [dB(uV/m)]	Margin [dB]	Height [cm]	Angle [deg]
11517.36	H	34	6.1	Average	40.1	54	-13.9	102	322.6
2130.067	V	45.3	-12.5	Average	32.8	54	-21.2	143.7	182.3
1753.349	V	43.6	-14.5	Average	29.1	54	-24.9	101.9	359.9
11517.36	H	49.1	6.1	Peak	55.2	74	-18.8	102	322.6
2130.067	V	63.7	-12.5	Peak	51.2	74	-22.8	143.7	182.3
1753.349	V	61.9	-14.5	Peak	47.4	74	-26.6	101.9	359.9

1GHz-40GHz – 802.11n(HT40)– 5795MHz

ANTENNA POLARITY & test distance: HORIZONTAL& Vertical at 3 m									
Frequency [MHz]	Pol	Reading [dB(uV)]	Factor [dB(1/m)]	Measurement Type	Level [dB(uV/m)]	Limit [dB(uV/m)]	Margin [dB]	Height [cm]	Angle [deg]
11597.5	H	34.7	6.2	Average	40.9	54	-13.1	104.3	80.8
2128.295	V	46.2	-12.5	Average	33.7	54	-20.3	173.1	218.5
3187.608	V	38.3	-9.4	Average	28.9	54	-25.1	385.7	56.2
11597.5	H	50.2	6.2	Peak	56.4	74	-17.6	104.3	80.8
2128.295	V	62.4	-12.5	Peak	49.9	74	-24.1	173.1	218.5
3187.608	V	50.2	-9.4	Peak	40.8	74	-33.2	385.7	56.2

1GHz-40GHz – 802.11ac(VHT40) – 5755MHz

ANTENNA POLARITY & test distance: HORIZONTAL& Vertical at 3 m									
Frequency [MHz]	Pol	Reading [dB(uV)]	Factor [dB(1/m)]	Measurement Type	Level [dB(uV/m)]	Limit [dB(uV/m)]	Margin [dB]	Height [cm]	Angle [deg]
11508.98	H	34.7	6.1	Average	40.8	54	-13.2	121.9	75.4
1745.934	V	42.6	-14.5	Average	28.1	54	-25.9	107.6	34.2
3189.114	V	40.3	-9.4	Average	30.9	54	-23.1	135.9	252.4
11508.98	H	47.9	6.1	Peak	54	74	-20	121.9	75.4
1745.934	V	60.7	-14.5	Peak	46.2	74	-27.8	107.6	34.2
3189.114	V	60.3	-9.4	Peak	50.9	74	-23.1	135.9	252.4

1GHz-40GHz – 802.11ac(VHT40) – 5795MHz

ANTENNA POLARITY & test distance: HORIZONTAL& Vertical at 3 m									
Frequency [MHz]	Pol	Reading [dB(uV)]	Factor [dB(1/m)]	Measurement Type	Level [dB(uV/m)]	Limit [dB(uV/m)]	Margin [dB]	Height [cm]	Angle [deg]
11588.58	V	38.5	6.2	Average	44.7	54	-9.3	163.7	42.2
2124.411	V	44.3	-12.5	Average	31.8	54	-22.2	112.9	0
1247.215	V	45.3	-16.5	Average	28.8	54	-25.2	116.5	283.7
11588.58	V	48.2	6.2	Peak	54.4	74	-19.6	163.7	42.2
2124.411	V	61.5	-12.5	Peak	49	74	-25	112.9	0
1247.215	V	56.3	-16.5	Peak	39.8	74	-34.2	116.5	283.7

1GHz-40GHz – 802.11ac(VHT80) – 5775MHz

ANTENNA POLARITY & test distance: HORIZONTAL& Vertical at 3 m									
Frequency [MHz]	Pol	Reading [dB(uV)]	Factor [dB(1/m)]	Measurement Type	Level [dB(uV/m)]	Limit [dB(uV/m)]	Margin [dB]	Height [cm]	Angle [deg]
11566.72	H	34.6	6.2	Average	40.8	54	-13.2	111.5	99.2
2130.647	V	43.1	-12.5	Average	30.6	54	-23.4	104.6	0
3192.152	V	38.8	-9.4	Average	29.4	54	-24.6	138.5	34.8
11566.72	H	48.3	6.2	Peak	54.5	74	-19.5	111.5	99.2
2130.647	V	61.2	-12.5	Peak	48.7	74	-25.3	104.6	0
3192.152	V	54.7	-9.4	Peak	45.3	74	-28.7	138.5	34.8

**RESTRICTED BAND Test Plots**  
**802.11a – 5180MHz**

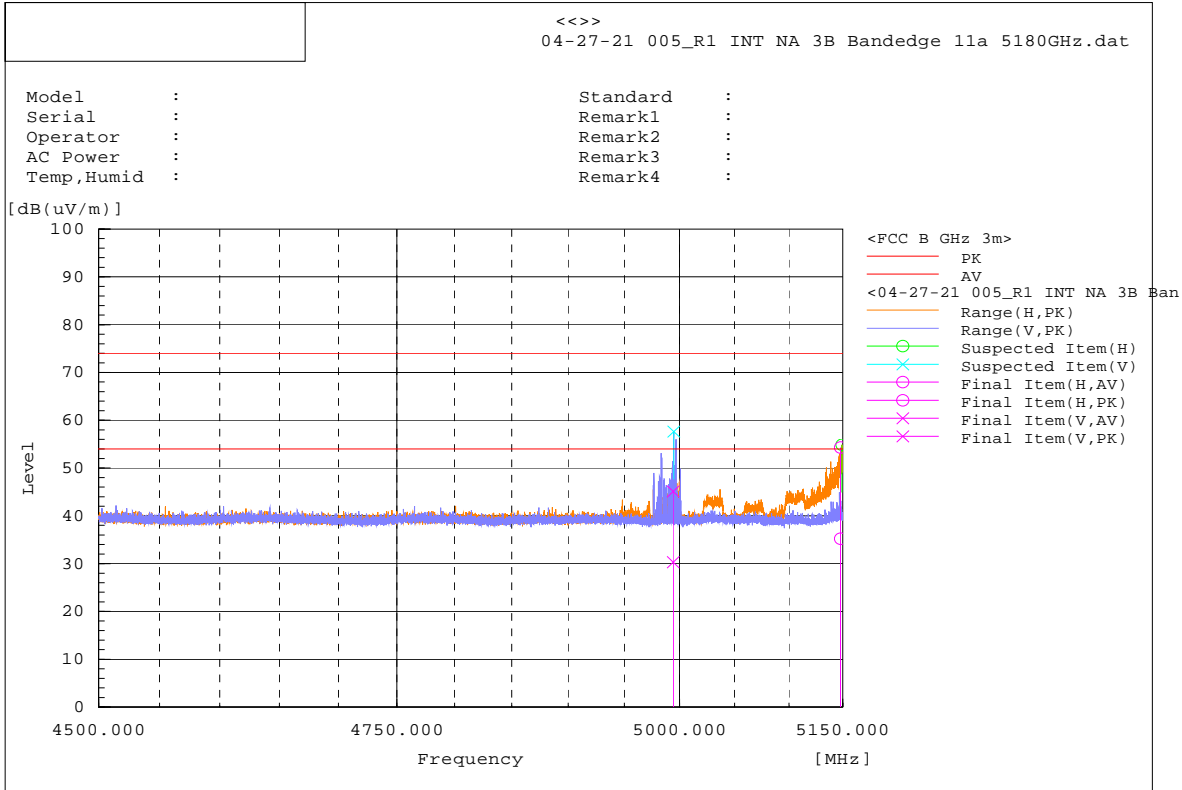

ANTENNA POLARITY & test distance: HORIZONTAL & Vertical at 3 m									
Frequency [MHz]	Pol	Reading [dB(uV)]	Factor [dB(1/m)]	Measurement Type	Level [dB(uV/m)]	Limit [dB(uV/m)]	Margin [dB]	Height [cm]	Angle [deg]
5148.035	H	40.9	-5.7	Average	35.2	54	-18.8	100.6	343.2
4994.072	V	36.1	-5.8	Average	30.3	54	-23.7	173.4	276.8
5148.035	H	60	-5.7	Average	54.3	74	-19.7	100.6	343.2
4994.072	V	50.9	-5.8	Peak	45.1	74	-28.9	173.4	276.8



**RESTRICTED BAND**  
**802.11n(HT20) – 5180MHz**

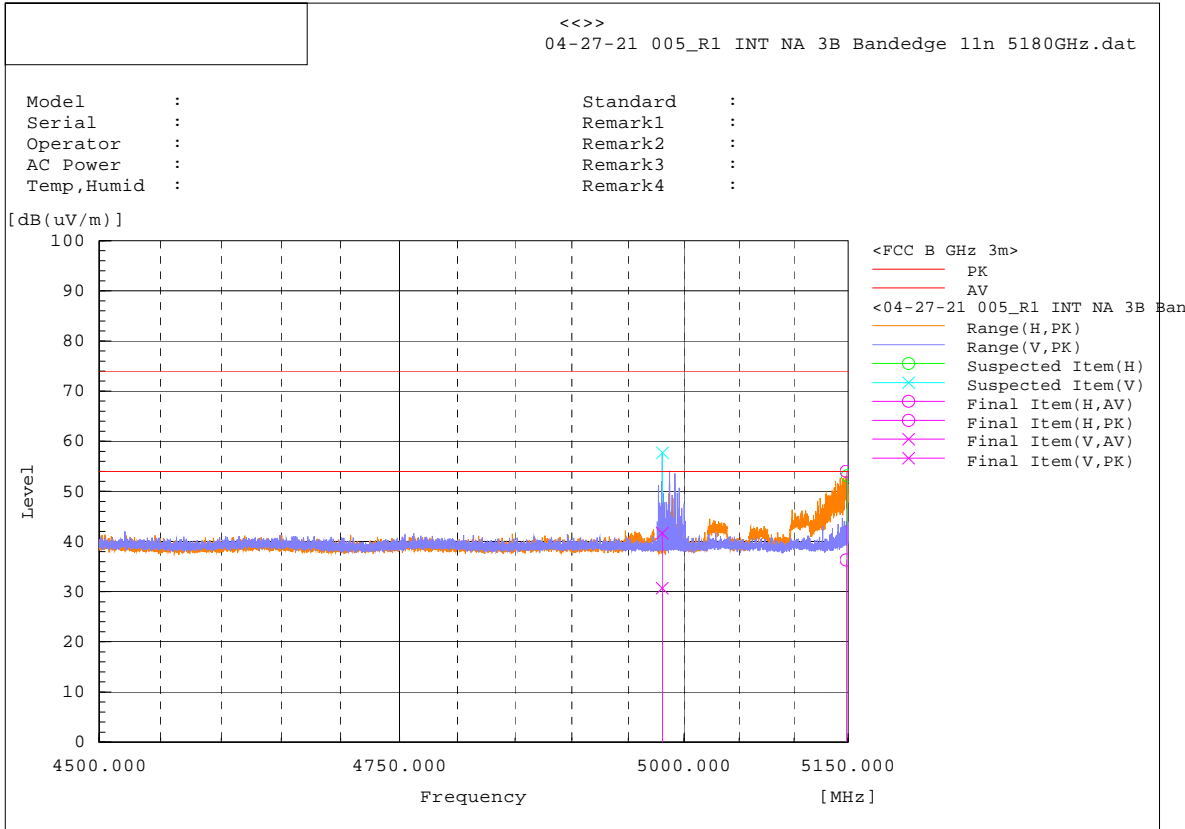

ANTENNA POLARITY & test distance: HORIZONTAL& Vertical at 3 m									
Frequency [MHz]	Pol	Reading [dB(uV)]	Factor [dB(1/m)]	Measurement Type	Level [dB(uV/m)]	Limit [dB(uV/m)]	Margin [dB]	Height [cm]	Angle [deg]
5148.208	H	42.1	-5.7	Average	36.4	54	-17.6	100	0.1
4980.3	V	36.6	-5.9	Average	30.7	54	-23.3	153	35.8
5148.208	H	59.7	-5.7	Average	54	74	-20	100	0.1
4980.3	V	47.6	-5.9	Peak	41.7	74	-32.3	153	35.8

**RESTRICTED BAND**  
**802.11ac(VHT20) – 5180MHz**

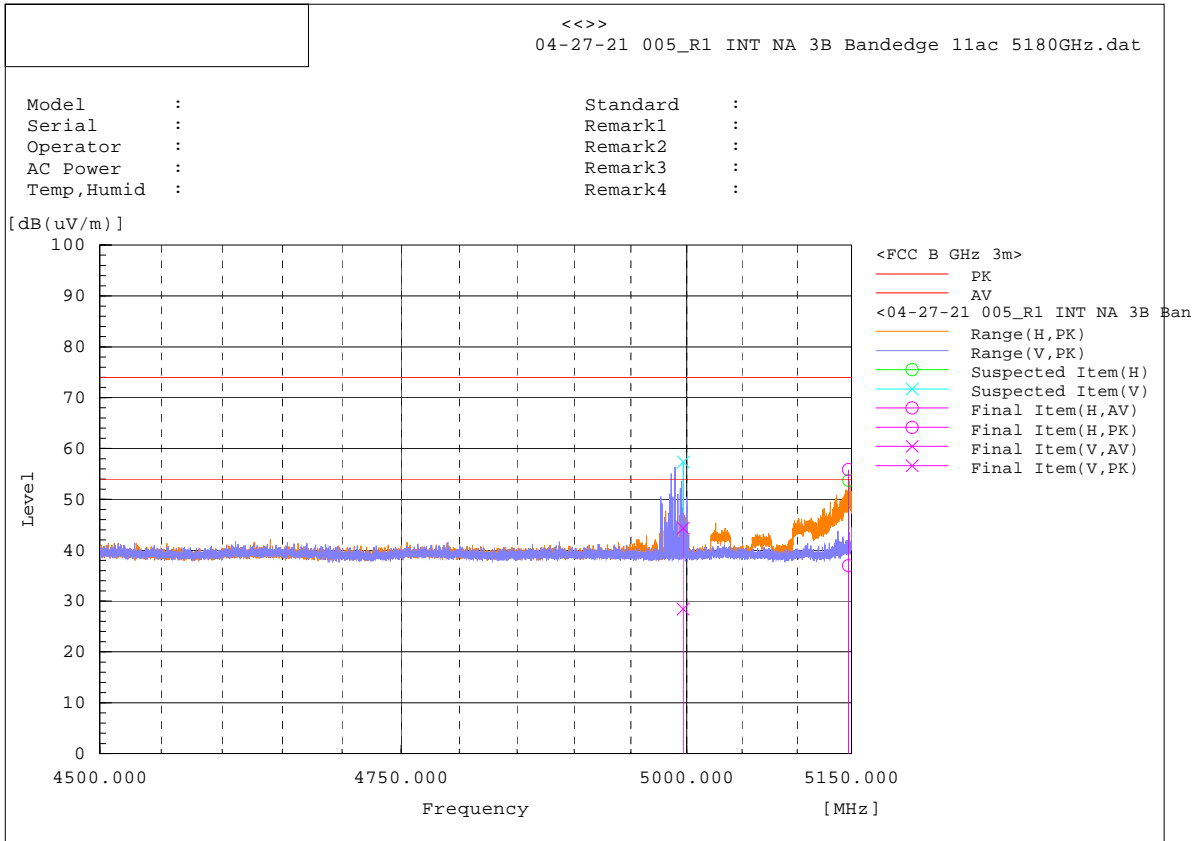

ANTENNA POLARITY & test distance: HORIZONTAL& Vertical at 3 m									
Frequency [MHz]	Pol	Reading [dB(uV)]	Factor [dB(1/m)]	Measurement Type	Level [dB(uV/m)]	Limit [dB(uV/m)]	Margin [dB]	Height [cm]	Angle [deg]
5147.25	H	42.7	-5.7	Average	37	54	-17	111.5	42.7
4996.676	V	34.2	-5.8	Average	28.4	54	-25.6	102.7	252.1
5147.25	H	61.5	-5.7	Average	55.8	74	-18.2	111.5	42.7
4996.676	V	50.2	-5.8	Peak	44.4	74	-29.6	102.7	252.1

**RESTRICTED BAND**  
**802.11n(HT40) – 5190MHz**

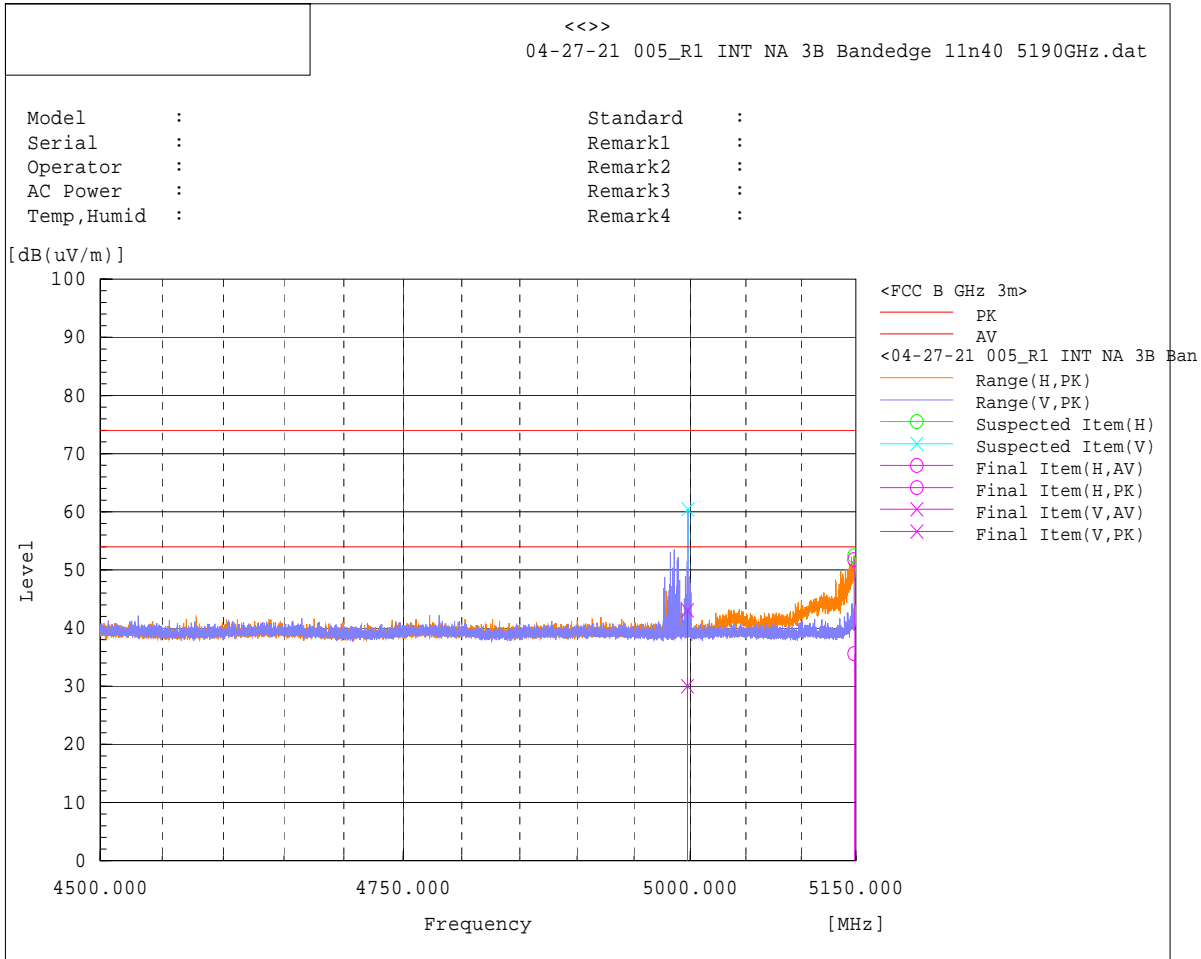

ANTENNA POLARITY & test distance: HORIZONTAL& Vertical at 3 m									
Frequency [MHz]	Pol	Reading [dB(uV)]	Factor [dB(1/m)]	Measurement Type	Level [dB(uV/m)]	Limit [dB(uV/m)]	Margin [dB]	Height [cm]	Angle [deg]
4997.488	V	35.8	-5.8	Average	30	54	-24	116.5	70
5148.314	H	41.3	-5.7	Average	35.6	54	-18.4	183.5	0
4997.488	V	48.9	-5.8	Average	43.1	74	-30.9	116.5	70
5148.314	H	57.5	-5.7	Peak	51.8	74	-22.2	183.5	0

**RESTRICTED BAND**  
**802.11ac(VHT40) – 5190MHz**

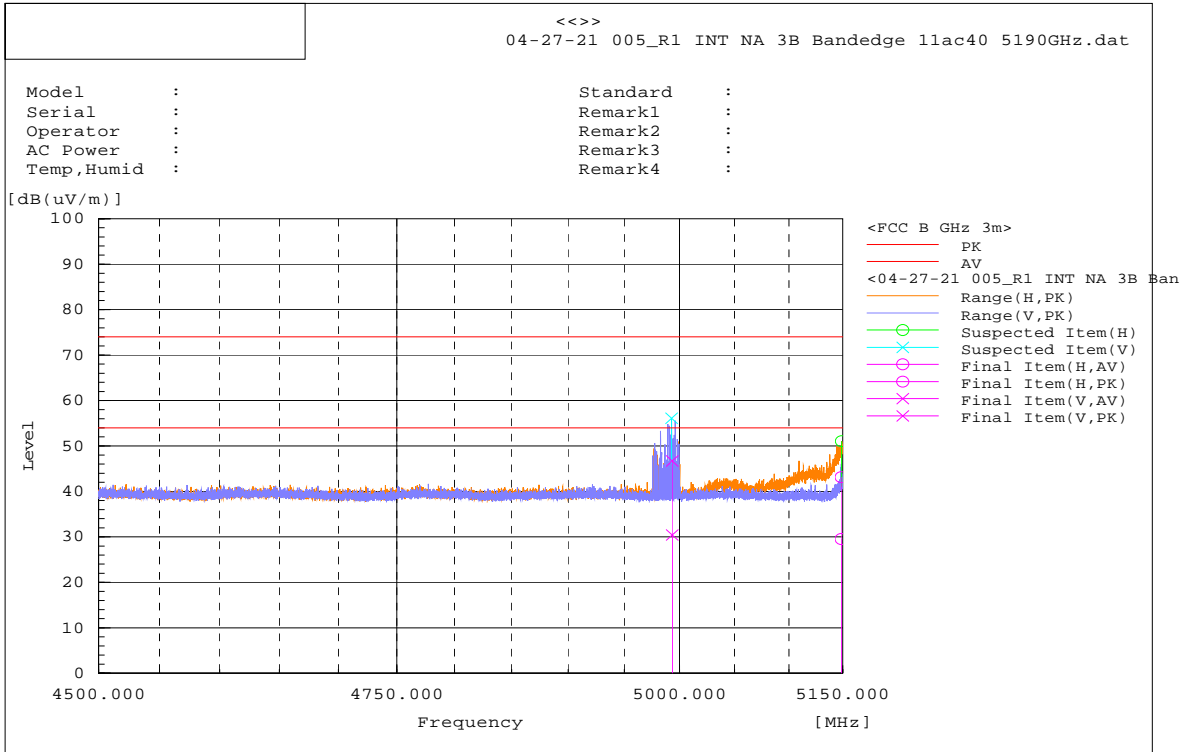

ANTENNA POLARITY & test distance: HORIZONTAL & Vertical at 3 m									
Frequency [MHz]	Pol	Reading [dB(uV)]	Factor [dB(1/m)]	Measurement Type	Level [dB(uV/m)]	Limit [dB(uV/m)]	Margin [dB]	Height [cm]	Angle [deg]
4993.163	V	36.2	-5.8	Average	30.4	54	-23.6	136.1	4.1
5148.613	H	35.2	-5.7	Average	29.5	54	-24.5	369.7	0
4993.163	V	52.5	-5.8	Average	46.7	74	-27.3	136.1	4.1
5148.613	H	48.8	-5.7	Peak	43.1	74	-30.9	369.7	0

**RESTRICTED BAND**  
**802.11n(VHT80) – 5210MHz**

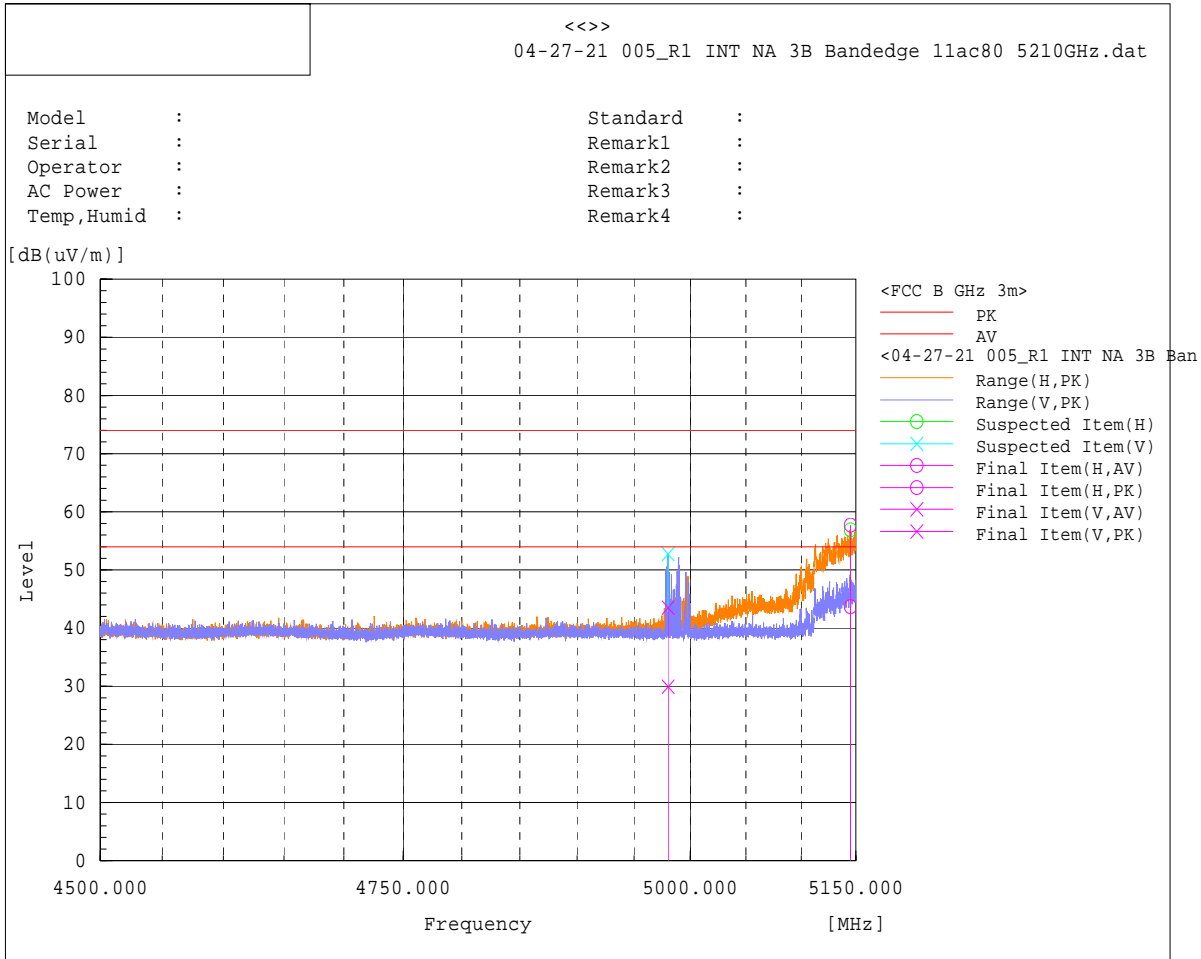

ANTENNA POLARITY & test distance: HORIZONTAL & Vertical at 3 m									
Frequency [MHz]	Pol	Reading [dB(uV)]	Factor [dB(1/m)]	Measurement Type	Level [dB(uV/m)]	Limit [dB(uV/m)]	Margin [dB]	Height [cm]	Angle [deg]
4980.234	V	35.8	-5.9	Average	29.9	54	-24.1	199.4	95.3
5145.093	H	49.4	-5.7	Average	43.7	54	-10.3	121.5	0.9
4980.234	V	49.4	-5.9	Average	43.5	74	-30.5	199.4	95.3
5145.093	H	63.4	-5.7	Peak	57.7	74	-16.3	121.5	0.9

Band Edge Test Plots for U-NII-1 Band:

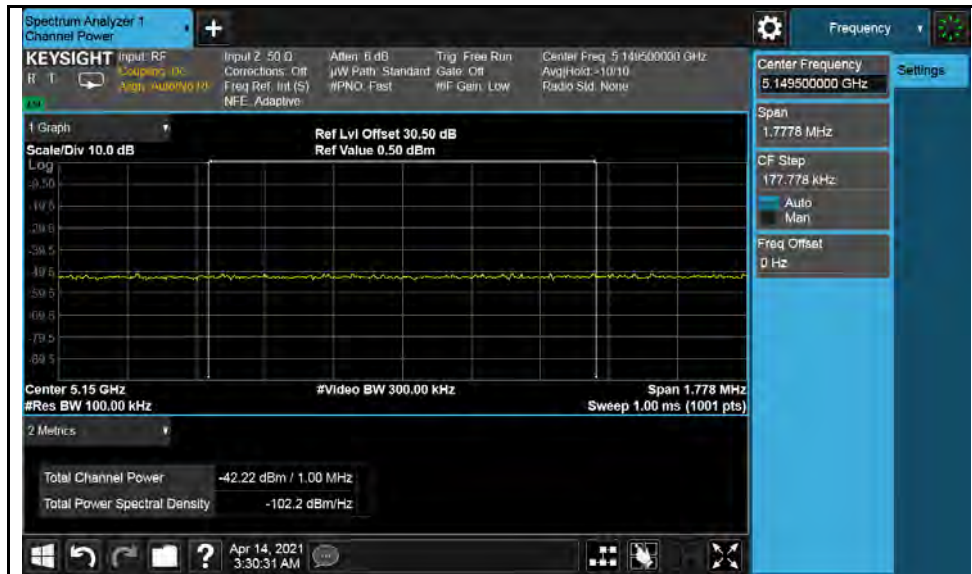

802.11a-5180MHz



802.11a-5240MHz

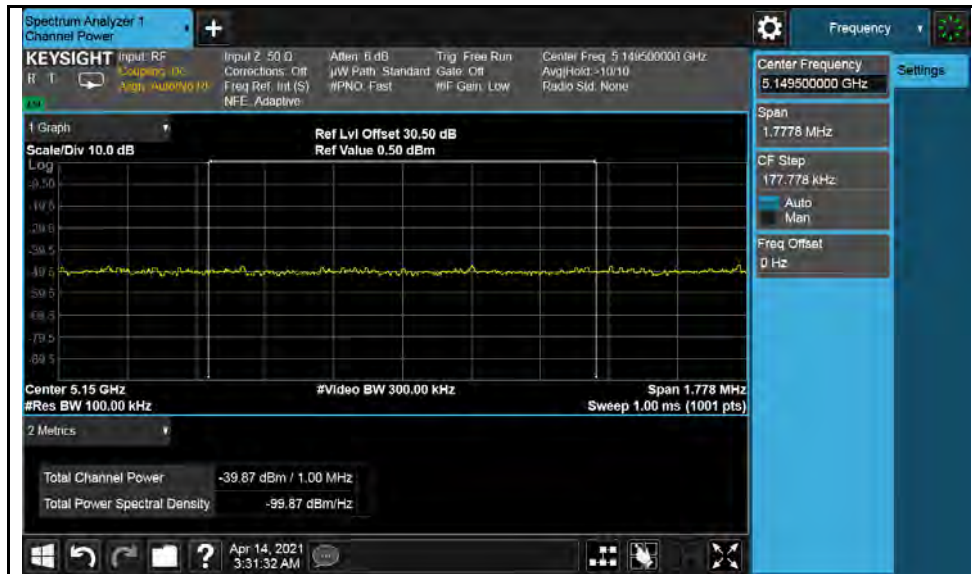

802.11n(HT20)-5180MHz

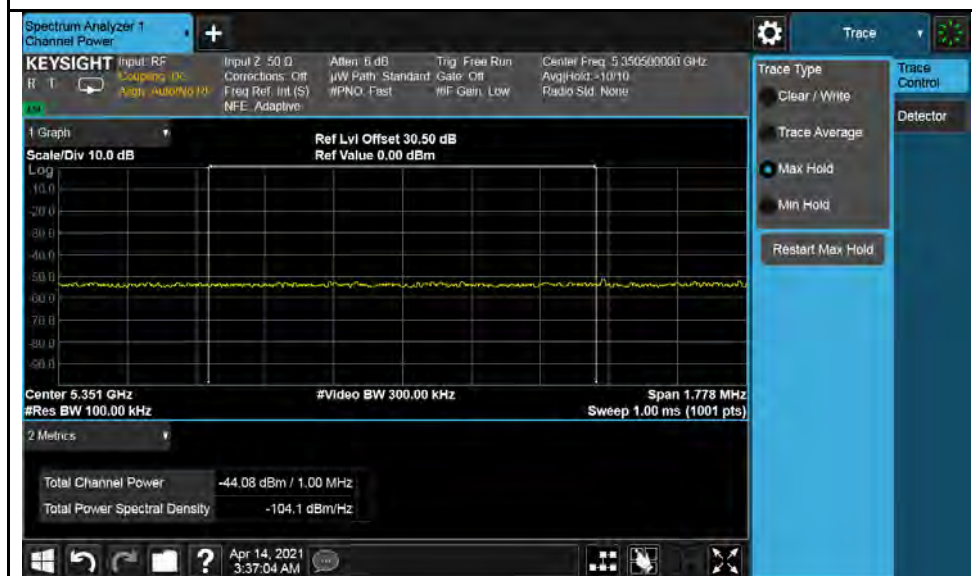

802.11n(HT20)-5240MHz

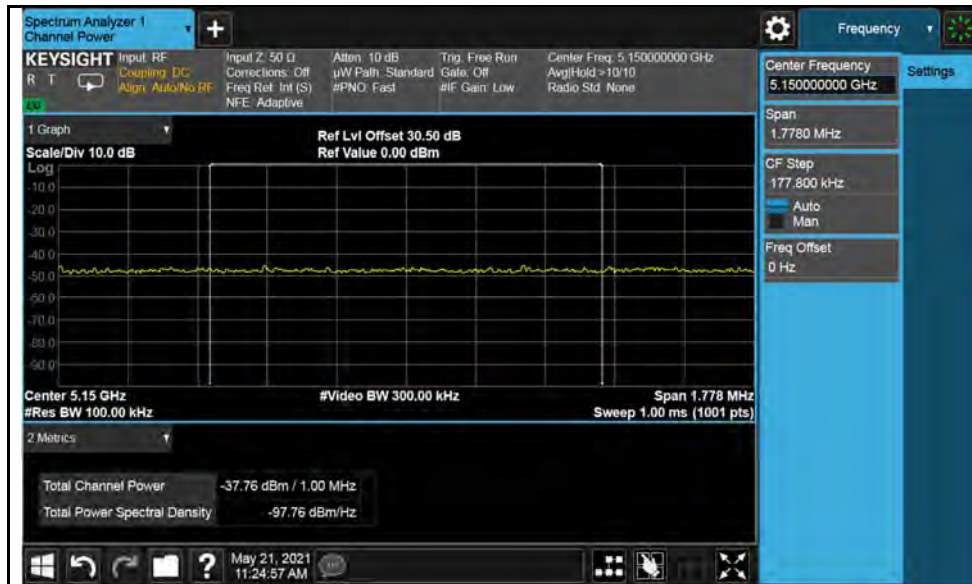

802.11ac(VHT20)-5180MHz

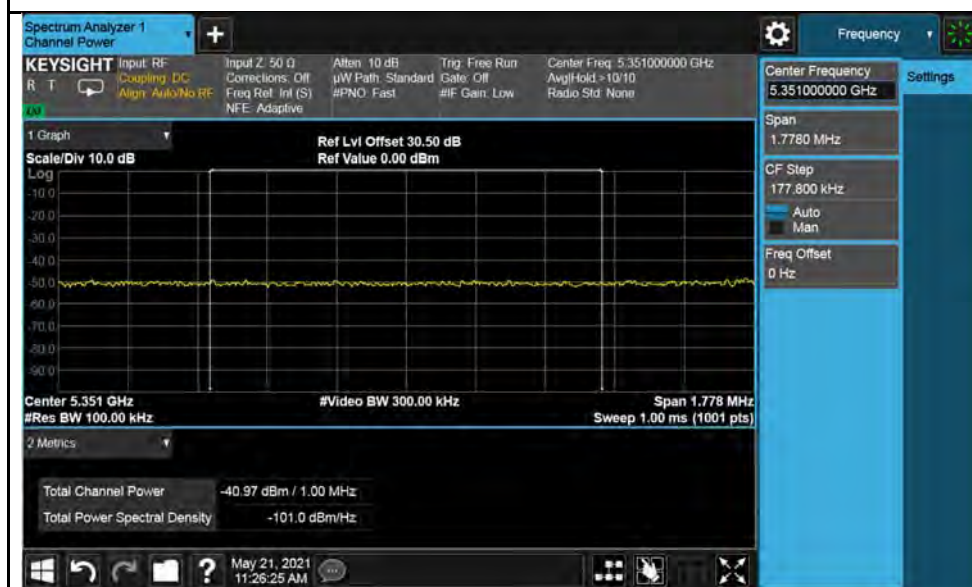

802.11ac(VHT20)-5240MHz





802.11n(HT40)-5190MHz



802.11n(HT40)-5230MHz

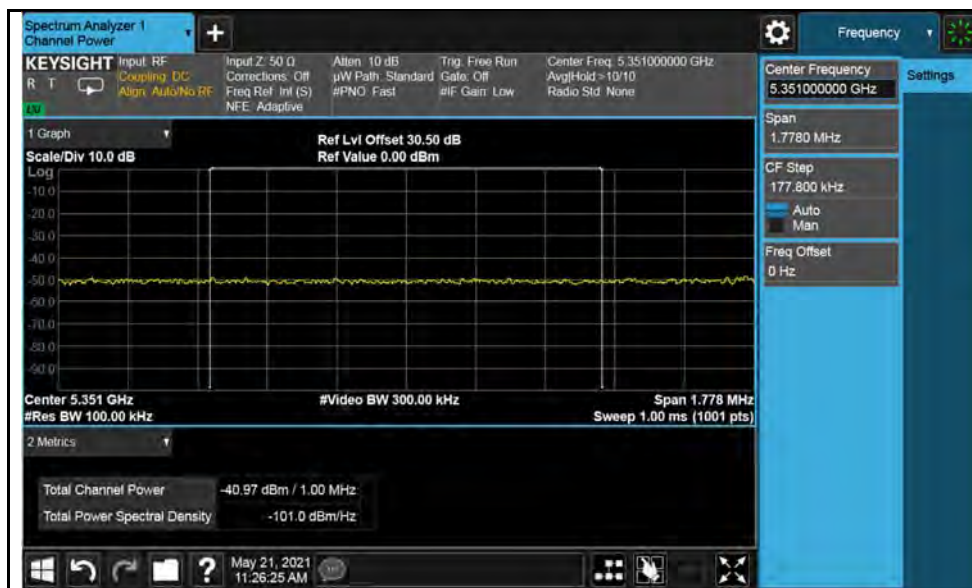

802.11ac(VHT400)-5190MHz

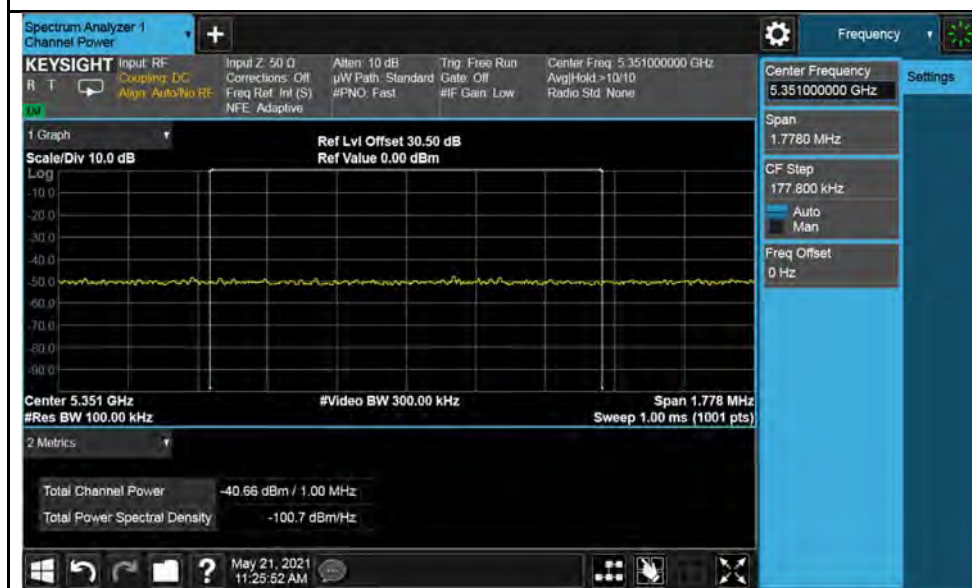

802.11ac(VHT40)-5230MHz

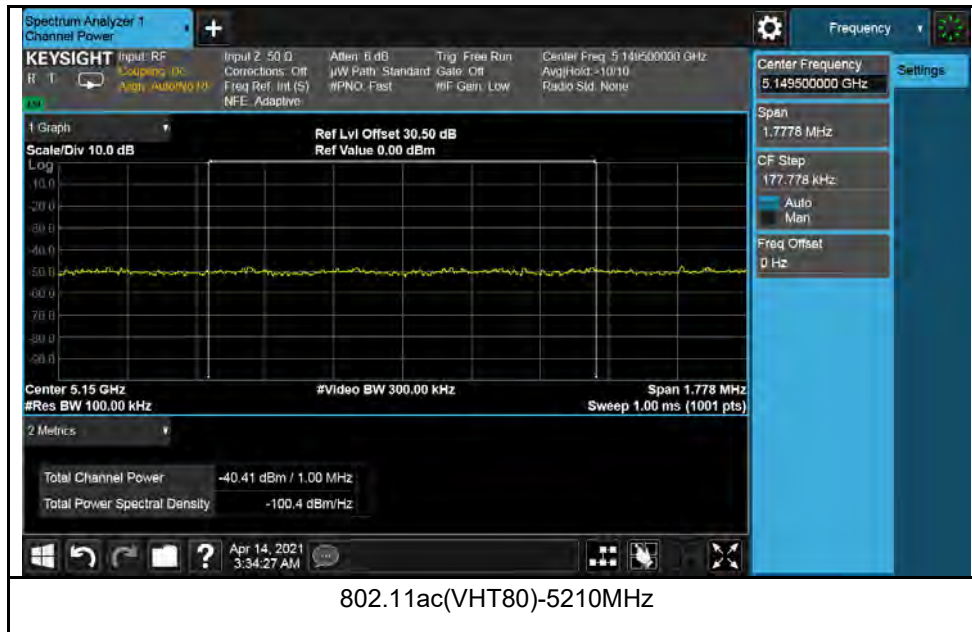

Test Plots for U-NII-3 Band:

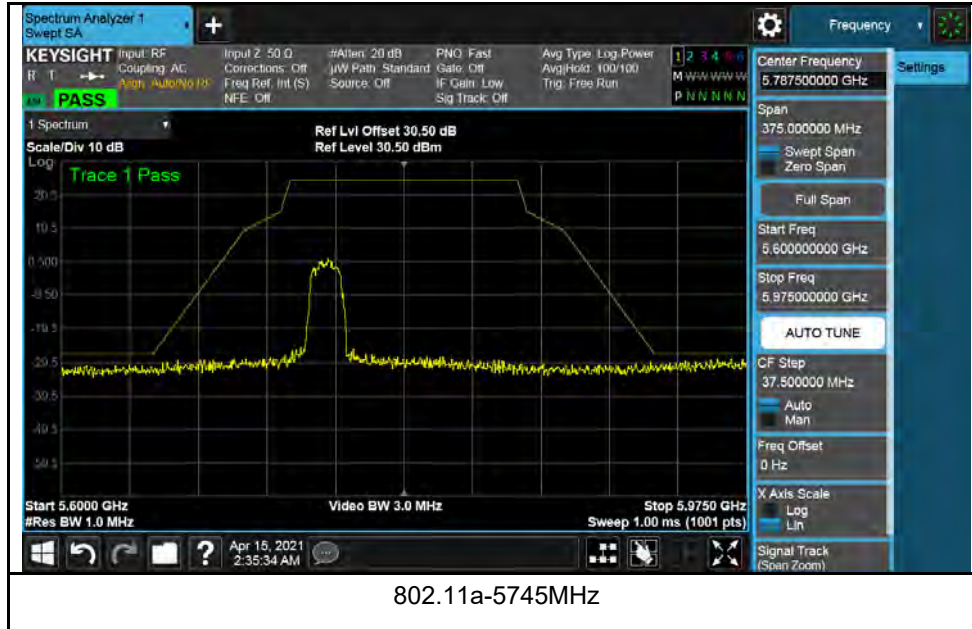

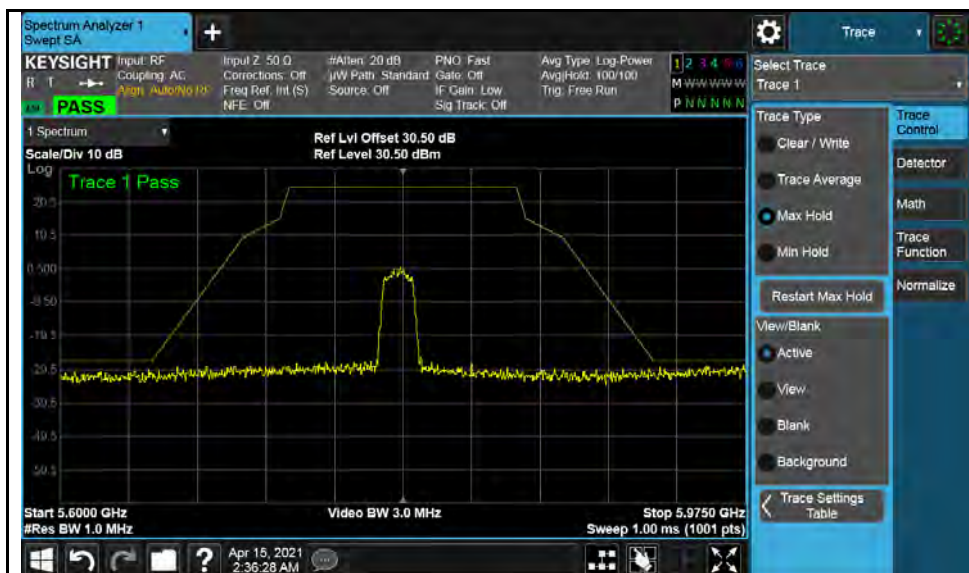

802.11a-5785MHz

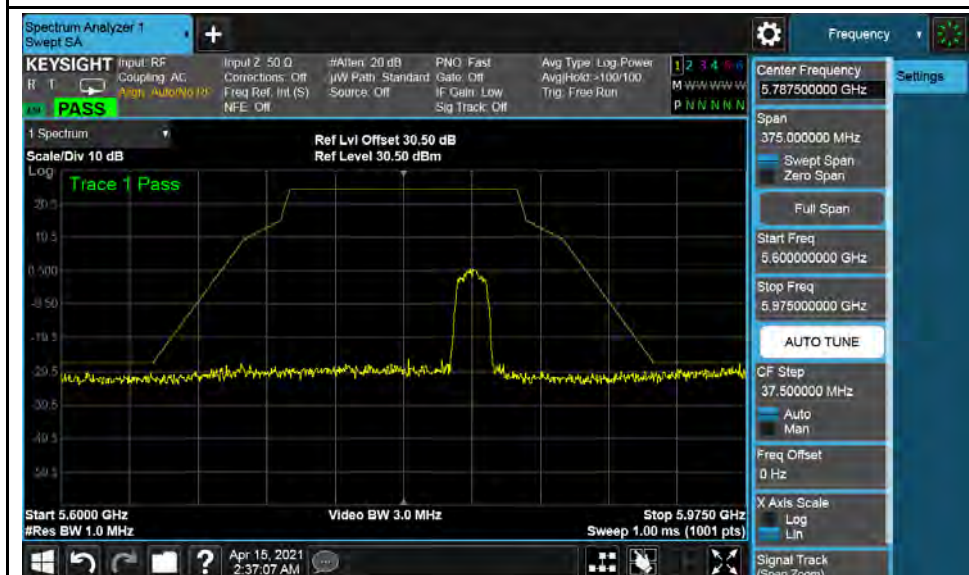

802.11a-5825MHz



802.11n(HT20)-5745MHz



802.11n(HT20)-5785MHz

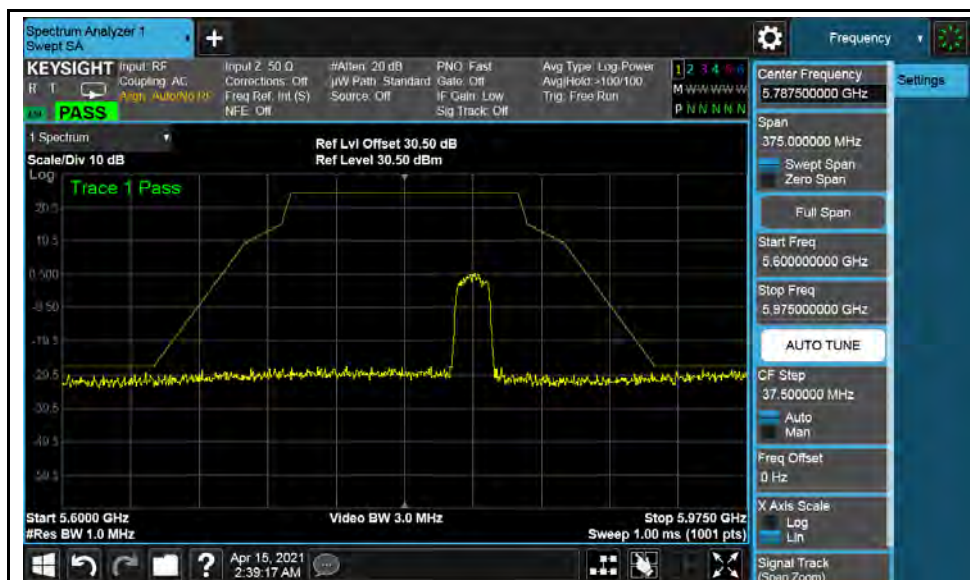

802.11n(HT20)-5825MHz

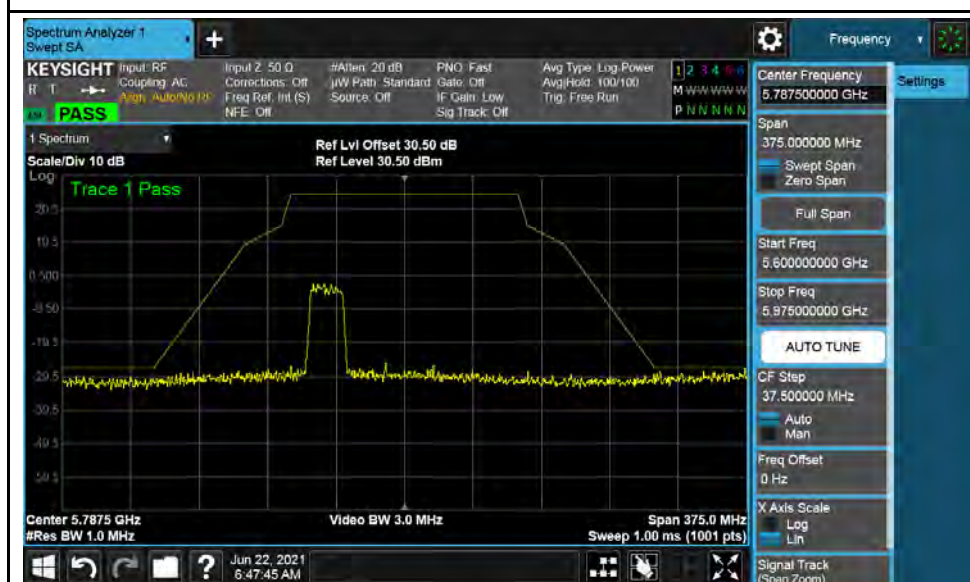

802.11ac (VHT20) - 5745MHz

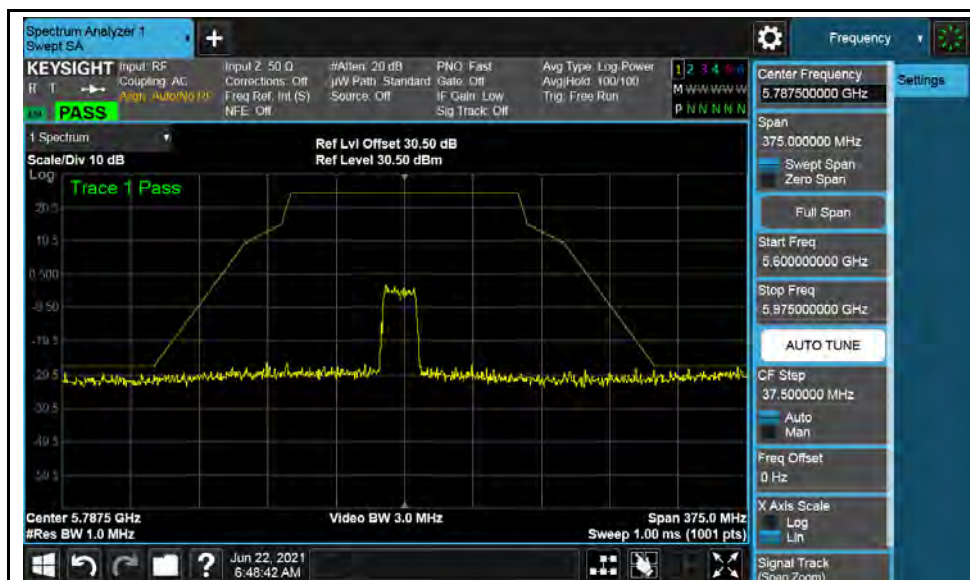

802.11ac (VHT20) – 5785MHz

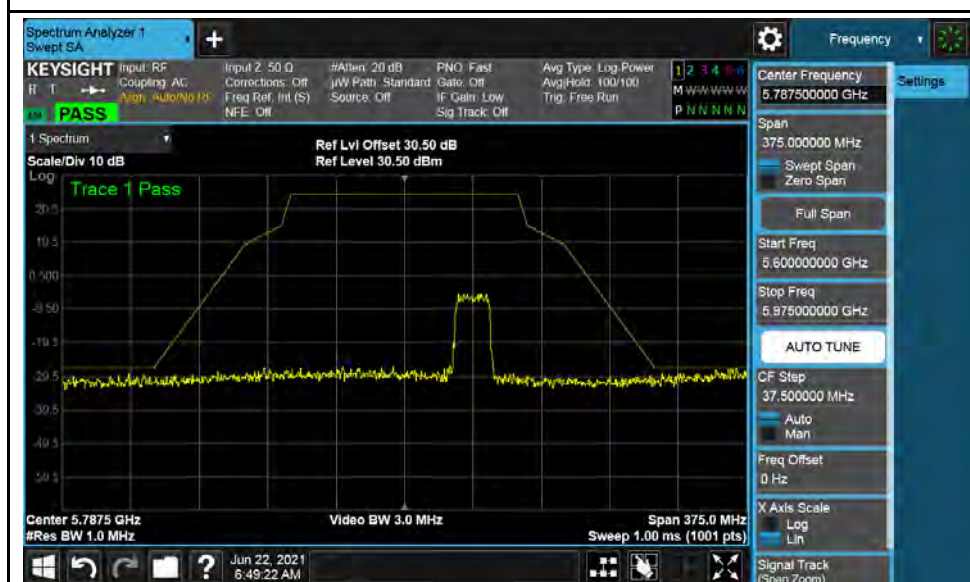

802.11ac (VHT20) – 5825MHz

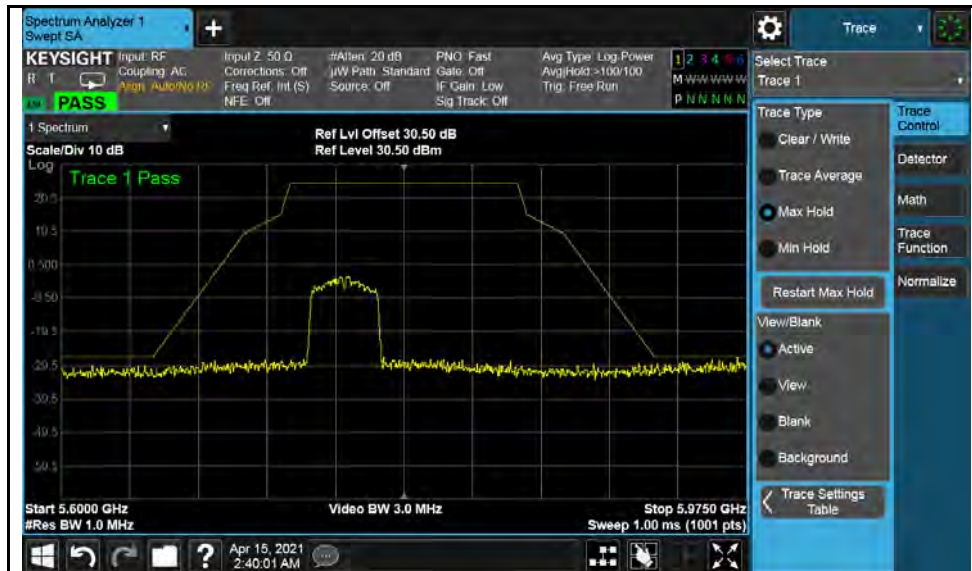

802.11n(HT40)-5755MHz

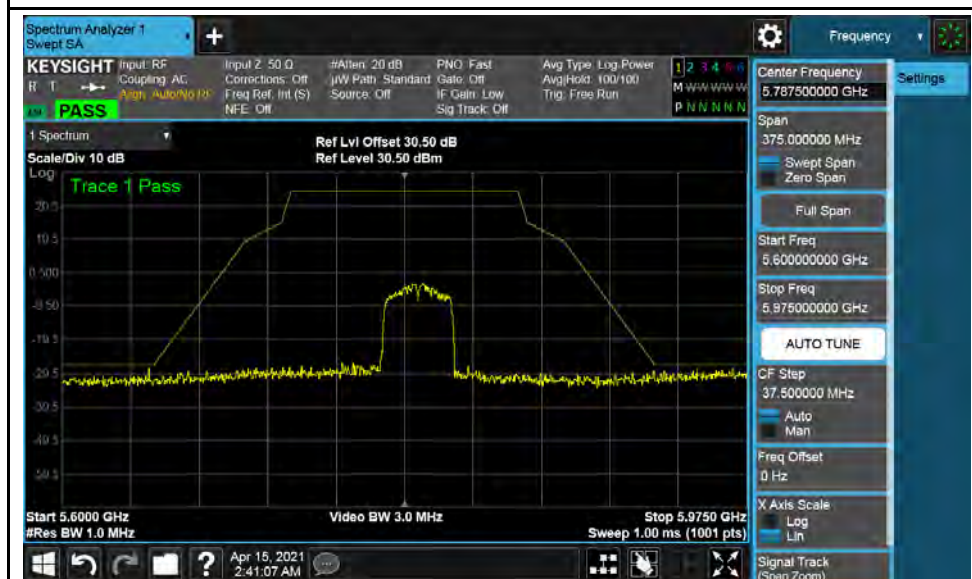

802.11n(HT40)-5795MHz



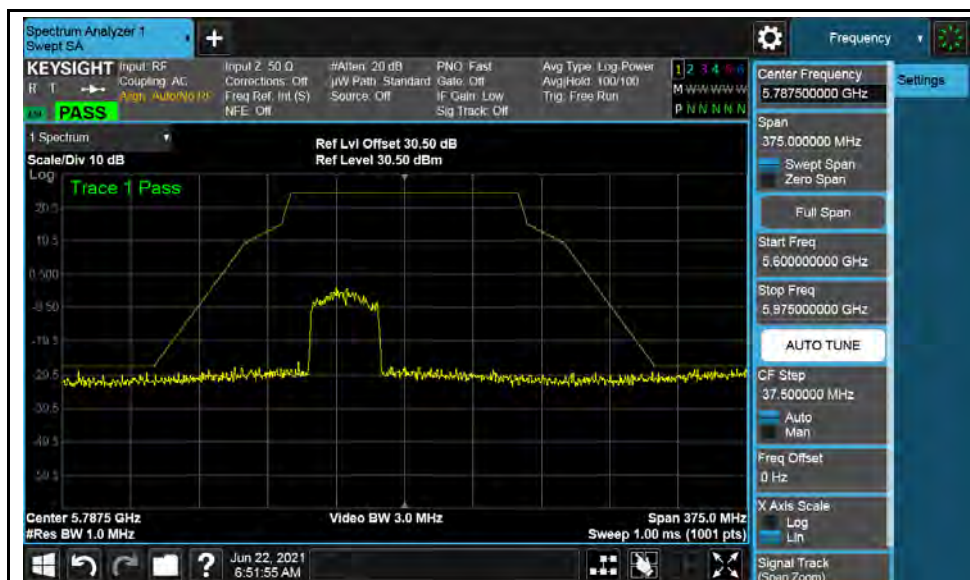

802.11ac (VHT40) - 5755MHz

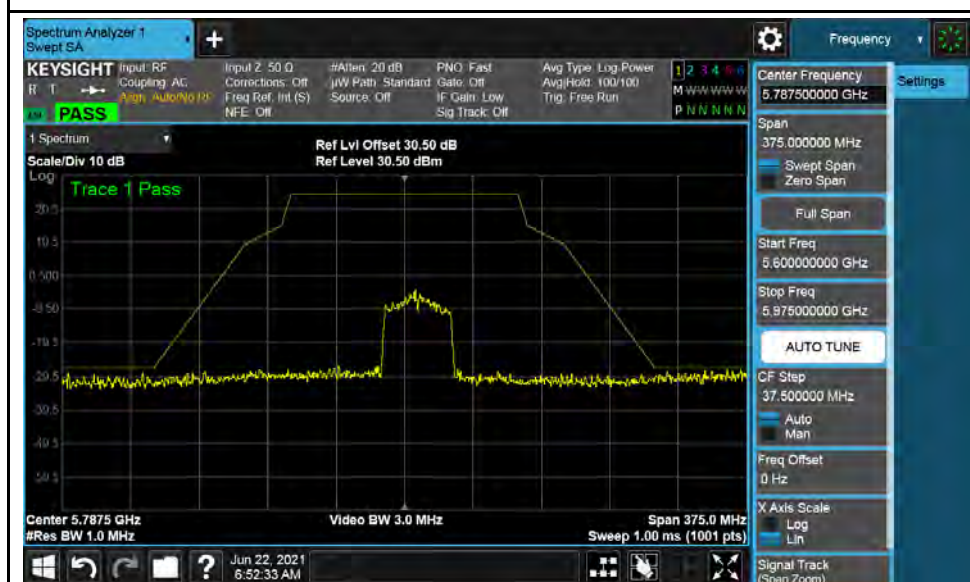

802.11ac (VHT40) - 5795MHz

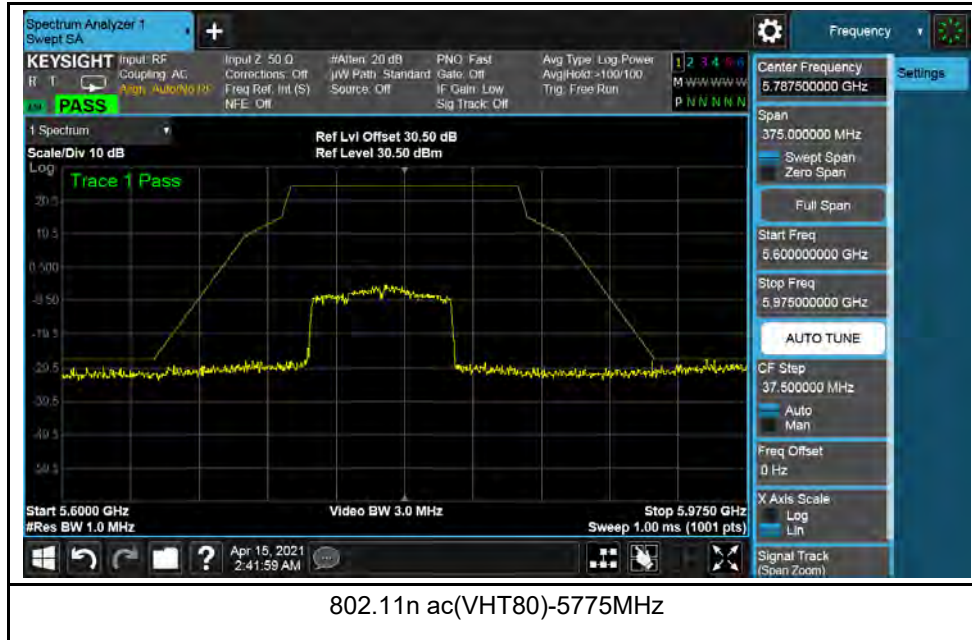

### 4.3 Transmit Power Measurement

#### 4.3.1 Limits of Transmit Power Measurement (FCC)

Operation Band	EUT Category		Limit
U-NII-1		Outdoor Access Point	1 Watt (30 dBm) (Max. e.i.r.p $\leq$ 125mW(21 dBm) at any elevation angle above 30 degrees as measured from the horizon)
		Fixed point-to-point Access Point	1 Watt (30 dBm)
		Indoor Access Point	1 Watt (30 dBm)
	√	Client device	250mW (24 dBm)
U-NII-2A	---		250mW (24 dBm) or 11 dBm+10 log B*
U-NII-2C	---		250mW (24 dBm) or 11 dBm+10 log B*
U-NII-3	√		1 Watt (30 dBm)

#### 4.3.2 Limits of Transmit Power Measurement (ISED)

Operation Band	EUT Category	Limit
5.150 ~ 5.250 GHz	OEM devices installed in Vehicles	Maximum e.i.r.p. shall not exceed 30 mW or 1.76 + 10 log <sub>10</sub> B, dBm Transmitter power control (TPC) capability: 3 dB below the maximum permitted e.i.r.p. of 30 mW
	Other devices	Maximum e.i.r.p. shall not exceed 200 mW or 10 + 10 log <sub>10</sub> B, dBm
5.250 ~ 5.350 GHz	OEM devices installed in Vehicles	Maximum e.i.r.p. shall not exceed 30 mW or 1.76 + 10 log <sub>10</sub> B, dBm Transmitter power control (TPC) capability: 3 dB below the maximum permitted e.i.r.p. of 30 mW
	Other devices	Conducted output power shall not exceed 250 mW or 11 + 10 log <sub>10</sub> B, dBm EIRP shall not exceed 1.0 W or 17 + 10 log <sub>10</sub> B, dBm
5.470 ~ 5.600 GHz 5.650 ~ 5.725 GHz	---	Conducted output power shall not exceed 250 mW or 11 + 10 log <sub>10</sub> B, dBm EIRP shall not exceed 1.0 W or 17 + 10 log <sub>10</sub> B, dBm
5.725 ~ 5.850 GHz	---	Conducted output power shall not exceed 1 W.

\*B is the 26 dB emission bandwidth in megahertz

Per KDB 662911 Method of conducted output power measurement on IEEE 802.11 devices,

Array Gain = 0 dB (i.e., no array gain) for  $N_{ANT} \leq 4$ ;

Array Gain = 0 dB (i.e., no array gain) for channel widths  $\geq 40$  MHz for any  $N_{ANT}$ ;

Array Gain = 5 log( $N_{ANT}/N_{SS}$ ) dB or 3 dB, whichever is less for 20-MHz channel widths with  $N_{ANT} \geq 5$ .

For power measurements on all other devices: Array Gain = 10 log( $N_{ANT}/N_{SS}$ ) dB.

#### 4.3.3 Test Setup

#### FOR POWER OUTPUT MEASUREMENT

##### ◆ Power Meter Measurement

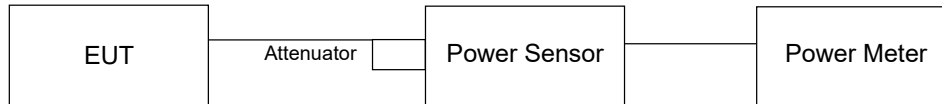

##### ◆ Spectrum Measurement

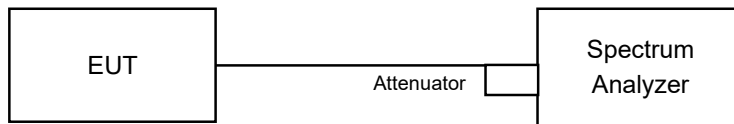

#### FOR 26dB OCCUPIED BANDWIDTH

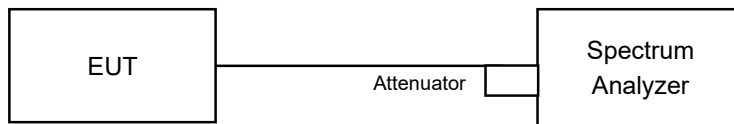

#### 4.3.4 Test Instruments

Refer to section 4.1.2 to get information of above instrument.

#### 4.3.5 Test Procedure

##### For Average Power Measurement

##### For 802.11a, 802.11n (HT20), 802.11n (HT40)

Method PM is used to perform output power measurement, trigger and gating function of wide band power meter is enabled to measure max output power of TX on burst and set the detector to AVERAGE. Duty factor is not added to measured value.

##### For 802.11ac (VHT80)

- 1) Set span to encompass the entire 26 dB EBW (or, alternatively, the entire 99% occupied bandwidth) of the signal.
- 2) Set sweep trigger to "free run".
- 3) Set RBW = 1 MHz.
- 4) Set VBW  $\geq$  3 MHz
- 5) Number of points in sweep  $\geq$  2 Span / RBW.
- 6) Sweep time  $\leq$  (number of points in sweep) \* T
- 7) Using emission bandwidth to determine the frequency span for integration the channel bandwidth.
- 8) Detector = RMS.
- 9) Trace mode = max hold.
- 10) Allow max hold to run for at least 60 seconds, or longer as needed to allow the trace to stabilize.

#### ◆ Power Meter Measurement

Method PM is used to perform output power measurement, trigger and gating function of wide band power meter is enabled to measure max output power of TX on burst. Duty factor is not added to measured value.

#### ◆ Spectrum Measurement

Follow FCC KDB 789033 UNII test procedure:

Method SA-1

1. Set span to encompass the entire emission bandwidth (EBW) of the signal.
2. Set RBW = 1MHz.
3. Set the VBW  $\geq 3 \times$  RBW.
4. Number of points in sweep  $\geq 2 \text{ Span} / \text{RBW}$ .
5. Sweep time = auto.
6. Set trigger to free run (duty cycle  $\geq 98$  percent)
7. Detector = RMS.
8. Trace average at least 100 traces in power averaging mode
9. Compute power by integrating the spectrum across the 26 dB EBW of the signal.

Follow FCC KDB 789033 UNII test procedure:

Method SA-2

1. Set span to encompass the emission bandwidth (EBW) of the signal.
2. Set RBW = 1MHz.
3. Set the VBW  $\geq 3 \times$  RBW.
4. Number of points in sweep  $\geq 2 \text{ Span} / \text{RBW}$ .
5. Sweep time = auto.
6. Detector = RMS.
7. Trace average at least 100 traces in power averaging mode
8. Compute power by integrating the spectrum across the 26 dB EBW of the signal.
9. Duty factor need added to measured value (duty cycle  $< 98$  percent).

#### FOR 26dB OCCUPIED BANDWIDTH

1. Set RBW = approximately 1% of the emission bandwidth.
2. Set the VBW  $>$  RBW.
3. Detector = Peak.
4. Trace mode = max hold.
5. Measure the maximum width of the emission that is 26 dB down from the peak of the emission. Compare this with the RBW setting of the analyzer. Readjust RBW and repeat measurement as needed until the RBW/EBW ratio is approximately 1%.

#### 4.3.6 Deviation from Test Standard

No deviation.

#### 4.3.7 EUT Operating Condition

The software provided by client to enable the EUT under transmission condition continuously at lowest, middle and highest channel frequencies individually.

#### 4.3.8 Test Results

##### Output Power measurement result for UNII-1 Band (FCC)

Type	Test mode	Freq (MHz)	CH	Conducted Power (dBm)	Limit (dBm)	Result
Output Power	802.11a	5180	Low	6.49	24	Pass
		5200	Mid	6.87	24	Pass
		5240	High	6.57	24	Pass
	802.11n-HT20	5180	Low	6.89	24	Pass
		5200	Mid	6.85	24	Pass
		5240	High	6.45	24	Pass
	802.11ac-VHT20	5180	Low	7.00	24	Pass
		5200	Mid	6.57	24	Pass
		5240	High	6.23	24	Pass
	802.11n-HT40	5190	Low	5.68	24	Pass
		5230	High	5.26	24	Pass
	802.11ac-VHT40	5190	Low	5.46	24	Pass
		5230	High	5.32	24	Pass
	802.11ac-VHT80	5210	Low	4.62	24	Pass

##### EIRP measurement result for 5180~5240 MHz Band (ISED)

Type	Test mode	Freq (MHz)	CH	Conducted Power (dBm)	Antenna Gain (dBi)	EIRP (dBm)	Limit (dBm)	Result
Output Power	802.11a	5180	Low	6.49	2.65	9.14	14.77	Pass
		5200	Mid	6.87	2.65	9.52	14.77	Pass
		5240	High	6.57	2.65	9.22	14.77	Pass
	802.11n-HT20	5180	Low	6.89	2.65	9.54	14.77	Pass
		5200	Mid	6.85	2.65	9.5	14.77	Pass
		5240	High	6.45	2.65	9.1	14.77	Pass
	802.11ac-VHT20	5180	Low	7.00	2.65	9.65	14.77	Pass
		5200	Mid	6.57	2.65	9.22	14.77	Pass
		5240	High	6.23	2.65	8.88	14.77	Pass
	802.11n-HT40	5190	Low	5.68	2.65	8.33	14.77	Pass
		5230	High	5.26	2.65	7.91	14.77	Pass
	802.11ac-VHT40	5190	Low	5.46	2.65	8.11	14.77	Pass
		5230	High	5.32	2.65	7.97	14.77	Pass
	802.11ac-VHT80	5210	Low	4.62	2.65	7.27	14.77	Pass

Output Power measurement result for UNII-3 Band

Type	Test mode	Freq (MHz)	CH	Conducted Power (dBm)	Limit (dBm)	Result
Output Power	802.11a	5745	Low	9.26	30	Pass
		5785	Mid	9.97	30	Pass
		5825	High	9.83	30	Pass
	802.11n-HT20	5745	Low	9.21	30	Pass
		5785	Mid	9.4	30	Pass
		5825	High	9.44	30	Pass
	802.11ac-VHT20	5745	Low	9.76	30	Pass
		5785	Mid	10.05	30	Pass
		5825	High	10.02	30	Pass
	802.11n-HT40	5755	Low	9.42	30	Pass
		5795	High	9.7	30	Pass
	802.11ac-VHT40	5755	Low	9.82	30	Pass
		5795	High	10.02	30	Pass
	802.11ac-VHT80	5775	Low	11.92	30	Pass

## 4.4 26dB Bandwidth & 6dB Bandwidth Measurement

### 4.4.1 Limits of 6 dB Bandwidth Measurement

The minimum of 6 dB Bandwidth Measurement is 0.5 MHz.

### 4.4.2 Test Setup



### 4.4.3 Test Instruments

Refer to section 4.1.2 to get information of above instrument.

### 4.4.4 Test Procedure

26dB Emission bandwidth measurement procedure (Other than 5.725-5.85 GHz)

- Allow the trace to stabilize.
- Use the spectrum analyzer built-in measurement function to determine the 26dB BW.  
Set RBW = around 1% of emission bandwidth  
Set VBW > RBW  
Detector = Peak  
Trace mode = max hold
- Capture the plot.
- Repeat above steps for different test channel and other modulation type.

6 dB Minimum emission bandwidth measurement procedure

- Allow the trace to stabilize.
- Use the spectrum analyzer built-in measurement function to determine the 6dB BW.  
Set RBW = 100 KHz  
Set VBW  $\geq 3 \times$  RBW  
Detector = Peak  
Trace mode = max hold  
Sweep = auto couple
- Capture the plot.
- Repeat above steps for different test channel and other modulation type.



#### 4.4.5 Test Results

##### 26dB Bandwidth measurement result for UNII-1 Band

Type	Test mode	Freq (MHz)	CH	99% OBW(MHz)	26 dB OBW(MHz)
26dB BW	802.11a	5180	Low	17.76	21.02
		5200	Mid	17.78	20.98
		5240	High	17.71	20.72
	802.11n-HT20	5180	Low	17.71	21.30
		5200	Mid	17.51	21.07
		5240	High	17.75	21.14
	802.11ac-VHT20	5180	Low	17.74	20.95
		5200	Mid	17.77	21.21
		5240	High	17.75	21.23
	802.11n-HT40	5190	Low	36.08	38.65
		5230	High	36.09	38.74
	802.11ac-VHT40	5190	Low	36.14	39.05
5230		High	36.15	39.11	
802.11ac-VHT80	5210	Low	75.86	80.43	

##### 6dB Bandwidth measurement result for UNII-3 Band

Type	Test mode	Freq (MHz)	CH	99% OBW(MHz)	6 dB OBW(MHz)	Limit (MHz)	Result
6dB BW	802.11a	5745	Low	17.77	17.73	0.5	Pass
		5785	Mid	17.80	17.72	0.5	Pass
		5825	High	17.70	17.71	0.5	Pass
	802.11n-HT20	5745	Low	17.74	17.65	0.5	Pass
		5785	Mid	17.76	17.76	0.5	Pass
		5825	High	17.74	17.71	0.5	Pass
	802.11ac-VHT20	5745	Low	17.72	17.71	0.5	Pass
		5785	Mid	17.71	17.75	0.5	Pass
		5825	High	17.76	17.78	0.5	Pass
	802.11n-HT40	5755	Low	36.06	36.20	0.5	Pass
		5795	High	36.14	35.34	0.5	Pass
	802.11ac-VHT40	5755	Low	36.01	35.89	0.5	Pass
		5795	High	36.11	35.68	0.5	Pass
	802.11ac-VHT80	5775	Low	75.91	75.51	0.5	Pass

Occupied Bandwidth Test Plots  
UNII-1 Band



802.11a-5180MHz

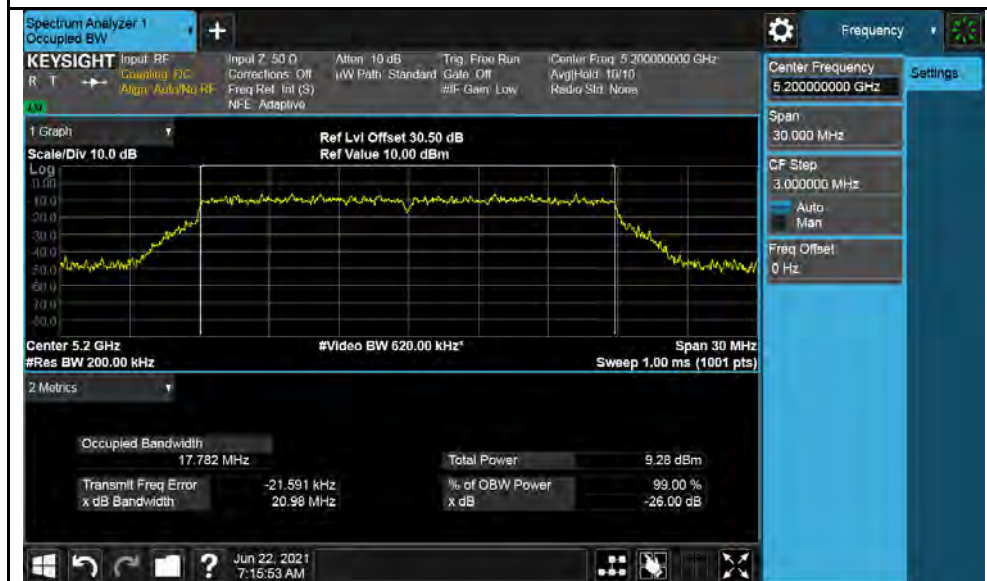

802.11a-5200MHz



802.11a-5240MHz



802.11n-HT20-5180MHz



802.11n-HT20-5200MHz

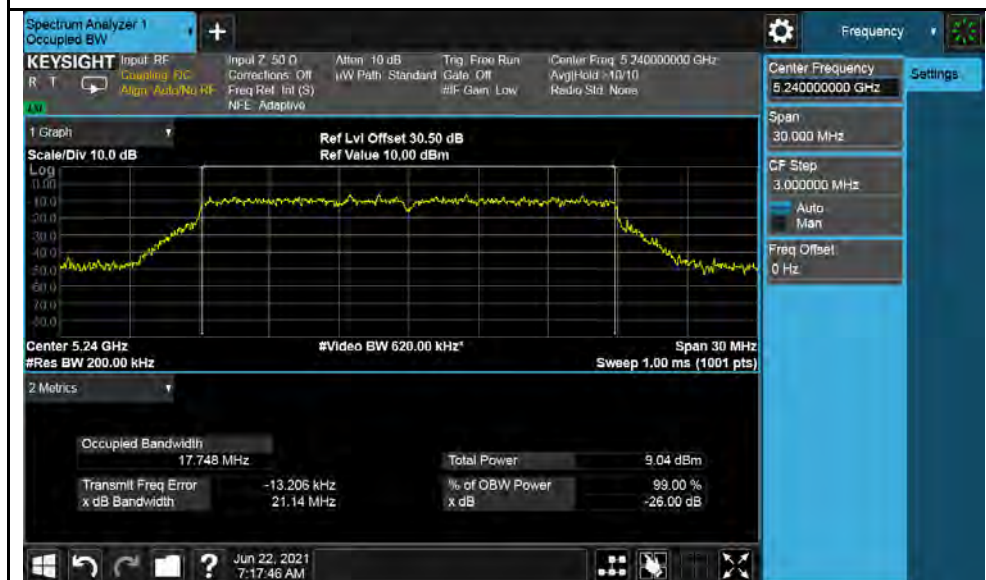

802.11n-HT20-5240MHz



802.11ac-VHT20-5180MHz



802.11ac-VHT20-5200MHz



802.11ac-VHT20-5240MHz

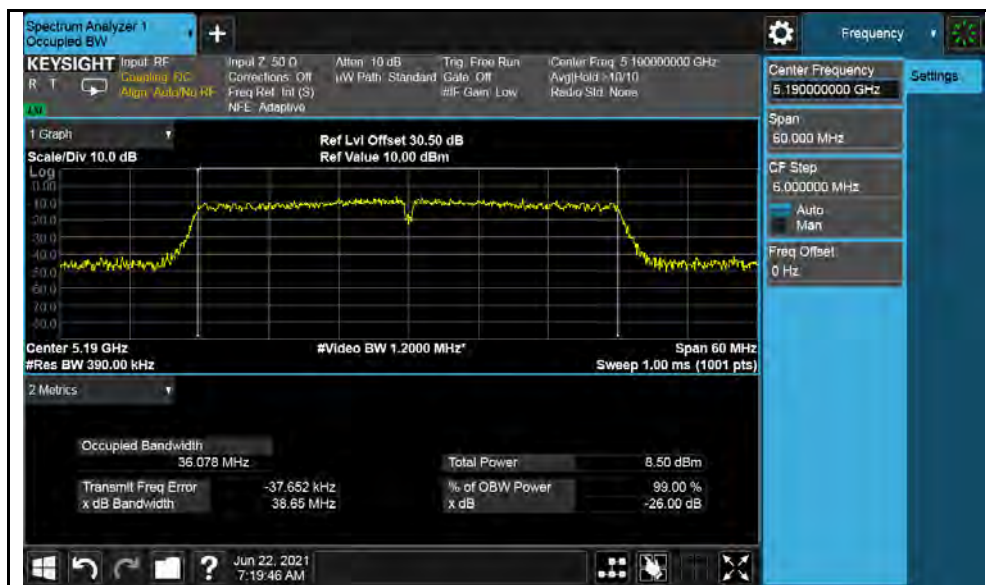

802.11n-HT40-5190MHz

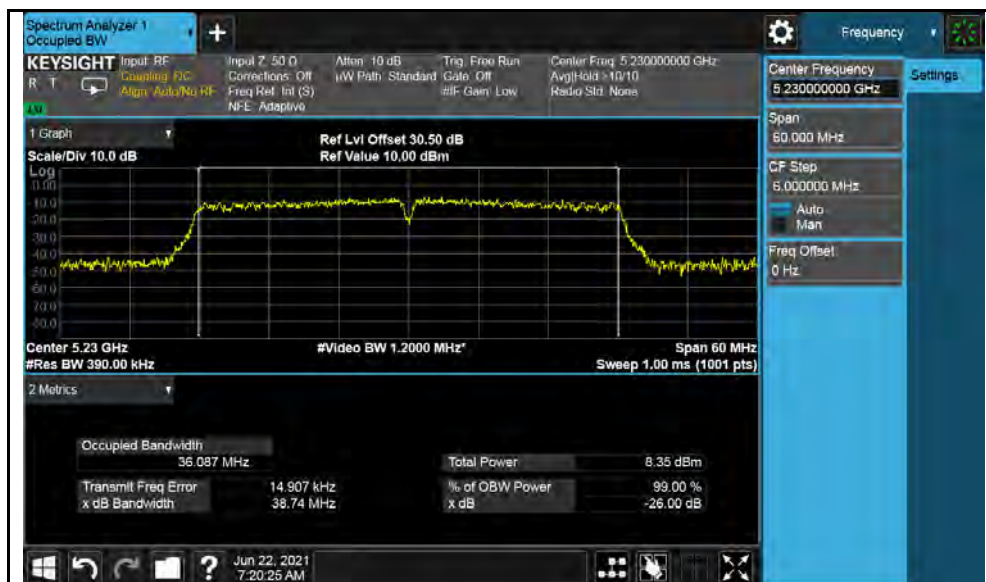

802.11n-HT40-5230MHz



802.11ac-VHT40-5190MHz

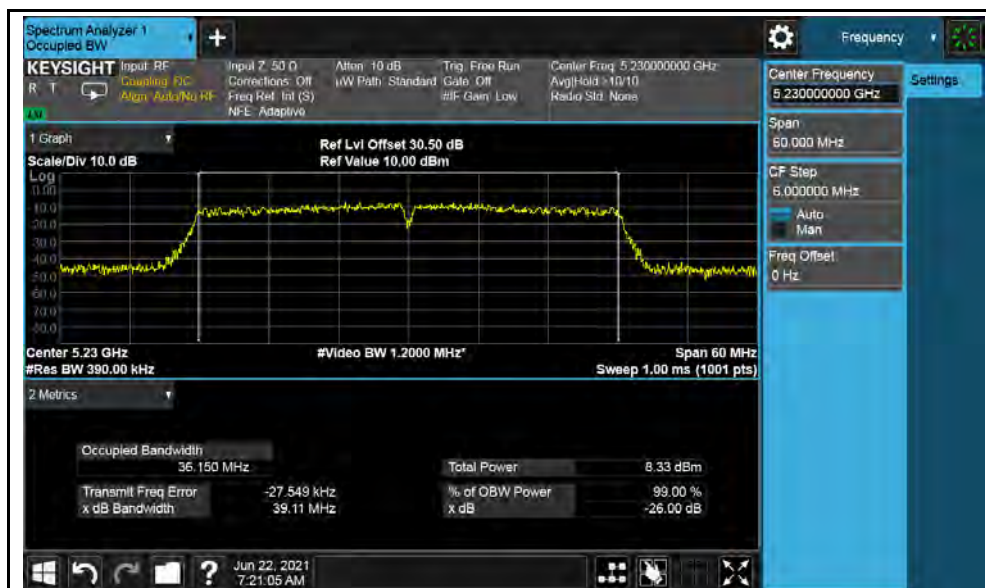

802.11ac-VHT40-5230MHz



802.11ac-VHT80-5210MHz



6dB Bandwidth Test Plots  
U-NII-3 Band:



802.11a-5745MHz



802.11a-5785MHz



802.11a-5825MHz

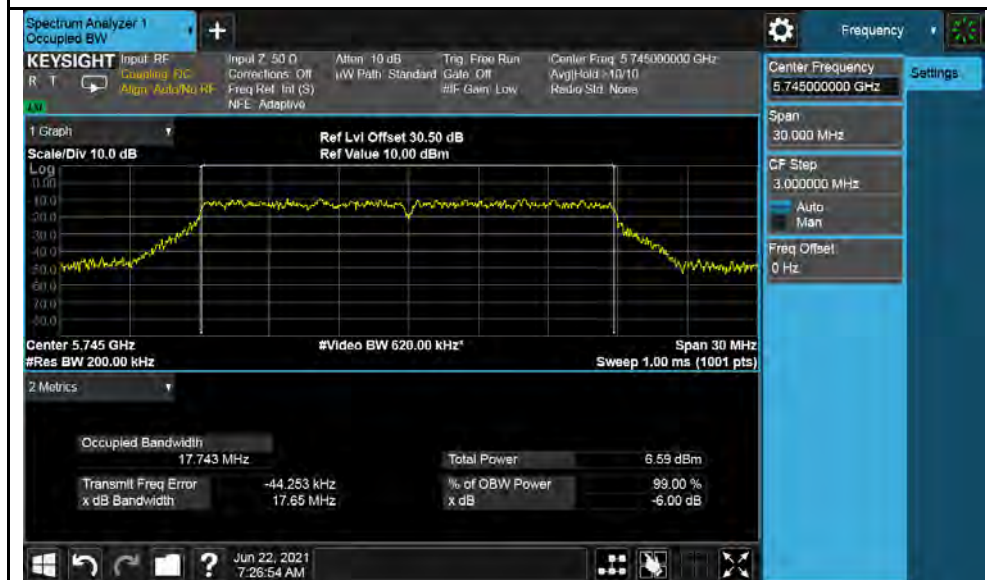

802.11n-HT20-5745MHz

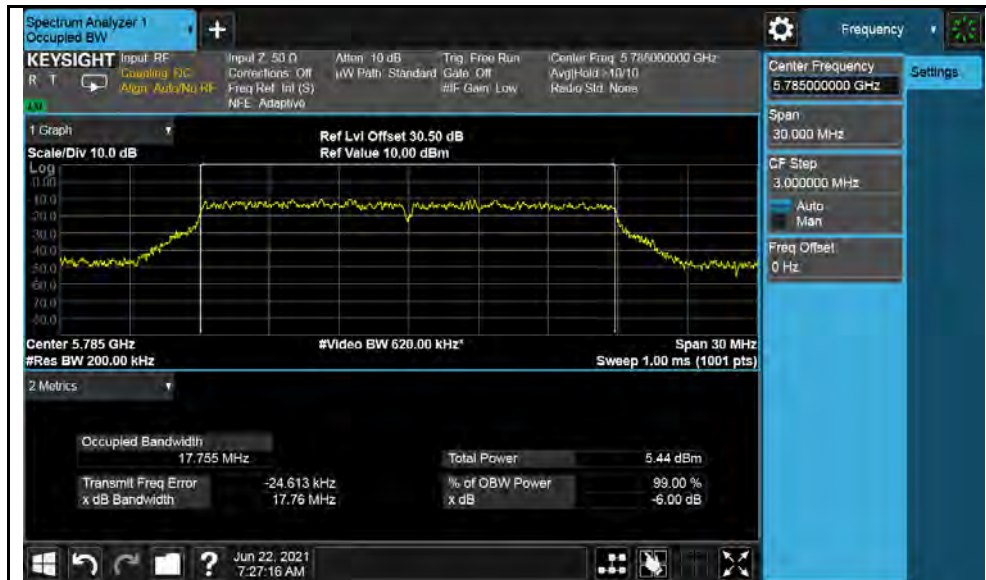

802.11n-HT20-5785MHz



802.11n-HT20-5825MHz



802.11ac-HT20-5745MHz



802.11ac-HT20-5785MHz

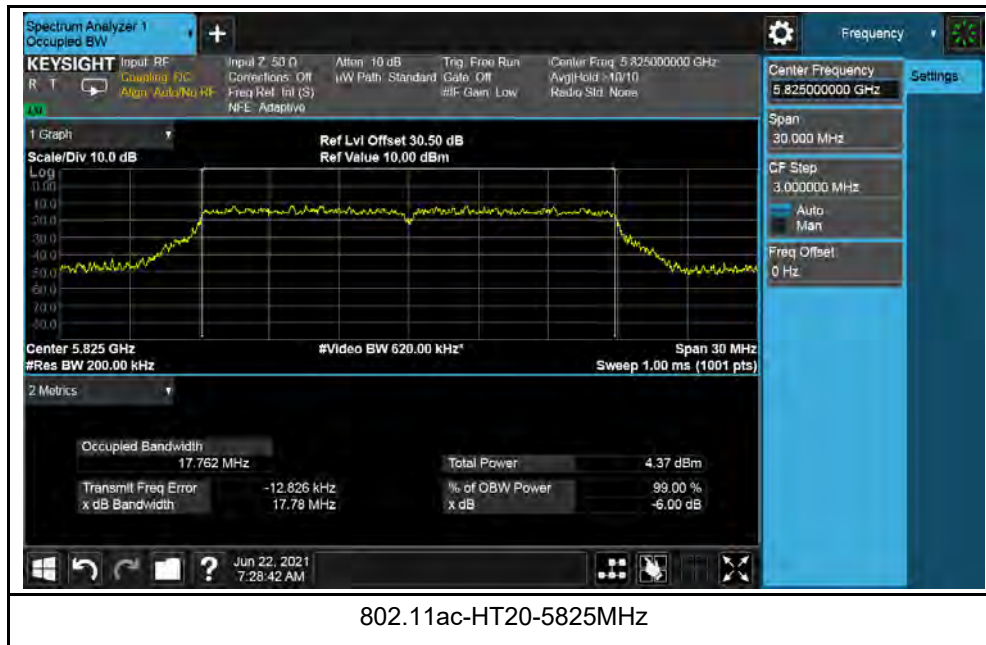

802.11ac-HT20-5825MHz



802.11n-HT40-5755MHz

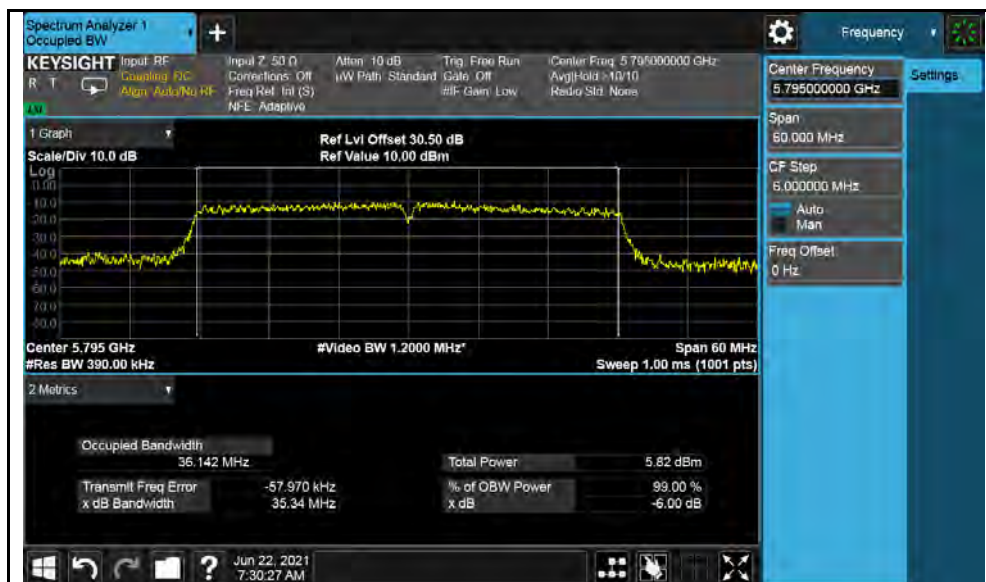

802.11n-HT40-5795MHz



802.11ac-VHT40-5795MHz



802.11ac-VHT40-5795MHz



802.11ac-VHT80-5775MHz

#### 4.5 Peak Power Spectral Density Measurement

##### 4.5.1 Limits of Peak Power Spectral Density Measurement (FCC)

Operation Band	EUT Category	Limit
U-NII-1	Outdoor Access Point	17dBm/ MHz
	Fixed point-to-point Access Point	
	Indoor Access Point	
	√ Client device	11dBm/ MHz
U-NII-2A	---	11dBm/ MHz
U-NII-2C	---	11dBm/ MHz
U-NII-3	√	30dBm/ 500kHz

##### 4.5.2 Limits of Peak Power Spectral Density Measurement (ISED)

Operation Band	EUT Category	Limit
5.150 ~ 5.250 GHz	OEM devices installed in Vehicles	N/A
	Other devices	EIRP spectral density shall not exceed 10 dBm in any 1.0 MHz band
5.250 ~ 5.350 GHz	OEM devices installed in Vehicles	N/A
	Other devices	Power spectral density shall not exceed 11 dBm in any 1.0 MHz band.
5.470 ~ 5.600 GHz 5.650 ~ 5.725 GHz	---	Power spectral density shall not exceed 11 dBm in any 1.0 MHz band.
5.725 ~ 5.850 GHz	---	Power spectral density shall not exceed 30 dBm in any 500 kHz band.

##### 4.5.3 Test Setup



##### 4.5.4 Test Instruments

Refer to section 4.1.2 to get information of above instrument.

##### 4.5.5 Test Procedure

**For U-NII-1, U-NII-2A, U-NII-2C band:**

Using method SA-1

1. Set span to encompass the entire emission bandwidth (EBW) of the signal.
2. Set RBW = 1 MHz, Set VBW ≥ 3 MHz, Detector = RMS
3. Sweep time = auto, trigger set to "free run".
4. Trace average at least 100 traces in power averaging mode.
5. Record the max value



**For U-NII-3:**

1. Set span to encompass the entire emission bandwidth (EBW) of the signal.
2. Set RBW = 300 kHz, Set VBW ≥ 1 MHz, Detector = RMS
3. Use the peak marker function to determine the maximum power level in any 300 kHz band segment within the fundamental EBW.
4. Scale the observed power level to an equivalent value in 500 kHz by adjusting (reducing) the measured power by a bandwidth correction factor (BWCF) where  $BWCF = 10\log(500 \text{ kHz}/100\text{kHz})$
5. Sweep time = auto, trigger set to "free run".
6. Trace average at least 100 traces in power averaging mode.
7. Record the max value

4.5.6 Deviation from Test Standard

No deviation.

4.5.7 EUT Operating Condition

Same as Item 4.3.6.

4.5.8 Test Results

PSD measurement result for UNII-1 Band

Type	Test mode	Freq (MHz)	CH	Conducted PSD (dBm/MHz)	Limit (dBm/MHz)	Result
Output Power	802.11a	5180	Low	-7.905	11	Pass
		5200	Mid	-8.249	11	Pass
		5240	High	-8.461	11	Pass
	802.11n-HT20	5180	Low	-7.639	11	Pass
		5200	Mid	-7.994	11	Pass
		5240	High	-8.383	11	Pass
	802.11ac-VHT20	5180	Low	-7.835	11	Pass
		5200	Mid	-8.079	11	Pass
		5240	High	-7.985	11	Pass
	802.11n-HT40	5190	Low	-11.135	11	Pass
		5230	High	-11.372	11	Pass
	802.11ac-vHT40	5190	Low	-11.074	11	Pass
		5230	High	-10.846	11	Pass
	802.11ac-VHT80	5210	Low	-15.120	11	Pass

PSD measurement result for UNII-1 Band (ISED)

Type	Test mode	Freq (MHz)	CH	Conducted PSD (dBm/MHz)	Antenna Gain (dBi)	PSD (dBm/MHz)	Limit (dBm/MHz)	Result
Output Power	802.11a	5180	Low	-7.905	2.65	-5.255	10	Pass
		5200	Mid	-8.249	2.65	-5.599	10	Pass
		5240	High	-8.461	2.65	-5.811	10	Pass
	802.11n-HT20	5180	Low	-7.639	2.65	-4.989	10	Pass
		5200	Mid	-7.994	2.65	-5.344	10	Pass
		5240	High	-8.383	2.65	-5.733	10	Pass
	802.11ac-VHT20	5180	Low	-7.835	2.65	-5.185	10	Pass
		5200	Mid	-8.079	2.65	-5.429	10	Pass
		5240	High	-7.985	2.65	-5.335	10	Pass
	802.11n-HT40	5190	Low	-11.135	2.65	-8.485	10	Pass
		5230	High	-11.372	2.65	-8.722	10	Pass
	802.11ac-vHT40	5190	Low	-11.074	2.65	-8.424	10	Pass
		5230	High	-10.846	2.65	-8.196	10	Pass
	802.11ac-VHT80	5210	Low	-15.120	2.65	-12.47	10	Pass

PSD measurement result for UNII-3 Band

Type	Test mode	Freq (MHz)	CH	Conducted PSD (dBm/MHz)	Correction factor (dB)	Correction PSD (dBm/MHz)	Limit (dBm/MHz)	Result
Output Power	802.11a	5745	Low	-18.796	6.99	-11.806	30	Pass
		5785	Mid	-19.692	6.99	-12.702	30	Pass
		5825	High	-20.986	6.99	-13.996	30	Pass
	802.11n-HT20	5745	Low	-19.230	6.99	-12.24	30	Pass
		5785	Mid	-20.151	6.99	-13.161	30	Pass
		5825	High	-21.257	6.99	-14.267	30	Pass
	802.11ac-VHT20	5745	Low	-19.355	6.99	-12.365	30	Pass
		5785	Mid	-19.689	6.99	-12.699	30	Pass
		5825	High	-20.609	6.99	-13.619	30	Pass
	802.11n-HT40	5755	Low	-21.286	6.99	-14.296	30	Pass
		5795	High	-22.011	6.99	-15.021	30	Pass
	802.11ac-vHT40	5755	Low	-21.858	6.99	-14.868	30	Pass
		5795	High	-22.883	6.99	-15.893	30	Pass
	802.11ac-VHT80	5775	Low	-26.356	6.99	-19.366	30	Pass
NOTE	BW correction factor = 10log (500kHz/RBW), RBW was set to 100kHz during test.							

Test Plot for UNII-1 Band:



802.11a-5180MHz



802.11a-5200MHz



802.11a-5240MHz



802.11n-HT20-5180MHz



802.11n-HT20-5200MHz



802.11n-HT20-5240MHz



802.11ac-VHT20-5180MHz



802.11ac-VHT20-5200MHz

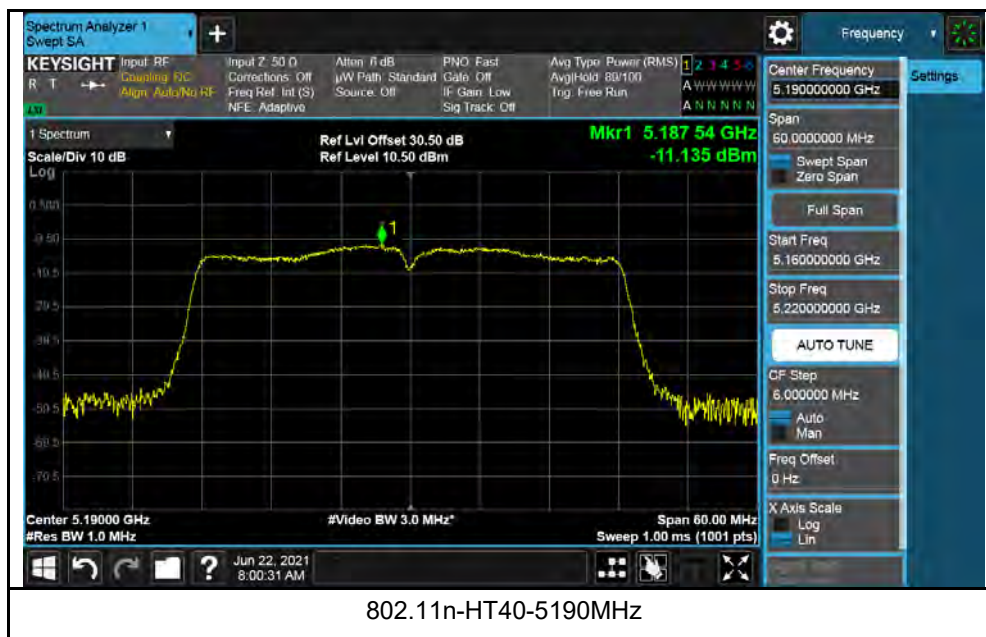
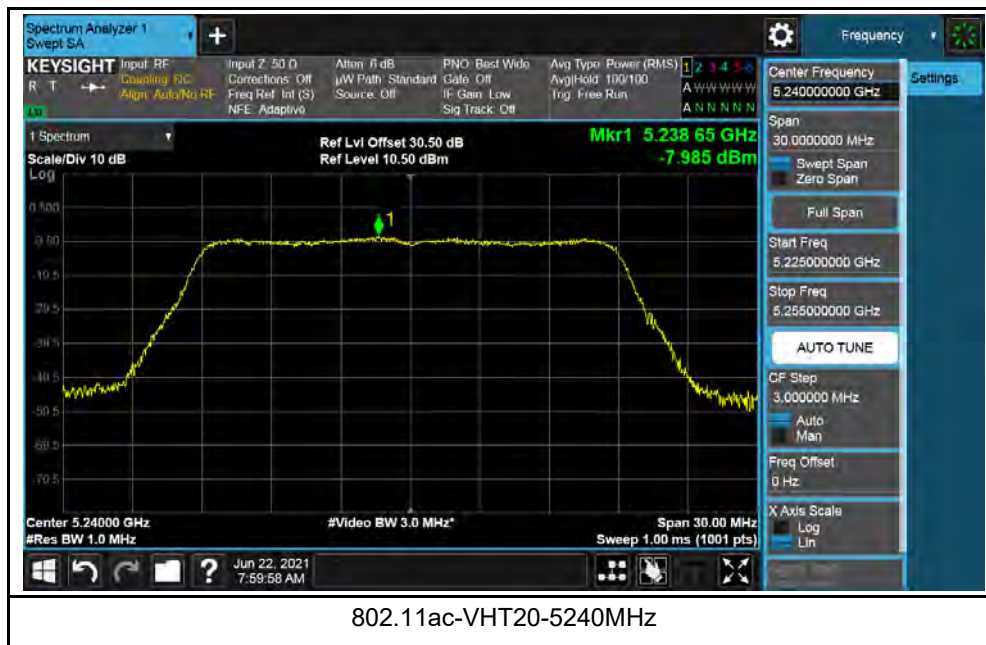



802.11n-HT40-5230MHz



802.11ac-VHT40-5190MHz





802.11ac-VHT40-5230MHz



802.11ac-VHT80-5210MHz

Test Plot for UNII-3 Band:



802.11a-5745MHz



802.11a-5785MHz



802.11a-5825MHz

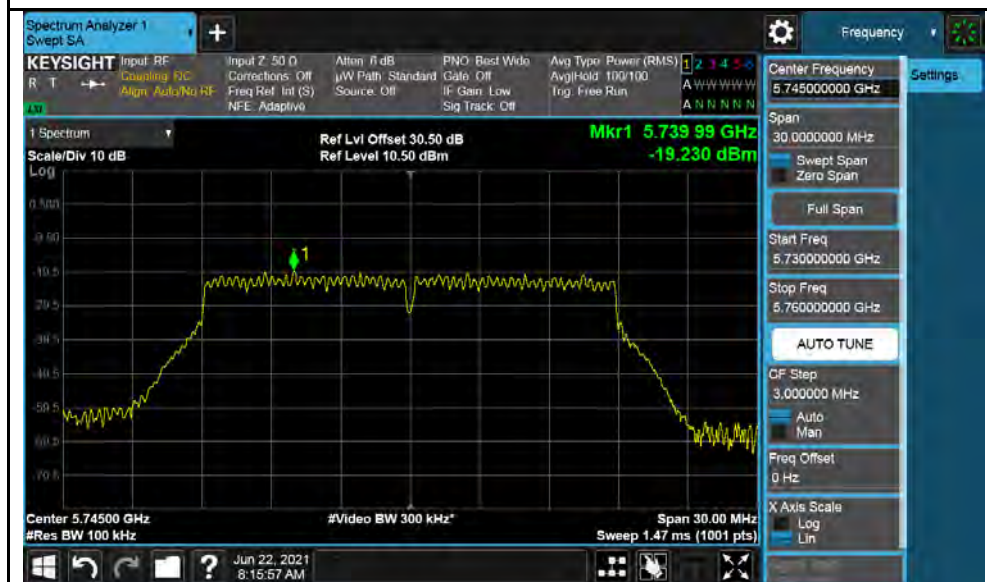

802.11n-HT20-5745MHz



802.11n-HT20-5785MHz



802.11n-HT20-5825MHz



802.11ac-VHT20-5745MHz

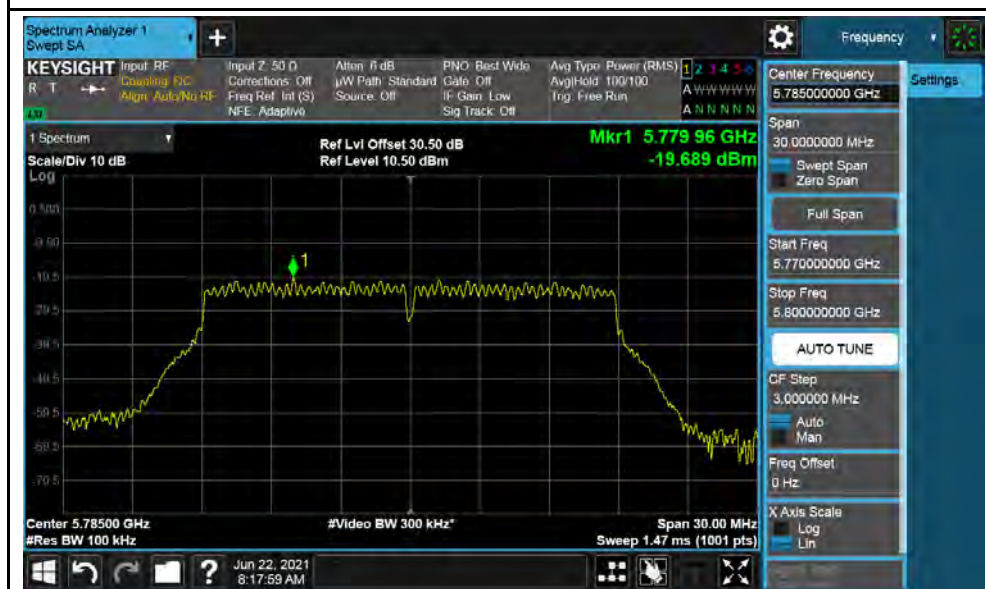

802.11ac-VHT20-5785MHz

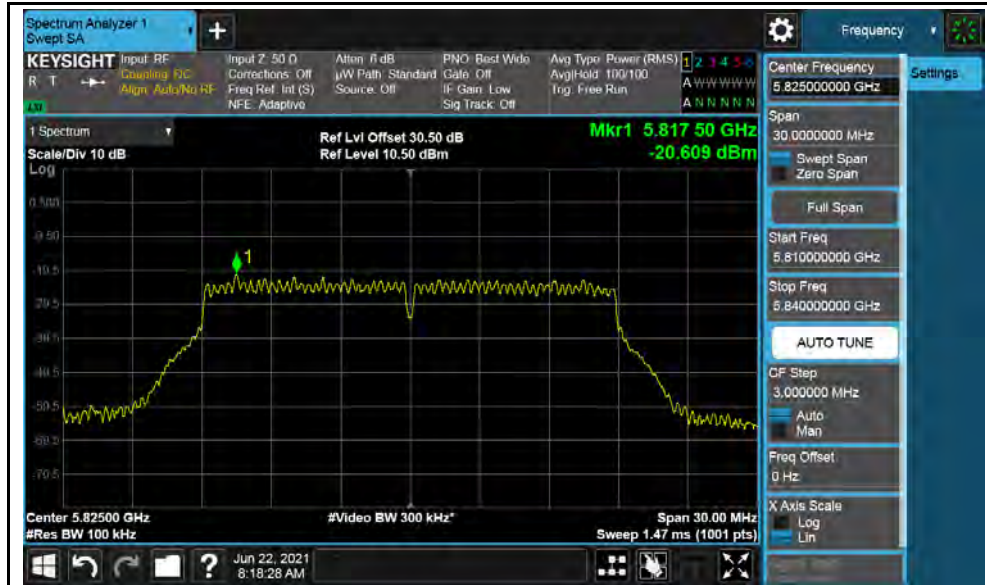

802.11ac-VHT20-5825MHz

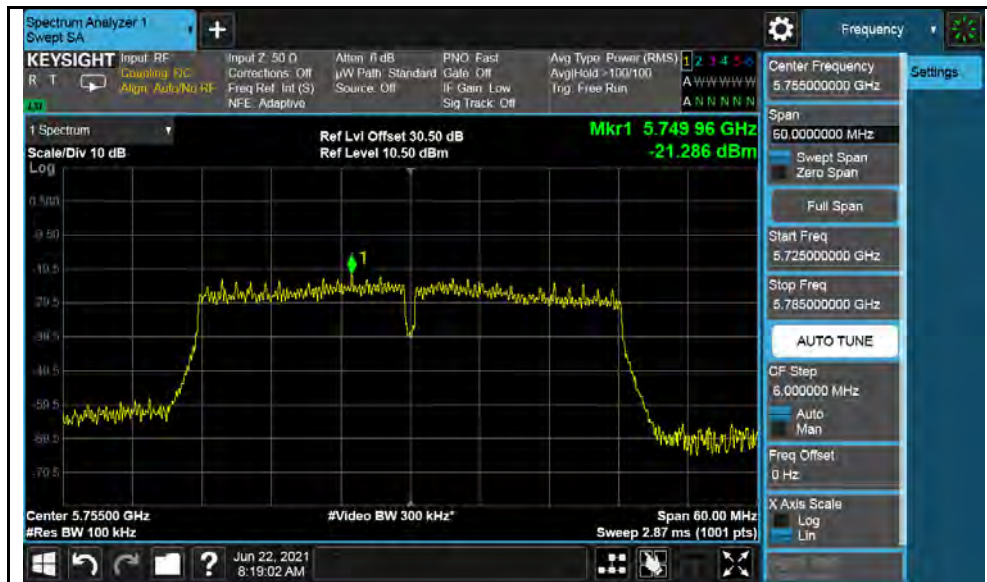

802.11n-HT40-5755MHz

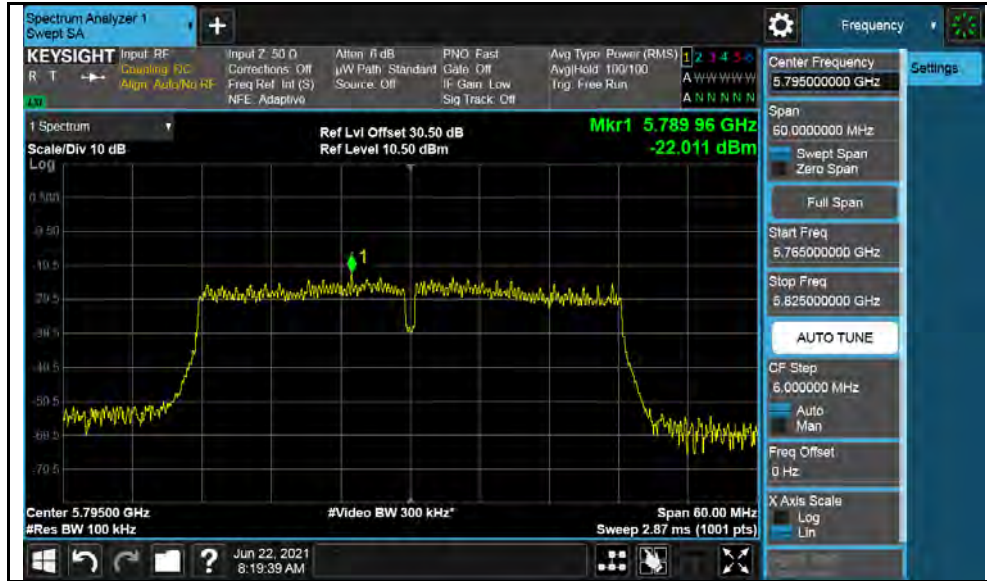

802.11n-HT40-5795MHz



802.11ac-VHT40-5755MHz

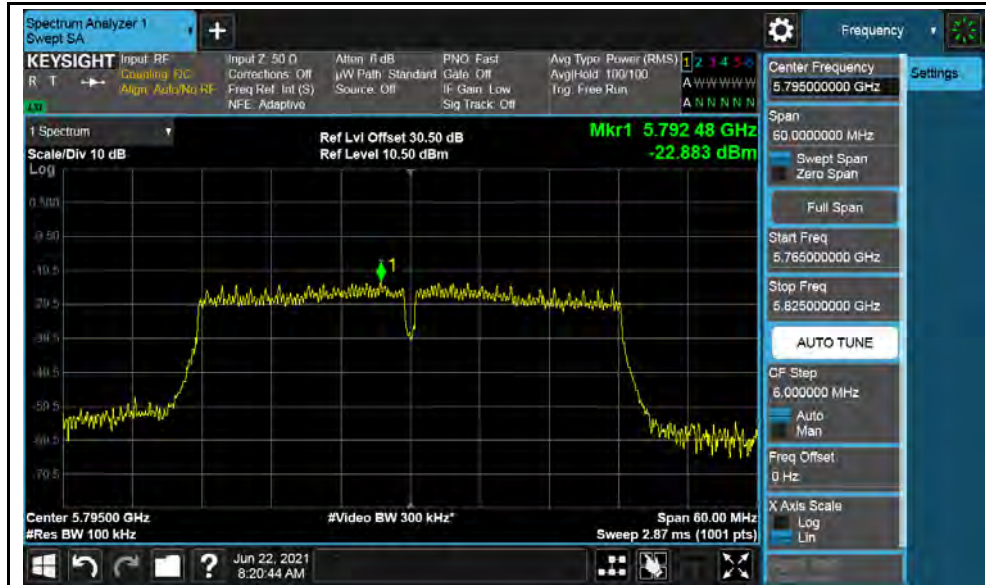

802.11ac-VHT40-5795MHz

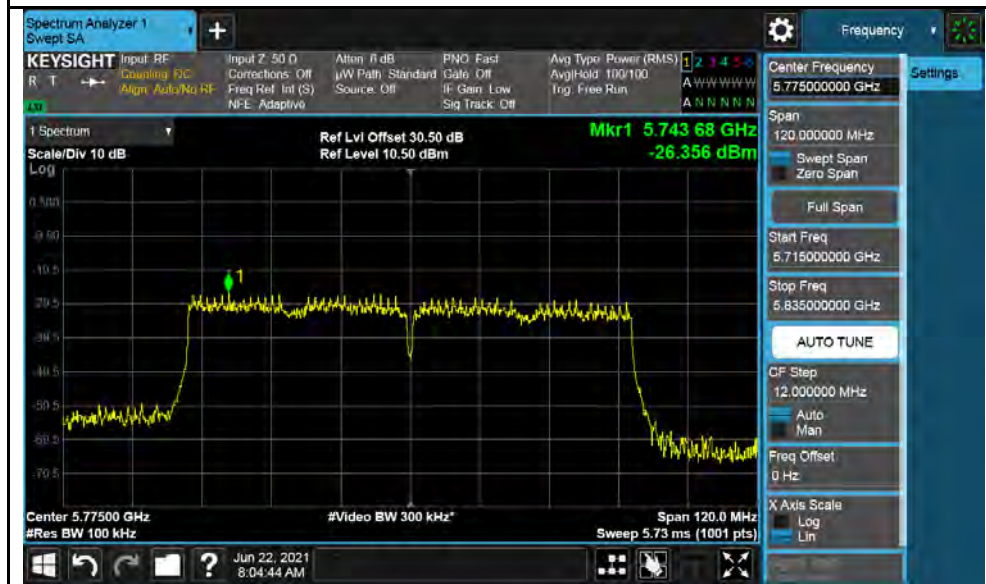

802.11ac-HT80-5775MHz



## 4.6 Frequency Stability Measurement

### 4.6.1 Limits of Frequency Stability Measurement

The frequency of the carrier signal shall be maintained within band of operation.

### 4.6.2 Test Setup

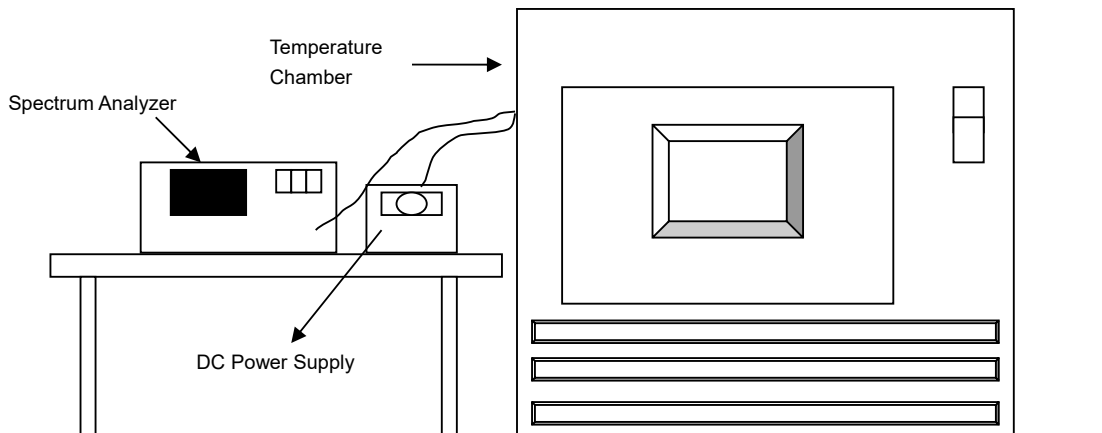

### 4.6.3 Test Instruments

Refer to section 4.1.2 to get information of above instrument.

### 4.6.4 Test Procedure

- The EUT was placed inside the environmental test chamber and powered by nominal DC voltage.
- Turn the EUT on and couple its output to a spectrum analyzer.
- Turn the EUT off and set the chamber to the highest temperature specified.
- Allow sufficient time (approximately 30 min) for the temperature of the chamber to stabilize, turn the EUT on and measure the operating frequency after 2, 5, and 10 Minutes.
- Repeat step (d) with the temperature chamber set to the next desired temperature until measurements down to the lowest specified temperature have been completed..
- The test chamber was allowed to stabilize at +20 degree C for a minimum of 30 Minutes. The supply voltage was then adjusted on the EUT from 85% to 115% and the frequency record.

### 4.6.5 Deviation from Test Standard

No deviation.

### 4.6.6 EUT Operating Condition

Set the EUT transmit at un-modulation mode to test frequency stability.

4.6.7 Test Results

Frequency Stability Versus Temp.									
Operating Frequency: 5180 MHz									
TEMP. (°C)	Power Supply (Vdc)	0 Minute		2 Minute		5 Minute		10 Minute	
		Measured Frequency (MHz)	Pass/Fail	Measured Frequency (MHz)	Pass/Fail	Measured Frequency (MHz)	Pass/Fail	Measured Frequency (MHz)	Pass/Fail
50	12	5179.973	Pass	5180.06234	Pass	5179.98167	Pass	5179.98913	Pass
40	12	5180.050	Pass	5179.99516	Pass	5180.00110	Pass	5180.00202	Pass
30	12	5179.991	Pass	5180.00249	Pass	5179.99216	Pass	5179.99117	Pass
20	12	5179.994	Pass	5180.00197	Pass	5179.99441	Pass	5180.00916	Pass
10	12	5179.976	Pass	5179.97193	Pass	5179.998421	Pass	5180.00841	Pass
0	12	5180.003	Pass	5180.00419	Pass	5179.97138	Pass	5180.98419	Pass
-10	12	5179.974	Pass	5179.98167	Pass	5179.97419	Pass	5179.99555	Pass
-20	12	5179.905	Pass	5179.99128	Pass	5180.00298	Pass	5180.00916	Pass
-30	12	5180.004	Pass	5179.98792	Pass	5179.99110	Pass	5179.99188	Pass

Frequency Stability Versus Voltage									
Operating Frequency: 5180 MHz									
TEMP. (°C)	Power Supply (Vdc)	0 Minute		2 Minute		5 Minute		10 Minute	
		Measured Frequency (MHz)	Pass/Fail	Measured Frequency (MHz)	Pass/Fail	Measured Frequency (MHz)	Pass/Fail	Measured Frequency (MHz)	Pass/Fail
20	13.8	5180.010	Pass	5179.980	Pass	5180.009	Pass	5180.0023	Pass
	12	5179.986	Pass	5179.916	Pass	5180.023	Pass	5180.0018	Pass
	10.2	5180.120	Pass	5180.012	Pass	5179.889	Pass	5179.9812	Pass

## 5 Pictures of Test Arrangements

Please refer to the attached file (Test Setup Photo).

## Appendix – Information on the Testing Laboratories

Bureau Veritas is a global leader in testing, inspection and certification (TIC) services. We help businesses improve safety, sustainability and productivity; and our clients include the majority of leading brands in retail, manufacturing and other industries. With a presence in every major country around the world, our quality assurance and compliance solutions are vital in helping our customers enhance product quality and concept-to-consumer journeys. We also assist with increasing speed to market, profitability and brand equity throughout the supply chain. Bureau Veritas is a leading wireless/IoT testing, inspection, audit and certification provider, with a global network of test laboratories to support the IoT industry in areas of connectivity, security, interoperability as well as quality, health & safety, and environmental/chemical requirements.

If you have any comments, please feel free to contact us at the following:

**Milpitas EMC/RF/Safety/Telecom Lab**

775 Montague Expressway, Milpitas, CA 95035  
Tel: +1 408 526 1188

**Sunnyvale OTA/Bluetooth Lab**

1293 Anvilwood Avenue, Sunnyvale, CA  
94089  
Tel: +1 669 600 5293

**Littleton EMC/RF/Safety/Environmental Lab**

1 Distribution Center Cir #1, Littleton, MA 01460  
Tel: +1 978 486 8880

**Email:** [sales.eaw@us.bureauveritas.com](mailto:sales.eaw@us.bureauveritas.com)

**Web Site:** [www.cps.bureauveritas.com](http://www.cps.bureauveritas.com)

The address and road map of all our labs can be found in our web site also.

--- END ---