



Model: R1 EXT RW 2B MY22

Internal Photos

9 August 2021

Revision 0

Harman International Industries, Inc.

30001 Cabot Drive

Novi, MI 48377

U.S.A.

Table of Contents

Revision History.....	3
Top Casting – Side 1	4
Top Casting – Side 2	5
Bottom Casting – Side 1	6
Bottom Casting – Side 2	7
Main PCB – Side 1	8
Main PCB – Side 2.....	Error! Bookmark not defined. 9

Revision History

Revision	Date	Description
0	9AUG2021	Initial release.

Top Casting – Side 1

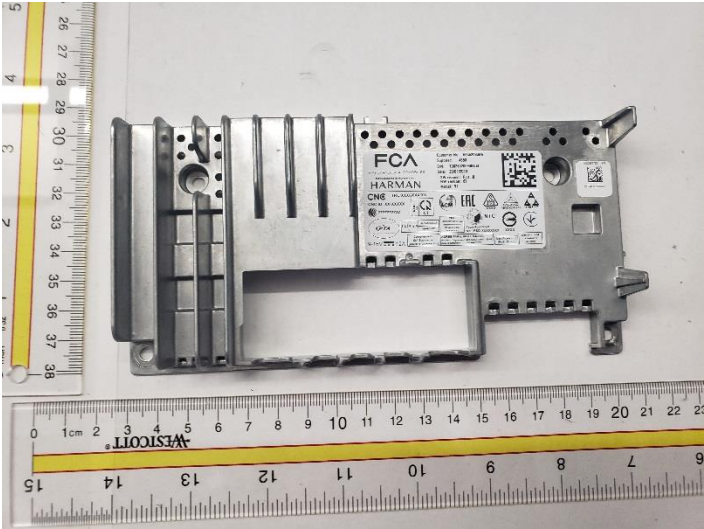

Top Casting – Side 2

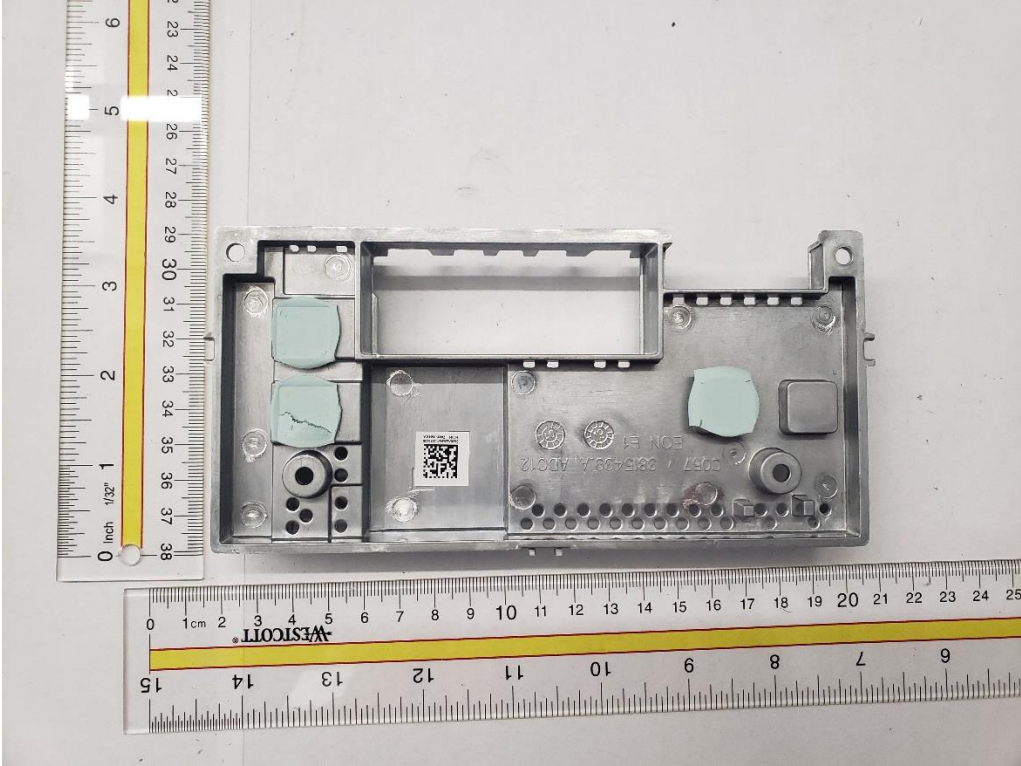

Front Plate – Side 1

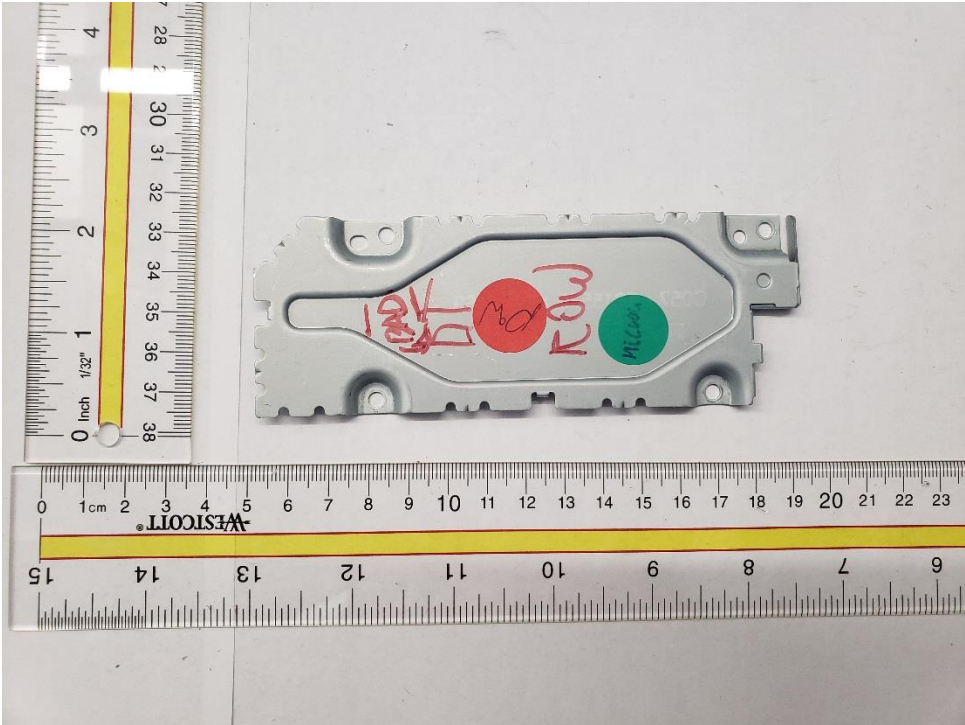

Front Plate – Side 2

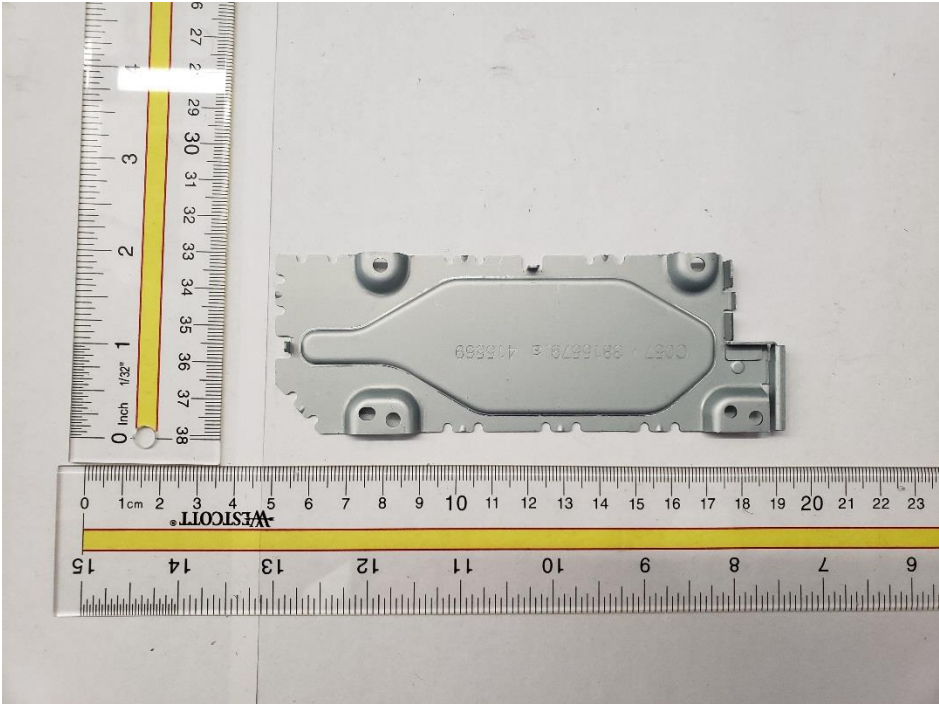

Main PCB – Side 1

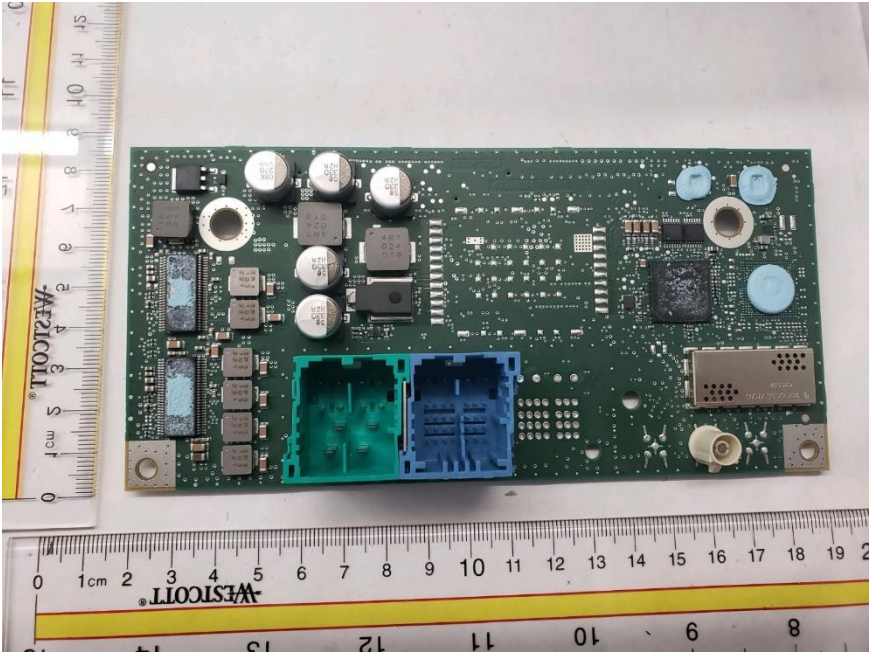

Main PCB – Side 1 (cont)

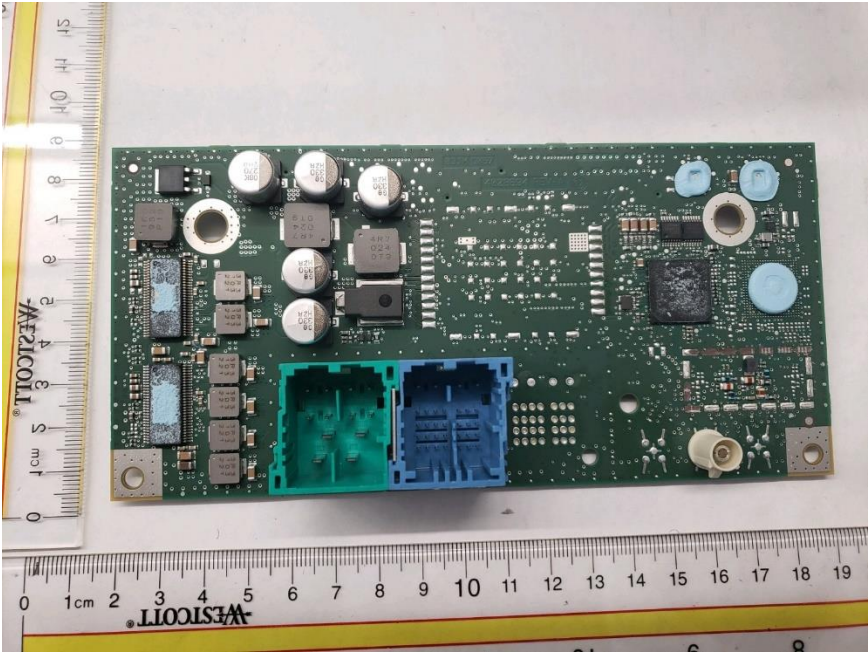

Main PCB – Side 2

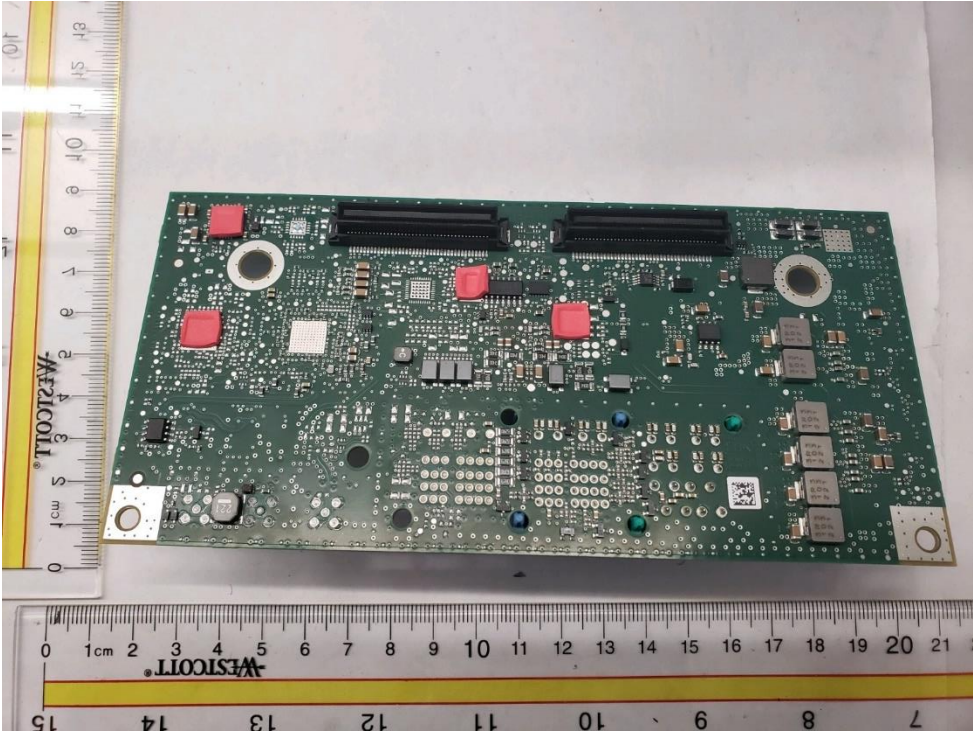

Inner Casting 1 – Side 1

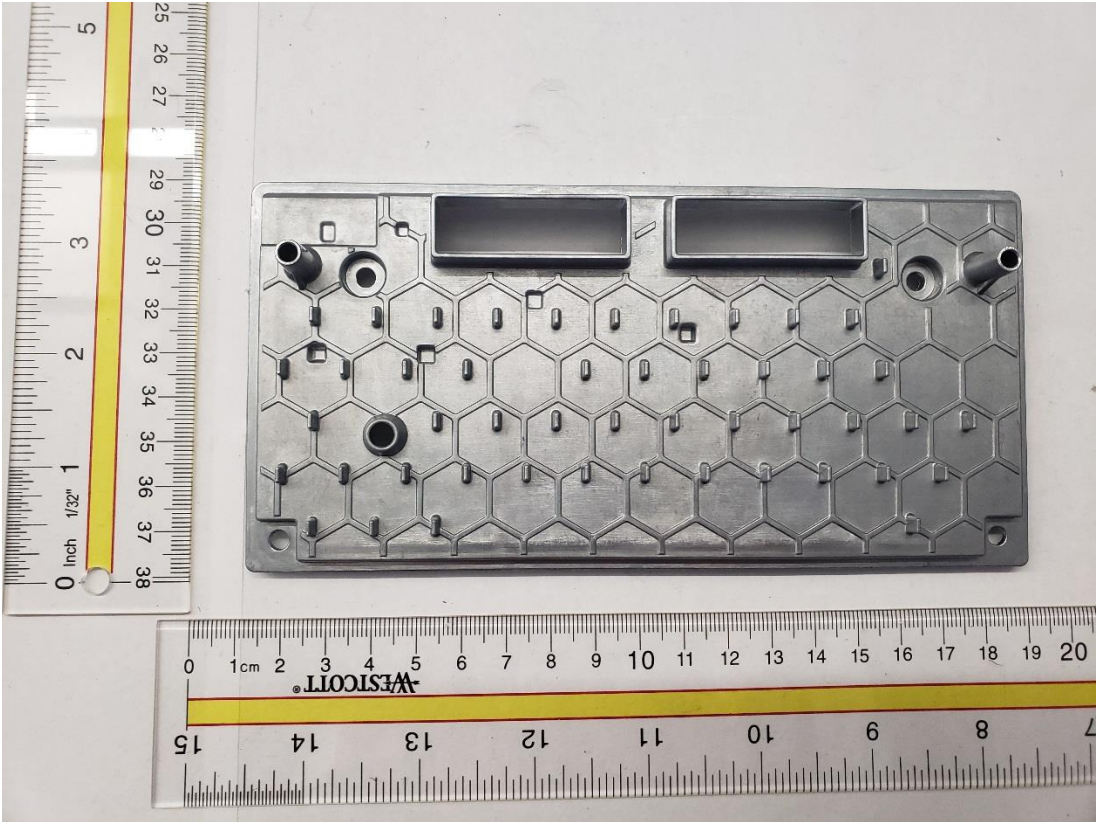

Inner Casting 1 – Side 2

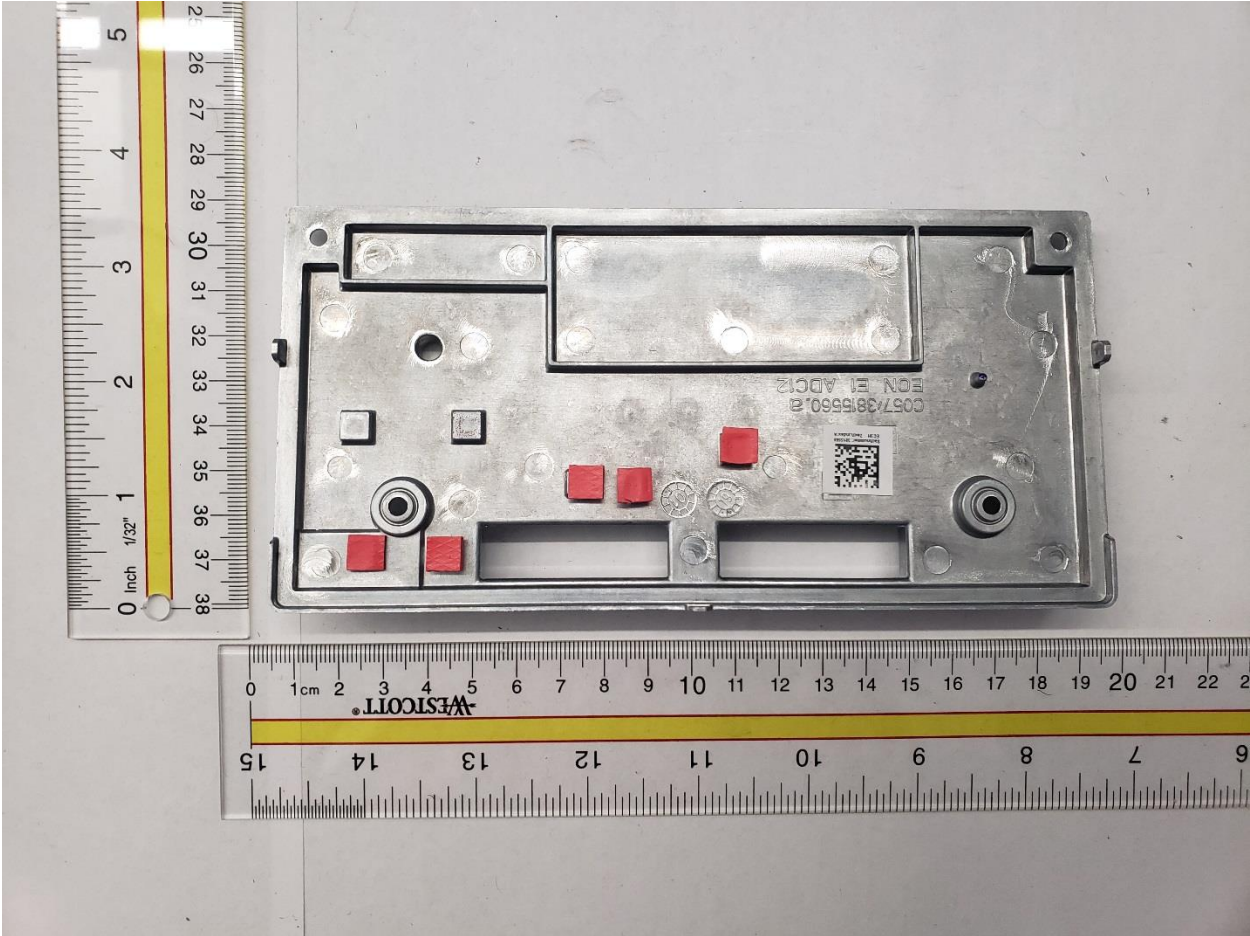

Inner Casting 2 – Side 1

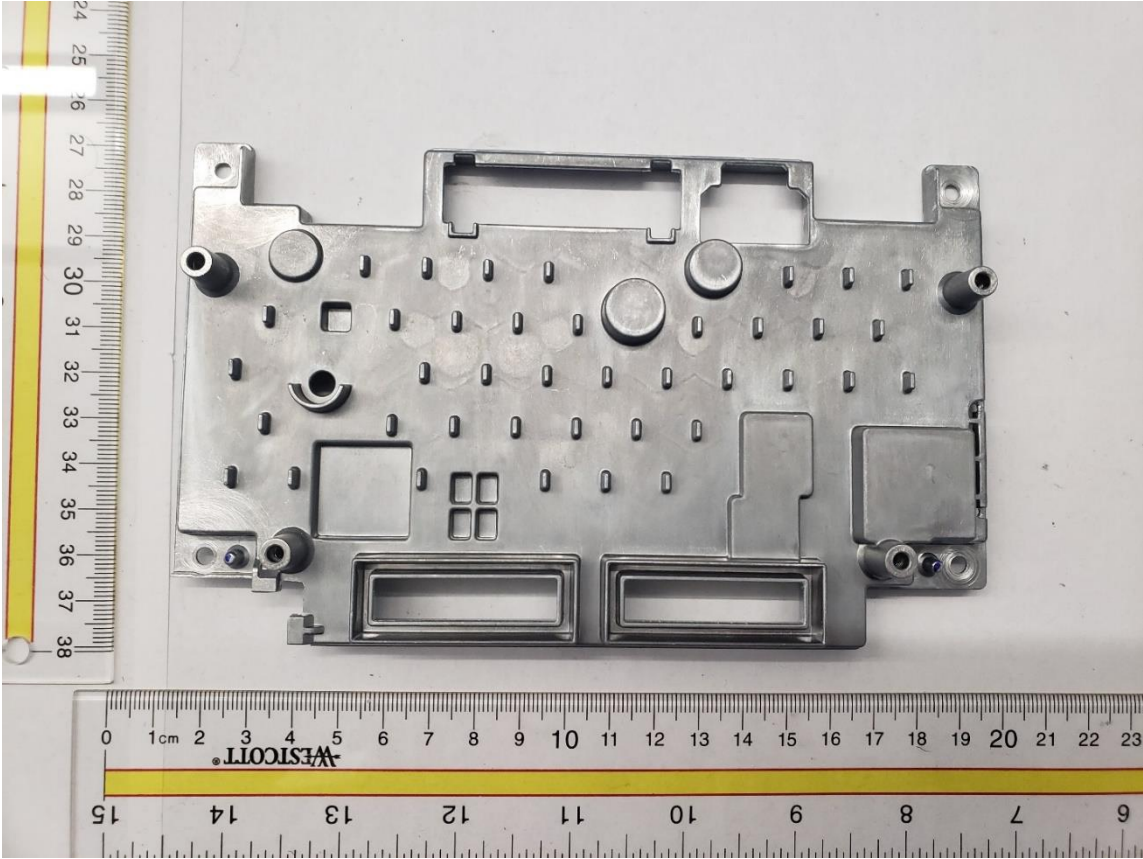

Inner Casting 2 – Side 2

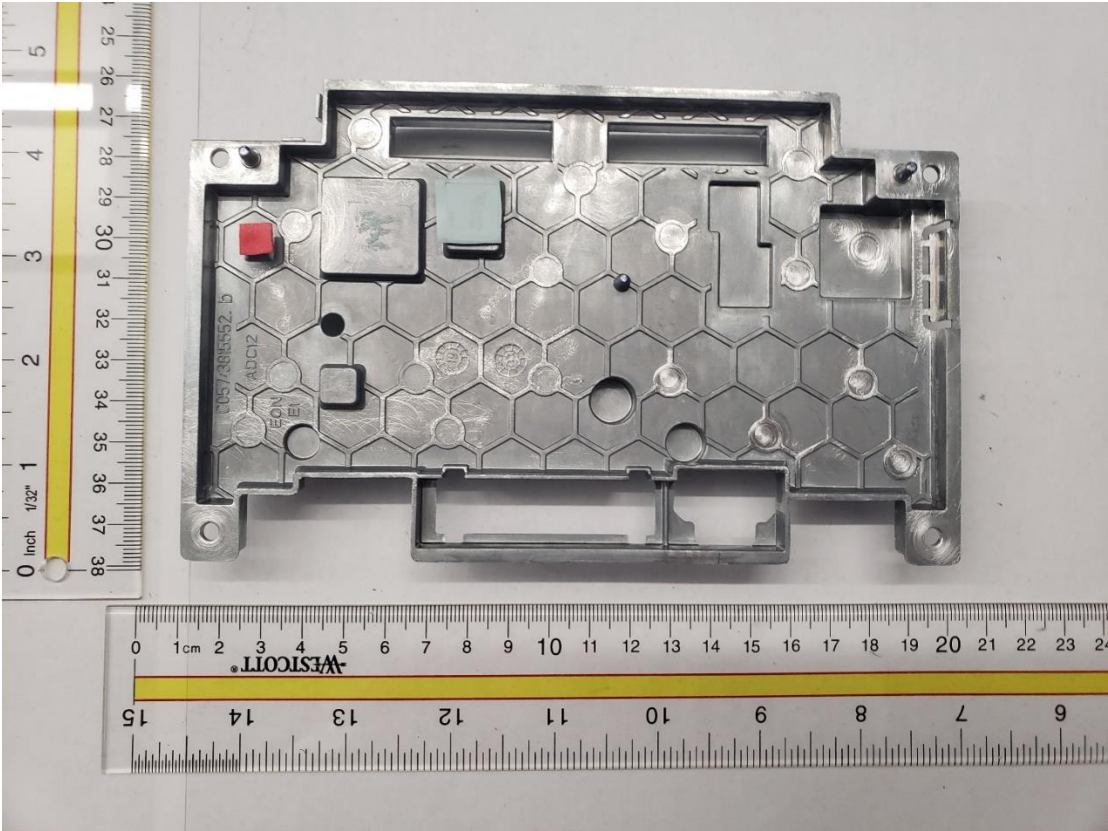

PCB 2 – Side 1

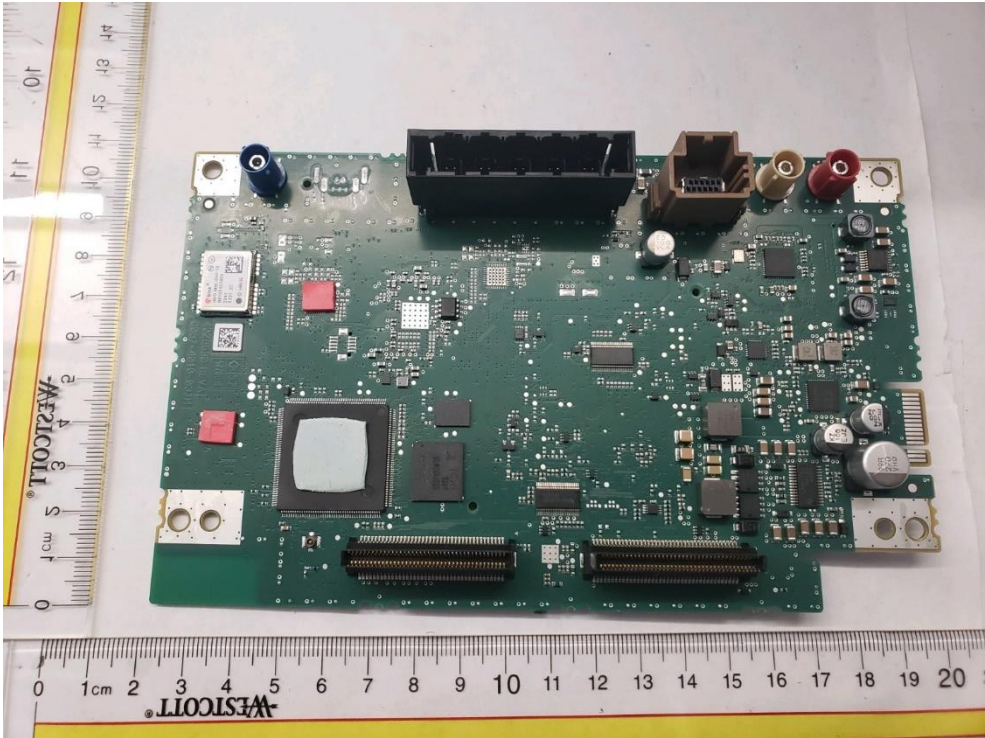

PCB 2 – Side 1

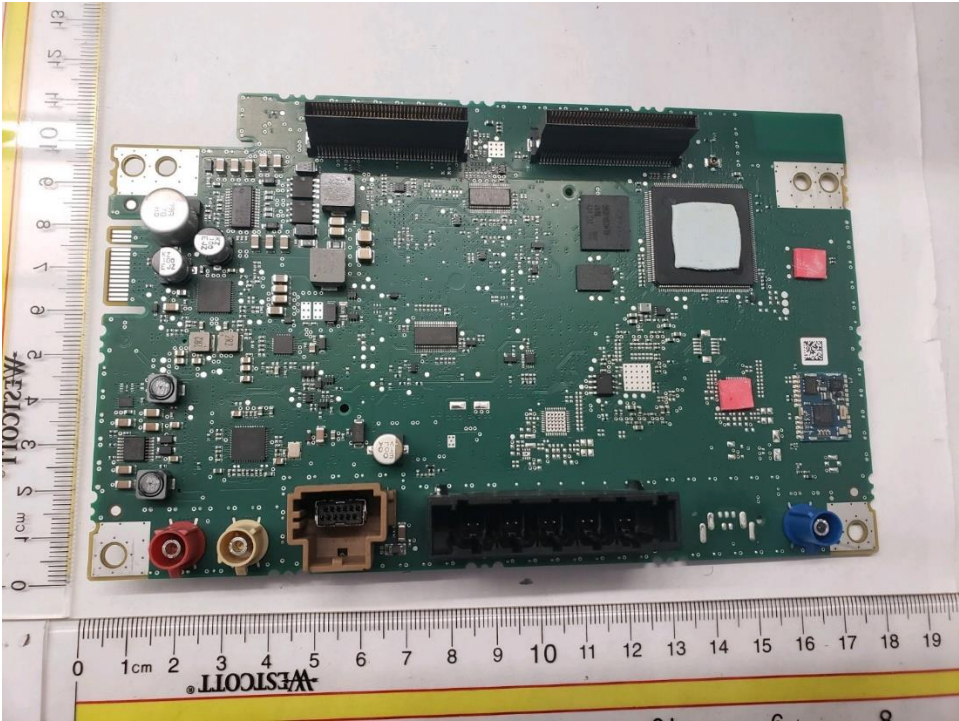

PCB 2 – Side 2



←--- PCB Trace Antenna

PCB 3 – Side 1

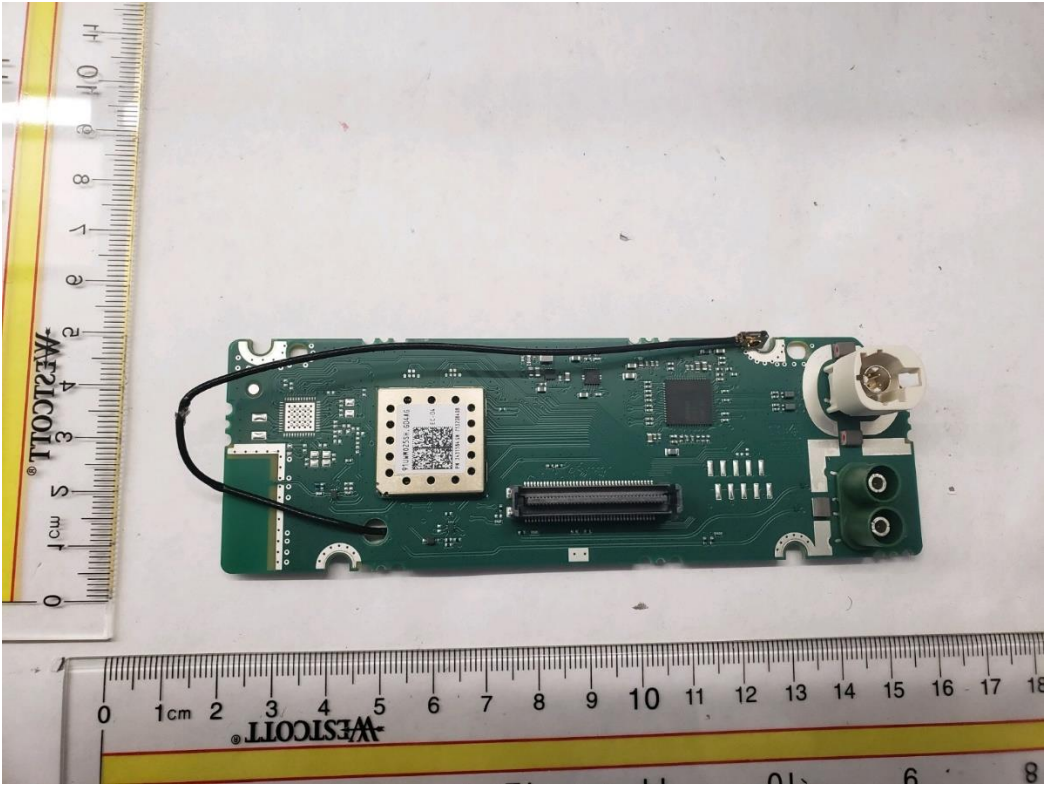

PCB 3 – Side 1 (cont)

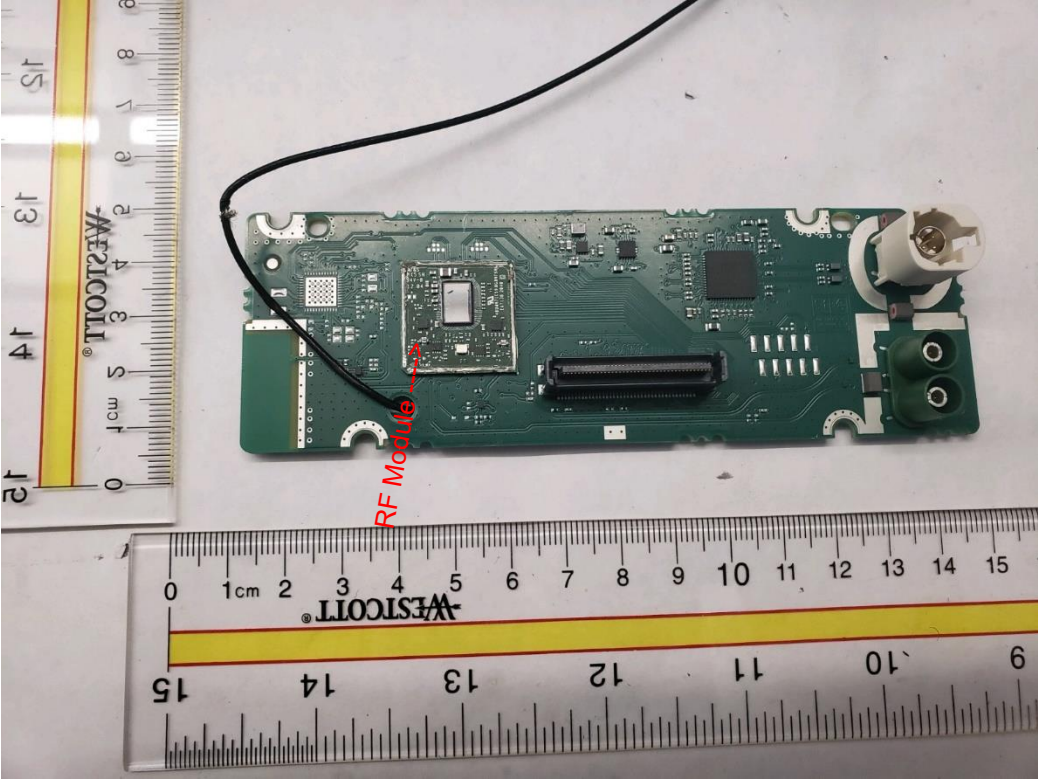

PCB 3 – Side 2

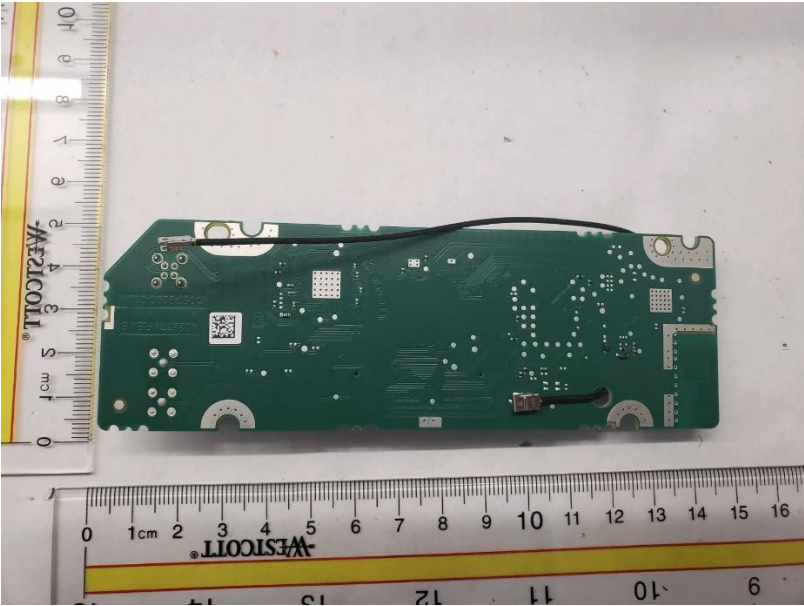

Bottom Casting – Side 1

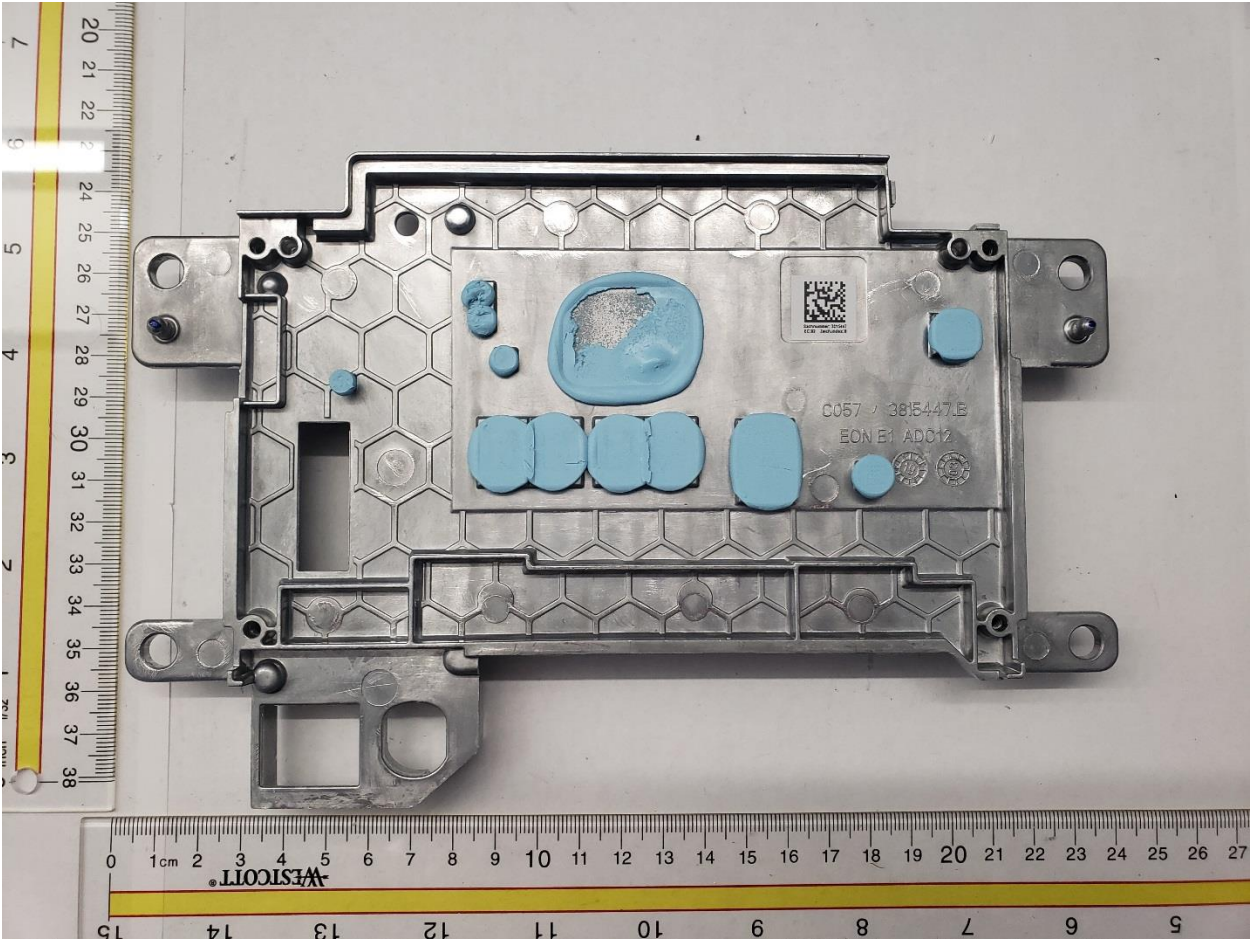

Bottom Casting – Side 2

