

UCONNECT SETTINGS

The Uconnect system uses a combination of buttons on the touchscreen and buttons on the faceplate located on the center of the instrument panel. These buttons allow you to access and change the Customer Programmable Features. Many features can vary by vehicle.

Buttons on the faceplate are located below and/or beside the Uconnect system in the center of the instrument panel. In addition, there is a Scroll/Enter control knob located on the right side. Turn the control knob to scroll through menus and change settings. Push the center of the control knob one or more times to select or change a setting.

Your Uconnect system may also have Screen Off and Mute buttons on the faceplate.

Push the Screen Off button on the faceplate to turn off the Uconnect screen. Push the button again or tap the screen to turn the screen on.

Press the Back Arrow button to exit out of a Menu or certain option on the Uconnect system.

For the Uconnect 5 systems, push and hold the Power button on the radio's faceplate for a minimum of 15 seconds to reset the radio.

CUSTOMER PROGRAMMABLE FEATURES

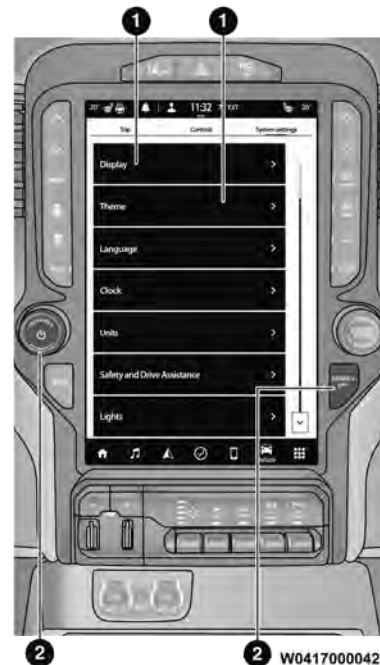

Uconnect 5 NAV With 12-inch Display Touchscreen And Faceplate Buttons

- 1 – Uconnect Buttons On The Touchscreen
- 2 – Uconnect Buttons On The Faceplate

For the Uconnect 3 With 5-inch Display, the Uconnect 5/5 NAV With 8.4-inch Display, and Uconnect 5 NAV With 12-inch Display

For the Uconnect 3 system, push the Settings button on the top of the faceplate. In this menu, the Uconnect system allows you to access all of the available programmable features.

For the Uconnect 5 systems, press the Vehicle button, then press the Settings tab at the top of the touchscreen. In this menu, the Uconnect system allows you to access all of the available programmable features.

5

NOTE:

- Only one touchscreen may be selected at a time.
- Depending on the vehicle's options, feature settings may vary.

When making a selection, only press one button at a time to enter the desired menu. Once in the desired menu, press and release the preferred setting option until a check mark appears next to the setting, showing that setting has been selected. Once the setting is complete, press the X button on the touchscreen to close out of the settings screen. Pressing the Up or Down Arrow button on the right side of the screen will allow you to toggle up or down through the available settings.

238 MULTIMEDIA**My Profile**

When the My Profile button is pressed on the touchscreen, the system displays options related to the vehicle's profiles.

| Setting Name | Description |
|--|---|
| Language | This setting will change the language of the Uconnect system and Instrument Cluster Display. The available languages are English, Français, and Español. |
| Display Mode | This setting will adjust the display for the radio to "Auto" or "Manual". "Manual" allows for more customization with the radio display. |
| Display Brightness Headlights On | This setting will allow you to set the brightness when the headlights are on. To access this setting, Display Mode must be set to "Manual". The "+" setting will increase the brightness; the "-" will decrease the brightness. |
| Display Brightness Headlights Off | This setting will allow you to set the brightness when the headlights are off. To access this setting, Display Mode must be set to "Manual". The "+" setting will increase the brightness; the "-" will decrease the brightness. |
| Set Theme | This setting will allow you to change the display theme. |
| Units | This setting will allow you to change the units to "US", "Metric", or "Custom". The available options within Custom are "Speed" (MPH or km/h), "Distance" (mi or km), "Fuel Consumption" (MPG [US], MPG [UK], L/100 km, or km/L), "Pressure" (psi, kPa, or bar), "Temperature" (°C or °F), Power" (HP [US], Gal HP [UK], or kW), and "Torque" (lb-ft or Nm) units of measurement independently. |
| Touchscreen Beep | This setting will allow you to turn the touchscreen beep on or off. |
| Show Main Category Bar Labels | This setting will allow the main category bar labels to be shown on or off. |
| Navigation Next Turn Pop-ups Displayed in Cluster | This setting will display navigation prompts in the Instrument Cluster Display. |
| Phone Pop-ups Displayed In Cluster | This setting will display smartphone notifications and messages in the Instrument Cluster Display. |

| Setting Name | Description |
|--|---|
| Time Format | This setting will allow you to set the time format (AM/PM). Sync Time With GPS must be "Off" for this setting to be available. The "12 hrs" setting will set the time to a 12-hour format. The "24 hrs" setting will set the time to a 24-hour format. |
| Voice Options | This setting will allow you to change the voice options for the radio to "Male" or "Female". |
| Wake Up Word | This setting will allow you to set the system "Wake Up" word. The available options are "Off", "Hey, Uconnect", and "Hey, Ram". |
| Voice Barge-in | This setting will allow Voice Barge-in to be turned on or off. |
| Show Command List | This setting will allow the Command List to be shown. The options are "On" and "Off". |
| Navigation Settings – If Equipped | This setting will redirect to the list of Navigation settings. Refer to the Owner's Manual Supplement for further information. |
| Auto-On Driver Heated/Ventilated Seat & Heated Steering Wheel – If Equipped | This setting will activate the vehicle's comfort system and heated seats or heated steering wheel when the vehicle is remote started or ignition is started. The "Off" setting will not activate the comfort systems. The "Remote Start" setting will only activate the comfort systems when using Remote Start. The "All Start" setting will activate the comfort systems whenever the vehicle is started. |
| Radio Power Off | This setting will keep certain electrical features running after the engine is turned off. When any door is opened, the electronics will deactivate. The available settings are "0 sec", "45 sec", "5 min", and "10 min". |
| Radio Off With Door | This setting will allow you to determine if the radio shuts off when any of the doors are opened. |

240 MULTIMEDIA

| Setting Name | Description |
|---|---|
| Audio Settings | This setting will open the submenu, containing the audio settings ➤ page 253. |
| App Drawer Favoriting Pop-ups | This setting will allow you to favorite app drawer pop-ups with “On” and “Off” options. |
| App Drawer Unfavoritings Pop-ups | This setting will allow you to unfavorite app drawer pop-ups with “On” and “Off” options. |
| New Text Message Pop-ups | This setting will allow you to have pop-up notifications for new text messages. Setting options are “On” and “Off”. |
| Missed Calls Message | This setting will allow you to have pop-up notifications for missed calls. Setting options are “On” and “Off”. |
| Navigation Pop-ups | This setting will allow you to have pop-up notifications for Navigation. Setting options are “On” and “Off”. |
| Reset App Drawer to Default Order | This setting will reset the app drawer to its factory default layout. |
| Restore Settings to Default | This setting will return all the previously changed settings to their factory default. |
| Trip B | This setting will turn the Trip B feature in the cluster on or off. |
| Audio Info On Cluster | This setting will turn the audio info on the cluster on or off. |
| Digital Speed On All Cluster Screens | This setting will show the digital speedometer on all cluster screens. |
| Consumption Bar On Cluster Screen | This setting will show the digital fuel consumption bar on all cluster screens. |
| Custom Areas On Cluster | This setting will allow you to customize the information displayed on the cluster. |

| Setting Name | Description |
|-----------------------------|--|
| Head Up Display | This setting will turn the Head Up Display (HUD) on or off. |
| HUD Brightness | This setting will adjust the brightness of the Head Up Display. |
| HUD Height | This setting will adjust the Head Up Display height. |
| HUD Content | This setting will adjust the amount of content displayed on the Head Up Display. The available options are "Simple", "Standard", and "Advanced". |
| Audio Repetition | This setting will turn the system audio repetition on or off. |
| More Profile Options | This setting will give access to more profile options. |

Display

When the Display button is pressed on the touchscreen, the system will display the options related to the theme (if equipped), brightness, and color of the touchscreen. The available settings are:

5

| Setting Name | Description |
|---|--|
| Language | This setting will change the language of the Uconnect system and Instrument Cluster Display. The available languages are English, Français, and Español. |
| Display Mode | This setting will allow you to set the brightness manually or have the system set it automatically. The "Auto" setting has the system automatically adjust the display brightness. The "Manual" setting will allow the user to adjust the brightness of the display. |
| Display Brightness With Headlights ON/Brightness | This setting will allow you to set the brightness when the headlights are on. To access this setting, Display Mode must be set to Manual. The "+" setting will increase the brightness; the "-" will decrease the brightness. |

242 MULTIMEDIA

| Setting Name | Description |
|--|--|
| Display Brightness With Headlights OFF/Brightness | This setting will allow you to set the brightness when the headlights are off. To access this setting, Display Mode must be set to Manual. The "+" setting will increase the brightness; the "-" will decrease the brightness. |
| Set Theme | This setting will allow you to change the display theme. |
| Units | This setting will allow you to change the units. The available options are "Speed" (MPH or km/h), "Distance" (mi or km), "Fuel Consumption" (MPG [US], MPG [UK], L/100 km, or km/L), "Pressure" (psi, kPa, or bar), "Temperature" (°C or °F), Power" (HP [US], Gal HP [UK], or kW), and "Torque" (lb-ft or Nm) units of measurement independently. |
| Touchscreen Beep | This setting will allow you to turn the touchscreen beep on or off. |
| Control Screen Timeout | This setting allows you to set the Control Screen to turn off automatically after five seconds or stay open until manually closed. |
| Navigation Next Turn Pop-ups Displayed in Cluster | This setting will display navigation prompts in the Instrument Cluster Display. |
| Phone Pop-ups Displayed In Cluster | This setting will display smartphone notifications and messages in the Instrument Cluster Display. |
| Fuel Saver Display | This setting will enable fuel saver mode in the Instrument Cluster Display. |
| Ready To Drive Pop-ups – If Equipped | This setting will enable the Ready To Drive Pop-ups in the Instrument Cluster Display. |

Safety/Driving Assistance

When the Safety/Driving Assistance button is selected on the touchscreen, the system displays the options related to the vehicle's safety settings. These options will differ depending on the features equipped on the vehicle. The settings may display in list form or within subfolders on the screen. To access a subfolder, select the desired folder; the available options related to that feature will then display on the screen.

| Setting Name | Description |
|--|---|
| Forward Collision Warning Sensitivity | This setting will change the distance at which the Forward Collision Warning (FCW) alert sounds. The "Medium" setting will have the FCW system signal when an object is in view, and the possibility of a collision is detected. The "Near" setting will have the FCW system signal when the object is closer to the vehicle. The "Far" setting will have the FCW system signal when an object is at a far distance from the vehicle. |
| Forward Collision Warning | This setting will turn the Forward Collision Warning system on or off. The "Off" setting will deactivate the FCW system. The "Warning Only" setting will provide only an audible chime when a collision is detected. The "Warning + Active Braking" setting will provide an audible chime and apply some brake pressure when a collision is detected. |
| Pedestrian Emergency Braking | This setting will turn the Pedestrian Emergency Braking system on or off. |
| LaneSense Warning | This setting will change the distance at which the steering wheel will provide lane departure feedback. The available settings are "Early", "Medium", and "Late". |
| LaneSense Strength | This setting will change the strength of the steering wheel feedback during a lane departure. The available settings are "Low", "Medium", and "High". |
| ParkSense | This setting will change the type of ParkSense alert when a close object is detected and provide both an audible chime and a visual display. |

244 MULTIMEDIA

| Setting Name | Description |
|---|--|
| Front ParkSense Volume | This setting adjusts the volume of the Front ParkSense system. The available settings are “Low”, “Medium”, and “High”. |
| Rear ParkSense Volume | This setting adjusts the volume of the Rear ParkSense system. The available settings are “Low”, “Medium”, and “High”. |
| Rear ParkSense Braking Assist | This setting will turn the Rear ParkSense Braking Assist on or off. |
| Blind Spot Alert | This setting will change the type of alert provided when an object is detected in a vehicle’s blind spot. The “Off” setting will turn off Blind Spot Alert. The “Lights” setting will activate the Blind Spot Alert lights on the outside mirrors. The “Lights & Chime” setting will activate both the lights on the outside mirrors and an audible chime. |
| Trailer Length For Blind Spot Alert | This setting will auto detect the length of an attached trailer. The “Auto” setting will have the system automatically set the trailer length. The “Max” setting will always set the length to the maximum 39.5 ft (12 m). |
| Hill Start Assist | This setting will turn the Hill Start Assist system on or off. |
| ParkView Backup Camera Delay | This setting will add a timed delay to the ParkView Backup Camera when shifting out of REVERSE. |
| ParkView Backup Camera Active Guidelines | This setting will turn the ParkView Backup Camera Active Guidelines on or off. |
| ParkView Backup Camera Fixed Guidelines | This setting will turn the ParkView Backup Camera Fixed Guidelines on or off. |
| Tire Fill Assist | This setting will turn Tire Fill Assist on or off. |
| Power Side Steps | This setting will raise and lower or stow the power side steps. The available options are “Automatic” to raise and lower the power side steps and “Stow” to deactivate the power side steps. |

Clock

When the Clock button is pressed on the touchscreen, the system displays the different options related to the vehicle's internal clock.

| Setting Name | Description |
|--|--|
| Sync Time With GPS | This setting will sync the time to the GPS receiver in the system. The system will control the time via the GPS location. |
| Set Time And Format/Time Format | This setting will allow you to set the time format (AM/PM). Sync Time With GPS must be off for this setting to be available. The "12 hrs" setting will set the time to a 12-hour format. The "24 hrs" setting will set the time to a 24-hour format. |
| Set Time Hours | This setting will allow you to set the hours. Sync Time With GPS must be off for this setting to be available. The "+" setting will increase the hours. The "-" setting will decrease the hours. |
| Set Time Minutes | This setting will allow you to set the minutes. Sync Time With GPS must be off for this setting to be available. The "+" setting will increase the minutes. The "-" setting will decrease the minutes. |
| Show Time in Status Bar | This setting will place the time in the radio's status bar. |

5

Phone/Bluetooth®

When the Phone/Bluetooth® button is pressed on the touchscreen, the system displays the options related to Bluetooth® connectivity from an external audio device or smartphone. The list of paired audio devices or smartphones can be accessed from this menu.

| Setting Name | Description |
|---------------------------|--|
| Device Manager | This setting will open the Device Manager main screen. |
| Do Not Disturb All | This setting will open the Do Not Disturb settings menu. The available options are "On" and "Off". |

246 MULTIMEDIA

| Setting Name | Description |
|---|---|
| Enable Two Active Phones | This setting will enable or disable two active phones within the vehicle. The setting options are “On” and “Off”. |
| Phone Pop-Ups Displayed In Cluster | This setting will activate phone message pop-ups in the Instrument Cluster Display. |

Voice

When the Voice button is pressed on the touchscreen, the system displays the options related to the vehicle’s Voice Recognition feature.

| Setting Name | Description |
|--------------------------|--|
| Voice Options | This setting will allow you to change the system’s voice to either “Male” or “Female”. |
| Wake Up Word | This setting will allow you to set the system’s “Wake Up” word. The available options are “Off”, “Hey, Uconnect”, and “Hey, Ram”. |
| Voice Barge-In | This setting allows you to respond to a Voice Response before the statement is completed by the system. The available options are “On” and “Off”. |
| Show Command List | This setting will allow you to turn the Command List on or off. The “Always” setting will always show the Command List. The “With Help” setting will show the Command List and provide a brief description of what the command does. The “Never” setting will turn the Command List off. |

Navigation – If Equipped

When the Navigation button is pressed on the touchscreen, the system displays options related to the vehicle’s built-in Navigation system. These settings can change which icons display on the map, how “time to arrival is calculated”, and route types.

For more information on Navigation and settings, refer to the Uconnect Owner’s Manual Supplement.

Trailer Brake/Trailer — If Equipped

When the Trailer Brake/Trailer button is pressed on the touchscreen, the system will display settings related to trailer towing.

| Setting Name | Description |
|---------------------------|---|
| Trailer Select | Select from “Trailer 1”, “Trailer 2”, “Trailer 3”, and “Trailer 4”. These trailer designations can be used to save different trailer settings. |
| Trailer Brake Type | This setting will set the system to a specific trailer type. The available options are “Light Electric”, “Heavy Electric”, “Light Electric-Over-Hydraulic”, and “Heavy Electric-Over-Hydraulic”. |
| Trailer Name | This setting will personalize the trailer name depending on the type of trailer you are hauling. Select the trailer name from the following list: trailer, boat, car, cargo, dump, equipment, flatbed, gooseneck, horse, livestock, motorcycle, snowmobile, travel, utility, and 5th wheel. |

5

Camera — If Equipped

When the Camera button is pressed on the touchscreen, the system displays the options related to the vehicle’s camera features.

| Setting Name | Description |
|---|---|
| Surround View Camera Delay | This setting will add a timed delay to the Surround View Camera when shifting out of REVERSE. |
| Surround View Camera Guidelines | This setting will turn the Surround View Camera Guidelines on or off. |
| ParkView Backup Camera Delay | This setting will add a timed delay to the ParkView Backup Camera when shifting out of REVERSE. |
| ParkView Backup Camera Active Guidelines | This setting will turn the ParkView Backup Camera Active Guidelines on or off. |
| ParkView Backup Camera Fixed Guidelines | This setting will turn the ParkView Backup Camera Fixed Guidelines on or off. |

248 MULTIMEDIA**Mirrors & Wipers**

When the Mirrors & Wipers button is pressed on the touchscreen, the system displays the options related to the vehicle's mirrors and wipers.

| Setting Name | Description |
|-------------------------------------|---|
| Tilt Side Mirrors In Reverse | This setting will tilt the outside side-view mirrors when the ignition is in the ON/RUN position and the transmission gear selector is in the REVERSE position. The mirrors will move back to their previous position when the transmission is shifted out of REVERSE. The available settings are "On" and "Off". |
| Rain Sensing Auto Wipers | This setting will turn the Rain Sensing Auto Wipers on or off. |
| Headlights With Wipers | This setting will turn the headlights on when the wipers are activated. |

Lights

When the Lights button is pressed on the touchscreen, the system displays the options related to the vehicle's exterior and interior lights.

NOTE:

When the "Daytime Running Lights" feature is selected, the daytime running lights can be turned on or off. This feature is only allowed by law in the country of the vehicle purchased.

| Setting Name | Description |
|---|--|
| Headlight Off Delay | This setting will allow you to set the amount of time it takes for the headlights to shut off after the vehicle is turned off. The available settings are "0 sec", "30 sec", "60 sec", and "90 sec". |
| Headlight Illumination On Approach | This setting will allow you to set the amount of time it takes for the headlights to shut off after the vehicle is unlocked. The available settings are "0 sec", "30 sec", "60 sec", and "90 sec". |
| Headlights with Wipers | This setting will turn the headlights on when the wipers are activated. |

| Setting Name | Description |
|---------------------------------|---|
| Daytime Running Lights | This setting will allow you to turn the Daytime Running Lights on or off. |
| Flash Lights With Lock | This setting will allow you to turn the flashing of the lights when the Lock button is pushed on the key fob on or off. |
| Auto Dim High Beams | This setting will allow you to turn the Auto Dim High Beams on or off. |
| Steering Directed Lights | This setting will turn the headlights with the steering wheel. The available options are "On" and "Off". |

Brakes

After pressing the Brakes button on the touchscreen, the following settings will be available:

5

| Setting Name | Description |
|------------------------|--|
| Auto Park Brake | This setting will turn the Auto Park Brake on or off. |
| Brake Service | This setting will allow you to retract the brakes for servicing. |

Doors & Locks

When the Doors & Locks button is pressed on the touchscreen, the system displays the options related to locking and unlocking the vehicle's doors.

| Setting Name | Description |
|----------------------------|--|
| Auto Door Locks | This setting will allow you to change if the doors lock automatically when the vehicle reaches 12 mph (19 km/h). |
| Auto Unlock On Exit | This setting will unlock the doors when any of the doors are opened from the inside. |

250 MULTIMEDIA

| Setting Name | Description |
|---|--|
| Flash Lights With Lock | This setting will allow you to turn the flashing of the lights when the Lock button is pushed on the key fob on or off. |
| Sound Horn With Lock | This setting will sound the horn when the Lock button is pushed on the key fob. The "Off" setting will not sound the horn when the Lock button is pushed. The "1st Press" setting will sound the horn when the Lock button is pushed once. The "2nd Press" setting will sound the horn when the Lock button is pushed twice. |
| Sound Horn With Remote Start | This setting will sound the horn when the remote start is activated from the key fob. |
| Remote Door Unlock, Door Lock/1st Press Of Key Fob Unlocks | This setting will change how many pushes of the Unlock button on the key fob are needed to unlock all the doors. The "Driver Door" setting will only unlock the driver door on the first push on the Unlock button. The "All Doors" setting will unlock all doors with only one push of the Unlock button. |
| Passive Entry | This setting will allow you to turn the Passive Entry feature (Keyless Enter-N-Go™) on or off. |
| Personal Settings Linked To Key Fob | This setting will recall preset radio stations and driver seat position that have been linked to the key fob. |

Seats & Comfort/Auto-On Comfort Systems — If Equipped

When Seats & Comfort/Auto-On Comfort Systems button is pressed on the touchscreen, the system displays the options related to the vehicle's comfort systems when remote start has been activated or the vehicle has been started.

| Setting Name | Description |
|---|--|
| Auto-On Driver Heated/Ventilated Seat & Heated Steering Wheel With Vehicle Start — If Equipped | This setting will activate the vehicle's comfort systems and heated seats or heated steering wheel when the vehicle is remote started or ignition is started. The "Off" setting will not activate the comfort systems. The "Remote Start" setting will only activate the comfort systems when using Remote Start. The "All Start" setting will activate the comfort systems whenever the vehicle is started. |
| Easy Exit Seats | This setting will automatically move the driver seat rearward when the engine is shut off. The available settings are "On" and "Off". |

5

Key Off Options/Engine Off Options

When the Key Off Options/Engine Off Options button is pressed on the touchscreen, the system displays the options related to vehicle shutoff. These settings will only activate when the ignition is set to OFF.

| Setting Name | Description |
|---|---|
| Easy Exit Seat | This setting adjusts the seats to make exiting the vehicle easier. |
| Key Off Power Delay/Engine Off Power Delay | This setting will keep certain electrical features running after the engine is turned off. When any door is opened, the electronics will deactivate. The available settings are "0 sec", "45 sec", "5 min", and "10 min". |
| Headlight Off Delay | This setting will allow you to set the amount of time the headlights remain on after the vehicle has been turned off. The "+" will increase the amount of time. The "-" will decrease the amount of time. |

252 MULTIMEDIA**Suspension/Air Suspension – If Equipped**

When the Suspension/Air Suspension button is pressed on the touchscreen, the system will display settings related to the vehicle's air suspension.

| Setting Name | Description |
|---|--|
| Sound Horn With Lower | This setting will sound the horn when the Lower button is pressed on the key fob. |
| Flash Lights With Lower | This setting will flash the lights when the Lower button is pressed on the key fob. |
| Display Suspension Messages | This setting will display suspension messages in the Instrument Cluster Display. The "All" setting will display all available messages. The "Warnings Only" setting will only display warning messages. |
| Aero Mode | This setting will automatically adjust the vehicle ride height depending on the vehicle speed. |
| Tire Jack Mode | This setting will disable the air suspension system to assist in changing a spare tire. |
| Transport Mode | This setting will lower the vehicle to Entry/Exit height and then disable the air suspension system for flat towing. |
| Wheel Alignment Mode | This setting must be activated before performing a wheel alignment, which will move the vehicle to normal ride height and then disable the air suspension system. Refer to an authorized dealer for further information. |
| Four Corner Air Suspension Modes | There are three air suspension modes designed to protect the system in unique situations. Tire Jack Mode is selected to assist in changing a spare tire. Transport Mode is selected to assist when the vehicle is being flat bed towed. Wheel Alignment Mode is selected before performing a wheel alignment. Refer to an authorized dealer for further information. |

AUX Switches – If Equipped

When the AUX Switches button is pressed on the touchscreen, the system displays the options related to the four vehicle AUX switches.

| Setting Name | Description |
|--------------|---|
| AUX 1-4 | This setting will adjust the type and power source for the four vehicle AUX switches. There are two types: “Latching” and “Momentary”. The power source for the AUX switches can either be set to run off the “Battery” or from the “Ignition”. In addition to setting the type and power source, you can set if the vehicle will recall the previous state at which the AUX switches were set. The Recalled Last State setting can be set to “On” or “Off”. Last state conditions are met only if the type is set to Latching and the power source is set to Ignition. |

5

Audio

When the Audio button is pressed on the touchscreen, the system displays options related to the vehicle’s sound system. These settings can change the audio location within the vehicle, adjust the bass or treble levels, and auto-play settings from an audio device or smartphone.

| Setting Name | Description |
|-----------------------|---|
| Balance/Fade | This setting will adjust audio levels from specific speakers in the front/back and left/right of the vehicle. The Speaker icon can be moved to set audio location. |
| Equalizer | This setting will adjust the “Bass”, “Mid”, and “Treble” ranges of the audio. |
| Speed Adjusted Volume | This setting will adjust audio volume as speeds increase. At a higher setting, the volume will increase more as the vehicle speeds up. The available settings are “Off”, “1”, “2”, and “3”. |

254 MULTIMEDIA

| Setting Name | Description |
|--------------------------|---|
| Surround Sound | This setting will turn the Surround Sound system on or off. |
| AUX Volume Offset | This setting will tune the audio levels from a device connected through the AUX port. The available settings are “+” and “-”. |
| Auto Play | This setting will automatically begin playing audio from a connected device. |
| Loudness | This setting will improve audio quality at lower volumes. |

Notifications

When the Notifications button is pressed on the touchscreen, the system displays the options related to Notifications for the system.

| Setting Name | Description |
|--|---|
| Notification Sounds | This setting will turn off the Notification chime that plays when a new notification is sent. The options are “On” and “Off”. |
| App Drawer Favoriting Pop-Ups | This setting turns the App Favorited pop-up on or off. |
| App Drawer Unfavoriting Pop-Ups | This setting turns the App Unfavorited pop-up on or off. |
| New Text Message Pop-Ups | This setting turns receiving/storing a pop-up for new text messages of any connected phone on or off. |
| Missed Calls Message | This setting turns receiving/storing a pop-up for missed calls of any connected phone on or off. |
| Navigation Pop-Ups | This setting turns receiving/storing predictive Navigation Pop-Ups on or off. |

SiriusXM® Setup

NOTE:

A subscription to SiriusXM® satellite radio is required for these settings to be functional.

When the SiriusXM® Setup button is pressed on the touchscreen, the system displays options related to SiriusXM® satellite radio. These settings can be used to skip specific radio channels and restart favorite songs from the beginning.

| Setting Name | Description |
|---------------------------------|--|
| Tune Start | This setting will play the current song from the beginning when you tune to a music channel using one of the 12 presets. |
| Channel Skip | This setting allows you to set channels that you wish to skip. A channel list will display of the skipped channels. |
| Subscription Information | This menu provides SiriusXM® subscription information. SiriusXM® Travel Link is a separate subscription. |

5

Software Updates – If Equipped

When the Software Updates button is pressed on the touchscreen, the system will display the setting related to updating the Uconnect software.

| Setting Name | Description |
|--------------------------------------|---|
| Software Downloads over Wi-Fi | This setting will allow software updates to happen over Wi-Fi. Selectable options for the setting are “On” and “Off”. |

256 MULTIMEDIA**Reset/Restore Settings To Default**

When the Reset/Restore Settings To Default button is pressed on the touchscreen, the system displays the options related to resetting the Uconnect system back to its default settings. These settings can clear personal data and reset selected settings from other menus.

| Setting Name | Description |
|--|---|
| Restart Radio | This setting will reboot the radio. |
| Reset Apps Drawer To Default Order | This setting will return the apps drawer to the default order. The available options are "Yes" and "Cancel". The X button can also be pressed to cancel the screen. |
| Restore Settings to Default | This setting will return all the previously changed settings to their factory default. |
| Clear Personal Data | This setting will display a pop-up that gives you the option to clear all personal data from the system, including Bluetooth® devices and presets. |
| Reset Wi-Fi Password For Projection | This setting will allow you to reset the vehicle's Wi-Fi password for smartphone projection. The available options are "Yes" and "Cancel". The X button can also be pressed to cancel the screen. |
| Factory Reset | This setting will restore the radio to its factory default settings. |

UCONNECT INTRODUCTION

SYSTEM OVERVIEW



Uconnect 3 With 5-inch Display





- 1 – Radio Button
- 2 – Media Button
- 3 – Phone Button
- 4 – Volume & On/Off Button
- 5 – Mute Button

- 6 – Compass Button
- 7 – Settings Button
- 8 – More Button
- 9 – Enter/Browse & Tune/Scroll Knob
- 10 – Screen Off Button

5

258 MULTIMEDIA**NOTE:**

Uconnect screen images are for illustration purposes only and may not reflect exact software for your vehicle.

| Feature | Description |
|--|--|
| Radio/Media | Press the Radio button or Media button to enter Radio Mode/Media Mode and access the radio functions and external audio sources ⇨ page 260. |
| Phone | Press the Phone button to enter Phone Mode and access the hands-free phone system ⇨ page 271. |
| Settings | Press the Settings button to access the Uconnect Settings ⇨ page 237. |
|  | Push the Enter/Browse button on the faceplate to accept a highlighted selection on the screen. Rotate the Tune/Scroll rotary knob to scroll through a list or tune a radio station. |
|  | Push the Screen Off button on the faceplate to turn the screen on or off. |
|  | Push the Mute button on the faceplate to turn the audio of the radio system off. Push it again to turn the audio back on. |
|  | Rotate the rotary knob to adjust the volume. Push the Volume & On/Off button on the faceplate to turn the system on or off. NOTE: Push and hold the Volume & On/Off button for approximately 10 seconds to reset the radio manually. Doing this can also recover the radio screen from freezing or being stuck. |

| Feature | Description |
|----------------|---|
| Compass | Press the Compass button to access the vehicle's compass. |
| More | Press the More button to access additional options. |

SAFETY AND GENERAL INFORMATION

Safety Guidelines

WARNING!

ALWAYS drive safely with your hands on the steering wheel. You have full responsibility and assume all risks related to the use of the Uconnect features and applications in this vehicle. Only use Uconnect when it is safe to do so. Failure to do so may result in an accident involving serious injury or death.

Please read this manual carefully before using the system. It contains instructions on how to use the system in a safe and effective manner.

Do NOT attach any object to the touchscreen. Doing so can result in damage to the touchscreen.

Please read and follow these safety precautions. Failure to do so may result in injury or property damage.

- Glance at the screen only when safe to do so. If prolonged viewing of the screen is required, park in a safe location and set the parking brake.

- Stop use immediately if a problem occurs. Failure to do so may cause injury or damage to the product. See an authorized dealer for repair.
- Ensure the volume level of the system is set to a level that still allows you to hear outside traffic and emergency vehicles.

Cybersecurity

Your vehicle may be a connected vehicle and may be equipped with both wired and wireless networks. These networks allow your vehicle to send and receive information. This information allows systems and features in your vehicle to function properly.

Your vehicle may be equipped with certain security features to reduce the risk of unauthorized and unlawful access to vehicle systems and wireless communications. Vehicle software technology continues to evolve over time and FCA US LLC, working with its suppliers, evaluates and takes appropriate steps as needed. Similar to a computer or other devices, your vehicle may require software updates to improve the usability and performance of your systems or to reduce the potential risk of unauthorized and unlawful access to your vehicle systems.

The risk of unauthorized and unlawful access to your vehicle systems may still exist, even if the most recent version of vehicle software (such as Uconnect software) is installed.

WARNING!

- It is not possible to know or to predict all of the possible outcomes if your vehicle's systems are breached. It may be possible that vehicle systems, including safety related systems, could be impaired or a loss of vehicle control could occur that may result in an accident involving serious injury or death.
- ONLY insert trusted devices/components into your vehicle. Media of unknown origin could possibly contain malicious software, and if installed in your vehicle, it may increase the possibility for vehicle systems to be breached.
- As always, if you experience unusual vehicle behavior, take your vehicle to your nearest authorized dealer immediately.

260 MULTIMEDIA

NOTE:

- FCA US LLC or your dealer may contact you directly regarding software updates.
- To help further improve vehicle security and minimize the potential risk of a security breach, vehicle owners should:
 - Routinely check www.driveuconnect.com (US Residents) or www.driveuconnect.ca (Canadian Residents) to learn about available Uconnect software updates.
 - Only connect and use trusted media devices (e.g. personal mobile phones, USBs, CDs).

Privacy of any wireless and wired communications cannot be assured. Third parties may unlawfully intercept information and private communications without your consent ⇨ page 140.

Safe Usage Of The Uconnect System

- The Uconnect system is a sophisticated electronic device. Do not let young children use the system.
- Permanent hearing loss may occur if you play your music or sound system at loud volumes. Exercise caution when setting the volume on the system.

- Keep drinks, rain and other sources of moisture away from the system. Besides damage to the system, moisture can cause electric shocks as with any electronic device.

NOTE:

Many features of this system are speed dependent. For your own safety, it is not possible to use some of the touchscreen features while the vehicle is in motion.

Care And Maintenance

- Do not press the touchscreen with any hard or sharp objects (pen, USB stick, jewelry, etc.), which could scratch the surface.
- Do not spray any liquid or chemicals directly on the screen! Use a clean and dry microfiber lens cleaning cloth in order to clean the touchscreen.
- If necessary, use a lint-free cloth dampened with a cleaning solution, such as isopropyl alcohol or an isopropyl alcohol and water solution ratio of 50:50. Be sure to follow the solvent manufacturer's precautions and directions ⇨ page 458.

UCONNECT MODES

STEERING WHEEL AUDIO CONTROLS

The remote sound system controls are located on the rear surface of the steering wheel at the three and nine o'clock positions.

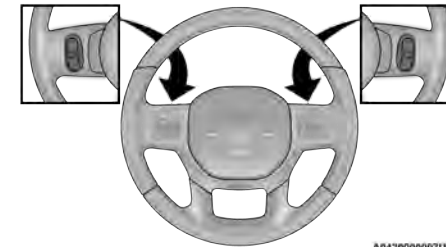

A042000007US

Remote Sound System Controls

The right-hand control is a rocker-type switch with a push button in the center and controls the volume and mode of the sound system. Pushing the top of the rocker switch will increase the volume, and pushing the bottom of the rocker switch will decrease the volume.

Pushing the center button will make the radio switch between the various modes available (AM/FM/SXM or Media, etc.).

The left-hand control is a rocker-type switch with a push button in the center. The function of the left-hand control is different depending on which mode you are in.

The following describes the left-hand control operation in each mode:

Radio Operation

Pushing the top of the switch will Seek Up for the next available station and pushing the bottom of the switch will Seek Down for the next available station.

The button located in the center of the left-hand control will tune to the next preset station that you have programmed in the radio presets.

Media Mode

Pushing the top of the switch skips to the next track on the selected media (AUX/USB/Bluetooth®). Pushing the switch up twice will go forward two tracks. Pushing the bottom switch goes to the beginning of the current track, or the beginning of the previous track if it is within eight seconds after the current track begins to play.

Double pressing the bottom button switch will skip to the previous track if it is after eight seconds into the current track.

RADIO MODE

Radio Controls

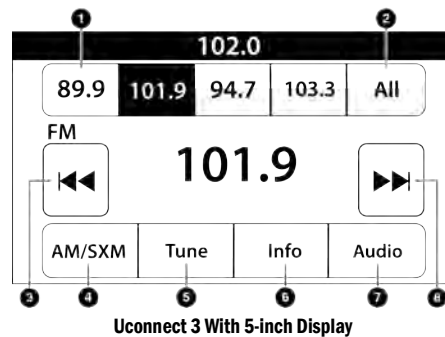

- 1 – Preset Radio Stations
- 2 – All Preset Radio Stations
- 3 – Seek Down ◀◀
- 4 – Radio Band (AM/FM)
- 5 – Tune
- 6 – Station Info
- 7 – Audio Settings
- 8 – Seek Up ▶▶

The radio is equipped with the following modes:

- AM
- FM
- SiriusXM® Satellite Radio (if equipped)

Press the Radio button on the touchscreen to enter the Radio Mode. The different tuner modes, AM, FM, and SXM, can then be selected by pressing the corresponding buttons in Radio Mode.

Volume & On/Off Control

Push the Volume & On/Off control knob to turn on and off the Uconnect system.

The electronic volume control turns continuously (360 degrees) in either direction, without stopping. Turning the Volume & On/Off control knob clockwise increases the volume, and counterclockwise decreases it.

When the audio system is turned on, the sound will be set at the same volume level as last played.

Mute Button

Push the Mute button to mute or unmute the system.

262 MULTIMEDIA

Tune/Scroll Control

Turn the rotary Tune/Scroll control knob clockwise to increase or counterclockwise to decrease the radio station frequency. Push the Enter/Browse button to choose a selection.

Seek

The Seek Up and Down functions are activated by pressing the double arrow buttons on the touchscreen to the right and left of the radio station display or by pushing the left steering wheel audio control button up or down.

Seek Up ►► and Seek Down ◀◀

Press and release the Seek Up ►► or Seek Down ◀◀ button to tune the radio to the next available station or channel. During a Seek Up/Down function, if the radio reaches the starting station after passing through the entire band two times, the radio will stop at the station where it began.

Fast Seek Up ►► and Fast Seek Down ◀◀

Press and hold, and then release the Seek Up ►► or Seek Down ◀◀ button to advance the radio through the available stations or channels at a faster rate. The radio stops at the next available station or channel when the button on the touchscreen is released.

NOTE:

Pressing and holding either the Seek Up ►► or Seek Down ◀◀ button will scan the different frequency bands at a slower rate.

Info — If Equipped

Press the Info button to display information related to the currently playing song and radio station.

Direct Tune

Press the Tune button located at the bottom of the radio screen to directly tune to a desired radio station or channel.

Press the available number button on the touchscreen to begin selecting a desired station. Once a number has been entered, any numbers that are no longer possible (stations that cannot be reached) will become deactivated/grayed out.

Undo

You can backspace an entry by pressing the Back  button on the touchscreen.

GO

Once the last digit of a station has been entered, press “Ok”. The Direct Tune screen will close, and the system will automatically tune to that station.

RADIO VOICE COMMANDS

Use your voice to quickly get to the AM, FM, or SiriusXM® Satellite Radio stations you would like to hear. (Subscription or included SiriusXM® Satellite Radio trial required.)

Push the VR button  on the steering wheel and wait for the beep to say a command. See an example below:

- “Tune to ninety-five-point-five FM”
- “Tune to Satellite Channel Hits 1”

Did You Know: At any time, if you are not sure of what to say or want to learn a Voice Command, push the VR button  and say “Help”. The system provides you with a list of commands.

SiriusXM® Satellite Radio Mode – If Equipped

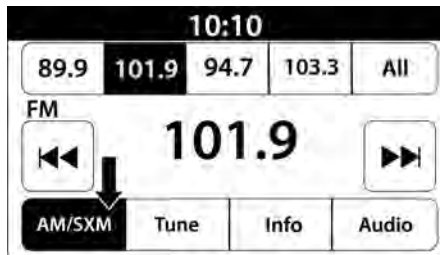

Uconnect 3 With 5-inch Display Changing To SiriusXM®

SiriusXM® Satellite Radio uses direct satellite-to-receiver broadcasting technology to provide clear, coast-to-coast radio content. SiriusXM® is a subscription-based service.

Visit siriusxm.com/getallaccess or review your SiriusXM® Radio pamphlet in your Owner's Manual kit for more information.

SiriusXM® services require subscriptions, sold separately after the trial included with the new vehicle purchase. If you decide to continue your service at the end of your trial subscription, the plan you choose will automatically renew and bill at then-current rates until you call SiriusXM® at 866-635-2349 to cancel. See SiriusXM® Customer Agreement for complete terms at www.siriusxm.com (US) or www.siriusxm.ca (Canada).

All fees and programming subject to change. SiriusXM® satellite service is available only to those at least 18 and older in the 48 contiguous US and D.C. Our SiriusXM® satellite service is also available in Canada and Puerto Rico (with coverage limitations). SiriusXM® Internet radio service is available throughout their satellite service area and in AK. © 2021 SiriusXM® Radio Inc. SiriusXM® and all related marks and logos are trademarks of SiriusXM® Radio Inc.

This functionality is only available for radios equipped with a Satellite receiver. In order to receive satellite radio, the vehicle needs to be outside with a clear view to the sky.

If the screen shows "Acquiring Signal", you might have to change the vehicle's position in order to receive a signal. In most cases, the satellite radio does not receive a signal in underground parking garages or tunnels.

No Subscription

Radios equipped with a Satellite receiver require a subscription to the SiriusXM® Service. When the radio does not have the necessary subscription, the radio is able to receive the Preview channel only.

Acquiring SiriusXM® Subscription

To activate the SiriusXM® Satellite Radio subscription, US residents visit <http://www.siriusxm.com/getallaccess> or call: 1-800-643-2112

Canadian residents visit <https://www.siriusxm.ca/> or call: 1-888-539-7474.

NOTE:

You will need to provide the SiriusXM® ID (RID) located at the bottom of the Channel 0 screen.

The Satellite Mode is activated by a press of the SXM button on the touchscreen.

264 MULTIMEDIA

When in Satellite Mode:

- The SXM button on the touchscreen is highlighted.
- The SiriusXM® Presets are displayed at the top of the screen.
- The SiriusXM® Channel Number is displayed in the center.
- The Program Information is displayed at the bottom of the Channel Number.
- The SiriusXM® function buttons are displayed below the Program Information.

Tuning is done by operating the Tune Knob or by Direct Tune, similar to other Radio Bands.

In addition to the tuning operation functions common to all radio modes, the replay, Traffic/Weather button, and Favorite button functions are available in SiriusXM® Mode.

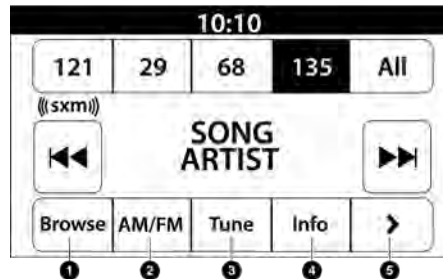

Uconnect 3 With 5-inch Display SiriusXM® Satellite Radio





- 1 – Browse
- 2 – Radio Bands
- 3 – Direct Tune
- 4 – Info Button
- 5 – Next Button

REPLAY

The replay function provides a means to store and replay up to 22 minutes of music audio and 48 minutes of talk radio. Once the channel is switched, content in replay memory is lost.

Press the Replay button on the touchscreen. The Play/Pause, Rewind/Forward and Live buttons will display at the top of the screen, along with the replay time.

You can exit by pressing the Replay button on the touchscreen any time during the Replay Mode.

| | | |
|-------------------|--|---|
| <p>Play/Pause</p> |  | <p>Press the Pause/Play button on the touchscreen to pause the playing of live or rearound content at any time. Play can be resumed by pressing the Pause/Play button again on the touchscreen.</p> |
| <p>Rewind</p> |  | <p>Press the Rewind button on the touchscreen to rewind the content in steps of five seconds. Pressing the Rewind button on the touchscreen for more than two seconds rewinds the content. The radio begins playing the content at the point at which the press is released.</p> |
| <p>Forward</p> |  | <p>Each press of the Forward button on the touchscreen forwards the content in steps of five seconds. Forwarding of the content can only be done when the content is previously rearound, and therefore, cannot be done for live content. A continuous press of the Forward button on the touchscreen also forwards the content. The radio begins playing the content at the point at which the press is release.</p> |
| <p>Live</p> |  | <p>Press the Live button on the touchscreen to resume the playing of live content.</p> |

266 MULTIMEDIA

FAVORITES

Press the Favorites button on the touchscreen to activate the favorites menu, which will time out within 20 seconds in absence of user interaction.

You can exit the Favorites Menu by a press of the X button.

The Favorites feature enables you to set a favorite artist or song that is currently playing. The radio then uses this information to alert you when either the favorite artist or song is being played at any time by any of the SiriusXM® Channels.

The maximum number of favorites that can be stored in the Radio is 50.

Favorite Artist: While the song is playing, to set a favorite artist, press the Favorites button on the touchscreen and then the Favorite Artist button on the touchscreen.

Favorite Song: While the song is playing, to set a favorite song, press the Favorites button on the touchscreen and then the Favorite Song button on the touchscreen.

BROWSE IN SXM

Press the Browse button on the touchscreen to edit Presets, Favorites, Game Zone, and Jump settings, along with providing the SiriusXM® Channel List.

This Screen contains many submenus. You can exit submenus to return to a parent menu by pressing the Back arrow.

All

Press the All button on the Browse Screen. When pressing the All button, the following categories become available:

- **Channel List:** Press the Channel List to display all the SiriusXM® Channel Numbers. You can scroll the Channel List by pressing the Up and Down arrows, located on the right side of the screen. Scrolling can also be done by operating the Tune/Scroll knob.
- **Genre List:** Press the Genre button on the touchscreen to display a list of Genres. You can select any desired Genre by pressing the Genre List. The radio tunes to a channel with the content in the selected Genre.

Favorites

Press the Favorites button on the Browse screen.

The Favorites menu provides a means to edit the Favorites list and to configure the Alert Settings, along with providing a list of Channels currently airing any of the items in the Favorites list.

You can scroll the Favorites list by pressing the Up and Down arrows located at the right side of the screen. Scrolling can also be done by operating the Tune/Scroll knob as well.

Remove Favorites

Press the Remove Favorites tab at the top of the screen. Press the Delete All button on the touchscreen to delete all of the Favorites or press the Trash Can icon next to the Favorite to be deleted.

Alert Settings

Press the Alert Settings tab at the top of the Favorites screen. The Alert Settings menu allows you to choose from a visual alert or audible and visual alert when one of your favorites is airing on any of the SiriusXM® channels.

Game Zone

Press the Game Zone button, located at the left of the Browse screen. This feature provides you with the ability to select teams, edit the selection, and set alerts.

On-Air

Press the On-Air tab at the top of the screen. The On-Air list provides a list of Channels currently airing any of the items in the Selections list, and pressing any of the items in the list tunes the radio to that channel.

Add/Delete — If Equipped

Press the Add/Delete button on the touchscreen to activate the League Scroll list. Press the chosen league and a scroll list of all teams within the league will appear, then you can select a team by pressing the corresponding box. A check mark appears for all teams that are chosen.

Remove Selection/Trash Can Icon

Press the Remove Selection tab at the top of the screen. Press the Delete All button on the touchscreen to delete all of the selections or press the Trash Can icon next to the selection to be deleted.

Alert Settings

Press the Alert Setting tab at the top of the screen. The Alert Settings menu allows you to choose from “Alert me to on-air games upon start” or “Alert upon score update” or both when one or more of your selections is airing on any of the SiriusXM® channels.

Tune Start

Tune Start begins playing the current song from the beginning when you tune to a music channel using one of the 12 presets. This feature occurs the first time the preset is selected during that current song.

Setting Presets



Uconnect 3 With 5-inch Display Radio Presets

The Presets are available for all Radio Modes, and are activated by pressing any of the Preset buttons, located at the top of the screen.

When you are on a station that you wish to save as a preset, press and hold the numbered button on the touchscreen for more than two seconds.

The Radio stores up to 12 presets in each of the Radio Modes.

For the Uconnect 3 With 5-inch Display

A set of four presets will appear on the screen. Press the All button to view all saved presets. To remove a saved preset, a new preset must be saved over the old one.

Audio Settings

Press the Audio button within the settings main menu to activate the Audio Settings screen.



Uconnect 3 With 5-inch Display

5

268 MULTIMEDIA

| Audio Setting | Description |
|--|---|
| Balance/Fade | Press the Balance/Fade button on the touchscreen to balance audio between the front speakers or fade the audio between the rear and front speakers. Press the Front, Rear, Left or Right buttons or press and drag the red Speaker icon to adjust the Balance/Fade. |
| Equalizer | Press the + or - buttons or press and drag the level bar to increase or decrease each of the equalizer bands. The level value, which spans between plus or minus nine, is displayed at the top of each of the bands. |
| Speed Adjusted Volume | The Speed Adjusted Volume is adjusted by selecting from "Off", "1", "2", and "3". This alters the automatic adjustment of the audio volume with variation to vehicle speed. Volume increases automatically as speed increases to compensate for normal road noise. |
| Surround Sound – If Equipped | When Surround Sound is on, you can hear audio coming from every direction as in a movie theatre or home theatre system. |
| Loudness – If Equipped | When Loudness is on, the sound quality at lower volumes improves. |
| AUX Volume Offset | The AUX Volume Offset is adjusted by pressing + and - buttons. This alters the AUX input audio volume. The level value, which spans between plus or minus three, is displayed above the adjustment bar. |
| Auto Play – If Equipped | The Auto Play feature begins playing music as soon as a USB Media device is connected to one of the vehicle's Media USB ports, when it is turned on. Press "Off" to turn the setting off. |
| Radio Off With Door – If Equipped | The Radio Off With Door feature, when activated, keeps the radio on until the driver or passenger door is opened or when the Radio Off Delay selected time has expired. |

MEDIA MODE

Operating Media Mode

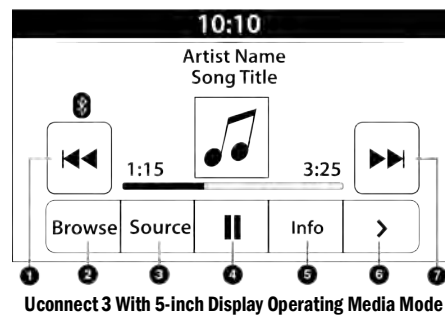

- 1 – Seek Down ◀◀
- 2 – Browse
- 3 – Source
- 4 – Pause/Play
- 5 – Info
- 6 – More Options
- 7 – Seek Up ▶▶

Media Mode is entered by pushing the MEDIA button located on the faceplate.

Audio Source Selection

Once in Media Mode, press the Source or Source Select button on the touchscreen and the desired mode button on the touchscreen. USB, AUX, and Bluetooth® are the Media sources available. When available, you can select the Browse button on the touchscreen to be given these options:

- Now Playing
- Artists
- Albums
- Genres
- Songs
- Playlists
- Folders

For the Uconnect 3 With 5-inch Display, Media Mode is entered by pushing the Media button located on the faceplate.

Types of Media Modes

USB MODE

Overview

USB Mode is entered by either inserting a USB device into the USB port or by pushing the MEDIA button on the faceplate and then selecting the USB button.

On the Uconnect 3 With 5-inch Display, if you insert a USB device with the ignition in ON/RUN, the unit will switch to USB Mode and begin to play. The display will show the track number and index time in minutes and seconds. Play will begin at the start of track 1.

BLUETOOTH® MODE

Overview

Bluetooth® Streaming Audio or Bluetooth® Mode is entered by pairing a Bluetooth® device, containing music, to the Uconnect system.

Before proceeding, the Bluetooth® device must be paired to the Uconnect Phone to communicate with the Uconnect system.

5

On the Uconnect 3 With 5-inch Display, push the MEDIA button located on the faceplate. Once in Media Mode, press the Source button on the touchscreen and select the Bluetooth® button ⇨ page 271.

To access Bluetooth® Mode, press the Bluetooth® button on the left side of the touchscreen or under the Source Select/Select Source button (if equipped).

270 MULTIMEDIA

AUX MODE

Overview

Auxiliary Mode (AUX) is entered by inserting an AUX device using a cable with a 3.5 mm audio jack into the AUX port or by pushing the MEDIA button on the faceplate, selecting the Source button and then the AUX button.

To insert an Auxiliary device, gently insert the Auxiliary device cable into the AUX port. If you insert an Auxiliary device with the ignition and the radio on, the unit will switch to AUX Mode and begin to play.

Controlling The Auxiliary Device

The control of the Auxiliary device (e.g., selecting playlists, play, fast forward, etc.) cannot be provided by the radio; use the device controls instead. Adjust the volume with the Volume button, Volume/Mute rotary knob, or the On/Off rotary knob, or with the volume of the attached device.

NOTE:

The radio unit is acting as the amplifier for audio output from the Auxiliary device. Therefore, if the volume control on the Auxiliary device is set too low, there will be insufficient audio signal for the radio unit to play the music on the device.

Seek Up ►► / Seek Down ◀◀

In USB Mode, press the Seek Up button on the touchscreen for the next selection on the USB device. Press and release the Seek Down button on the touchscreen to return to the beginning of the current selection, or to return to the beginning of the previous selection if the USB device is within the first three seconds of the current selection.

In Bluetooth® Mode, press and release the Seek Up button on the touchscreen for the next selection on the Bluetooth® device. Press and release the Seek Down button on the touchscreen to return to the beginning of the current selection, or return to the beginning of the previous selection if the Bluetooth® device is within the first second of the current selection.

Browse

In USB Mode, press the Browse button on the touchscreen to display the browse window. In USB Mode, the left side of the browse window displays a list of ways you can browse through the contents of the USB device. If supported by the device, you can browse by Folder, Artist, Playlist, Album, Song, etc. Press the desired button on the touchscreen on the left side of the screen. The center of the browse window shows items and their sub-functions, which can be scrolled through by pressing the Up and Down buttons to the right. The Tune/Scroll knob can also be used to scroll.

On the Uconnect 3 With 5-inch Display, rotate the Browse button on the touchscreen to scroll through and select a desired track on the device. Press the Exit button on the touchscreen if you wish to cancel the Browse function.

Media Mode

In USB Mode, press the Media button on the touchscreen to select the desired audio source: USB.

In Bluetooth® Mode, press the Media button on the touchscreen to select the desired audio source: Bluetooth®.

In AUX Mode, press the Media button on the touchscreen to select the desired audio source: AUX.

Repeat

In USB Mode, press the Repeat button on the touchscreen to toggle the repeat functionality. The Repeat button on the touchscreen is highlighted when active. The Radio will continue to play the current track, repeatedly, as long as the repeat is active. Press the Repeat button again to enter Repeat All. The radio will continue to play all the current tracks, repeatedly, as long as the repeat function is active. To cancel Repeat, press the Repeat button a third time.

Shuffle

In USB Mode, press the Shuffle button on the touchscreen to play the selections on the USB device in random order to provide an interesting change of pace. Press the Shuffle button on the touchscreen a second time to turn this feature off.

Audio

Audio settings can be accessed by pressing the Audio button → page 261.

Info

In USB Mode, press the Info button on the touchscreen to display the current track information. Press the Info or X button on the touchscreen a second time to cancel this feature.

Tracks

In USB Mode, press the Tracks button on the touchscreen to display a pop-up with the Song List. The song currently playing is indicated by an arrow and lines above and below the song title. When in the Tracks List screen you can rotate the Tune/Scroll knob to highlight a track (indicated by the line above and below the track name) and then push the Enter/Browse knob to start playing that track.

In Bluetooth® Mode, if the Bluetooth® device supports this feature, press the Tracks button on the touchscreen to display a pop-up with the Song List. The currently playing song is indicated by a red arrow and lines above and below the song title.

Pressing the Tracks button on the touchscreen while the pop-up is displayed will close the pop-up.

MEDIA VOICE COMMANDS

Uconnect offers connections via USB, Bluetooth®, and auxiliary (AUX) ports. Voice operation is only available for connected USB and AUX devices.

Push the VR button  located on the steering wheel. After the beep, say one of the following commands and follow the prompts to switch your media source or choose an artist.

- “**Change source to** Bluetooth®”
- “**Change source to** AUX”
- “**Change source to** USB”
- “**Play artist** Beethoven”; “**Play album** Greatest Hits”; “**Playsong** Moonlight Sonata”; “**Play genre** Classical”

Did You Know: Press the Browse button on the touchscreen to see all of the music on your USB device. Your Voice Command must match exactly how the artist, album, song, and genre information is displayed.

PHONE MODE**Overview**

Uconnect Phone is a voice-activated, hands-free, in-vehicle communications system. It allows you to dial a phone number with your mobile phone.

The feature supports the following:

Voice Activated Features

- Hands-Free dialing via Voice (“Call John Smith Mobile” or “Dial 248-555-1212”).
- Hands-Free text-to-speech listening of your incoming SMS messages.
- Hands-Free Text Message Replying: Forward one of 18 predefined SMS messages to incoming calls/text messages.
- Redialing last dialed numbers (“Redial”).
- Calling Back the last incoming call number (“Call Back”).
- Viewing call logs on screen (“Show Incoming Calls,” “Show Outgoing Calls,” “Show Missed Calls,” or “Show Recent Calls”).
- Searching Contacts phone number (“Search for John Smith Mobile”).

272 MULTIMEDIA

Screen Activated Features

- Dialing via Keypad using touchscreen.
- Viewing and Calling contacts from Phonebooks displayed on the touchscreen.
- Setting Favorite Contact phone numbers so they are easily accessible on the Main Phone screen.
- Viewing and Calling contacts from Recent Call logs.
- Reviewing your recent Incoming SMS Messages.
- Pairing up to 10 phones/audio devices for easy access to connect to them quickly.

NOTE:

Your phone must be capable of SMS messaging via Bluetooth® for messaging features to work properly.

Your mobile phone's audio is transmitted through your vehicle's audio system; the system will automatically mute your radio when using the Uconnect Phone.

For Uconnect customer support:

- US visit UconnectPhone.com or call 877-855-8400
- Canada visit UconnectPhone.com or call 800-465-2001 (English) or (French) call 800-387-9983

Uconnect Phone allows you to transfer calls between the system and your mobile phone as you enter or exit your vehicle and enables you to mute the system's microphone for private conversation.

WARNING!

ALWAYS drive safely with your hands on the steering wheel. You have full responsibility and assume all risks related to the use of the Uconnect features and applications in this vehicle. Only use Uconnect when it is safe to do so. Failure to do so may result in an accident involving serious injury or death.

The Phone feature is driven through your Bluetooth® "Hands-Free Profile" mobile phone. Uconnect features Bluetooth® technology – the global standard that enables different electronic devices to connect to each other without wires or a docking station. Ensure your phone is turned on with Bluetooth® active and has been paired to the Uconnect system. Up to 10 mobile phones or audio devices are allowed to be linked to the system. Only one linked (or paired) mobile phone and one audio device can be used with the system at a time.

Phone Button



The Phone button on your steering wheel is used to get into the Phone Mode and make calls, show recent, incoming or outgoing calls, view phonebook, etc. When you push the button you will hear a BEEP. The BEEP is your signal to give a command.

Voice Command Button



The Voice Command button on your steering wheel is only used for “barge in” and when you are already in a call or want to make another call.

The button on your steering wheel is also used to access the Voice Commands for the Uconnect Voice Command features if your vehicle is equipped.

Phone Operation

OPERATION

Voice commands can be used to operate the Uconnect Phone and to navigate its menu structure. Voice commands are required after most Uconnect Phone prompts. There are two general methods for how Voice Command works:

1. Say compound commands like “Call John Smith mobile”.
2. Say the individual commands and allow the system to guide you to complete the task.

You will be prompted for a specific command and then guided through the available options.

- Prior to giving a voice command, one must wait for the beep, which follows the “Listen” prompt or another prompt.
- For certain operations, compound commands can be used. For example, instead of saying “Call” and then “John Smith” and then “mobile”, the following compound command can be said: “Call John Smith mobile.”
- For each feature explanation in this section, only the compound command form of the voice command is given. You can also break the commands into parts and say each part of the command when you are asked for it. For example, you can use the compound command form voice command “Search for John Smith,” or you can break the compound command form into two voice commands: “Search Contacts” and when asked, “John Smith.” Please remember, the Uconnect Phone works best when you talk in a normal conversational tone, as if speaking to someone sitting a few feet/ meters away from you.

NATURAL SPEECH

Your Uconnect Phone Voice system uses a Natural Language Voice Recognition (VR) engine.

Natural speech allows the user to speak commands in phrases or complete sentences. The system filters out certain non-word utterances and sounds such as “ah” and “eh.” The system handles fill-in words such as “I would like to”.

The system handles multiple inputs in the same phrase or sentence such as “make a phone call” and “to Kelly Smith”. For multiple inputs in the same phrase or sentence, the system identifies the topic or context and provides the associated follow-up prompt such as “Who do you want to call?” in the case where a phone call was requested but the specific name was not recognized.

The system utilizes continuous dialog. When the system requires more information from the user, it will ask a question to which the user can respond without pushing the Voice Command button on the steering wheel.

274 MULTIMEDIA

HELP COMMAND

If you need assistance at any prompt, or if you want to know your options at any prompt, say "Help" following the beep.

To activate the Uconnect Phone from idle, simply push the Phone button (if active) on your steering wheel and say a command or say "Help". All Phone sessions begin with a push of the VR button or the Phone button.

CANCEL COMMAND

At any prompt, after the beep, you can say "Cancel" and you will be returned to the main menu.

You can also push the VR button or Phone button on your steering wheel when the system is listening for a command and be returned to the main or previous menu.

PAIR (LINK) UCONNECT PHONE TO A MOBILE PHONE

Use this QR code to access your digital experience.

To begin using your Uconnect Phone, you must pair your compatible Bluetooth®-enabled mobile phone. Mobile phone pairing is the process of establishing a wireless connection between a cellular phone and the Uconnect system.



To complete the pairing process, you will need to reference your mobile phone's manual. Please visit UconnectPhone.com for complete mobile phone compatibility information.

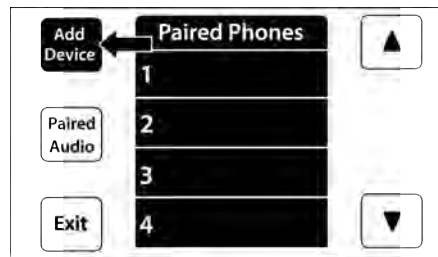

Uconnect 3 With 5-inch Display

NOTE:

- You must have Bluetooth® enabled on your phone to complete this procedure.
- The vehicle must be in PARK or at a standstill.

Follow the steps below to pair your phone:

1. Place the ignition in the ACC or ON/RUN position.
2. Press the Phone button.

NOTE:

- If there are no phones currently connected with the system, a pop-up will appear asking if you would like to pair a mobile phone.
- This pop-up only appears when the user enters Phone Mode and no other device(s) have previously been paired. If the system has a phone previously paired, even if no phone is currently connected with the system, this pop-up will not appear.

3. Select "Yes" to begin the pairing process.
4. Search for available devices on your Bluetooth®-enabled mobile phone.

- Press the Settings button on your mobile phone.
- Select "Bluetooth®" and ensure it is enabled. Once enabled, the mobile phone will begin to search for Bluetooth® connections.

NOTE:

During the pairing procedure, you may receive a pop-up on your touchscreen asking you to make sure the PIN on the touchscreen matches the PIN from the pop-up on your mobile phone.

5. If “No” is selected, and you still would like to pair a mobile phone, press the Pairing or Settings button from the Uconnect Phone main screen.
 - Press the Paired Phones button or the Add Device button.
 - Search for available devices on your Bluetooth®-enabled mobile phone (see below). When prompted on the phone, select “Uconnect” and accept the connection request.
6. Uconnect Phone will display an in-progress screen while the system is connecting.
7. When your mobile phone finds the Uconnect system, select “Uconnect.”
8. When prompted on the mobile phone, accept the connection request from Uconnect.
9. When the pairing process has successfully completed, the system will prompt you to choose whether or not this is your favorite phone. Selecting “Yes” will make this phone the highest priority. This phone will take precedence over other paired phones within range and will connect to the Uconnect system automatically when entering the vehicle. Only one mobile phone and/or one Bluetooth® audio device can be connected to the

Uconnect system at a time. If “No” is selected, simply select “Uconnect” from the mobile phone/audio device Bluetooth® screen, and the Uconnect system will reconnect to the Bluetooth® device.

NOTE:

For phones which are not made a favorite, the phone priority is determined by the order in which it was paired. The most recent phone paired will have the higher priority.

NOTE:

During the pairing procedure, you may receive a pop-up on your mobile phone for the Uconnect system to access your “messages” and “contacts”. Selecting “Ok” or “Allow” will sync your contacts with the Uconnect system.

You can also use the following VR command to bring up the Paired Phone screen from any screen on the radio:

- “Show Paired Phones”

NOTE:

Software updates on your phone or the Uconnect system may interfere with the Bluetooth® connection. If this happens, simply repeat the pairing process. However, first make sure to delete the device from the list of phones on your Uconnect system. Next, be sure to remove Uconnect from the list of devices in your phone’s Bluetooth® settings.

CONNECTING TO A PARTICULAR MOBILE PHONE OR AUDIO DEVICE AFTER PAIRING

Uconnect Phone will automatically connect to the highest priority paired phone and/or Audio Device within range. If you need to choose a particular phone or audio device follow these steps:

1. Press the Settings button on the touchscreen.
2. Press the Paired Phones or Audio Sources button.
3. Press to select the particular phone or the particular audio device. A pop-up menu will appear; press “Connect Phone”.
4. Press the X to exit out of the Settings screen.

5

DISCONNECTING OR DELETING A PHONE OR AUDIO DEVICE

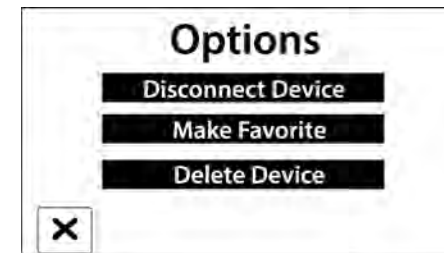

Uconnect 3 With 5-inch Display

276 MULTIMEDIA

1. Press the Uconnect Phone Pairing or Settings button.
2. Press the Paired Phones or Audio Sources button.
3. Press the Settings button located to the right of the device name for a different phone or audio device than the currently connected device or press the preferred Connected Phone from the list.
4. The option's pop-up will be displayed.
5. Press the Disconnect Device or the Delete Device button on the touchscreen.
6. Press the X to exit out of the Settings screen.

MAKING A PHONE OR AUDIO DEVICE A FAVORITE

1. On the Paired Phone/Audio sources screen, press the Settings button located to the right of the device name for a different phone or audio device than the currently connected device or press the preferred "Connected Phone" from the list.
2. The option's pop-up will be displayed.
3. Press the Make Favorite button on the touchscreen; you will see the chosen device move to the top of the list.
4. Press the X to exit out of the Settings screen.

PHONEBOOK DOWNLOAD (AUTOMATIC PHONEBOOK TRANSFER FROM MOBILE PHONE) — IF EQUIPPED

If supported by your phone, Uconnect Phone has the ability to download contact names and number entries from the mobile phone's phonebook. Specific Bluetooth® Phones with Phonebook Access Profile may support this feature. Your mobile phone may receive a pop-up asking for permission for the Uconnect system to access your messages and contacts. Selecting "Ok" or "Allow" will sync your contacts with the Uconnect system.

See the Uconnect website, UconnectPhone.com, for supported phones.

- To call a name from a downloaded mobile phonebook, follow the procedure in "Voice Command" in this section.
- Automatic download and update of a phonebook, if supported, begins as soon as the Bluetooth® wireless phone connection is made to the Uconnect Phone, for example, after you start the vehicle.
- A maximum of 5,000 contact names with four numbers per contact will be downloaded and updated every time a phone is connected to the Uconnect Phone.

- Depending on the maximum number of entries downloaded, there may be a short delay before the latest downloaded names can be used. Until then, if available, the previously downloaded phonebook is available for use.
- Only the phonebook of the currently connected mobile phone is accessible.
- This downloaded phonebook cannot be edited or deleted on the Uconnect Phone. These can only be edited on the mobile phone. The changes are transferred and updated to Uconnect Phone on the next phone connection.

MANAGING YOUR FAVORITES — IF EQUIPPED

There are two ways you can add an entry to your favorites:

1. After loading the mobile phonebook, press the Favorites button on the touchscreen, and then press one of the +Add Favorite Contact buttons that appears on the list.
2. After loading the mobile phonebook, select "Contacts" from the Phone main screen, and then select the appropriate number. Press the Down Arrow button or the Settings Gear button next to the selected number to display the option's pop-up. In the pop-up, select "Add to Favorites".

NOTE:

If the Favorites list is full, you will be asked to remove an existing favorite.

TO REMOVE A FAVORITE — IF EQUIPPED

1. To remove a Favorite, select "Favorites" from the Phone main screen.
2. Next, select the Down Arrow icon or the Settings Gear icon next to the contact you want to remove from your favorites. This will bring up the options for that Favorite contact.
3. Deselect the Star icon to delete the Favorite.

Phone Call Features

The following features can be accessed through the Uconnect Phone if the feature(s) are available and supported by Bluetooth® on your mobile service plan. For example, if your mobile service plan provides three-way calling, this feature can be accessed through the Uconnect Phone. Check with your mobile service provider for the features that you have.

Listed below are the phone options with Uconnect:

- Redial
- Dial by pressing in the number
- Voice Commands (Dial by Saying a Name, Call by Saying a Phonebook Name, Redial or Call Back)

- Favorites
- Mobile Phonebook
- Recent Call Log
- SMS Message Viewer

CALL CONTROLS

The touchscreen allows you to control the following call features:

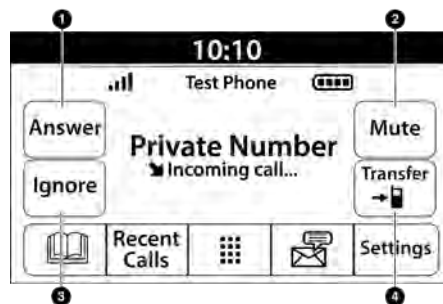

Uconnect 3 With 5-inch Display

- 1 — Answer
- 2 — Mute/Unmute
- 3 — Ignore
- 4 — Transfer

Other phone call features include:

- End Call
- Hold/Unhold/Resume
- Swap two active calls

KEY PAD NUMBER ENTRY

1. Press the Phone button.
2. Press the Dial/Keypad button on the touchscreen.
3. The Touch-Tone screen will be displayed.
4. Use the numbered buttons on the touchscreens to enter the number and press "Dial/Call".

5

RECENT CALLS — IF EQUIPPED

You may browse a list of the most recent of each of the following call types:

- All Calls
- Incoming Calls or Calls Received
- Outgoing Calls or Calls Made
- Missed Calls

These can be accessed by pressing the Recent Calls button on the phone main screen.

You can also push the VR button on your steering wheel and perform the above operation. For example, say "Show my incoming calls".

278 MULTIMEDIA

ANSWER OR IGNORE AN INCOMING CALL — NO CALL CURRENTLY IN PROGRESS

When you receive a call on your mobile phone, the Uconnect Phone will interrupt the vehicle audio system. Push the Phone button on the steering wheel, press the Answer button on the touchscreen, or press the Answer button on the touchscreen.

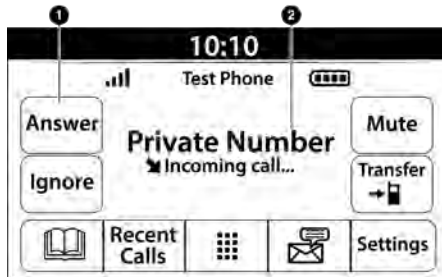

Uconnect 3 With 5-inch Display

- 1 — Answer Button
2 — Caller ID Box

ANSWER OR IGNORE AN INCOMING CALL — CALL CURRENTLY IN PROGRESS

If a call is currently in progress and you have another incoming call, you will hear the same network tones for call waiting that you normally hear when using your mobile phone. Push the Phone button on the steering wheel, press the Answer button on the touchscreen, or press the Caller ID box to place the current call on hold and answer the incoming call.

NOTE:

Phones that are compatible with the Uconnect system in the market today do not support rejecting an incoming call when another call is in progress. Therefore, the user can only answer an incoming call or ignore it.

DO NOT DISTURB

With Do Not Disturb, you can disable notifications from incoming calls and texts, allowing you to keep your eyes on the road and hands on the wheel. For your convenience, there is a counter display to keep track of your missed calls and text messages while Do Not Disturb is active.

Do Not Disturb can automatically reply with a text message, a call, or both when declining an incoming call and send it to voicemail.

Automatic reply messages can be:

- “I am driving right now, I will get back to you shortly”.
- Create a custom auto reply message up to 160 characters.

NOTE:

Only the first 25 characters can be seen on the touchscreen while typing a custom message. While in Do Not Disturb, Conference Call can be selected so you can still place a second call without being interrupted by incoming calls.

NOTE:

- Reply with text message is not compatible with iPhones®.
- Auto reply with text message is only available on phones that support Bluetooth® Message Access Profile (MAP).

PLACE/RETRIEVE A CALL FROM HOLD

During an active call, press the Hold or Call On Hold button on the Phone main screen.

MAKING A SECOND CALL WHILE CURRENT CALL IS IN PROGRESS

You can place a call on hold by pressing the Hold button on the Phone main screen, then dial a number from the keypad (if supported by your mobile phone), recent calls, SMS Inbox or from the phonebooks.

TOGGLING BETWEEN CALLS



Uconnect 3 With 5-inch Display

If two calls are in progress (one active and one on hold), press the Swap Calls button on the phone main screen. Only one call can be placed on hold at a time.

You can also push the Phone button to toggle between the active and held phone call.

JOIN CALLS

When two calls are in progress (one active and one on hold), press the Join/Merge Calls button on the Phone main screen to combine all calls into a conference call.

CALL TERMINATION

To end a call in progress, momentarily press the End Call button on the touchscreen or the Phone End button on the steering wheel. Only the active call(s) will be terminated and if there is a call on hold, it will become the new active call.

REDIAL



Push the VR button and after the "Listening" prompt and the following beep, say "Redial."

The Uconnect Phone will call the last number that was dialed from your mobile phone.

CALL CONTINUATION

Call continuation is the progression of a phone call on the Uconnect Phone after the vehicle ignition has been switched to OFF.

NOTE:

The call will remain within the vehicle audio system until the phone becomes out of range for the Bluetooth® connection. It is recommended to press the Transfer button on the touchscreen when leaving the vehicle.

Advanced Phone Connectivity

TRANSFER CALL TO AND FROM MOBILE PHONE

The Uconnect Phone allows ongoing calls to be transferred from your mobile phone without terminating the call. To transfer an ongoing call from your connected mobile phone to the Uconnect Phone or vice versa, press the Transfer button on the Phone main screen.

Things You Should Know About Uconnect Phone

VOICE COMMAND

For the best performance:

- Always wait for the beep before speaking
- Speak normally, without pausing, just as you would speak to a person sitting a few feet/meters away from you
- Ensure that no one other than you is speaking during a voice command period
- Low-To-Medium Blower Setting
- Low-To-Medium Vehicle Speed
- Low Road Noise
- Smooth Road Surface
- Fully Closed Windows
- Dry Weather Conditions

280 MULTIMEDIA

WARNING!

ALWAYS drive safely with your hands on the wheel. You have full responsibility and assume all risks related to the use of the Uconnect features and applications in this vehicle. Only use Uconnect when it is safe to do so. Failure to do so may result in an accident involving serious injury or death.

Even though the system is designed for many languages and accents, the system may not always work for some.

NOTE:

It is recommended that you do not store names in your Favorites phonebook while the vehicle is in motion.

Number and name recognition rate is optimized when the entries are not similar. You can say "O" (letter "O") for "0" (zero).

Even though international dialing for most number combinations is supported, some shortcut dialing number combinations may not be supported.

Audio Performance

Audio quality is maximized under:

- Low-To-Medium Blower Setting
- Low-To-Medium Vehicle Speed
- Low Road Noise
- Smooth Road Surface
- Fully Closed Windows
- Dry Weather Conditions
- Operation From The Driver's Seat

Performance such as audio clarity, echo, and loudness to a large degree rely on the phone and network, and not the Uconnect Phone.

Echo at the far end can sometimes be reduced by lowering the in-vehicle audio volume.

Phone Voice Commands

Making and answering hands-free phone calls is easy with Uconnect. When the Phonebook button is illuminated on your touchscreen, your system is ready. Check UconnectPhone.com for mobile phone compatibility and pairing instructions.



Push the Phone button  and wait for the beep to say a command. See some examples below:

- "Call John Smith"
- "Dial 123 456 7890"
- "Redial" (call previous outgoing phone number)
- "Call back" (call previously answered incoming phone number)

Did You Know: When providing a Voice Command, push the Phone button  and say "Call", then pronounce the name **exactly** as it appears in your phonebook. When a contact has multiple phone numbers, you can say "Call John Smith **work**".

Voice Text Reply – If Equipped

Uconnect can announce **incoming** text messages.

Push the VR button  or Phone button  and say:

1. "Listen" to have the system read an incoming text message. (Must have compatible mobile phone paired to Uconnect system.)
2. "Reply" after an incoming text message has been read.

Listen to the Uconnect prompts. After the beep, repeat one of the predefined messages and follow the system prompts.

| PRE-DEFINED VOICE TEXT REPLY RESPONSES | | |
|--|-----------------------|---|
| Yes. | Stuck in traffic. | See you later. |
| No. | Start without me. | I'll be late. |
| Okay. | Where are you? | I will be 5 <or 10, 15, 20, 25, 30, 45, 60> minutes late. |
| Call me. | Are you there yet? | |
| I'll call you later. | I need directions. | See you in 5 <or 10, 15, 20, 25, 30, 45, 60> minutes. |
| I'm on my way. | Can't talk right now. | |
| I'm lost. | | Thanks. |

NOTE:

Only use the numbering listed in the provided table. Otherwise, the system will not transpose the message.

Did You Know: Your mobile phone must have the full implementation of the **Message Access Profile (MAP)** to take advantage of this feature. For details about MAP, visit UconnectPhone.com.

Apple® iPhone® iOS 6 or later supports reading **incoming** text messages only. For further information on how to enable this feature on your Apple® iPhone®, refer to your iPhone's® "User Manual".

Did You Know: Voice Text Reply is not compatible with iPhone®, but if your vehicle is equipped with Siri® Eyes Free, you can use your voice to send a text message.

Siri® Eyes Free – If Equipped

When used with your Apple® iPhone® connected to your vehicle via Bluetooth®, Siri lets you use your voice to send text messages, select media, place phone calls and much more. Siri uses your natural language to understand what you mean and responds back to confirm your requests. The system is designed to keep your eyes on the road and your hands on the wheel by letting Siri help you perform useful tasks.

To enable Siri, push and hold, then release the Uconnect Voice Recognition (VR) button on the steering wheel. After you hear a double beep, you can ask Siri to play podcasts and music, get directions, read text messages, and many other useful requests.

BLUETOOTH® COMMUNICATION LINK

Mobile phones may lose connection to the Uconnect Phone. When this happens, the connection can generally be re-established by restarting the mobile phone. Your mobile phone is recommended to remain in Bluetooth® ON mode.

POWER-UP

After switching the ignition key from OFF to either the ON/RUN or ACC position, or after a language change, you must wait at least 15 seconds prior to using the system → page 458.

RADIO OPERATION AND MOBILE PHONES

Under certain conditions, the mobile phone being on in your vehicle can cause erratic or noisy performance from your radio. This condition may be lessened or eliminated by repositioning the mobile phone within the vehicle. This condition is not harmful to the radio. If your radio performance does not satisfactorily improve from repositioning the mobile phone, it is recommended that the volume be turned down or off during mobile phone operation when not using the Uconnect system.

282 MULTIMEDIA

REGULATORY AND SAFETY INFORMATION

US/CANADA

Exposure to Radio Frequency Radiation

The radiated output power of the internal wireless radio is far below the FCC and IC radio frequency exposure limits. Nevertheless, the wireless radio will be used in such a manner that the radio is 8 in (20 cm) or further from the human body.

The internal wireless radio operates within guidelines found in radio frequency safety standards and recommendations, which reflect the consensus of the scientific community.

The radio manufacturer believes the internal wireless radio is safe for use by consumers. The level of energy emitted is far less than the electromagnetic energy emitted by wireless devices such as mobile phones. However, the use of wireless radios may be restricted in some situations or environments, such as aboard airplanes. If you are unsure of restrictions, you are encouraged to ask for authorization before turning on the wireless radio → page 458.

PERFORMANCE PAGES — IF EQUIPPED

Performance Pages is an application that provides a display for performance indicators that will help you gain familiarity with the capabilities of your vehicle in real time.

To access the Performance Pages, press the Vehicle button on the touchscreen. Then, press the Performance tab. Press the desired button on the touchscreen to access that specific Performance Page.

WARNING!

Measurement of vehicle statistics with the Performance Pages is intended for off-highway or off-road use only and should not be done on any public roadways. It is recommended that these features be used in a controlled environment and within the limits of the law. The capabilities of the vehicle as measured by the Performance Pages must never be exploited in a reckless or dangerous manner, which can jeopardize the user's safety or the safety of others. Only a safe, attentive, and skillful driver can prevent accidents.

The Performance Pages include the following:

- Timers
- Gauges
- G-Force
- Dyno/Engine
- Vehicle Dynamics

Snapshot

The Snapshot feature allows you to take a screenshot of any page. The information can be saved onto a USB device.

To take a snapshot, make sure a USB device is plugged into the vehicle. Next, press the Snapshot icon located in the lower left corner of the touchscreen.

The file will be saved to the USB drive. At the time a snapshot is taken, the bottom bar of the touchscreen will be replaced with the historical data from the vehicle present at the time the snapshot icon was pressed. The following information will display:

- Date
- Vehicle Identification Number (VIN)
- Longitude And Latitude Coordinates
- Outside Temperature
- Odometer

The following describes each feature and its operation:

TIMERS

When the Timers page is selected, you will be able to view the Drag and Accel & Braking timers.

- Recent

A real-time summary of performance timers for the most recent valid run, or the status of a test in progress.

- Last

The last recorded run of performance timers.

- Best

The best recorded run of performance timers, except for braking data.

Save

Pressing the SAVE button will let you save the timer data for Recent, Last, and Best recorded times to an inserted USB flash drive.

The Timers pages contain the timers listed below:

- **Reaction Time:** Measures the driver's reaction time for launching the vehicle against a simulated drag strip timing light (behavior modeled after 500 Sportsman Tree) displayed in the instrument cluster display.

NOTE:

Drag timers (RT, 60 ft [20 m], 330 ft [100 m], 1/8 mile [200 m], 1000 ft [300 m], and 1/4 mile [400 m]) and Acceleration Timers (0-60 mph [0-96 km/h] and 0-100 mph [0-160 km/h]) will be ready to acquire new recent data measurements when the vehicle is at 0 mph (0 km/h) and vehicle is in drive.

The timer listed below shows the measured time required to travel at the cited distance is met. Some timers will also display speeds present at the time the distance was met.

- 0-60 mph (0-100 km/h)
- 0-100 mph (0-160 km/h)
- 60 ft (20 m) ET
- 330 ft (100 m) ET
- 1/8 Mile (200 m) + ET
- 1/8 Mile (200) + mph
- 1000 ft (300 m) ET
- 1/4 Mile (400 m) + ET
- 1/4 Mile (400 m) + mph
- Brake Distance ft (meters)

NOTE:

The distance measurement will be aborted if the brake pedal is released or the parking brake is engaged, before the vehicle comes to a complete stop.

- Brake from mph (km/h)

NOTE:

Brake Distance and Speed timers only display "ready" when vehicle is traveling at a speed greater than 30 mph (48 km/h).

GAUGES

When selected, this screen displays the following values:

- Coolant Temperature
Shows the actual coolant temperature.
- Oil Temperature
Shows the actual oil temperature.
- Oil Pressure
Shows the actual oil pressure.
- Trans Temp
Shows actual transmission oil temperature.
- Battery Voltage
Shows actual battery voltage.
- Intake Air Temp
Shows actual intake air temperature.

If a gauge is selected, the Gauge Detail View Page will appear on the screen. This page shows gauge values for the previous two minutes on the selected gauge.

284 MULTIMEDIA

Pressing the Left or Right Arrow will cycle through the details for each of the gauges. Pressing the minimize button beside the graph will return to the Gauge menu.

G-FORCE

When G-Force is selected, the following features will be available:

- Vehicle Speed
Measures the current speed of the vehicle in either mph or km/h, starting at zero with no maximum value.
- Front G-Force
Measures the peak braking force on the front of the vehicle.
- Right G-Force
Measures the peak force on the right side of the vehicle.
- Left G-Force
Measures the peak force on the left side of the vehicle.
- Rear G-Force
Measures the peak acceleration force on the rear of the vehicle.

NOTE:

Front, Right, Left, and Rear G-Forces are all peak values. These readings can be reset by clearing peak G-Force on the instrument cluster.

The friction circle display shows instantaneous G-Force as a highlight and previous G-Force as dots within the circle. The system records previous G-Force for three minutes. If there are multiple samples at a given point, the color of the dot will darken from blue to red. Vectors more frequent will show in red; infrequent vectors will show in blue.

Pitch & Roll

The G-Force page displays the vehicle's current pitch (angle up and down) and roll (angle side to side) in degrees. The pitch and roll gauges provide a visualization of the current vehicle angle.

DYNAMOMETER (DYNO)/ENGINE

Dynamometer (Dyno)

The system will start drawing graphs for Power and Torque (top chart) and Engine Speed (bottom chart). The graph will fill from the left side of the x-axis and fill to the right side of the x-axis (based on History time selected). Once the right side of the page is reached, the graph will scroll with the right side always being the most recent recorded sample.

The following options can be selected:

- Pressing the STOP button will freeze the graph. Selecting "Play" will clear the graph and restart the process.
- Press the + or - button to change the history of the graph. The selectable options are "30", "60", "90", "120" seconds. The graph will expand or constrict depending on the setting selected.
- Select the "Gear" display setting to turn the graph gear markers on or off.

NOTE:

The Gear On/Off feature will only display if your vehicle is equipped with an Automatic Transmission.

Engine

Press the Left and Right Arrow buttons on the bottom of the touchscreen to cycle between the Dyno and Engine pages.

When selected, this screen displays the following values:

- **Vehicle Speed:** Shows the actual vehicle speed.
- **Engine Power:** Shows the instantaneous power.
- **Engine Torque:** Shows the instantaneous torque.
- **Boost Pressure:** Shows the actual engine boost pressure.
- **Gear:** Shows the current (or pending) operating gear of the vehicle.

VEHICLE DYNAMICS

The Vehicle Dynamics page displays information concerning the vehicle's drivetrain.

Steering Angle — If Equipped

Steering Angle utilizes the steering angle sensor to calculate the degree of the steering relative to zero (straight ahead) reference angle. The zero degree reference angle measurement indicates the actual front tire steering angle.

Transfer Case

This feature will be active when the vehicle is in 4WD HIGH, 4WD AUTO, Neutral, or 4WD LOW.

NOTE:

A lock symbol will only be present on the Transfer Case button when the vehicle is in 4WD LOW.

Rear Axle Locker

This feature will allow you to lock and unlock the rear axle. To change the status, push the AXLE LOCK button.

OFF-ROAD PAGES — IF EQUIPPED

Your vehicle may be equipped with Off-Road Pages which display vehicle information related to the drivetrain, transfer case, and coolant/oil gauges.

To access Off-Road Pages, press the Vehicle button on the touchscreen, select the Off-Road Pages tab, and then select the Off-Road button on the main screen. Off-Road Pages can also be accessed through the app drawer.

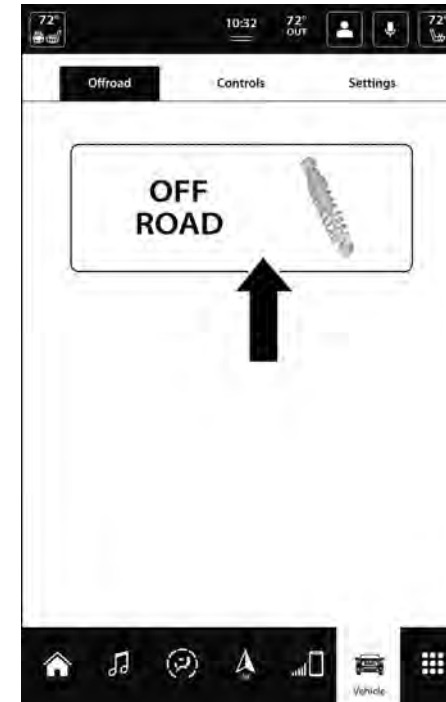

Off-Road Button

286 MULTIMEDIA

OFF-ROAD PAGES STATUS BAR

The Off-Road Pages Status Bar is located along the bottom of Off-Road Pages and is present in each of the four selectable page options. It provides information for the following items:

1. Transfer Case Status
2. Latitude/Longitude
3. Altitude of the vehicle
4. Status of Hill Descent Control
5. Speed in MPH (km/h)

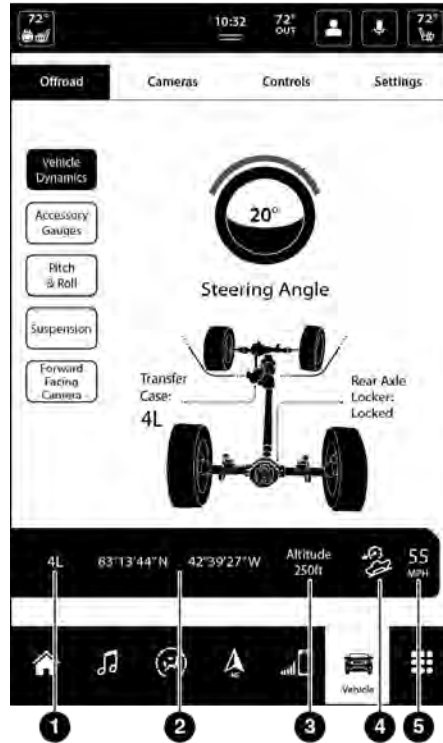

Status Bar 2WD/4WD

- 1 – Transfer Case Status
- 2 – Latitude/Longitude
- 3 – Altitude
- 4 – Hill Descent Control Status
- 5 – Speed

VEHICLE DYNAMICS

The Vehicle Dynamics page displays information concerning the vehicle's transfer case and steering angle.

The following information is displayed:

1. Status of Transfer Case
2. Status of Front Axles — If Equipped
3. Status of the Rear Axles
4. Steering angle in degrees

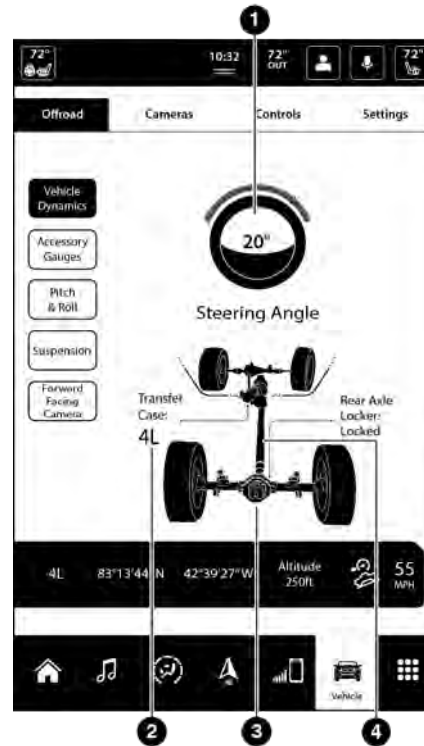

Drivetrain Menu 2WD/4WD

- 1 — Steering Angle
- 2 — Transfer Case Status
- 3 — Rear Axle Locker Status
- 4 — Rear Axle

ACCESSORY GAUGE

The Accessory Gauge page displays the current status of the vehicle's Coolant Temperature, Oil Temperature, Oil Pressure, Transmission Temperature, and Battery Voltage.

288 MULTIMEDIA

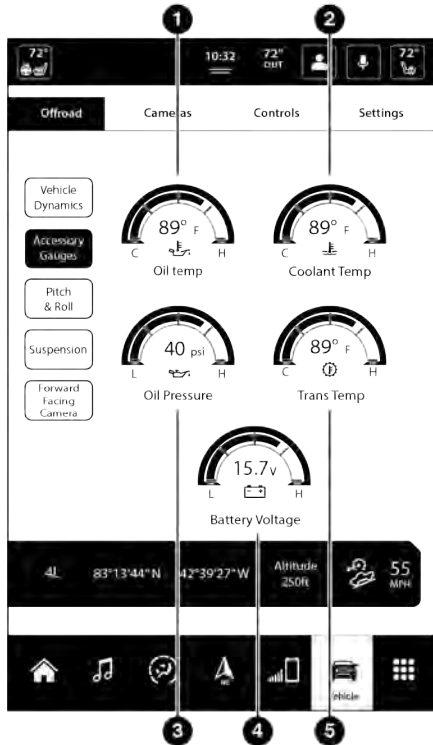

Accessory Gauge Menu 2WD/4WD

- 1 – Oil Temperature
- 2 – Coolant Temperature
- 3 – Oil Pressure
- 4 – Battery Voltage
- 5 – Transmission Temperature

PITCH & ROLL

The Pitch & Roll page displays the vehicle's current pitch (angle up and down) and roll (angle side to side) in degrees. The Pitch & Roll gauge provide a visualization of the current vehicle angle.

NOTE:

Pitch & Roll values may show upon startup. These numbers will update once the vehicle is driven.

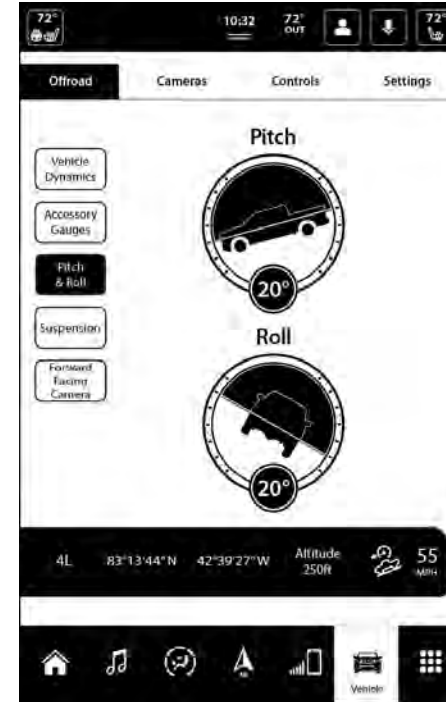

Pitch & Roll Menu 2WD/4WD

SUSPENSION

The Suspension page displays the current status of the vehicle's suspension system and the current ride height of the vehicle. The Suspension page will also indicate when the vehicle's height changes.

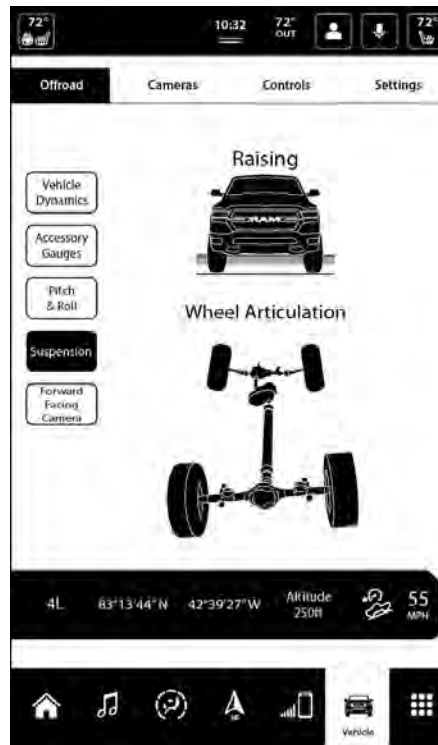

Suspension Menu

FORWARD FACING CAMERA

Your vehicle may be equipped with a Forward Facing Camera that allows you to see an on-screen image of the front view of your vehicle. The image will be displayed on the touchscreen along with a caution note "Check Entire Surroundings" across the top of the screen.

To activate, press the Forward Facing Camera button on the touchscreen.

SAFETY

SAFETY FEATURES

ANTI-LOCK BRAKE SYSTEM (ABS)

The ABS provides increased vehicle stability and brake performance under most braking conditions. The system automatically prevents wheel lock, and enhances vehicle control during braking.

The ABS performs a self-check cycle to ensure that the ABS is working properly each time the vehicle is started and driven. During this self-check, you may hear a slight clicking sound as well as some related motor noises.

The ABS is activated during braking when the system detects one or more wheels are beginning to lock. Road conditions such as ice, snow, gravel, bumps, railroad tracks, loose debris, or panic stops may increase the likelihood of ABS activation(s).

You also may experience the following normal characteristics when the ABS activates:

- ABS motor noise or clicking sounds (you may continue to hear for a short time after the stop)
- Brake pedal pulsations
- A slight drop of the brake pedal at the end of the stop

The ABS is designed to function with the Original Equipment Manufacturer (OEM) tires. Modification may result in degraded ABS performance.

WARNING!

- The ABS contains sophisticated electronic equipment that may be susceptible to interference caused by improperly installed or high output radio transmitting equipment. This interference can cause possible loss of anti-lock braking capability. Installation of such equipment should be performed by qualified professionals.
- Pumping of the Anti-Lock Brakes will diminish their effectiveness and may lead to a collision. Pumping makes the stopping distance longer. Just press firmly on your brake pedal when you need to slow down or stop.
- The ABS cannot prevent the natural laws of physics from acting on the vehicle, nor can it increase braking or steering efficiency beyond that afforded by the condition of the vehicle brakes and tires or the traction afforded.

(Continued)

WARNING!

- The ABS cannot prevent collisions, including those resulting from excessive speed in turns, following another vehicle too closely, or hydroplaning.
- The capabilities of an ABS equipped vehicle must never be exploited in a reckless or dangerous manner that could jeopardize the user's safety or the safety of others.

Anti-Lock Brake System (ABS) Warning Light

The yellow ABS Warning Light will turn on when the ignition is placed in the ON/RUN mode and may stay on for as long as four seconds.

If the ABS Warning Light remains on or comes on while driving, it indicates that the anti-lock portion of the brake system is not functioning and that service is required. However, the conventional brake system will continue to operate normally if the ABS Warning Light is on.

If the ABS Warning Light is on, the brake system should be serviced as soon as possible to restore the benefits of anti-lock brakes. If the ABS Warning Light does not come on when the ignition is placed in the ON/RUN mode, have the light repaired as soon as possible.

ELECTRONIC BRAKE CONTROL (EBC) SYSTEM

Your vehicle is equipped with an advanced Electronic Brake Control (EBC) system. This system includes Anti-Lock Brake System (ABS), Brake Assist System (BAS), Electronic Brake Force Distribution (EBD), Electronic Roll Mitigation (ERM), Electronic Stability Control (ESC), Hill Start Assist (HSA), and Traction Control System (TCS). These systems work together to enhance both vehicle stability and control in various driving conditions.

Your vehicle may also be equipped with Trailer Sway Control (TSC) and Hill Descent Control (HDC).

Brake Assist System (BAS)

The BAS is designed to optimize the vehicle's braking capability during emergency braking maneuvers. The system detects an emergency braking situation by sensing the rate and amount of brake application, and then applies optimum pressure to the brakes. This can help reduce braking distances. The BAS complements the

Anti-Lock Brake System (ABS). Applying the brakes very quickly results in the best BAS assistance. To receive the benefit of the system, you must apply continuous braking pressure during the stopping sequence (do not "pump" the brakes). Do not reduce brake pedal pressure unless braking is no longer desired. Once the brake pedal is released, the BAS is deactivated.

WARNING!

The Brake Assist System (BAS) cannot prevent the natural laws of physics from acting on the vehicle, nor can it increase the traction afforded by prevailing road conditions. BAS cannot prevent collisions, including those resulting from excessive speed in turns, driving on very slippery surfaces, or hydroplaning. The capabilities of a BAS-equipped vehicle must never be exploited in a reckless or dangerous manner, which could jeopardize the user's safety or the safety of others.

Brake System Warning Light

The red Brake System Warning Light will turn on when the ignition is placed in the ON/RUN mode and may stay on for as long as four seconds.

If the Brake System Warning Light remains on or comes on while driving, it indicates that the brake system is not functioning properly and that immediate service is required. If the Brake System

Warning Light does not come on when the ignition is placed in the ON/RUN mode, have the light repaired as soon as possible.

Electronic Brake Force Distribution (EBD)

EBD manages the distribution of the braking torque between the front and rear axles by limiting braking pressure to the rear axle. This is done to prevent overslip of the rear wheels to avoid vehicle instability, and to prevent the rear axle from entering the Anti-Lock Brake System (ABS) before the front axle.

Electronic Roll Mitigation (ERM)

The ERM system anticipates the potential for wheel lift by monitoring the driver's steering wheel input and the speed of the vehicle. When ERM determines that the rate of change of the steering wheel angle and vehicle's speed are sufficient to potentially cause wheel lift, it then applies the appropriate brake and may also reduce engine power to lessen the chance that wheel lift will occur. ERM can only reduce the chance of wheel lift occurring during severe or evasive driving maneuvers; it cannot prevent wheel lift due to other factors, such as road conditions, leaving the roadway, striking objects or other vehicles.

292 SAFETY

WARNING!

Many factors, such as vehicle loading, road conditions and driving conditions, influence the chance that wheel lift or rollover may occur. ERM cannot prevent all wheel lift or rollovers, especially those that involve leaving the roadway or striking objects or other vehicles. The capabilities of an ERM-equipped vehicle must never be exploited in a reckless or dangerous manner which could jeopardize the user's safety or the safety of others.

Electronic Stability Control (ESC)

ESC enhances directional control and stability of the vehicle under various driving conditions. ESC corrects for oversteering or understeering of the vehicle by applying the brake of the appropriate wheel(s) to counteract the above conditions. Engine power may also be reduced to help the vehicle maintain the desired path.

- Oversteer – when the vehicle is turning more than appropriate for the steering wheel position.
- Understeer – when the vehicle is turning less than appropriate for the steering wheel position.

ESC uses sensors in the vehicle to determine the vehicle path intended by the driver and compares it to the actual path of the vehicle. When the actual path does not match the intended path, ESC applies the brake of the appropriate wheel to assist in counteracting the oversteer or understeer condition.

The ESC Activation/Malfunction Indicator Light located in the instrument cluster will start to flash as soon as the ESC system becomes active. The ESC Activation/Malfunction Indicator Light also flashes when the TCS is active. If the ESC Activation/Malfunction Indicator Light begins to flash during acceleration, ease up on the accelerator and apply as little throttle as possible. Be sure to adapt your speed and driving to the prevailing road conditions.

WARNING!

- Electronic Stability Control (ESC) cannot prevent the natural laws of physics from acting on the vehicle, nor can it increase the traction afforded by prevailing road conditions. ESC cannot prevent accidents, including those resulting from excessive speed in turns, driving on very slippery surfaces, or hydroplaning. ESC also cannot prevent accidents resulting from loss of vehicle control due to inappropriate driver input for the conditions. Only a safe, attentive, and skillful driver can prevent accidents. The capabilities of an ESC equipped vehicle must never be exploited in a reckless or dangerous manner which could jeopardize the user's safety or the safety of others.

(Continued)

WARNING!

- Vehicle modifications, or failure to properly maintain your vehicle, may change the handling characteristics of your vehicle, and may negatively affect the performance of the ESC system. Changes to the steering system, suspension, braking system, tire type and size or wheel size may adversely affect ESC performance. Improperly inflated and unevenly worn tires may also degrade ESC performance. Any vehicle modification or poor vehicle maintenance that reduces the effectiveness of the ESC system can increase the risk of loss of vehicle control, vehicle rollover, personal injury and death.

ESC Operating Modes

Depending upon model and mode of operation, the ESC system may have multiple operating modes.

ESC On

This is the normal operating mode for the ESC. Whenever the vehicle is started, the ESC system will be in this mode. This mode should be used for most driving conditions. Alternate ESC modes should only be used for specific reasons as noted in the following paragraphs.

Partial Off

This mode may be useful if the vehicle becomes stuck. This mode may modify TCS and ESC thresholds for activation, which allows for more wheel spin than normally allowed.

To enter the "Partial Off" mode, momentarily push the ESC OFF button and the ESC OFF Indicator Light will illuminate. To turn the ESC on again, momentarily push the ESC OFF button and the ESC OFF Indicator Light will turn off.

NOTE:

For vehicles with multiple partial ESC modes, the push and release of the button will toggle the ESC modes. Multiple attempts may be required to return to "ESC On".

WARNING!

- When in "Partial Off" mode, the TCS functionality of ESC (except for the limited slip feature described in the TCS section) has been disabled and the ESC OFF Indicator Light will be illuminated. When in "Partial Off" mode, the engine power reduction feature of TCS is disabled, and the enhanced vehicle stability offered by the ESC system is reduced.
- Trailer Sway Control (TSC) is disabled when the ESC system is in the "Partial Off" mode.

Full Off – If Equipped

This mode is intended for off-highway or off-road use only and should not be used on any public roadways. In this mode, TCS and ESC features are turned off. To enter the "Full Off" mode, push and hold the ESC OFF button for five seconds while the vehicle is stopped with the engine running. After five seconds, a chime will sound, the ESC OFF Indicator Light will illuminate, and the "ESC OFF" message will display in the instrument cluster. To turn ESC on again, momentarily push the ESC OFF button.

NOTE:

System may switch from ESC "Full Off" to "Partial Off" mode when vehicle exceeds a predetermined speed. When the vehicle speed slows below the predetermined speed the system will return to ESC "Full Off".

ESC modes may also be affected by drive modes (if equipped).

294 SAFETY

WARNING!

- In the ESC “Full Off” mode, the engine torque reduction and stability features are disabled. Therefore, enhanced vehicle stability offered by the ESC system is unavailable. In an emergency evasive maneuver, the ESC system will not engage to assist in maintaining stability. ESC “Full Off” mode is intended for off-highway or off-road use only.
- The Electronic Stability Control (ESC) cannot prevent the natural laws of physics from acting on the vehicle, nor can it increase the traction afforded by prevailing road conditions. ESC cannot prevent all accidents, including those resulting from excessive speed in turns, driving on very slippery surfaces, or hydroplaning. ESC also cannot prevent collisions.

ESC Activation/Malfunction Indicator Light And ESC OFF Indicator Light

The ESC Activation/Malfunction Indicator Light in the instrument cluster will come on when the ignition is placed in the ON/RUN mode. It should go out with the engine running. If the ESC Activation/Malfunction Indicator Light comes on continuously with the engine running, a malfunction has been detected in the ESC system. If this light remains on after several ignition cycles, and the vehicle has been driven several miles (kilometers) at speeds greater than 30 mph (48 km/h), see an authorized dealer as soon as possible to have the problem diagnosed and corrected.

The ESC Activation/Malfunction Indicator Light starts to flash as soon as the tires lose traction and the ESC system becomes active. The ESC Activation/Malfunction Indicator Light also flashes when TCS is active. If the ESC Activation/Malfunction Indicator Light begins to flash during acceleration, ease up on the accelerator and apply as little throttle as possible. Be sure to adapt your speed and driving to the prevailing road conditions.



The ESC OFF Indicator Light indicates that the Electronic Stability Control (ESC) is in a reduced mode.

NOTE:

- The ESC Activation/Malfunction Indicator Light and the ESC OFF Indicator Light come on momentarily each time the ignition is placed in the ON/RUN mode.
- Each time the ignition is placed in the ON/RUN mode, the ESC system will be on even if it was turned off previously.
- The ESC system will make buzzing or clicking sounds when it is active. This is normal; the sounds will stop when ESC becomes inactive following the maneuver that caused the ESC activation.

Hill Descent Control (HDC) – If Equipped

HDC is intended for low speed off-road driving while in 4WD Low. HDC maintains vehicle speed while descending hills during various driving situations. HDC controls vehicle speed by actively controlling the brakes.

HDC Has Three States:

1. Off (feature is not enabled and will not activate).
2. Enabled (feature is enabled and ready but activation conditions are not met, or driver is actively overriding with brake or throttle application).
3. Active (feature is enabled and actively controlling vehicle speed).

Enabling HDC

HDC is enabled by pushing the HDC switch, but the following conditions must also be met to enable HDC:

- The driveline is in 4WD Low.
- The vehicle speed is below 5 mph (8 km/h).
- The parking brake is released.
- The driver door is closed.

Activating HDC

Once HDC is enabled it will activate automatically if driven down a grade of sufficient magnitude. The set speed for HDC is selectable by the driver, and can be adjusted by using the gear shift +/- . The following summarizes the HDC set speeds:

HDC Target Set Speeds

- P = No set speed. HDC may be enabled but will not activate.
- R = 0.6 mph (1 km/h)
- N = 1.2 mph (2 km/h)
- D = 0.6 mph (1 km/h)
- 1st = 0.6 mph (1 km/h)
- 2nd = 1.2 mph (2 km/h)
- 3rd = 1.8 mph (3 km/h)
- 4th = 2.5 mph (4 km/h)
- 5th = 3.1 mph (5 km/h)

- 6th = 3.7 mph (6 km/h)
- 7th = 4.3 mph (7 km/h)
- 8th = 5.0 mph (8 km/h)
- 9th = 5.6 mph (9 km/h) – If Equipped

NOTE:

During HDC the +/- shifter input is used for HDC target speed selection, but will not affect the gear chosen by the transmission. When actively controlling HDC the transmission will shift appropriately for the driver-selected set speed and corresponding driving conditions.

Driver Override

The driver may override HDC activation with throttle or brake application at any time.

Deactivating HDC

HDC will be deactivated but remain available if any of the following conditions occur:

- The driver overrides HDC set speed with throttle or brake application.
- The vehicle speed exceeds 20 mph (32 km/h) but remains below 40 mph (64 km/h).
- The vehicle is on a downhill grade of insufficient magnitude, is on level ground, or is on an uphill grade.
- The vehicle is shifted to PARK.

Disabling HDC

HDC will be deactivated and disabled if any of the following conditions occur:

- The driver pushes the HDC switch.
- The driveline is shifted out of the 4WD Low.
- The parking brake is applied.
- The driver door opens.
- The vehicle is driven greater than 20 mph (32 km/h) for greater than 70 seconds.
- The vehicle is driven greater than 40 mph (64 km/h) (HDC exits immediately).
- HDC detects excessive brake temperature.

Feedback To The Driver

The instrument cluster has an HDC icon and the HDC switch has an LED icon, which offers feedback to the driver about the state HDC is in.

- The cluster icon and switch lamp will illuminate and remain on solid when HDC is enabled or activated. This is the normal operating condition for HDC.
- The cluster icon and switch lamp will flash for several seconds, then extinguish when the driver pushes the HDC switch but enable conditions are not met.

296 SAFETY

- The cluster icon and switch lamp will flash for several seconds, then extinguish when HDC disables due to excess speed.
- The cluster icon and switch lamp will flash when HDC deactivates due to overheated brakes. The flashing will stop and HDC will activate again once the brakes have cooled sufficiently.

WARNING!

HDC is only intended to assist the driver in controlling vehicle speed when descending hills. The driver must remain attentive to the driving conditions and is responsible for maintaining a safe vehicle speed.

Hill Start Assist (HSA)

HSA is designed to mitigate roll back from a complete stop while on an incline. If the driver releases the brake while stopped on an incline, HSA will continue to hold the brake pressure for a short period. If the driver does not apply the throttle before this time expires, the system will release brake pressure and the vehicle will roll down the hill as normal.

The following conditions must be met in order for HSA to activate:

- The feature must be enabled.
- The vehicle must be stopped.
- The parking brake must be off.
- The driver door must be closed.
- The vehicle must be on a sufficient grade.
- The gear selection must match vehicle uphill direction (i.e., vehicle facing uphill is in forward gear; vehicle backing uphill is in REVERSE gear).
- HSA will work in REVERSE gear and all forward gears. The system will not activate if the transmission is in PARK or NEUTRAL.

WARNING!

There may be situations where the Hill Start Assist (HSA) will not activate and slight rolling may occur, such as on minor hills or with a loaded vehicle, or while pulling a trailer. HSA is not a substitute for active driving involvement. It is always the driver's responsibility to be attentive to distance to other vehicles, people, and objects, and most importantly brake operation to ensure safe operation of the vehicle under all road conditions. Your complete attention is always required while driving to maintain safe control of your vehicle. Failure to follow these warnings can result in a collision or serious personal injury.

Disabling And Enabling HSA

This feature can be turned on or turned off. To change the current setting, proceed as follows:

If disabling HSA using Uconnect Settings
⇨ page 237.

Towing With HSA

HSA will also provide assistance to mitigate roll back while towing a trailer.

WARNING!

- If you use a trailer brake controller with your trailer, the trailer brakes may be activated and deactivated with the brake switch. If so, there may not be enough brake pressure to hold both the vehicle and the trailer on a hill when the brake pedal is released. In order to avoid rolling down an incline while resuming acceleration, manually activate the trailer brake or apply more vehicle brake pressure prior to releasing the brake pedal.
- HSA is not a parking brake. Always apply the parking brake fully when exiting your vehicle. Also, be certain to place the transmission in PARK.
- Failure to follow these warnings can result in a collision or serious personal injury.

Rain Brake Support (RBS)

RBS may improve braking performance in wet conditions. It will periodically apply a small amount of brake pressure to remove any water buildup on the front brake rotors. It functions when the windshield wipers are in LO or HI speed. When Rain Brake Support is active, there is no notification to the driver and no driver interaction is required.

Ready Alert Braking (RAB)

RAB may reduce the time required to reach full braking during emergency braking situations. It anticipates when an emergency braking situation may occur by monitoring how fast the throttle is released by the driver. The Electronic Brake Control system will prepare the brake system for a panic stop.

Traction Control System (TCS)

The TCS monitors the amount of wheel spin of each of the driven wheels. If wheel spin is detected, the TCS may apply brake pressure to the spinning wheel(s) and/or reduce engine power to provide enhanced acceleration and stability. A feature of the TCS, Brake Limited Differential (BLD) functions similarly to a limited slip differential and controls the wheel spin across a driven axle. If one wheel on a driven axle is spinning faster than the

other, the system will apply the brake of the spinning wheel. This will allow more engine torque to be applied to the wheel that is not spinning. BLD may remain enabled even if TCS and Electronic Stability Control (ESC) are in reduced modes.

Trailer Sway Control (TSC)

TSC uses sensors in the vehicle to recognize an excessively swaying trailer and will take the appropriate actions to attempt to stop the sway.

NOTE:

TSC cannot stop all trailers from swaying. Always use caution when towing a trailer and follow the trailer tongue weight recommendations ⇨ page 214.

When TSC is functioning, the ESC Activation/Malfunction Indicator Light will flash, the engine power may be reduced and you may feel the brakes being applied to individual wheels to attempt to stop the trailer from swaying. TSC is disabled when the ESC system is in the "Partial Off" or "Full Off" modes.

WARNING!

If TSC activates while driving, slow the vehicle down, stop at the nearest safe location, and adjust the trailer load to eliminate trailer sway.

298 SAFETY

AUXILIARY DRIVING SYSTEMS**BLIND SPOT MONITORING (BSM) —
IF EQUIPPED**

BSM uses two radar sensors, located inside the taillights, to detect highway licensable vehicles (automobiles, trucks, motorcycles, etc.) that enter the blind spot zones from the rear/front/side of the vehicle.

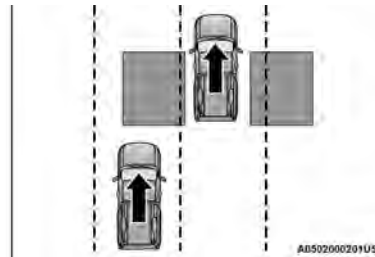
**Rear Detection Zones**

When the vehicle is started, the BSM Warning Light will momentarily illuminate in both outside rearview mirrors to let the driver know that the system is operational. The BSM system sensors operate when the vehicle is in any forward gear or REVERSE and enters standby mode when the vehicle is in PARK.

The BSM detection zone covers approximately one lane width on both sides of the vehicle 12 ft (3.8 m). The zone length starts at the outside rearview mirror and extends approximately 10 ft (3 m) beyond the rear fascia/bumper of the vehicle. The BSM system monitors the detection zones on both sides of the vehicle when the vehicle speed reaches approximately 6 mph (10 km/h) or higher and will alert the driver of vehicles in these areas.

NOTE:

- The BSM system DOES NOT alert the driver about rapidly approaching vehicles that are outside the detection zones.
- BSM may experience dropouts (blinking on and off) of the side mirror warning indicator lamps when a motorcycle or any small object remains at the side of the vehicle for extended periods of time (more than a couple of seconds).

The BSM system can become blocked if snow, ice, mud, or other road contaminations accumulate on the rear fascia/bumper where the radar sensors are located. The system may also detect blockage if the vehicle is operated in areas with extremely low radar returns such as a desert or parallel to a large elevation drop. If blockage is detected, a “Blind Spot Temporarily Unavailable, Wipe Rear Corners” message will display in the cluster, both mirror lights will illuminate, and BSM and RCP alerts will not occur. This is normal operation. The

system will automatically recover and resume function when the condition clears. To minimize system blockage, do not block the area of the rear fascia/bumper where the radar sensors are located with foreign objects (bumper stickers, bicycle racks, etc.) and keep it clear of road contaminations.

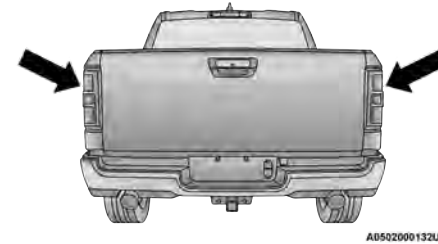
**Radar Sensor Locations**

If the system detects degraded performance due to contamination or foreign objects, a message will warn you of a blocked sensor and the warning indicators in side view mirrors will be on. The warning indicators will remain illuminated until blockage clearing conditions are met. First clear the taillights around the sensors of the blockage. After removing the blockage, the following procedure can be used to reset the system:

Cycle the ignition from ON to OFF and then back ON.

If the blockage message is still present after cycling the ignition and driving in traffic, check again for a blockage.

The system may also detect a blockage if the vehicle is operated in areas with extremely low radar returns such as a desert or parallel to a large elevation drop.

The BSM system notifies the driver of objects in the detection zones by illuminating the BSM warning light located in the outside mirrors, in addition to sounding an audible (chime) alert and reducing the radio volume → page 301.

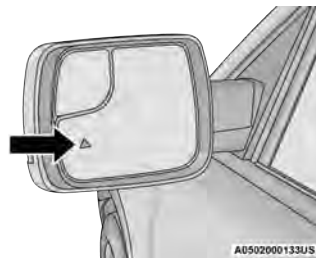

Warning Light Location

The BSM system monitors the detection zone from three different entry points (side, rear, front) while driving to see if an alert is necessary. The BSM system will issue an alert during these types of zone entries.

Entering From The Side

Vehicles that move into your adjacent lanes from either side of the vehicle.

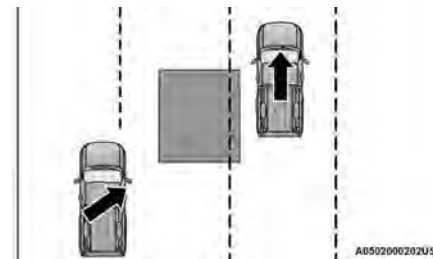

Side Monitoring

Entering From The Rear

Vehicles that come up from behind your vehicle on either side and enter the rear detection zone with a relative speed of less than 30 mph (48 km/h).

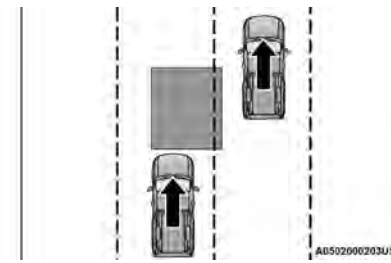

Rear Monitoring

Overtaking Traffic

If you pass another vehicle slowly with a relative speed less than 15 mph (24 km/h) and the vehicle remains in the blind spot for approximately 1.5 seconds, the warning light will be illuminated. If the difference in speed between the two vehicles is greater than 15 mph (24 km/h), the warning light will not illuminate.

300 SAFETY

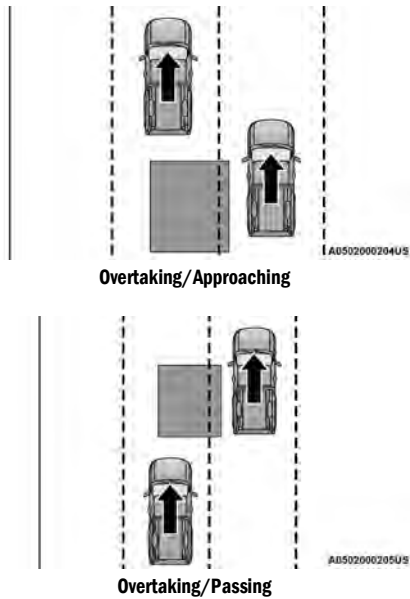

The BSM system is designed not to issue an alert on stationary objects such as guardrails, posts, walls, foliage, berms, snow banks, car washes etc. However, occasionally the system may alert on such objects. This is normal operation and your vehicle does not require service.

The BSM system will not alert you of objects that are traveling in the opposite direction of the vehicle in adjacent lanes → page 458.

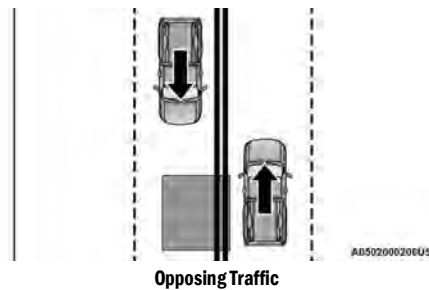

For information on how Blind Spot Monitoring functions when pulling a trailer → page 301.

| WARNING! |
|--|
| <p>The Blind Spot Monitoring system is only an aid to help detect objects in the blind spot zones. The BSM system is not designed to detect pedestrians, bicyclists, or animals. Even if your vehicle is equipped with the BSM system, always check your vehicle's mirrors, glance over your shoulder, and use your turn signal before changing lanes. Failure to do so can result in serious injury or death.</p> |

Rear Cross Path (RCP)

RCP is intended to aid the driver when backing out of parking spaces where their vision of oncoming vehicles may be blocked. Proceed slowly and cautiously out of the parking space until the rear end of the vehicle is exposed. The RCP system will then have a clear view of the cross traffic, and if an oncoming vehicle is detected, alert the driver.

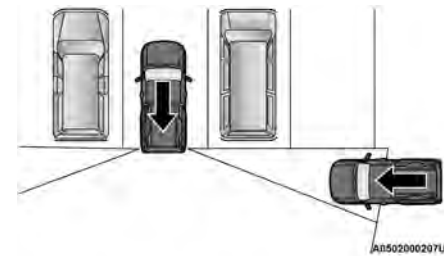

RCP monitors the rear detection zones on both sides of the vehicle with a minimum speed of approximately 3 mph (5 km/h), to objects moving a maximum of approximately 20 mph (32 km/h), such as in parking lot situations. When RCP is on and the vehicle is in REVERSE (R), the driver is alerted using both the visual and audible alarms, including reducing the radio volume.

NOTE:

In a parking lot situation, oncoming vehicles can be blocked by vehicles parked on either side. If the sensors are blocked by other structures or vehicles, the system will not be able to alert the driver.

WARNING!

Rear Cross Path Detection (RCP) is not a backup aid system. It is intended to be used to help a driver detect an oncoming vehicle in a parking lot situation. Drivers must be careful when backing up, even when using RCP. Always check carefully behind your vehicle, look behind you, and be sure to check for pedestrians, animals, other vehicles, obstructions, and blind spots before backing up. Failure to do so can result in serious injury or death.

Blind Spot Modes

Blind Spot has three selectable modes of operation that are available in the Uconnect system.

Blind Spot Alert Lights Only

When operating in Blind Spot Alert mode, the BSM system will provide a visual alert in the appropriate side view mirror based on a detected object. However, when the system is operating in Rear Cross Path (RCP) mode, the system will respond with both visual and audible alerts when a detected object is present. Whenever an audible alert is requested, the radio is muted.

Blind Spot Alert Lights/Chime

When operating in Blind Spot Alert Lights/Chime mode, the BSM system will provide a visual alert in the appropriate side view mirror based on a detected object. If the turn signal is then activated, and it corresponds to an alert present on that side of the vehicle, an audible chime will also be sounded. Whenever a turn signal and detected object are present on the same side at the same time, both the visual and audible alerts will be issued. In addition to the audible alert the radio (if on) will also be muted.

NOTE:

Whenever an audible alert is requested by the BSM system, the radio is also muted.

When the system is in RCP, the system shall respond with both visual and audible alerts when a detected object is present. Whenever an audible alert is requested, the radio is also muted. Turn/hazard signal status is ignored; the RCP state always requests the chime.

Blind Spot Alert Off

When the BSM system is turned off there will be no visual or audible alerts from either the BSM, RCP, or Trailer Merge Assist systems.

NOTE:

The BSM system will store the current operating mode when the vehicle is shut off. Each time the vehicle is started the previously stored mode will be recalled and used.

Trailer Merge Assist — If Equipped

Trailer Merge Assist is a function of the Blind Spot Monitoring (BSM) system that extends the blind spot zone to work while pulling a trailer.

302 SAFETY**NOTE:**

When Trailer Merge Assist is activated, Rear Cross Path is disabled.

Trailer Merge Assist consists of three sub functions:

- Automatic Trailer Detection
- Trailer Length Detection
- Trailer Merge Warning

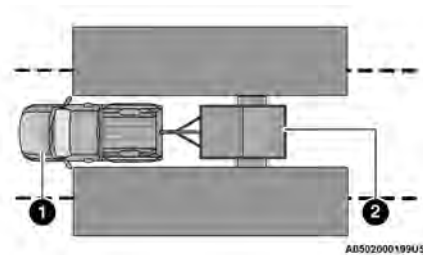



Blind Spot Zones With Trailer Merge Assist

- 1 – Vehicle
- 2 – Trailer

Automatic Trailer Detection

There are two modes of operation for the detection of the trailer length:

- *Automatic Mode* – When “Auto Mode” is selected, the system will use the blind spot sensors to automatically determine the presence and length of a trailer. The presence of a trailer will be detected using the blind spot radar within 90 seconds of forward movement of the vehicle. The vehicle must be moving above 6 mph (10 km/h) to activate the feature. Once the trailer has been detected, the system will default to the maximum blind spot zone until the length has been verified. You will see “Auto” in the instrument panel cluster .
- *Maximum Mode* – When “Max Mode” is selected, the system will default to the maximum blind spot zone regardless of what size trailer is attached .

NOTE:

Selected setting is stored when the ignition is placed in the OFF position. To change this setting, it must be selected through the Uconnect Settings  page 237.

Trailer Length Detection

Once the trailer presence has been established, the trailer length will be established (by making a 90 degree turn) and then the trailer length category (example 10-20 ft (3 m to 6 m)) will be displayed. This can take up to 30 seconds after completing the turn.

NOTE:

During the same ignition cycle, if the vehicle is at a standstill for a minimum of 90 seconds, a new “trailer detection request” is enabled by the system once the vehicle resumes motion.

The maximum trailer length supported by the Trailer Merge Assist feature is 39.5 ft (12 m). Trailer length is considered the forward most portion of the trailer hitch to the rearward most portion of the body, fascia/bumper, or ramp of the trailer.

The maximum width supported by the Trailer Merge Assist feature is 8.5 ft (2.59 m). Trailer width is measured at the widest portion of the trailer and may include wheels, tires, fenders, or rails.

NOTE:

Fifth wheel or gooseneck trailers are not supported by Trailer Merge Assist.

NOTE:

The ability to detect a trailer may be degraded in crowded or busy environments. Busy parking lots, narrow areas surrounded with trees, or any other crowded area may prevent the radar sensors from being able to adequately detect the trailer. The system will try to detect a trailer at every ignition cycle or 90 seconds of standstill.

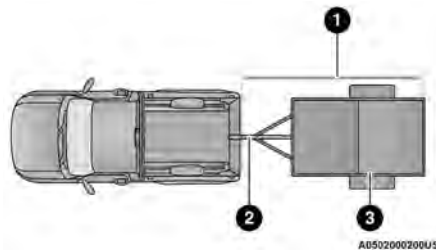

Trailer Length Detection

- 1 – Trailer Length
- 2 – Trailer Hitch
- 3 – Trailer Width

Trailer length will be identified and placed into one of the following categories:

- Trailer length up to 10 ft (3 m) – Blind spot zone will be adjusted to 10 ft (3 m) $\frac{10\text{ ft}}{3\text{ m}}$ $\frac{3\text{ m}}{3\text{ m}}$.
- Trailer length between 10 ft to 20 ft (3 m to 6 m) – Blind spot zone will be adjusted to 20 ft (6 m) $\frac{20\text{ ft}}{6\text{ m}}$ $\frac{6\text{ m}}{6\text{ m}}$.
- Trailer length between 20 ft to 30 ft (6 m to 9 m) – Blind spot zone will be adjusted to 30 ft (9 m) $\frac{30\text{ ft}}{9\text{ m}}$ $\frac{9\text{ m}}{9\text{ m}}$.
- Trailer length between 30 ft and 39.5 ft (9 m to 12 m) – Blind spot zone will be adjusted to Max distance $\frac{\text{Max}}{12\text{ m}}$.

NOTE:

Trailer length is determined within +/- 3 ft (1 m) of actual length. Trailers that are the same size as the category limit, 10/20/30 ft (3/6/9 m), could be subject to being placed in the category above or below the correct one.

Trailer Merge Warning

Trailer Merge Warning is the extension of the blind spot function to cover the length of the trailer, plus a safety margin, to warn the driver when there is a vehicle in the adjacent lane. The driver is alerted by the illumination of the BSM warning light located in the outside mirror on the side the other vehicle is detected on. In addition, an audible (chime) alert will be heard and radio volume will be reduced
 ⇨ page 301.

NOTE:

- The Trailer Merge Alert system DOES NOT alert the driver about rapidly approaching vehicles that are outside the detection zones.
- The Blind Spot Monitoring (BSM) system may experience drop outs (blinking on and off) of the side mirror warning indicator lamps when a motorcycle or any small object remains at the side of the vehicle for extended periods of time (more than a couple of seconds).
- Crowded areas such as parking lots, neighborhoods, etc. may lead to an increased amount of false alerts. This is normal operation.

| WARNING! |
|--|
| <p>The Blind Spot Monitoring system is only an aid to help detect objects in the blind spot zones. The BSM system is not designed to detect pedestrians, bicyclists, or animals. Even if your vehicle is equipped with the BSM system, always check your vehicle's mirrors, glance over your shoulder, and use your turn signal before changing lanes. Failure to do so can result in serious injury or death.</p> |

304 SAFETY

**FORWARD COLLISION WARNING (FCW)
WITH MITIGATION — IF EQUIPPED**

FCW with Mitigation provides the driver with audible warnings, visual warnings (within the instrument cluster display), and may apply a brake jerk to warn the driver when it detects a potential frontal collision. The warnings and limited braking are intended to provide the driver with enough time to react, avoid or mitigate the potential collision.

NOTE:

FCW monitors the information from the forward looking sensors as well as the Electronic Brake Controller (EBC), to calculate the probability of a forward collision. When the system determines that a forward collision is probable, the driver will be provided with audible and visual warnings as well as a possible brake jerk warning.

If the driver does not take action based upon these progressive warnings, then the system will provide a limited level of active braking to help slow the vehicle and mitigate the potential forward collision. If the driver reacts to the warnings by braking and the system determines that the driver intends to avoid the collision by braking but has not applied sufficient brake force, the system will compensate and provide additional brake force as required.

If a FCW with Mitigation event begins at a speed below 32 mph (52 km/h), the system may provide the maximum braking possible to mitigate the potential forward collision. If the Forward Collision Warning with Mitigation event stops the vehicle completely, the system will hold the vehicle at standstill for two seconds and then release the brakes.



FCW Message

When the system determines a collision with the vehicle in front of you is no longer probable, the warning message will be deactivated → page 458.

NOTE:

- The minimum speed for FCW activation is 3 mph (5 km/h).
- The FCW alerts may be triggered on objects other than vehicles such as guard rails or sign posts based on the course prediction. This is expected and is a part of normal FCW activation and functionality.
- It is unsafe to test the FCW system. To prevent such misuse of the system, after four Active Braking events within a key cycle, the Active Braking portion of FCW will be deactivated until the next key cycle.
- The FCW system is intended for on-road use only. If the vehicle is taken off-road, the FCW system should be deactivated to prevent unnecessary warnings to the surroundings.
- FCW may not react to irrelevant objects such as overhead objects, ground reflections, objects not in the path of the vehicle, stationary objects that are far away, oncoming traffic, or leading vehicles with the same or higher rate of speed.
- FCW will be disabled like ACC, with the unavailable screens.

WARNING!

Forward Collision Warning (FCW) is not intended to avoid a collision on its own, nor can FCW detect every type of potential collision. The driver has the responsibility to avoid a collision by controlling the vehicle via braking and steering. Failure to follow this warning could lead to serious injury or death.

Turning FCW On Or Off

The FCW button is located in the Uconnect display in the control settings → page 237.

- To turn the FCW system on, press the forward collision button once.
- To turn the FCW system off, press the forward collision button once.

NOTE:

- When the FCW is “on”, this allows the system to warn the driver of a possible collision with the vehicle in front.
- When the FCW is “off”, this prevents the system from warning the driver of a possible collision with the vehicle in front. If the FCW is set to “off”, “FCW OFF” will be displayed in the instrument cluster display.

- When FCW status is set to “Only Warning”, this prevents the system from providing limited active braking, or additional brake support if the driver is not braking adequately in the event of a potential frontal collision.
- When FCW status is set to “Warning and Braking”, this allows the system to warn the driver of a possible collision with the vehicle in front using audible/visual warnings and it applies autonomous braking.
- The FCW system state is defaulted to “Full On” from one ignition cycle to the next. If the system is turned off, it will reset to “Full On” when the vehicle is restarted.

FCW Braking Status And Sensitivity

The FCW Sensitivity and Active Braking status are programmable through the Uconnect system → page 237.

- Far
 - When the sensitivity of FCW is set to the “Far” setting and the system status is “Only Warning”, this allows the system to warn the driver of a possible more distant collision with the vehicle in front using audible/visual warnings.
 - More cautious drivers that do not mind frequent warnings may prefer this setting.

- Medium
 - When the sensitivity of FCW is set to the “Medium” setting and the system status is “Only Warning”, this allows the system to warn the driver of a possible collision with the vehicle in front using audible/visual warnings.
- Near
 - When the sensitivity of FCW is set to the “Near” setting and the system status is “Only Warning”, this allows the system to warn the driver of a possible closer collision with the vehicle in front using audible/visual warnings.
 - This setting provides less reaction time than the “Far” and “Medium” settings, which allows for a more dynamic driving experience.
 - More dynamic or aggressive drivers that want to avoid frequent warnings may prefer this setting.

FCW Limited Warning

If the instrument cluster displays “ACC/FCW Limited Functionality” or “ACC/FCW Limited Functionality Clean Front Windshield” momentarily, there may be a condition that limits FCW functionality. Although the vehicle is still driveable under normal conditions, the active braking may not be fully available. Once the condition that limited the system performance is

306 SAFETY

no longer present, the system will return to its full performance state. If the problem persists, see an authorized dealer.

Service FCW Warning

If the system turns off, and the instrument cluster displays:

- ACC/FCW Unavailable Service Required
- Cruise/FCW Unavailable Service Required

This indicates there is an internal system fault. Although the vehicle is still drivable under normal conditions, have the system checked by an authorized dealer.

Pedestrian Emergency Braking (PEB) — If Equipped

PEB is a subsystem of the FCW system that provides the driver with audible and visual warnings in the instrument cluster display, and may apply automatic braking when it detects a potential frontal collision with a pedestrian.

If a PEB event begins at a speed below 37 mph (60 km/h), the system may provide braking to mitigate the potential collision with a pedestrian. If the PEB event stops the vehicle completely, the system will hold the vehicle at a standstill for two seconds and then release the brakes. When the system determines a collision with the pedestrian in front of you is no longer probable, the warning message will be deactivated.

The minimum speed for PEB activation is 3 mph (5 km/h).

WARNING!

Pedestrian Emergency Braking (PEB) is not intended to avoid a collision on its own, nor can PEB detect every type of potential collision with a pedestrian. The driver has the responsibility to avoid a collision by controlling the vehicle via braking and steering. Failure to follow this warning could lead to serious injury or death.

Turning PEB On Or Off**NOTE:**

The default status of PEB is "On." This allows the system to warn you of a possible frontal collision with the pedestrian.

The PEB button is located in the Uconnect display in the controls settings → page 237.

To turn the PEB system off, push the Pedestrian Emergency Braking button once.

To turn the PEB system back on, push the Pedestrian Emergency Braking button again.

Changing the PEB status to "Off" deactivates the system, so no warning or active braking will be available in case of a possible frontal collision with the pedestrian.

NOTE:

The PEB system will retain the last setting selected by the driver after ignition shut down.

TIRE PRESSURE MONITORING SYSTEM (TPMS)

TPMS will warn the driver of a low tire pressure based on the vehicle recommended cold placard pressure.

NOTE:

The TPMS Warning Light will illuminate in the instrument cluster and a chime will sound when tire pressure is low in one or more of the four active road tires. In addition, the instrument cluster will display a graphic showing the pressure values of each tire with the low tire pressure values in a different color, or the Uconnect radio will display a TPMS message; when this occurs you must increase the tire pressure to the recommended cold placard pressure in order for the TPMS Warning Light to turn off.

The tire pressure will vary with temperature by about 1 psi (7 kPa) for every 12° F (6.5° C). This means that when the outside temperature decreases, the tire pressure will decrease. Tire pressure should always be set based on cold inflation tire pressure. This is defined as the tire pressure after the vehicle has not been driven for at least three hours, or driven less than 1 mile (1.6 km) after a three hour period. The cold tire

inflation pressure must not exceed the maximum inflation pressure molded into the tire sidewall. The tire pressure will also increase as the vehicle is driven — this is normal and there should be no adjustment for this increased pressure.

See ⇨ page 418 on how to properly inflate the vehicle's tires.

The TPMS will warn the driver of a low tire pressure if the tire pressure falls below the low-pressure warning limit for any reason, including low temperature effects and natural pressure loss through the tire ⇨ page 458.

The TPMS will continue to warn the driver of low tire pressure as long as the condition exists, and will not turn off until the tire pressure is at or above the recommended cold placard pressure. Once the low TPMS Warning Light illuminates, increase the tire pressure to the recommended cold placard pressure in order for the TPMS Warning Light to turn off. The system will automatically update and the TPMS Warning Light will turn off once the system receives the updated tire pressures. The vehicle may need to be driven for up to 20 minutes above 15 mph (24 km/h) in order for the TPMS to receive this information.

NOTE:

When filling warm tires, the tire pressure may need to be increased up to an additional 4 psi (28 kPa) above the recommended cold placard pressure in order to turn the TPMS Warning Light off.

For example, your vehicle may have a recommended cold (parked for more than three hours) placard pressure of 30 psi (207 kPa). If the ambient temperature is 68°F (20°C) and the measured tire pressure is 27 psi (186 kPa), a temperature drop to 20°F (-7°C) will decrease the tire pressure to approximately 23 psi (158 kPa). This tire pressure is sufficiently low enough to turn on the TPMS Warning Light. Driving the vehicle may cause the tire pressure to rise to approximately 27 psi (186 kPa), but the TPMS Warning Light will still be on. In this situation, the TPMS Warning Light will turn off only after the tires are inflated to the vehicle's recommended cold placard pressure value.

CAUTION!

- The TPMS has been optimized for the original equipment tires and wheels. TPMS pressures and warning have been established for the tire size equipped on your vehicle. Undesirable system operation or sensor damage may result when using replacement equipment that is not of the same size, type, and/or style. Aftermarket wheels can cause sensor damage.

(Continued)

CAUTION!

- Using aftermarket tire sealants may cause the Tire Pressure Monitoring System (TPMS) sensor to become inoperable. After using an aftermarket tire sealant it is recommended that you take your vehicle to an authorized dealership to have your sensor function checked.
- After inspecting or adjusting the tire pressure always reinstall the valve stem cap. This will prevent moisture and dirt from entering the valve stem, which could damage the TPMS sensor.

NOTE:

- The TPMS is not intended to replace normal tire care and maintenance or to provide warning of a tire failure or condition.
- The TPMS should not be used as a tire pressure gauge while adjusting your tire pressure, unless your vehicle is equipped with a Tire Fill Alert (TFA) system.
- Driving on a significantly underinflated tire causes the tire to overheat and can lead to tire failure. Underinflation also reduces fuel efficiency and tire tread life, and may affect the vehicle's handling and stopping ability.

308 SAFETY

- The TPMS is not a substitute for proper tire maintenance, and it is the driver's responsibility to maintain correct tire pressure using an accurate tire pressure gauge, even if underinflation has not reached the level to trigger illumination of the TPMS Warning Light.
- Seasonal temperature changes will affect tire pressure, and the TPMS will monitor the actual tire pressure in the tire.

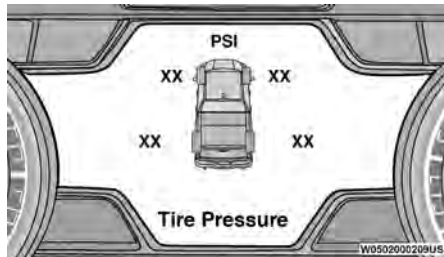

Tire Pressure Monitoring System Display

The Tire Pressure Monitoring System (TPMS) uses wireless technology with wheel rim mounted electronic sensors to monitor tire pressure levels. Sensors, mounted to each wheel as part of the valve stem, transmit tire pressure readings to the receiver module.

NOTE:

It is particularly important for you to check the tire pressure in all of the tires on your vehicle monthly and to maintain the proper pressure.

The TPMS consists of the following components:

- Receiver module
- Four Tire Pressure Monitoring System sensors
- Various Tire Pressure Monitoring System messages, which display in the instrument cluster
- Tire Pressure Monitoring System Warning Light

Tire Pressure Monitoring System Low Pressure Warnings



The Tire Pressure Monitoring System (TPMS) Warning Light will illuminate in the instrument cluster and a chime will sound when tire pressure is low in one or more of the four active road tires. In addition, the instrument cluster will display a graphic showing the pressure values of each tire with the low tire pressure values in a different color. An "Inflate to XX" message will also be displayed.

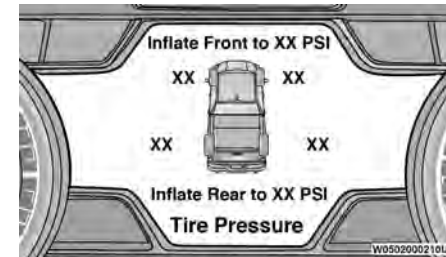

Low Tire Pressure Display

Should this occur, you should stop as soon as possible and inflate the tires with a low pressure condition (those in a different color in the instrument cluster graphic) to the vehicle's recommended cold placard pressure inflation value as shown in the "Inflate to XX" message. Once the system receives the updated tire pressures, the system will automatically update, the graphic display in the instrument cluster will return to its original color, and the Tire Pressure Monitoring System Warning Light will turn off. The vehicle may need to be driven for up to 20 minutes above 15 mph (24 km/h) in order for the TPMS to receive this information.

NOTE:

When filling warm tires, the tire pressure may need to be increased up to an additional 4 psi (28 kPa) above the recommended cold placard pressure in order to turn the Tire Pressure Monitoring System Warning Light off.

Service TPMS Warning

If a system fault is detected, the Tire Pressure Monitoring System (TPMS) Warning Light will flash on and off for 75 seconds and then remain on solid. The system fault will also sound a chime. In addition, the instrument cluster will display a "SERVICE TPM SYSTEM" message for a minimum of five seconds and then display dashes (-) in place of the pressure value to indicate which sensor is not being received.

If the ignition switch is cycled, this sequence will repeat, providing the system fault still exists. If the system fault no longer exists, the Tire Pressure Monitoring System Warning Light will no longer flash, and the "SERVICE TPM SYSTEM" message will no longer display, and a pressure value will display in place of the dashes. A system fault can occur due to any of the following:

- Signal interference due to electronic devices or driving next to facilities emitting the same radio frequencies as the Tire Pressure Monitoring System sensors

- Installing aftermarket window tinting that contains materials that may block radio wave signals
- Accumulation of snow or ice around the wheels or wheel housings
- Using tire chains on the vehicle
- Using wheels/tires not equipped with TPMS sensors

A system fault may occur due to an incorrect TPMS sensor location condition. When a system fault occurs due to an incorrect TPMS sensor location, the Tire Pressure Monitoring System (TPMS) Warning Light will flash on and off for 75 seconds and then remain on solid. The system fault will also sound a chime. In addition, the instrument cluster will display a Tire Pressure Temporarily Unavailable message in place of the tire pressure display screen. If the ignition switch is cycled, this sequence will repeat, providing the system fault still exists. If the system fault no longer exists, the "Tire Pressure Monitoring System Warning Light" will no longer flash and the tire pressure display screen will be displayed showing the tire pressure values the correct locations.

Vehicles With Non-Matching Full Size Spare Or Compact Spare

- The non-matching full size spare or compact spare tire does not have a TPMS sensor. Therefore, the TPMS will not monitor the pressure in the non-matching full size spare or compact spare tire.
- If you install the non-matching full size spare or compact spare tire in place of a road tire that has a pressure below the low-pressure warning limit, upon the next ignition switch cycle, the Tire Pressure Monitoring System (TPMS) Warning Light and a "LOW TIRE" message will remain on and a chime will sound. In addition, the graphic in the instrument cluster will still display a pressure value in a different color and an "Inflate to XX" message.
- After driving the vehicle for up to 20 minutes above 15 mph (24 km/h), the Tire Pressure Monitoring System (TPMS) Warning Light will flash on and off for 75 seconds and then remain on solid. In addition, the instrument cluster will display a "SERVICE TPM SYSTEM" message for a minimum of five seconds and then display dashes (-) in place of the pressure value.

310 SAFETY

- For each subsequent ignition switch cycle, a chime will sound, the Tire Pressure Monitoring System (TPMS) Warning Light will flash on and off for 75 seconds and then remain on solid, and the instrument cluster will display a "SERVICE TPM SYSTEM" message for a minimum of five seconds and then display dashes (-) in place of the pressure value.
- Once you repair or replace the original road tire and reinstall it on the vehicle in place of the non-matching full size spare or compact spare, the TPMS will update automatically. In addition, the Tire Pressure Monitoring System (TPMS) Warning Light will turn off and the graphic in the instrument cluster will display a new pressure value instead of dashes (-), as long as no tire pressure is below the low-pressure warning limit in any of the four active road tires. The vehicle may need to be driven for up to 20 minutes above 15 mph (24 km/h) in order for the TPMS to receive this information.

Tire Fill Alert

This feature notifies the user when the placard tire pressure is attained while inflating or deflating the tire.

You may choose to disable or enable the Tire Fill Alert feature through use of the Uconnect Settings in the radio.

NOTE:

- Only one tire can be filled at a time when using the Tire Fill Alert system.
- The Tire Fill Alert feature cannot be entered if an existing TPMS fault is set to "active" or if the system is in deactivation mode (if equipped).

The system will be activated when a positive increase in tire pressure is detected by the TPMS while inflating the tire. The ignition must be in the RUN mode, with the transmission in PARK.

NOTE:

It is not required to have the engine running to enter Tire Fill Alert mode.

The hazard lamps will come on to confirm the vehicle is in Tire Fill Alert mode.

When Tire Fill Alert mode is entered, the tire pressure display screen will be displayed in the instrument cluster.

If the hazard lamps do not come on while inflating the tire, the TPMS sensor may be out of range preventing the TPMS sensor signal from being received. In this case, the vehicle may need to be moved either forward or backward slightly to exit the null spot.

Operation:

- The horn will sound once to let the user know when to stop filling the tire, when it reaches recommended pressure.
- The horn will sound three times if the tire is over-filled and will continue to sound every five seconds if the user continues to inflate the tire.
- The horn will sound once again when enough air is let out to reach proper inflation level.
- The horn will also sound three times if the tire is then underinflated and will continue to sound every five seconds if the user continues to deflate the tire.

Trailer Tire Pressure Monitoring System (TTPMS) — If Equipped

The Trailer Tire Pressure Monitoring System (TTPMS) is a feature that displays the trailer tire pressure values and warns the driver of a low tire pressure event based on the driver's set target tire pressure value, through TTPMS settings found in the radio.

The TTPMS monitors the pressure of each tire and warns the driver through the instrument cluster, when either a low tire pressure condition falls below 25% of the driver's set pressure or if a system malfunction occurs. The instrument cluster will display the actual tire pressure or dashes for

each of the trailer tires in the correct trailer position, based on trailer configuration. The TTPMS can support up to 12 trailer tires per configured trailer on up to four configurable trailers
 ↪ page 237.

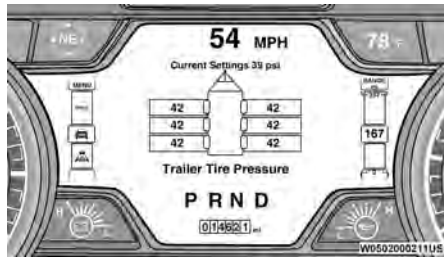

Trailer Tire Pressure Monitoring System

Trailer Tire Pressure Sensor Pairing

In order use this feature, the provided tire pressure sensors must be installed in the desired trailer tires and the sensors must be paired to the truck. If the target trailer requires more than the provided four sensors, additional Ram sensors can be purchased at an authorized Ram dealership.

With the sensors installed and the trailer near or connected to your Ram truck, initiate the pairing process by entering the settings menu in the radio and selecting trailer. Select the desired trailer profile to pair to, open the "Tire Pressure" menu, and hit "Setup All Tires" ↪ page 237.

NOTE:

The vehicle may not be driven until the pairing process is complete.



Trailer Tire Pressure Settings



Trailer Tire Pressure Pairing

Follow the on screen prompts to select the number of axles (1 - 3), the number of trailer tires (2, 4, 6, 8, or 12), and the set trailer tire pressure. The range is selectable anywhere between 25-125 psi (172-862 kPa).

Once psi (kPa) is programmed, the pairing screen appears. Tire sensors must be paired in order shown. Starting with Tire 1, deflate tire by 5 psi (34 kPa) and wait for a horn chirp. It may take up to three minutes for the chirp to occur, indicating that the sensor has paired. Repeat process on each tire, in order, until complete. Do not exit the pairing screen until process is complete. If pairing was unsuccessful, a double horn chirp will sound, and a prompt on the touchscreen will allow you to retry the procedure; "Retry" will only appear when setup fails. Each tire must be successfully paired during a single pairing process to receive the success screen.

NOTE:

If the pairing process times out after three minutes of no communication with a sensor, a double horn chirp will occur indicating the pairing has failed and a message will display on the radio indicating the process was unsuccessful. Under certain circumstances, the double horn chirp may continue to happen every three minutes indicating the failed pairing. If this happens, the horn chirping may be canceled by cycling the ignition button OFF and then back to RUN position.

312 SAFETY

Tire Pressure Monitoring System Low Pressure Warnings

When a tire pressure low in one or more of the active road tires is detected, the instrument cluster will display a message stating "Trailer Tire Pressure Low". The instrument cluster will then display the TTPMS graphic showing the pressure values of each tire with the low tire pressure values in a different color.

Should this occur, you should stop as soon as possible and inflate the tires with a low pressure condition (those in a different color in the instrument cluster graphic) to the customer programmed target tire pressure value as shown at the top of the TTPMS instrument cluster graphic. Once the tire(s) are inflated, the system will automatically update the graphic display in the instrument cluster, returning to its original color. The vehicle may need to be driven for up to 10 minutes above 15 mph (24 km/h) in order for the TTPMS to receive the updated information.

Service TTPMS Warning

If a system fault is detected, the instrument cluster will display a "Trailer Tire Pressure System Service Required" message for a minimum of five seconds.

Once the system fault is corrected the "Trailer Tire Pressure System Service Required" message will no longer be displayed. The vehicle may need to be driven for up to 10 minutes above 15 mph (24 km/h) in order for the TTPMS to receive the trailer tire pressure information.

Trailer Tire Pressure System Not Configured

A "Trailer Tire Pressure System Not Configured" message will be displayed in the instrument cluster on the TTPMS instrument cluster graphic when a trailer number is selected that has not had trailer tire pressure sensors paired. To correct this condition, see ⇨ page 237.

Trailer Sensors Detected Do Not Match Active Trailer

The "Trailer Sensors Detected Do Not Match Active Trailer" message will be displayed in the instrument cluster when the trailer sensors being received by the TTPMS module do not match the trailer sensors paired to the current trailer number selected. This message will be displayed when the sensors being received completely match the sensors paired to another trailer number configured in the TTPMS module.

To correct this condition, the correct trailer number must be selected in the radio ⇨ page 237.

OCCUPANT RESTRAINT SYSTEMS

Some of the most important safety features in your vehicle are the restraint systems:

OCCUPANT RESTRAINT SYSTEMS FEATURES

- Seat Belt Systems
- Supplemental Restraint Systems (SRS) Air Bags
- Child Restraints

Some of the safety features described in this section may be standard equipment on some models, or may be optional equipment on others. If you are not sure, ask an authorized dealer.

IMPORTANT SAFETY PRECAUTIONS

Please pay close attention to the information in this section. It tells you how to use your restraint system properly, to keep you and your passengers as safe as possible.

Here are some simple steps you can take to minimize the risk of harm from a deploying air bag:

1. Children 12 years old and under should always ride buckled up in the rear seat of a vehicle with a rear seat.
2. A child who is not big enough to wear the vehicle seat belt properly must be secured in the appropriate child restraint or belt-positioning booster seat in a rear seating position → page 331.
3. If a child from 2 to 12 years old (not in a rear-facing child restraint) must ride in the front passenger seat, move the seat as far back as possible and use the proper child restraint → page 331.
4. Never allow children to slide the shoulder belt behind them or under their arm.
5. You should read the instructions provided with your child restraint to make sure that you are using it properly.
6. All occupants should always wear their lap and shoulder belts properly.
7. The driver and front passenger seats should be moved back as far as practical to allow the front air bags room to inflate.

8. Do not lean against the door or window. If your vehicle has side air bags, and deployment occurs, the side air bags will inflate forcefully into the space between occupants and the door and occupants could be injured.
9. If the air bag system in this vehicle needs to be modified to accommodate a disabled person, see → page 455 for customer service contact information.

WARNING!

- Never place a rear-facing child restraint in front of an air bag. A deploying passenger front air bag can cause death or serious injury to a child 12 years or younger, including a child in a rear-facing child restraint.
- Never install a rear-facing child restraint in the front seat of a vehicle. Only use a rear-facing child restraint in the rear seat. If the vehicle does not have a rear seat, do not transport a rear-facing child restraint in that vehicle.

SEAT BELT SYSTEMS

Buckle up even though you are an excellent driver, even on short trips. Someone on the road may be a poor driver and could cause a collision that includes you. This can happen far away from home or on your own street.

Research has shown that seat belts save lives, and they can reduce the seriousness of injuries in a collision. Some of the worst injuries happen when people are thrown from the vehicle. Seat belts reduce the possibility of ejection and the risk of injury caused by striking the inside of the vehicle. Everyone in a motor vehicle should be belted at all times.

Enhanced Seat Belt Use Reminder System (BeltAlert)

Driver And Passenger BeltAlert — If Equipped



BeltAlert is a feature intended to remind the driver and outboard front seat passenger (if equipped with outboard front passenger seat BeltAlert) to buckle

their seat belts. The BeltAlert feature is active whenever the ignition switch is in the START or ON/RUN position.

Initial Indication

If the driver is unbuckled when the ignition switch is first in the START or ON/RUN position, a chime will signal for a few seconds. If the driver or outboard front seat passenger (if equipped with outboard front passenger seat BeltAlert) is unbuckled when the ignition switch is first in the START or ON/RUN position the Seat Belt Reminder Light will turn on and remain on until both outboard front seat belts are buckled. The outboard front passenger seat BeltAlert is not active when an outboard front passenger seat is unoccupied.

314 SAFETY

BeltAlert Warning Sequence

The BeltAlert warning sequence is activated when the vehicle is moving above a specified vehicle speed range and the driver or outboard front seat passenger is unbuckled (if equipped with outboard front passenger seat BeltAlert) (the outboard front passenger seat BeltAlert is not active when the outboard front passenger seat is unoccupied). The BeltAlert warning sequence starts by blinking the Seat Belt Reminder Light and sounding an intermittent chime. Once the BeltAlert warning sequence has completed, the Seat Belt Reminder Light will remain on until the seat belts are buckled. The BeltAlert warning sequence may repeat based on vehicle speed until the driver and occupied outboard front seat passenger seat belts are buckled. The driver should instruct all occupants to buckle their seat belts.

Change Of Status

If the driver or outboard front seat passenger (if equipped with outboard front passenger seat BeltAlert) unbuckles their seat belt while the vehicle is traveling, the BeltAlert warning sequence will begin until the seat belts are buckled again.

The outboard front passenger seat BeltAlert is not active when the outboard front passenger seat is unoccupied. BeltAlert may be triggered when an animal or other items are placed on the outboard front passenger seat or when the seat is folded flat (if equipped). It is recommended that pets be restrained in the rear seat (if equipped) in pet harnesses or pet carriers that are secured by seat belts, and cargo is properly stowed.

BeltAlert can be activated or deactivated by an authorized dealer. FCA US LLC does not recommend deactivating BeltAlert.

NOTE:

If BeltAlert has been deactivated and the driver or outboard front seat passenger (if equipped with outboard front passenger seat BeltAlert) is unbuckled the Seat Belt Reminder Light will turn on and remain on until the driver and outboard front seat passenger seat belts are buckled.

Lap/Shoulder Belts

All seating positions in your vehicle are equipped with lap/shoulder belts.

The seat belt webbing retractor will lock only during very sudden stops or collisions. This feature allows the shoulder part of the seat belt to move freely with you under normal conditions. However, in a collision the seat belt will lock and reduce your risk of striking the inside of the vehicle or being thrown out of the vehicle.

WARNING!

- Relying on the air bags alone could lead to more severe injuries in a collision. The air bags work with your seat belt to restrain you properly. In some collisions, the air bags won't deploy at all. Always wear your seat belt even though you have air bags.
- In a collision, you and your passengers can suffer much greater injuries if you are not properly buckled up. You can strike the interior of your vehicle or other passengers, or you can be thrown out of the vehicle. Always be sure you and others in your vehicle are buckled up properly.
- It is dangerous to ride in a cargo area, inside or outside of a vehicle. In a collision, people riding in these areas are more likely to be seriously injured or killed.
- Do not allow people to ride in any area of your vehicle that is not equipped with seats and seat belts.

(Continued)

WARNING!

- Be sure everyone in your vehicle is in a seat and using a seat belt properly. Occupants, including the driver, should always wear their seat belts whether or not an air bag is also provided at their seating position to minimize the risk of severe injury or death in the event of a crash.
- Wearing your seat belt incorrectly could make your injuries in a collision much worse. You might suffer internal injuries, or you could even slide out of the seat belt. Follow these instructions to wear your seat belt safely and to keep your passengers safe, too.
- Two people should never be belted into a single seat belt. People belted together can crash into one another in a collision, hurting one another badly. Never use a lap/shoulder belt or a lap belt for more than one person, no matter what their size.

WARNING!

- A lap belt worn too high can increase the risk of injury in a collision. The seat belt forces won't be at the strong hip and pelvic bones, but across your abdomen. Always wear the lap part of your seat belt as low as possible and keep it snug.
- A twisted seat belt may not protect you properly. In a collision, it could even cut into you. Be sure the seat belt is flat against your body, without twists. If you can't straighten a seat belt in your vehicle, take it to an authorized dealer immediately and have it fixed.
- A seat belt that is buckled into the wrong buckle will not protect you properly. The lap portion could ride too high on your body, possibly causing internal injuries. Always buckle your seat belt into the buckle nearest you.
- A seat belt that is too loose will not protect you properly. In a sudden stop, you could move too far forward, increasing the possibility of injury. Wear your seat belt snugly.

*(Continued)***WARNING!**

- A seat belt that is worn under your arm is dangerous. Your body could strike the inside surfaces of the vehicle in a collision, increasing head and neck injury. A seat belt worn under the arm can cause internal injuries. Ribs aren't as strong as shoulder bones. Wear the seat belt over your shoulder so that your strongest bones will take the force in a collision.
- A shoulder belt placed behind you will not protect you from injury during a collision. You are more likely to hit your head in a collision if you do not wear your shoulder belt. The lap and shoulder belt are meant to be used together.
- A frayed or torn seat belt could rip apart in a collision and leave you with no protection. Inspect the seat belt system periodically, checking for cuts, frays, or loose parts. Damaged parts must be replaced immediately. Do not disassemble or modify the seat belt system. If your vehicle is involved in a collision, or if you have questions regarding seat belt or retractor conditions, take your vehicle to an authorized FCA dealer or authorized FCA Certified Collision Care Program facility for inspection.

316 SAFETY

Lap/Shoulder Belt Operating Instructions

1. Enter the vehicle and close the door. Sit back and adjust the seat.
2. The seat belt latch plate is above the back of the front seat, and next to your arm in the rear seat (for vehicles equipped with a rear seat). Grab the latch plate and pull out the seat belt. Slide the latch plate up the webbing as far as necessary to allow the seat belt to go around your lap.



Pulling Out The Latch Plate

3. When the seat belt is long enough to fit, insert the latch plate into the buckle until you hear a "click."



Inserting Latch Plate Into Buckle

4. Position the lap belt so that it is snug and lies low across your hips, below your abdomen. To remove slack in the lap belt portion, pull up on the shoulder belt. To loosen the lap belt if it is too tight, tilt the latch plate and pull on the lap belt. A snug seat belt reduces the risk of sliding under the seat belt in a collision.



Positioning The Lap Belt

5. Position the shoulder belt across the shoulder and chest with minimal, if any slack so that it is comfortable and not resting on your neck. The retractor will withdraw any slack in the shoulder belt.
6. To release the seat belt, push the red button on the buckle. The seat belt will automatically retract to its stowed position. If necessary, slide the latch plate down the webbing to allow the seat belt to retract fully.

Lap/Shoulder Belt Untwisting Procedure

Use the following procedure to untwist a twisted lap/shoulder belt.

1. Position the latch plate as close as possible to the anchor point.
2. At about 6 to 12 inches (15 to 30 cm) above the latch plate, grab and twist the seat belt webbing 180 degrees to create a fold that begins immediately above the latch plate.
3. Slide the latch plate upward over the folded webbing. The folded webbing must enter the slot at the top of the latch plate.
4. Continue to slide the latch plate up until it clears the folded webbing and the seat belt is no longer twisted.

Adjustable Upper Shoulder Belt Anchorage

In the driver and outboard front passenger seats, the top of the shoulder belt can be adjusted upward or downward to position the seat belt away from your neck. Push or squeeze the anchorage button to release the anchorage, and move it up or down to the position that serves you best.

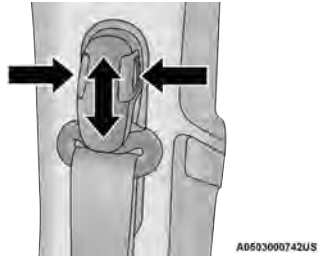

Adjustable Anchorage

As a guide, if you are shorter than average, you will prefer the shoulder belt anchorage in a lower position, and if you are taller than average, you will prefer the shoulder belt anchorage in a higher position. After you release the anchorage button, try to move it up or down to make sure that it is locked in position.

NOTE:

The adjustable upper shoulder belt anchorage is equipped with an Easy Up feature. This feature allows the shoulder belt anchorage to be adjusted in the upward position without pushing or squeezing the release button. To verify the shoulder belt anchorage is latched, pull downward on the shoulder belt anchorage until it is locked into position.

WARNING!

- Wearing your seat belt incorrectly could make your injuries in a collision much worse. You might suffer internal injuries, or you could even slide out of the seat belt. Follow these instructions to wear your seat belt safely and to keep your passengers safe, too.
- Position the shoulder belt across the shoulder and chest with minimal, if any slack so that it is comfortable and not resting on your neck. The retractor will withdraw any slack in the shoulder belt.
- Misadjustment of the seat belt could reduce the effectiveness of the safety belt in a crash.
- Always make all seat belt height adjustments when the vehicle is stationary.

Seat Belt Extender

If a seat belt is not long enough to fit properly, even when the webbing is fully extended and the adjustable upper shoulder belt anchorage (if equipped) is in its lowest position, an authorized dealer can provide you with a Seat Belt Extender. The Seat Belt Extender should be used only if the existing seat belt is not long enough. When the Seat Belt Extender is not required for a different occupant, it must be removed.

WARNING!

- ONLY use a Seat Belt Extender if it is physically required in order to properly fit the original seat belt system. DO NOT USE the Seat Belt Extender if, when worn, the distance between the front edge of the Seat Belt Extender buckle and the center of the occupant's body is LESS than 6 inches.
- Using a Seat Belt Extender when not needed can increase the risk of serious injury or death in a collision. Only use the Seat Belt Extender when the lap belt is not long enough and only use in the recommended seating positions. Remove and store the Seat Belt Extender when not needed.

318 SAFETY

Seat Belts And Pregnant Women

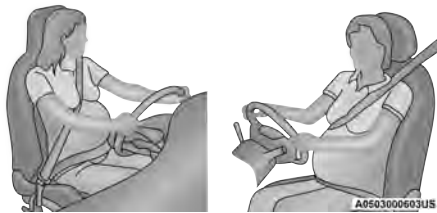

Seat Belts And Pregnant Women

Seat belts must be worn by all occupants including pregnant women: the risk of injury in the event of an accident is reduced for the mother and the unborn child if they are wearing a seat belt.

Position the lap belt snug and low below the abdomen and across the strong bones of the hips. Place the shoulder belt across the chest and away from the neck. Never place the shoulder belt behind the back or under the arm.

Seat Belt Pretensioner

The front outboard seat belt system is equipped with pretensioning devices that are designed to remove slack from the seat belt in the event of a collision. These devices may improve the

performance of the seat belt by removing slack from the seat belt early in a collision. Pretensioners work for all size occupants, including those in child restraints.

NOTE:

These devices are not a substitute for proper seat belt placement by the occupant. The seat belt still must be worn snugly and positioned properly.

The pretensioners are triggered by the Occupant Restraint Controller (ORC). Like the air bags, the pretensioners are single use items. A deployed pretensioner or a deployed air bag must be replaced immediately.

Energy Management Feature

The front outboard seat belt system is equipped with an Energy Management feature that may help further reduce the risk of injury in the event of a collision. The seat belt system has a retractor assembly that is designed to release webbing in a controlled manner.

Switchable Automatic Locking Retractors (ALR)

The seat belts in the passenger seating positions are equipped with a Switchable Automatic Locking Retractor (ALR) which is used to secure a child restraint system ↪ page 340. The figure below illustrates the locking feature for each seating position.

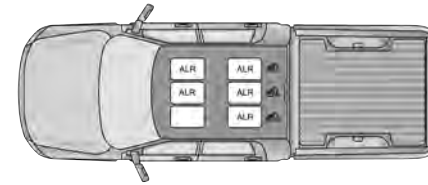

Automatic Locking Retractor – (ALR) Locations
(All Models)

If the passenger seating position is equipped with an ALR and is being used for normal usage, only pull the seat belt webbing out far enough to comfortably wrap around the occupant's mid-section so as to not activate the ALR. If the ALR is activated, you will hear a clicking sound as the seat belt retracts. Allow the webbing to retract completely in this case and then carefully pull out only the amount of webbing necessary to comfortably wrap around the occupant's mid-section. Slide the latch plate into the buckle until you hear a "click."

In Automatic Locking Mode, the shoulder belt is automatically pre-locked. The seat belt will still retract to remove any slack in the shoulder belt. Use the Automatic Locking Mode anytime a child restraint is installed in a seating position that has a seat belt with this feature. Children 12 years old and under should always be properly restrained in the rear seat of a vehicle with a rear seat.

WARNING!

- Never place a rear-facing child restraint in front of an air bag. A deploying passenger front air bag can cause death or serious injury to a child 12 years or younger, including a child in a rear-facing child restraint.
- Never install a rear-facing child restraint in the front seat of a vehicle. Only use a rear-facing child restraint in the rear seat. If the vehicle does not have a rear seat, do not transport a rear-facing child restraint in that vehicle.

How To Engage The Automatic Locking Mode

1. Buckle the combination lap and shoulder belt.
2. Grab the shoulder portion and pull downward until the entire seat belt is extracted.

3. Allow the seat belt to retract. As the seat belt retracts, you will hear a clicking sound. This indicates the seat belt is now in the Automatic Locking Mode.

How To Disengage The Automatic Locking Mode

Unbuckle the combination lap/shoulder belt and allow it to retract completely to disengage the Automatic Locking Mode and activate the vehicle sensitive (emergency) locking mode.

WARNING!

- The seat belt assembly must be replaced if the switchable Automatic Locking Retractor (ALR) feature or any other seat belt function is not working properly when checked according to the procedures in the Service Manual.
- Failure to replace the seat belt assembly could increase the risk of injury in collisions.
- Do not use the Automatic Locking Mode to restrain occupants who are wearing the seat belt or children who are using booster seats. The locked mode is only used to install rear-facing or forward-facing child restraints that have a harness for restraining the child.

SUPPLEMENTAL RESTRAINT SYSTEMS (SRS)

Some of the safety features described in this section may be standard equipment on some models, or may be optional equipment on others. If you are not sure, ask an authorized dealer.

The air bag system must be ready to protect you in a collision. The Occupant Restraint Controller (ORC) monitors the internal circuits and interconnecting wiring associated with the electrical Air Bag System Components. Your vehicle may be equipped with the following Air Bag System Components:

Air Bag System Components

- Occupant Restraint Controller (ORC)
- Air Bag Warning Light 
- Steering Wheel and Column
- Instrument Panel
- Knee Impact Bolsters
- Driver and Front Passenger Air Bags
- Seat Belt Buckle Switch
- Supplemental Side Air Bags

320 SAFETY

- Front and Side Impact Sensors
- Seat Belt Pretensioners
- Seat Track Position Sensors
- Occupant Classification System

Air Bag Warning Light

The Occupant Restraint Controller (ORC) monitors the readiness of the electronic parts of the air bag system whenever the ignition switch is in the START or ON/RUN position. If the ignition switch is in the OFF position or in the ACC position, the air bag system is not on and the air bags will not inflate.

The ORC contains a backup power supply system that may deploy the air bag system even if the battery loses power or it becomes disconnected prior to deployment.

The ORC turns on the Air Bag Warning Light in the instrument panel for approximately four to eight seconds for a self-check when the ignition switch is first in the ON/RUN position. After the self-check, the Air Bag Warning Light will turn off. If the ORC detects a malfunction in any part of the system, it turns on the Air Bag Warning Light, either momentarily or continuously. A single chime will sound to alert you if the light comes on again after initial startup.

The ORC also includes diagnostics that will illuminate the instrument panel Air Bag Warning Light if a malfunction is detected that could affect the air bag system. The diagnostics also record the nature of the malfunction. While the air bag system is designed to be maintenance free, if any of the following occurs, have an authorized dealer service the air bag system immediately.

- The Air Bag Warning Light does not come on during the four to eight seconds when the ignition switch is first in the ON/RUN position.
- The Air Bag Warning Light remains on after the four to eight-second interval.
- The Air Bag Warning Light comes on intermittently or remains on while driving.

NOTE:

If the speedometer, tachometer, or any engine related gauges are not working, the Occupant Restraint Controller (ORC) may also be disabled. In this condition the air bags may not be ready to inflate for your protection. Have an authorized dealer service the air bag system immediately.

WARNING!

Ignoring the Air Bag Warning Light in your instrument panel could mean you won't have the air bag system to protect you in a collision. If the light does not come on as a bulb check when the ignition is first turned on, stays on after you start the vehicle, or if it comes on as you drive, have an authorized dealer service the air bag system immediately.

Redundant Air Bag Warning Light

If a fault with the Air Bag Warning Light is detected, which could affect the Supplemental Restraint System (SRS), the Redundant Air Bag Warning Light will illuminate on the instrument panel. The Redundant Air Bag Warning Light will stay on until the fault is cleared. In addition, a single chime will sound to alert you that the Redundant Air Bag Warning Light has come on and a fault has been detected. If the Redundant Air Bag Warning Light comes on intermittently or remains on while driving have an authorized dealer service the vehicle immediately → page 130.

Front Air Bags

This vehicle has front air bags and lap/shoulder belts for both the driver and front passenger. The front air bags are a supplement to the seat belt restraint systems. The driver front air bag is mounted in the center of the steering wheel. The passenger front air bag is mounted in the instrument panel, above the glove compartment. The words "SRS AIRBAG" or "AIRBAG" are embossed on the air bag covers.

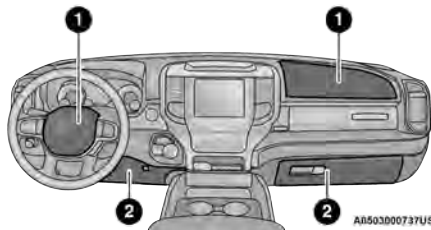

Front Air Bag/Knee Bolster Locations

- 1 – Driver And Passenger Front Air Bags
2 – Driver And Passenger Knee Impact Bolsters

WARNING!

- Being too close to the steering wheel or instrument panel during front air bag deployment could cause serious injury, including death. Air bags need room to inflate. Sit back, comfortably extending your arms to reach the steering wheel or instrument panel.
- Never place a rear-facing child restraint in front of an air bag. A deploying passenger front air bag can cause death or serious injury to a child 12 years or younger, including a child in a rear-facing child restraint.
- Never install a rear-facing child restraint in the front seat of a vehicle. Only use a rear-facing child restraint in the rear seat. If the vehicle does not have a rear seat, do not transport a rear-facing child restraint in that vehicle.

Driver And Passenger Front Air Bag Features

The Advanced Front Air Bag system has multistage driver and front passenger air bags. This system provides output appropriate to the severity and type of collision as determined by the Occupant Restraint Controller (ORC), which may receive information from the front impact sensors (if equipped) or other system components.

The first stage inflator is triggered immediately during an impact that requires air bag deployment. A low energy output is used in less severe collisions. A higher energy output is used for more severe collisions.

This vehicle may be equipped with a driver and/or front passenger seat belt buckle switch that detects whether the driver or front passenger seat belt is buckled. The seat belt buckle switch may adjust the inflation rate of the Advanced Front Air Bags.

This vehicle may be equipped with driver and/or front passenger seat track position sensors that may adjust the inflation rate of the Advanced Front Air Bags based upon seat position.

322 SAFETY

This vehicle is equipped with a right front passenger Occupant Classification System (“OCS”) that is designed to provide Passenger Advanced Front Air Bag output appropriate to the occupant’s seated weight input, as determined by the OCS.

WARNING!

- No objects should be placed over or near the air bag on the instrument panel or steering wheel because any such objects could cause harm if the vehicle is in a collision severe enough to cause the air bag to inflate.
- Do not put anything on or around the air bag covers or attempt to open them manually. You may damage the air bags and you could be injured because the air bags may no longer be functional. The protective covers for the air bag cushions are designed to open only when the air bags are inflating.
- Relying on the air bags alone could lead to more severe injuries in a collision. The air bags work with your seat belt to restrain you properly. In some collisions, air bags won’t deploy at all. Always wear your seat belts even though you have air bags.

Front Air Bag Operation

Front Air Bags are designed to provide additional protection by supplementing the seat belts. Front air bags are not expected to reduce the risk of injury in rear, side, or rollover collisions. The front air bags will not deploy in all frontal collisions, including some that may produce substantial vehicle damage — for example, some pole collisions, truck underrides, and angle offset collisions.

On the other hand, depending on the type and location of impact, front air bags may deploy in crashes with little vehicle front-end damage but that produce a severe initial deceleration.

Because air bag sensors measure vehicle deceleration over time, vehicle speed and damage by themselves are not good indicators of whether or not an air bag should have deployed.

Seat belts are necessary for your protection in all collisions, and also are needed to help keep you in position, away from an inflating air bag.

When the Occupant Restraint Controller (ORC) detects a collision requiring the front air bags, it signals the inflator units. A large quantity of non-toxic gas is generated to inflate the front air bags.

The steering wheel hub trim cover and the upper passenger side of the instrument panel separate and fold out of the way as the air bags inflate to their full size. The front air bags fully inflate in less time than it takes to blink your eyes. The front air bags then quickly deflate while helping to restrain the driver and front passenger.

Occupant Classification System (OCS) — Front Passenger Seat

The Occupant Classification System (OCS) is part of a Federally regulated safety system for this vehicle. It is designed to provide Passenger Advanced Front Air Bag output appropriate to the occupant’s seated weight, as determined by the OCS.

The Occupant Classification System (OCS) consists of the following:

- Occupant Restraint Controller (ORC)
- Occupant Classification Module (OCM) and Sensor located in the front passenger seat
- Air Bag Warning Light 

Occupant Classification Module (OCM) And Sensor

The Occupant Classification Module (OCM) is located underneath the front passenger seat. The Sensor is located beneath the passenger seat cushion foam. Any weight on the seat will be sensed by the Sensor. The OCM uses input from the Sensor to determine the front passenger's most probable classification. The OCM communicates this information to the ORC. The ORC may reduce the inflation rate of the Passenger Advanced Front Air Bag deployment based on occupant classification. In order for the OCS to operate as designed, it is important for the front passenger to be seated properly and properly wearing the seat belt.

The OCS will NOT prevent deployment of the Passenger Advanced Front Air Bag. The OCS may reduce the inflation rate of the Passenger Advanced Front Air Bag if the OCS estimates that:

- The front passenger seat is unoccupied or has very light objects on it; or
- The front passenger seat is occupied by a small passenger, including a child; or
- The front passenger seat is occupied by a rear-facing child restraint; or
- The front passenger is not properly seated or his or her weight is taken off of the seat for a period of time.

| Front Passenger Seat Occupant Status | Front Passenger Air Bag Output |
|---|---|
| Rear-facing child restraint | Reduced-power deployment |
| Child, including a child in a forward-facing child restraint or booster seat* | Reduced-power deployment OR full-power deployment |
| Properly seated adult | Full-power deployment OR reduced-power deployment |
| Unoccupied seat | Reduced-power deployment |

* It is possible for a child to be classified as an adult, allowing a full-power Passenger Advanced Front Air Bag deployment. Never allow children to ride in the front passenger seat and never install a child restraint system, including a rear-facing child restraint, in the front passenger seat.

| WARNING! |
|---|
| <ul style="list-style-type: none"> ● Never place a rear-facing child restraint in front of an air bag. A deploying passenger front air bag can cause death or serious injury to a child 12 years or younger, including a child in a rear-facing child restraint. |

(Continued)

| WARNING! |
|--|
| <ul style="list-style-type: none"> ● Never install a rear-facing child restraint in the front seat of a vehicle. Only use a rear-facing child restraint in the rear seat. If the vehicle does not have a rear seat, do not transport a rear-facing child restraint in that vehicle. ● Children 12 years or younger should always ride buckled up in the rear seat of a vehicle with a rear seat. |

The OCS determines the front passenger's most probable classification. The OCS estimates the seated weight on the front passenger seat and where that weight is located. The OCS communicates the classification status to the ORC. The ORC uses the classification to determine whether the Passenger Advanced Front Air Bag inflation rate should be adjusted.

In order for the OCS to operate as designed, it is important for the front passenger to be seated properly and properly wearing the seat belt. Properly seated passengers are:

- Sitting upright
- Facing forward
- Sitting in the center of the seat with their feet comfortably on or near the floor
- Sitting with their back against the seatback and the seatback in an upright position

324 SAFETY

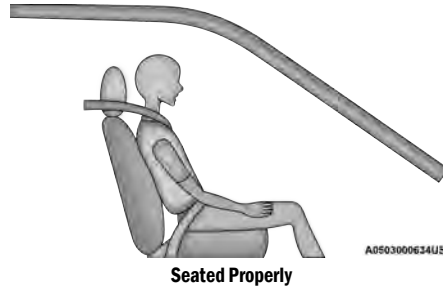

Lighter Weight Passengers (Including Small Adults)

When a lighter weight passenger, including a small adult, occupies the front passenger seat, the OCS may reduce the inflation rate of the Passenger Advanced Front Air Bag. This does not mean that the OCS is working improperly.

Do not decrease OR increase the front passenger's seated weight on the front passenger seat

The front passenger's seated weight must be properly positioned on the front passenger seat. Failure to do so may result in serious injury or death. The OCS determines the most probable classification of the occupant that it detects. The OCS will detect the front passenger's decreased or increased seated weight, which may result in an adjusted inflation rate of the Passenger Advanced Front Air Bag in a collision. This does not mean that the OCS is working improperly. Decreasing the

front passenger's seated weight on the front passenger seat may result in a reduced-power deployment of the Passenger Advanced Front Air Bag. Increasing the front passenger's seated weight on the front passenger seat may result in a full-power deployment of the Passenger Advanced Front Air Bag.

Examples of improper front passenger seating include:

- The front passenger's weight is transferred to another part of the vehicle (like the door, arm rest or instrument panel).
- The front passenger leans forward, sideways, or turns to face the rear of the vehicle.
- The front passenger's seatback is not in the full upright position.
- The front passenger carries or holds an object while seated (e.g., backpack, box, etc.).
- Objects are lodged under the front passenger seat.
- Objects are lodged between the front passenger seat and center console.
- Accessories that may change the seated weight on the front passenger seat are attached to the front passenger seat.
- Anything that may decrease or increase the front passenger's seated weight.

The OCS determines the front passenger's most probable classification. If an occupant in the front passenger seat is seated improperly, the occupant may provide an output signal to the OCS that is different from the occupant's properly seated weight input, for example:

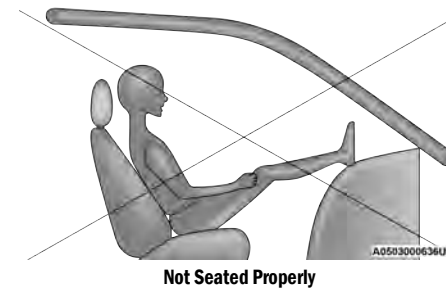
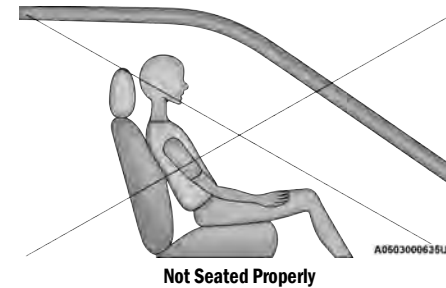

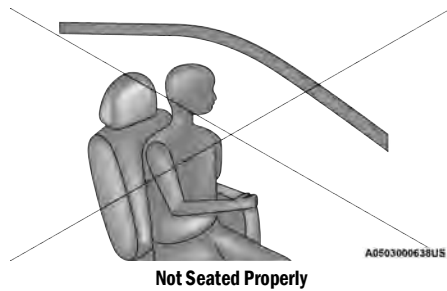
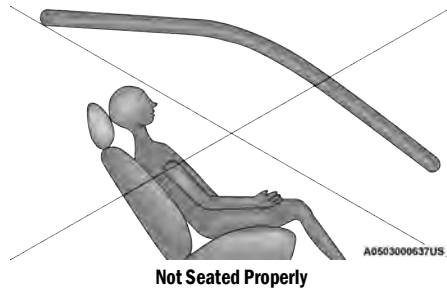

WARNING!

- If a child restraint system, child, small teenager or adult in the front passenger seat is seated improperly, the occupant may provide an output signal to the OCS that is different from the occupant's properly seated weight input. This may result in serious injury or death in a collision.
- Always wear your seat belt and sit properly, with the seatback in an upright position, your back against the seatback, sitting upright, facing forward, in the center of the seat, with your feet comfortably on or near the floor.
- Do not carry or hold any objects (e.g., backpacks, boxes, etc.) while seated in the front passenger seat. Holding an object may provide an output signal to the OCS that is different than the occupant's properly seated weight input, which may result in serious injury or death in a collision.
- Placing an object on the floor under the front passenger seat may prevent the OCS from working properly, which may result in serious injury or death in a collision. Do not place any objects on the floor under the front passenger seat.

The Air Bag Warning Light  in the instrument panel will turn on whenever the OCS is unable to classify the front passenger seat status. A malfunction in the OCS may affect the operation of the air bag system.

If the Air Bag Warning Light  does not come on, or stays on after you start the vehicle, or it comes on as you drive, take the vehicle to an authorized dealer for service immediately.

The passenger seat assembly contains critical OCS components that may affect the Passenger Advanced Front Air Bag inflation. In order for the OCS to properly classify the seated weight of a front seat passenger, the OCS components must function as designed. Do not make any modifications to the front passenger seat components, assembly, or to the seat cover. If the seat, trim cover, or cushion needs service for any reason, take the vehicle to an authorized dealer. Only FCA US LLC approved seat accessories may be used.

The following requirements must be strictly followed:

- Do not modify the front passenger seat assembly or components in any way.
- Do not use prior or future model year seat covers or cushions not designated by FCA US LLC for the specific model being repaired.

326 SAFETY

Always use the correct seat cover and cushion specified for the vehicle.

- Do not replace the seat cover or cushion with an aftermarket seat cover or cushion.
- Do not add a secondary seat cover or mat.
- At no time should any Supplemental Restraint System (SRS) component or SRS related component or fastener be modified or replaced with any part except those which are approved by FCA US LLC.

WARNING!

- Unapproved modifications or service procedures to the passenger seat assembly, its related components, seat cover or cushion may inadvertently change the air bag deployment in case of a frontal collision. This could result in death or serious injury to the front passenger if the vehicle is involved in a collision. A modified vehicle may not comply with required Federal Motor Vehicle Safety Standards (FMVSS) and/or Canadian Motor Vehicle Safety Standards (CMVSS).
- If it is necessary to modify the air bag system for persons with disabilities, contact an authorized dealer.

Knee Impact Bolsters

The Knee Impact Bolsters help protect the knees of the driver and front passenger, and position the front occupants for improved interaction with the front air bags.

WARNING!

- Do not drill, cut, or tamper with the knee impact bolsters in any way.
- Do not mount any accessories to the knee impact bolsters such as alarm lights, stereos, citizen band radios, etc.

Supplemental Side Air Bags

Supplemental Seat-Mounted Side Air Bags (SABs)

This vehicle is equipped with Supplemental Seat-Mounted Side Air Bags (SABs). Supplemental Seat-Mounted Side Air Bags (SABs) are located in the outboard side of the front seats. The SABs are marked with "SRS AIRBAG" or "AIRBAG" on a label or on the seat trim on the outboard side of the seats.

The SABs may help to reduce the risk of occupant injury during certain side impacts, in addition to the injury reduction potential provided by the seat belts and body structure.

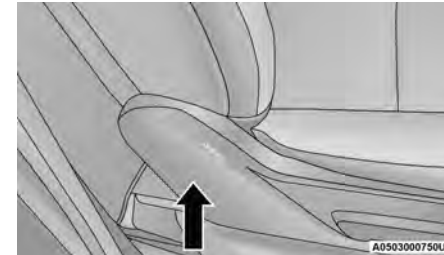

Supplemental Seat-Mounted Side Air Bag Label

When the SAB deploys, it opens the seam on the outboard side of the seatback's trim cover. The inflating SAB deploys through the seat seam into the space between the occupant and the door. The SAB moves at a very high speed and with such a high force that it could injure occupants if they are not seated properly, or if items are positioned in the area where the SAB inflates. Children are at an even greater risk of injury from a deploying air bag.

WARNING!

Do not use accessory seat covers or place objects between you and the Side Air Bags; the performance could be adversely affected and/or objects could be pushed into you, causing serious injury.

Supplemental Side Air Bag Inflatable Curtains (SABICs)

This vehicle is equipped with Supplemental Side Air Bag Inflatable Curtains (SABICs).

Supplemental Side Air Bag Inflatable Curtains (SABICs) are located above the side windows. The trim covering the SABICs is labeled “SRS AIRBAG” or “AIRBAG.”

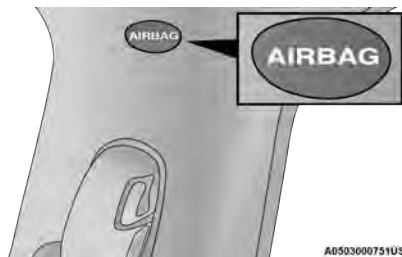

Supplemental Side Air Bag Inflatable Curtain (SABIC) Label Location

SABICs may help reduce the risk of head and other injuries to front and rear seat outboard occupants in certain side impacts, in addition to the injury reduction potential provided by the seat belts and body structure.

The SABIC deploys downward, covering the side windows. An inflating SABIC pushes the outside edge of the headliner out of the way and covers the window. The SABICs inflate with enough force to injure occupants if they are not belted and seated properly, or if items are positioned in the area where the SABICs inflate. Children are at an even greater risk of injury from a deploying air bag.

The SABICs may help reduce the risk of partial or complete ejection of vehicle occupants through side windows in certain side impact events.

WARNING!

- Do not mount equipment, or stack luggage or other cargo up high enough to block the deployment of the SABICs. The trim covering above the side windows where the SABIC and its deployment path are located should remain free from any obstructions.
- In order for the SABICs to work as intended, do not install any accessory items in your vehicle which could alter the roof. Do not add an after-market sunroof to your vehicle. Do not add roof racks that require permanent attachments (bolts or screws) for installation on the vehicle roof. Do not drill into the roof of the vehicle for any reason.

Side Impacts

The Side Air Bags are designed to activate in certain side impacts. The Occupant Restraint Controller (ORC) determines whether the deployment of the Side Air Bags in a particular impact event is appropriate, based on the severity and type of collision. The side impact sensors aid the ORC in determining the appropriate response to impact events. The system is calibrated to deploy the Side Air Bags on the impact side of the vehicle during impacts that require Side Air Bag occupant protection. In side impacts, the Side Air Bags deploy independently; a left side impact deploys the left Side Air Bags only and a right-side impact deploys the right Side Air Bags only. Vehicle damage by itself is not a good indicator of whether or not Side Air Bags should have deployed.

The Side Air Bags will not deploy in all side collisions, including some collisions at certain angles, or some side collisions that do not impact the area of the passenger compartment. The Side Air Bags may deploy during angled or offset frontal collisions where the front air bags deploy.

Side Air Bags are a supplement to the seat belt restraint system. Side Air Bags deploy in less time than it takes to blink your eyes.

328 SAFETY

| WARNING! |
|--|
| <ul style="list-style-type: none"> ● Occupants, including children, who are up against or very close to Side Air Bags can be seriously injured or killed. Occupants, including children, should never lean on or sleep against the door, side windows, or area where the side air bags inflate, even if they are in an infant or child restraint. ● Seat belts (and child restraints where appropriate) are necessary for your protection in all collisions. They also help keep you in position, away from an inflating Side Air Bag. To get the best protection from the Side Air Bags, occupants must wear their seat belts properly and sit upright with their backs against the seats. Children must be properly restrained in a child restraint or booster seat that is appropriate for the size of the child. |

| WARNING! |
|--|
| <ul style="list-style-type: none"> ● Side Air Bags need room to inflate. Do not lean against the door or window. Sit upright in the center of the seat. ● Being too close to the Side Air Bags during deployment could cause you to be severely injured or killed. |

(Continued)

| WARNING! |
|--|
| <ul style="list-style-type: none"> ● Relying on the Side Air Bags alone could lead to more severe injuries in a collision. The Side Air Bags work with your seat belt to restrain you properly. In some collisions, Side Air Bags won't deploy at all. Always wear your seat belt even though you have Side Air Bags. |

NOTE:

Air bag covers may not be obvious in the interior trim, but they will open during air bag deployment.

Rollover Events

Side Air Bags and seat belt pretensioners are designed to activate in certain rollover events. The Occupant Restraint Controller (ORC) determines whether deployment in a particular rollover event is appropriate, based on the severity and type of collision. Vehicle damage by itself is not a good indicator of whether or not Side Air Bags and seat belt pretensioners should have deployed.

The Side Air Bags and seat belt pretensioners will not deploy in all rollover events. The rollover sensing system determines if a rollover event may be in progress and whether deployment is appropriate. In the event the vehicle experiences a rollover or near rollover event, and deployment is appropriate, the rollover sensing system will deploy the side air bags and seat belt pretensioners on both sides of the vehicle.

The SABICs may help reduce the risk of partial or complete ejection of vehicle occupants through side windows in certain rollover or side impact events.

Air Bag System Components

NOTE:

The Occupant Restraint Controller (ORC) monitors the internal circuits and interconnecting wiring associated with electrical Air Bag System Components listed below:

- Occupant Restraint Controller (ORC)
- Air Bag Warning Light 
- Steering Wheel and Column
- Instrument Panel
- Knee Impact Bolsters
- Driver and Front Passenger Air Bags
- Seat Belt Buckle Switch
- Supplemental Side Air Bags
- Front and Side Impact Sensors
- Seat Belt Pretensioners
- Seat Track Position Sensors
- Occupant Classification System

If A Deployment Occurs

The front air bags are designed to deflate immediately after deployment.

NOTE:

Front and/or side air bags will not deploy in all collisions. This does not mean something is wrong with the air bag system.

If you do have a collision which deploys the air bags, any or all of the following may occur:

- The air bag material may sometimes cause abrasions and/or skin reddening to the occupants as the air bags deploy and unfold. The abrasions are similar to friction rope burns or those you might get sliding along a carpet or gymnasium floor. They are not caused by contact with chemicals. They are not permanent and normally heal quickly. However, if you haven't healed significantly within a few days, or if you have any blistering, see your doctor immediately.
- As the air bags deflate, you may see some smoke-like particles. The particles are a normal by-product of the process that generates the non-toxic gas used for air bag inflation. These airborne particles may irritate the skin, eyes, nose, or throat. If you have skin or eye irritation, rinse the area with cool water. For nose or throat irritation, move to fresh air. If the irritation continues, see your doctor. If these particles settle on your clothing, follow the garment manufacturer's instructions for cleaning.

Do not drive your vehicle after the air bags have deployed. If you are involved in another collision, the air bags will not be in place to protect you.

WARNING!

Deployed air bags and seat belt pretensioners cannot protect you in another collision. Have the air bags, seat belt pretensioners, and the seat belt retractor assemblies replaced by an authorized dealer immediately. Also, have the Occupant Restraint Controller System serviced as well.

NOTE:

- Air bag covers may not be obvious in the interior trim, but they will open during air bag deployment.
- After any collision, the vehicle should be taken to an authorized dealer immediately.

Enhanced Accident Response System

In the event of an impact, if the communication network remains intact, and the power remains intact, depending on the nature of the event, the Occupant Restraint Controller (ORC) will determine whether to have the Enhanced Accident Response System perform the following functions:

- Cut off fuel to the engine (if equipped)
- Cut off battery power to the electric motor (if equipped)
- Flash hazard lights as long as the battery has power

- Turn on the interior lights, which remain on as long as the battery has power or for 15 minutes from the intervention of the Enhanced Accident Response System

- Unlock the power door locks

Your vehicle may also be designed to perform any of these other functions in response to the Enhanced Accident Response System:

- Turn off the Fuel Filter Heater, Turn off the HVAC Blower Motor, Close the HVAC Circulation Door
- Cut off battery power to the:
 - Engine
 - Electric Motor (if equipped)
 - Electric power steering
 - Brake booster
 - Electric park brake
 - Automatic transmission gear selector
 - Horn
 - Front wiper
 - Headlamp washer pump (if equipped)

330 SAFETY**NOTE:**

After an accident, remember to cycle the ignition to the STOP (OFF/LOCK) position and remove the key from the ignition switch to avoid draining the battery. Carefully check the vehicle for fuel leaks in the engine compartment and on the ground near the engine compartment and fuel tank before resetting the system and starting the engine. If there are no fuel leaks or damage to the vehicle electrical devices (e.g. headlights) after an accident, reset the system by following the procedure described below. If you have any doubt, contact an authorized dealer.

Enhanced Accident Response System Reset Procedure

In order to reset the Enhanced Accident Response System functions after an event, the ignition switch must be changed from ignition START or ON/RUN to ignition OFF. Carefully check the vehicle for fuel leaks in the engine compartment and on the ground near the engine compartment and fuel tank before resetting the system and starting the engine. After an accident, if the vehicle will not start after performing the reset procedure, the vehicle must be towed to an authorized dealer to be inspected and to have the Enhanced Accident Response System reset.

Maintaining Your Air Bag System**WARNING!**

- Modifications to any part of the air bag system could cause it to fail when you need it. You could be injured if the air bag system is not there to protect you. Do not modify the components or wiring, including adding any kind of badges or stickers to the steering wheel hub trim cover or the upper passenger side of the instrument panel. Do not modify the front fascia/bumper, vehicle body structure, or add aftermarket side steps or running boards.
- It is dangerous to try to repair any part of the air bag system yourself. Be sure to tell anyone who works on your vehicle that it has an air bag system.
- Do not attempt to modify any part of your air bag system. The air bag may inflate accidentally or may not function properly if modifications are made. Take your vehicle to an authorized dealer for any air bag system service. If your seat, including your trim cover and cushion, needs to be serviced in any way (including removal or loosening/tightening of seat attachment bolts), take the vehicle to an authorized dealer. Only manufacturer approved seat accessories may be used. If it is necessary to modify the air bag system for persons with disabilities, contact an authorized dealer.

Event Data Recorder (EDR)

This vehicle is equipped with an event data recorder (EDR). The main purpose of an EDR is to record, in certain crash or near crash-like situations, such as an air bag deployment or hitting a road obstacle, data that will assist in understanding how a vehicle's systems performed. The EDR is designed to record data related to vehicle dynamics and safety systems for a short period of time, typically 30 seconds or less. The EDR in this vehicle is designed to record such data as:

- How various systems in your vehicle were operating;
- Whether or not the driver and passenger safety belts were buckled/fastened;
- How far (if at all) the driver was depressing the accelerator and/or brake pedal; and,
- How fast the vehicle was traveling.

These data can help provide a better understanding of the circumstances in which crashes and injuries occur.

NOTE:

EDR data are recorded by your vehicle only if a non-trivial crash situation occurs; no data are recorded by the EDR under normal driving conditions and no personal data (e.g., name, gender, age, and crash location) are recorded. However, other parties, such as law enforcement, could combine the EDR data with the type of personally identifying data routinely acquired during a crash investigation.

To read data recorded by an EDR, special equipment is required, and access to the vehicle or the EDR is needed. In addition to the vehicle manufacturer, other parties, such as law enforcement, that have the special equipment, can read the information if they have access to the vehicle or the EDR.

CHILD RESTRAINTS

Everyone in your vehicle needs to be buckled up at all times, including babies and children. Every state in the United States, and every Canadian province, requires that small children ride in proper restraint systems. This is the law, and you can be prosecuted for ignoring it.

Children 12 years or younger should ride properly buckled up in a rear seat, if available. According to crash statistics, children are safer when properly restrained in the rear seats rather than in the front.

WARNING!

In a collision, an unrestrained child can become a projectile inside the vehicle. The force required to hold even an infant on your lap could become so great that you could not hold the child, no matter how strong you are. The child and others could be badly injured or killed. Any child riding in your vehicle should be in a proper restraint for the child's size.

There are different sizes and types of restraints for children from newborn size to the child almost large enough for an adult safety belt. Always check the child seat Owner's Manual to make sure you have the correct seat for your child. Carefully read and follow all the instructions and warnings in the child restraint Owner's Manual and on all the labels attached to the child restraint.

Before buying any restraint system, make sure that it has a label certifying that it meets all applicable Safety Standards. You should also make sure that you can install it in the vehicle where you will use it.

NOTE:

- For additional information, refer to <http://www.nhtsa.gov/parents-and-caregivers> or call: 1-888-327-4236
- Canadian residents should refer to Transport Canada's website for additional information: <https://www.tc.gc.ca/en/services/road/child-car-seat-safety.html>

332 SAFETY**Summary Of Recommendations For Restraining Children In Vehicles**

| | Child Size, Height, Weight Or Age | Recommended Type Of Child Restraint |
|---|--|--|
| Infants and Toddlers | Children who are two years old or younger and who have not reached the height or weight limits of their child restraint | Either an Infant Carrier or a Convertible Child Restraint, facing rearward in a rear seat of the vehicle |
| Small Children | Children who are at least two years old or who have outgrown the height or weight limit of their rear-facing child restraint | Forward-Facing Child Restraint with a five-point Harness, facing forward in a rear seat of the vehicle |
| Larger Children | Children who have outgrown their forward-facing child restraint, but are too small to properly fit the vehicle's seat belt | Belt Positioning Booster Seat and the vehicle seat belt, seated in a rear seat of the vehicle |
| Children Too Large for Child Restraints | Children 12 years old or younger, who have outgrown the height or weight limit of their booster seat | Vehicle Seat Belt, seated in a rear seat of the vehicle |

Infant And Child Restraints

Safety experts recommend that children ride rear-facing in the vehicle until they are two years old or until they reach either the height or weight limit of their rear-facing child restraint. Two types of child restraints can be used rear-facing: infant carriers and convertible child seats.

The infant carrier is only used rear-facing in the vehicle. It is recommended for children from birth until they reach the weight or height limit of the infant carrier. Convertible child seats can be used either rear-facing or forward-facing in the vehicle. Convertible child seats often have a higher weight limit in the rear-facing direction than infant carriers do, so they can be used rear-facing by children who have outgrown their infant carrier but are still less than at least two years old. Children should remain rear-facing until they reach the highest weight or height allowed by their convertible child seat.

WARNING!

- Never place a rear-facing child restraint in front of an air bag. A deploying passenger front air bag can cause death or serious injury to a child 12 years or younger, including a child in a rear-facing child restraint.
- Never install a rear-facing child restraint in the front seat of a vehicle. Only use a rear-facing child restraint in the rear seat. If the vehicle does not have a rear seat, do not transport a rear-facing child restraint in that vehicle.

WARNING!

Do not install a rear-facing car seat using a rear support leg in this vehicle. The floor of this vehicle is not designed to manage the crash forces of this type of car seat. In a crash, the support leg may not function as it was designed by the car seat manufacturer, and your child may be more severely injured as a result.

(Continued)

WARNING!



6

Older Children And Child Restraints

Children who are two years old or who have outgrown their rear-facing convertible child seat can ride forward-facing in the vehicle.

Forward-facing child seats and convertible child seats used in the forward-facing direction are for children who are over two years old or who have outgrown the rear-facing weight or height limit of their rear-facing convertible child seat. Children should remain in a forward-facing child seat with a

334 SAFETY

harness for as long as possible, up to the highest weight or height allowed by the child seat.

All children whose weight or height is above the forward-facing limit for the child seat should use a belt-positioning booster seat until the vehicle's seat belts fit properly. If the child cannot sit with knees bent over the vehicle's seat cushion while the child's back is against the seatback, they should use a belt-positioning booster seat. The child and belt-positioning booster seat are held in the vehicle by the seat belt.

| WARNING! |
|--|
| <ul style="list-style-type: none"> ● Improper installation can lead to failure of an infant or child restraint. It could come loose in a collision. The child could be badly injured or killed. Follow the child restraint manufacturer's directions exactly when installing an infant or child restraint. ● After a child restraint is installed in the vehicle, do not move the vehicle seat forward or rearward because it can loosen the child restraint attachments. Remove the child restraint before adjusting the vehicle seat position. When the vehicle seat has been adjusted, reinstall the child restraint. |

(Continued)

| WARNING! |
|--|
| <ul style="list-style-type: none"> ● When your child restraint is not in use, secure it in the vehicle with the seat belt or LATCH anchorages, or remove it from the vehicle. Do not leave it loose in the vehicle. In a sudden stop or accident, it could strike the occupants or seatbacks and cause serious personal injury. |

Children Too Large For Booster Seats

Children who are large enough to wear the shoulder belt comfortably, and whose legs are long enough to bend over the front of the seat when their back is against the seatback, should use the seat belt in a rear seat. Use this simple 5-step test to decide whether the child can use the vehicle's seat belt alone:

1. Can the child sit all the way back against the back of the vehicle seat?
2. Do the child's knees bend comfortably over the front of the vehicle seat while the child is still sitting all the way back?
3. Does the shoulder belt cross the child's shoulder between the neck and arm?

4. Is the lap part of the belt as low as possible, touching the child's thighs and not the stomach?
5. Can the child stay seated like this for the whole trip?

If the answer to any of these questions was "no," then the child still needs to use a booster seat in this vehicle. If the child is using the lap/shoulder belt, check seat belt fit periodically and make sure the seat belt buckle is latched. A child's squirming or slouching can move the belt out of position. If the shoulder belt contacts the face or neck, move the child closer to the center of the vehicle, or use a booster seat to position the seat belt on the child correctly.

| WARNING! |
|--|
| <p>Never allow a child to put the shoulder belt under an arm or behind their back. In a crash, the shoulder belt will not protect a child properly, which may result in serious injury or death. A child must always wear both the lap and shoulder portions of the seat belt correctly.</p> |

Recommendations For Attaching Child Restraints

| Restraint Type | Combined Weight of the Child + Child Restraint | Use Any Attachment Method Shown With An "X" Below | | | |
|--------------------------------|--|---|----------------|---|-------------------------------|
| | | LATCH – Lower Anchors Only | Seat Belt Only | LATCH – Lower Anchors + Top Tether Anchor | Seat Belt + Top Tether Anchor |
| Rear-Facing Child Restraint | Up to 65 lbs (29.5 kg) | X | X | | |
| Rear-Facing Child Restraint | More than 65 lbs (29.5 kg) | | X | | |
| Forward-Facing Child Restraint | Up to 65 lbs (29.5 kg) | | | X | X |
| Forward-Facing Child Restraint | More than 65 lbs (29.5 kg) | | | | X |

336 SAFETY

Lower Anchors And Tethers For Children (LATCH) Restraint System





LATCH Label

Your vehicle is equipped with the child restraint anchorage system called LATCH, which stands for Lower Anchors and Tethers for Children. The LATCH system has three vehicle anchor points for installing LATCH-equipped child seats. There are two lower anchorages located at the back of the seat cushion where it meets the seatback and one top tether anchorage located behind the seating position. These anchorages are used to install LATCH-equipped child seats without using the vehicle's seat belts. Some seating positions may have a top tether anchorage but no lower anchorages. In these seating positions, the seat belt must be used with the top tether anchorage to install the child restraint. Please see the following table for more information.

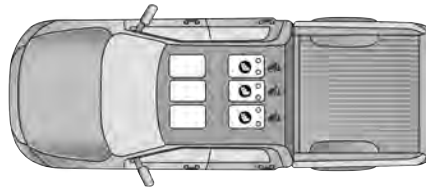
LATCH Positions For Installing Child Restraints In This Vehicle



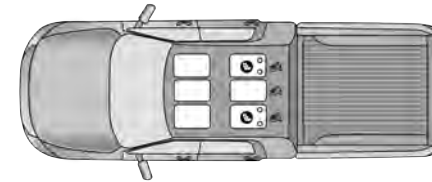

Crew Cab 60/40 Split Bench LATCH Positions

-  Top Tether Anchorage Symbol
-  Lower Anchorage Symbol (2 Anchorages Per Seating Position)



Crew Cab Full Bench, Quad Cab Full Bench And 60/40 Split Bench LATCH Positions

-  Top Tether Anchorage Symbol
-  Lower Anchorage Symbol (2 Anchorages Per Seating Position)

| Frequently Asked Questions About Installing Child Restraints With LATCH | | |
|---|------------------|---|
| What is the weight limit (child's weight + weight of the child restraint) for using the LATCH anchorage system to attach the child restraint? | 65 lbs (29.5 kg) | Use the LATCH anchorage system until the combined weight of the child and the child restraint is 65 lbs (29.5 kg). Use the seat belt and tether anchor instead of the LATCH system once the combined weight is more than 65 lbs (29.5 kg). |
| Can the LATCH anchorages and the seat belt be used together to attach a rear-facing or forward-facing child restraint? | No | Do not use the seat belt when you use the LATCH anchorage system to attach a rear-facing or forward-facing child restraint. Booster seats may be attached to the LATCH anchorages if allowed by the booster seat manufacturer. See your booster seat owner's manual for more information. |
| Can a child seat be installed in the center position using the inner LATCH lower anchorages from the outboard seating positions? | No | Quad Cab or Crew with Full bench rear seat: Use the seat belt and tether anchor to install a child seat in the center seating position |
| Can two child restraints be attached using a common lower LATCH anchorage? | No | Never "share" a LATCH anchorage with two or more child restraints. If the center position does not have dedicated LATCH lower anchorages, use the seat belt to install a child seat in the center position next to a child seat using the LATCH anchorages in an outboard position. |
| Can the rear-facing child restraint touch the back of the front passenger seat? | Yes | The child seat may touch the back of the front passenger seat if the child restraint manufacturer also allows contact. See your child restraint owner's manual for more information. |
| Can the rear head restraints be removed? | No | |

338 SAFETY

Locating The LATCH Anchorages



The lower anchorages are round bars that are found at the rear of the seat cushion where it meets the seatback, below the anchorage symbols on the seatback. They are just visible when you lean into the rear seat to install the child restraint. You will easily feel them if you run your finger along the gap between the seatback and seat cushion.

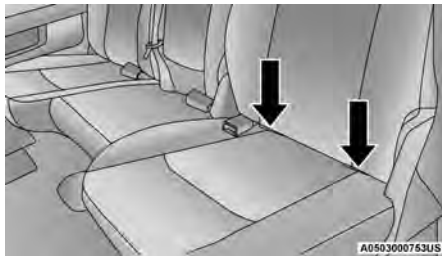

Rear Outboard Seats Driver Side (Example Shown)

Locating The Upper Tether Anchorages



There are tether strap anchorages located behind each of the rear seats.

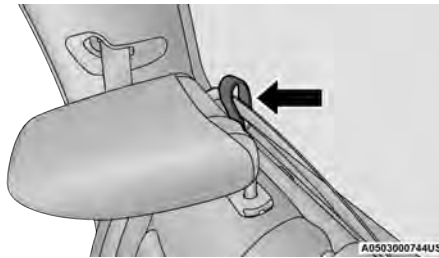

Outboard Tether Anchorage

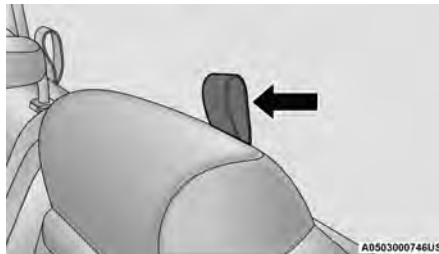

Center Tether Anchorage Over Head Rest

LATCH-compatible child restraint systems will be equipped with a rigid bar or a flexible strap on each side. Each will have a hook or connector to attach to the lower anchorage and a way to tighten the connection to the anchorage. Forward-facing child restraints and some rear-facing child restraints will also be equipped with a tether strap. The tether strap will have a hook at the end to attach to the top tether anchorage and a way to tighten the strap after it is attached to the anchorage.

Center Seat LATCH

**All Quad Cabs Or Crew Cab Full Bench Rear Seat:
No Lower Center LATCH Anchorages Available**

WARNING!

- Do not install a child restraint in the center position using the LATCH system. This position is not approved for installing child seats using the LATCH attachments. You must use the seat belt and tether anchor to install a child seat in the center seating position.
- Never use the same lower anchorage to attach more than one child restraint
➤ page 339.

Crew Cab Split Bench Rear Seat: Center LATCH Anchorages Available

If a child restraint installed in the center position blocks the seat belt webbing or buckle for the outboard position, do not use that outboard position. If a child seat in the center position blocks the outboard LATCH anchors or seat belt, do not install a child seat in that outboard position.

WARNING!

Never use the same lower anchorage to attach more than one child restraint → page 339.

Always follow the directions of the child restraint manufacturer when installing your child restraint. Not all child restraint systems will be installed as described here.

To Install A LATCH-Compatible Child Restraint

If the selected seating position has a Switchable Automatic Locking Retractor (ALR) seat belt, stow the seat belt, following the instructions below. See → page 340 to check what type of seat belt each seating position has.

1. Loosen the adjusters on the lower straps and on the tether strap of the child seat so that you can more easily attach the hooks or connectors to the vehicle anchorages.
2. Place the child seat between the lower anchorages for that seating position. If the second row seat can be reclined, you may recline the seat and/or raise the head restraint (if adjustable) to get a better fit. If the rear seat can be moved forward and rearward in the vehicle, you may wish to move it to its rear-most position to make room for the child seat. You may also move the front seat forward to allow more room for the child seat.
3. Attach the lower hooks or connectors of the child restraint to the lower anchorages in the selected seating position.
4. If the child restraint has a tether strap, connect it to the top tether anchorage. See → page 342 for directions to attach a tether anchor.
5. Tighten all of the straps as you push the child restraint rearward and downward into the seat. Remove slack in the straps according to the child restraint manufacturer's instructions.
6. Test that the child restraint is installed tightly by pulling back and forth on the child seat at the belt path. It should not move more than 1 inch (25.4 mm) in any direction.

How To Stow An Unused Switchable-ALR (ALR) Seat Belt:

When using the LATCH attaching system to install a child restraint, stow all ALR seat belts that are not being used by other occupants or being used to secure child restraints. An unused belt could injure a child if they play with it and accidentally lock the seat belt retractor. Before installing a child restraint using the LATCH system, buckle the seat belt behind the child restraint and out of the child's reach. If the buckled seat belt interferes with the child restraint installation, instead of buckling it behind the child restraint, route the seat belt through the child restraint belt path and then buckle it. Do not lock the seat belt. Remind all children in the vehicle that the seat belts are not toys and that they should not play with them.

340 SAFETY

| WARNING! |
|--|
| <ul style="list-style-type: none"> ● Improper installation of a child restraint to the LATCH anchorages can lead to failure of the restraint. The child could be badly injured or killed. Follow the child restraint manufacturer's directions exactly when installing an infant or child restraint. ● Child restraint anchorages are designed to withstand only those loads imposed by correctly-fitted child restraints. Under no circumstances are they to be used for adult seat belts, harnesses, or for attaching other items or equipment to the vehicle. |

Installing Child Restraints Using The Vehicle Seat Belt

Child restraint systems are designed to be secured in vehicle seats by lap belts or the lap belt portion of a lap/shoulder belt.

| WARNING! |
|---|
| <ul style="list-style-type: none"> ● Improper installation or failure to properly secure a child restraint can lead to failure of the restraint. The child could be badly injured or killed. ● Follow the child restraint manufacturer's directions exactly when installing an infant or child restraint. |

The seat belts in the passenger seating positions are equipped with a Switchable Automatic Locking Retractor (ALR) that is designed to keep the lap portion of the seat belt tight around the child restraint so that it is not necessary to use a locking clip. The ALR retractor can be "switched" into a locked mode by pulling all of the webbing out of the retractor and then letting the webbing retract back into the retractor. If it is locked, the ALR will make a clicking noise while the webbing is pulled back into the retractor.

See the "Automatic Locking Mode" description ↗ page 318 for additional information on ALR.

Please see the table below and the following sections for more information.

Lap/Shoulder Belt Systems For Installing Child Restraints In This Vehicle

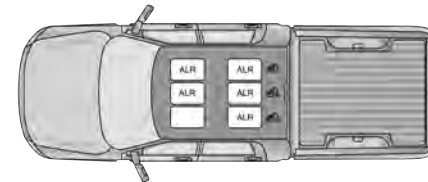

A0503000749US

**Automatic Locking Retractor – (ALR) Locations
(All Models)**

ALR – Switchable Automatic Locking Retractor
 Top Tether Anchorage Symbol

| Frequently Asked Questions About Installing Child Restraints With Seat Belts | | |
|--|-------------------------------------|---|
| What is the weight limit (child's weight + weight of the child restraint) for using the Tether Anchor with the seat belt to attach a forward facing child restraint? | Weight limit of the Child Restraint | Always use the tether anchor when using the seat belt to install a forward facing child restraint, up to the recommended weight limit of the child restraint. |
| Can the rear-facing child restraint touch the back of the front passenger seat? | Yes | Contact between the front passenger seat and the child restraint is allowed, if the child restraint manufacturer also allows contact. |
| Can the rear head restraints be removed? | No | Head restraints may not be removed. |
| Can the buckle stalk be twisted to tighten the seat belt against the belt path of the child restraint? | No | Do not twist the buckle stalk in a seating position with an ALR retractor. |

342 SAFETY**Installing A Child Restraint With A Switchable Automatic Locking Retractor (ALR):**

Child restraint systems are designed to be secured in vehicle seats by lap belts or the lap belt portion of a lap/shoulder belt.

WARNING!

- Improper installation or failure to properly secure a child restraint can lead to failure of the restraint. The child could be badly injured or killed.
- Follow the child restraint manufacturer's directions exactly when installing an infant or child restraint.

1. Place the child seat in the center of the seating position. If the second row seat can be reclined, you may recline the seat and/or raise the head restraint (if adjustable) to get a better fit. If the rear seat can be moved forward and rearward in the vehicle, you may wish to move it to its rear-most position to make room for the child seat. You may also move the front seat forward to allow more room for the child seat.

2. Pull enough of the seat belt webbing from the retractor to pass it through the belt path of the child restraint. Do not twist the belt webbing in the belt path.
3. Slide the latch plate into the buckle until you hear a "click."
4. Pull on the webbing to make the lap portion tight against the child seat.
5. To lock the seat belt, pull down on the shoulder part of the belt until you have pulled all the seat belt webbing out of the retractor. Then, allow the webbing to retract back into the retractor. As the webbing retracts, you will hear a clicking sound. This means the seat belt is now in the Automatic Locking mode.
6. Try to pull the webbing out of the retractor. If it is locked, you should not be able to pull out any webbing. If the retractor is not locked, repeat step 5.
7. Finally, pull up on any excess webbing to tighten the lap portion around the child restraint while you push the child restraint rearward and downward into the vehicle seat.
8. If the child restraint has a top tether strap and the seating position has a top tether anchorage, connect the tether strap to the anchorage and tighten the tether strap
 ⇨ page 342.

9. Test that the child restraint is installed tightly by pulling back and forth on the child seat at the belt path. It should not move more than 1 inch (25.4 mm) in any direction.

Any seat belt system will loosen with time, so check the belt occasionally, and pull it tight if necessary.

Installing Child Restraints Using The Top Tether Anchorage**WARNING!**

Do not attach a tether strap for a rear-facing car seat to any location in front of the car seat, including the seat frame or a tether anchorage. Only attach the tether strap of a rear-facing car seat to the tether anchorage that is approved for that seating position, located behind the top of the vehicle seat. For the location of approved tether anchorages in your vehicle, see
 ⇨ page 336.



WARNING!

Never place a rear-facing child restraint in front of an air bag. A deploying Passenger Front Air Bag can cause death or serious injury to a child 12 years or younger, including a child in a rear-facing child restraint.



The top tether anchorages in this vehicle are tether strap loops located between the rear glass and the back of the rear seat. There is a tether strap loop located behind each seating position. Follow the steps below to attach the tether strap of the child restraint.

Right Or Left Outboard Seats:

1. Reach between the rear seat and rear glass to access the tether strap loop.
2. Place a child restraint on the seat and adjust the tether strap so that it will reach over the seat back, through the space between the head restraint and the seat back, through the tether strap loop behind the seat and over to the tether strap loop behind the center seat.
3. Pass the tether strap hook through the space between the head restraint and the seat back behind the child seat, through the tether strap loop behind the seat and over to the center tether strap loop.

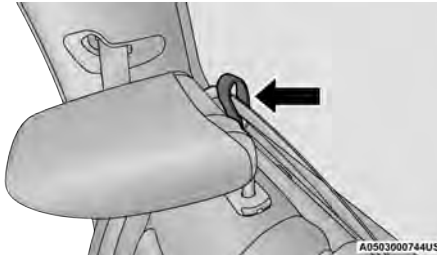

Tether Strap Through Outboard Tether Strap Loop

4. Attach the hook to the center tether strap loop (see diagram). Tighten the tether strap according to the child seat manufacturer's instructions.



Tether Strap Through Outboard Tether Strap Loop And Attached To Center Tether Strap Loop

NOTE:

If there are child seats in both of the outboard (left and right) seating positions, the tether strap hooks of both child seats should be connected to the center tether strap loop. This is the correct way to tether two outboard child seats.

Center Seat:

1. Reach between the rear seat and rear glass to access the tether strap loop.

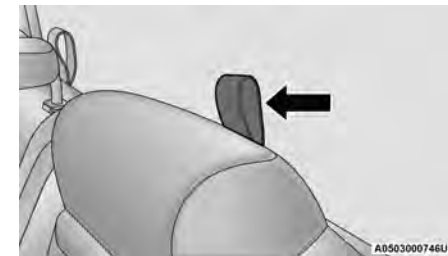

Center Tether Strap Loop Location

2. Place a child restraint on the seat and adjust the tether strap so that it will reach over the seat back and headrest, through the tether strap loop behind the seat and over to the tether strap loop behind either the right or left outboard seat.

344 SAFETY

3. Pass the tether strap hook over the headrest behind the child seat, through the tether strap loop behind the seat and over to the right or left outboard tether strap loop.

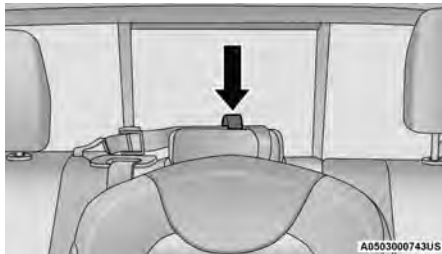

Tether Strap Through Center Tether Strap Loop

4. Attach the hook to the outboard tether strap loop (see diagram). Tighten the tether strap according to the child seat manufacturer's instructions.

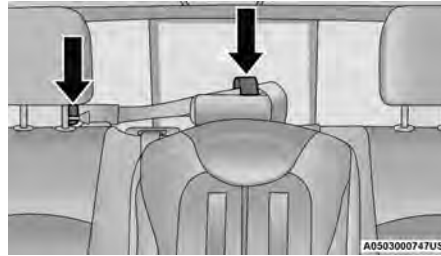

Tether Strap Through Center Tether Strap Loop And Attached To Outboard Tether Strap Loop

Installing Three Child Restraints:

1. Place a child restraint on each outboard rear seat. Route the tether straps following the directions for right and left seating positions, above.
2. Attach both hooks to the center tether strap loop, but do not tighten the straps yet.
3. Place a child restraint on the center rear seat. Route the tether strap following the directions for the center seating position, above.
4. Attach the hook to the outboard tether strap loop.

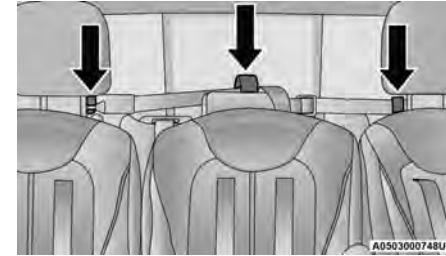

Outboard And Center Seating Positions Shown

5. Tighten the tether straps according to the child seat manufacturer's instructions, tightening the right and left tether straps before the center tether strap.

WARNING!

- An incorrectly anchored tether strap could lead to increased head motion and possible injury to the child. Use only the anchorage position directly behind the child seat to secure a child restraint top tether strap.
- If your vehicle is equipped with a split rear seat, make sure the tether strap does not slip into the opening between the seatbacks as you remove slack in the strap.

SAFETY TIPS

TRANSPORTING PASSENGERS

NEVER TRANSPORT PASSENGERS IN THE CARGO AREA.

WARNING!

- Do not leave children or animals inside parked vehicles in hot weather. Interior heat build-up may cause serious injury or death.
- It is extremely dangerous to ride in a cargo area, inside or outside of a vehicle. In a collision, people riding in these areas are more likely to be seriously injured or killed.
- Do not allow people to ride in any area of your vehicle that is not equipped with seats and seat belts.
- Be sure everyone in your vehicle is in a seat and using a seat belt properly.

TRANSPORTING PETS

Air Bags deploying in the front seat could harm your pet. An unrestrained pet will be thrown about and possibly injured, or injure a passenger during panic braking or in a collision.

Pets should be restrained in the rear seat (if equipped) in pet harnesses or pet carriers that are secured by seat belts.

SAFETY CHECKS YOU SHOULD MAKE INSIDE THE VEHICLE

Seat Belts

Inspect the seat belt system periodically, checking for cuts, frays, and loose parts. Damaged parts must be replaced immediately. Do not disassemble or modify the system.

If your vehicle is involved in a collision, or if you have questions regarding the seat belt or retractor conditions, take your vehicle to an authorized FCA dealer or authorized FCA Certified Collision Care Program facility for inspection.

Air Bag Warning Light



The Air Bag Warning Light will turn on for four to eight seconds as a bulb check when the ignition switch is first placed in the ON/RUN position. If the light is either not on during starting, stays on, or turns on while driving, have the system inspected at an authorized dealer as soon as possible. After the bulb check, this light will illuminate with a single chime when a fault with the Air Bag System has been detected. It will stay on until the fault is removed. If the light comes on intermittently or remains on while driving, have an authorized dealer service the vehicle immediately.

See ⇨ page 312 for further information.

Defroster

Check operation by selecting the defrost mode and place the blower control on high speed. You should be able to feel the air directed against the windshield. See an authorized dealer for service if your defroster is inoperable.

346 SAFETY

Floor Mat Safety Information

Always use floor mats designed to fit your vehicle. Only use a floor mat that does not interfere with the operation of the accelerator, brake or clutch pedals. Only use a floor mat that is securely attached using the floor mat fasteners so it cannot slip out of position and interfere with the accelerator, brake or clutch pedals or impair safe operation of your vehicle in other ways.

| WARNING! | |
|--|--|
| <p>An improperly attached, damaged, folded, or stacked floor mat, or damaged floor mat fasteners may cause your floor mat to interfere with the accelerator, brake, or clutch pedals and cause a loss of vehicle control. To prevent SERIOUS INJURY or DEATH:</p> | |
|  | <ul style="list-style-type: none"> ● ALWAYS securely attach your floor mat using the floor mat fasteners. DO NOT install your floor mat upside down or turn your floor mat over. Lightly pull to confirm mat is secured using the floor mat fasteners on a regular basis. |

(Continued)

| WARNING! | |
|--|--|
|  | <ul style="list-style-type: none"> ● ALWAYS REMOVE THE EXISTING FLOOR MAT FROM THE VEHICLE before installing any other floor mat. NEVER install or stack an additional floor mat on top of an existing floor mat. |
| <ul style="list-style-type: none"> ● ONLY install floor mats designed to fit your vehicle. NEVER install a floor mat that cannot be properly attached and secured to your vehicle. If a floor mat needs to be replaced, only use a FCA approved floor mat for the specific make, model, and year of your vehicle. ● ONLY use the driver's side floor mat on the driver's side floor area. To check for interference, with the vehicle properly parked with the engine off, fully depress the accelerator, the brake, and the clutch pedal (if present) to check for interference. If your floor mat interferes with the operation of any pedal, or is not secure to the floor, remove the floor mat from the vehicle and place the floor mat in your trunk. ● ONLY use the passenger's side floor mat on the passenger's side floor area. | |

(Continued)

| WARNING! | |
|--|--|
| <ul style="list-style-type: none"> ● ALWAYS make sure objects cannot fall or slide into the driver's side floor area when the vehicle is moving. Objects can become trapped under accelerator, brake, or clutch pedals and could cause a loss of vehicle control. ● NEVER place any objects under the floor mat (e.g., towels, keys, etc.). These objects could change the position of the floor mat and may cause interference with the accelerator, brake, or clutch pedals. ● If the vehicle carpet has been removed and re-installed, always properly attach carpet to the floor and check the floor mat fasteners are secure to the vehicle carpet. Fully depress each pedal to check for interference with the accelerator, brake, or clutch pedals then re-install the floor mats. ● It is recommended to only use mild soap and water to clean your floor mats. After cleaning, always check your floor mat has been properly installed and is secured to your vehicle using the floor mat fasteners by lightly pulling mat. | |

PERIODIC SAFETY CHECKS YOU SHOULD MAKE OUTSIDE THE VEHICLE

Tires

Examine tires for excessive tread wear and uneven wear patterns. Check for stones, nails, glass, or other objects lodged in the tread or sidewall. Inspect the tread for cuts and cracks. Inspect sidewalls for cuts, cracks, and bulges. Check the lug nut/bolt torque for tightness. Check the tires (including spare) for proper cold inflation pressure.

Lights

Have someone observe the operation of brake lights and exterior lights while you work the controls. Check turn signal and high beam indicator lights on the instrument panel.

Door Latches

Check for proper closing, latching, and locking.

Fluid Leaks

Check area under the vehicle after overnight parking for fuel, coolant, oil, or other fluid leaks. Also, if gasoline fumes are detected or if fuel or brake fluid leaks are suspected, the cause should be located and corrected immediately.

EXHAUST GAS

WARNING!

Exhaust gases can injure or kill. They contain carbon monoxide (CO), which is colorless and odorless. Breathing it can make you unconscious and can eventually poison you. To avoid breathing (CO), follow these safety tips:

- Do not run the engine in a closed garage or in confined areas any longer than needed to move your vehicle in or out of the area.
- If you are required to drive with the trunk/lift-gate/rear doors open, make sure that all windows are closed and the climate control BLOWER switch is set at high speed. DO NOT use the recirculation mode.
- If it is necessary to sit in a parked vehicle with the engine running, adjust your heating or cooling controls to force outside air into the vehicle. Set the blower at high speed.

The best protection against carbon monoxide entry into the vehicle body is a properly maintained engine exhaust system.

Whenever a change is noticed in the sound of the exhaust system, when exhaust fumes can be detected inside the vehicle, or when the underside or rear of the vehicle is damaged, have an authorized

dealer inspect the complete exhaust system and adjacent body areas for broken, damaged, deteriorated, or mispositioned parts. Open seams or loose connections could permit exhaust fumes to seep into the passenger compartment. In addition, inspect the exhaust system each time the vehicle is raised for lubrication or oil change. Replace as required.

CARBON MONOXIDE WARNINGS

WARNING!

Carbon monoxide (CO) in exhaust gases is deadly. Follow the precautions below to prevent carbon monoxide poisoning:

- Do not inhale exhaust gases. They contain carbon monoxide, a colorless and odorless gas, which can kill. Never run the engine in a closed area, such as a garage, and never sit in a parked vehicle with the engine running for an extended period. If the vehicle is stopped in an open area with the engine running for more than a short period, adjust the ventilation system to force fresh, outside air into the vehicle.
- Guard against carbon monoxide with proper maintenance. Have the exhaust system inspected every time the vehicle is raised. Have any abnormal conditions repaired promptly. Until repaired, drive with all side windows fully open.

IN CASE OF EMERGENCY

HAZARD WARNING FLASHERS

The Hazard Warning Flashers button is located on the upper switch bank just below the radio.

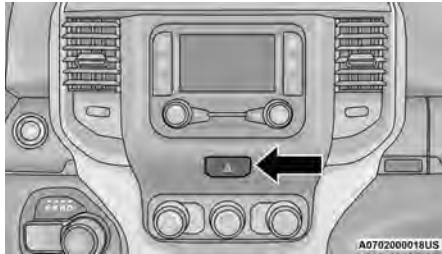

Hazard Warning Flashers Button

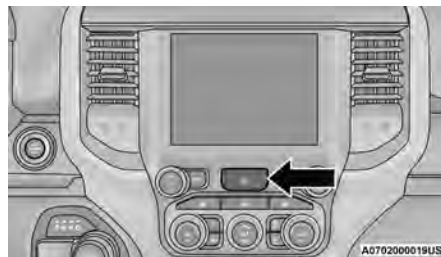

Hazard Warning Flashers Button

NOTE:

If your vehicle is equipped with a 12-inch Uconnect display, the Hazard Warning Flashers button is located above the display.

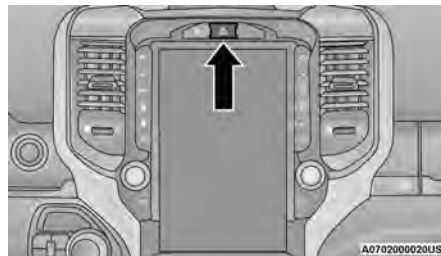

Hazard Warning Flashers Button with 12-inch display

Push the button to turn on the Hazard Warning Flashers. When the button is activated, all directional turn signals will flash on and off to warn oncoming traffic of an emergency. Push the button a second time to turn off the Hazard Warning Flashers.

This is an emergency warning system and it should not be used when the vehicle is in motion. Use it when your vehicle is disabled and it is creating a safety hazard for other motorists.

When leaving the vehicle to seek assistance, the Hazard Warning Flashers will continue to operate even though the ignition is placed in the OFF position.

NOTE:

With extended use the Hazard Warning Flashers may wear down your battery.

ASSIST AND SOS SYSTEM — IF EQUIPPED

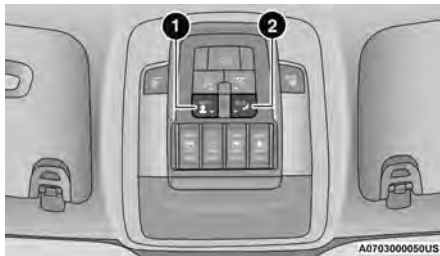

Assist And SOS Buttons

- 1 — ASSIST Button
2 — SOS Button

If equipped, the overhead console contains an ASSIST and a SOS button.

WARNING!

ALWAYS obey traffic laws and pay attention to the road. ALWAYS drive safely with your hands on the steering wheel. You have full responsibility and assume all risks related to the use of the features and applications in this vehicle. Only use the features and applications when it is safe to do so. Failure to do so may result in an accident involving serious injury or death.

NOTE:

- Your vehicle may be transmitting data as authorized by the subscriber → page 458.
- The ASSIST and SOS buttons will only function if you are connected to an operable LTE (voice/data) or 4G (data) network, which comes as a built in function. Other Uconnect services will only be operable if your SiriusXM Guardian™ service is active and connected to an operable LTE (voice/data) or 4G (data) network.

ASSIST Call

The ASSIST Button is used to automatically connect you to any one of the following support centers:

- Roadside Assistance – If you get a flat tire, or need a tow, just push the ASSIST button and you'll be connected to someone who can help. Roadside Assistance will know what vehicle you're driving and its location. Additional fees may apply for roadside assistance.
- SiriusXM Guardian™ Customer Care – In-vehicle support for SiriusXM Guardian™.
- Vehicle Customer Care – Total support for all other vehicle issues.
- Uconnect Customer Care - Total support for Radio, Phone and NAV issues.

SOS Call

1. Push the SOS Call button on the overhead console.

NOTE:

In case the SOS Call button is pushed in error, there will be a ten second delay before the SOS Call system initiates a call to a SOS operator. To cancel the SOS Call connection, push the SOS call button on the overhead console or press the cancellation button on the Device Screen. Termination of the SOS Call will turn off the green LED light on the overhead console.

2. The LED lights located within the ASSIST and SOS buttons on the overhead console will turn green once a connection to a SOS operator has been made.
3. Once a connection between the vehicle and a SOS operator is made, the SOS Call system may transmit the following important vehicle information to a SOS operator:
 - Indication that the occupant placed a SOS Call
 - The vehicle brand
 - The last known GPS coordinates of the vehicle

350 IN CASE OF EMERGENCY

4. You should be able to speak with the SOS operator through the vehicle audio system to determine if additional help is needed.

WARNING!

ALWAYS obey traffic laws and pay attention to the road. ALWAYS drive safely with your hands on the steering wheel. You have full responsibility and assume all risks related to the use of the features and applications in this vehicle. Only use the features and applications when it is safe to do so. Failure to do so may result in an accident involving serious injury or death.

NOTE:

- Your vehicle may be transmitting data as authorized by the subscriber.
- Once a connection is made between the vehicle's SOS Call system and the SOS operator, the SOS operator may be able to open a voice connection with the vehicle to determine if additional help is needed. Once the SOS operator opens a voice connection with the vehicle's SOS Call system, the operator should be able to speak with you or other vehicle occupants and hear sounds occurring in the vehicle. The vehicle's SOS Call system will attempt to remain connected with the SOS operator until the SOS operator terminates the connection.

5. The SOS operator may attempt to contact appropriate emergency responders and provide them with important vehicle information and GPS coordinates.

WARNING!

- If anyone in the vehicle could be in danger (e.g., fire or smoke is visible, dangerous road conditions or location), do not wait for voice contact from an Emergency Services Agent. All occupants should exit the vehicle immediately and move to a safe location.
- Never place anything on or near the vehicle's operable network and GPS antennas. You could prevent operable network and GPS signal reception, which can prevent your vehicle from placing an emergency call. An operable network and GPS signal reception is required for the SOS Call system to function properly.

(Continued)

WARNING!

- The SOS Call system is embedded into the vehicle's electrical system. Do not add aftermarket electrical equipment to the vehicle's electrical system. This may prevent your vehicle from sending a signal to initiate an emergency call. To avoid interference that can cause the SOS Call system to fail, never add aftermarket equipment (e.g., two-way mobile radio, CB radio, data recorder, etc.) to your vehicle's electrical system or modify the antennas on your vehicle. IF YOUR VEHICLE LOSES BATTERY POWER FOR ANY REASON (INCLUDING DURING OR AFTER AN ACCIDENT), THE UCONNECT FEATURES, APPS AND SERVICES, AMONG OTHERS, WILL NOT OPERATE.
- Modifications to any part of the SOS Call system could cause the air bag system to fail when you need it. You could be injured if the air bag system is not there to help protect you.

SOS Call System Limitations

Vehicles sold in Mexico **DO NOT** have SOS Call system capabilities.

SOS or other emergency line operators in Mexico may not answer or respond to SOS system calls.

If the SOS Call system detects a malfunction, any of the following may occur at the time the malfunction is detected, and at the beginning of each ignition cycle:

- The overhead console lights located within the ASSIST and SOS buttons will continuously illuminate red.
- The Device Screen will display the following message: "Vehicle device requires service. Please contact an authorized dealer."
- An In-Vehicle Audio message will state "Vehicle device requires service. Please contact an authorized dealer."

WARNING!

- Ignoring the overhead console light could mean you will not have SOS Call services. If the overhead console light is illuminated, have an authorized dealer service the SOS Call system immediately.

(Continued)

WARNING!

- The Occupant Restraint Control module turns on the air bag Warning Light on the instrument panel if a malfunction in any part of the system is detected. If the Air Bag Warning Light is illuminated, have an authorized dealer service the Occupant Restraint Control system immediately.

Even if the SOS Call system is fully functional, factors beyond FCA US LLC's control may prevent or stop the SOS Call system operation. These include, but are not limited to, the following factors:

- The ignition is in the OFF position
- The vehicle's electrical systems are not intact
- The SOS Call system software and/or hardware are damaged during a crash
- The vehicle battery loses power or becomes disconnected during a vehicle crash
- LTE (voice/data) or 4G (data) network and/or Global Positioning Satellite signals are unavailable or obstructed
- Equipment malfunction at the SOS operator facility
- Operator error by the SOS operator

- LTE (voice/data) or 4G (data) network congestion
- Weather
- Buildings, structures, geographic terrain, or tunnels

WARNING!

ALWAYS obey traffic laws and pay attention to the road. ALWAYS drive safely with your hands on the steering wheel. You have full responsibility and assume all risks related to the use of the features and applications in this vehicle. Only use the features and applications when it is safe to do so. Failure to do so may result in an accident involving serious injury or death.

NOTE:

- Your vehicle may be transmitting data as authorized by the subscriber.
- Never place anything on or near the vehicle's LTE (voice/data) or 4G (data) and GPS antennas. You could prevent LTE (voice/data) or 4G (data) and GPS signal reception, which can prevent your vehicle from placing an emergency call. An operable LTE (voice/data) or 4G (data) network connection and a GPS signal is required for the SOS Call system to function properly.

352 IN CASE OF EMERGENCY

NOTE:

Changes or modifications not expressly approved by the party responsible for compliance could void the user's authority to operate the equipment.

Automatic SOS — If Equipped

Automatic SOS is a hands-free safety service that can immediately connect you with help in the event that your vehicle's airbags deploy. Please refer to your provided radio supplement for complete information.

JACKING AND TIRE CHANGING

WARNING!

- Do not attempt to change a tire on the side of the vehicle close to moving traffic. Pull far enough off the road to avoid the danger of being hit when operating the jack or changing the wheel.
- Being under a jacked-up vehicle is dangerous. The vehicle could slip off the jack and fall on you. You could be crushed. Never put any part of your body under a vehicle that is on a jack. If you need to get under a raised vehicle, take it to a service center where it can be raised on a lift.
- Never start or run the engine while the vehicle is on a jack.

(Continued)

WARNING!

- The jack is designed to be used as a tool for changing tires only. The jack should not be used to lift the vehicle for service purposes. The vehicle should be jacked on a firm level surface only. Avoid ice or slippery areas.

NOTE:

If your vehicle is equipped with an air suspension system, there is a feature which allows the automatic leveling to be disabled to assist with changing a tire. This feature can be activated through the Uconnect system → page 252.

PREPARATIONS FOR JACKING

NOTE:

If your vehicle is equipped with Air Suspension, you will need to enable Tire Jack Mode in the Uconnect system → page 166 before changing the tire.

1. Park on a firm, level surface. Avoid ice or slippery areas.

WARNING!

Do not attempt to change a tire on the side of the vehicle close to moving traffic. Pull far enough off the road to avoid being hit when operating the jack or changing the wheel.

2. Turn on the Hazard Warning Flashers.
3. Apply the parking brake.
4. Shift the transmission into Park (P).
5. Turn the ignition OFF.
6. Block both the front and rear wheel diagonally opposite of each jacking position. For example, if the driver's front wheel is being changed, block the passenger's rear wheel.

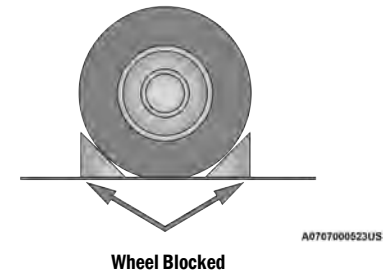

NOTE:

Passengers should not remain in the vehicle when the vehicle is being raised or lifted.

JACK LOCATION

The jack and tools are stored under the front passenger seat.

REMOVAL OF JACK AND TOOLS

To access the jack and tools, you must remove the plastic access cover located on the side of the front passenger's seat. To remove the cover, pull the front part of the cover (closest to the front of the seat) toward you to release a locking tab. Once the front of the cover is loose, slide the cover toward the front of the seat until it is free from the seat frame.

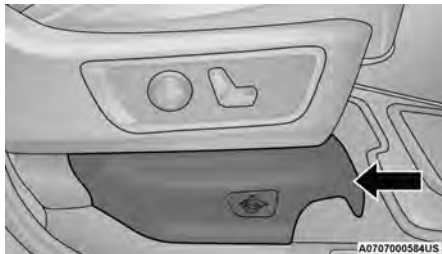

Pull Jack Access Cover From Front

Remove the jack and tools by turning the wing bolt counterclockwise. After removing the wing bolt, slide the assembly out from under the seat.

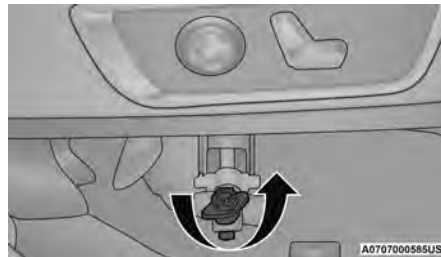

Jack And Tools

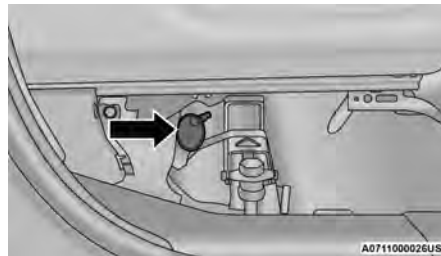

Fuel Funnel Location

Release the tool bag straps from the jack and remove tools from bag.

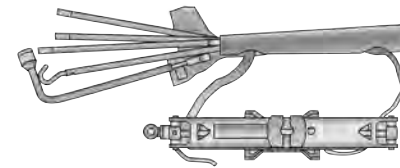

A0707000536US

Jack And Tool Bag

354 IN CASE OF EMERGENCY

There are two ways to assemble the tools:

Assembled For Spare Tire Lowering/Raising

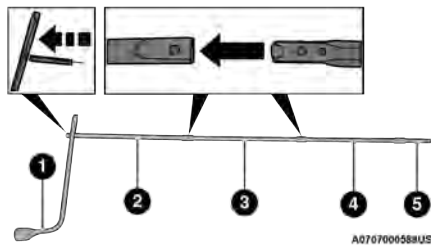

Assembled For Spare Tire Lowering/Raising

- 1 – Lug Wrench
- 2 – Long Extension Without Spring Clip 2
- 3 – Long Extension With Spring Clip 3
- 4 – Long Extension With Spring Clip 4
- 5 – Short Extension 5

NOTE:

If the tailgate is lowered, adding the shorter extension 5 to jack extension 4 will enable lowering the spare tire without having to raise the tailgate.

CAUTION!

- The lug wrench can only be attached to extension 2.
- When attaching the tool to the winch mechanism be sure the large flared end opening on extension 4 is positioned correctly over the winch mechanism adjusting nut.
- Damage to the lug wrench, extensions and winch mechanism may occur from improper tool assembly.

Assembled For Jack Operation

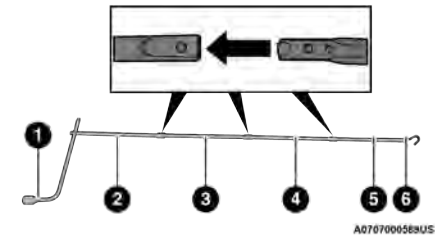

Assembled For Jack Operation

- 1 – Lug Wrench
- 2 – Long Extension 2
- 3 – Long Extension 3
- 4 – Long Extension 4
- 5 – Short Extension 5
- 6 – Extension With Hook

WARNING!

After using the jack and tools, always reinstall them in the original carrier and location. While driving you may experience abrupt stopping, rapid acceleration or sharp turns. A loose jack, tools, bracket or other objects in the vehicle may move around with force, resulting in serious injury.

REMOVING THE SPARE TIRE

1. Remove the spare tire before attempting to jack up the truck. Attach the lug wrench to the extension tubes with the curved angle facing away from the vehicle.
2. Remove the protective cover over the access hole for the winch mechanism by sliding the cover upward.

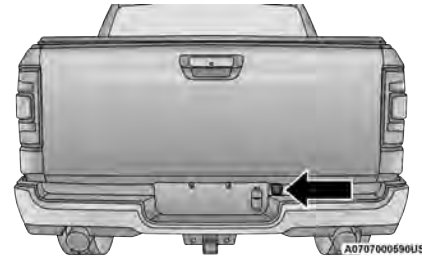

Access Hole Cover Location

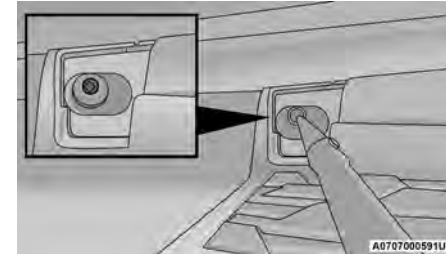

Winch Mechanism Tube

3. Insert the extension tube through the access hole between the lower tailgate and the top of the fascia/bumper and into the winch mechanism tube.

CAUTION!

The winch mechanism is designed for use with the jack extension tube only. Use of an air wrench or other power tools is not recommended and can damage the winch.

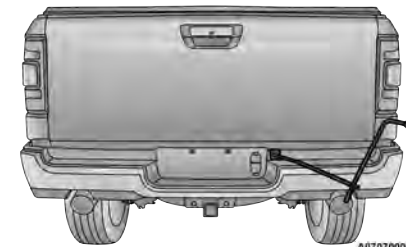

Inserting The Extension Tubes Into The Access Hole

4. Rotate the lug wrench handle counter-clockwise until the spare tire is on the ground with enough cable slack to allow you to pull it out from under the vehicle.

356 IN CASE OF EMERGENCY

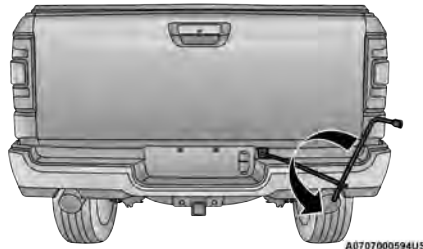

Rotating The Lug Wrench Handle

5. Pull the spare tire out from under the vehicle to gain access to the spare tire retainer.

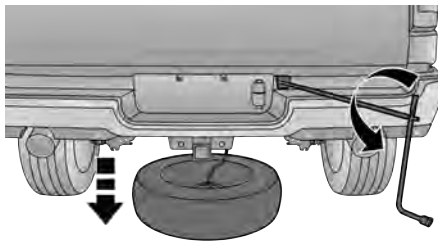

Pulling The Spare Tire Out

6. Lift the spare tire with one hand to give clearance to tilt the retainer at the end of the cable.

7. Pull the retainer through the center of the wheel.

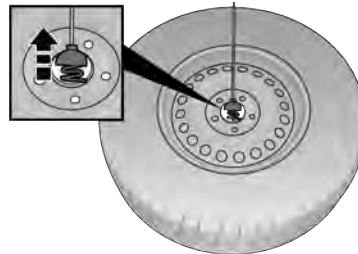

Disengaging The Retainer

JACKING INSTRUCTIONS

WARNING!

Carefully follow these tire changing warnings to help prevent personal injury or damage to your vehicle:

- Always park on a firm, level surface as far from the edge of the roadway as possible before raising the vehicle.
- Turn on the Hazard Warning Flashers.
- Apply the parking brake firmly and set the transmission in PARK.

(Continued)

WARNING!

- Block the wheel diagonally opposite the wheel to be raised.
- Never start or run the engine with the vehicle on a jack.
- Do not let anyone sit in the vehicle when it is on a jack.
- Do not get under the vehicle when it is on a jack. If you need to get under a raised vehicle, take it to a service center where it can be raised on a lift.
- Only use the jack in the positions indicated and for lifting this vehicle during a tire change.
- If working on or near a roadway, be extremely careful of motor traffic.
- To assure that spare tires, flat or inflated, are securely stowed, spares must be stowed with the valve stem facing the ground.



Jack Warning Label

06060714

CAUTION!

Do not attempt to raise the vehicle by jacking on locations other than those indicated in the Jacking Instructions for this vehicle.

1. Remove the spare tire, jack, and tools from the stored location.
2. Using the lug wrench, loosen the wheel nuts (but do not remove), by turning them counter-clockwise one turn while the wheel is still on the ground.
3. Assemble the jack and jacking tools. Connect the jack handle driver to the extension, then to the lug wrench.

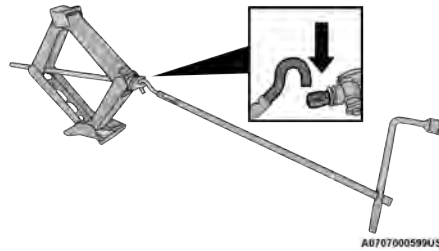

Assembled Jack And Tools

A0707000599US

4. Placement for the front and rear jacking locations are critical. See below images for proper jacking locations.

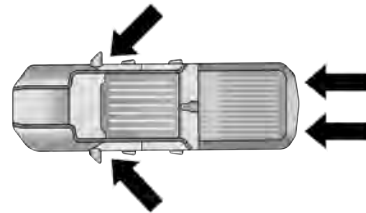

Jack / Extensions Placement

A0707000600US

Front Jacking Location

When changing a front wheel, place the scissor jack under the rear portion of the lower control arm as shown. **Access the front jacking location from behind the front tire.**

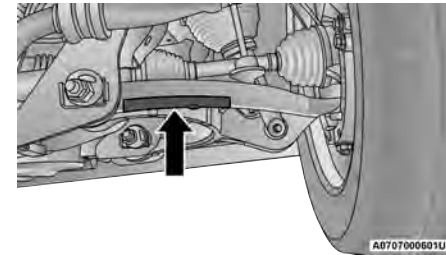

Front Lifting Point

7

358 IN CASE OF EMERGENCY

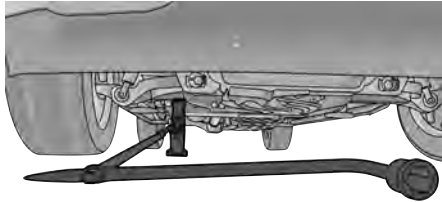

A0707000602US

Front Jacking Location

Rear Jacking Location

Operate the jack using the extension with jack hook and the lug wrench. The extension tubes may be used but are not required.

When changing a rear wheel, assemble the extension with jack hook to the jack and connect the extension tubes. **Access the rear jacking location from behind the rear tire.** Place the jack under the Jack Lifting Point located on the rear axle lower control arm bracket. Then locate the slot in the jack lift plate onto the rear axle Jack Lifting Point. Attach the extension with jack hook extending to the rear of the vehicle.

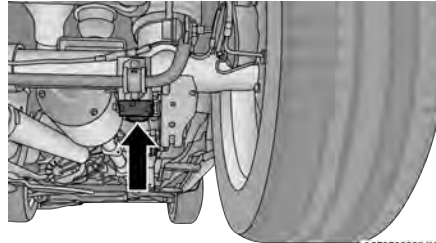

A0707000604US

Rear Lifting Point

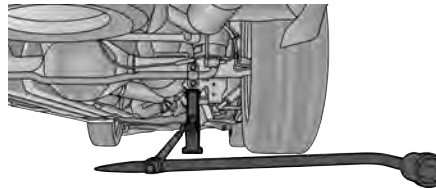

A0707000603US

Rear Jacking Location

Connect the long extensions to the lug wrench.

CAUTION!

Before raising the wheel off the ground, make sure that the jack will not damage surrounding truck parts and adjust the jack position as required.

- By rotating the lug wrench clockwise, raise the vehicle until the wheel just clears the ground surface.

WARNING!

Raising the vehicle higher than necessary can make the vehicle less stable. It could slip off the jack and hurt someone near it. Raise the vehicle only enough to remove the tire.

- Remove the lug nuts and pull the wheel off. Install the spare wheel and lug nuts with the cone shaped end of the lug nuts toward the wheel. Hand tighten the lug nuts with the vehicle lifted. To avoid the risk of forcing the vehicle off the jack, do not fully tighten the lug nuts until the vehicle has been completely lowered.

7. Lower the vehicle to the ground and finish tightening the lug nuts. Push down on the wrench handle for increased leverage. Tighten the lug nuts in a star pattern until each lug nut has been tightened twice ↪ page 442. If in doubt about the correct tightness, have them checked with a torque wrench by an authorized dealer or at a service station.

WARNING!

A loose tire or jack thrown forward in a collision or hard stop, could endanger the occupants of the vehicle. Always stow the jack parts and the spare tire in the places provided.

8. If your vehicle is equipped with a wheel center cap, install the cap and remove the wheel blocks. Do not install chrome or aluminum wheel center caps on the spare wheel. This may result in cap damage.
9. Lower the jack to its fully closed position. Stow the replaced tire, and secure the jack and tools in the proper location.
10. Adjust the tire pressure when possible.

To STOW THE FLAT OR SPARE

1. Lift the spare tire with one hand to give clearance to tilt the retainer at the end of the cable.
2. Position the wheel behind the rear fascia/bumper facing outward. Push the end of the winch's cable, spring and steel sleeve through the back of the road wheel. Making sure the valve stem is facing the ground when the wheel is stowed.

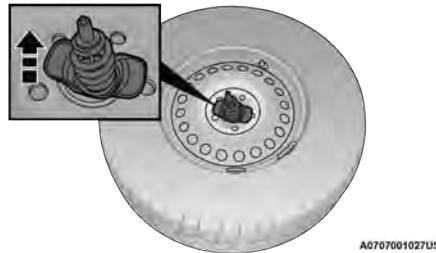
**Reinstalling The Retainer**

A6707001027US

3. Remove the extension with the hook and reattach the short extension 5. Attach the lug wrench to the extension tubes with the curved angle facing away from the vehicle ↪ page 353. Insert the extension tubes through the access hole between the lower tailgate and the top of the fascia/bumper and into the winch mechanism tube.

CAUTION!

The winch mechanism is designed for use with the jack extension tube only. Use of an air wrench or other power tools is not recommended and can damage the winch.

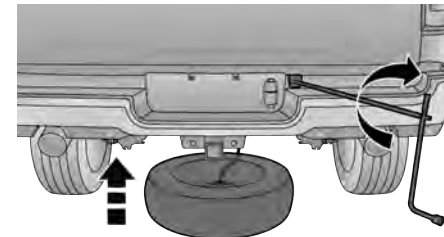

A6707000596US

Reinstalling The Flat Or Spare Tire

4. Rotate the lug wrench handle clockwise until the wheel is drawn into place against the underside of the vehicle. Continue to rotate until you feel the winch mechanism slip, or click three or four times. It cannot be overtightened. Push against the tire several times to ensure it is firmly in place.

360 IN CASE OF EMERGENCY

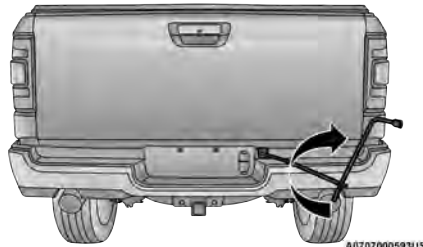

Rotating The Lug Wrench Handle

NOTE:
Have the flat tire repaired or replaced immediately.

WARNING!

A loose tire or jack thrown forward in a collision or hard stop could endanger the occupants of the vehicle. Always stow the jack parts and the spare tire in the places provided. Have the deflated (flat) tire repaired or replaced immediately.

REINSTALLING THE JACK AND TOOLS

1. Tighten the jack all the way down by turning the jack turn-screw counterclockwise until the jack is snug.
2. Position the jack and tool bag. Make sure the lug wrench is under the jack near the jack turn-screw.

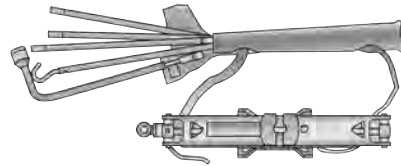

Jack And Tool Bag

3. Secure the tool bag straps to the jack.

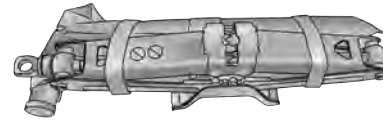

Jack And Tools Tied

4. Place the jack and tools in the storage position holding the jack by the jack turn-screw, slip the jack and tools under the seat so that the bottom slot engages into the fastener on the floor.

NOTE:
Ensure that the jack slides into the front hold down location.

5. Turn the wing bolt clockwise to secure to the floor pan. Reinstall the plastic cover.

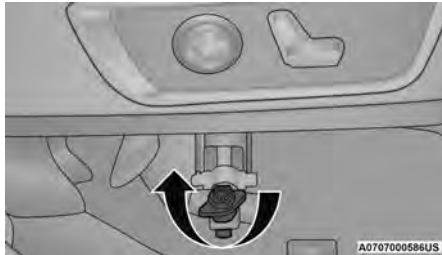

Jack Hold Down Wing Bolt

WARNING!

After using the jack and tools, always reinstall them in the original carrier and location. While driving you may experience abrupt stopping, rapid acceleration or sharp turns. A loose jack, tools, bracket or other objects in the vehicle may move around with force, resulting in serious injury.

JUMP STARTING

If your vehicle has a discharged battery, it can be jump started using a set of jumper cables and a battery in another vehicle, or by using a portable battery booster pack. Jump starting can be dangerous if done improperly, so please follow the procedures in this section carefully.

WARNING!

Do not attempt jump starting if the battery is frozen. It could rupture or explode and cause personal injury.

CAUTION!

Do not use a portable battery booster pack or any other booster source with a system voltage greater than 12 Volts or damage to the battery, starter motor, alternator or electrical system may occur.

NOTE:

When using a portable battery booster pack, follow the manufacturer's operating instructions and precautions.

PREPARATIONS FOR JUMP START

The battery in your vehicle is located in the front of the engine compartment, behind the left headlight assembly.

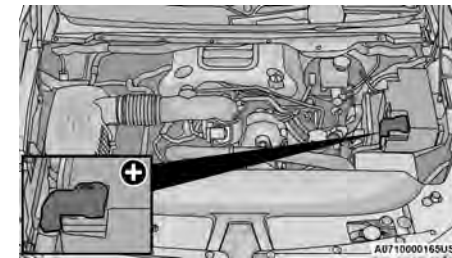

Positive (+) Battery Post Location

NOTE:

The positive battery post may be covered with a protective cap. Lift up on the cap to gain access to the positive battery post. Do not jump off fuses. Only jump directly off positive post which has a positive (+) symbol on or around the post.

362 IN CASE OF EMERGENCY

Follow the below steps to prepare for jump starting:

1. Shift the automatic transmission into PARK, apply the parking brake and turn the ignition OFF.
2. Turn off the heater, radio, and all electrical accessories.
3. If using another vehicle to jump start the battery, park the vehicle within the jumper cables' reach, apply the parking brake and make sure the ignition is OFF.

| WARNING! |
|---|
| Do not allow vehicles to touch each other as this could establish a ground connection and personal injury could result. |

4. Pull upward and remove the protective cover over the positive (+) battery post.

| WARNING! |
|---|
| <ul style="list-style-type: none"> ● Take care to avoid the radiator cooling fan whenever the hood is raised. It can start anytime the ignition switch is ON. You can be injured by moving fan blades. |

(Continued)

| WARNING! |
|---|
| <ul style="list-style-type: none"> ● Remove any metal jewelry such as rings, watch bands and bracelets that could make an inadvertent electrical contact. You could be seriously injured. ● Batteries contain sulfuric acid that can burn your skin or eyes and generate hydrogen gas which is flammable and explosive. Keep open flames or sparks away from the battery. |

JUMP STARTING PROCEDURE

| WARNING! |
|---|
| Failure to follow this jump starting procedure could result in personal injury or property damage due to battery explosion. |

| CAUTION! |
|--|
| Failure to follow these procedures could result in damage to the charging system of the booster vehicle or the discharged vehicle. |

Connecting The Jumper Cables

1. Connect the positive (+) end of the jumper cable to the positive (+) post of the discharged vehicle.

NOTE:

Do not jump off fuses. Only jump directly off positive post.

2. Connect the opposite end of the positive (+) jumper cable to the positive (+) post of the booster battery.
3. Connect the negative (-) end of the jumper cable to the negative (-) post of the booster battery.
4. Connect the opposite end of the negative (-) jumper cable to a good engine ground. A "ground" is an exposed metallic/unpainted part of the engine, frame or chassis, such as an accessory bracket or large bolt. The ground must be away from the battery and the fuel injection system.

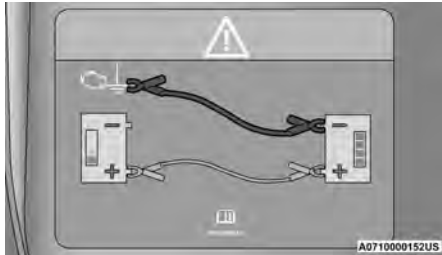

Jump Starting Label

WARNING!

Do not connect the jumper cable to the negative (-) post of the discharged battery. The resulting electrical spark could cause the battery to explode and could result in personal injury.

5. Start the engine in the vehicle that has the booster battery, let the engine idle a few minutes, and then start the engine in the vehicle with the discharged battery.

CAUTION!

Do not connect jumper cable to any of the fuses on the positive battery terminal. The resulting electrical current will blow the fuse.

6. Once the engine is started, follow the disconnection procedure below.

Disconnecting The Jumper Cables

1. Disconnect the negative (-) end of the jumper cable from the engine ground of the vehicle with the discharged battery.
2. Disconnect the opposite end of the negative (-) jumper cable from the negative (-) post of the booster battery.
3. Disconnect the positive (+) end of the jumper cable from the positive (+) post of the booster battery.
4. Disconnect the opposite end of the positive (+) jumper cable from the positive (+) post of the vehicle with the discharged battery, and reinstall the protective cap.

If frequent jump starting is required to start your vehicle you should have the battery and charging system inspected at an authorized dealer.

CAUTION!

Accessories plugged into the vehicle power outlets draw power from the vehicle's battery, even when not in use (i.e., cellular devices, etc.). Eventually, if plugged in long enough without engine operation, the vehicle's battery will discharge sufficiently to degrade battery life and/or prevent the engine from starting.

REFUELING IN EMERGENCY – IF EQUIPPED

The vehicle is equipped with a refueling funnel for a Cap-Less Fuel System. The refueling funnel can be found with the jack and tools ↗ page 353. If refueling is necessary, while using an approved gas can, insert the refueling funnel into the filler neck opening. Take care to open both flappers with the funnel to avoid spills.

NOTE:

In certain cold conditions, ice may prevent the fuel door from opening. If this occurs, lightly push on the fuel door to break the ice buildup and re-release the fuel door using the inside release button. Do not pry on the door.

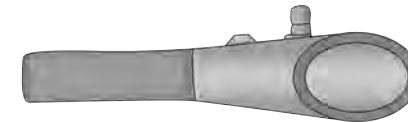

Refueling Funnel

364 IN CASE OF EMERGENCY

CAUTION!

To avoid fuel spillage and overfilling, do not "top off" the fuel tank after filling.

Emergency Gas Can Refueling:

Most gas cans will not open the flapper doors. A funnel is provided to allow emergency refueling with a gas can.

See below steps for refueling:

1. Retrieve funnel from the spare tire storage area.
2. Insert funnel into same filler pipe opening as the fuel nozzle.

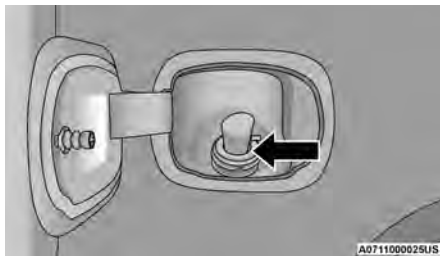

Inserting Funnel

3. Ensure funnel is inserted fully to hold flapper doors open.
4. Pour fuel into funnel opening.
5. Remove funnel from filler pipe, clean off prior to putting back in the spare tire storage area.

WARNING!

- Never have any smoking materials lit in or near the vehicle when the fuel door is open or the tank is being filled.
- Never add fuel when the engine is running. This is in violation of most state and federal fire regulations and may cause the Malfunction Indicator Light to turn on.
- A fire may result if fuel is pumped into a portable container that is inside of a vehicle. You could be burned. Always place fuel containers on the ground while filling.

IF YOUR ENGINE OVERHEATS

If the vehicle is overheating, it will need to be serviced by an authorized dealer.

In any of the following situations, you can reduce the potential for overheating by taking the appropriate action.

- On the highways — slow down.
- In city traffic — while stopped, place the transmission in NEUTRAL (N), but do not increase the engine idle speed while preventing vehicle motion with the brakes.

NOTE:

There are steps that you can take to slow down an impending overheat condition:

- If your Air Conditioner (A/C) is on, turn it off. The A/C system adds heat to the engine cooling system and turning the A/C off can help remove this heat.
- You can also turn the temperature control to maximum heat, the mode control to floor and the blower control to high. This allows the heater core to act as a supplement to the radiator and aids in removing heat from the engine cooling system.

WARNING!

You or others can be badly burned by hot engine coolant (antifreeze) or steam from your radiator. If you see or hear steam coming from under the hood, do not open the hood until the radiator has had time to cool. Never try to open a cooling system pressure cap when the radiator or coolant bottle is hot.

CAUTION!

Driving with a hot cooling system could damage your vehicle. If the temperature gauge reads HOT (H), pull over and stop the vehicle. Idle the vehicle with the air conditioner turned off until the pointer drops back into the normal range. If the pointer remains on HOT (H), and you hear continuous chimes, turn the engine off immediately and call for service.

MANUAL PARK RELEASE**WARNING!**

Always secure your vehicle by fully applying the parking brake before activating the Manual Park Release. In addition, you should be seated in the driver's seat with your foot firmly on the brake pedal when activating the Manual Park Release. Activating the Manual Park Release will allow your vehicle to roll away if it is not secured by the parking brake, or by proper connection to a tow vehicle. Activating the Manual Park Release on an unsecured vehicle could lead to serious injury or death for those in or around the vehicle.

In order to move the vehicle in cases where the transmission will not shift out of PARK (P) (such as a depleted battery), a Manual Park Release is available.

Follow these steps to activate the Manual Park Release:

1. Apply firm pressure to the brake pedal while seated in the driver's seat.
2. Apply the parking brake if possible.
3. Using a small screwdriver or similar tool, open the Manual Park Release cover, which is located to the lower left of the steering column.

**Manual Park Release Access Cover**

4. Behind the Manual Park Release access cover is the orange tether strap. Pull the tether strap out as far as it will go, then release it. The tether and lever will remain outside of the trim panel and the transmission should now be in NEUTRAL, allowing the vehicle to be moved.

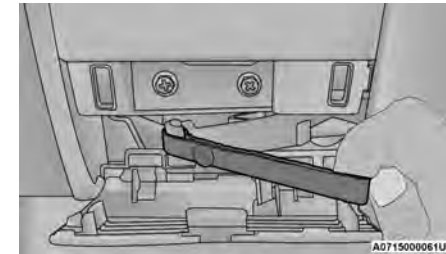
**Manual Park Release Tether**

366 IN CASE OF EMERGENCY

To Reset The Manual Park Release:

1. Apply firm pressure to the brake pedal while seated in the driver's seat.
2. Pull the tether strap out again, then release it.
3. Allow the tether to retract with the lever back to its original position.

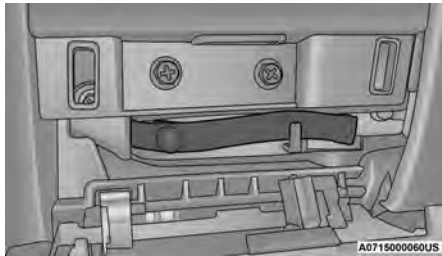

Manual Park Release Tether

4. Verify the transmission is in PARK.
5. Confirm that the tether has retracted fully and re-install the access cover. If the access cover cannot be reinstalled, repeat steps 1 through 4.

NOTE:

When the lever is locked in the released position the access cover cannot be reinstalled.

FREEDING A STUCK VEHICLE

If your vehicle becomes stuck in mud, sand, or snow, it can often be moved using a rocking motion. Turn the steering wheel right and left to clear the area around the front wheels. Then shift back and forth between DRIVE (D) and REVERSE (R), while gently pressing the accelerator. Use the least amount of accelerator pedal pressure that will maintain the rocking motion, without spinning the wheels or racing the engine.

CAUTION!

- Racing the engine or spinning the wheels may lead to transmission overheating and failure. Allow the engine to idle with the transmission in NEUTRAL for at least one minute after every five rocking-motion cycles. This will minimize overheating and reduce the risk of transmission failure during prolonged efforts to free a stuck vehicle.
- When “rocking” a stuck vehicle by shifting between DRIVE and REVERSE, do not spin the wheels faster than 15 mph (24 km/h), or drivetrain damage may result.
- Revving the engine or spinning the wheels too fast may lead to transmission overheating and failure. It can also damage the tires. Do not spin the wheels above 30 mph (48 km/h) while in gear (no transmission shifting occurring).

NOTE:

Shifts between DRIVE and REVERSE can only be achieved at wheel speeds of 5 mph (8 km/h) or less. Whenever the transmission remains in NEUTRAL (N) for more than two seconds, you must press the brake pedal to engage DRIVE or REVERSE.

Push the ESC OFF button to place the Electronic Stability Control (ESC) system in “Partial OFF” mode, before rocking the vehicle → page 292. Once the vehicle has been freed, push the ESC OFF button to restore “ESC On” mode.

WARNING!

Fast spinning tires can be dangerous. Forces generated by excessive wheel speeds may cause damage, or even failure, of the axle and tires. A tire could explode and injure someone. Do not spin your vehicle's wheels faster than 30 mph (48 km/h) or for longer than 30 seconds continuously without stopping when you are stuck and do not let anyone near a spinning wheel, no matter what the speed.

TOWING A DISABLED VEHICLE

This section describes procedures for towing a disabled vehicle using a commercial towing service.

If the transmission and drivetrain are operable, disabled vehicles may also be towed as described on [page 230](#).

NOTE:

Vehicles equipped with the Active-Level Four Corner Air Suspension System must be placed in Transport mode, before tying them down (from the body) on a trailer or flatbed truck [page 166](#). If the vehicle cannot be placed in Transport mode (for example, engine will not run), tie-downs must be fastened to the tires (not to the body). Failure to follow these instructions may cause fault codes to be set and/or cause loss of proper tie-down tension.

| Towing Condition | Wheels OFF The Ground | 2WD Models | 4WD Models |
|-------------------------|-----------------------|---|--|
| Flat Tow | NONE | If transmission is operable: <ul style="list-style-type: none"> • Transmission in NEUTRAL • 30 mph (48 km/h) max speed • 30 miles (48 km) max distance | Detailed instruction on page 230 <ul style="list-style-type: none"> • Automatic Transmission in PARK • Transfer Case in NEUTRAL (N) • Tow in forward direction |
| Wheel Lift Or Dolly Tow | Front | | NOT ALLOWED |
| | Rear | OK | NOT ALLOWED |
| Flatbed | ALL | BEST METHOD | BEST METHOD |

368 IN CASE OF EMERGENCY

Proper towing or lifting equipment is required to prevent damage to your vehicle. Use only tow bars and other equipment designed for this purpose, following equipment per FCA US LLC instructions. Use of safety chains is mandatory. Attach a tow bar or other towing device to main structural members of the vehicle, not to fascia/bumpers or associated brackets. State and local laws regarding vehicles under tow must be observed.

If you must use the accessories (wipers, defrosters, etc.) while being towed, the ignition must be in the ON/RUN mode, not the ACC mode.

If the key fob is unavailable or the vehicle's battery is discharged, find Instructions on shifting the transmission out of PARK in order to move the vehicle → page 365.

| CAUTION! |
|--|
| <ul style="list-style-type: none"> ● Do not use sling type equipment when towing. Vehicle damage may occur. ● When securing the vehicle to a flat bed truck, do not attach to front or rear suspension components. Damage to your vehicle may result from improper towing. |

TWO-WHEEL DRIVE MODELS

FCA US LLC recommends towing your vehicle with all four wheels **OFF** the ground using a flatbed.

If flatbed equipment is not available, and the transmission is operable, the vehicle may be towed (with rear wheels on the ground) under the following conditions:

- The transmission must be in NEUTRAL (N). Instructions on shifting the transmission to NEUTRAL (N) when the engine is **OFF** → page 365.
- The towing speed must not exceed 30 mph (48 km/h).
- The towing distance must not exceed 30 miles (48 km).

If the transmission is not operable, or the vehicle must be towed faster than 30 mph (48 km/h) and farther than 30 miles (48 km), tow with the rear wheels **OFF** the ground. Acceptable methods to tow the vehicle on a flatbed are as follows:

- The front wheels raised and the rear wheels on a towing dolly.
- Using a suitable steering wheel stabilizer to hold the front wheels in the straight position with the rear wheels raised when and the front wheels **ON** the ground.

| CAUTION! |
|---|
| Towing this vehicle in violation of the above requirements can cause severe transmission damage. Damage from improper towing is not covered under the New Vehicle Limited Warranty. |

FOUR-WHEEL DRIVE MODELS

FCA US LLC recommends towing with all wheels **OFF** the ground. Acceptable methods are to tow the vehicle on a flatbed or with one end of vehicle raised and the opposite end on a towing dolly.

| CAUTION! |
|--|
| <ul style="list-style-type: none"> ● Front or rear wheel lifts must not be used (if the remaining wheels are on the ground). Internal damage to the transmission or transfer case will occur if a front or rear wheel lift is used when towing. ● Towing this vehicle in violation of the above requirements can cause severe transmission and/or transfer case damage. Damage from improper towing is not covered under the New Vehicle Limited Warranty. |

EMERGENCY TOW HOOKS — IF EQUIPPED

Your vehicle may be equipped with emergency tow hooks.

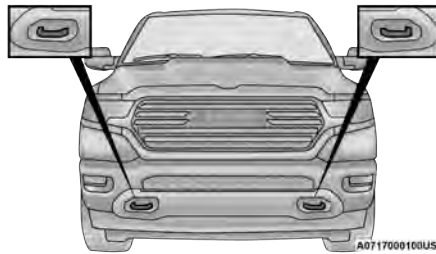

Emergency Tow Hooks

NOTE:

For off-road recovery, it is recommended to use both of the front tow hooks to minimize the risk of damage to the vehicle.

WARNING!

- Do not use a chain for freeing a stuck vehicle. Chains may break, causing serious injury or death.
- Stand clear of vehicles when pulling with tow hooks. Tow straps may become disengaged, causing serious injury.

CAUTION!

Tow hooks are for emergency use only, to rescue a vehicle stranded off road. Do not use tow hooks for tow truck hookup or highway towing. You could damage your vehicle.

ENHANCED ACCIDENT RESPONSE SYSTEM (EARS)

This vehicle is equipped with an Enhanced Accident Response System.

This feature is a communication network that takes effect in the event of an impact ↪ page 329.

EVENT DATA RECORDER (EDR)

This vehicle is equipped with an event data recorder (EDR). The main purpose of an EDR is to record data that will assist in understanding how a vehicle's systems performed under certain crash or near crash-like situations, such as an air bag deployment or hitting a road obstacle ↪ page 330.

SERVICING AND MAINTENANCE

SCHEDULED SERVICING — GASOLINE ENGINE

Your vehicle is equipped with an automatic oil change indicator system. The oil change indicator system will remind you that it is time to take your vehicle in for scheduled maintenance.

Based on engine operation conditions, the oil change indicator message will illuminate. This means that service is required for your vehicle. Operating conditions such as frequent short-trips, trailer tow, and extremely hot or cold ambient temperatures will influence when the “Oil Change Required” message is displayed. Have your vehicle serviced as soon as possible, within the next 500 miles (805 km).

An authorized dealer will reset the oil change indicator message after completing the scheduled oil change. If a scheduled oil change is performed by someone other than an authorized dealer, the message can be reset by referring to the steps described under Instrument Cluster Display ⇨ page 114.

NOTE:

Under no circumstances should oil change intervals exceed 10,000 miles (16,000 km), 12 months or 350 hours of engine run time, whichever comes first. The 350 hours of engine run or idle time is generally only a concern for fleet customers.

Once A Month Or Before A Long Trip:

- Check engine oil level.
- Check windshield washer fluid level.
- Check tire pressure and look for unusual wear or damage. Rotate tires at the first sign of irregular wear, even if it occurs before the oil indicator system turns on.
- Check the fluid levels of the coolant reservoir, brake master cylinder, and fill as needed.
- Check function of all interior and exterior lights.

MAINTENANCE PLAN

Refer to the Maintenance Plan for required maintenance. More frequent maintenance may be needed in severe conditions, such as dusty areas and very short trip driving. In some extreme conditions, additional maintenance not specified in the maintenance schedule may be required.

| At Every Oil Change Interval As Indicated By Oil Change Indicator System: |
|--|
| ● Change the oil and filter. |
| ● Rotate the tires. Rotate at the first sign of irregular wear, even if it occurs before the oil indicator system turns on. |
| ● Inspect the battery and clean and tighten terminals as required. |
| ● Inspect the CV/Universal joints. |
| ● Inspect the brake pads, shoes, rotors, drums, and hoses. |
| ● Inspect the engine cooling system protection and hoses. |
| ● Inspect the exhaust system. |
| ● Inspect the engine air cleaner if using in dusty or off-road conditions, replace the engine air cleaner, as necessary. |
| ● Inspect and replace the Evaporative System Fresh Air Filter as necessary; replacement may be more frequent if vehicle is operated in extreme dusty conditions. |

NOTE:

Using white lithium grease, lubricate the door hinge roller pivot joints twice a year to prevent premature wear.

| Mileage or time passed (whichever comes first) | 20,000 | 30,000 | 40,000 | 50,000 | 60,000 | 70,000 | 80,000 | 90,000 | 100,000 | 110,000 | 120,000 | 130,000 | 140,000 | 150,000 |
|--|---|--------|--------|--------|--------|---------|---------|---------|---------|---------|---------|---------|---------|---------|
| Or Years: | 2 | 3 | 4 | 5 | 6 | 7 | 8 | 9 | 10 | 11 | 12 | 13 | 14 | 15 |
| Or Kilometers: | 32,000 | 48,000 | 64,000 | 80,000 | 96,000 | 112,000 | 128,000 | 144,000 | 160,000 | 176,000 | 192,000 | 208,000 | 224,000 | 240,000 |
| Additional Maintenance | | | | | | | | | | | | | | |
| Replace cabin air filter. | To be replaced every 12,000 mi (19,000 km). | | | | | | | | | | | | | |
| For severe dusty driving conditions, inspect and replace the Evaporative System Fresh Air Filter as necessary; replacement may be more frequent depending on conditions. | X | X | X | X | X | X | X | X | X | X | X | X | X | X |
| Replace engine air cleaner. | | X | | | X | | | X | | | X | | | X |
| If equipped with Stop/Start, replace accessory drive belt with OEM grade Mopar® belt. | | | | | | | | | | | | | | X |
| Replace spark plugs. ¹ | | | | | | | | | X | | | | | |
| Flush and replace the engine coolant at 10 years or 150,000 miles (240,000 km) whichever comes first. | | | | | | | | | X | | | | | X |

374 SERVICING AND MAINTENANCE

| Mileage or time passed (whichever comes first) | 20,000 | 30,000 | 40,000 | 50,000 | 60,000 | 70,000 | 80,000 | 90,000 | 100,000 | 110,000 | 120,000 | 130,000 | 140,000 | 150,000 |
|--|--------|--------|--------|--------|--------|---------|---------|---------|---------|---------|---------|---------|---------|---------|
| Or Years: | 2 | 3 | 4 | 5 | 6 | 7 | 8 | 9 | 10 | 11 | 12 | 13 | 14 | 15 |
| Or Kilometers: | 32,000 | 48,000 | 64,000 | 80,000 | 96,000 | 112,000 | 128,000 | 144,000 | 160,000 | 176,000 | 192,000 | 208,000 | 224,000 | 240,000 |
| Inspect the transfer case fluid, change for any of the following: police, taxi, fleet, or frequent trailer towing. | | | | | X | | | | | | X | | | |
| Change the transfer case fluid. | | | | | | | | | | | X | | | |
| Inspect and replace PCV valve if necessary. | | | | | | | | | X | | | | | |

1. The spark plug change interval is mileage-based only; yearly intervals do not apply.

| WARNING! |
|---|
| <ul style="list-style-type: none"> ● You can be badly injured working on or around a motor vehicle. Do only service work for which you have the knowledge and the right equipment. If you have any doubt about your ability to perform a service job, take your vehicle to a competent mechanic. ● Failure to properly inspect and maintain your vehicle could result in a component malfunction and effect vehicle handling and performance. This could cause an accident. |

SCHEDULED SERVICING — DIESEL ENGINE

Your vehicle is equipped with an automatic oil change indicator system. The oil change indicator system will remind you that it is time to take your vehicle in for scheduled maintenance.

Based on engine operation conditions, the oil change indicator message will illuminate. This means that service is required for your vehicle. Operating conditions such as frequent short-trips, trailer tow, extremely hot or cold ambient temperatures will influence when the “Oil Change Required” message is displayed. Have your vehicle serviced as soon as possible, within the next 500 miles (805 km).

An authorized dealer will reset the oil change indicator message after completing the scheduled oil change. If a scheduled oil change is performed by someone other than an authorized dealer, the message can be reset by referring to the steps described under Instrument Cluster Display [page 114](#).

NOTE:

Under no circumstances should oil change intervals exceed 10,000 miles (16,000 km) or 12 months, whichever comes first.

Once A Month Or Before A Long Trip:

- Check engine oil level.
- Check windshield washer fluid level.
- Check the tire inflation pressures and look for unusual wear or damage.
- Check the fluid levels of the coolant reservoir, brake master cylinder, and power steering, and fill as needed.
- Check function of all interior and exterior lights.

376 SERVICING AND MAINTENANCE

MAINTENANCE PLAN — DIESEL FUEL UP TO B5 BIODIESEL

Refer to the Maintenance Schedules for required maintenance.

| At Every Oil Change Interval As Indicated By Oil Change Indicator System: |
|---|
| ● Change oil and filter. |
| ● Completely fill the Diesel Exhaust Fluid tank. |
| ● Drain water from fuel filter assembly. |
| ● Rotate the tires. Rotate at the first sign of irregular wear, even if it occurs before the oil indicator system turns on. |
| ● Inspect battery and clean and tighten terminals as required. |
| ● Inspect the CV/Universal joints. |
| ● Inspect brake pads, shoes, rotors, drums, hoses and parking brake. |
| ● Inspect engine cooling system protection and hoses. |
| ● Inspect exhaust system. |
| ● Inspect engine air cleaner filter if using in dusty or off-road conditions. Replace engine air cleaner, as necessary. |

NOTE:

Using white lithium grease, lubricate the door hinge roller pivot joints twice a year to prevent premature wear.

| At Every Second Oil Change Interval As Indicated By Oil Change Indicator System: |
|---|
| ● Change fuel filter. |

| Mileage or time passed (whichever comes first) | 10,000 | 20,000 | 30,000 | 40,000 | 50,000 | 60,000 | 70,000 | 80,000 | 90,000 | 100,000 | 110,000 | 120,000 | 130,000 | 140,000 | 150,000 |
|---|--------|--------|--------|--------|--------|--------|---------|---------|---------|---------|---------|---------|---------|---------|---------|
| Or Years: | 1 | 2 | 3 | 4 | 5 | 6 | 7 | 8 | 9 | 10 | 11 | 12 | 13 | 14 | 15 |
| Or Kilometers: | 16,000 | 32,000 | 48,000 | 64,000 | 80,000 | 96,000 | 112,000 | 128,000 | 144,000 | 160,000 | 176,000 | 192,000 | 208,000 | 224,000 | 240,000 |
| Additional Inspections | | | | | | | | | | | | | | | |
| Completely fill the Diesel Exhaust Fluid tank. | X | X | X | X | X | X | X | X | X | X | X | X | X | X | X |
| Inspect the CV/Universal joints. | X | X | X | X | X | X | X | X | X | X | X | X | X | X | X |
| Inspect front suspension, tie rod ends, and replace if necessary. | | X | | X | | X | | X | | X | | X | | X | |
| Inspect the front and rear axle fluid. If gear oil leakage is suspected, check the fluid level. If using your vehicle for police, taxi, fleet, off-road or frequent trailer towing change the axle fluid. | | | X | | | X | | | X | | | X | | | X |
| Inspect the brake linings, parking brake function. | | X | | X | | X | | X | | X | | X | | X | |

378 SERVICING AND MAINTENANCE

| Mileage or time passed (whichever comes first) | 10,000 | 20,000 | 30,000 | 40,000 | 50,000 | 60,000 | 70,000 | 80,000 | 90,000 | 100,000 | 110,000 | 120,000 | 130,000 | 140,000 | 150,000 |
|--|---|--------|--------|--------|--------|--------|---------|---------|---------|---------|---------|---------|---------|---------|---------|
| Or Years: | 1 | 2 | 3 | 4 | 5 | 6 | 7 | 8 | 9 | 10 | 11 | 12 | 13 | 14 | 15 |
| Or Kilometers: | 16,000 | 32,000 | 48,000 | 64,000 | 80,000 | 96,000 | 112,000 | 128,000 | 144,000 | 160,000 | 176,000 | 192,000 | 208,000 | 224,000 | 240,000 |
| Additional Maintenance | | | | | | | | | | | | | | | |
| Replace cabin air filter. | To be replaced every 12,000 mi (19,000 km). | | | | | | | | | | | | | | |
| Drain water from fuel filter assembly. | X | X | X | X | X | X | X | X | X | X | X | X | X | X | X |
| Replace fuel filter and drain water from the fuel filter assembly. ¹ | Fuel filter replacement intervals should be every second oil change and must not exceed 20,000 miles (32,000 km) if using diesel fuel up to B5. | | | | | | | | | | | | | | |
| Replace engine air cleaner. | | | X | | | X | | | X | | | X | | | X |
| Flush and replace the engine coolant at 10 years or 150,000 miles (240,000 km) whichever comes first. | | | | | | | | | | X | | | | | X |
| Replace accessory drive belt(s). | | | | | | | | | | X | | | | | |
| Inspect the transfer case fluid, change for any of the following: police, taxi, fleet, or frequent trailer towing. | | | | | | X | | | | | | X | | | |
| Change transfer case fluid. | | | | | | | | | | | | | | | X |

1. Under normal conditions the diesel fuel filter should be replaced every 20,000 miles (32,000 km) (every other oil change). If the vehicle is being used in severe operating conditions, or in certain geographical areas of the country (Pennsylvania, New York, Ohio, Maryland, West Virginia, Arkansas, Oklahoma, Kansas, Iowa, Missouri and Nebraska) due to fuel cleanliness issues, it's recommended to replace the fuel filter every 10,000 miles (16,000 km).

WARNING!

- You can be badly injured working on or around a motor vehicle. Do only service work for which you have the knowledge and the right equipment. If you have any doubt about your ability to perform a service job, take your vehicle to a competent mechanic.
- Failure to properly inspect and maintain your vehicle could result in a component malfunction and affect vehicle handling and performance. This could cause an accident.

ADDITIONAL MAINTENANCE — B6 To B20 BIODIESEL

NOTE:

- Under no circumstances should oil change intervals exceed 8,000 miles (12,875 km) or six months, whichever comes first when using biodiesel blends greater than 5% (B5).

- The owner is required to monitor mileage for B6-B20 biodiesel, the automatic oil change indicator system does not reflect the use of biofuels.
- Fuel filter change interval is maintained at every second oil change. This is especially important with biodiesel usage.

For more information on using biodiesel
➔ page 446.

380 SERVICING AND MAINTENANCE

ENGINE COMPARTMENT

3.6L ENGINE WITH STOP/START

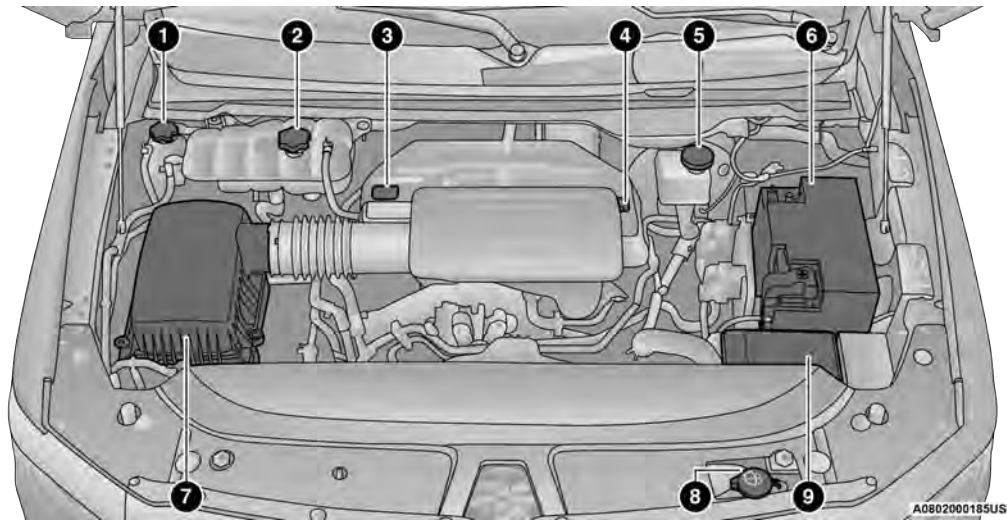

- 1 – Motor Generator Unit Coolant Reservoir Pressure Cap
- 2 – Engine Coolant Reservoir Pressure Cap
- 3 – Engine Oil Dipstick
- 4 – Engine Oil Fill
- 5 – Brake Fluid Reservoir

- 6 – Battery
- 7 – Engine Air Cleaner Filter
- 8 – Washer Fluid Reservoir Cap
- 9 – Power Distribution Center (Fuses)

5.7L ENGINE WITHOUT STOP/START

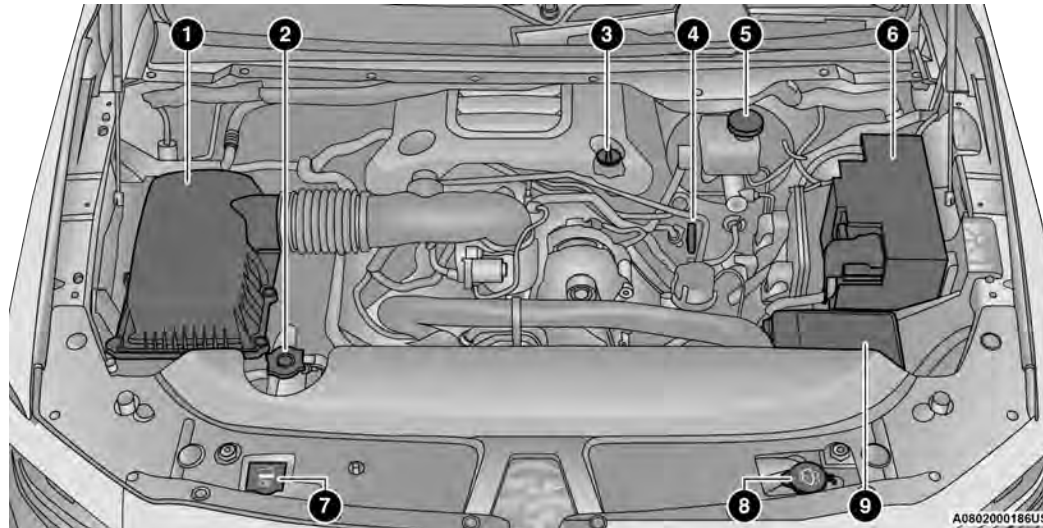

- 1 – Engine Air Cleaner Filter
- 2 – Engine Coolant Pressure Cap
- 3 – Engine Oil Fill
- 4 – Engine Oil Dipstick
- 5 – Brake Fluid Reservoir Cap

- 6 – Battery
- 7 – Engine Coolant Reservoir Cap
- 8 – Washer Fluid Reservoir Cap
- 9 – Power Distribution Center (Fuses)

382 SERVICING AND MAINTENANCE

5.7L ENGINE WITH STOP/START

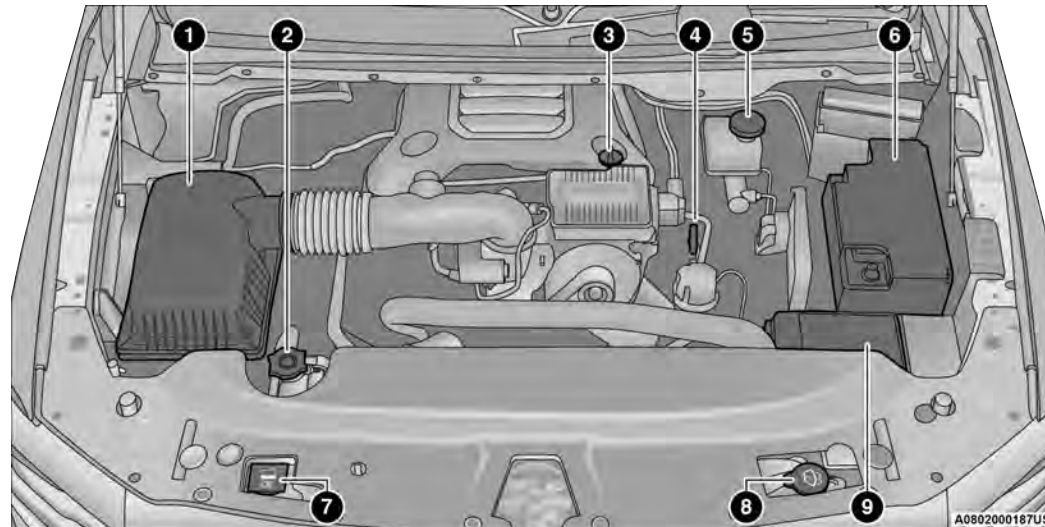

- 1 – Engine Air Cleaner Filter
- 2 – Engine Coolant Pressure Cap
- 3 – Engine Oil Fill
- 4 – Engine Oil Dipstick
- 5 – Brake Fluid Reservoir Cap

- 6 – Battery
- 7 – Engine Coolant Reservoir Cap
- 8 – Washer Fluid Reservoir Cap
- 9 – Power Distribution Center (Fuses)

3.0L DIESEL ENGINE

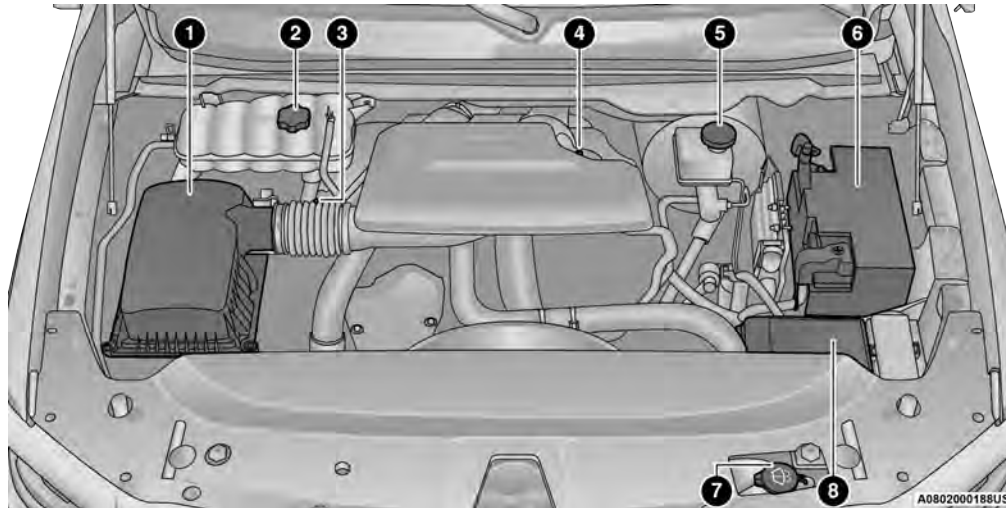

- 1 – Engine Air Cleaner Filter
- 2 – Engine Coolant Reservoir Pressure Cap
- 3 – Engine Oil Dipstick
- 4 – Engine Oil Fill

- 5 – Brake Fluid Reservoir Cap
- 6 – Battery
- 7 – Washer Fluid Reservoir Cap
- 8 – Power Distribution Center (Fuses)

384 SERVICING AND MAINTENANCE**CHECKING OIL LEVEL**

To ensure proper engine lubrication, the engine oil must be maintained at the correct level. Check the oil level at regular intervals, such as every fuel stop. The best time to check the engine oil level is about five minutes after a fully warmed up engine is shut off.

Checking the oil while the vehicle is on level ground will improve the accuracy of the oil level readings.

There are four possible dipstick types:

- Crosshatched zone.
- Crosshatched zone marked SAFE.
- Crosshatched zone marked with MIN at the low end of the range and MAX at the high end of the range.
- Crosshatched zone marked with dimples at the MIN and the MAX ends of the range.

NOTE:

Always maintain the oil level within the crosshatch markings on the dipstick.

Adding 1 quart (1.0 liter) of oil when the reading is at the low end of the dipstick range will raise the oil level to the high end of the range marking.

CAUTION!

Overfilling or underfilling the crankcase will cause oil aeration or loss of oil pressure. This could damage your engine.

ADDING WASHER FLUID

The fluid reservoir is located under the hood and should be checked for fluid level at regular intervals. Fill the reservoir with windshield washer solvent only (not radiator antifreeze). When refilling the washer fluid reservoir, take some washer fluid and apply it to a cloth or towel and wipe the wiper blades clean. This will help blade performance.

To prevent freeze-up of your windshield washer system in cold weather, select a solution or mixture that meets or exceeds the temperature range of your climate. This rating information can be found on most washer fluid containers.

WARNING!

Commercially available windshield washer solvents are flammable. They could ignite and burn you. Care must be exercised when filling or working around the washer solution.

After the engine has warmed up, operate the defroster for a few minutes to reduce the possibility of smearing or freezing the fluid on the cold windshield. Windshield washer solution used with water as directed on the container, aids cleaning action, reduces the freezing point to avoid line clogging, and is not harmful to paint or trim.

MAINTENANCE-FREE BATTERY

Your vehicle is equipped with a maintenance-free battery. You will never have to add water, and periodic maintenance is not required.

WARNING!

- Battery fluid is a corrosive acid solution and can burn or even blind you. Do not allow battery fluid to contact your eyes, skin, or clothing. Do not lean over a battery when attaching clamps. If acid splashes in eyes or on skin, flush the area immediately with large amounts of water → page 361.
- Battery gas is flammable and explosive. Keep flame or sparks away from the battery. Do not use a booster battery or any other booster source with an output greater than 12 Volts. Do not allow cable clamps to touch each other.
- Battery posts, terminals, and related accessories contain lead and lead compounds. Wash hands after handling.

CAUTION!

- It is essential when replacing the cables on the battery that the positive cable is attached to the positive post and the negative cable is attached to the negative post. Battery posts are marked positive (+) and negative (-) and are identified on the battery case. Cable clamps should be tight on the terminal posts and free of corrosion.
- If a “fast charger” is used while the battery is in the vehicle, disconnect both vehicle battery cables before connecting the charger to the battery. Do not use a “fast charger” to provide starting voltage.

PRESSURE WASHING

Cleaning the engine compartment with a high pressure washer is not recommended.

CAUTION!

Precautions have been taken to safeguard all parts and connections however, the pressures generated by these machines is such that complete protection against water ingress cannot be guaranteed.

VEHICLE MAINTENANCE

An authorized dealer has the qualified service personnel, special tools, and equipment to perform all service operations in an expert manner. Service Manuals are available which include detailed service information for your vehicle. Refer to these Service Manuals before attempting any procedure yourself.

NOTE:

Intentional tampering with emissions control systems may void your warranty and could result in civil penalties being assessed against you.

WARNING!

You can be badly injured working on or around a motor vehicle. Only do service work for which you have the knowledge and the proper equipment. If you have any doubt about your ability to perform a service job, take your vehicle to a competent mechanic.

ENGINE OIL — GAS ENGINE**Engine Oil Selection — Gasoline Engine**

Use only the manufacturer's recommended fluids
 ⇨ page 449.

NOTE:

Hemi engines (5.7L) at times can tick right after startup and then quiet down after approximately 30 seconds. This is normal and will not harm the engine. This characteristic can be caused by short drive cycles. For example, if the vehicle is started then shut off after driving a short distance. Upon restarting, you may experience a ticking sound. Other causes could be if the vehicle is unused for an extended period of time, incorrect oil, extended oil changes or extended idling. If the engine continues to tick or if the Malfunction Indicator Light (MIL) comes on, see the nearest authorized dealer.

Engine Oil Selection — Diesel Engine

Use only the manufacturer's recommended fluids
 ⇨ page 449.

**American Petroleum Institute (API)
Approved Engine Oil**

These symbols mean that the oil has been certified by the API. The manufacturer only recommends API trademark oils.



The API Starburst trademark certifies 0W-20, 0W-30 and 5W-30 engine oils.



The API Donut trademark certifies 0W-40 and 5W-40 engine oil.

386 SERVICING AND MAINTENANCE

CAUTION!

Do not use chemical flushes in your engine oil as the chemicals can damage your engine. Such damage is not covered by the New Vehicle Limited Warranty.

Synthetic Engine Oils

Your engine was designed for synthetic engine oils, only use synthetic API approved engine oils.

Synthetic engine oils which do not have both the correct API trademark and the correct SAE viscosity grade numbers should not be used.

Materials Added To Engine Oil

The manufacturer strongly recommends against the addition of any additives (other than leak detection dyes) to the engine oil. Engine oil is an engineered product and its performance may be impaired by supplemental additives.

Disposing Of Used Engine Oil And Oil Filters

Care should be taken in disposing of used engine oil and oil filters from your vehicle. Used oil and oil filters, indiscriminately discarded, can present a problem to the environment. Contact an authorized dealer, service station or governmental agency for advice on how and where used oil and oil filters can be safely discarded in your area.

ENGINE OIL FILTER

The engine oil filter should be replaced with a new filter at every engine oil change.

Engine Oil Filter Selection

A full-flow type disposable oil filter should be used for replacement. The quality of replacement filters varies considerably. Only high quality Mopar® certified filters should be used.

ENGINE AIR CLEANER FILTER

For the proper maintenance intervals ⇨ page 371.

WARNING!

The air induction system (air cleaner, hoses, etc.) can provide a measure of protection in the case of engine backfire. Do not remove the air induction system (air cleaner, hoses, etc.) unless such removal is necessary for repair or maintenance. Make sure that no one is near the engine compartment before starting the vehicle with the air induction system (air cleaner, hoses, etc.) removed. Failure to do so can result in serious personal injury.

Engine Air Cleaner Filter Selection

The quality of replacement filters varies considerably. Only high quality Mopar® certified filters should be used.

Engine Air Cleaner Filter Inspection And Replacement — Except G/T Model

Inspect engine air cleaner filter for dirt and or debris, if you find evidence of either dirt or debris you should change your engine air cleaner filter.

Engine Air Cleaner Filter Removal

1. With suitable tool fully loosen (six) fasteners on the engine air cleaner filter cover.

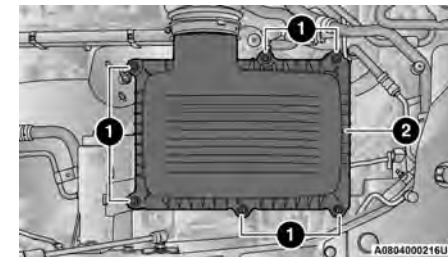

Engine Air Cleaner Filter

- 1 — Fasteners
- 2 — Engine Air Cleaner Filter Cover

2. Lift the engine air cleaner filter cover to access the engine air cleaner filter.
3. Remove the engine air cleaner filter from the housing assembly.

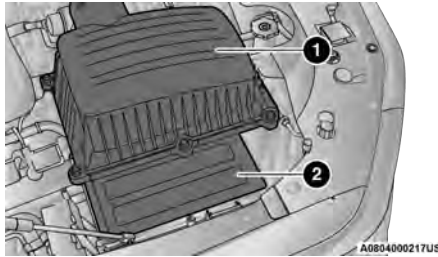

Engine Air Cleaner Filter

- 1 – Engine Air Cleaner Filter Cover
- 2 – Engine Air Cleaner Filter

Engine Air Cleaner Filter Installation

NOTE:

Inspect and clean the housing if dirt or debris is present before replacing the engine air cleaner filter.

1. Install the engine air cleaner filter into the housing assembly with the engine air cleaner filter inspection surface facing downward.
2. Install the engine air cleaner filter cover onto the housing assembly.
3. Tighten the fasteners (six) on the engine air cleaner filter assembly.

Engine Air Cleaner Filter Inspection And Replacement – G/T Model

Inspect engine air cleaner filter for dirt and or debris, if you find evidence of either dirt or debris you should change your engine air cleaner filter.

Engine Air Cleaner Filter Removal

1. Release and remove the engine cover from ball studs by lifting up on each side edge of the engine cover.

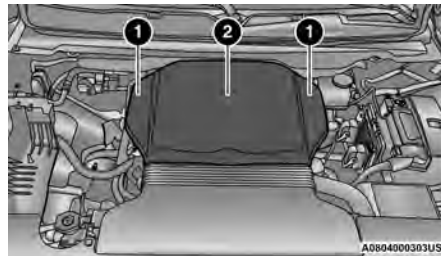

Engine Cover

- 1 – Engine Cover Ball Stud Location
- 2 – Engine Cover

2. With suitable tool fully loosen (four) fasteners on the engine air cleaner filter cover.
3. Remove the engine air cleaner filter cover from the engine air cleaner filter assembly.

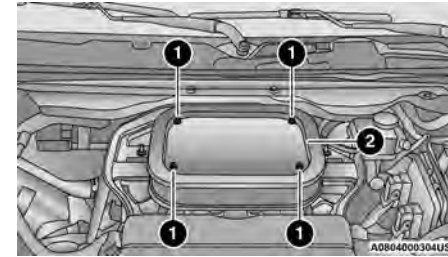

Engine Air Cleaner Filter Assembly

- 1 – Engine Air Cleaner Filter Fasteners
- 2 – Engine Air Cleaner Filter Cover

4. Remove the engine air cleaner filter from the vehicle.



Engine Air Cleaner Filter

- 1 – Engine Air Cleaner Filter

388 SERVICING AND MAINTENANCE

Engine Air Cleaner Filter Installation

NOTE:

Inspect and clean the housing if dirt or debris is present before replacing the engine air cleaner filter.

1. Install the engine air cleaner filter onto the engine air cleaner filter assembly.
2. Install the engine air cleaner filter cover onto the engine air cleaner filter assembly.
3. Tighten the fasteners (four) on the engine air cleaner filter assembly.
4. Install the engine cover.

DRAINING FUEL/WATER SEPARATOR FILTER — DIESEL ENGINE

The fuel/water separator filter housing is located inside the frame rail, behind the left front wheel. The best access to this water drain valve is from under the vehicle.

CAUTION!

- Do not drain the fuel/water separator filter when the engine is running.
- Diesel fuel will damage blacktop paving surfaces. Drain the filter into an appropriate container.

If water is detected in the water separator while the engine is running, or while the ignition switch is in the ON/RUN position, the Water In Fuel Indicator Light will illuminate and an audible chime will be heard. At this point, you should stop the engine and drain the water from the filter housing.

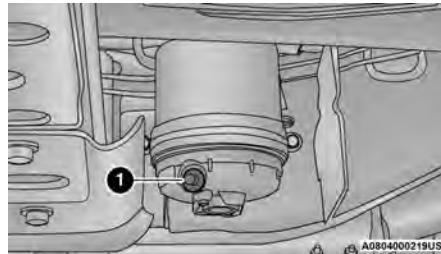

Fuel Filter Assembly

1 — Water In Fuel Drain Valve

CAUTION!

If the Water In Fuel Indicator Light remains on, DO NOT START the engine before you drain water from the fuel filter to avoid engine damage.

If the Water In Fuel Indicator Light comes on and a single chime is heard while you are driving, or with the ignition in the ON position, there may be a

problem with your water separator wiring or sensor. See an authorized dealer for service.

Upon proper draining of the water from the fuel filter, the Water In Fuel Indicator Light will remain illuminated for approximately 10 seconds. If the water was drained while the engine was running, the Water In Fuel Indicator Light may remain on for approximately three minutes.

NOTE:

Care should be taken in disposing of used fluids from your vehicle. Used fluids, indiscriminately discarded, can present a problem to the environment. Contact an authorized dealer, service station, or government agency for advice on recycling programs and for where used fluids and filters can be properly disposed of in your area.

Drain the fuel/water separator filter when the Water In Fuel Indicator Light is ON. Within 10 minutes of vehicle shutdown, turn the filter drain valve (located on the bottom of the filter housing) counterclockwise to drain fuel/water, then turn the ignition switch to the ON position, and allow any accumulated water to drain. Leave the drain valve open until all water and contaminants have been removed. When clean fuel is visible, close the drain valve by turning it clockwise, and turn the ignition switch to OFF.

If more than two ounces or 60 milliliters of fuel have been drained → page 389.

UNDERBODY MOUNTED FUEL FILTER REPLACEMENT — DIESEL ENGINE

NOTE:

Using a fuel filter that does not meet the manufacturer's filtration and water separating requirements can severely impact fuel system life and reliability. Under normal conditions the diesel fuel filter should be replaced every 20,000 miles (every other oil change). If the vehicle is being used in severe operating conditions, or in certain geographical areas of the country (Pennsylvania, New York, Ohio, Maryland, West Virginia, Arkansas, Oklahoma, Kansas, Iowa, Missouri and Nebraska) due to fuel cleanliness issues, it's recommended to replace the fuel filter every 10,000 miles.

CAUTION!

- Diesel fuel will damage blacktop paving surfaces. Drain the filter into an appropriate container.
- Do not prefill the fuel filter when installing a new fuel filter. There is a possibility debris could be introduced into the fuel filter during this action. It is best to install the filter dry and allow the in-tank lift pump to prime the fuel system.

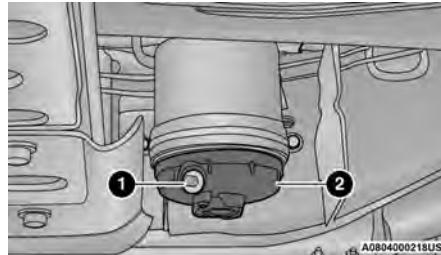

Fuel Filter Assembly

- 1 — Water In Fuel Drain Valve
2 — Fuel Filter Access

1. Turn engine off.
2. Place a drain pan under the fuel filter assembly.
3. Open the water drain valve, and let any accumulated water drain.
4. Close the water drain valve.
5. Remove bottom cover using a strap wrench. Rotate counterclockwise for removal. Remove the used o-ring and discard it.
6. Remove the used filter cartridge from the housing and dispose of it according to your local regulations.

7. Wipe the sealing surfaces of the lid and housing clean.
8. Install a new o-ring into the ring groove on the filter housing and lubricate with clean engine oil.

PRIMING IF THE ENGINE HAS RUN OUT OF FUEL — DIESEL ENGINE

WARNING!

Do not open the high pressure fuel system with the engine running. Engine operation causes high fuel pressure. High pressure fuel spray can cause serious injury or death.

1. Add a substantial amount of fuel to the tank, approximately 2 to 5 gal (8 L to 19 L).
2. Press ignition switch twice without your foot on brake to put vehicle in ON/RUN position. This will activate the in tank fuel pump for approximately 30 seconds. Repeat this process twice.
3. Start the engine using the "Normal Starting" procedure → page 146.

390 SERVICING AND MAINTENANCE**CAUTION!**

The starter motor will engage for approximately 30 seconds at a time. Allow two minutes between cranking intervals.

NOTE:

The engine may run rough until the air is forced from all the fuel lines.

WARNING!

Do not use alcohol or gasoline as a fuel blending agent. They can be unstable under certain conditions and be hazardous or explosive when mixed with diesel fuel.

CAUTION!

Due to lack of lubricants in alcohol or gasoline, the use of these fuels can cause damage to the fuel system.

NOTE:

- Use of biodiesel mixture in excess of 20% can negatively impact the fuel filter's ability to separate water from the fuel, resulting in high pressure fuel system corrosion or damage.

- In addition, commercially available fuel additives are not necessary for the proper operation of your diesel engine.
- For extreme cold conditions, "Mopar® Premium Diesel Fuel Treatment" is recommended to assist with cold starting.

INTERVENTION REGENERATION STRATEGY — MESSAGE PROCESS FLOW (DIESEL ENGINE)

This engine meets all required diesel engine emissions standards. To achieve these emissions standards, your vehicle is equipped with a state-of-the-art engine and exhaust system. These systems are seamlessly integrated into your vehicle and managed by the Powertrain Control Module (PCM). The PCM manages engine combustion to allow the exhaust system's catalyst to trap and burn Particulate Matter (PM) pollutants, with no input or interaction on your part.

Additionally, your vehicle has the ability to alert you to additional maintenance required on your vehicle or engine → page 114.

WARNING!

A hot exhaust system can start a fire if you park over materials that can burn, such as grass or leaves, and those items that come into contact with your exhaust system. Do not park or operate your vehicle in areas where your exhaust system can contact anything that can burn.

DIESEL EXHAUST FLUID

Diesel Exhaust Fluid (DEF) sometimes known simply by the name of its active component, UREA—is a key component of Selective Catalytic Reduction (SCR) systems, which help diesel vehicles meet stringent emission regulations. DEF is a liquid reducing agent that reacts with engine exhaust in the presence of a catalyst to convert smog-forming Nitrogen Oxides (NOx) into harmless nitrogen and water vapor.

Refer to Engine Fluids And Lubricants → page 449 for further information.

AIR CONDITIONER MAINTENANCE

For best possible performance, your air conditioner should be checked and serviced by an authorized dealer at the start of each warm season. This service should include cleaning of the condenser fins and a performance test. Drive belt tension should also be checked at this time.

WARNING!

- Use only refrigerants and compressor lubricants approved by the manufacturer for your air conditioning system. Some unapproved refrigerants are flammable and can explode, injuring you. Other unapproved refrigerants or lubricants can cause the system to fail, requiring costly repairs. Refer to Warranty Information Book, for further warranty information.
- The air conditioning system contains refrigerant under high pressure. To avoid risk of personal injury or damage to the system, adding refrigerant or any repair requiring lines to be disconnected should be done by an experienced technician.

CAUTION!

Do not use chemical flushes in your air conditioning system as the chemicals can damage your air conditioning components. Such damage is not covered by the New Vehicle Limited Warranty.

Refrigerant Recovery And Recycling – R-1234yf

R-1234yf Air Conditioning Refrigerant is a Hydrofluoroolefin (HFO) that is endorsed by the Environmental Protection Agency and is an ozone-friendly substance with a low global-warming potential. It is recommended that air conditioning service be performed by an authorized dealer using recovery and recycling equipment.

NOTE:

Use only the manufacturer approved A/C system PAG compressor oil, and refrigerants.

Cabin Air Filter Replacement

For the proper maintenance intervals ⇨ page 371.

WARNING!

Do not remove the cabin air filter while the vehicle is running, or while the ignition is in the ACC or ON/RUN mode. With the cabin air filter removed and the blower operating, the blower can contact hands and may propel dirt and debris into your eyes, resulting in personal injury.

The cabin air filter is located in the fresh air inlet behind the glove compartment. Perform the following procedure to replace the filter:

1. Open the glove compartment and remove all contents.
2. With the glove compartment door open, remove the glove compartment tension tether and tether clip by sliding the clip toward the face of the glove compartment door. Lift the clip out of glove compartment door and release into dash panel.

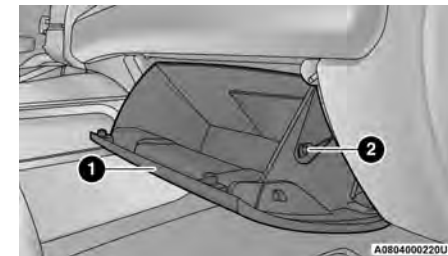

Right Side Of Glove Compartment

- 1 – Glove Compartment Door
2 – Glove Compartment Tension Tether

392 SERVICING AND MAINTENANCE

3. There are glove compartment travel stops on both sides of the glove compartment door. Push inward on both sides of the glove compartment to release the glove compartment travel stops.

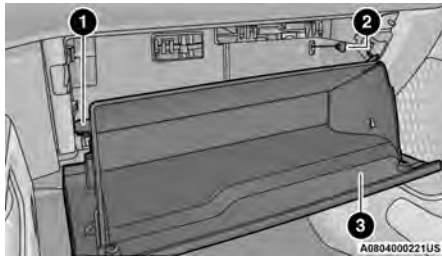

Glove Compartment

- 1 – Glove Compartment Travel Stop
- 2 – Glove Compartment Tension Tether
- 3 – Glove Compartment Door

4. Disengage the glove compartment door from its hinges by opening the glove compartment past the travel stop and pulling it toward you.
5. Remove the filter cover by pushing in on the finger tabs on each end of the filter cover.

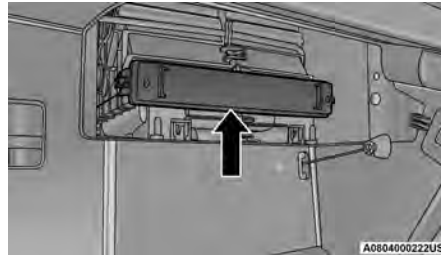

Filter Cover

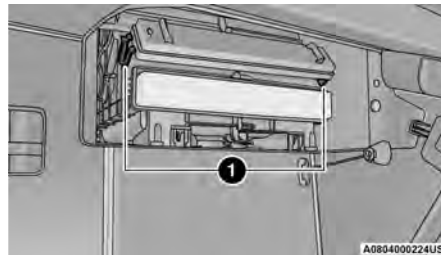

Filter Cover Removal

- 1 – Finger Tabs

6. Remove the cabin air filter by pulling it straight out of the housing.

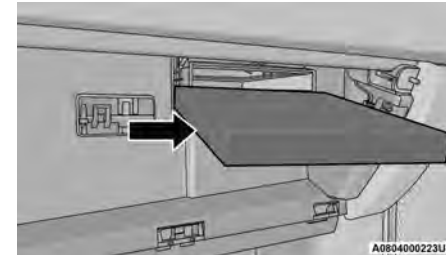

Cabin Air Filter

7. Install the cabin air filter with the arrow on the filter pointing toward the floor. When installing the filter cover, press on each end until you hear an audible click.

CAUTION!

The cabin air filter is identified with an arrow to indicate airflow direction through the filter. Failure to properly install the filter will result in the need to replace it more often.

8. Reinstall the glove compartment on the hinges.
9. Pull the tension tether outward and reinstall the glove compartment past the travel stops by pushing in on the glove compartment sides.

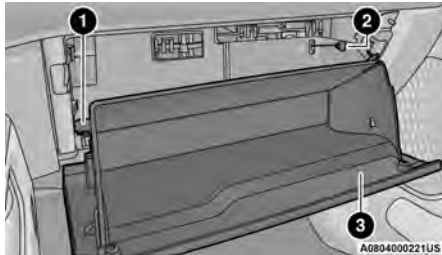

Glove Compartment

- 1 – Glove Compartment Travel Stop
- 2 – Glove Compartment Tension Tether
- 3 – Glove Compartment Door

NOTE:

Ensure the glove compartment door hinges and glove compartment travel stops are fully engaged.

10. Reattach the glove compartment tension tether by inserting the tether clip in the glove compartment and sliding the clip away from the face of the glove compartment door.

ACCESSORY DRIVE BELT INSPECTION

WARNING!

- Do not attempt to inspect an accessory drive belt with vehicle running.
- When working near the radiator cooling fan, disconnect the fan motor lead. The fan is temperature controlled and can start at any time regardless of ignition mode. You could be injured by the moving fan blades.
- You can be badly injured working on or around a motor vehicle. Only do service work for which you have the knowledge and the proper equipment. If you have any doubt about your ability to perform a service job, take your vehicle to a competent mechanic.

When inspecting accessory drive belts, small cracks that run across the ribbed surface of the belt from rib to rib, are considered normal. This is not a reason to replace the belt. However, cracks running along a rib (not across) are not normal. Any belt with cracks running along a rib must be replaced. Also have the belt replaced if it has excessive wear, frayed cords or severe glazing.

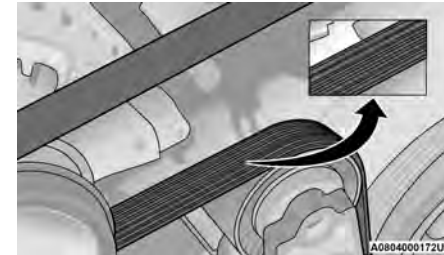

Accessory Belt (Serpentine Belt)

Conditions that would require replacement:

- Rib chunking (one or more ribs has separated from belt body)
- Rib or belt wear
- Longitudinal belt cracking (cracks between two ribs)
- Belt slips
- “Groove jumping” (belt does not maintain correct position on pulley)
- Belt broken
- Noise (objectionable squeal, squeak, or rumble is heard or felt while drive belt is in operation)

394 SERVICING AND MAINTENANCE

NOTE:

Identify and correct problem before new belt is installed.

NOTE:

If your vehicle is equipped with a Stop/Start, belt must be replaced with an OEM grade Mopar® belt. Some conditions can be caused by a faulty component such as a belt pulley. Belt pulleys should be carefully inspected for damage and proper alignment.

Belt replacement on some models requires the use of special tools, we recommend having your vehicle serviced at an authorized dealer.

BODY LUBRICATION

Locks and all body pivot points, including such items as seat tracks, door hinge pivot points and rollers, liftgate, tailgate, decklid, sliding doors and hood hinges, should be lubricated periodically. Use a lithium-based grease, such as Mopar® Spray White Lube to assure quiet, easy operation and to protect against rust and wear. Prior to the application of any lubricant, the parts concerned should be wiped clean to remove dust and grit; after lubricating excess oil and grease should be removed. Particular attention should also be given to hood latching components to ensure proper function. When performing other underhood

services, the hood latch release mechanism, and safety catch should be cleaned and lubricated.

The external lock cylinders should be lubricated twice a year, preferably in the Autumn and Spring. Apply a small amount of a high quality lubricant, such as Mopar® Lock Cylinder Lubricant directly into the lock cylinder.

WINDSHIELD WIPER BLADES

Clean the rubber edges of the wiper blades and the windshield periodically with a sponge or soft cloth and a mild nonabrasive cleaner. This will remove accumulations of salt or road film.

Operation of the wipers on dry glass for long periods may cause deterioration of the wiper blades. Always use washer fluid when using the wipers to remove salt or dirt from a dry windshield.

Avoid using the wiper blades to remove frost or ice from the windshield. Keep the blade rubber out of contact with petroleum products such as engine oil, gasoline, etc.

NOTE:

Life expectancy of wiper blades varies depending on geographical area and frequency of use. If chattering, marks, water lines or wet spots are present, clean the wiper blades or replace as necessary.

The wiper blades and wiper arms should be inspected periodically, not just when wiper performance problems are experienced. This inspection should include the following points:

- Wear or uneven edges
- Foreign material
- Hardening or cracking
- Deformation or fatigue

If a wiper blade or wiper arm is damaged, replace the affected wiper arm or blade with a new unit. Do not attempt to repair a wiper arm or blade that is damaged.

Wiper Blade Removal/Installation

| |
|---|
| CAUTION! |
| Do not allow the wiper arm to spring back against the glass without the wiper blade in place or the glass may be damaged. |

1. Lift the wiper arm to raise the wiper blade off of the glass, until the wiper arm is in the full up position.

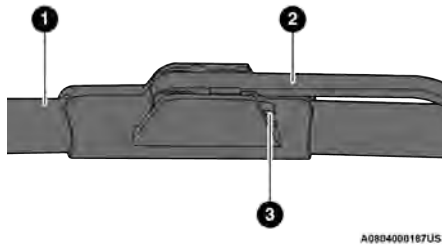

Wiper Blade With Release Tab In Locked Position

- 1 – Wiper Blade
- 2 – Wiper Arm
- 3 – Release Tab

2. To disengage the wiper blade from the wiper arm, press the release tab on the wiper blade and while holding the wiper arm with one hand, slide the wiper blade down towards the base of the wiper arm.

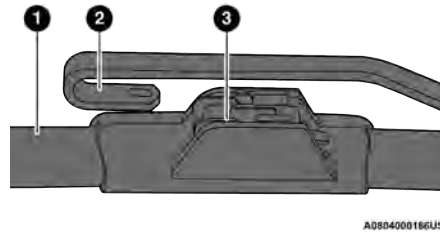

Wiper Blade With Release Tab In Unlocked Position

- 1 – Wiper Blade
- 2 – Wiper Arm J Hook
- 3 – J Hook Retainer

3. With the wiper blade disengaged, remove the wiper blade from the wiper arm.
4. Gently lower the wiper arm onto the glass.

Installing The Front Wipers

1. Lift the wiper arm off of the glass, until the wiper arm is in the full up position.
2. Position the wiper blade near the hook on the tip of the wiper arm.
3. Slide the wiper blade up into the hook on the wiper arm, latch engagement will be accompanied by an audible click.
4. Gently lower the wiper blade onto the glass.

EXHAUST SYSTEM

The best protection against carbon monoxide entry into the vehicle body is a properly maintained engine exhaust system.

If you notice a change in the sound of the exhaust system; or if the exhaust fumes can be detected inside the vehicle; or when the underside or rear of the vehicle is damaged; have an authorized technician inspect the complete exhaust system and adjacent body areas for broken, damaged, deteriorated, or mispositioned parts. Open seams or loose connections could permit exhaust fumes to seep into the passenger compartment. In addition, have the exhaust system inspected each time the vehicle is raised for lubrication or oil change. Replace as required.

WARNING!

- Exhaust gases can injure or kill. They contain Carbon Monoxide (CO), which is colorless and odorless. Breathing it can make you unconscious and can eventually poison you. To avoid breathing CO see ↪ page 345.
- A hot exhaust system can start a fire if you park over materials that can burn. Such materials might be grass or leaves coming into contact with your exhaust system. Do not park or operate your vehicle in areas where your exhaust system can contact anything that can burn.

396 SERVICING AND MAINTENANCE

| CAUTION! |
|--|
| <ul style="list-style-type: none"> ● The catalytic converter requires the use of unleaded fuel only. Leaded gasoline will destroy the effectiveness of the catalyst as an emissions control device and may seriously reduce engine performance and cause serious damage to the engine. ● Damage to the catalytic converter can result if your vehicle is not kept in proper operating condition. In the event of engine malfunction, particularly involving engine misfire or other apparent loss of performance, have your vehicle serviced promptly. Continued operation of your vehicle with a severe malfunction could cause the converter to overheat, resulting in possible damage to the converter and vehicle. |

Under normal operating conditions, the catalytic converter will not require maintenance. However, it is important to keep the engine properly tuned to assure proper catalyst operation and prevent possible catalyst damage.

NOTE:
Intentional tampering with emissions control systems can result in civil penalties being assessed against you.

In unusual situations involving grossly malfunctioning engine operation, a scorching odor

may suggest severe and abnormal catalyst overheating. If this occurs, stop the vehicle, turn off the engine and allow it to cool. Service, including a tune-up to manufacturer's specifications, should be obtained immediately.

To minimize the possibility of catalytic converter damage:

- Do not interrupt the ignition when the transmission is in gear and the vehicle is in motion.
- Do not try to start the vehicle by pushing or towing the vehicle.
- Do not idle the engine with any ignition components disconnected or removed, such as when diagnostic testing, or for prolonged periods during very rough idle or malfunctioning operating conditions.

COOLING SYSTEM

| WARNING! |
|---|
| <ul style="list-style-type: none"> ● You or others can be badly burned by hot engine coolant (antifreeze) or steam from your radiator. If you see or hear steam coming from under the hood, do not open the hood until the radiator has had time to cool. Never open a cooling system pressure cap when the radiator or coolant bottle is hot. |

(Continued)

| WARNING! |
|---|
| <ul style="list-style-type: none"> ● Keep hands, tools, clothing, and jewelry away from the radiator cooling fan when the hood is raised. The fan starts automatically and may start at any time, whether the engine is running or not. ● When working near the radiator cooling fan, disconnect the fan motor lead or turn the ignition to the OFF mode. The fan is temperature controlled and can start at any time the ignition is in the ON mode. |

Engine Coolant Checks

Check the engine coolant (antifreeze) protection every 12 months (before the onset of freezing weather, where applicable). If the engine coolant is dirty or rusty in appearance, the system should be drained, flushed and refilled with fresh coolant. Check the front of the A/C condenser (if equipped) or radiator for any accumulation of bugs, leaves, etc. If dirty, clean by gently spraying water from a garden hose vertically down the face of the A/C condenser (if equipped) or the back of the radiator core.

Check the engine cooling system hoses for brittle rubber, cracking, tears, cuts and tightness of the connection at the coolant recovery bottle and radiator. Inspect the entire system for leaks.

DO NOT REMOVE THE COOLANT PRESSURE CAP WHEN THE COOLING SYSTEM IS HOT.

Cooling System – Drain, Flush And Refill

NOTE:

Some vehicles require special tools to add coolant properly. Failure to fill these systems properly could lead to severe internal engine damage. If any coolant is needed to be added to the system please contact an authorized dealer.

If the engine coolant (antifreeze) is dirty or contains visible sediment, have an authorized dealer clean and flush with OAT coolant (conforming to MS.90032).

For the proper maintenance intervals ↪ page 371.

Selection Of Coolant

For further information ↪ page 449.

NOTE:

- Mixing of engine coolant (antifreeze) other than specified Organic Additive Technology (OAT) engine coolant, may result in engine damage and may decrease corrosion protection. OAT engine coolant is different and should not be mixed with Hybrid Organic Additive Technology (HOAT) engine coolant or any “globally compat-

ible” coolant. If a non-OAT engine coolant is introduced into the cooling system in an emergency, the cooling system will need to be drained, flushed, and refilled with fresh OAT coolant (conforming to MS.90032), by an authorized dealer as soon as possible.

- Do not use water alone or alcohol-based engine coolant products. Do not use additional rust inhibitors or anti-rust products, as they may not be compatible with the radiator engine coolant and may plug the radiator.
- This vehicle has not been designed for use with propylene glycol-based engine coolant. Use of propylene glycol-based engine coolant is not recommended.
- Some vehicles require special tools to add coolant properly. Failure to fill these systems properly could lead to severe internal engine damage. If any coolant is needed to be added to the system please contact an authorized dealer.

Adding Coolant

Your vehicle has been built with an improved engine coolant (OAT coolant conforming to MS.90032) that allows extended maintenance intervals. This engine coolant (antifreeze) can be used up to 10 years or 150,000 miles (240,000 km) before replacement.

To prevent reducing this extended maintenance period, it is important that you use the same engine coolant (OAT coolant conforming to MS.90032) throughout the life of your vehicle.

Please review these recommendations for using Organic Additive Technology (OAT) engine coolant that meets the requirements of the manufacturer Material Standard MS.90032. When adding engine coolant:

- We recommend using Mopar® Antifreeze/Coolant 10 Year/150,000 Mile (240,000 km) Formula OAT that meets the requirements of the manufacturer Material Standard MS.90032.
- Mix a minimum solution of 50% OAT engine coolant that meets the requirements of the manufacturer Material Standard MS.90032 and distilled water. Use higher concentrations (not to exceed 70%) if temperatures below -34 °F (-37 °C) are anticipated. Please contact an authorized dealer for assistance.
- Use only high purity water such as distilled or deionized water when mixing the water/engine coolant solution. The use of lower quality water will reduce the amount of corrosion protection in the engine cooling system.

398 SERVICING AND MAINTENANCE**NOTE:**

- It is the owner's responsibility to maintain the proper level of protection against freezing according to the temperatures occurring in the area where the vehicle is operated.
- Some vehicles require special tools to add coolant properly. Failure to fill these systems properly could lead to severe internal engine damage. If any coolant is needed to be added to the system, please contact an authorized dealer.
- Mixing engine coolant types is not recommended and can result in cooling system damage. If HOAT and OAT coolant are mixed in an emergency, have an authorized dealer drain, flush, and refill with OAT coolant (conforming to MS.90032) as soon as possible.

Cooling System Pressure Cap

The cap must be fully tightened to prevent loss of engine coolant (antifreeze), and to ensure that engine coolant will return to the radiator from the coolant expansion bottle/recovery tank (if equipped).

The cap should be inspected and cleaned if there is any accumulation of foreign material on the sealing surfaces.

WARNING!

- Do not open hot engine cooling system. Never add engine coolant (antifreeze) when the engine is overheated. Do not loosen or remove the cap to cool an overheated engine. Heat causes pressure to build up in the cooling system. To prevent scalding or injury, do not remove the pressure cap while the system is hot or under pressure.
- Do not use a pressure cap other than the one specified for your vehicle. Personal injury or engine damage may result.

Disposal Of Used Coolant

Used ethylene glycol-based coolant (antifreeze) is a regulated substance requiring proper disposal. Check with your local authorities to determine the disposal rules for your community. To prevent ingestion by animals or children, do not store ethylene glycol-based coolant in open containers or allow it to remain in puddles on the ground, clean up any ground spills immediately. If ingested, seek emergency assistance immediately.

Checking Coolant Level – 3.6L Engine

The level of the coolant in the pressurized coolant bottle should be between the "MIN" and "MAX" range on the bottle when the engine is cold.

The radiator normally remains completely full, so there is no need to remove the cap unless checking for coolant freeze point or replacing engine coolant (antifreeze). Advise your service attendant of this. As long as the engine operating temperature is satisfactory, the coolant bottle need only be checked once a month. When additional engine coolant is needed to maintain the proper level, it should be added to the coolant bottle. Do not overfill.

Checking Coolant Level – 5.7L Engines

With the engine off and cold, the level of the engine coolant should be between the ADD and SAFE range on the dipstick.

To check the coolant level:

1. Open the coolant reservoir.
2. Lift and remove the plastic dipstick from the reservoir neck.

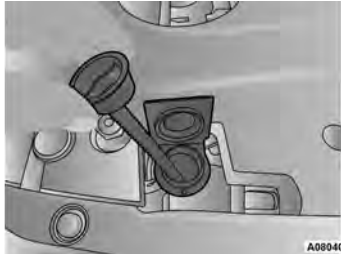

Coolant Reservoir Dipstick

3. Check the coolant level on the dipstick.

The radiator normally remains completely full, so there is no need to remove the radiator cap unless checking for engine coolant (antifreeze) freeze point or replacing engine coolant. Advise your service attendant of this. As long as the engine operating temperature is satisfactory, the coolant bottle need only be checked once a month.

When additional engine coolant is needed to maintain the proper level, it should be added to the coolant bottle. Do not overfill.

Cooling System Notes

NOTE:

When the vehicle is stopped after a few miles/kilometers of operation, you may observe vapor coming from the front of the engine compartment. This is normally a result of moisture from rain,

snow, or high humidity accumulating on the radiator and being vaporized when the thermostat opens, allowing hot engine coolant (antifreeze) to enter the radiator.

If an examination of your engine compartment shows no evidence of radiator or hose leaks, the vehicle may be safely driven. The vapor will soon dissipate.

- Do not overfill the coolant expansion bottle.
- Check the coolant freeze point in the radiator and in the coolant expansion bottle. If engine coolant needs to be added, the contents of the coolant expansion bottle must also be protected against freezing.
- If frequent engine coolant additions are required, the cooling system should be pressure tested for leaks.
- Maintain engine coolant concentration at a minimum of 50% OAT coolant (conforming to MS.90032) and distilled water for proper corrosion protection of your engine which contains aluminum components.
- Make sure that the coolant expansion bottle overflow hoses are not kinked or obstructed.
- Keep the front of the radiator clean. If your vehicle is equipped with air conditioning, keep the front of the condenser clean.

- Do not change the thermostat for Summer or Winter operation. If replacement is ever necessary, install ONLY the correct type thermostat. Other designs may result in unsatisfactory engine cooling performance, poor gas mileage, and increased emissions.

CHARGE AIR COOLER — INTER-COOLER (DIESEL ENGINE)

The charge air cooler is positioned in front of the radiator and the air conditioner condenser. Air enters the engine through the air cleaner and passes through the turbocharger, where it is pressurized. This pressurized air rapidly reaches high temperature. The air is then directed through a hose to the charge air cooler and through another hose to the intake manifold of the engine. This cooling process enables more efficient burning of fuel resulting in fewer emissions.

To guarantee optimum performance of the system, keep the surfaces of the charge air cooler, condenser and radiator clean and free of debris. Periodically check the hoses leading to and from the charge air cooler for cracks or loose clamps resulting in loss of pressure and reduced engine performance.

400 SERVICING AND MAINTENANCE

BRAKE SYSTEM

In order to ensure brake system performance, all brake system components should be inspected periodically ↪ page 371.

| WARNING! |
|--|
| Riding the brakes can lead to brake failure and possibly a collision. Driving with your foot resting or riding on the brake pedal can result in abnormally high brake temperatures, excessive lining wear, and possible brake damage. You would not have your full braking capacity in an emergency. |

Fluid Level Check — Brake Master Cylinder

The fluid level of the brake master cylinder should be checked whenever the vehicle is serviced, or immediately if the brake system warning light is on. If necessary, add fluid to bring level within the designated marks on the side of the reservoir of the brake master cylinder. Be sure to clean the top of the master cylinder area before removing cap. With disc brakes, fluid level can be expected to fall as the brake pads wear. Brake fluid level should be checked when pads are replaced. If the brake fluid is abnormally low, check the system for leaks ↪ page 454.

| WARNING! |
|--|
| <ul style="list-style-type: none"> ● Use only manufacturer's recommended brake fluid ↪ page 454. Using the wrong type of brake fluid can severely damage your brake system and/or impair its performance. The proper type of brake fluid for your vehicle is also identified on the original factory installed hydraulic master cylinder reservoir. ● To avoid contamination from foreign matter or moisture, use only new brake fluid or fluid that has been in a tightly closed container. Keep the master cylinder reservoir cap secured at all times. Brake fluid in a open container absorbs moisture from the air resulting in a lower boiling point. This may cause it to boil unexpectedly during hard or prolonged braking, resulting in sudden brake failure. This could result in a collision. ● Overfilling the brake fluid reservoir can result in spilling brake fluid on hot engine parts, causing the brake fluid to catch fire. Brake fluid can also damage painted and vinyl surfaces, care should be taken to avoid its contact with these surfaces. |

(Continued)

| WARNING! |
|---|
| <ul style="list-style-type: none"> ● Do not allow petroleum based fluid to contaminate the brake fluid. Brake seal components could be damaged, causing partial or complete brake failure. This could result in a collision. |

AUTOMATIC TRANSMISSION

Special Additives

The manufacturer strongly recommends against using any special additives in the transmission. Automatic Transmission Fluid (ATF) is an engineered product and its performance may be impaired by supplemental additives. Therefore, do not add any fluid additives to the transmission. Avoid using transmission sealers as they may adversely affect seals.

| CAUTION! |
|--|
| Do not use chemical flushes in your transmission as the chemicals can damage your transmission components. Such damage is not covered by the New Vehicle Limited Warranty. |

Fluid Level Check

The fluid level is preset at the factory and does not require adjustment under normal operating conditions. Routine fluid level checks are not required, therefore the transmission has no dipstick. An authorized dealer can check your transmission fluid level using special service tools.

If you notice fluid leakage or transmission malfunction, visit an authorized dealer immediately to have the transmission fluid level checked. Operating the vehicle with an improper fluid level can cause severe transmission damage.

CAUTION!

If a transmission fluid leak occurs, visit an authorized dealer immediately. Severe transmission damage may occur. An authorized dealer has the proper tools to adjust the fluid level accurately.

Fluid And Filter Changes

Under normal operating conditions, the fluid installed at the factory will provide satisfactory lubrication for the life of the vehicle.

Routine fluid and filter changes are not required. However, change the fluid and filter if the fluid becomes contaminated (with water, etc.), or if the transmission is disassembled for any reason.

Selection Of Lubricant

It is important to use the proper transmission fluid to ensure optimum transmission performance and life. Use only the manufacturer recommended transmission fluid ↗ page 454. It is important to maintain the transmission fluid at the correct level using the recommended fluid. No chemical flushes should be used in any transmission; only the approved lubricant should be used.

CAUTION!

Using a transmission fluid other than the manufacturer's recommended fluid may cause deterioration in transmission shift quality and/or torque converter shudder ↗ page 454.

REAR AXLE AND 4x4 FRONT DRIVING AXLE FLUID LEVEL

For normal service, periodic fluid level checks are not required. When the vehicle is serviced for other reasons the exterior surfaces of the axle assembly should be inspected. If gear oil leakage is suspected inspect the fluid level ↗ page 454. This inspection should be made with the vehicle in a level position.

The fluid level should be even with the bottom of the fill hole (within 1/4 in (6.4 mm) of edge of hole) for the front axle and rear axle.

Drain And Refill

For the proper maintenance intervals ↗ page 371.

Lubricant Selection

For further information ↗ page 454.

NOTE:

The presence of water in the gear lubricant will result in corrosion and possible failure of differential components. Operation of the vehicle in water, as may be encountered in some off-highway types of service, will require draining and refilling the axle to avoid damage.

Limited-Slip Differentials

Rear axles equipped with a Limited Slip Differential require that 5 oz. (148 ml) Mopar® Limited Slip Additive be added to the gear lubricant ↗ page 454. The Mopar® Limited Slip Additive should be added to the gear lubricant whenever a fluid change is made to an axle equipped with a Limited Slip Differential.

NOTE:

When refilling a limited slip differential axle which requires a friction modification additive, the additive should be added before the gear lubricant to ensure proper additive fill.

402 SERVICING AND MAINTENANCE

TRANSFER CASE

Fluid Level Check

This fluid level can be checked by removing the filler plug. The fluid level should be to the bottom edge of the filler plug hole (or within 1/8 inch of the bottom) with the vehicle in a level position.

Drain And Refill

For the proper maintenance intervals ⇨ page 371.

Selection Of Lubricant

Use only the manufacturer recommended fluid ⇨ page 454.

FUSES

General Information

| WARNING! |
|---|
| <ul style="list-style-type: none"> When replacing a blown fuse, always use an appropriate replacement fuse with the same amp rating as the original fuse. Never replace a fuse with another fuse of higher amp rating. Never replace a blown fuse with metal wires or any other material. Do not place a fuse inside a circuit breaker cavity or vice versa. Failure to use proper fuses may result in serious personal injury, fire and/or property damage. |

(Continued)

| WARNING! |
|---|
| <ul style="list-style-type: none"> Before replacing a fuse, make sure that the ignition is off and that all the other services are switched off and/or disengaged. If the replaced fuse blows again, contact an authorized dealer. If a general protection fuse for safety systems (air bag system, braking system), power unit systems (engine system, transmission system) or steering system blows, contact an authorized dealer. |

| CAUTION! |
|---|
| <p>If it is necessary to wash the engine compartment, take care not to directly hit the fuse box, and the windshield wiper motors with water.</p> |

The fuses protect electrical systems against excessive current.

When a device does not work, you must check the fuse element inside the blade fuse for a break/melt.

Also, please be aware that when using power outlets for extended periods of time with the engine off may result in vehicle battery discharge.

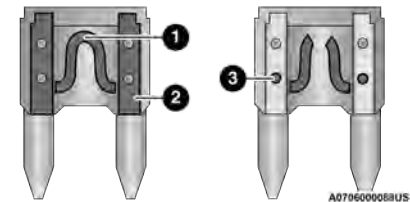

Blade Fuses

- 1 – Fuse Element
- 2 – Blade Fuse with a good/functional fuse element
- 3 – Blade fuse with a bad/not functional fuse element (blown fuse)

External Power Distribution Center

The Power Distribution Center is located in the engine compartment near the battery. This center contains cartridge fuses, micro fuses, relays, and circuit breakers. A description of each fuse and component may be stamped on the inside cover, otherwise the cavity number of each fuse is stamped on the inside cover that corresponds to the following chart.

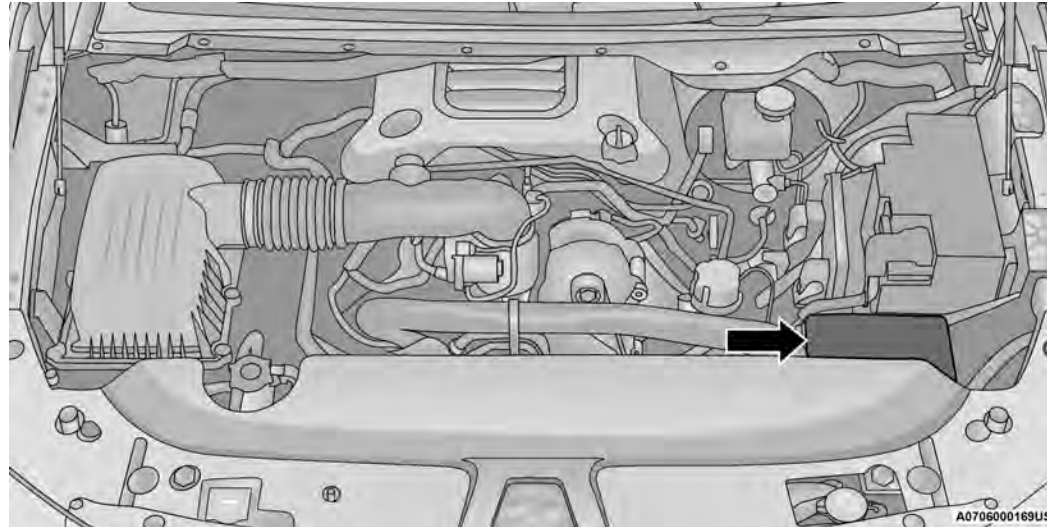

Underhood Power Distribution Center

404 SERVICING AND MAINTENANCE

| Cavity | Cartridge Fuse | Micro Fuse | Description |
|----------------------|----------------|---------------|--|
| * If Equipped | | | |
| F01 | - | 25 Amp Clear | Fuel Pump Motor |
| F02 | - | - | Spare |
| F03 | - | 5 Amp Tan | MGU * |
| F04 | - | - | Spare |
| F05 | - | - | Spare |
| F06 | - | 10 Amp Red | OUTPUT TO UPFITTER PDC * |
| F07 | - | - | Spare |
| F08 | 20 Amp Blue | - | Trailer Tow Backup |
| F09 | - | 20 Amp Yellow | Trailer Stop / Turn Lamp Left |
| F10 | - | 20 Amp Yellow | Trailer Stop / Turn Lamp Right |
| F11 | - | 15 Amp Blue | ID/CLEARANCE LIGHTS * |
| F12 | 20 Amp Blue | - | Trailer Tow Park Lamp |
| F13 | - | - | Spare |
| F14 | - | 10 Amp Red | AC Clutch |
| F15 | - | 5 Amp Tan | Intelligent Battery Sensor (IBS) |
| F16 | - | - | Spare |
| F17 | - | 20 Amp Yellow | Air Suspension |
| F18 | - | 15 Amp Blue | AGS / Rear Axle Cooling Valve / Active Air Dam |
| F19 | - | - | Spare |
| F20 | - | 20 Amp Yellow | Adjustable Pedals * |

| Cavity | Cartridge Fuse | Micro Fuse | Description |
|----------------------|----------------|---------------|--|
| * If Equipped | | | |
| F21 | 30 Amp Pink | - | Power Side Step * |
| F22 | 50 Amp Red | - | Air Module * |
| F23 | - | - | Spare |
| F24 | - | 20 Amp Yellow | TCM SBW |
| F25 | 40 Amp Green | - | MOD CBC 4 Exterior Lights 2 |
| F26 | 50 Amp Red | - | ESP Module |
| F27 | 30 Amp Pink | - | Front Wiper |
| F28 | - | 10 Amp Red | PCM / ECM |
| F29 | 40 Amp Green | - | ESP Module |
| F30 | - | - | Spare |
| F31 | - | - | Spare |
| F32 | 20 Amp Blue | - | ECM / PCM |
| F33 | 30 Amp Pink | - | Brake Vacuum Pump |
| F34 | - | - | Spare |
| F35 | - | 10 Amp Red | PCM / ECM / Power Pack Unit (PPU) Motor Generator Unit (MGU) Wake Up * / EPS / ESP |
| F36 | - | - | Spare |
| F37 | - | 5 Amp Tan | R / S Output to iPDC |
| F38 | - | 10 Amp Red | DTCM / Active CL TEMP VLV |
| F39 | - | 15 Amp Blue | MOD ATMM * |

406 SERVICING AND MAINTENANCE

| Cavity | Cartridge Fuse | Micro Fuse | Description |
|----------------------|----------------|---------------------------|---------------------------------|
| * If Equipped | | | |
| F40 | 40 Amp Green | - | Starter |
| F41 | - | 10 Amp Red | IRCAM Heaters |
| F42 | 20 Amp Blue | - | AUX SWITCH #5 * |
| F43 | - | 20 Amp Yellow | MGU Coolant Pump / ADCM * |
| F44 | - | 10 Amp Red | Trailer Camera * |
| F45 | - | 10 Amp Red | ADCM * |
| F46 | 30 Amp Pink | - | Fuel Heater * |
| F47 | 30 Amp Pink | - | Rear Defroster |
| F48 | - | - | Spare |
| F49 | 30 Amp Pink | - | Htr Ctrl * |
| F50 | 20 Amp Blue | - | AUX SWITCH #6 * |
| F51 | 25 Amp White | - | FUEL PUMP MOTOR #1 * |
| F52 | - | - | Spare |
| F53 | - | 10 Amp Red | Supply / Purging Pump * |
| F54 | - | 15 Amp Blue 10 Amp Red | PCM * Vapor Blocking Valve * |
| F55 | - | - | Spare |
| F56 | - | - | Spare |

| Cavity | Cartridge Fuse | Micro Fuse | Description |
|----------------------|-----------------------------|---------------|--|
| * If Equipped | | | |
| F57 | - | 20 Amp Yellow | Horn |
| F58 | 25 Amp White | - | FUEL PUMP MOTOR #2 * |
| F59 | - | 25 Amp Clear | Injectors / IGN Coil / Glow Plug Module * |
| F60 | - | 20 Amp Yellow | ECM / PCM / ACT Short Running Valve / LTR Coolant Pump * |
| F61 | - | - | Spare |
| F62 | 60 Amp Blue 40 Amp Green | - | Glow Plug * LTR Coolant Pump * |
| F63 | 20 Amp Blue | - | NOx Sensor * |
| F64 | - | 10 Amp Red | PM Sensor * |

CAUTION!

- When installing the power distribution center cover, it is important to ensure the cover is properly positioned and fully latched. Failure to do so may allow water to get into the power distribution center and possibly result in an electrical system failure.
- When replacing a blown fuse, it is important to use only a fuse having the correct amperage rating. The use of a fuse with a rating other than indicated may result in a dangerous electrical system overload. If a properly rated fuse continues to blow, it indicates a problem in the circuit that must be corrected.

408 SERVICING AND MAINTENANCE**Internal Power Distribution Center**

The Power Distribution Center is located under the driver's side instrument panel. This center contains cartridge fuses, micro fuses, relays, and circuit breakers. A description of each fuse and component may be stamped on the inside cover, otherwise the cavity number of each fuse is stamped on the inside cover that corresponds to the following chart.

| Cavity | Cartridge Fuse | Micro Fuse | Description |
|----------------------|----------------|---------------|--|
| * If Equipped | | | |
| F01 | 30 Amp Pink | - | Trailer Tow Receptacle |
| F03 | - | 20 Amp Yellow | Module Seat Heater Front (Pass) |
| F04 | - | - | Spare |
| F05 | - | 20 Amp Yellow | Module PPU Cooling Fan * |
| F06 | - | - | Spare |
| F07 | 40 Amp Green | - | Mod CBC 3 PWR Locks |
| F08 | - | - | Spare |
| F09 | - | - | Spare |
| F10 | 40 Amp Green | - | HVAC Blower Motor |
| F11 | - | 5 Amp Tan | Output to Under-hood Power Distribution Center (UPDC) Run Coil |
| F12 | - | 25 Amp Clear | Mod Audio Amplifier / Active Noise Cancellation |
| F13 | - | 20 Amp Yellow | Mod Seat Heater Front (Driver) |
| F14 | - | 15 Amp Blue | Mod Seat Heater Front (Steering Wheel) |
| F15 | - | - | Spare |
| F16 | - | - | Spare |
| F17 | - | 20 Amp Yellow | LT Spot Lamp * |
| F18 | 30 Amp Pink | - | Motor Sunshade Sunroof |

| Cavity | Cartridge Fuse | Micro Fuse | Description |
|----------------------|----------------|---------------|--|
| * If Equipped | | | |
| F19 | - | - | Spare |
| F20 | - | 20 Amp Yellow | Comfort Rear Seat Module (CRSM) (Heat Rear RT) |
| F21 | - | - | Spare |
| F22 | - | - | Spare |
| F23 | - | - | Spare |
| F24 | - | 15 Amp Blue | Mod RF Hub / Mod Ignition / Mod Cluster CNN |
| F25 | 40 Amp Green | - | Mod Integrated Trailer Brake |
| F26 | - | 15 Amp Blue | Mod Cluster CCN / Mod Cyber Security / Trailer Gateway Module (360 Camera) |
| F27 | - | 5 Amp Tan | Mod Cluster CCN / Mod SGW |
| F28 | - | 10 Amp Red | Mod ORC |
| F29 | - | 20 Amp Yellow | Mod CRSM (Heat Rear LT) |
| F30 | 30 Amp Pink | - | Mod DTCM / Mod Tailgate |
| F31 | 30 Amp Pink | - | Mod CBC 1 Interior Light |
| F32 | - | 20 Amp Yellow | RT Spot Lamp * |
| F33 | - | 10 Amp Red | Assy Overhead Console / Switch 911 / Switch Assist / Sunshade / HUD |
| F34 | - | 15 Amp Blue | Frt & RR Ventilated Seat Motor |
| F35 | - | 10 Amp Red | Mod Inverter / Mtr Sunshade Sunroof / Mtr Dual Sunroof / USB Charge Only |
| F36 | 40 Amp Green | - | Mod CBC 2 Exterior Light 1 |

410 SERVICING AND MAINTENANCE

| Cavity | Cartridge Fuse | Micro Fuse | Description |
|----------------------|----------------|---------------|---|
| * If Equipped | | | |
| F37 | - | - | Spare |
| F38 | - | - | Spare |
| F39 | - | - | Spare |
| F40 | 20 Amp Blue | - | Dome Pursuit Vehicle * |
| F41 A&B | - | 15 Amp Blue | Lumbar Support & Pass SW / Steering Column Control Module / HVAC Control Module / ICS Switch Bank / Upper Switch Bank |
| F42 A&B | - | 10 Amp Red | Mod Transfer Case Switch Module (TCSM) / SBW / Electric Park Brake SW / Module TPM Trailer / Module Gateway Can-C Trailer TPM / Seat LT & RT Vent |
| F43 A&B | - | 10 Amp Red | Port Diagnostics / Front & Rear USB |
| F44 | - | 20 Amp Yellow | Radio / DCSD / Telematics Box Mod / Trailer Gateway Module (360) |
| F45 | 30 Amp Pink | - | Mod Door MUX Driver |
| F46 | 30 Amp Pink | - | Mod Door MUX Passenger |
| F47 | - | - | Spare |
| F48A | - | 10 Amp Red | Rear View Mirror / SW Window Passenger / Rear USB / Wireless Charging Pad Mod |
| F49 | - | 15 Amp Blue | Mod CVPM / SNSR Blind Spot / HDLP Adaptive Front Lighting Sensor (AFLS) |
| F50A | - | 10 Amp Red | Battery PACK Control Mod * |
| F51 A&B | - | - | Spare |

| Cavity | Cartridge Fuse | Micro Fuse | Description |
|----------------------|----------------|---------------|--|
| * If Equipped | | | |
| F52 | 20 Amp Blue | - | Direct Battery Feed * |
| F53 | - | 10 Amp Red | Trailer Reverse Steering Control / Trailer Steering Control Knob |
| F54A & F54B | - | 20 Amp Yellow | Power Outlet Center Seat Battery Fed Position Power Outlet Center Seat Ignition Fed Position |
| F55 | 25 Amp White | - | Upfitter * |
| F56 | 30 Amp Pink | - | Mod Network Interface * |
| F57 | 20 Amp Blue | - | Direct Battery Feed * |
| F58 | 20 Amp Blue | - | Direct Battery Feed * |
| F60 | 50 Amp Red | - | Mod Inverter |
| F61 | - | - | Spare |
| F62 A&B | - | 10 Amp Red | ITBM / Mod Occupant Class / Mod IAIR Suspension / Mod HVAC / Snr In car Temp / Integrated Radar Camera Mod (IRCM) / Humidity Rain & Light Sensor (HRLS) / Parktronics System Mod (PTS) / Gateway Can-C Trailer TPM Mod |

412 SERVICING AND MAINTENANCE

| Cavity | Cartridge Fuse | Micro Fuse | Description |
|----------------------|----------------|------------|----------------------|
| * If Equipped | | | |
| F63 | - | - | Spare |
| F64 | - | - | Spare |
| F65 | - | 10 Amp Red | Mod ORC |
| F66 | - | 10 Amp Red | Run - Accessory Feed |

Circuit Breakers

| Cavity | Circuit Breaker | Description |
|--------|-----------------|--|
| CB1 | 25 Amp | Driver Window SW Rear PWR Windows / Overhead SW Rear Defrost |
| CB2 | 25 Amp | Driver PWR Seat / Driver Seat Memory Mod |
| CB3 | 25 Amp | Passenger Power Seat / Passenger Seat Memory Mod |

BULB REPLACEMENT**Replacement Bulbs, Names, And Part Numbers**

In the instance a bulb needs to be replaced, this section includes bulb description and replacement part numbers. All of the inside bulbs are brass or glass-wedge base. Aluminum base bulbs are not approved.

NOTE:

See an authorized dealer for LED bulb replacement.

| Interior Bulbs | |
|--|-------------|
| Bulb Name | Bulb Number |
| Overhead Console Lamps | TS 212-9 |
| Dome Lamp | 7679 |
| NOTE: For lighted switches, see an authorized dealer for replacement instructions. | |

| Exterior Bulbs | |
|--|--|
| Bulb Name | Bulb Number |
| Low Beam (Halogen Reflector Headlamp) | H11LL |
| High Beam (Halogen Reflector Headlamp) | 9005LL |
| Low & High Beam (LED Reflector Headlamp) | LED (Serviced at an authorized dealer) |
| Low & High Beam (LED Projector Headlamp) | LED (Serviced at an authorized dealer) |

414 SERVICING AND MAINTENANCE

| Exterior Bulbs | |
|---|--|
| Bulb Name | Bulb Number |
| Turn Signal / Front Position (Halogen Reflector Headlamp) | 7444NA |
| Turn Signal / Front Position (LED Headlamps) | LED (Serviced at an authorized dealer) |
| Front Side Marker (Halogen Reflector Headlamp) | W5W |
| Front Side Marker (LED Headlamps) | LED (Serviced at an authorized dealer) |
| Front Fog Lamps (Halogen Reflector Headlamp) | H11LL |
| Front Fog Lamps (LED Headlamps) | LED (Serviced at an authorized dealer) |
| Side Indicators (Front And Side View Mirror) | LED (Serviced at an authorized dealer) |
| Base Rear Tail/Turn and Stop Lamp | 7440LL/W21WLL |
| Premium Rear Tail/Turn/Backup and Stop Lamp | LED (Serviced at an authorized dealer) |
| Base Backup Lamp | 7440/W21W |
| Center High Mounted Stop Lamp (CHMSL) | 921 |
| Cargo Lamp | 921 |
| Rear License Plate Lamp | LED (Serviced at an authorized dealer) |
| Base Turn Lamp | 7440NA / WY21W |

Replacing Exterior Bulbs

BASE QUAD: LOW BEAM HEADLAMP, HIGH BEAM HEADLAMP, FRONT PARK AND TURN — IF EQUIPPED

Low Beam

See below steps to replace:

1. Open the hood.
2. Disconnect and isolate the negative battery cable.
3. Locate the low beam access cover, which can be found on the back side of the headlamps.

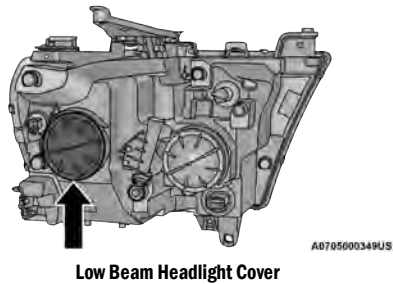

NOTE:

It may be necessary to remove/reposition Air Cleaner Assembly to access passenger side headlamp/side marker light bulbs.

4. Disengage the bulb access cover by rotating counterclockwise.
5. Disconnect the internal lamp wiring harness connector from the low beam bulb.

CAUTION!

- Do not contaminate the bulb glass by touching it with your fingers or by allowing it to contact other oily surfaces. Shortened bulb life will result.
- Always use the correct bulb size and type for replacement. An incorrect bulb size or type may overheat and cause damage to the lamp, the bulb socket, or the lamp wiring.

6. Rotate the bulb counterclockwise a quarter turn to unlock the bulb from the lamp.
7. Pull the bulb straight out from the housing.
8. Reverse the procedure for installation of new bulb and covers.

High Beam

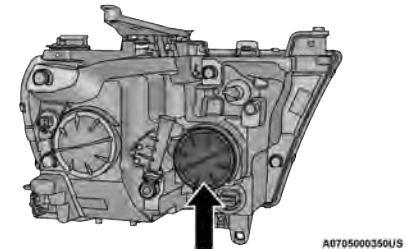

See below steps to replace:

1. Open the hood.
2. Disconnect and isolate the negative battery cable.
3. Locate the high beam access cover, which can be found on the back side of the headlamps.

NOTE:

It may be necessary to remove/reposition Air Cleaner Assembly to access passenger side headlamp/side marker light bulbs.

416 SERVICING AND MAINTENANCE

4. Reach behind the headlamp and disengage the access cover by rotating counterclockwise.
5. Disconnect the internal lamp wiring harness connector from the high beam bulb.

CAUTION!

- Do not contaminate the bulb glass by touching it with your fingers or by allowing it to contact other oily surfaces. Shortened bulb life will result.
- Always use the correct bulb size and type for replacement. An incorrect bulb size or type may overheat and cause damage to the lamp, the bulb socket, or the lamp wiring.

6. Rotate the bulb counterclockwise a quarter turn to unlock the bulb from the lamp.
7. Pull the bulb straight out from the housing.
8. Reverse the procedure for installation of new bulb and cover.

Front Park And Turn

See below steps to replace:

1. Open the hood.
2. Disconnect and isolate the negative battery cable.
3. Locate the park and turn socket, which can be found on the back side of the headlamps.

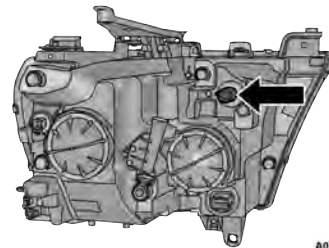

A0705000354US

Park And Turn Socket

4. Reach behind the headlamp and unlock the park and turn socket from the lamp by rotating counterclockwise a quarter turn.
5. Pull the bulb straight out from the housing.
6. Separate the bulb from the socket without twisting.
7. Reverse the procedure for installation of new bulb and covers.

Side Marker Lamp

See below steps to replace:

1. Open the hood.
2. Disconnect and isolate the negative battery cable.
3. Locate the side marker lamp, which can be found on the back side of the headlamps.

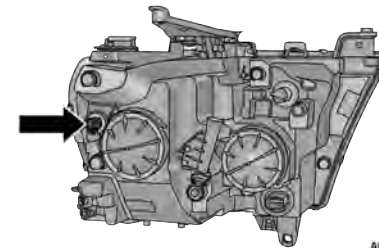

A0705000352US

Side Marker Lamp

4. Disengage the side marker socket by rotating counterclockwise a quarter turn.
5. Pull the socket and bulb straight out from the housing.
6. Separate the bulb from the socket without twisting.
7. Reverse the procedure for installation of new bulb and covers.

FOG LAMPS – IF EQUIPPED

Please see an authorized dealer for service on LED and Halogen front fog lamps.

Halogen

See below steps to replace:

1. Reach under and behind the front fascia/ bumper to access the back of the front fog lamp housing.
2. Disconnect the fog lamp wiring harness connector from the fog lamp bulb.

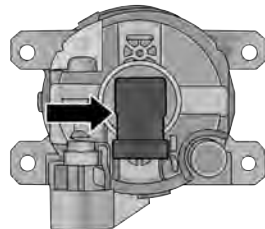

A0705000443US

Fog Lamp Bulb

3. Rotate the bulb counterclockwise a quarter turn to unlock the bulb from the housing.
4. Pull the bulb straight out from the housing.
5. Reverse the procedure to install the bulb and cover.

CAUTION!

Do not contaminate the bulb glass by touching it with your fingers or by allowing it to contact other oily surfaces. Shortened bulb life will result.

REAR TAIL/STOP, TURN SIGNAL AND BACKUP LAMPS

See below steps to replace:

1. Remove the two screws and push pin retainers that pass through the bed sheet metal.

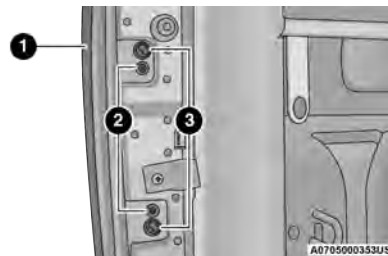

A0705000353US

Tail Lamp Locations

- 1 – Tail Lamp
- 2 – Fasteners
- 3 – Push - Pin Retainers

2. Pull the outboard side of the lamp rearward far enough to unsnap the two receptacles on the outboard side of the lamp housing from the two plastic snap post retainers in the outer box side panel.

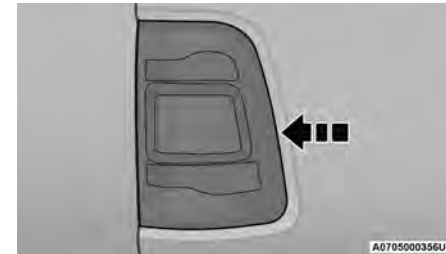

A0705000356US

Tail Lamp Removal

3. Disconnect the wiring harness connectors from the bulb socket.

418 SERVICING AND MAINTENANCE

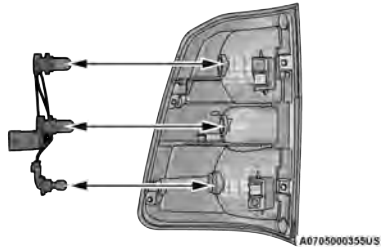

Wiring Harness Connector

4. Rotate the bulb socket counterclockwise a quarter turn to unlock it from the housing.
5. Pull the bulb straight out of the socket.

CAUTION!

Do not contaminate the bulb glass by touching it with your fingers or by allowing it to contact other oily surfaces. Shortened bulb life will result.

6. Reverse the procedure to install the bulb and housing.

CENTER HIGH MOUNTED STOP LAMP (CHMSL) WITH CARGO LAMP

See below steps to replace:

1. Remove the four screws holding the housing/lens to the body as shown.



CHMSL Mounting Screw Locations

2. Separate the connector holding the housing and wiring harness to the body.

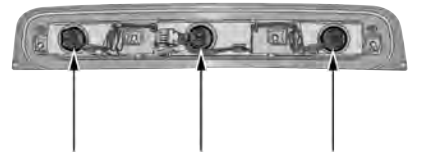

CHMSL Bulb Location

3. Turn the desired bulb socket a quarter turn counterclockwise and remove the socket and bulb from housing.
4. Pull the desired bulb straight from the socket.

CAUTION!

Do not contaminate the bulb glass by touching it with your fingers or by allowing it to contract other oily surfaces. Shortened bulb life will result.

- Outside Bulbs: Cargo Lamps
 - Inside Bulb: Center High Mounted Stop Lamp
5. Reverse the procedure for installation of bulbs and housing.

TIRES

TIRE SAFETY INFORMATION

Tire safety information will cover aspects of the following information: Tire Markings, Tire Identification Numbers, Tire Terminology and Definitions, Tire Pressures, and Tire Loading.

Tire Markings

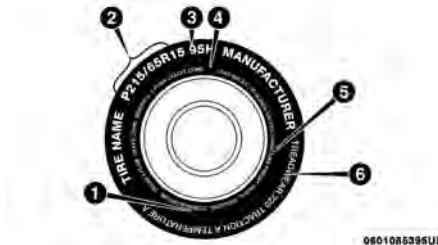

Tire Markings

- 1 – US DOT Safety Standards Code (TIN)
- 2 – Size Designation
- 3 – Service Description
- 4 – Maximum Load
- 5 – Maximum Pressure
- 6 – Treadwear, Traction and Temperature Grades

NOTE:

- P (Passenger) – Metric tire sizing is based on US design standards. P-Metric tires have the letter “P” molded into the sidewall preceding the size designation. Example: P215/65R15 95H.
- European – Metric tire sizing is based on European design standards. Tires designed to this standard have the tire size molded into the sidewall beginning with the section width. The letter “P” is absent from this tire size designation. Example: 215/65R15 96H.
- LT (Light Truck) – Metric tire sizing is based on US design standards. The size designation for LT-Metric tires is the same as for P-Metric tires except for the letters “LT” that are molded into the sidewall preceding the size designation. Example: LT235/85R16.
- Temporary spare tires are designed for temporary emergency use only. Temporary high pressure compact spare tires have the letter “T” or “S” molded into the sidewall preceding the size designation. Example: T145/80D18 103M.
- High flotation tire sizing is based on US design standards and it begins with the tire diameter molded into the sidewall. Example: 31x10.5 R15 LT.

420 SERVICING AND MAINTENANCE

TIRE SIZING CHART

| EXAMPLE: |
|--|
| Example Size Designation: P215/65R15XL 95H, 215/65R15 96H, LT235/85R16C, T145/80D18 103M, 31x10.5 R15 LT |
| P = Passenger car tire size based on US design standards, or |
| "....blank...." = Passenger car tire based on European design standards, or |
| LT = Light truck tire based on US design standards, or |
| T or S = Temporary spare tire or |
| 31 = Overall diameter in inches (in) |
| 215, 235, 145 = Section width in millimeters (mm) |
| 65, 85, 80 = Aspect ratio in percent (%) |
| <ul style="list-style-type: none"> ● Ratio of section height to section width of tire, or |
| 10.5 = Section width in inches (in) |
| R = Construction code |
| <ul style="list-style-type: none"> ● "R" means radial construction, or ● "D" means diagonal or bias construction |
| 15, 16, 18 = Rim diameter in inches (in) |

| EXAMPLE: |
|---|
| Service Description: |
| 95 = Load Index <ul style="list-style-type: none">● A numerical code associated with the maximum load a tire can carry |
| H = Speed Symbol <ul style="list-style-type: none">● A symbol indicating the range of speeds at which a tire can carry a load corresponding to its load index under certain operating conditions● The maximum speed corresponding to the speed symbol should only be achieved under specified operating conditions (i.e., tire pressure, vehicle loading, road conditions, and posted speed limits) |
| Load Identification: Absence of the following load identification symbols on the sidewall of the tire indicates a Standard Load (SL) tire: <ul style="list-style-type: none">● XL = Extra load (or reinforced) tire, or● LL = Light load tire or● C, D, E, F, G = Load range associated with the maximum load a tire can carry at a specified pressure |
| Maximum Load - Maximum load indicates the maximum load this tire is designed to carry |
| Maximum Pressure - Maximum pressure indicates the maximum permissible cold tire inflation pressure for this tire |

422 SERVICING AND MAINTENANCE**Tire Identification Number (TIN)**

The Tire Identification Number (TIN) may be found on one or both sides of the tire; however, the date code may only be on one side. Tires with white sidewalls will have the full TIN, including the date code, located on the white sidewall side of the tire. Look for the TIN on the outboard side of black sidewall tires as mounted on the vehicle. If the TIN is not found on the outboard side, then you will find it on the inboard side of the tire.

| EXAMPLE: |
|--|
| DOT MA L9 ABCD 0301 |
| DOT = Department of Transportation <ul style="list-style-type: none"> ● This symbol certifies that the tire is in compliance with the US Department of Transportation tire safety standards and is approved for highway use |
| MA = Code representing the tire manufacturing location (two digits) |
| L9 = Code representing the tire size (two digits) |
| ABCD = Code used by the tire manufacturer (one to four digits) |
| 03 = Number representing the week in which the tire was manufactured (two digits) <ul style="list-style-type: none"> ● 03 means the 3rd week |
| 01 = Number representing the year in which the tire was manufactured (two digits) <ul style="list-style-type: none"> ● 01 means the year 2001 ● Prior to July 2000, tire manufacturers were only required to have one number to represent the year in which the tire was manufactured. Example: 031 could represent the 3rd week of 1981 or 1991 |

Tire Terminology And Definitions

| Term | Definition |
|---|--|
| B-pillar | The vehicle B-pillar is the structural member of the body located behind the front door. |
| Cold Tire Inflation Pressure | Cold tire inflation pressure is defined as the tire pressure after the vehicle has not been driven for at least three hours, or driven less than 1 mile (1.6 km) after sitting for a minimum of three hours. Inflation pressure is measured in units of PSI (pounds per square inch) or kPa (kilopascals). |
| Maximum Inflation Pressure | The maximum inflation pressure is the maximum permissible cold tire inflation pressure for this tire. The maximum inflation pressure is molded into the sidewall. |
| Recommended Cold Tire Inflation Pressure | The manufacturer's recommended cold tire inflation pressure as shown on the tire placard. |
| Tire Placard | A label permanently attached to the vehicle describing the vehicle's loading capacity, the original equipment tire sizes and the recommended cold tire inflation pressures. |

424 SERVICING AND MAINTENANCE

Tire Loading And Tire Pressure

NOTE:

The proper cold tire inflation pressure is listed on the driver's side B-pillar or the rear edge of the driver's side door.

Check the inflation pressure of each tire, including the spare tire (if equipped), at least monthly and inflate to the recommended pressure for your vehicle.

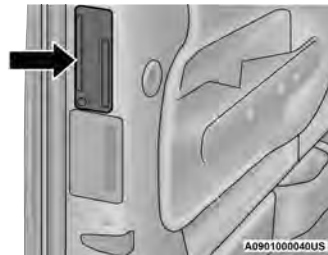

Example Tire Placard Location (Door)

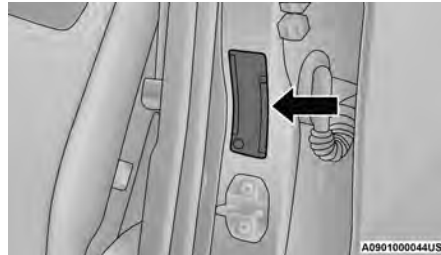

Example Tire Placard Location (B-pillar)

Tire And Loading Information Placard

| TIRE AND LOADING INFORMATION | | | |
|---|---------------|---------------|---------------|
| SEATING CAPACITY - TOTAL 5 FRONT 2 REAR 3 | | | |
| THE COMBINED WEIGHT OF OCCUPANTS AND CARGO SHOULD NEVER EXCEED XXXX KG, GROSS WEIGHT LESS | | | |
| TIRE | FRONT | REAR | SPARE |
| ORIGINAL TIRE SIZE | P195/70R14 | P195/70R14 | T125/70D15 |
| COLD TIRE INFLATION PRESSURE | 200kPa, 29PSI | 200kPa, 29PSI | 420kPa, 60PSI |

SEE OWNER'S MANUAL FOR ADDITIONAL INFORMATION

Tire And Loading Information Placard

This placard tells you important information about the:

1. Number of people that can be carried in the vehicle.
2. Total weight your vehicle can carry.
3. Tire size designed for your vehicle.
4. Cold tire inflation pressures for the front, rear, and spare tires.

Loading

The vehicle maximum load on the tire must not exceed the load carrying capacity of the tire on your vehicle. You will not exceed the tire's load carrying capacity if you adhere to the loading conditions, tire size, and cold tire inflation pressures specified on the Tire and Loading Information placard in Vehicle Loading page 213.

NOTE:

Under a maximum loaded vehicle condition, Gross Axle Weight Rating (GAWR) for the front and rear axles must not be exceeded.

For further information on GAWR, vehicle loading, and trailer towing → page 213.

To determine the maximum loading conditions of your vehicle, locate the statement “The combined weight of occupants and cargo should never exceed XXX kg or XXX lbs” on the Tire and Loading Information placard. The combined weight of occupants, cargo/luggage and trailer tongue weight (if applicable) should never exceed the weight referenced here.

Steps For Determining Correct Load Limit—

- (1) Locate the statement “The combined weight of occupants and cargo should never exceed XXX kg or XXX lbs.” on your vehicle's placard.
- (2) Determine the combined weight of the driver and passengers that will be riding in your vehicle.
- (3) Subtract the combined weight of the driver and passengers from XXX kg or XXX lbs.

(4) The resulting figure equals the available amount of cargo and luggage load capacity. For example, if “XXX” amount equals 1400 lbs. and there will be five 150 lb passengers in your vehicle, the amount of available cargo and luggage load capacity is 650 lbs. $(1400 - 750 (5 \times 150) = 650 \text{ lbs.})$

(5) Determine the combined weight of luggage and cargo being loaded on the vehicle. That weight may not safely exceed the available cargo and luggage load capacity calculated in Step 4.

(6) If your vehicle will be towing a trailer, load from your trailer will be transferred to your vehicle. Consult this manual to determine how this reduces the available cargo and luggage load capacity of your vehicle.

Metric Example For Load Limit

For example, if “XXX” amount equals 635 kg and there will be five 68 kg passengers in your vehicle, the amount of available cargo and luggage load capacity is 295 kg $(635 - 340 (5 \times 68) = 295 \text{ kg})$ as shown in step 4.

NOTE:

- If your vehicle will be towing a trailer, load from your trailer will be transferred to your vehicle. The following table shows examples on how to calculate total load, cargo/luggage, and towing capacities of your vehicle with varying seating configurations and number and size of occupants. This table is for illustration purposes only and may not be accurate for the seating and load carry capacity of your vehicle.
- For the following example, the combined weight of occupants and cargo should never exceed 865 lbs (392 kg).

426 SERVICING AND MAINTENANCE

| Occupants | | | Combined weight of occupants and cargo from Tire Placard | MINUS | Combined Occupant's weight | = | AVAILABLE Cargo/Luggage and Trailer Tongue Weight |
|------------------|-------|------|--|-------|----------------------------|---|---|
| TOTAL | FRONT | REAR | | | | | |
| EXAMPLE 1 | | | 865 lbs | minus | 670 lbs | = | 195 lbs |
| 5 | 2 | 3 | | | | | |
| EXAMPLE 2 | | | 865 lbs | minus | 540 lbs | = | 325 lbs |
| 3 | 2 | 1 | | | | | |
| EXAMPLE 3 | | | 865 lbs | minus | 400 lbs | = | 465 lbs |
| 2 | 2 | 0 | | | | | |

EXAMPLE

Occupant 1: 200 lbs
 Occupant 2: 130 lbs
 Occupant 3: 160 lbs
 Occupant 4: 100 lbs
 Occupant 5: 80 lbs
 TOTAL WEIGHT: 670 lbs

Occupant 1: 210 lbs
 Occupant 2: 130 lbs
 Occupant 3: 150 lbs
 TOTAL WEIGHT: 540 lbs

Occupant 1: 200 lbs
 Occupant 2: 200 lbs
 TOTAL WEIGHT: 400 lbs

811a4d11

WARNING!

Overloading of your tires is dangerous. Overloading can cause tire failure, affect vehicle handling, and increase your stopping distance. Use tires of the recommended load capacity for your vehicle. Never overload them.

TIRES — GENERAL INFORMATION

Tire Pressure

Proper tire inflation pressure is essential to the safe and satisfactory operation of your vehicle. Four primary areas are affected by improper tire pressure:

- Safety
- Fuel Economy
- Tread Wear
- Ride Comfort and Vehicle Stability

Safety

| WARNING! |
|---|
| <ul style="list-style-type: none"> ● Improperly inflated tires are dangerous and can cause collisions. ● Underinflation increases tire flexing and can result in overheating and tire failure. ● Overinflation reduces a tire's ability to cushion shock. Objects on the road and chuckholes can cause damage that result in tire failure. ● Overinflated or underinflated tires can affect vehicle handling and can fail suddenly, resulting in loss of vehicle control. |

(Continued)

| WARNING! |
|---|
| <ul style="list-style-type: none"> ● Unequal tire pressures can cause steering problems. You could lose control of your vehicle. ● Unequal tire pressures from one side of the vehicle to the other can cause the vehicle to drift to the right or left. ● Always drive with each tire inflated to the recommended cold tire inflation pressure. |

Both underinflation and overinflation affect the stability of the vehicle and can produce a feeling of sluggish response or over responsiveness in the steering.

NOTE:

- Unequal tire pressures from side to side may cause erratic and unpredictable steering response.
- Unequal tire pressure from side to side may cause the vehicle to drift left or right.

Fuel Economy

Underinflated tires will increase tire rolling resistance resulting in higher fuel consumption.

Tread Wear

Improper cold tire inflation pressures can cause abnormal wear patterns and reduced tread life, resulting in the need for earlier tire replacement.

Ride Comfort And Vehicle Stability

Proper tire inflation contributes to a comfortable ride. Overinflation produces a jarring and uncomfortable ride.

Tire Inflation Pressures

The proper cold tire inflation pressure is listed on the driver's side B-pillar or rear edge of the driver's side door.

At least once a month:

- Check and adjust tire pressure with a good quality pocket-type pressure gauge. Do not make a visual judgment when determining proper inflation. Tires may look properly inflated even when they are underinflated.
- Inspect tires for signs of tire wear or visible damage.

| CAUTION! |
|---|
| <p>After inspecting or adjusting the tire pressure, always reinstall the valve stem cap. This will prevent moisture and dirt from entering the valve stem, which could damage the valve stem.</p> |

428 SERVICING AND MAINTENANCE

Inflation pressures specified on the placard are always “cold tire inflation pressure”. Cold tire inflation pressure is defined as the tire pressure after the vehicle has not been driven for at least three hours, or driven less than 1 mile (1.6 km) after sitting for a minimum of three hours. The cold tire inflation pressure must not exceed the maximum inflation pressure molded into the tire sidewall.

Check tire pressures more often if subject to a wide range of outdoor temperatures, as tire pressures vary with temperature changes.

Tire pressures change by approximately 1 psi (7 kPa) per 12 °F (7 °C) of air temperature change. Keep this in mind when checking tire pressure inside a garage, especially in the Winter.

Example: If garage temperature = 68 °F (20 °C) and the outside temperature = 32 °F (0 °C) then the cold tire inflation pressure should be increased by 3 psi (21 kPa), which equals 1 psi (7 kPa) for every 12 °F (7 °C) for this outside temperature condition.

Tire pressure may increase from 2 to 6 psi (13 to 40 kPa) during operation. DO NOT reduce this normal pressure build up or your tire pressure will be too low.

Tire Pressures For High Speed Operation

The manufacturer advocates driving at safe speeds and within posted speed limits. Where speed limits or conditions are such that the vehicle can be driven at high speeds, maintaining correct tire inflation pressure is very important. Increased tire pressure and reduced vehicle loading may be required for high-speed vehicle operation. Refer to an authorized tire dealer or original equipment vehicle dealer for recommended safe operating speeds, loading and cold tire inflation pressures.

WARNING!

High speed driving with your vehicle under maximum load is dangerous. The added strain on your tires could cause them to fail. You could have a serious collision. Do not drive a vehicle loaded to the maximum capacity at continuous speeds above 75 mph (120 km/h).

Radial Ply Tires

WARNING!

Combining radial ply tires with other types of tires on your vehicle will cause your vehicle to handle poorly. The instability could cause a collision. Always use radial ply tires in sets of four. Never combine them with other types of tires.

Tire Repair

If your tire becomes damaged, it may be repaired if it meets the following criteria:

- The tire has not been driven on when flat
- The damage is only on the tread section of your tire (sidewall damage is not repairable)
- The puncture is no greater than a ¼ of an inch (6 mm)

Consult an authorized tire dealer for tire repairs and additional information.

Damaged Run Flat tires, or Run Flat tires that have experienced a loss of pressure should be replaced immediately with another Run Flat tire of identical size and service description (Load Index and Speed Symbol). Replace the tire pressure sensor as well as it is not designed to be reused.

Run Flat Tires — If Equipped

Run Flat tires allow you the capability to drive 50 miles (80 km) at 50 mph (80 km/h) after a rapid loss of inflation pressure. This rapid loss of inflation is referred to as the Run Flat mode. A Run Flat mode occurs when the tire inflation pressure is of/or below 14 psi (96 kPa). Once a Run Flat tire reaches the Run Flat mode it has limited driving capabilities and needs to be replaced immediately. A Run Flat tire is not repairable. When a Run Flat tire is changed after driving with underinflated tire condition, please replace the TPM sensor as it is not designed to be reused when driven under Run Flat mode 14 psi (96 kPa) condition.

NOTE:

TPM Sensor must be replaced after driving the vehicle on a flat tire condition.

It is not recommended driving a vehicle loaded at full capacity or to tow a trailer while a tire is in the Run Flat mode.

For more information ⇨ page 306.

Tire Spinning

When stuck in mud, sand, snow, or ice conditions, do not spin your vehicle's wheels above 30 mph (48 km/h) or for longer than 30 seconds continuously without stopping.

For further information ⇨ page 366.

WARNING!

Fast spinning tires can be dangerous. Forces generated by excessive wheel speeds may cause tire damage or failure. A tire could explode and injure someone. Do not spin your vehicle's wheels faster than 30 mph (48 km/h) for more than 30 seconds continuously when you are stuck, and do not let anyone near a spinning wheel, no matter what the speed.

Tread Wear Indicators

Tread wear indicators are in the original equipment tires to help you in determining when your tires should be replaced.

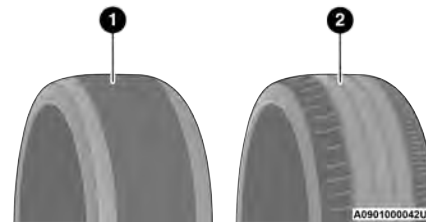

Tire Tread

- 1 — Worn Tire
- 2 — New Tire

These indicators are molded into the bottom of the tread grooves. They will appear as bands when the tread depth becomes a 1/16 of an inch (1.6 mm). When the tread is worn to the tread wear indicators, the tire should be replaced.

For further information ⇨ page 430.

Life Of Tire

The service life of a tire is dependent upon varying factors including, but not limited to:

- Driving style
- Tire pressure - Improper cold tire inflation pressures can cause uneven wear patterns to develop across the tire tread. These abnormal wear patterns will reduce tread life, resulting in the need for earlier tire replacement
- Distance driven
- Performance tires, tires with a speed rating of V or higher, and Summer tires typically have a reduced tread life. Rotation of these tires per the vehicle scheduled maintenance is highly recommended

8

WARNING!

Tires and the spare tire should be replaced after six years, regardless of the remaining tread. Failure to follow this warning can result in sudden tire failure. You could lose control and have a collision resulting in serious injury or death.

430 SERVICING AND MAINTENANCE

NOTE:

Wheel Valve Stem must be replaced as well when installing new tires due to wear and tear in existing tires.

Keep dismounted tires in a cool, dry place with as little exposure to light as possible. Protect tires from contact with oil, grease, and gasoline.

Replacement Tires

The tires on your new vehicle provide a balance of many characteristics. They should be inspected regularly for wear and correct cold tire inflation pressures. The manufacturer strongly recommends that you use tires equivalent to the originals in size, quality and performance when replacement is needed → page 429. Refer to the Tire and Loading Information placard or the Vehicle Certification Label for the size designation of your tire. The Load Index and Speed Symbol for your tire will be found on the original equipment tire sidewall.

For more information relating to the Load Index and Speed Symbol of a tire → page 420.

It is recommended to replace the two front tires or two rear tires as a pair. Replacing just one tire can seriously affect your vehicle's handling. If you ever replace a wheel, make sure that the wheel's specifications match those of the original wheels.

It is recommended you contact an authorized tire dealer or original equipment dealer with any

questions you may have on tire specifications or capability. Failure to use equivalent replacement tires may adversely affect the safety, handling, and ride of your vehicle.

WARNING!

- Do not use a tire, wheel size, load rating, or speed rating other than that specified for your vehicle. Some combinations of unapproved tires and wheels may change suspension dimensions and performance characteristics, resulting in changes to steering, handling, and braking of your vehicle. This can cause unpredictable handling and stress to steering and suspension components. You could lose control and have a collision resulting in serious injury or death. Use only the tire and wheel sizes with load ratings approved for your vehicle.
- Never use a tire with a smaller load index or capacity, other than what was originally equipped on your vehicle. Using a tire with a smaller load index could result in tire overloading and failure. You could lose control and have a collision.
- Failure to equip your vehicle with tires having adequate speed capability can result in sudden tire failure and loss of vehicle control.

CAUTION!

Replacing original tires with tires of a different size may result in false speedometer and odometer readings.

TIRE TYPES

All Season Tires — If Equipped

All Season tires provide traction for all seasons (Spring, Summer, Autumn, and Winter). Traction levels may vary between different all season tires. All season tires can be identified by the M+S, M&S, M/S or MS designation on the tire sidewall. Use all season tires only in sets of four; failure to do so may adversely affect the safety and handling of your vehicle.

Summer Or Three Season Tires — If Equipped

Summer tires provide traction in both wet and dry conditions, and are not intended to be driven in snow or on ice. If your vehicle is equipped with Summer tires, be aware these tires are not designed for Winter or cold driving conditions. Install Winter tires on your vehicle when ambient temperatures are less than 40° F (5° C) or if roads are covered with ice or snow. For more information, contact an authorized dealer.

Summer tires do not contain the all season designation or mountain/snowflake symbol on the tire sidewall. Use Summer tires only in sets of four; failure to do so may adversely affect the safety and handling of your vehicle.

WARNING!

Do not use Summer tires in snow/ice conditions. You could lose vehicle control, resulting in severe injury or death. Driving too fast for conditions also creates the possibility of loss of vehicle control.

Snow Tires

Some areas of the country require the use of snow tires during the Winter. Snow tires can be identified by a "mountain/snowflake" symbol on the tire sidewall.



If you need snow tires, select tires equivalent in size and type to the original equipment tires. Use snow tires only in sets of four; failure to do so may adversely affect the safety and handling of your vehicle.

Snow tires generally have lower speed ratings than what was originally equipped with your vehicle and should not be operated at sustained speeds over 75 mph (120 km/h). For speeds above 75 mph (120 km/h) refer to original equipment or an authorized tire dealer for recommended safe operating speeds, loading and cold tire inflation pressures.

While studded tires improve performance on ice, skid and traction capability on wet or dry surfaces may be poorer than that of non-studded tires. Some states prohibit studded tires; therefore, local laws should be checked before using these tire types.

SPARE TIRES — IF EQUIPPED

NOTE:

For vehicles equipped with Tire Service Kit instead of a spare tire, please refer to "Tire Service Kit" in "In Case Of Emergency" for further information.

CAUTION!

Because of the reduced ground clearance, do not take your vehicle through an automatic car wash with a compact or limited use temporary spare installed. Damage to the vehicle may result.

For restrictions when towing with a spare tire designated for temporary emergency use ⇨ page 222.

Spare Tire Matching Original Equipped Tire And Wheel — If Equipped

Your vehicle may be equipped with a spare tire and wheel equivalent in look and function to the original equipment tire and wheel found on the front or rear axle of your vehicle. This spare tire may be used in the tire rotation for your vehicle. If your vehicle has this option, refer to an authorized tire dealer for the recommended tire rotation pattern.

Compact Spare Tire — If Equipped

The compact spare is for temporary emergency use only. You can identify if your vehicle is equipped with a compact spare by looking at the spare tire description on the Tire and Loading Information Placard located on the driver's side door opening or on the sidewall of the tire. Compact spare tire descriptions begin with the letter "T" or "S" preceding the size designation. Example: T145/80D18 103M.

T, S = Temporary Spare Tire

Since this tire has limited tread life, the original equipment tire should be repaired (or replaced) and reinstalled on your vehicle at the first opportunity.

432 SERVICING AND MAINTENANCE

Do not install a wheel cover or attempt to mount a conventional tire on the compact spare wheel, since the wheel is designed specifically for the compact spare tire. Do not install more than one compact spare tire and wheel on the vehicle at any given time.

| WARNING! |
|--|
| <p>Compact and collapsible spares are for temporary emergency use only. With these spares, do not drive more than 50mph (80 km/h). Temporary use spares have limited tread life. When the tread is worn to the tread wear indicators, the temporary use spare tire needs to be replaced. Be sure to follow the warnings, which apply to your spare. Failure to do so could result in spare tire failure and loss of vehicle control.</p> |

Collapsible Spare Tire — If Equipped

The collapsible spare is for temporary emergency use only. You can identify if your vehicle is equipped with a collapsible spare by looking at the spare tire description on the Tire and Loading Information Placard located on the driver's side door opening or on the sidewall of the tire.

Collapsible spare tire description example: 165/80-17 101P.

Since this tire has limited tread life, the original equipment tire should be repaired (or replaced) and reinstalled on your vehicle at the first opportunity.

Inflate collapsible tire only after the wheel is properly installed to the vehicle. Inflate the collapsible tire using the electric air pump before lowering the vehicle.

Do not install a wheel cover or attempt to mount a conventional tire on the collapsible spare wheel, since the wheel is designed specifically for the collapsible spare tire.

| WARNING! |
|--|
| <p>Compact and Collapsible spares are for temporary emergency use only. With these spares, do not drive more than 50mph (80 km/h). Temporary use spares have limited tread life. When the tread is worn to the tread wear indicators, the temporary use spare tire needs to be replaced. Be sure to follow the warnings, which apply to your spare. Failure to do so could result in spare tire failure and loss of vehicle control.</p> |

Full Size Spare — If Equipped

The full size spare is for temporary emergency use only. This tire may look like the originally equipped tire on the front or rear axle of your vehicle, but it is not. This spare tire may have limited tread life. When the tread is worn to the tread wear indicators, the temporary use full size spare tire needs to be replaced. Since it is not the same as your original equipment tire, replace (or repair) the original equipment tire and reinstall on the vehicle at the first opportunity.

Limited Use Spare — If Equipped

The limited use spare tire is for temporary emergency use only. This tire is identified by a label located on the limited use spare wheel. This label contains the driving limitations for this spare. This tire may look like the original equipped tire on the front or rear axle of your vehicle, but it is not. Installation of this limited use spare tire affects vehicle handling. Since it is not the same as your original equipment tire, replace (or repair) the original equipment tire and reinstall on the vehicle at the first opportunity.

WARNING!

Limited use spares are for emergency use only. Installation of this limited use spare tire affects vehicle handling. With this tire, do not drive more than the speed listed on the limited use spare wheel. Keep inflated to the cold tire inflation pressures listed on your Tire and Loading Information Placard located on the driver's side B-pillar or the rear edge of the driver's side door. Replace (or repair) the original equipment tire at the first opportunity and reinstall it on your vehicle. Failure to do so could result in loss of vehicle control.

WHEEL AND WHEEL TRIM CARE

All wheels and wheel trim, especially aluminum and chrome plated wheels, should be cleaned regularly using mild (neutral Ph) soap and water to maintain their luster and to prevent corrosion. Wash wheels with the same soap solution recommended for the body of the vehicle and remember to always wash when the surfaces are not hot to the touch.

Your wheels are susceptible to deterioration caused by salt, sodium chloride, magnesium chloride, calcium chloride, etc., and other road chemicals used to melt ice or control dust on dirt roads. Use a soft cloth or sponge and mild soap to wipe away promptly. Do not use harsh chemicals or a stiff brush. They can damage the wheel's protective coating that helps keep them from corroding and tarnishing.

CAUTION!

Avoid products or automatic car washes that use acidic solutions or strong alkaline additives or harsh brushes. Many aftermarket wheel cleaners and automatic car washes may damage the wheel's protective finish. Such damage is not covered by the New Vehicle Limited Warranty. Only car wash soap, Mopar® Wheel Cleaner or equivalent is recommended.

When cleaning extremely dirty wheels including excessive brake dust, care must be taken in the selection of tire and wheel cleaning chemicals and equipment to prevent damage to the wheels. Mopar® Wheel Treatment or Mopar® Chrome Cleaner or their equivalent is recommended or select a non-abrasive, non-acidic cleaner for aluminum or chrome wheels.

CAUTION!

Do not use scouring pads, steel wool, a bristle brush, metal polishes or oven cleaner. These products may damage the wheel's protective finish. Such damage is not covered by the New Vehicle Limited Warranty. Only car wash soap, Mopar® Wheel Cleaner or equivalent is recommended.

NOTE:

If you intend parking or storing your vehicle for an extended period after cleaning the wheels with wheel cleaner, drive your vehicle and apply the brakes to remove the water droplets from the brake components. This activity will remove the red rust on the brake rotors and prevent vehicle vibration when braking.

Dark Vapor Chrome, Black Satin Chrome, or Low Gloss Clear Coat Wheels**CAUTION!**

If your vehicle is equipped with these specialty wheels, DO NOT USE wheel cleaners, abrasives, or polishing compounds. They will permanently damage this finish and such damage is not covered by the New Vehicle Limited Warranty. HAND WASH ONLY USING MILD SOAP AND WATER WITH A SOFT CLOTH. Used on a regular basis; this is all that is required to maintain this finish.

434 SERVICING AND MAINTENANCE**SNOW TRACTION DEVICES**

Use of traction devices require sufficient tire-to-body clearance. Due to limited clearance, the following snow traction devices are recommended. Follow these recommendations to guard against damage:

- Snow traction device must be of proper size for the tire, as recommended by the snow traction device manufacturer.
- No other tire sizes are recommended for use with the snow traction device.
- Please follow the table below for the recommended tire size, axle and snow traction device:

| 4x2 (2WD) Trim Level | Axle | Tire/Wheel Size | Snow Traction Device (maximum projection beyond tire profile or equivalent) |
|---|---------------|------------------------|--|
| HFE Tradesman Bighorn Lonestar Laramie | Rear | 275/65R18 275/55R20 | S Class |
| Longhorn Sport Limited | Rear | 275/55R20 | S Class |
| REBEL | Not Chainable | | |

| 4x4 (4WD) Trim Level | Axle | Tire/Wheel Size | Snow Traction Device (maximum projection beyond tire profile or equivalent) |
|--|-------------|-------------------------|--|
| Tradesman Bighorn Lonestar Laramie | Rear | 275/65R18 275/55/R20 | S Class |

| 4x4 (4WD) Trim Level | Axle | Tire/Wheel Size | Snow Traction Device (maximum projection beyond tire profile or equivalent) |
|------------------------------|---------------|-----------------|---|
| Longhorn Sport Limited | Rear | 275/55R20 | S Class |
| REBEL | Not Chainable | | |

WARNING!

Using tires of different size and type (M+S, Snow) between front and rear axles can cause unpredictable handling. You could lose control and have a collision.

CAUTION!

To avoid damage to your vehicle or tires, observe the following precautions:

- Because of restricted traction device clearance between tires and other suspension components, it is important that only traction devices in good condition are used. Broken devices can cause serious damage. Stop the vehicle immediately if noise occurs that could indicate device breakage. Remove the damaged parts of the device before further use.
- Install device as tightly as possible and then retighten after driving about ½ mile (0.8 km). Autosock traction devices do not require retightening.
- Do not exceed 30 mph (48 km/h).
- Drive cautiously and avoid severe turns and large bumps, especially with a loaded vehicle.
- Do not drive for a prolonged period on dry pavement.
- Observe the traction device manufacturer's instructions on the method of installation, operating speed, and conditions for use. Always use the suggested operating speed of the device manufacturer's if it is less than 30 mph (48 km/h).
- Do not use traction devices on a compact spare tire.

436 SERVICING AND MAINTENANCE**TIRE ROTATION RECOMMENDATIONS**

Tires on the front and rear axles of vehicles operate at different loads and perform different steering, driving, and braking functions. For these reasons, they wear at unequal rates.

These effects can be reduced by timely rotation of tires. The benefits of rotation are especially worthwhile with aggressive tread designs such as those on all season type tires. Rotation will increase tread life, help to maintain mud, snow and wet traction levels and contribute to a smooth, quiet ride.

For the proper maintenance intervals → page 371. More frequent rotation is permissible if desired. The reasons for any rapid or unusual wear should be corrected prior to rotation being performed.

The suggested rotation method is the “rearward cross” shown in the following diagram. This rotation pattern does not apply to some directional tires that must not be reversed.

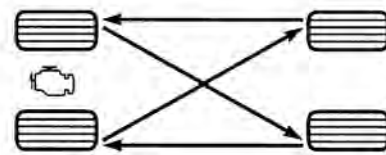

Tire Rotation (Rearward Cross)

055703771

DEPARTMENT OF TRANSPORTATION UNIFORM TIRE QUALITY GRADES

The following tire grading categories were established by the National Highway Traffic Safety Administration. The specific grade rating assigned by the tire's manufacturer in each category is shown on the sidewall of the tires on your vehicle.

All passenger vehicle tires must conform to Federal safety requirements in addition to these grades.

TREADWEAR

The Treadwear grade is a comparative rating, based on the wear rate of the tire when tested under controlled conditions on a specified government test course. For example, a tire graded 150 would wear one and one-half times as well on the government course as a tire graded 100. The relative performance of tires depends upon the actual conditions of their use, however, and may depart significantly from the norm due to variations in driving habits, service practices, and differences in road characteristics and climate.

TRACTION GRADES

The Traction grades, from highest to lowest, are AA, A, B, and C. These grades represent the tire's ability to stop on wet pavement, as measured under controlled conditions on specified government test surfaces of asphalt and concrete. A tire marked C may have poor traction performance.

WARNING!

The traction grade assigned to this tire is based on straight-ahead braking traction tests, and does not include acceleration, cornering, hydroplaning, or peak traction characteristics.

TEMPERATURE GRADES

The Temperature grades are A (the highest), B, and C, representing the tire's resistance to the generation of heat and its ability to dissipate heat, when tested under controlled conditions on a specified indoor laboratory test wheel.

Sustained high temperature can cause the material of the tire to degenerate and reduce tire life, and excessive temperature can lead to sudden tire failure. The grade C corresponds to a level of performance, which all passenger vehicle tires must meet under the Federal Motor Vehicle Safety Standard No. 109. Grades B and A represent higher levels of performance on the laboratory test wheel, than the minimum required by law.

WARNING!

The temperature grade for this tire is established for a tire that is properly inflated and not overloaded. Excessive speed, underinflation, or excessive loading, either separately or in combination, can cause heat buildup and possible tire failure.

STORING THE VEHICLE

If you are storing your vehicle for more than three weeks, we recommend that you take the following steps to minimize the drain on your vehicle's battery:

- Disconnect the negative cable from battery.
- Any time you store your vehicle or keep it out of service (i.e., vacation) for two weeks or more, run the air conditioning system at idle for about five minutes in the fresh air and high blower setting. This will ensure adequate system lubrication to minimize the possibility of compressor damage when the system is started again.

BODYWORK**PROTECTION FROM ATMOSPHERIC AGENTS**

Vehicle body care requirements vary according to geographic locations and usage. Chemicals that make roads passable in snow and ice and those that are sprayed on trees and road surfaces during other seasons are highly corrosive to the metal in your vehicle. Outside parking, which exposes your vehicle to airborne contaminants, road surfaces on which the vehicle is operated, extreme hot or cold weather and other extreme conditions will have an adverse effect on paint, metal trim, and underbody protection.

The following maintenance recommendations will enable you to obtain maximum benefit from the corrosion resistance built into your vehicle.

What Causes Corrosion?

Corrosion is the result of deterioration or removal of paint and protective coatings from your vehicle.

The most common causes are:

- Road salt, dirt and moisture accumulation.
- Stone and gravel impact.
- Insects, tree sap and tar.
- Salt in the air near seacoast localities.
- Atmospheric fallout/industrial pollutants.

438 SERVICING AND MAINTENANCE

BODY AND UNDERBODY MAINTENANCE

Cleaning Headlights

Your vehicle is equipped with plastic headlights and fog lights that are lighter and less susceptible to stone breakage than glass headlights.

Plastic is not as scratch resistant as glass and therefore different lens cleaning procedures must be followed.

To minimize the possibility of scratching the lenses and reducing light output, avoid wiping with a dry cloth. To remove road dirt, wash with a mild soap solution followed by rinsing.

Do not use abrasive cleaning components, solvents, steel wool or other aggressive material to clean the lenses.

Tri-Fold Soft Tonneau Cover Care

For cleaning and protecting the vinyl Tri-Fold Tonneau cover, use Mopar® Whitewall & Vinyl Top Cleaner and Mopar® Leather and Vinyl Conditioner/Protectant.

PRESERVING THE BODYWORK

Washing

- Wash your vehicle regularly. Always wash your vehicle in the shade using Mopar® Car Wash, or a mild car wash soap, and rinse the panels completely with water.
- If insects, tar, or other similar deposits have accumulated on your vehicle, use Mopar® Super Kleen Bug and Tar Remover to remove.
- Use a high quality cleaner wax, such as Mopar® Cleaner Wax to remove road film, stains and to protect your paint finish. Use precautions to not scratch the paint.
- Avoid using abrasive compounds and power buffing that may diminish the gloss or thin out the paint finish.

| CAUTION! |
|---|
| <ul style="list-style-type: none"> ● Do not use abrasive or strong cleaning materials such as steel wool or scouring powder that will scratch metal and painted surfaces. ● Use of power washers exceeding 1,200 psi (8,274 kPa) can result in damage or removal of paint and decals. |

Fascia/Bumper Care

The customer is responsible to clean and maintain the chrome components of the vehicle. Wash away road debris and salt using an automotive soap. Fascia/bumpers should be cleaned regularly using mild (neutral Ph) soap and water to maintain their luster and to prevent corrosion.

Your fascia/bumpers are susceptible to deterioration caused by salt, sodium chloride, magnesium chloride, calcium chloride, etc., and other road chemicals used to melt ice or control dust on dirt roads. Do not use harsh chemicals or a stiff brush. They can stain or damage the protective coating that helps keep them from corroding and tarnishing.

| CAUTION! |
|--|
| <ul style="list-style-type: none"> ● Do not use scouring pads, steel wool, a bristle brush, metal polishes, or oven cleaner. These products may damage the bumper's protective finish. Such damage is not covered by the New Vehicle Limited Warranty. Only car wash soap, Mopar® Chrome Cleaner, or equivalent is recommended. |

(Continued)

CAUTION!

- Avoid products or automatic car washes that use acidic solutions, strong alkaline additives, or harsh brushes. Many aftermarket cleaners and automatic car washes may damage the bumper's protective finish. Such damage is not covered by the New Vehicle Limited Warranty. Only car wash soap, Mopar® Chrome Cleaner, or equivalent is recommended.

Special Care

- If you drive on salted or dusty roads or if you drive near the ocean, hose off the undercarriage at least once a month.
- It is important that the drain holes in the lower edges of the doors, rocker panels, and trunk be kept clear and open.
- If you detect any stone chips or scratches in the paint, touch them up immediately.
- If your vehicle is damaged due to a collision or similar cause that destroys the paint and protective coating, have your vehicle repaired as soon as possible.
- If you carry special cargo such as chemicals, fertilizers, de-icer salt, etc., be sure that such materials are well packaged and sealed.

- If a lot of driving is done on gravel roads, consider mud or stone shields behind each wheel.
- Use Mopar® Touch Up Paint on scratches as soon as possible. An authorized dealer has touch up paint to match the color of your vehicle.

Spray-On Bedliner – If Equipped

During ownership, the shine and luster of the Spray-On Bedliner can fade from oxidation, road dirt, heavy-duty hauling and hard water stains. Weathering and UV exposure will lead to fading.

To help maintain the appearance of your Spray-On Bedliner, the manufacturer recommends you periodically rinse all loose dirt from your truck bed and clean your truck at least twice per year using the Mopar® Spray-On Bedliner Conditioner available at a local authorized dealer.

To Help Maintain The Appearance Of Your Spray-On Bedliner, Follow The Steps Below:

1. Rinse your truck bed out with water to remove any loose dirt and debris.
2. Mix a mild soap or detergent with water. Then apply solution with a soft cloth or brush.
3. Rinse bedliner with water.
4. Once dry, apply a small amount of Mopar® Spray-On Bedliner Conditioner to a moist towel or sponge and wipe over the entire surface of the truck bedliner.

WARNING!

Do not use silicon-based protection products to clean your bedliner. Silicon-based products can become slippery and may result in personal injury.

Spray-On Bedliners are chemically-resistant to many different types of chemicals (including gasoline, oil, hydraulic fluids) for short periods of time. If a spill occurs on your Spray-On Bedliner, rinse the truck out as soon as possible to avoid permanent damage.

Repairing The Spray-On Bedliner

While extremely tough, it is possible to damage a Spray-On Bedliner. One common condition is when loading a heavy pallet and dragging that pallet across the floor of the bed. If a nail or sharp point is exposed under the weight of the pallet a scratch or tear is possible. While not covered by your new vehicle warranty, a cosmetic fix to cover the metal exposed by the scratch is required. To repair a tear or gouge, follow the directions provided in the Mopar® Quick Repair Kit.

440 SERVICING AND MAINTENANCE

INTERIORS

SEATS AND FABRIC PARTS

Use Mopar® Total Clean to clean fabric upholstery and carpeting.

WARNING!

Do not use volatile solvents for cleaning purposes. Many are potentially flammable, and if used in closed areas they may cause respiratory harm.

Stain Repel Fabric Cleaning Procedure — If Equipped

Stain Repel seats may be cleaned in the following manner:

- Remove as much of the stain as possible by blotting with a clean, dry towel.
- Blot any remaining stain with a clean, damp towel.

- For tough stains, apply Mopar® Total Clean, or a mild soap solution to a clean, damp cloth and remove stain. Use a fresh, damp towel to remove soap residue.
- For grease stains, apply Mopar® Multi-Purpose Cleaner to a clean, damp cloth and remove stain. Use a fresh, damp towel to remove soap residue.
- Do not use any harsh solvents or any other form of protectants on Stain Repel products.

Seat Belt Maintenance

Do not bleach, dye or clean the belts with chemical solvents or abrasive cleaners. This will weaken the fabric.

If the belts need cleaning, use a mild soap solution or lukewarm water. Do not remove the belts from the vehicle to wash them. Dry with a soft cloth.

Sun damage can also weaken the fabric. Replace the belts if they appear frayed or worn or if the buckles do not work properly.

NOTE:

If the belts retract slowly, inspect the upper turning loop for soiling. If soiling is present, clean with a wet soft cloth until all residue is removed.

WARNING!

A frayed or torn seat belt could rip apart in a collision and leave you with no protection. Inspect the seat belt system periodically, checking for cuts, frays, or loose parts. Damaged parts must be replaced immediately. Do not disassemble or modify the seat belt system. If your vehicle is involved in a collision, or if you have questions regarding seat belt or retractor conditions, take your vehicle to an authorized FCA dealer or authorized FCA Certified Collision Care Program facility for inspection.

PLASTIC AND COATED PARTS

Use Mopar® Total Clean to clean vinyl upholstery.

CAUTION!

- Direct contact of air fresheners, insect repellents, suntan lotions, or hand sanitizers to the plastic, painted, or decorated surfaces of the interior may cause permanent damage. Wipe away immediately.
- Damage caused by these type of products may not be covered by your New Vehicle Limited Warranty.

Cleaning Plastic Instrument Cluster

Lenses

The lenses in front of the instruments in this vehicle are molded in clear plastic. When cleaning the lenses, care must be taken to avoid scratching the plastic.

Clean with a wet soft cloth. A mild soap solution may be used, but do not use high alcohol content or abrasive cleaners. If soap is used, wipe clean with a clean damp cloth. Dry with a soft cloth.

LEATHER SURFACES

Mopar® Total Clean is specifically recommended for leather upholstery.

Your leather upholstery can be best preserved by regular cleaning with a damp soft cloth. Small particles of dirt can act as an abrasive and damage the leather upholstery and should be removed promptly with a damp cloth. Stubborn soils can be removed easily with a soft cloth and Mopar® Total Clean. Care should be taken to avoid soaking your leather upholstery with any liquid. Please do not use polishes, oils, cleaning fluids, solvents, detergents, or ammonia-based cleaners to clean your leather upholstery.

NOTE:

If equipped with light colored leather, it tends to show any foreign material, dirt, and fabric dye transfer more so than darker colors. The leather is designed for easy cleaning, and the manufacturer recommends Mopar® Total Clean leather cleaner applied on a cloth to clean the leather seats as needed.

CAUTION!

Do not use Alcohol and Alcohol-based and/or Ketone based cleaning products to clean leather upholstery, as damage to the upholstery may result.

GLASS SURFACES

All glass surfaces should be cleaned on a regular basis with Mopar® Glass Cleaner, or any commercial household-type glass cleaner. Never use an abrasive type cleaner. Use caution when cleaning the inside rear window equipped with electric defrosters or windows equipped with radio antennas. Do not use scrapers or other sharp instruments that may scratch the elements.

When cleaning the rear view mirror, spray cleaner on the towel or cloth that you are using. Do not spray cleaner directly on the mirror.

TECHNICAL SPECIFICATIONS

VEHICLE IDENTIFICATION NUMBER (VIN)

The VIN is found on the left front corner of the instrument panel, visible through the windshield.

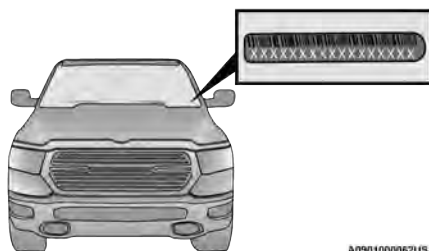

Vehicle Identification Number

A090100006ZUS

NOTE:

It is illegal to remove or alter the VIN.

BRAKE SYSTEM

If power assist is lost for any reason (for example, repeated brake applications with the engine off), the brakes will still function. However, you will experience a substantial increase in braking effort to stop the vehicle.

If either the front or rear hydraulic system loses normal braking capability, the remaining system will still function with some loss of overall braking effectiveness. This will be evident by increased pedal travel during application, greater pedal force required to slow or stop, and the Brake Warning Light and the ABS Warning Light will activate during brake use.

WHEEL AND TIRE TORQUE SPECIFICATIONS

Proper lug nut/bolt torque is very important to ensure that the wheel is properly mounted to the vehicle. Any time a wheel has been removed and reinstalled on the vehicle, the lug nuts/bolts should be torqued using a properly calibrated torque wrench using a six sided (hex) deep wall socket.

TORQUE SPECIFICATIONS

| Lug Nut/ Bolt Torque | Lug Nut/ Bolt Type | **Lug Nut/Bolt Size | Lug Nut/ Bolt Socket Size |
|----------------------------|-----------------------|---------------------------|------------------------------------|
| 130 Ft-Lb (176 N·m) | Cone | M14 x 1.50 | 22 mm |

**Use only authorized dealer recommended lug nuts/bolts and clean or remove any dirt or oil before tightening.

NOTE:

Do not oil wheel studs. For chrome wheels, do not substitute with chrome plated wheel nuts.

Inspect the wheel mounting surface prior to mounting the tire and remove any corrosion or loose particles.

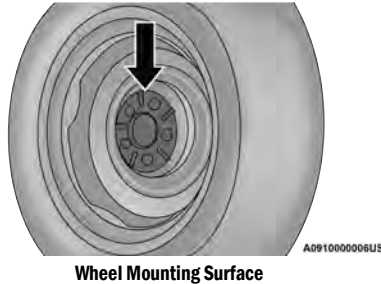

Wheel Mounting Surface

Tighten the lug nuts/bolts in a star pattern until each nut/bolt has been tightened twice. Ensure that the socket is fully engaged on the lug nut/bolt (do not insert it halfway).

After 25 miles (40 km), check the lug nut/bolt torque to be sure that all the lug nuts/bolts are properly seated against the wheel.

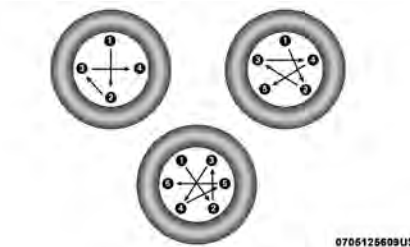

Four, Five, And Six Lug Nuts/Bolts Torque Pattern

WARNING!

To avoid the risk of forcing the vehicle off the jack, do not tighten the lug nuts/bolts fully until the vehicle has been lowered. Failure to follow this warning may result in personal injury.

FUEL REQUIREMENTS — GASOLINE ENGINE

While operating on gasoline with the required octane number, hearing a light knocking sound from the engine is not a cause for concern. However, if the engine is heard making a heavy knocking sound, see a dealer immediately. Use of gasoline with a lower than recommended octane number can cause engine failure and may void or not be covered by the New Vehicle Limited Warranty.

Poor quality gasoline can cause problems such as hard starting, stalling, and hesitations. If you experience these symptoms, try another brand of gasoline before considering service for the vehicle.

3.6L ENGINE

Do not use E-85 flex fuel or ethanol blends greater than 15% in this engine.

87

This engine is designed to meet all emissions regulations and provide optimum fuel economy and performance when using high quality unleaded “Regular” gasoline having a posted octane number of 87 as specified by the (R+M)/2 method. The use of higher octane “Premium” gasoline is not required, as it will not provide any benefit over “Regular” gasoline in these engines.

5.7L ENGINE

Do not use E-85 flex fuel or ethanol blends greater than 15% in this engine.

89

This engine is designed to meet all emissions regulations and provide satisfactory fuel economy and performance when using high-quality unleaded gasoline having an octane range of 87 to 89 as specified by the (R+M)/2 method. The use of 89 octane “Plus” gasoline is recommended for optimum performance and fuel economy.

444 TECHNICAL SPECIFICATIONS

REFORMULATED GASOLINE

Many areas of the country require the use of cleaner burning gasoline referred to as "reformulated gasoline". Reformulated gasoline contains oxygenates and are specifically blended to reduce vehicle emissions and improve air quality.

The use of reformulated gasoline is recommended. Properly blended reformulated gasoline will provide improved performance and durability of engine and fuel system components.

MATERIALS ADDED TO FUEL

Besides using unleaded gasoline with the proper octane rating, gasolines that contain detergents, corrosion and stability additives are recommended. Using gasolines that have these additives will help improve fuel economy, reduce emissions, and maintain vehicle performance.



Designated TOP TIER Detergent Gasoline contains a higher level of detergents to further aid in minimizing engine and fuel system deposits. When available, the usage of TOP TIER Detergent Gasoline is recommended. Visit www.toptiergas.com for a list of TOP TIER Detergent Gasoline retailers.

Indiscriminate use of fuel system cleaning agents should be avoided. Many of these materials intended for gum and varnish removal may contain active solvents or similar ingredients. These can harm fuel system gasket and diaphragm materials.

GASOLINE/OXYGENATE BLENDS

Some fuel suppliers blend unleaded gasoline with oxygenates such as ethanol.

| CAUTION! |
|---|
| DO NOT use E-85, gasoline containing methanol, or gasoline containing more than 15% ethanol (E-15). Use of these blends may result in starting and drivability problems, damage critical fuel system components, cause emissions to exceed the applicable standard, and/or cause the Malfunction Indicator Light to illuminate. Please observe pump labels as they should clearly communicate if a fuel contains greater than 15% ethanol (E-15). |

Problems that result from using gasoline containing more than 15% ethanol (E-15) or gasoline containing methanol are not the responsibility of the manufacturer and may void the New Vehicle Limited Warranty.

DO NOT USE E-85 IN NON-FLEX FUEL VEHICLES

Non-Flex Fuel Vehicles (FFV) are compatible with gasoline containing up to 15% ethanol (E-15). Use of gasoline with higher ethanol content may void the New Vehicle Limited Warranty.

If a Non-FFV vehicle is inadvertently fueled with E-85 fuel, the engine will have some or all of these symptoms:

- Operate in a lean mode.
- OBD II Malfunction Indicator Light on.
- Poor engine performance.
- Poor cold start and cold drivability.
- Increased risk for fuel system component corrosion.

CNG AND LP FUEL SYSTEM MODIFICATIONS

Modifications that allow the engine to run on Compressed Natural Gas (CNG) or Liquid Propane (LP) may result in damage to the engine, emissions, and fuel system components. Problems that result from running CNG or LP are not the responsibility of the manufacturer and may void the New Vehicle Limited Warranty.

METHYLCYCLOPENTADIENYL MANGANESE TRICARBONYL (MMT) IN GASOLINE

MMT is a manganese-containing metallic additive that is blended into some gasoline to increase octane. Gasoline blended with MMT provides no performance advantage beyond gasoline of the same octane number without MMT. Gasoline blended with MMT reduces spark plug life and reduces emissions system performance in some vehicles. The manufacturer recommends that gasoline without MMT be used in your vehicle. The MMT content of gasoline may not be indicated on the gasoline pump; therefore, you should ask the gasoline retailer whether the gasoline contains MMT. MMT is prohibited in Federal and California reformulated gasoline.

FUEL SYSTEM CAUTIONS

CAUTION!

Follow these guidelines to maintain your vehicle's performance:

- The use of leaded gasoline is prohibited by Federal law. Using leaded gasoline can impair engine performance and damage the emissions control system.

(Continued)

CAUTION!

- An out-of-tune engine or certain fuel or ignition malfunctions can cause the catalytic converter to overheat. If you notice a pungent burning odor or some light smoke, your engine may be out of tune or malfunctioning and may require immediate service. Contact an authorized dealer for service assistance.
- The use of fuel additives, which are now being sold as octane enhancers, is not recommended. Most of these products contain high concentrations of methanol. Fuel system damage or vehicle performance problems resulting from the use of such fuels or additives is not the responsibility of the manufacturer and may void or not be covered under the New Vehicle Limited Warranty.

NOTE:

Intentional tampering with the emissions control system can result in civil penalties being assessed against you.

FUEL REQUIREMENTS – DIESEL ENGINE

Federal law requires that you must fuel this vehicle with Ultra Low Sulfur Highway Diesel fuel (15 ppm Sulfur maximum) and prohibits the use of Low Sulfur Highway Diesel fuel (500 ppm Sulfur

maximum) to avoid damage to the emissions control system.

Use good quality diesel fuel from a reputable supplier in your vehicle. For most year-round service, No. 2 diesel fuel meeting ASTM (formerly known as the American Society for Testing and Materials) specification D-975 Grade S15 will provide good performance. If the vehicle is exposed to extreme cold (below 20 °F or -7 °C), or is required to operate at colder-than-normal conditions for prolonged periods, use Climatized Number 2 diesel fuel or dilute the Number 2 diesel fuel with 50% Number 1 diesel fuel. This will provide better protection from fuel gelling or wax-plugging of the fuel filters.

WARNING!

Do not use alcohol or gasoline as a fuel blending agent. They can be unstable under certain conditions and hazardous or explosive when mixed with diesel fuel.

Diesel fuel is seldom completely free of water. To prevent fuel system trouble, drain the accumulated water from the fuel/water separator filter using the fuel/water separator drain provided on the fuel filter housing. If you buy good quality fuel and follow the cold weather advice above, fuel conditioners should not be required in your vehicle.

446 TECHNICAL SPECIFICATIONS

If available in your area, a high cetane “premium” diesel fuel may offer improved cold-starting and warm-up performance.

CAUTION!

If the Water in Fuel Indicator Light remains on, **DO NOT START** engine before you drain the water from the fuel filter(s) to avoid engine damage
 ⇨ page 388.

DIESEL FUEL SPECIFICATIONS

This diesel engine has been developed to take advantage of the high energy content and generally lower cost Number 2 Ultra Low Sulfur diesel fuel or Number 2 Ultra Low Sulfur Climatized diesel fuels.

NOTE:

- If you accidentally fill the fuel tank with gasoline or DEF on your diesel vehicle, do not start the engine. Damage to the engine and fuel system could occur. Please call an authorized dealer for service.

- A maximum blend of 5% biodiesel meeting ASTM specification D-975 may be used with your diesel engine without any adjustments to regular service schedules.
- Commercially available fuel additives are not necessary for the proper operation of your diesel engine.
- Number 1 Ultra Low Sulfur diesel fuel should only be used where extended arctic conditions (-10°F or -23°C) exist.

BIODIESEL FUEL REQUIREMENTS

A maximum blend of 5% biodiesel meeting ASTM specification D975 is recommended for use with your diesel engine. If frequent operation with Biodiesel blends that are between 6% and 20% (B6–B20) is desired, the maintenance schedule is subject to shorter intervals.

The oil and filter change along with fuel filter replacement is subject to shorter intervals when operating your engine on biodiesel greater than 5%. Do not use biodiesel greater than 20%.

For regular use of biodiesel blends between 6% and 20% (B6–B20) it is important that you understand and comply with these requirements. For further direction ⇨ page 379.

CAUTION!

Failure to comply with Oil Change requirements for vehicles operating on biodiesel blends between 6% and 20% (B6–B20) will result in premature engine wear. Such wear is not covered by the New Vehicle Limited Warranty.

Biodiesel is a fuel produced from renewable resources typically derived from animal fat, rapeseed oil (Rapeseed Methyl Ester (RME) base), or soybean oil (Soy Methyl Ester (SME or SOME) base).

Biodiesel fuel has inherent limitations which require that you understand and adhere to the following requirements if you use blends of Biodiesel between 6% and 20% (B6–B20). There are no unique restrictions for the use of B5.

CAUTION!

Use of blends greater than 20% is not approved. Use of blends greater than 20% can result in engine damage. Such damage is not covered by the New Vehicle Limited Warranty.

CAUTION!

In the event that the vehicle is filled with biodiesel and not used for more than a month, the fuel should either be used up by driving (up to quarter tank) and filled with standard diesel blends with less than 5% that is normally available. This will help prevent the fuel filter clogging and potential damage to the fuel injection system due to degraded biodiesel, which is not covered by the New Vehicle Limited Warranty.

Biodiesel Fuel Properties — Low Ambient Temperatures

Biodiesel fuel may gel or solidify at low ambient temperatures, which may pose problems for both storage and operation. Precautions can be necessary at low ambient temperatures, such as storing the fuel in a heated building or a heated storage tank, or using cold temperature additives.

Fuel Quality — Must Comply With ASTM Standards

The quality of Biodiesel fuel may vary widely. Only fuel produced by a BQ9000 supplier to the following specifications may be blended to meet Biodiesel blend B6 – B20 fuel meeting ASTM specification D-7467:

Petrodiesel fuel meeting ASTM specification D-975 and Biodiesel fuel (B100) meeting ASTM specification D-6751

Fuel Oxidation Stability — Must Use Fuel Within Six Months Of Manufacture

Biodiesel fuel has poor oxidation stability which can result in long term storage problems. Fuel produced to approved ASTM standards, if stored properly, provides for protection against fuel oxidation for up to six months.

Fuel Water Separation — Must Use Mopar® Approved Fuel Filter Elements

Biodiesel fuel has a natural affinity to water and water accelerates microbial growth. Your Mopar® filtration system is designed to provide adequate fuel water separation capabilities.

Fuel In Oil Dilution — Must Adhere To Required Oil Change Interval

Fuel dilution of lubricating oil has been observed with the use of Biodiesel fuel. Fuel in oil must not exceed 5%. To ensure this limit is met your oil change interval must be maintained with in the suggested schedule. The regular use of biodiesel between 6% and 20% requires intervals shorter than the outlined 10,000 miles (16,100 km) and must not exceed the suggested schedule. When

routinely operating on biodiesel between 6% and 20%, oil and filter replacement intervals must not exceed 8,000 Miles (12,900 km) or six months, which ever comes first.

Biodiesel Fuel Filter Change Intervals

The use of biodiesel requires more frequent fuel filter change intervals. When operating on biodiesel between 6% and 20%, fuel filter replacement intervals should be every second oil change, and must not exceed 16,000 miles (25,750 km).

NOTE:

Under no circumstances should oil change intervals exceed 8,000 miles (12,875 km) or six months, if regular operation occurs with 6% - 20% biodiesel blends. Under no circumstances should fuel filter replacement intervals exceed every second oil change and must not exceed 16,000 miles (25,750 km), if regular operation occurs with 6% - 20% biodiesel blends. Failure to comply with these oil change and fuel filter requirements for vehicles operating on biodiesel blends up to B20 may result in premature engine wear. Such wear is not covered by the New Vehicle Limited Warranty. The engine may suffer severe damage if operated with concentrations of biodiesel higher than 20%.

448 TECHNICAL SPECIFICATIONS**FLUID CAPACITIES**

| | US | Metric |
|--|-------------|-------------|
| Fuel (Approximate) | | |
| 1500 Regular Cab Shortbed/Crew Quad Cab Models | 23 Gallons | 87 Liters |
| 1500 Regular Cab Shortbed/Crew Quad Cab Models | 26 Gallons | 98 Liters |
| 1500 Regular Cab Longbed/Crew Quad Cab Models (Optional) | 33 Gallons | 121 Liters |
| Engine Oil With Filter | | |
| 3.6L Engine | 5 Quarts | 4.7 Liters |
| 5.7L Engine | 7 Quarts | 6.6 Liters |
| Cooling System | | |
| 3.6L Engine | 13.7 Quarts | 13 Liters |
| 3.6L Motor Generator Unit | 1.8 Quarts | 1.7 Liters |
| 5.7L Engine | 18.3 Quarts | 17.3 Liters |

| | US | Metric |
|----------------------------------|--------------|-------------|
| Fuel (Approximate) | | |
| 3.0L Turbo Diesel Engine | 26 Gallons | 98.5 Liters |
| Diesel Exhaust Fluid Tank | | |
| Tradesman/Rebel Models | 5.14 Gallons | 19.5 Liters |
| All Other Models | 5.74 Gallons | 21.7 Liters |
| Engine Oil With Filter | | |
| 3.0L Turbo Diesel Engine | 8.5 Quarts | 8.0 Liters |
| Cooling System | | |
| 3.0L Turbo Diesel Engine | 11.6 Quarts | 11 Liters |

ENGINE FLUIDS AND LUBRICANTS

| Component | Fluid, Lubricant, or Genuine Part |
|--|---|
| Gasoline Engine Coolant | We recommend you use Mopar® Antifreeze/Coolant 10 Year/150,000 Mile (240,000 km) Formula OAT (Organic Additive Technology). |
| Motor Generator Unit – 3.6L Engine (If Equipped) | We recommend you use Mopar® Antifreeze/Coolant 10 Year/150,000 Mile (240,000 km) Formula OAT (Organic Additive Technology). |

450 TECHNICAL SPECIFICATIONS

| Component | Fluid, Lubricant, or Genuine Part |
|---------------------------------|--|
| Engine Oil – 3.6L & 5.7L Engine | We recommend you use Mopar® SAE 0W-20 Full Synthetic Engine Oil which meets the requirements of the manufacturer Material Standard MS-6395. Equivalent full synthetic SAE 0W-20 engine oil can be used but must have the API Starburst trademark → page 385. |
| Gasoline Engine Oil Filter | We recommend you use a Mopar® Engine Oil Filter. If a Mopar® Engine Oil Filter is unavailable only use filters that meet or exceed SAE/USCAR-36 Filter Performance Requirements. |
| Fuel Selection – 3.6L Engine | 87 Octane (R+M)/2 Method, 0-15% ethanol (Do not use E-85). |
| Fuel Selection – 5.7L Engine | 89 Octane Recommended - 87 Octane Acceptable (R+M)/2 Method, 0-15% ethanol (Do not use E-85). |

| Component | Fluid, Lubricant, or Genuine Part |
|---------------------------------------|--|
| Diesel Engine Coolant | We recommend you use Mopar® Antifreeze/Coolant 10 Year/150,000 Mile (240,000 km) Formula OAT (Organic Additive Technology). |
| Engine Oil – 3.0L Turbo Diesel Engine | We recommend you use 5W-40 synthetic engine oil such as Mopar® that meets the manufacturer Material Standard MS-12991 and the API SP engine oil category is required. |

| Component | Fluid, Lubricant, or Genuine Part |
|---|--|
| Diesel Engine Oil Filter | We recommend you use Mopar® engine oil filters. Using an oil filter that does not meet the manufacturer's filtration requirements can severely impact engine life and reliability. |
| Fuel Filters – 3.0L Turbo Diesel Engine | We recommend you use Mopar® fuel filter. Must meet 3 micron rating. Using a fuel filter that does not meet the manufacturer's filtration and water separating requirements can severely impact fuel system life and reliability. Under normal conditions the diesel fuel filter should be replaced every 20,000 miles (32,000 km) (every other oil change). If the vehicle is being used in severe operating conditions, or In certain geographical areas of the country (Pennsylvania, New York, Ohio, Maryland, West Virginia, Arkansas, Oklahoma, Kansas, Iowa, Missouri and Nebraska) due to fuel cleanliness issues, it's recommended to replace the fuel filter every 10,000 miles (16,000 km). |

452 TECHNICAL SPECIFICATIONS

| Component | Fluid, Lubricant, or Genuine Part |
|---|--|
| Fuel Selection — 3.0L Turbo Diesel Engine | <p>Use good quality diesel fuel from a reputable supplier in your vehicle. Federal law requires that you must fuel this vehicle with Ultra Low Sulfur Highway Diesel fuel (15 ppm Sulfur maximum) and prohibits the use of Low Sulfur Highway Diesel fuel (500 ppm Sulfur maximum) to avoid damage to the emissions control system.</p> <p>For most year-round service, Number 2 diesel fuel meeting ASTM specification D-975 Grade S15 will provide good performance. We recommend you use a blend of up to 5% biodiesel, meeting ASTM specification D-975 with your diesel engine.</p> <p>This vehicle is compatible with biodiesel blends greater than 5% but no greater than 20% biodiesel meeting ASTM specification D-7467 provided the shortened maintenance intervals are followed as directed.</p> |
| Diesel Exhaust Fluid | Mopar® Diesel Exhaust Fluid (API Certified) (DEF) or equivalent that has been API Certified to the ISO 22241 standard. Use of fluids not API Certified to ISO 22241 may result in system damage. |

NOTE:

If Climatized or Number 1 ULSD fuel is not available, and you are operating below 20°F (-6°C), in sustained arctic conditions, Mopar® Premium Diesel Fuel Treatment (or equivalent) is recommended to avoid gelling.

CAUTION!

- Mixing of engine coolant (antifreeze) other than specified Organic Additive Technology (OAT) engine coolant (antifreeze), may result in engine damage and may decrease corrosion protection. Organic Additive Technology (OAT) engine coolant is different and should not be mixed with Hybrid Organic Additive Technology (HOAT) engine coolant (antifreeze) or any “globally compatible” coolant (antifreeze). If a non-OAT engine coolant (antifreeze) is introduced into the cooling system in an emergency, the cooling system will need to be drained, flushed, and refilled with fresh OAT coolant (conforming to MS.90032), by an authorized dealer as soon as possible.
- Do not use water alone or alcohol-based engine coolant (antifreeze) products. Do not use additional rust inhibitors or antirust products, as they may not be compatible with the radiator engine coolant and may plug the radiator.
- This vehicle has not been designed for use with propylene glycol-based engine coolant (antifreeze). Use of propylene glycol-based engine coolant (antifreeze) is not recommended.

454 TECHNICAL SPECIFICATIONS

CHASSIS FLUIDS AND LUBRICANTS

| Component | Fluid, Lubricant, or Genuine Part |
|--|---|
| Automatic Transmission | Use only Mopar® ZF 8 & 9 Speed ATF Automatic Transmission Fluid, or equivalent. Failure to use the correct fluid may affect the function or performance of your transmission. |
| Transfer Case - 48-11 Active On-Demand 2-speed Transfer Case (With 4WD AUTO) | We recommend you use Mobil Fluid LT. |
| Transfer Case - 48-12 Part Time 2-Speed Transfer Case (Without 4WD AUTO) | We recommend you use Shell Spirax S2 ATF A389. |
| Front Axle | We recommend you use Mopar® GL-5 Synthetic Axle Lubricant SAE 75W-85. |
| Rear Axle (3.21/3.55) | We recommend you use Mopar® Synthetic Gear Lubricant SAE 75W-90 (MS-A0160). Limited-Slip Rear Axles require the addition of 5 oz. (148 ml) Mopar® Limited Slip Additive (MS-10111). |
| Rear Axle (3.92) | We recommend you use Mopar® Synthetic Gear Lubricant SAE 75W-140 (MS-8985). Limited-Slip Rear Axles require the addition of 5 oz. (148 ml) Mopar® Limited Slip Additive (MS-10111). |
| Max Tow Rear Axle (3.92) | We recommend You Use Dana SAE 80W90 Axle Lubricant. |
| Brake Master Cylinder | We recommend you use Mopar® DOT 3 Brake Fluid, SAE J1709. |

CUSTOMER ASSISTANCE

SUGGESTIONS FOR OBTAINING SERVICE FOR YOUR VEHICLE

PREPARE FOR THE APPOINTMENT

All work to be performed may not be covered by the warranty. Discuss additional charges with the service manager. Keep a maintenance log of your vehicle's service history. This can often provide a clue to the current problem.

PREPARE A LIST

Make a written list of your vehicle's problems or the specific work you want done. If you've had an accident or work done that is not on your maintenance log, let the service advisor know.

BE REASONABLE WITH REQUESTS

If you list a number of items and you must have your vehicle by the end of the day, discuss the situation with the service advisor and list the items in order of priority. At many authorized dealers, you may obtain a rental vehicle (additional charges may apply). If you need a rental, it is advisable to make these arrangements when you call for an appointment.

IF YOU NEED ASSISTANCE

FCA US LLC and its authorized dealers are vitally interested in your satisfaction. We want you to be happy with our products and services.

Warranty service must be done by an authorized dealer. We strongly recommend that you take the vehicle to an authorized dealer. They know your vehicle the best, and are most concerned that you get prompt and high quality service. FCA US LLC's authorized dealers have the facilities, factory-trained technicians, special tools, and the latest information to ensure the vehicle is fixed correctly and in a timely manner.

This is why you should always talk to an authorized dealer's service manager first. If for some reason you are still not satisfied, talk to the general manager or owner of the authorized dealer. They want to know if you need assistance. If an authorized dealer is unable to resolve the concern, you may contact FCA US LLC's Customer Assistance center.

Any communication to FCA US LLC's customer center should include the following information:

- Owner's name and address
- Owner's telephone number (home, mobile, and office)
- Authorized dealer name
- Vehicle Identification Number (VIN)
- Vehicle delivery date and mileage

FCA US LLC CUSTOMER CENTER

P.O. Box 21-8004
Auburn Hills, MI 48321-8004
Phone: (866) 726-4636

FCA CANADA INC. CUSTOMER CENTER

P.O. Box 1621
Windsor, Ontario N9A 4H6
Phone: (800) 465-2001 English / (800) 387-9983
French

456 CUSTOMER ASSISTANCE

MEXICO

Av. Prolongacion Paseo de la Reforma, 1240
Sante Fe C.P. 05109
Mexico, D. F.
In Mexico City: 800-505-1300
Outside Mexico City: +(52) 55 50817568

PUERTO RICO AND US VIRGIN ISLANDS

FCA Caribbean LLC
P.O. Box 191857
San Juan 00919-1857
Phone: (866) 726-4636
Fax: (787) 782-3345

CUSTOMER ASSISTANCE FOR THE HEARING OR SPEECH IMPAIRED (TDD/TTY)

To assist customers who have hearing difficulties, FCA US LLC has installed special TDD (Telecommunication Devices for the Deaf) equipment at its customer center. Any hearing or speech impaired customer, who has access to a TDD or a conventional teletypewriter (TTY) in the United States, can communicate with FCA US LLC by dialing 1-800-380-2479.

Canadian residents with hearing difficulties that require assistance can use the special needs relay service offered by Bell Canada. For TTY teletypewriter users, dial 711 and for Voice callers, dial 1-800-855-0511 to connect with a Bell Relay Service operator.

SERVICE CONTRACT

You may have purchased a service contract for a vehicle to help protect you from the high cost of unexpected repairs after FCA US LLC's New Vehicle Limited Warranty expires. The Mopar® Vehicle Protection plans are the ONLY vehicle extended protection plans authorized, endorsed and backed by FCA US LLC to provide additional protection beyond your vehicle's warranty. If you purchased a Mopar® Vehicle Protection Plan, you will receive Plan Provisions and an Owner Identification Card in the mail within three weeks of the vehicle delivery date. If you have any questions about the service contract, call FCA US LLC's Service Contract National Customer Hotline at 1-800-521-9922 (Canadian residents, call (800) 465-2001 English / (800) 387-9983 French).

FCA US LLC is not responsible for any service contract you may have purchased from another manufacturer. If you require service after the FCA US LLC New Vehicle Limited Warranty expires, please refer to the contract documents, and contact the person listed in those documents.

We appreciate that you have made a major investment when you purchased the vehicle. An authorized dealer has also made a major investment in facilities, tools, and training to ensure that you are absolutely delighted with the ownership experience.

WARNING!

Engine exhaust (internal combustion engines only), some of its constituents, and certain vehicle components contain, or emit, chemicals known to the State of California to cause cancer and birth defects, or other reproductive harm. In addition, certain fluids contained in vehicles and certain products of component wear contain, or emit, chemicals known to the State of California to cause cancer and birth defects, or other reproductive harm.

WARRANTY INFORMATION

See the Warranty Information for the terms and provisions of FCA US LLC warranties applicable to this vehicle and market. Refer to www.mopar.com for further information.

See the Warranty Information for the terms and provisions of FCA Canada Inc. warranties applicable to this vehicle and market. Refer to www.owners.mopar.ca/en for further information.

Use this QR code to access your digital experience.



MOPAR® PARTS

Mopar® original equipment parts & accessories and factory filled fluids are available from an authorized dealer. They are recommended for your vehicle to keep it operating at its best and maintain its original condition.

REPORTING SAFETY DEFECTS

IN THE 50 UNITED STATES AND WASHINGTON, D.C.

If you believe that your vehicle has a defect that could cause a crash or cause injury or death, you should immediately inform the National Highway Traffic Safety Administration (NHTSA) in addition to notifying FCA US LLC.

If NHTSA receives similar complaints, it may open an investigation, and if it finds that a safety defect exists in a group of vehicles, it may order a recall and remedy campaign. However, NHTSA cannot become involved in individual problems between you, an authorized dealer or FCA US LLC.

To contact NHTSA, you may call the Vehicle Safety Hotline toll free at 1-888-327-4236 (TTY: 1-800-424-9153); or go to <http://www.safercar.gov>; or write to: Administrator, NHTSA, 1200 New Jersey Avenue, SE., West Building, Washington, D.C. 20590. You can also obtain other information about motor vehicle safety from <http://www.safercar.gov>.

IN CANADA

If you believe that your vehicle has a safety defect, you should contact the Customer Service Department immediately. Canadian customers who wish to report a safety defect to the Canadian government should contact Transport Canada, Motor Vehicle Defect Investigations and Recalls at 1-800-333-0510 or go to www.apps.tc.gc.ca/Saf-Sec-Sur/7/PCDB-BDPP.

458 CUSTOMER ASSISTANCE

PUBLICATION ORDER FORMS

To order the following manuals, you may use either the website or the phone numbers listed below.

Service Manuals

These comprehensive Service Manuals provide a complete working knowledge of the vehicle, system, and/or components and is written in straightforward language with illustrations, diagrams, and charts.

Diagnostic Procedure Manuals

Diagnostic Procedure Manuals are filled with diagrams, charts and detailed illustrations. These manuals make it easy to find and fix problems on computer-controlled vehicle systems and features. They show exactly how to find and correct problems, using step-by-step troubleshooting and drivability procedures, proven diagnostic tests and a complete list of all tools and equipment.

To order a hard copy of your Service or Diagnostic Procedure manuals, visit:

www.techauthority.com (US and Canada).

Owner's Manuals

These Owner's Manuals have been prepared with the assistance of service and engineering specialists to acquaint you with specific FCA vehicles.

To access your Owner's Information online, visit www.mopar.com/om (US) or www.owners.mopar.ca (Canada).

Or

Call Tech Authority toll free at:

● 1-800-890-4038 (US)

Owner's Manuals, Radio Manuals and Warranty Information Books can be ordered through Archway at:

● 1-800-387-1143 (Canada)

GENERAL INFORMATION

The following regulatory statement applies to all Radio Frequency (RF) devices equipped in this vehicle:

This device complies with Part 15 of the FCC Rules and with Innovation, Science and Economic Development Canada license-exempt RSS standard(s). Operation is subject to the following two conditions:

1. This device may not cause harmful interference, and
2. This device must accept any interference received, including interference that may cause undesired operation.

Le présent appareil est conforme aux CNR d'Innovation, Science and Economic Development applicables aux appareils radio exempts de licence. L'exploitation est autorisée aux deux conditions suivantes:

1. l'appareil ne doit pas produire de brouillage, et
2. l'utilisateur de l'appareil doit accepter tout brouillage radioélectrique subi, même si le brouillage est susceptible d'en compromettre le fonctionnement.

La operación de este equipo está sujeta a las siguientes dos condiciones:

1. es posible que este equipo o dispositivo no cause interferencia perjudicial y
2. este equipo o dispositivo debe aceptar cualquier interferencia, incluyendo la que pueda causar su operación no deseada.

NOTE:

Changes or modifications not expressly approved by the party responsible for compliance could void the user's authority to operate the equipment.

INDEX

- A**
- Accessory Drive Belt Inspection.....393
 - Adaptive Cruise Control (ACC)
(Cruise Control).....133, 138, 139, 177, 179
 - Adding Engine Coolant (Antifreeze)397
 - Adding Fuel..... 209, 210
 - Additives, Fuel444
 - Adjust
 - Down38
 - Forward38
 - Rearward.....38
 - Up.....38
 - Adjustable Pedals.....44
 - Advance Phone Connectivity279
 - Air Bag
 - Air Bag Operation322
 - Air Bag Warning Light 320, 322
 - Enhanced Accident Response..... 329, 369
 - Event Data Recorder (EDR)369
 - Front Air Bag322
 - If Deployment Occurs.....328
 - Knee Impact Bolsters.....326
 - Maintaining Your Air Bag System330
 - Maintenance330
 - Redundant Air Bag Warning Light320
 - Transporting Pets.....345
 - Air Bag Light.....130, 320, 345
 - Air Cleaner, Engine (Engine Air Cleaner Filter)...386
 - Air Conditioner Maintenance390
 - Air Conditioner Refrigerant390, 391
 - Air Conditioner System390
 - Air Conditioning.....63, 66
 - Air Conditioning Filter.....69, 391
 - Air Conditioning System68
 - Air Conditioning, Operating Tips.....68
 - Air Filter386
 - Air Pressure
 - Tires427
 - Air Suspension..... 133, 136, 137, 166, 170
 - Alarm
 - Security Alarm28, 133
 - Alterations/Modifications
 - Vehicle.....13
 - Antifreeze (Engine Coolant)397, 448
 - Disposal398
 - Anti-Lock Brake System (ABS)290
 - Anti-Lock Warning Light133
 - Assist, Hill Start.....296
 - Audio Settings.....267
 - Audio Systems (Radio).....236
 - Auto Down Power Windows79
 - Automatic Door Locks.....33
 - Automatic Headlights.....56
 - Automatic High Beams.....55
 - Automatic Tailgate Release86
 - Automatic Temperature Control (ATC).....68
 - Automatic Transmission.....156, 401
 - Adding Fluid401
 - Fluid And Filter Change.....401
 - Fluid Change.....401
 - Fluid Level Check.....400, 401
 - Fluid Type401, 454
 - Special Additives400
 - Automatic Transmission Limp Home Mode...159
 - AutoPark144
 - AUX Camera205
 - Auxiliary Driving Systems298
 - Axle Fluid.....401, 454
 - Axle Locker System173
 - Axle Lubrication401
- B**
- Back-Up Camera200
 - Battery131, 384
 - Charging System Light131
 - Keyless Key Fob Replacement21
 - Battery Saver Feature59
 - Bed Divider96

| | | | | | |
|---|----------|---|----------|---|---------------|
| Bed Step..... | 89 | Caps, Filler | | Climate Control | 62 |
| Bedliner | 439 | Oil (Engine) | 380 | Automatic | 63 |
| Belts, Seat | 345 | Radiator (Coolant Pressure) | 398 | Manual | 66 |
| Blind Spot Monitoring | 298 | Car Washes..... | 438 | Cold Weather Operation..... | 147 |
| Bluetooth | | Carbon Monoxide Warning..... | 347 | Compact Spare Tire | 431 |
| Connecting To A Particular Mobile Phone | | Care And Maintenance | 437 | Contract, Service..... | 456 |
| Or Audio Device After Pairing | 275 | Cargo Light..... | 58, 137 | Controls | 261 |
| Body Builders Guide | 11 | CD | 269 | Cooling Pressure Cap (Radiator Cap) | 398 |
| Body Mechanism Lubrication | 394 | Cellular Phone | 281 | Cooling System | 132, 396 |
| Bodywork..... | 437 | Center High Mounted Stop Light..... | 418 | Adding Coolant (Antifreeze) | 397 |
| B-Pillar Location..... | 424 | Center Seat Storage Compartment..... | 70 | Coolant Level | 396, 398 |
| Brake Assist System | 291 | Charge Air Cooler | 399 | Cooling Capacity | 448 |
| Brake Control System | 291 | Chart, Tire Sizing..... | 420 | Disposal Of Used Coolant | 398 |
| Brake Fluid | 400, 454 | Check Engine Light (Malfunction | | Drain, Flush, And Refill | 397 |
| Brake System | 400, 442 | Indicator Light)..... | 140 | Inspection | 398 |
| Fluid Check | 400 | Checking Your Vehicle For Safety | 345 | Points To Remember | 399 |
| Master Cylinder..... | 400 | Checks, Safety | 345 | Pressure Cap | 398 |
| Parking..... | 151 | Child Restraint | 331 | Radiator Cap..... | 398 |
| Warning Light..... | 130 | Child Restraints | | Selection Of Coolant | |
| Brake/Transmission Interlock | 155 | Booster Seats..... | 334 | (Antifreeze)..... | 397, 448, 449 |
| Bulb Replacement | 413 | Child Seat Installation | 340, 342 | Corrosion Protection | 437 |
| Bulbs, Light..... | 347, 413 | How To Stow An unused ALR Seat Belt | 339 | Cruise Control | |
| C | | Infant And Child Restraints..... | 333 | Accel/Decel | 179 |
| Camera..... | 200 | Locating The LATCH Anchorages | 338 | Cancel..... | 179 |
| Camera, AUX..... | 205 | Lower Anchors And Tethers For Children.. | 336 | Resume | 179 |
| Camera, Rear | 200 | Older Children And Child Restraints | 333 | Cruise Control (Speed Control).... | 135, 177, 179 |
| Camera, Surround View | 202 | Seating Positions..... | 335 | Cruise Light | 138, 139 |
| Camera, Trailer 360 | 205 | Clean Air Gasoline..... | 444 | Customer Assistance | 455 |
| Capacities, Fuel | 448 | Cleaning | | Cybersecurity | 236, 259 |
| | | Wheels | 433 | | |

| | | | |
|--|-------------|--|--------------------|
| D | | | |
| Daytime Running Lights..... | 55 | | |
| Dealer Service | 385 | | |
| Defroster, Windshield | 63, 66, 345 | | |
| Deleting A Phone | 275 | | |
| Diagnostic System, Onboard | 140 | | |
| Diesel Exhaust Fluid | 211 | | |
| Adding..... | 211 | | |
| Fill Procedure | 212 | | |
| Storage..... | 211 | | |
| Diesel Fuel..... | 445 | | |
| Diesel Fuel Requirements | 445 | | |
| Bulk Storage Of | 211 | | |
| Diesel Fuel System, Re-Priming..... | 389 | | |
| Differential, Limited Slip | 174 | | |
| Dimmer Control Switch | 60 | | |
| Disable Vehicle Towing..... | 367 | | |
| Disc Drive | 269 | | |
| Disconnecting..... | 275 | | |
| Disposal | | | |
| Antifreeze (Engine Coolant)..... | 398 | | |
| Disturb..... | 278 | | |
| Door Ajar Light..... | 131, 133 | | |
| Door Locks | | | |
| Automatic..... | 33 | | |
| Doors..... | 29 | | |
| Draining Fuel/Water Separator Filter | 388 | | |
| Driver Memory Presets | 267 | | |
| Driver's Seat Back Tilt | 36 | | |
| | | Driving | |
| | | Through Flowing, Rising, Or Shallow | |
| | | Standing Water | 234 |
| | | Driving Tips | 233 |
| | | Dual Rear Wheels | 442 |
| | | E | |
| | | Electric Brake Control System..... | 291 |
| | | Anti-Lock Brake System..... | 290 |
| | | Electronic Roll Mitigation | 291, 297 |
| | | Electric Parking Brake..... | 151 |
| | | Electric Power Steering..... | 174 |
| | | Electrical Power Outlets | 76 |
| | | Electronic Range Select (ERS) | 159 |
| | | Electronic Stability Control (ESC) | 134, 292 |
| | | Electronic Throttle Control Warning Light..... | 131 |
| | | Electronically Shifted Transfer Case | 162, 164 |
| | | Emergency Braking..... | 306 |
| | | Emergency Gas Can Refueling..... | 363 |
| | | Emergency, In Case Of | |
| | | Freeing Vehicle When Stuck..... | 366 |
| | | Hazard Warning Flasher | 348 |
| | | Jump Starting | 361 |
| | | Emission Control System Maintenance | 140 |
| | | Engine..... | 380 |
| | | Air Cleaner..... | 386 |
| | | Block Heater..... | 150 |
| | | Break-In Recommendations | 151 |
| | | Compartment | 380, 381, 382, 383 |
| | | Compartment | |
| | | Identification | 380, 381, 382, 383 |
| | | Coolant (Antifreeze) | 449 |
| | | Exhaust Gas Caution | 347 |
| | | Fails To Start..... | 145 |
| | | Flooded, Starting..... | 145 |
| | | Fuel Requirements | 443, 448 |
| | | Idling..... | 148 |
| | | Jump Starting | 361 |
| | | Oil | 385, 448, 449 |
| | | Oil Filler Cap | 380 |
| | | Oil Filter | 386 |
| | | Oil Selection..... | 385, 448 |
| | | Oil Synthetic..... | 386 |
| | | Oil Temperature..... | 132 |
| | | Overheating | 364 |
| | | Starting..... | 143, 146 |
| | | Enhanced Accident Response Feature... | 329, 369 |
| | | Entry System, Illuminated | 61 |
| | | Ethanol..... | 444 |
| | | Exhaust Gas Cautions | 347 |
| | | Exhaust System | 347, 395 |
| | | Exterior Lights | 54, 347 |
| | | F | |
| | | Filters | |
| | | Air Cleaner | 386 |
| | | Air Conditioning | 69, 391 |
| | | Engine Fuel..... | 388 |

| | | | | | |
|--------------------------------|--------------------|---------------------------------------|---------------|--|----------|
| Engine Oil..... | 386, 449 | Octane Rating..... | 443, 449 | Head Restraints..... | 41 |
| Engine Oil Disposal | 386 | Requirements..... | 443, 445, 448 | Head Rests | 41 |
| Flashers | | Specifications..... | 446 | Headlights..... | 138, 415 |
| Turn Signals | 139, 347 | Tank Capacity..... | 448 | Cleaning..... | 438 |
| Flash-To-Pass | 56 | Fuel Saver Technology..... | 175 | Delay | 57 |
| Flat Tire Stowage..... | 359 | Fuses | 402 | High Beam..... | 55, 139 |
| Fluid Capacities | 448 | G | | High Beam/Low Beam Select Switch | 55 |
| Fluid Leaks | 347 | Garage Door Opener (HomeLink)..... | 50 | Lights On Reminder | 57 |
| Fluid Level Checks | | Gasoline, Clean Air..... | 444 | On With Wipers..... | 56 |
| Brake | 400 | Gasoline, Reformulated | 444 | Passing..... | 56 |
| Fluid, Brake | 454 | Gauges | | Switch | 54 |
| Fog Lights | 57, 138, 417 | Voltage | 147 | Heads Up Display (HUD)..... | 121, 125 |
| Fold-Flat Seats..... | 36 | Glass Cleaning..... | 441 | Heated Mirrors | 49 |
| Forward Collision Warning..... | 135, 137, 304 | Grocery Bag Retainer..... | 41 | Heated Seats | 40 |
| Four Wheel Drive | 135, 137, 139, 162 | Gross Axle Weight Rating..... | 215 | Heated Steering Wheel | 34 |
| Four-Way Hazard Flasher..... | 348 | Gross Combination Weight Rating | 215 | Heater, Engine Block..... | 150 |
| Freeing A Stuck Vehicle | 366 | Gross Trailer Weight | 214 | High Beam/Low Beam Select (Dimmer) Switch .. | 55 |
| Front Axle (Differential)..... | 401 | Gross Vehicle Weight Rating..... | 214 | Hill Descent Control | 139, 294 |
| Fuel | 210, 443, 445 | Guide | | Hill Descent Control Indicator | 294 |
| Adding..... | 209, 210 | Body Builders | 11 | Hill Start Assist..... | 296 |
| Additives | 444 | GVWR..... | 213 | Hitches | |
| Clean Air..... | 444 | H | | Trailer Towing | 218 |
| Ethanol..... | 444 | Hazard | | HomeLink (Garage Door Opener) | 50 |
| Filter..... | 388 | Driving Through Flowing, Rising, Or | | Hood | |
| Gasoline | 443 | Shallow Standing Water | 234 | Opening | 132 |
| Light | 134 | Hazard Warning Flashers..... | 348 | Hood Release..... | 85 |
| Materials Added..... | 444 | | | HUD..... | 121, 125 |
| Methanol..... | 444 | | | | |

| | | 463 |
|---|------------------------------|-----|
| I | | |
| Ignition | 23 | |
| Switch | 23 | |
| Ignition Park Interlock..... | 155 | |
| Illuminated Entry | 61 | |
| Inside Rearview Mirror..... | 45, 349 | |
| Instrument | | |
| Cluster | 105, 107, 109, 110, 112, 113 | |
| Descriptions | 106, 108, 110, 113 | |
| Display | 114 | |
| Engine Oil Reset | 115 | |
| Location And Controls | 114 | |
| Menu Items..... | 116 | |
| Instrument Cluster Display | | |
| Audio | 120 | |
| Driver Assist | 117 | |
| Fuel Economy..... | 120 | |
| Off-Road..... | 116 | |
| Speedometer | 116 | |
| StopStart..... | 120 | |
| Stored Messages | 121 | |
| Trailer Tow..... | 120 | |
| Trip..... | 120 | |
| Vehicle Info | 116 | |
| Instrument Panel Lens Cleaning..... | 441 | |
| Integrated Trailer Brake Control | 223 | |
| Interior Appearance Care..... | 440 | |
| Interior Lights..... | 59 | |
| Intervention Regeneration Strategy | 126, 390 | |
| Inverter Outlet (115V)..... | 77 | |
| J | | |
| Jack Location..... | 352 | |
| Jump Starting | 361 | |
| K | | |
| Key Fob..... | 19 | |
| Programming Additional Key Fobs..... | 22 | |
| Key Fob Battery Replacement | 21 | |
| Key Fob Programming (Remote Keyless Entry) .. | 22 | |
| Keyless Enter-N-Go | 30, 143 | |
| Passive Entry..... | 30 | |
| Keys..... | 19 | |
| L | | |
| Lane Change Assist | 58 | |
| LaneSense..... | 134, 138, 139, 198 | |
| Lap/Shoulder Belts..... | 314 | |
| Latches..... | 347 | |
| Hood..... | 85 | |
| Lead Free Gasoline..... | 443 | |
| Leaks, Fluid | 347 | |
| Life Of Tires..... | 429 | |
| Light Bulbs..... | 347, 413 | |
| Lights | 347 | |
| 4WD..... | 137 | |
| 4WD AUTO | 139 | |
| 4WD High | 137 | |
| 4WD Low | 137 | |
| Air Bag..... | 130, 320, 345 | |
| Air Suspension Aerodynamic Height..... | 137 | |
| Air Suspension Fault..... | 133 | |
| Air Suspension Off-Road 1..... | 136 | |
| Air Suspension Off-Road 2..... | 136 | |
| Air Suspension Payload Protection | 136 | |
| Air Suspension Ride Height Lowering | 137 | |
| Air Suspension Ride Height Raising..... | 137 | |
| Anti-Lock Brake System | 133 | |
| Brake Assist Warning..... | 294 | |
| Brake Warning..... | 130 | |
| Bulb Replacement | 413 | |
| Cargo | 58, 137 | |
| Center Mounted Stop | 418 | |
| Courtesy/Reading..... | 59 | |
| Cruise | 138, 139 | |
| Daytime Running | 55 | |
| ECO Mode..... | 138 | |
| Electric Power Steering..... | 132 | |
| Electronic Park Brake | 134 | |
| Electronic Stability Control..... | 134 | |
| Electronic Throttle Control | 131 | |
| Engine Coolant Temperature | 132 | |

| | | | | | |
|--|----------|---|---------------|-------------------------------------|---------|
| Exterior..... | 54, 347 | Traction Control..... | 294 | Media Hub | 74 |
| Fog..... | 138, 417 | Transmission Temperature..... | 133 | Media Mode..... | 269 |
| Forward Collision Warning..... | 137 | Turn Signals | 139, 415 | Memory Seat..... | 34 |
| Hazard Warning Flasher..... | 348 | Wait To Start..... | 138 | Memory Settings | 34 |
| Headlights..... | 54, 56 | Warning Instrument Cluster Descriptions..... | 139 | Methanol..... | 444 |
| High Beam | 55, 139 | Limited-Slip Differential | 174, 401 | Mirrors | 45 |
| High Beam/Low Beam Select | 55 | Load Shed Battery Saver Mode | 129 | Automatic Dimming | 45 |
| Hill Descent Control Indicator..... | 139, 294 | Load Shed Battery Saver On..... | 129 | Digital | 46 |
| Hood Open | 132 | Load Shed Electrical Load Reduction | 129 | Electric Powered..... | 48 |
| Illuminated Entry | 61 | Load Shed Intelligent Battery Sensor..... | 129 | Heated..... | 49 |
| Interior | 59 | Loading Vehicle | 213 | Manual Dimming | 45 |
| LaneSense | 138, 139 | Tires | 424 | Memory | 34 |
| Lights On Reminder..... | 57 | Locks | | Outside | 47 |
| Low Diesel Exhaust Fluid..... | 137 | Automatic Door..... | 33 | Power Folding | 48 |
| Low Fuel..... | 138 | Child Protection | 33 | Rearview..... | 45, 349 |
| Malfunction Indicator (Check Engine) | 134 | Power Door..... | 30 | Tilt Side In Reverse..... | 49 |
| NEUTRAL | 137 | Low Tire Pressure System..... | 306 | Trailer Towing | 49 |
| Oil Temperature | 132 | Lubrication, Body..... | 394 | Vanity..... | 46 |
| Passing..... | 56 | Lug Nuts | 442 | Modifications/Alterations | |
| Rear Axle Lock..... | 137 | Lug Nuts/Bolts..... | 442 | Vehicle..... | 13 |
| Rear Axle Lock Fault..... | 135 | M | | Monitor, Tire Pressure System | 306 |
| Rear Tail Lamps | 417 | Maintenance..... | 82, 85 | Mopar Parts | 457 |
| Seat Belt Reminder..... | 132 | Maintenance Free Battery | 384 | MP3 Control | 74 |
| Security Alarm..... | 133 | Maintenance Schedule..... | 370, 375, 376 | Multi-Function Control Lever | 55 |
| Service | 413 | Malfunction Indicator Light (Check Engine) .. | 134 | Multifunction Tailgate | 86 |
| Service Stop Start | 135 | Manual | | N | |
| Stop Start Active..... | 138 | Service | 458 | New Vehicle Break-In Period | 151 |
| TOW HAUL | 137 | | | | |

| | | | | |
|--------------------------------------|----------|--|----------|---|
| O | | Onboard Diagnostic System..... | 140 | Power |
| Occupant Restraints | 312 | Operating Precautions | 140 | Distribution Center (Fuses)..... |
| Octane Rating, Gasoline (Fuel) | 443 | Operator Manual | | Door Locks..... |
| Off Road Pages..... | 285 | Owner's Manual..... | 458 | Mirrors |
| Accessory Gauges | 287 | Outside Rearview Mirrors | 47 | Outlet (Auxiliary Electrical Outlet)..... |
| Pitch And Roll | 288 | Overheating, Engine..... | 364 | Seats |
| Status Bar | 286 | P | | Side Steps |
| Vehicle Dynamics | 287 | Paddle Shifters | 160 | Sliding Rear Window..... |
| Off-Pavement Driving (Off-Road)..... | 235 | Paint Care | 437 | Steering..... |
| Off-Road Driving (Off-Pavement)..... | 235 | Pair (Link) Uconnect Phone To A | | Sunroof..... |
| Oil Filter, Change | 386 | Mobile Phone  | 274 | Windows |
| Oil Filter, Selection..... | 386 | Parallel Parking..... | 195 | Power Seats |
| Oil Pressure Light | 132 | Parking Brake | 134, 151 | Down |
| Oil, Engine | 385, 449 | Parking Lights | 56 | Forward |
| Capacity | 448 | ParkSense Active Park Assist..... | 194 | Rearward |
| Dipstick | 384 | ParkSense System, Rear | 188 | Recline..... |
| Disposal | 386 | Passive Entry | 30 | Tilt..... |
| Filter..... | 386, 449 | Pedals, Adjustable | 44 | Up |
| Filter Disposal | 386 | Pedestrian Warning System..... | 306 | Power Steering..... |
| Identification Logo..... | 385 | Performance Features | 117 | Pregnant Women And Seat Belts |
| Materials Added To | 386 | Pets | 345 | Presets..... |
| Pressure Warning Light | 132 | Phone Mode | 271 | Pressure Washing |
| Recommendation..... | 385, 448 | Pickup Box | 91, 93 | Pretensioners |
| Synthetic | 386 | Pinch Protection | 82, 84 | Seat Belts |
| Viscosity | 448 | Placard, Tire And Loading Information..... | 424 | Profile Settings..... |

R

| | |
|---|----------|
| Radial Ply Tires | 428 |
| Radiator Cap (Coolant Pressure Cap) .. | 397, 398 |
| Radio | |
| Off Road Pages | 285 |
| Presets | 267 |
| Settings | 237 |
| Sound Setting | 253 |
| Radio Controls | 261 |
| Radio Mode | 261 |
| Radio Operation | 261, 281 |
| Radio Remote Controls | 260 |
| Rain Sensitive Wiper System | 62 |
| RamBox | 93 |
| RamBox Safety | 95 |
| Rear Axle (Differential) | 401 |
| Rear Cargo Area Utility Rails | 92 |
| Rear Cross Path | 300 |
| Rear ParkSense System | 188 |
| Rear Window, Sliding | 81 |
| Reclining Rear Seats | 38 |
| Recreational Towing | 230 |
| Four-Wheel Drive Models | 231 |
| Shifting Into Transfer Case Neutral (N) | 232 |
| Shifting Out Of Transfer Case Neutral (N) .. | 233 |
| Two-Wheel Drive Models | 231 |
| Reformulated Gasoline | 444 |
| Refrigerant | 391 |

| | |
|---|--------|
| Release, Hood | 85 |
| Release, Tailgate | 86 |
| Reminder, Seat Belt | 313 |
| Remote Keyless Entry | |
| Programming Additional Key Fobs | 22 |
| Remote Sound System (Radio) Control | 260 |
| Remote Start (Diesel) | 27 |
| Remote Start (Gasoline) | 24 |
| Remote Starting | |
| Comfort Systems | 26 |
| Exit Remote Start Mode | 26 |
| Remote Starting System | 24, 27 |
| Remove, Tailgate | 87 |
| Replacement Bulbs | 413 |
| Replacement Tires | 430 |
| Reporting Safety Defects | 457 |
| Restraints, Child | 331 |
| Restraints, Head | 41 |
| Rotation, Tires | 436 |

S

| | |
|-------------------------------------|-----|
| Safety | 259 |
| Safety Checks Inside Vehicle | 345 |
| Safety Checks Outside Vehicle | 347 |
| Safety Defects, Reporting | 457 |
| Safety Features | 259 |
| Safety Information, Tire | 418 |
| Safety Tips | 345 |

| | |
|---|---------------|
| Safety, Exhaust Gas | 347 |
| Satellite Radio | 263 |
| Saved Radio Stations | 267 |
| Schedule, Maintenance | 370, 375, 376 |
| Seat Belt Reminder | 132 |
| Seat Belts | 313, 345 |
| Adjustable Shoulder Belt | 317 |
| Adjustable Upper Shoulder Anchorage | 317 |
| Adjustable Upper Shoulder Belt Anchorage .. | 317 |
| Automatic Locking Retractor (ALR) | 318 |
| Child Restraints | 331 |
| Energy Management Feature | 318 |
| Extender | 317 |
| Front Seat | 313, 314, 316 |
| Inspection | 345 |
| Lap/Shoulder Belt Operation | 316 |
| Lap/Shoulder Belt Untwisting | 316 |
| Lap/Shoulder Belts | 314 |
| Operating Instructions | 316 |
| Pregnant Women | 318 |
| Pretensioners | 318 |
| Rear Seat | 314 |
| Reminder | 313 |
| Seat Belt Extender | 317 |
| Seat Belt Pretensioner | 318 |
| Seat Belt Reminder | 313 |
| Untwisting Procedure | 316 |
| Seat Belts Maintenance | 440 |

| | | |
|---|----------------|------------|
| | | 467 |
| Seats | 36, 37, 38 | |
| Adjustment..... | 36, 38 | |
| Easy Entry | 39 | |
| Head Restraints | 41 | |
| Memory..... | 34 | |
| Power | 38 | |
| Rear Folding..... | 36 | |
| Reclining Rear..... | 38 | |
| Tilting | 36 | |
| Second Row USB..... | 74 | |
| Security System | 28, 133 | |
| Selection Of Coolant (Antifreeze)..... | 449 | |
| Sentry Key (Immobilizer)..... | 23 | |
| Service Assistance..... | 455 | |
| Service Contract | 456 | |
| Service Manuals..... | 458 | |
| Settings, Audio | 267 | |
| Shifting | 154 | |
| Automatic Transmission..... | 156 | |
| Transfer Case, Shifting Into Transfer | | |
| Case Neutral (N) | 137, 232 | |
| Transfer Case, Shifting Out Of | | |
| Transfer Case Neutral (N) | 233 | |
| Shoulder Belts..... | 314 | |
| Side Steps, Power..... | 30 | |
| Signals, Turn..... | 57, 139, 347 | |
| Sirius Satellite Radio | 263 | |
| Favorites | 266 | |
| Replay | 264 | |
| SiriusXM Satellite Radio | | |
| Browse in SXM | 266 | |
| Favorites..... | 266 | |
| Replay | 264 | |
| Sliding Rear Window, Power | 80 | |
| Snow Chains (Tire Chains)..... | 434 | |
| Snow Plow | 228 | |
| Snow Tires | 431 | |
| Spare Tires | 431, 432 | |
| Speed Control (Cruise Control) | 179 | |
| Starting..... | 142, 143, 146 | |
| Automatic Transmission | 143 | |
| Button | 23 | |
| Cold Weather..... | 147 | |
| Engine Fails To Start..... | 145 | |
| Starting And Operating..... | 138, 143, 146 | |
| Starting Procedures | 143, 146 | |
| Steering | | |
| Power | 174 | |
| Tilt Column | 33 | |
| Wheel, Heated..... | 33, 34 | |
| Wheel, Tilt..... | 33 | |
| Wheel, Voice Recognition | 43 | |
| Steering Wheel Audio Controls | 260 | |
| Steering Wheel Mounted Sound System | 260 | |
| Steps, Power Side..... | 30 | |
| Stop/Start..... | 135, 175 | |
| Storage | 69 | |
| Below Seat..... | 74 | |
| Door..... | 70 | |
| Front Bench Seat..... | 72 | |
| Glove Compartment..... | 69 | |
| In Floor | 73 | |
| Rear Console | 73 | |
| Storage Compartment, Center Seat | 70 | |
| Storage, Vehicle | 68, 437 | |
| Store Radio Presets | 267 | |
| Storing Your Vehicle | 437 | |
| Sun Roof | 81, 82, 83, 85 | |
| Sunglasses Storage | 72 | |
| Sunshade Operation | 82, 84 | |
| Surround View Camera | 202 | |
| Suspension | | |
| Air | 166, 170 | |
| Sway Control, Trailer | 297 | |
| Symbol Glossary..... | 13 | |
| Synthetic Engine Oil | 386 | |
| T | | |
| Tailgate | 86 | |
| Tailgate Removal | 87 | |
| Tailgate, Electronic Lowering | 86 | |
| Tailgate, Multifunction | 86 | |
| Telescoping Steering Column..... | 33 | |
| Temperature Control, Automatic (ATC)..... | 68 | |

| | | | |
|--|--------------------|--|---------------|
| Tilt | | | |
| Down | 39 | Radial | 428 |
| Up..... | 39 | Replacement | 430 |
| Tilt Steering Column | 33 | Rotation..... | 436 |
| Tip Start..... | 143 | Run Flat..... | 429 |
| Tire And Loading Information Placard | 424 | Safety | 418, 427 |
| Tire Identification Number (TIN) | 422 | Sizes..... | 420 |
| Tire Markings..... | 419 | Snow Tires..... | 431 |
| Tire Safety Information | 418 | Spare Tires | 431, 432 |
| Tire Terminology And Definitions | 423 | Spinning | 429 |
| Tires..... | 347, 427, 431, 436 | Trailer Towing..... | 222 |
| Aging (Life Of Tires) | 429 | Tread Wear Indicators | 429 |
| Air Pressure..... | 427 | Types | 430 |
| Chains | 434 | Wheel Nut Torque..... | 442 |
| Compact Spare | 431 | To Open Hood | 85 |
| Dual..... | 442 | Tongue Weight/Trailer Weight | 215, 219 |
| General Information | 427, 431 | Tonneau Cover..... | 97, 438 |
| High Speed..... | 428 | Tonneau Cover Cleaning..... | 438 |
| Inflation Pressure..... | 427 | Tow/Haul Mode | 161 |
| Life Of Tires..... | 429 | Towing | 137, 214, 367 |
| Load Capacity..... | 424 | Disabled Vehicle..... | 367 |
| Pressure Monitoring System (TPMS).... | 135, 306 | Guide..... | 218 |
| Quality Grading..... | 436 | Recreational | 230 |
| | | Weight | 218 |
| | | Towing Behind A Motorhome | 230 |
| | | Traction | 233 |
| | | Traction Control | 297 |
| | | Trailer Reverse Steering Control | 219 |
| | | Trailer Sway Control (TSC)..... | 215, 297 |
| | | Trailer Tire Pressure..... | 310 |
| | | Trailer Towing..... | 133, 214 |
| | | Frontal Area | 215 |
| | | Hitches | 218 |
| | | Minimum Requirements | 221 |
| | | Mirrors | 49 |
| | | Tips..... | 227 |
| | | Trailer And Tongue Weight..... | 219 |
| | | Weight Carrying Hitch | 215 |
| | | Weight Distributing Hitch | 215 |
| | | Wiring | 225 |
| | | Trailer Towing Guide | 218 |
| | | Trailer Weight..... | 218 |
| | | Transfer Case..... | 402 |
| | | Electronically Shifted | 162, 164 |
| | | Fluid..... | 454 |

| | | | | | |
|---|-------------------|---|----------|---|---------|
| Transmission | 156 | Uconnect Phone | 273, 274 | Pair (Link) Uconnect Phone To A | |
| Automatic..... | 156, 400 | Answer Or Ignore An Incoming Call – | | Mobile Phone | 274 |
| Fluid | 454 | Call Currently In Progress..... | 278 | Phonebook Download..... | 276 |
| Maintenance | 400 | Answer Or Ignore An Incoming Call – | | Place/Retrieve A Call From Hold..... | 278 |
| Shifting..... | 154 | No Call Currently In Progress..... | 278 | Power-Up | 281 |
| Temperature | 133 | Bluetooth Communication Link | 281 | Recent Calls..... | 277 |
| Transporting Pets | 345 | Call Continuation | 279 | Redial | 279 |
| Tread Wear Indicators | 429 | Call Controls | 277 | To Remove A Favorite | 277 |
| Tri-Fold Tonneau Cover | 97 | Call Termination | 279 | Toggling Between Calls..... | 279 |
| Cleaning..... | 104 | Cancel Command..... | 274 | Touch-Tone Number Entry | 277 |
| Install | 101 | Connecting To A Particular Mobile Phone | | Transfer Call To And From Mobile Phone.. | 279 |
| Removal..... | 98 | Or Audio Device After Pairing | 275 | Voice Command | 279 |
| Turn Signals..... | 57, 139, 415, 417 | Help Command..... | 274 | Uconnect Settings | |
| U | | Join Calls | 279 | Customer Programmable Features.... | 30, 237 |
| Uconnect | | Making A Phone Or Audio Device | | Passive Entry Programming..... | 30 |
| Phone Call Features | 277 | A Favorite | 276 | Uconnect System | 257 |
| Things You Should Know About Your | | Making A Second Call While Current Call | | Uniform Tire Quality Grades | 436 |
| Uconnect Phone..... | 279 | Is In Progress | 278 | Universal Garage Door Opener (Homelink®) – | |
| Uconnect Settings | 237 | Managing Your Favorites..... | 276 | If Equipped  | 50 |
| Uconnect (Radio)..... | 236 | Natural Speech..... | 273 | Unleaded Gasoline..... | 443 |
| Uconnect 4C Nav With 12-Inch Display | 236 | Operation | 273 | Untwisting Procedure, Seat Belt..... | 316 |
| Uconnect 4C/4C Nav With 8.4-Inch Display .. | 236 | Overview..... | 271 | USB | 74 |
| | | | | Utility Rails, Rear Cargo Area | 92 |

470

V

Vehicle Identification Number (VIN).....442
 Vehicle Loading 213, 424
 Vehicle Maintenance 385
 Vehicle Modifications/Alterations..... 13
 Vehicle Settings237
 Vehicle Storage68, 437
 Ventilated Seats 41
 Voice Command 43
 Voice Recognition System (VR) 43

W

Warning Lights And Messages 130
 Warranty Information 456
 Washers, Windshield 384
 Washing Vehicle 438
 Water
 Driving Through 234
 Water Separator
 Diesel Fuel..... 138, 388
 Wheel And Wheel Tire Care 433
 Wheel And Wheel Tire Trim 433
 Wind Buffeting81
 Window Fogging.....69

Window Lockout Switch80
 Windows79
 Power.....79
 Rear Sliding81
 Reset Auto-Up.....80
 Windshield Defroster 345
 Windshield Washers 61, 134, 384
 Fluid..... 384
 Windshield Wiper Blades 394
 Windshield Wipers61
 Wipers Blade Replacement..... 394
 Wipers, Rain Sensitive62
 Wireless Charging Pad78



A series of 12 horizontal lines, evenly spaced, spanning most of the width of the page. These lines are intended for writing text.





A series of 12 horizontal lines, evenly spaced, spanning most of the width of the page, intended for writing.



Operational Description

This device is intended to be installed in a passenger vehicle and powered by the vehicle's main battery. The device is an original equipment manufacturer (OEM) application and is installed by the OEM during vehicle assembly. Device is not available by normal means in the consumer market. Power harness is supplied by the vehicle manufacturer.

This device is a centralized control console integrating USB, radio tuner receiver, GPS receiver and navigation system, Bluetooth radio for connecting to mobile phones with Bluetooth capability and WLAN functionality for connecting with an access point for the purposes of downloading software/firmware updates to the device itself. The USB connector on device is intended to be used for software/firmware updates to the device, but also for communicating with and powering consumer grade USB devices, such as mobile phones, etc. The device "does not" have an integrated display of any type.

The Bluetooth/WLAN transmitter Model CYW89359 is manufactured by Cypress Semiconductor Corporation.

For Bluetooth, device operates in 2.4 ISM band and is compatible with Bluetooth 4.2. Supports modulations GFSK, 4DQPSK, 8DPSK. For WLAN, the RF to baseband radio operates in the 2.4 / 5 GHz ISM radio band for 802.11 a, b, g, n, ac.

The intended operational frequency band for the integrated Bluetooth transmitter is 2402 – 2483.5 MHz with 79 frequency hopping channels. Bluetooth TX_Power class 1.5. The intended operational frequency band for the integrated BT/WLAN radio is 2.400 – 2.484 GHz and also operates in Subband U-NII-1 and U-NII-3. Support for channels 1-11 or channels 1-13 depending on the market as allowed by the regional regulatory authority.

Device has two antennas. The two antennas are located outside the silverbox and cannot be modified by normal means with a max antenna gain of 1.4 dBi @ 2.4GHz. The antenna gain @ 5GHz is as follows:

- Integral / 2.6 dBi for Subband U-NII-1
- Integral / 1.5 dBi for Subband U-NII-3

For GPS, a receiver operating with reception frequency range 1575.42 MHz band allows for satellite navigation.

Technical Specification

| | MIN | NOMINAL | MAX |
|----------------------------|---------------------|----------------|------------|
| Rated Voltage | 0 VDC | 14 VDC | 24 VDC |
| Operational Voltage | 9 VDC | 14 VDCC | 16 VDC |
| Temperate Range | -40 °C | 25 °C | 75 °C |
| Consumption Current | - | - | 25 A |
| Weight | ~ 900 gm | | |
| Dimensions HxWxD | ~ 70 x 140 x 220 mm | | |