



**Model: R1 EXT ER 2B MY22; R1 INT ER 2B MY22**

**Internal Photos**

**9 August 2021**

**Revision 0**

**Harman International Industries, Inc.**

**30001 Cabot Drive**

**Novi, MI 48377**

**U.S.A.**

## Table of Contents

Revision History.....	3
Top Casting – Side 1 .....	4
Top Casting – Side 2 .....	5
Bottom Casting – Side 1 .....	6
Bottom Casting – Side 2 .....	7
Main PCB – Side 1 .....	8
Main PCB – Side 2.....	<b>Error! Bookmark not defined.</b> 9

# Revision History

Revision	Date	Description
0	9 AUG 2021	Initial release.



Top Casting – Side 2

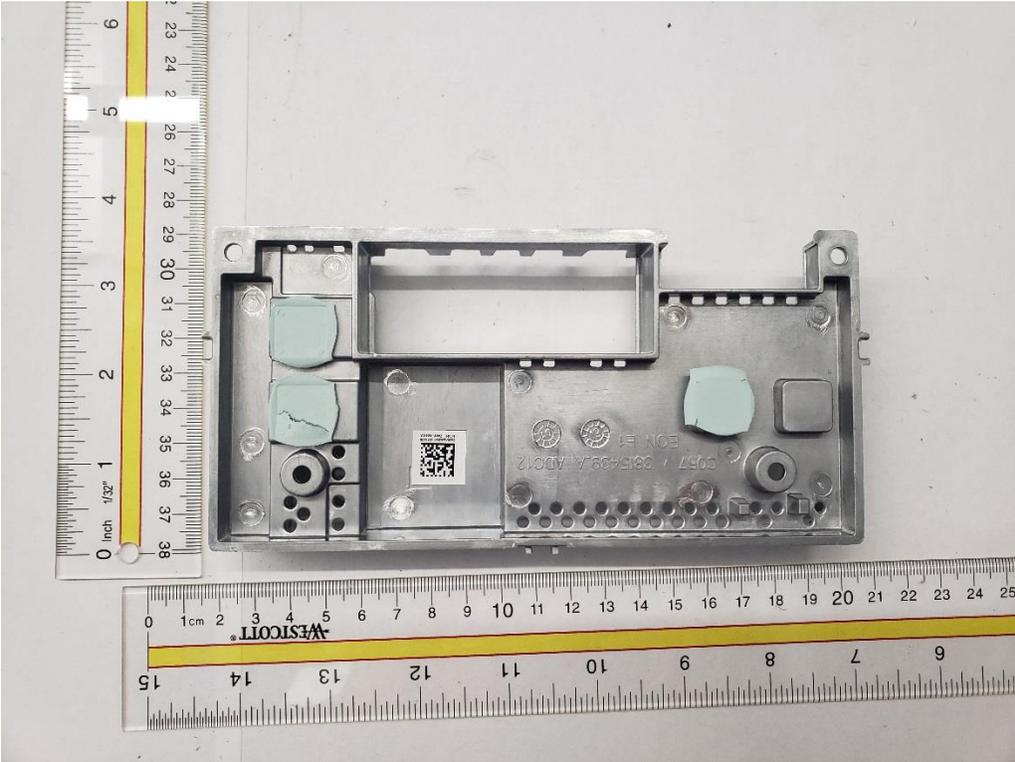

Front Plate – Side 1

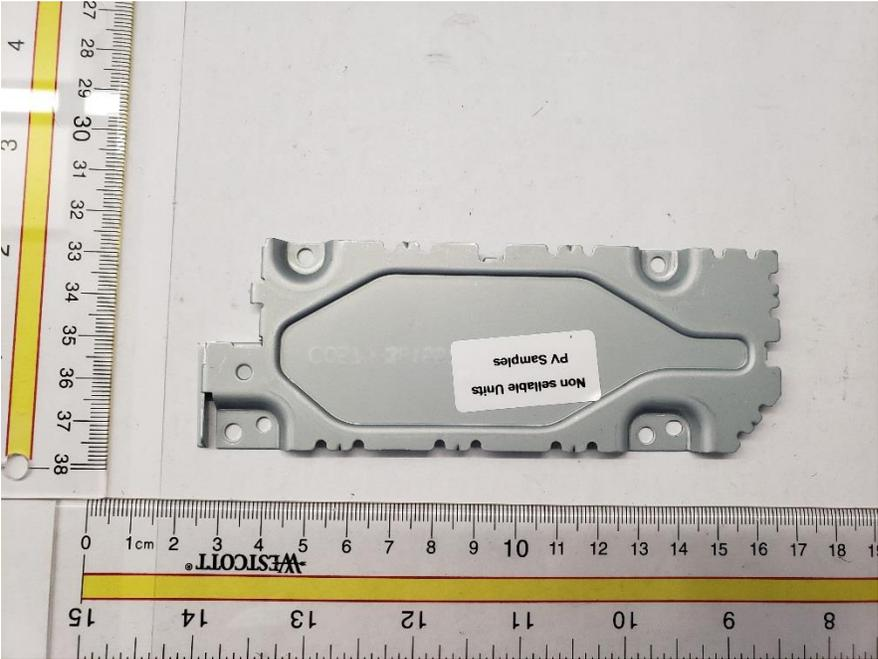

Front Plate – Side 2

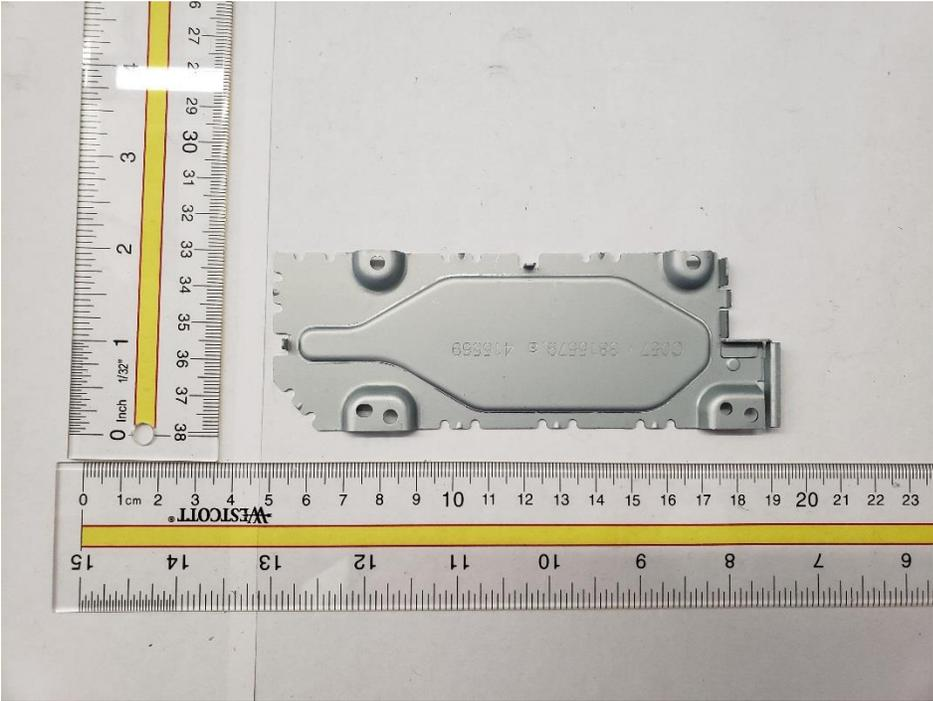

Main PCB – Side 1

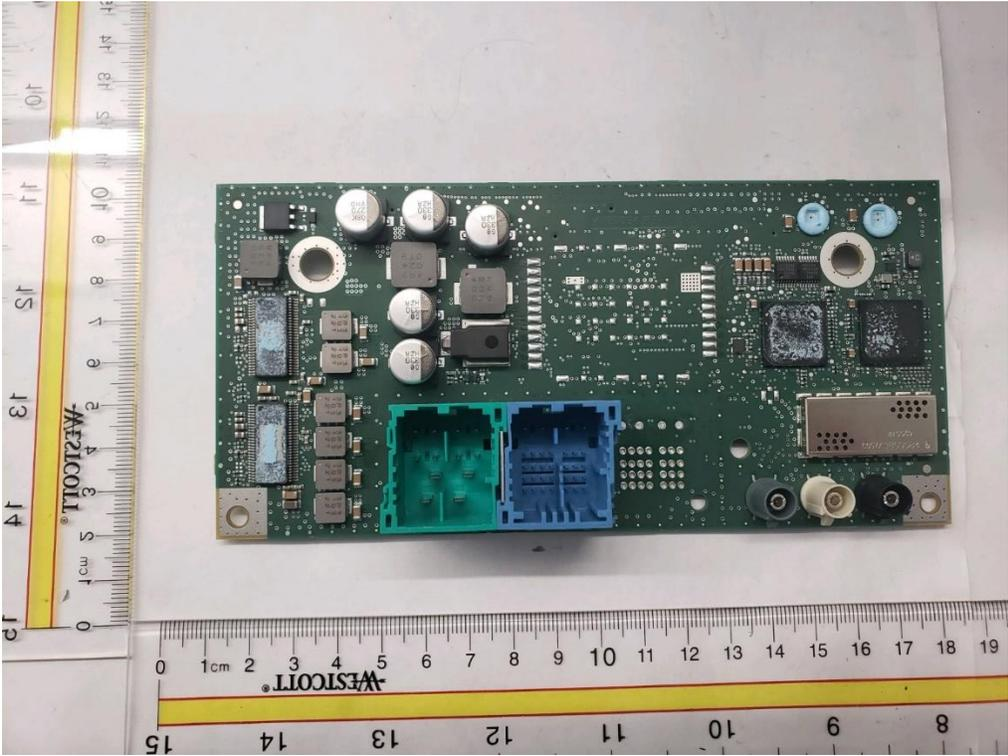

Main PCB – Side 1 (cont)

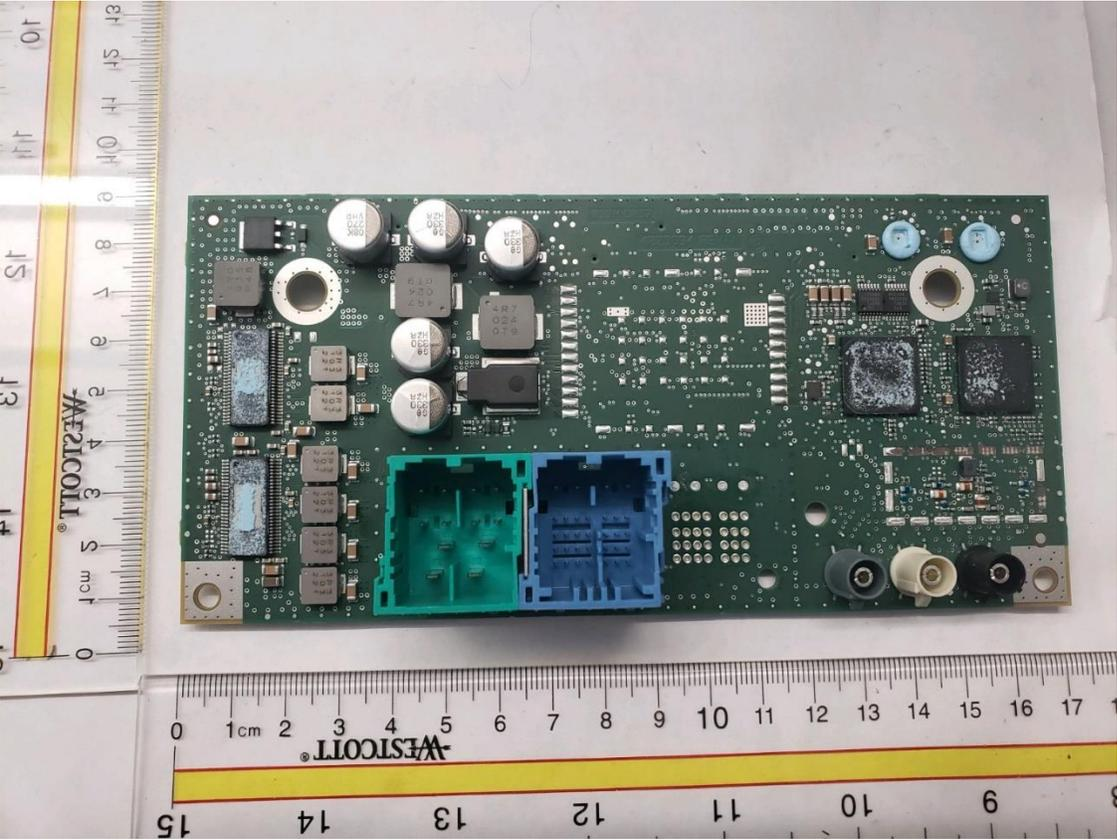

Main PCB – Side 2

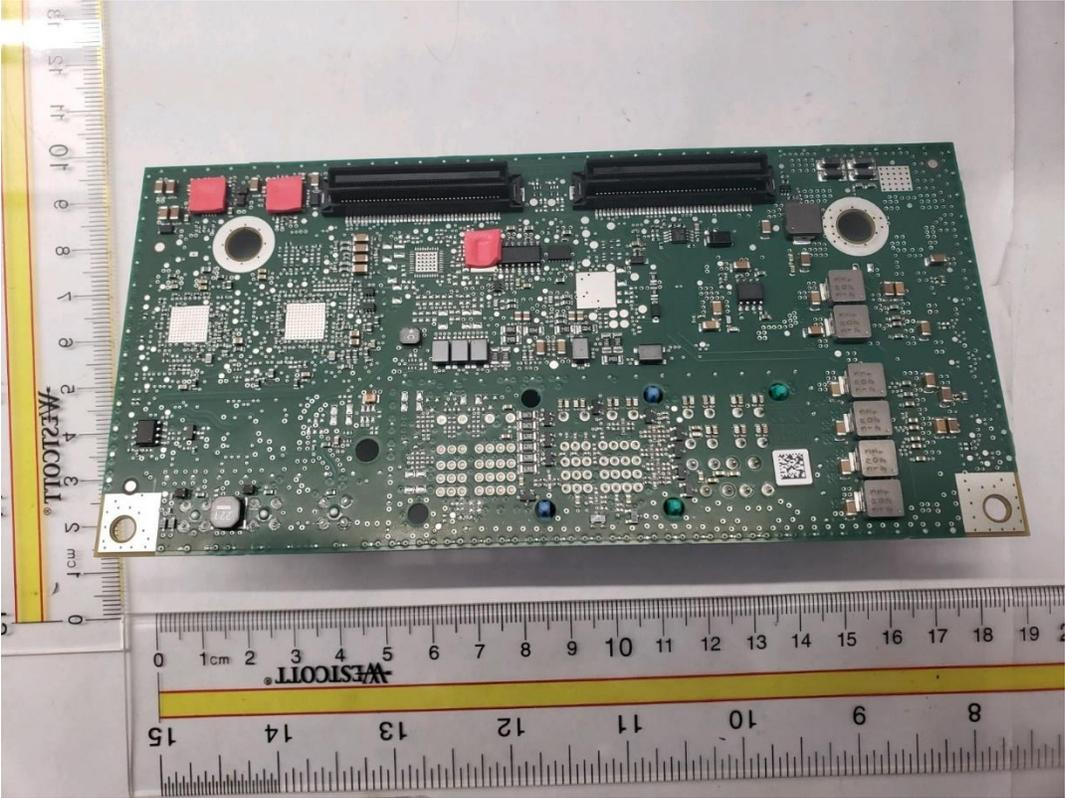

Inner Casting 1 – Side 1

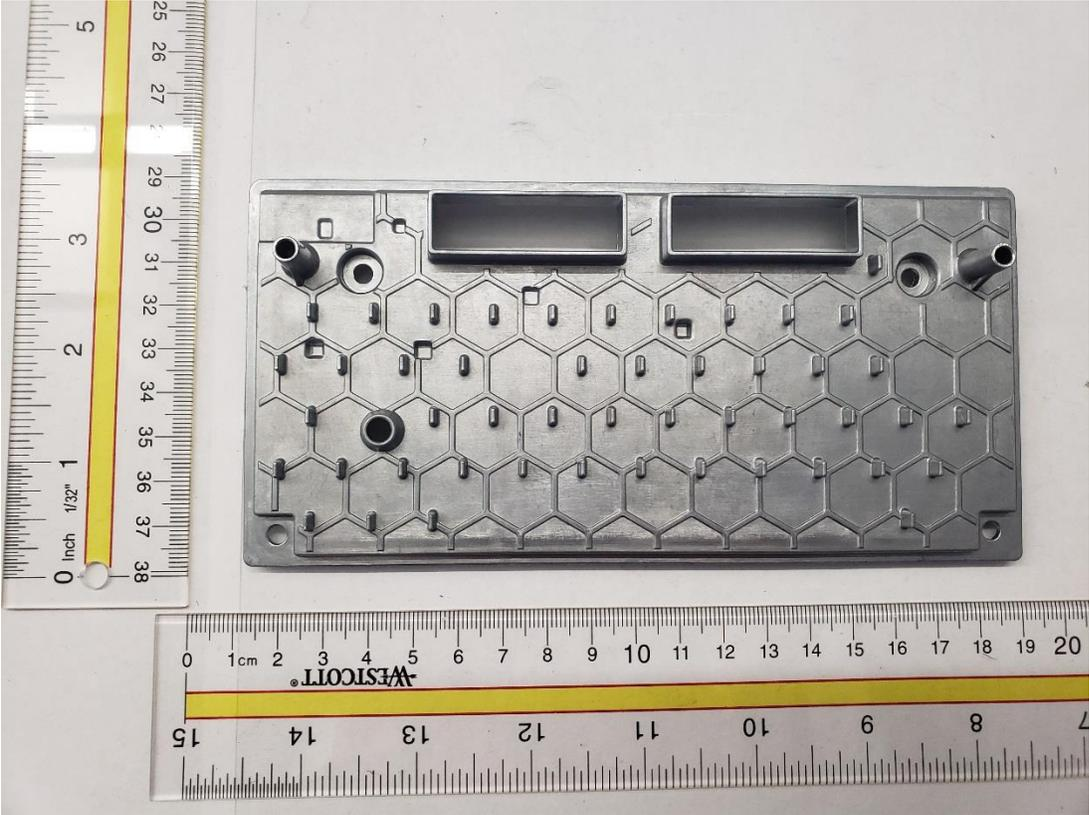

Inner Casting 1 – Side 2

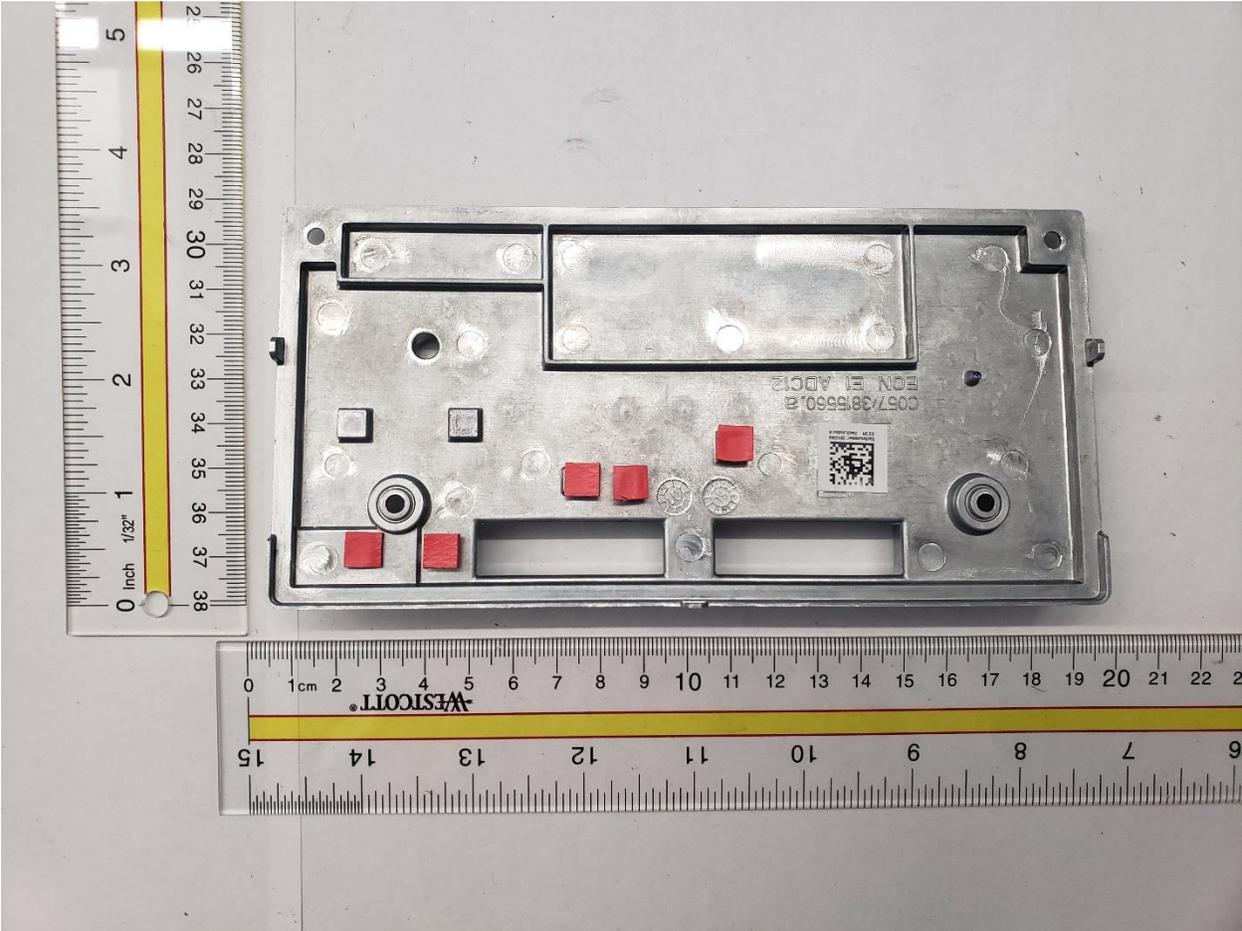

Inner Casting 2 – Side 1

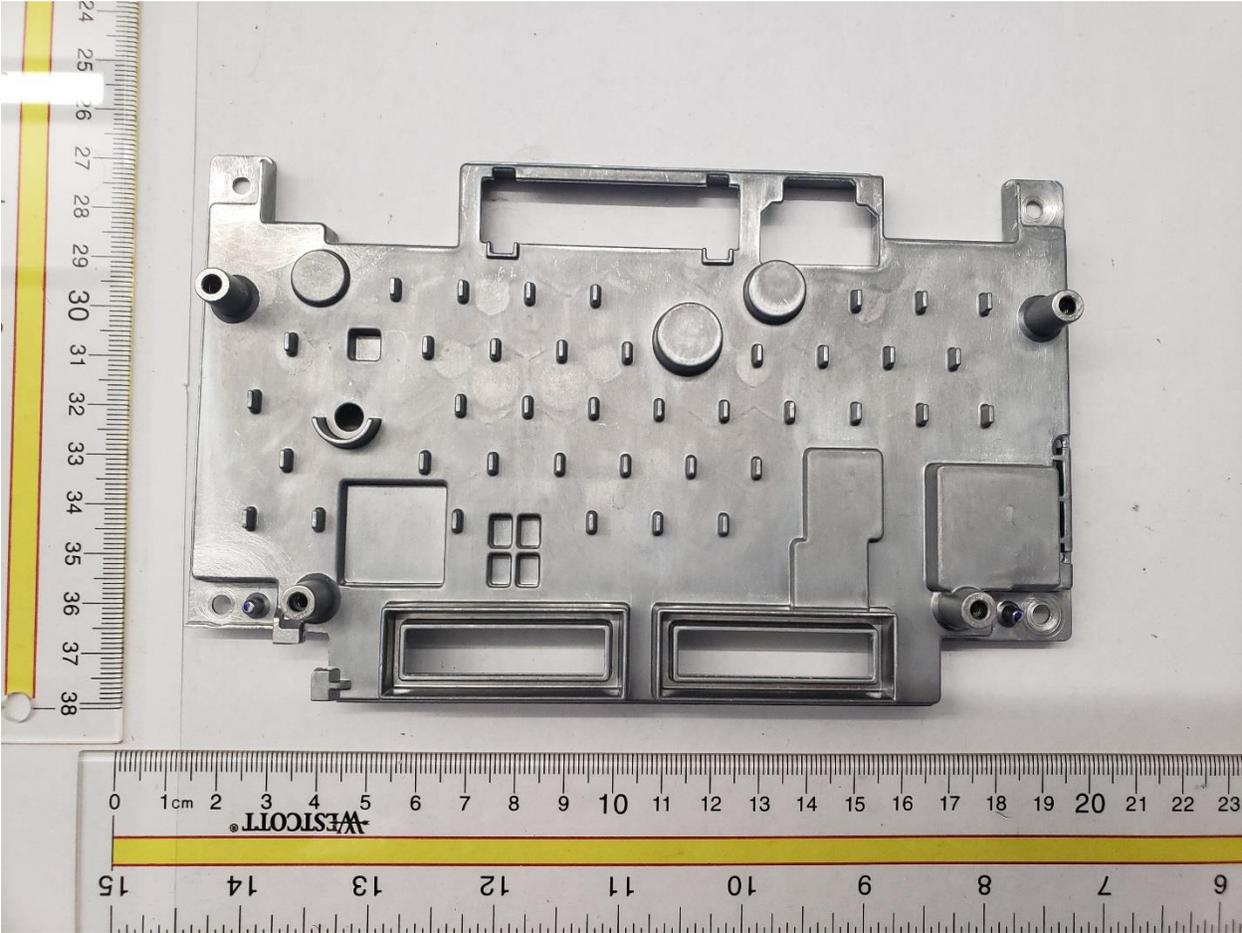

Inner Casting 2 – Side 2

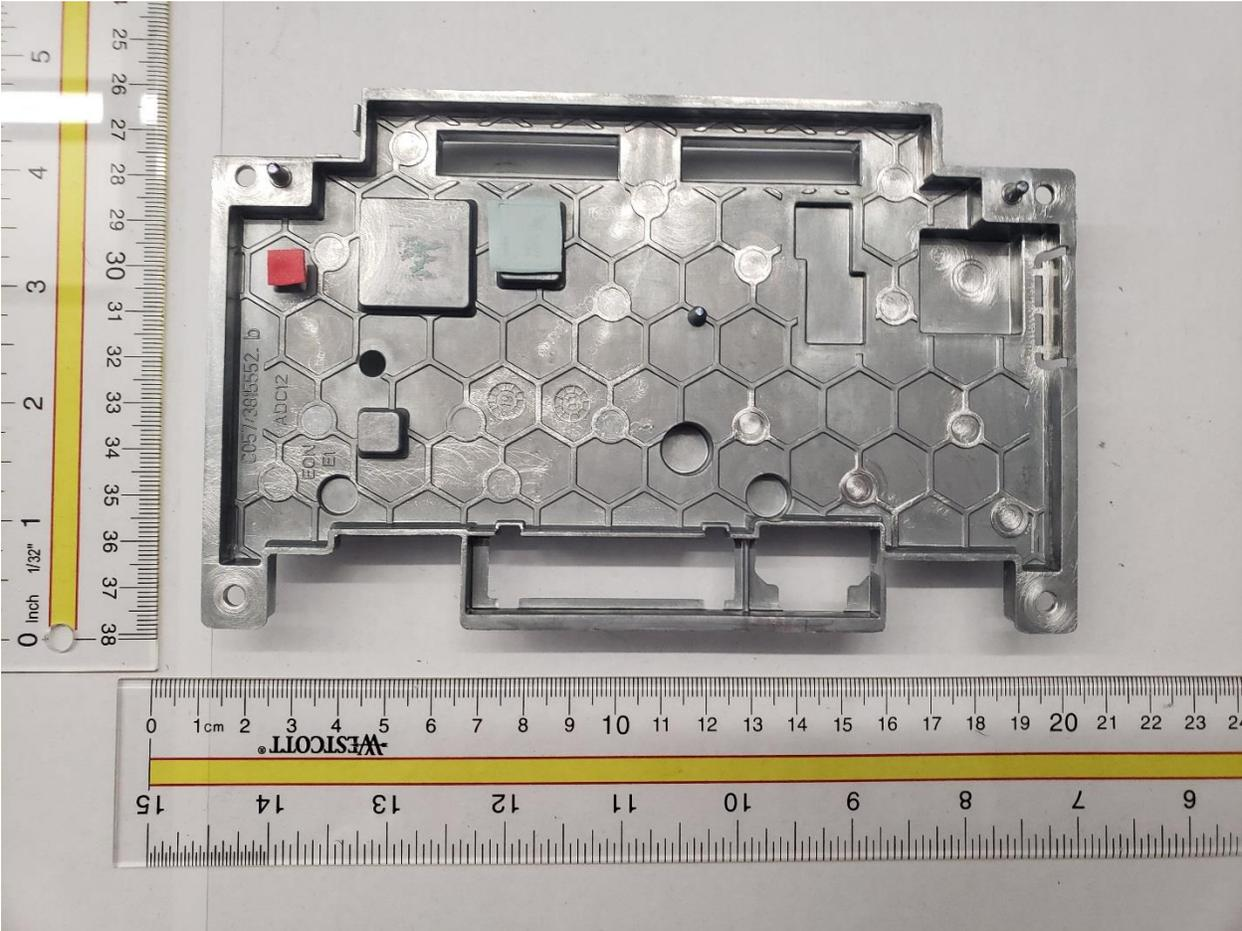

PCB 2 – Side 1

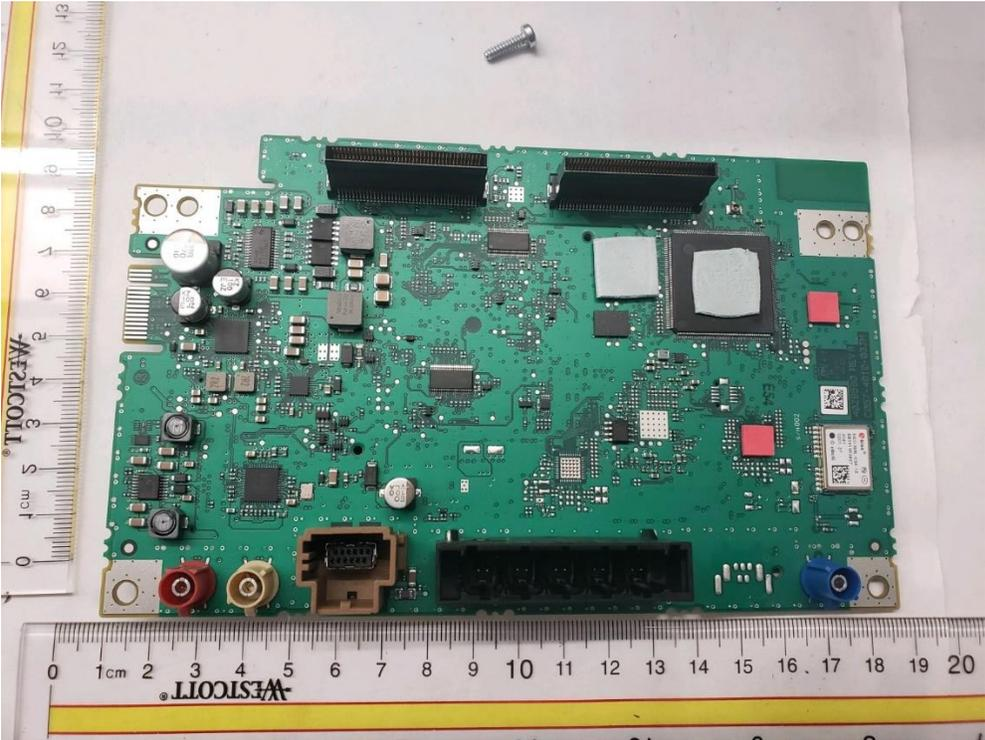

PCB 2 – Side 1 (cont)



PCB 2 – Side 2

PCB Trace Antenna

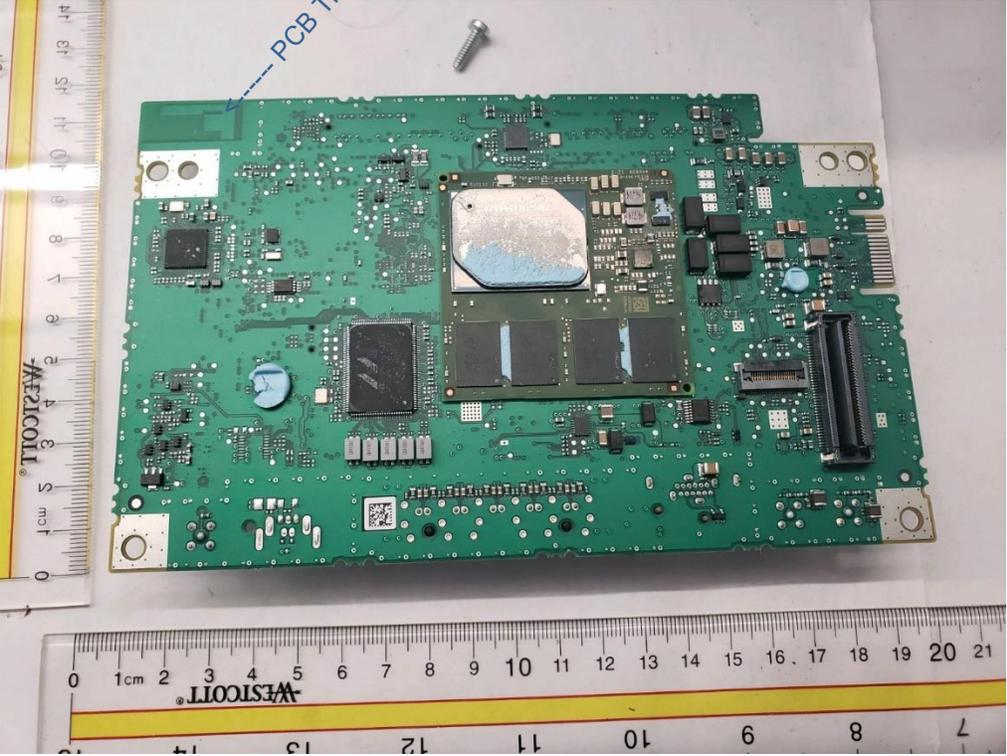

PCB 3 – Side 1

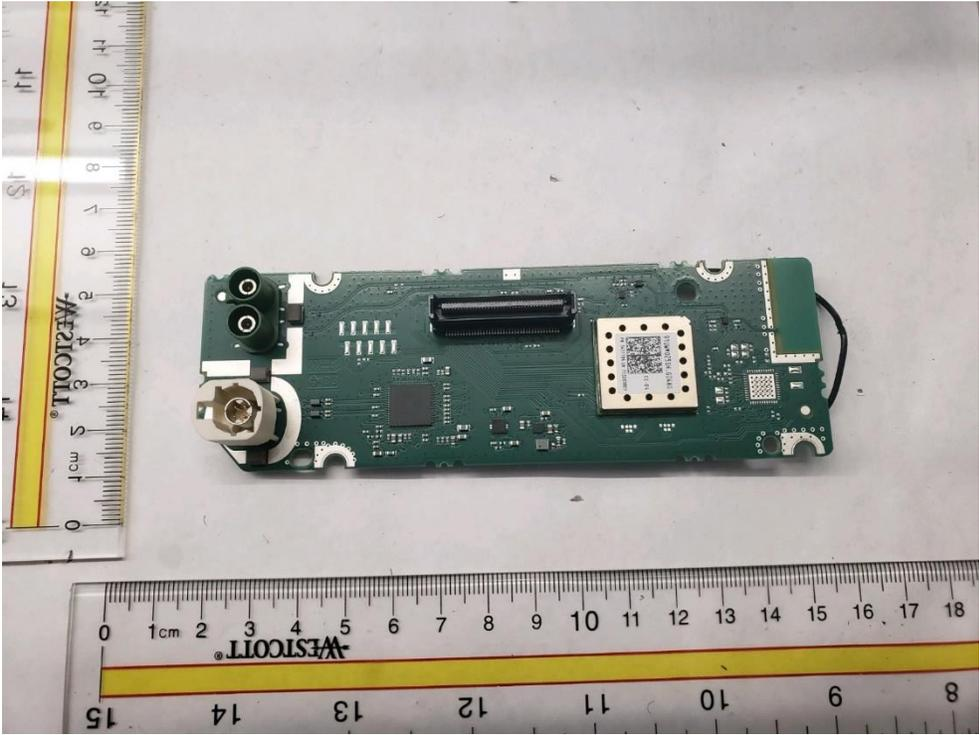

PCB 3 – Side 1 (cont)

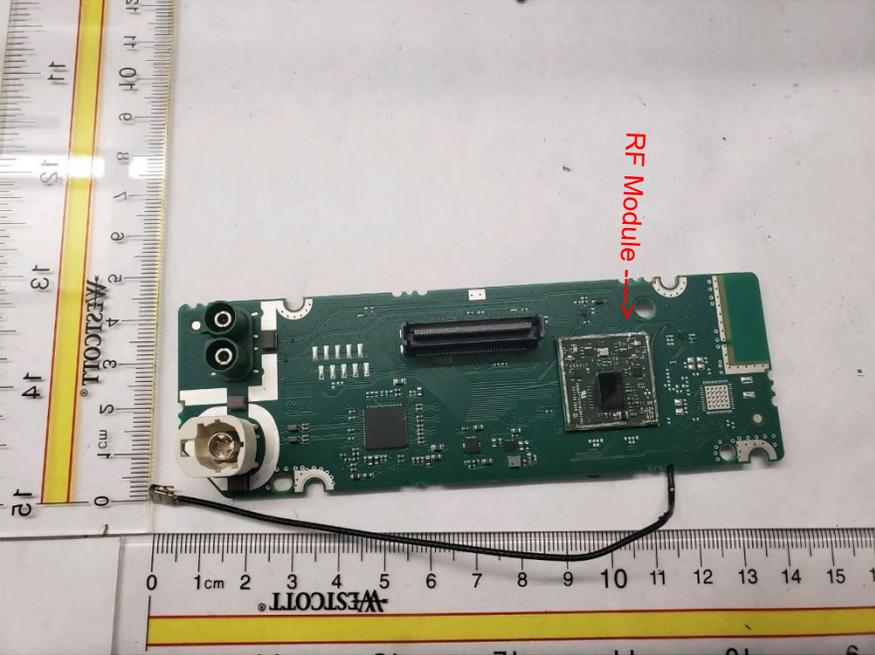

PCB 3 – Side 2

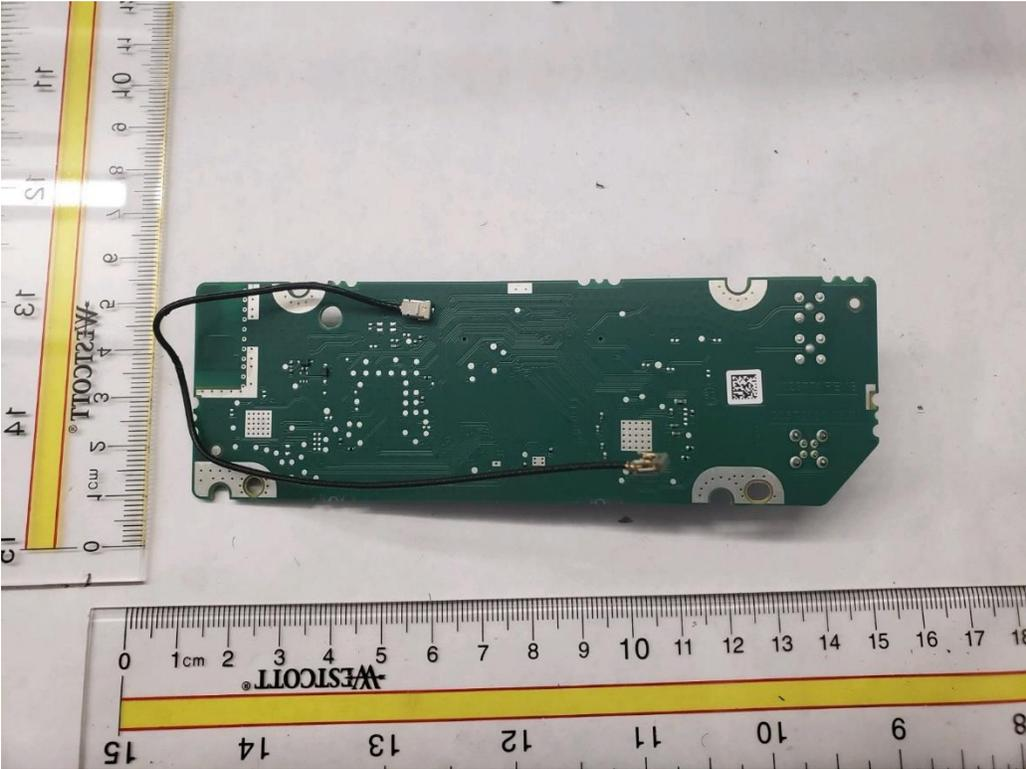

Bottom Casting – Side 1

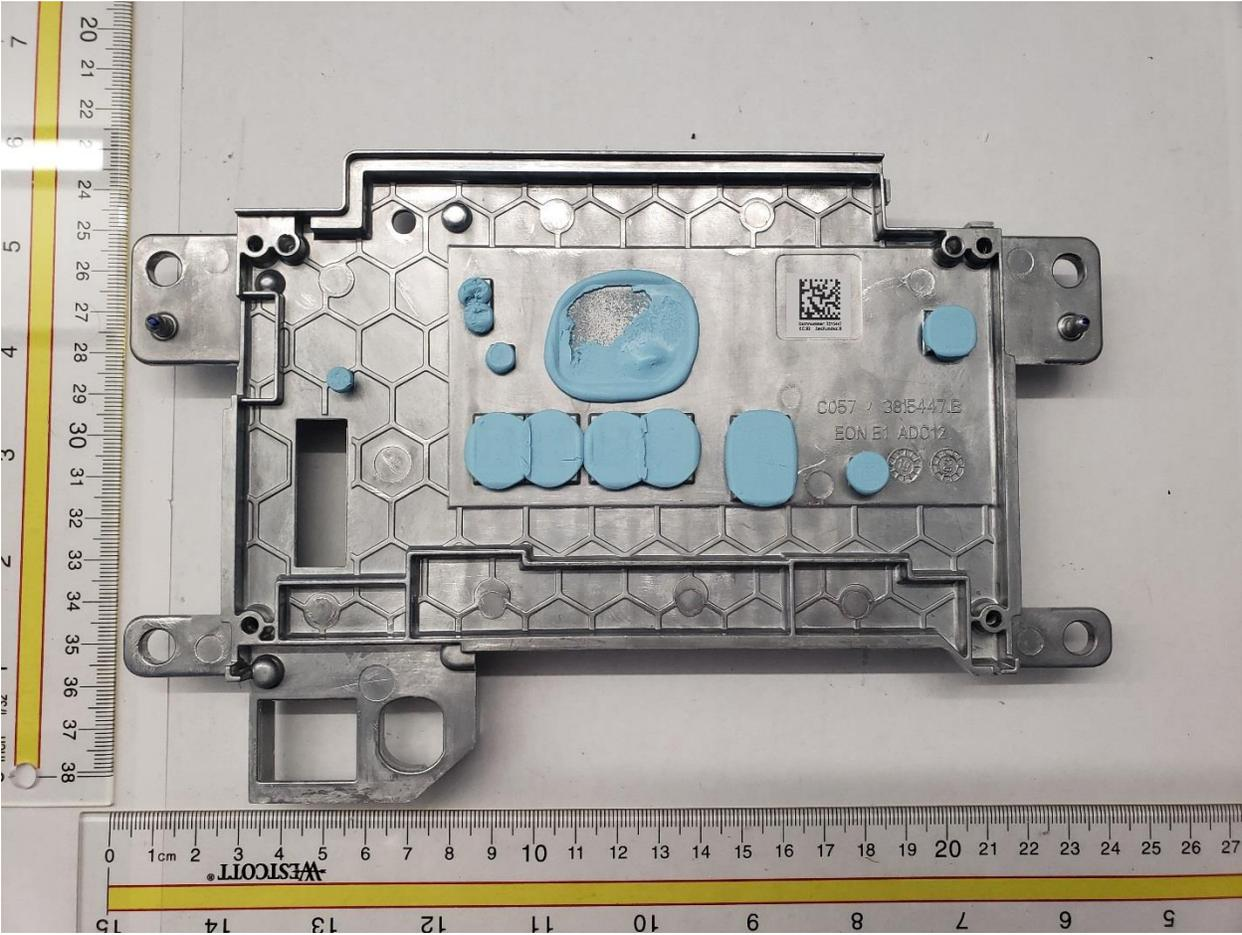

Bottom Casting – Side 2

