

## FCC RF Test Report

**Report No.:** FCC\_RF\_SL20010901-HAR-2217\_5G

**FCC ID:** 2AHPN-BE2487

**Model:** R1 INT ER

**Received Date:** 02/10/2020

**Test Date:** 02/18/2020 - 03/18/2020

**Issued Date:** 03/20/2020

**Applicant:** HARMAN INTERNATIONAL

**Address:** 30001 Cabot Drive, Novi, MI 48377, USA

**Manufacturer:** HARMAN INTERNATIONAL

**Address:** 30001 Cabot Drive, Novi, MI 48377, USA

**Issued By:** Bureau Veritas Consumer Products Services, Inc.

**Lab Address:** 775 Montague Expressway, Milpitas, CA 95035, USA

**FCC Test Site Reg No.:** 540430



This report is for your exclusive use. Any copying or replication of this report to or for any other person or entity, or use of our name or trademark, is permitted only with our prior written permission. This report sets forth our findings solely with respect to the test samples identified herein. The results set forth in this report are not indicative or representative of the quality or characteristics of the lot from which a test sample was taken or any similar or identical product unless specifically and expressly noted. Our report includes all of the tests requested by you and the results thereof based upon the information that you provided to us. You have 60 days from date of issuance of this report to notify us of any material error or omission caused by our negligence, provided, however, that such notice shall be in writing and shall specifically address the issue you wish to raise. A failure to raise such issue within the prescribed time shall constitute your unqualified acceptance of the completeness of this report, the tests conducted and the correctness of the report contents. Unless specific mention, the uncertainty of measurement has been explicitly taken into account to declare the compliance or non-compliance to the specification. The report must not be used by the client to claim product certification, approval, or endorsement by A2LA or any government agencies.

## Table of Contents

<b>Release Control Record</b> .....	<b>4</b>
<b>1 Certificate of Conformity</b> .....	<b>5</b>
<b>2 Summary of Test Results</b> .....	<b>6</b>
2.1 Measurement Uncertainty.....	6
2.2 Modification Record.....	6
<b>3 General Information</b> .....	<b>7</b>
3.1 General Description of EUT.....	7
3.2 Description of Operation Modes.....	8
3.2.1 Test Mode Applicability and Tested Channel Detail.....	10
3.3 Description of Support Units.....	11
3.3.1 Duty Cycle of Test Signal.....	13
3.4 General Description of Applied Standard.....	14
<b>4 Test Types and Results</b> .....	<b>15</b>
4.1 Antenna Requirement.....	15
4.2 Radiated Emission and Bandedge Measurement.....	16
4.2.1 Limits of Radiated Emission Measurement.....	16
4.2.2 Test Instruments.....	17
4.2.3 Test Procedure.....	17
4.2.4 Deviation from Test Standard.....	18
4.2.5 Test Setup.....	19
4.2.6 EUT Operating Condition.....	20
4.2.7 Test Results.....	21
4.3 Transmit Power Measurement.....	38
4.3.1 Limits of Transmit Power Measurement.....	38
4.3.2 Test Setup.....	39
4.3.3 Test Instruments.....	39
4.3.4 Test Procedure.....	39
4.3.5 Deviation from Test Standard.....	40
4.3.6 EUT Operating Condition.....	40
4.3.7 Test Results.....	41
4.4 26dB Bandwidth & 6dB Bandwidth Measurement.....	42
4.4.1 Limits of 6 dB Bandwidth Measurement.....	42
4.4.2 Test Setup.....	42
4.4.3 Test Instruments.....	42
4.4.4 Test Procedure.....	42
4.4.5 Test Results.....	43
4.5 Peak Power Spectral Density Measurement.....	54
4.5.1 Limits of Peak Power Spectral Density Measurement.....	54
4.5.2 Test Setup.....	54
4.5.3 Test Instruments.....	54
4.5.4 Test Procedure.....	54
4.5.5 Deviation from Test Standard.....	54
4.5.6 EUT Operating Condition.....	54
4.5.7 Test Results.....	55
4.6 Frequency Stability Measurement.....	66
4.6.1 Limits of Frequency Stability Measurement.....	66
4.6.2 Test Setup.....	66
4.6.3 Test Instruments.....	66
4.6.4 Test Procedure.....	66
4.6.5 Deviation from Test Standard.....	66
4.6.6 EUT Operating Condition.....	66
4.6.7 Test Results.....	67

<b>5</b>	<b>Pictures of Test Arrangements.....</b>	<b>68</b>
	<b>Appendix – Information on the Testing Laboratories.....</b>	<b>69</b>

### Release Control Record

Issue No.	Description	Date Issued
FCC_RF_SL20010901-HAR-2217_5G	Original release	03/20/2020

## 1 Certificate of Conformity

**Product:** Automotive Information Unit

**Brand:** HARMAN

**Model:** R1 INT ER

**Sample Status:** Engineer Sample

**Applicant:** HARMAN INTERNATIONAL

**Test Date:** 02/18/2020 - 03/18/2020

**Standard:** 47 CFR FCC Part 15, Subpart E (Section 15.407)  
789033 D02 General UNII Test Procedures New Rules v02r01  
ANSI C63.10:2013

The above equipment has been tested by **Bureau Veritas Consumer Products Services, Inc. Milpitas Branch**, and found compliance with the requirement of the above standards. The test record, data evaluation & Equipment Under Test (EUT) configurations represented herein are true and accurate accounts of the measurements of the sample's EMC characteristics under the conditions specified in this report.

*Gary Chou*  
**Prepared by :** \_\_\_\_\_, **Date:** \_\_\_\_\_  
Gary Chou / Compliance Engineer

*Chen Ge*  
**Approved by :** \_\_\_\_\_, **Date:** \_\_\_\_\_  
Chen Ge / Engineer Reviewer

## 2 Summary of Test Results

47 CFR FCC Part 15, Subpart E (Section 15.407)			
Standard Section	Test Item	Result	Remarks
15.203	Antenna Requirement	Pass	PCB antenna with U.FL connector
15.407 (b)(6)	AC Power Conducted Emissions	N/A	N/A
15.407 (b)(1/2/3/4(i/ii)/6)	Radiated Emissions & Band Edge Measurement*	Pass	Meet the requirement of limit.
15.407 (a)(1/2/3)	Max Average Transmit Power	Pass	Meet the requirement of limit.
-	Occupied Bandwidth	Pass	Meet the requirement of limit.
15.407 (e)	6 dB Emission Bandwidth	Pass	Meet the requirement of limit. (U-NII-3 only)
15.407 (a)(1/2/3)	Peak Power Spectral Density	Pass	Meet the requirement of limit.
15.407(g)	Frequency Stability	Pass	Meet the requirement of limit.

Note: The EUT is DC powered.

### 2.1 Measurement Uncertainty

Where relevant, the following measurement uncertainty levels have been estimated for tests performed on the EUT as specified in CISPR 16-4-2:

Measurement	Frequency	Expanded Uncertainty (k=2) (±)
Conducted Emissions at mains ports	150kHz ~ 30MHz	3.51dB
Radiated Emissions up to 1 GHz	30MHz ~ 1GHz	3.73dB
Radiated Emissions above 1 GHz	1GHz ~ 6GHz	4.64dB
	6GHz ~ 18GHz	4.82dB
	18GHz ~ 40GHz	4.91dB

### 2.2 Modification Record

There were no modifications required for compliance.

### 3 General Information

#### 3.1 General Description of EUT

Product	Automotive Infotainment Unit
Brand	HARMAN
Test Model	R1 INT ER
Status of EUT	Engineer Sample
Power Supply Rating	12Vdc
Modulation Type	256QAM, 64QAM, 16QAM, QPSK, BPSK for OFDM
Modulation Technology	DSSS, OFDM
Transfer Rate	802.11a: up to 54Mbps 802.11n: up to 300Mbps 802.11ac: up to 433Mbps
Operating Frequency	5180~5240MHz, 5745~5825MHz
Number of Channel	5180~5240MHz: 4 channels for 802.11a, 802.11n, 11ac (20MHz) 2 channels for 802.11n, 11ac (40MHz) 1 channel for 802.11ac (80MHz) 5745~5825MHz: 5 channels for 802.11a, 802.11n, 11ac (20MHz) 2 channels for 802.11n, 11ac (40MHz) 1 channel for 802.11ac (80MHz)
Antenna Type	PCB Antenna 5180~5240MHz: 2.65dBi 5745~5825MHz: 1.51dBi
Antenna Connector	U.FL

Note:

- The EUT provides one completed transmitter and one receiver.

Modulation Mode	Tx Function
802.11a	1TX
802.11n	1TX
802.11ac	1TX

### 3.2 Description of Operation Modes

#### FOR 5180 ~ 5240MHz

4 channels are provided for 802.11a, 802.11n (20MHz), 802.11ac(20MHz):

Channel	Frequency	Channel	Frequency
36	5180 MHz	44	5220 MHz
40	5200 MHz	48	5240 MHz

2 channels are provided for, 802.11n (40MHz), 802.11ac (40MHz):

Channel	Frequency	Channel	Frequency
38	5190 MHz	46	5230 MHz

1 channels are provided for, 802.11ac (80MHz):

Channel	Frequency	Channel	Frequency
38	5210 MHz		

#### FOR 5745 ~ 5825MHz:

5 channels are provided for 802.11a, 802.11n (HT20):

Channel	Frequency	Channel	Frequency
149	5745MHz	161	5805MHz
153	5765MHz	165	5825MHz
157	5785MHz		

2 channels are provided for 802.11n (40MHz), 802.11ac(40MHz):

Channel	Frequency	Channel	Frequency
151	5755MHz	159	5795MHz

1 channels are provided for 802.11ac(80MHz):

Channel	Frequency	Channel	Frequency
155	5775MHz	--	--



Power setting is as below:

802.11a		802.11n, ac(20MHz)	
Channel	Power Setting	Channel	Power Setting
36	4	36	4
40	4	40	4
48	4	48	4
149	4	149	4
157	4	157	4
165	4	165	4
802.11n, ac(40MHz)		802.11ac(80MHz)	
Channel	Power Setting	Channel	Power Setting
38	4	38	4
46	4	155	4
151	4	48	4
159	4	-	-

1. The above EUT information is declared by manufacturer and for more detailed features description, please refer to the manufacturer's specifications or user's manual.

### 3.2.1 Test Mode Applicability and Tested Channel Detail

EUT Configure Mode	Applicable To				Description
	RE≥1G	RE<1G	PLC	APCM	
A	√	√	-	√	Powered 12Vdc Battery

Where **RE≥1G**: Radiated Emission above 1GHz      **RE<1G**: Radiated Emission below 1GHz  
**PLC**: Power Line Conducted Emission      **APCM**: Antenna Port Conducted Measurement

**NOTE:**

1. The EUT had been pre-tested on the positioned of each 3 axis. The worst case was found when positioned on **X-plane**.
2. "-" means no effect.

#### **Radiated Emission Test (Above 1GHz):**

- Pre-Scan has been conducted to determine the worst-case mode from all possible combinations between available modulations, data rates and antenna ports (if EUT with antenna diversity architecture).
- Following channel(s) was (were) selected for the final test as listed below.

EUT Configure Mode	Mode	FREQ. Band (MHz)	Available Channel	Tested Channel	Modulation Technology	Modulation Type
-	802.11a	5180-5240	36 to 48	36, 40, 48	OFDM	BPSK
-	802.11n (HT20)		36 to 48	36, 40, 48	OFDM	BPSK
-	802.11n (HT40)		38 to 46	38, 46	OFDM	BPSK
-	802.11ac (VHT80)		42	42	OFDM	BPSK
-	802.11a	5745-5825	149 to 165	149, 157, 165	OFDM	BPSK
-	802.11n (HT20)		149 to 165	149, 157, 165	OFDM	BPSK
-	802.11n (HT40)		151 to 159	151, 159	OFDM	BPSK
-	802.11ac (VHT80)		155	155	OFDM	BPSK

#### **Radiated Emission Test (Below 1GHz):**

- Pre-Scan has been conducted to determine the worst-case mode from all possible combinations between available modulations, data rates and antenna ports (if EUT with antenna diversity architecture).
- Following channel(s) was (were) selected for the final test as listed below.

EUT Configure Mode	Mode	FREQ. Band (MHz)	Available Channel	Tested Channel	Modulation Technology	Modulation Type
-	802.11a	5180-5320	36 to 64	40	OFDM	BPSK
-	802.11a	5745-5825	149 to 165	157	OFDM	BPSK

### Power Line Conducted Emission Test:

- Pre-Scan has been conducted to determine the worst-case mode from all possible combinations between available modulations, data rates and antenna ports (if EUT with antenna diversity architecture).
- Following channel(s) was (were) selected for the final test as listed below.

EUT Configure Mode	Mode	FREQ. Band (MHz)	Available Channel	Tested Channel	Modulation Technology	Modulation Type
-	802.11a	5180-5320	36 to 64	62	OFDM	BPSK
-	802.11a	5745-5825	149 to 165	149	OFDM	BPSK

### Antenna Port Conducted Measurement:

- This item includes all test value of each mode, but only includes spectrum plot of worst value of each mode.
- Pre-Scan has been conducted to determine the worst-case mode from all possible combinations between available modulations, data rates and antenna ports (if EUT with antenna diversity architecture).
- Following channel(s) was (were) selected for the final test as listed below.

EUT Configure Mode	Mode	FREQ. Band (MHz)	Available Channel	Tested Channel	Modulation Technology	Modulation Type
-	802.11a	5180-5240	36 to 48	36, 40, 48	OFDM	BPSK
-	802.11n (HT20)		36 to 48	36, 40, 48	OFDM	BPSK
-	802.11n (HT40)		38 to 46	38, 46	OFDM	BPSK
-	802.11ac (VHT80)		42	42	OFDM	BPSK
-	802.11a	5745-5825	149 to 165	149, 157, 165	OFDM	BPSK
-	802.11n (HT20)		149 to 165	149, 157, 165	OFDM	BPSK
-	802.11n (HT40)		151 to 159	151, 159	OFDM	BPSK
-	802.11ac (VHT80)		155	155	OFDM	BPSK

### Test Condition:

Applicable To	Environmental Conditions	Input Power	Tested By
RE $\geq$ 1G	25deg. C, 65%RH	12Vdc	Gary Chou
RE $<$ 1G	25deg. C, 65%RH	12Vdc	Gary Chou
APCM	21deg. C, 60%RH	12Vdc	Gary Chou

### 3.3 Description of Support Units

The EUT has been tested as an independent unit together with other necessary accessories or support units. The following support units or accessories were used to form a representative test configuration during the tests.

ID	Product	Brand	Model No.	Serial No.	FCC ID	Remarks
A.	Laptop	Dell	Latitude 3550	N/A	N/A	N/A
B.						
C.						
D.						

E.						
F.						
G.						

ID	Descriptions	Qty.	Length (m)	Shielding (Yes/No)	Cores (Qty.)	Remarks
1.	USB	1	1m	No	0	Connect from EUT to Laptop
2.						
3.						

### 3.3.1 Duty Cycle of Test Signal

#### MODULATION TYPE: BPSK

If Duty cycle of test signal is < 98 %, duty factor is required.

802.11a: Duty cycle = 98.6%

802.11n (HT20): Duty cycle = 99.12%

802.11n (HT40): Duty cycle = 98.26%

802.11ac (VHT80): Duty cycle = 98.20%

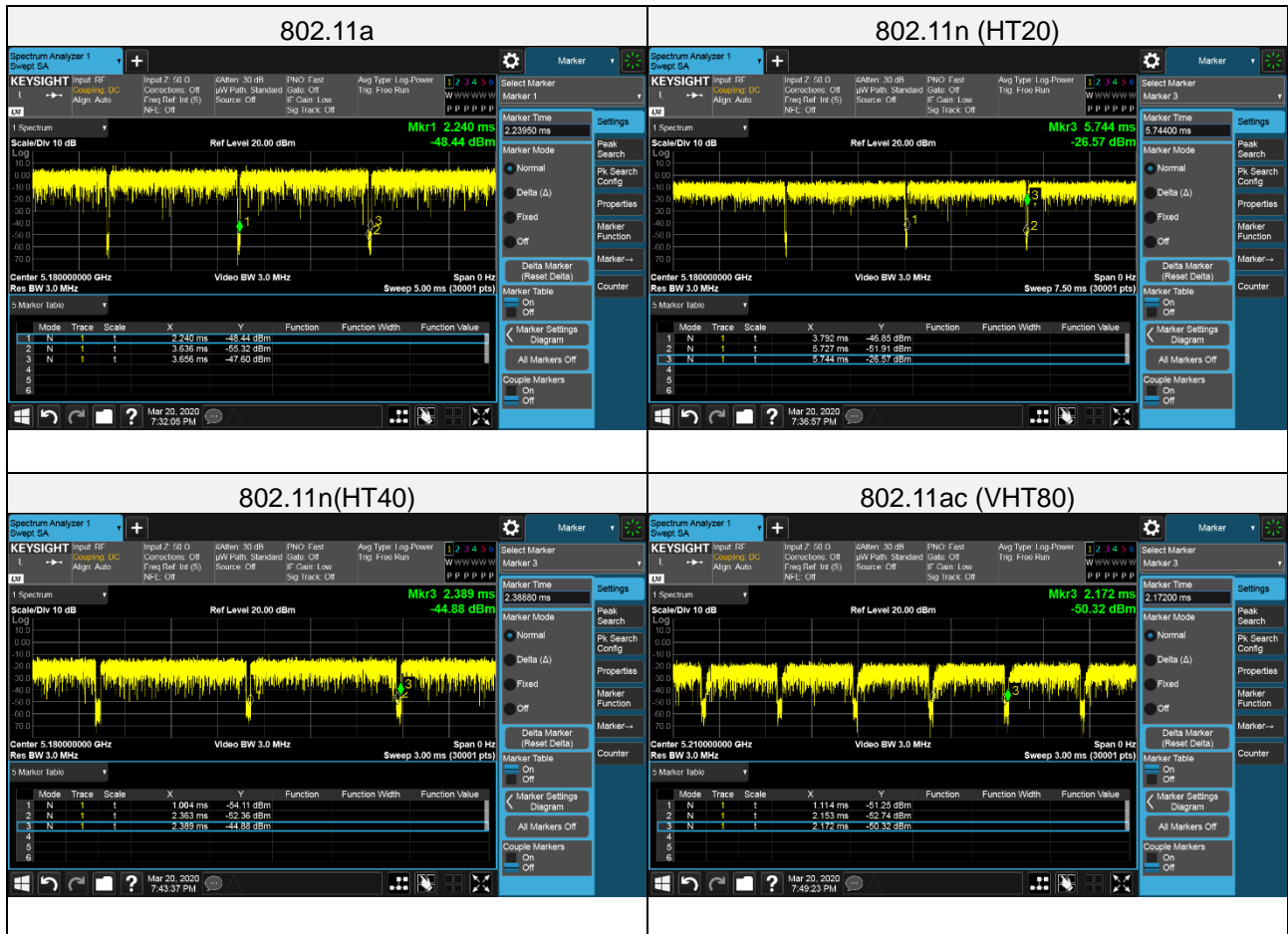

### **3.4 General Description of Applied Standard**

The EUT is a RF Product. According to the specifications of the manufacturer, it must comply with the requirements of the following standards:

**47 CFR FCC Part 15, Subpart E (Section 15.407)**

**789033 D02 General UNII Test Procedures New Rules v02r01**

**ANSI C63.10:2013**

All test items have been performed and recorded as per the above standards.

## 4 Test Types and Results

### 4.1 Antenna Requirement

Spec	Requirement	Applicable
15.203	<p>An intentional radiator shall be designed to ensure that no antenna other than that furnished by the responsible party shall be used with the device.</p> <p>Antenna requirement must meet at least one of the following:</p> <p>a) Antenna must be permanently attached to the device.            b) The antenna must use a unique type of connector to attach to the device.            c) Device must be professionally installed. The installer shall be responsible for ensuring that the correct antenna is employed by the device.</p>	<input checked="" type="checkbox"/>
Remark	The EUT uses a PCB antenna to permanently attach to the device.	
Result	<input checked="" type="checkbox"/> PASS <input type="checkbox"/> FAIL	

## 4.2 Radiated Emission and Bandedge Measurement

### 4.2.1 Limits of Radiated Emission Measurement

Radiated emissions which fall in the restricted bands must comply with the radiated emission limits specified as below table.

Frequencies (MHz)	Field Strength (microvolts/meter)	Measurement Distance (meters)
0.009 ~ 0.490	2400/F(kHz)	300
0.490 ~ 1.705	24000/F(kHz)	30
1.705 ~ 30.0	30	30
30 ~ 88	100	3
88 ~ 216	150	3
216 ~ 960	200	3
Above 960	500	3

#### NOTE:

1. The lower limit shall apply at the transition frequencies.
2. Emission level (dBuV/m) = 20 log Emission level (uV/m).
3. For frequencies above 1000MHz, the field strength limits are based on average detector, however, the peak field strength of any emission shall not exceed the maximum permitted average limits, specified above by more than 20dB under any condition of modulation.

Limits of unwanted emission out of the restricted bands

Applicable To		Limit	
789033 D02 General UNII Test Procedure New Rules v02r01		Field Strength at 3m	
		PK:74 (dBµV/m)	AV:54 (dBµV/m)
Frequency Band	Applicable To	EIRP Limit	Equivalent Field Strength at 3m
5150~5250 MHz	15.407(b)(1)	PK:-27 (dBm/MHz)	PK:68.2(dBµV/m)
5250~5350 MHz	15.407(b)(2)		
5470~5725 MHz	15.407(b)(3)		
5725~5850 MHz	<input checked="" type="checkbox"/> 15.407(b)(4)(i)	PK:-27 (dBm/MHz) <sup>*1</sup> PK:10 (dBm/MHz) <sup>*2</sup> PK:15.6 (dBm/MHz) <sup>*3</sup> PK:27 (dBm/MHz) <sup>*4</sup>	PK: 68.2(dBµV/m) <sup>*1</sup> PK:105.2 (dBµV/m) <sup>*2</sup> PK: 110.8(dBµV/m) <sup>*3</sup> PK:122.2 (dBµV/m) <sup>*4</sup>
	<input type="checkbox"/> 15.407(b)(4)(ii)	Emission limits in section 15.247(d)	
<sup>*1</sup> beyond 75 MHz or more above of the band edge. <sup>*3</sup> below the band edge increasing linearly to a level of 15.6 dBm/MHz at 5 MHz above.		<sup>*2</sup> below the band edge increasing linearly to 10 dBm/MHz at 25 MHz above. <sup>*4</sup> from 5 MHz above or below the band edge increasing linearly to a level of 27 dBm/MHz at the band edge.	

#### Note:

The following formula is used to convert the equipment isotropic radiated power (eirp) to field strength:

$$E = \frac{1000000 \cdot \sqrt{30P}}{3} \mu\text{V/m, where } P \text{ is the eirp (Watts).}$$



#### 4.2.2 Test Instruments

DESCRIPTION & MANUFACTURER	MODEL NO.	SERIAL NO.	DATE OF CALIBRATION	DUE DATE OF CALIBRATION
50GHz Spectrum Analyzer	N9030B (PXA)	MY57140597	06/05/2019	06/05/2020
Biconilog Antenna Sunol	JB6	A111717	08/27/2019	08/27/2020
Pre-Amplifier RF Bay, Inc.	LPA-6-30	11170601	04/27/2019	04/27/2020
Horn Antenna ETS-Lindgren	3117	218554	11/22/2019	11/22/2020
Pre-Amplifier RF-Lambda	RAMP00M50GA	17032300048	06/18/2019	06/18/2020

#### 4.2.3 Test Procedure

##### For Radiated emission below 30MHz

- The EUT was placed on the top of a rotating table 0.8 meters above the ground at a 3 meter chamber room. The table was rotated 360 degrees to determine the position of the highest radiation.
- The EUT was set 3 meters away from the interference-receiving antenna, which was mounted on the top of a variable-height antenna tower.
- Parallel, perpendicular, and ground-parallel orientations of the antenna are set to make the measurement.
- For each suspected emission, the EUT was arranged to its worst case and the rotatable table was turned from 0 degrees to 360 degrees to find the maximum reading.
- The test-receiver system was set to Quasi-Peak Detect Function and Specified Bandwidth with Maximum Hold Mode.

##### NOTE:

- The resolution bandwidth and video bandwidth of test receiver/spectrum analyzer is 9kHz at frequency below 30MHz.

##### For Radiated emission above 30MHz

- The EUT was placed on the top of a rotating table 0.8 meters (for 30MHz ~ 1GHz) / 1.5 meters (for above 1GHz) above the ground at 3 meter chamber room for test. The table was rotated 360 degrees to determine the position of the highest radiation.
- The EUT was set 3 meters away from the interference-receiving antenna, which was mounted on the top of a variable-height antenna tower.
- The height of antenna is varied from one meter to four meters above the ground to determine the maximum value of the field strength. Both horizontal and vertical polarizations of the antenna are set to make the measurement.
- For each suspected emission, the EUT was arranged to its worst case and then the antenna was tuned to heights from 1 meter to 4 meters and the rotatable table was turned from 0 degrees to 360 degrees to find the maximum reading.
- The test-receiver system was set to quasi-peak detect function and specified bandwidth with maximum hold mode when the test frequency is below 1 GHz.
- The test-receiver system was set to peak and average detects function and specified bandwidth with maximum hold mode when the test frequency is above 1 GHz. If the peak reading value also meets average limit, measurement with the average detector is unnecessary.

**Note:**

1. The resolution bandwidth and video bandwidth of test receiver/spectrum analyzer is 120kHz for Quasi-peak detection (QP) at frequency below 1GHz.
2. The resolution bandwidth of test receiver/spectrum analyzer is 1 MHz and the video bandwidth is 3 MHz for Peak detection (PK) at frequency above 1GHz.
3. The resolution bandwidth of test receiver/spectrum analyzer is 1MHz and the video bandwidth is  $\geq 1/T$  (Duty cycle < 98%) or 10Hz (Duty cycle  $\geq$  98%) for Average detection (AV) at frequency above 1GHz.
4. All modes of operation were investigated and the worst-case emissions are reported.

**For Band edge Measurement**

789033 D02 General U-NII Test Procedures New Rules v02r01, II.F. Method SA-1

1. For average emissions measurements, follow the procedures described in section II.G.6., "Procedures for Average Unwanted Emissions Measurements above 1000 MHz", except for the following changes:
2. Set RBW=100 kHz
3. Set VBW=300 kHz
4. Perform a band-power integration across the 1 MHz bandwidth in which the band-edge emission level is to be measured.

4.2.4 Deviation from Test Standard

No deviation.

#### 4.2.5 Test Setup

##### For Radiated emission below 30MHz

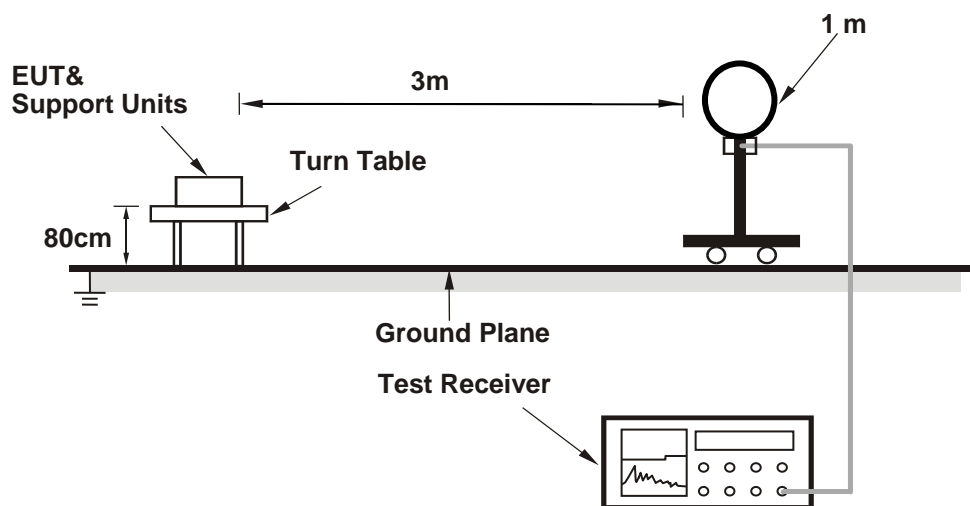

##### For Radiated emission 30MHz to 1GHz

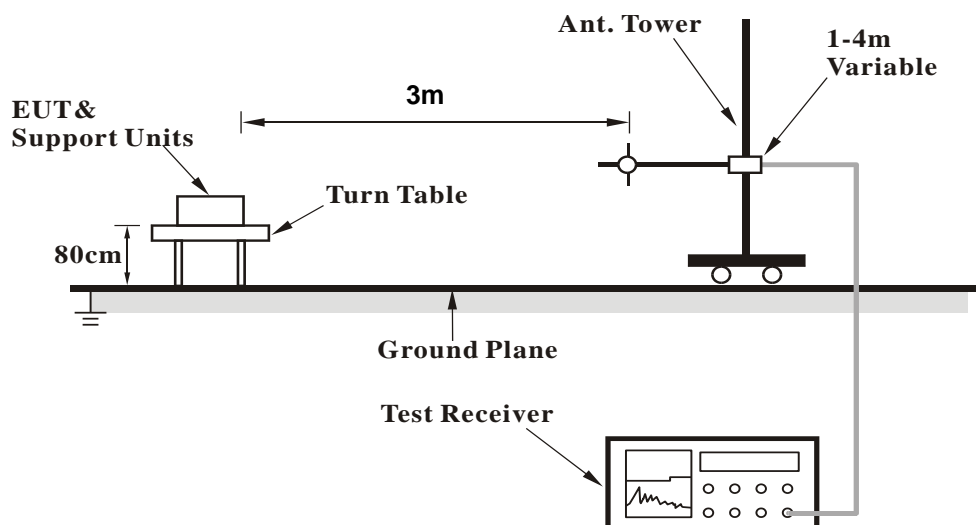

### For Radiated emission above 1GHz

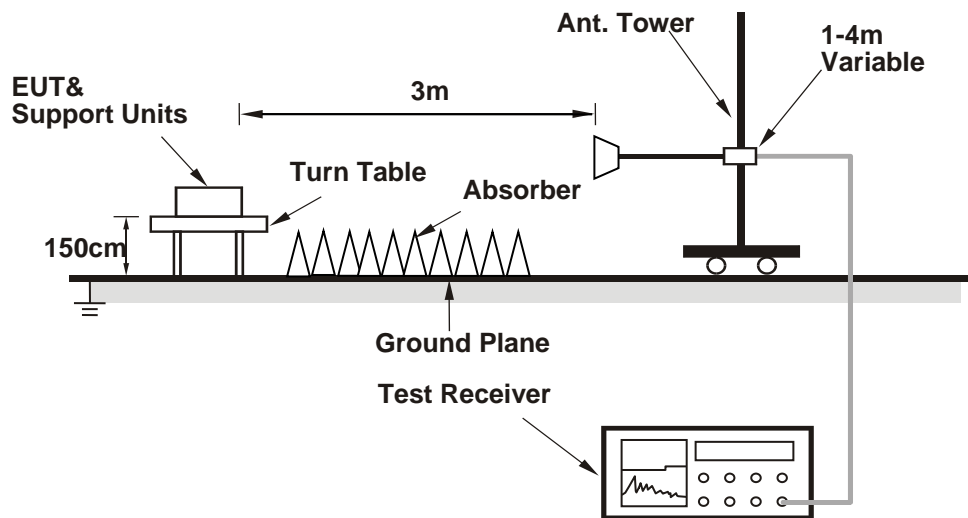

For the actual test configuration, please refer to the attached file (Test Setup Photo).

#### 4.2.6 EUT Operating Condition

- a. Placed the EUT on the testing table.
- b. Prepared notebooks to act as communication partner and placed it outside of testing area.
- c. The communication partner connected with EUT via a USB cable and ran a test program (provided by manufacturer) to enable EUT under transmission condition continuously at specific channel frequency.
- d. The necessary accessories enable the system in full functions.

#### 4.2.7 Test Results

##### Below 1GHz Worst-Case Data:

<b>CHANNEL</b>	802.11a Channel 40	<b>DETECTOR FUNCTION</b>	Quasi Peak
<b>FREQUENCY RANGE</b>	30MHz – 1GHz		

##### Antenna Polarity & Test Distance: Vertical and Horizontal at 3m

No.	Frequency (MHz)	Polarization (H/V)	Reading QP [dB(uV)]	Factor [dB(1/m)]	Level QP [dB(uV/m)]	Limit\QP dB(uV/m)	Margin QP [dB]	Height (cm)	Angle (Deg)	Pass/Fail
1	73.999	V	14.8	13	27.8	40	-12.2	100	0.4	Pass
2	100.013	V	15	16.7	31.7	43.5	-11.8	112	160	Pass
3	169.981	V	16.7	17.9	34.6	43.5	-8.9	154	153	Pass
4	180.015	V	19.9	17.6	37.5	43.5	-6	153	134	Pass
5	200.005	H	14.7	19.3	34	43.5	-9.5	154	10.6	Pass
6	599.982	V	12.2	25.5	37.7	46	-8.3	154	0.1	Pass

#### REMARKS:

1. Emission level (dBuV/m) = Raw Value (dBuV) + Cable Loss (dB) + AF (dB)
2. AF (dB/m) = Antenna Factor (dB/m) – Preamplifier Gain (dB).
3. Margin = Level (dBuV/m) - Limit value(dBuV/m)

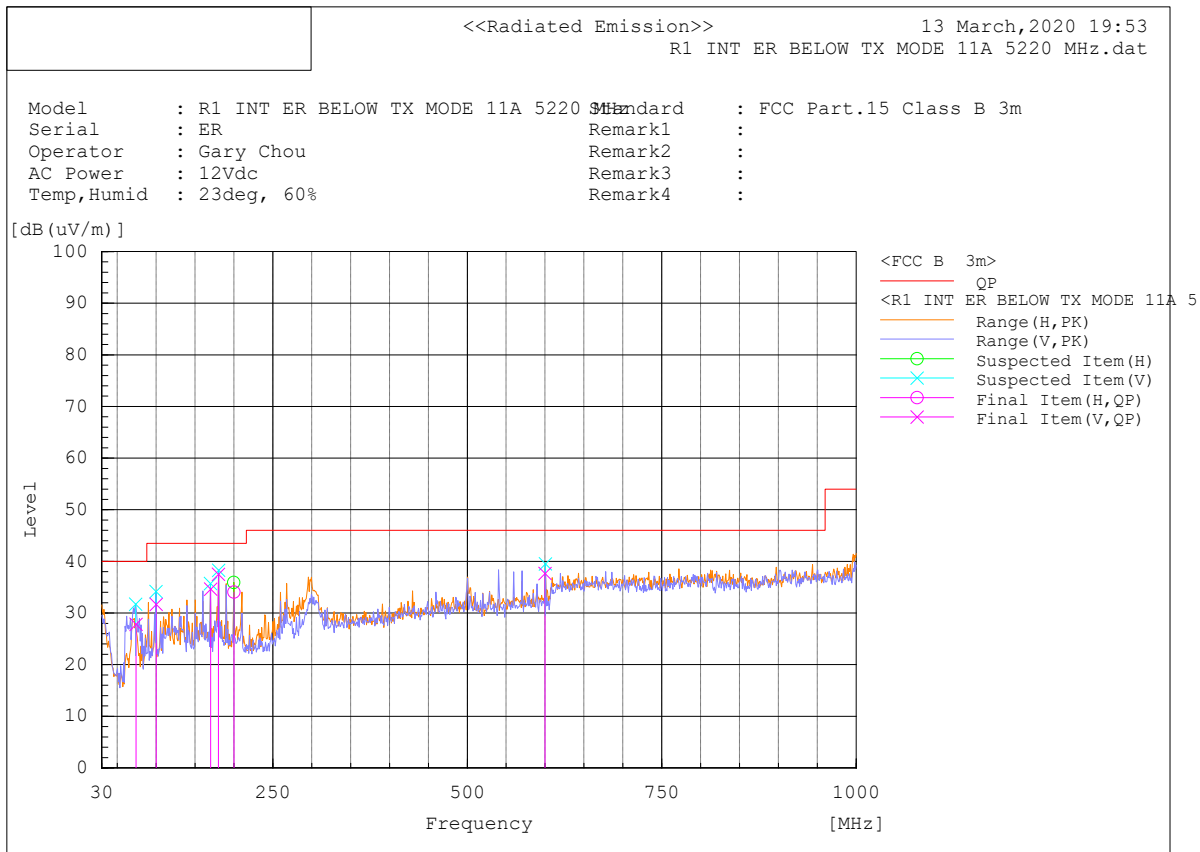

**Below 1GHz Worst-Case Data:**

<b>CHANNEL</b>	802.11a Channel 157	<b>DETECTOR FUNCTION</b>	Quasi Peak
<b>FREQUENCY RANGE</b>	30MHz – 1GHz		

**Antenna Polarity & Test Distance: Vertical and Horizontal at 3m**

No.	Frequency (MHz)	Polarization (H/V)	Reading QP [dB(uV)]	Factor [dB(1/m)]	Level QP [dB(uV/m)]	Limit\QP dB(uV/m)	Margin QP [dB]	Height (cm)	Angle (Deg)	Pass/Fail
1	70.009	V	18	13.1	31.1	40	-8.9	137	137.4	Pass
2	180.002	H	18.2	17.3	35.5	43.5	-8	120	274.3	Pass
3	189.987	H	17	17.6	34.6	43.5	-8.9	100	91.6	Pass
4	199.983	H	16.1	19.3	35.4	43.5	-8.1	100	89.9	Pass
5	599.98	V	11.5	25.5	37	46	-9	171	343.7	Pass
6	995.567	H	16.8	31.2	48	54	-6	146	123.2	Pass

**REMARKS:**

1. Emission level (dBuV/m) = Raw Value (dBuV) + Cable Loss (dB) + AF (dB)
2. AF (dB/m) = Antenna Factor (dB/m) – Preamplifier Gain (dB).
3. Margin = Level (dBuV/m) - Limit value(dBuV/m)

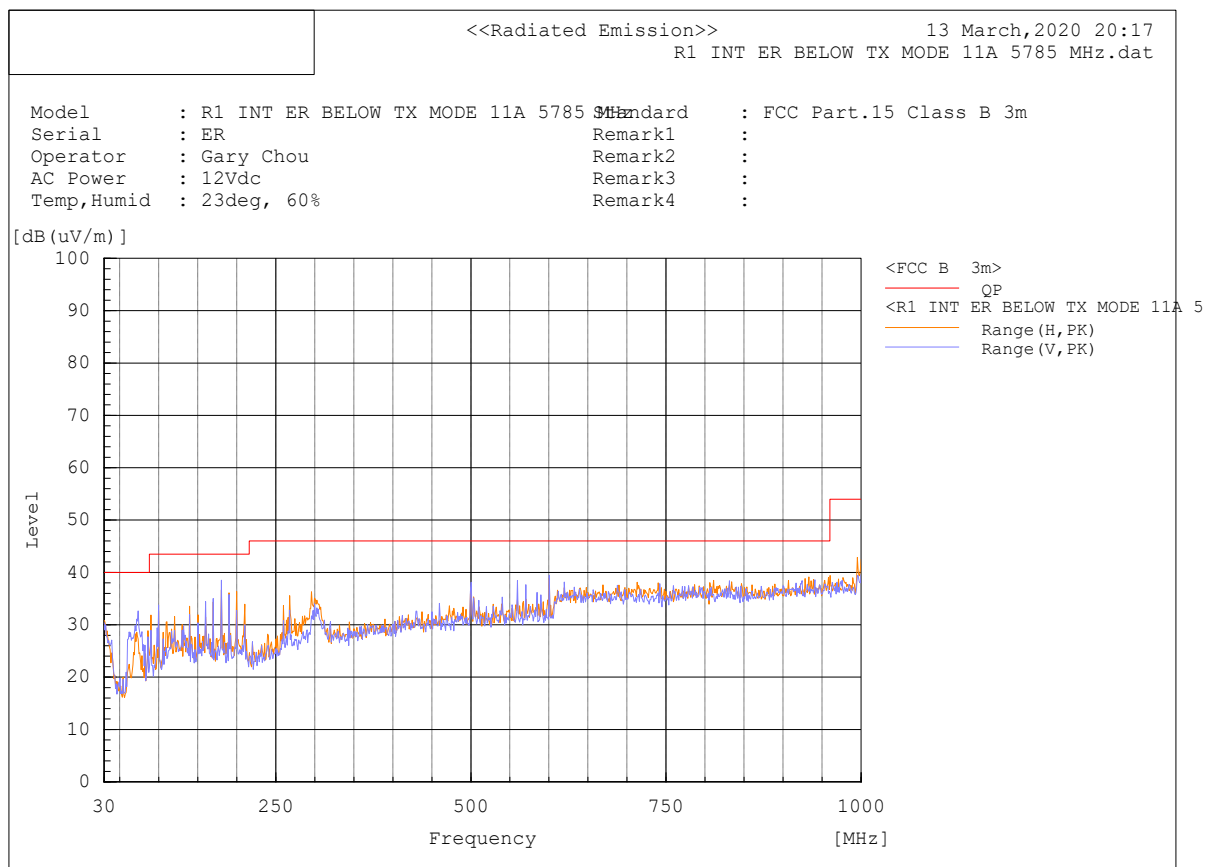

### Above 1GHz Test Data:

1GHz-40GHz – 802.11a – 5180MHz

Antenna Polarity & Test Distance: Vertical and Horizontal at 3m														
No.	Frequency (MHz)	Polarization (H/V)	Reading AV [dB(uV)]	Reading PK [dB(uV)]	Factor [dB(1/m)]	Level AV [dB(uV/m)]	Level PK dB(uV/m)	LimitAV dB(uV/m)	LimitPK [dB(uV/m)]	Margin AV [dB]	Margin PK [dB]	Height (cm)	Angle (Deg)	Pass/ Fail
1	2834.61	H	47.5	58.7	-9.1	38.4	49.6	54	74	-15.6	-24.4	273	277.3	Pass
2	10360.79	V	45.8	58.3	3.1	48.9	61.4	54	74	-5.1	-12.6	137	49.5	Pass
3	15540.076	V	34.2	47.5	8	42.2	55.5	54	74	-11.8	-18.5	108	327	Pass

1GHz-40GHz – 802.11a – 5200MHz

Antenna Polarity & Test Distance: Vertical and Horizontal at 3m														
No.	Frequency (MHz)	Polarization (H/V)	Reading AV [dB(uV)]	Reading PK [dB(uV)]	Factor [dB(1/m)]	Level AV [dB(uV/m)]	Level PK dB(uV/m)	LimitAV dB(uV/m)	LimitPK [dB(uV/m)]	Margin AV [dB]	Margin PK [dB]	Height (cm)	Angle (Deg)	Pass/ Fail
1	2835.556	H	50.2	58.8	-9.1	41.1	49.7	54	74	-12.9	-24.3	273	282.3	Pass
2	10399.303	V	44.9	58.7	3.2	48.1	61.9	54	74	-5.9	-12.1	137	49.1	Pass
3	15600.137	V	33.7	46.8	8.3	42	55.1	54	74	-12	-18.9	208	100.2	Pass

1GHz-40GHz – 802.11a – 5240MHz

Antenna Polarity & Test Distance: Vertical and Horizontal at 3m														
No.	Frequency (MHz)	Polarization (H/V)	Reading AV [dB(uV)]	Reading PK [dB(uV)]	Factor [dB(1/m)]	Level AV [dB(uV/m)]	Level PK dB(uV/m)	LimitAV dB(uV/m)	LimitPK [dB(uV/m)]	Margin AV [dB]	Margin PK [dB]	Height (cm)	Angle (Deg)	Pass/ Fail
1	2836.935	H	47.3	57.8	-9.1	38.2	48.7	54	74	-15.8	-25.3	215	261.5	Pass
2	10479.363	V	46.6	60.1	3.4	50	63.5	54	74	-4	-10.5	180	64.7	Pass
3	15719.911	V	33.3	47.2	8.5	41.8	55.7	54	74	-12.2	-18.3	100	211.4	Pass

1GHz-40GHz – 802.11n(HT20) – 5180MHz

Antenna Polarity & Test Distance: Vertical and Horizontal at 3m														
No.	Frequency (MHz)	Polarization (H/V)	Reading AV [dB(uV)]	Reading PK [dB(uV)]	Factor [dB(1/m)]	Level AV [dB(uV/m)]	Level PK dB(uV/m)	LimitAV dB(uV/m)	LimitPK [dB(uV/m)]	Margin AV [dB]	Margin PK [dB]	Height (cm)	Angle (Deg)	Pass/ Fail
1	2386.103	H	41.5	54.8	-9.8	31.7	45	54	74	-22.3	-29	258	268.7	Pass
2	10358.813	V	45.5	59.8	3.1	48.6	62.9	54	74	-5.4	-11.1	100	5.1	Pass
3	15539.857	V	33.8	47.2	8	41.8	55.2	54	74	-12.2	-18.8	244	29.6	Pass

1GHz-40GHz – 802.11n(HT20) – 5200MHz

Antenna Polarity & Test Distance: Vertical and Horizontal at 3m														
No.	Frequency (MHz)	Polarization (H/V)	Reading AV [dB(uV)]	Reading PK [dB(uV)]	Factor [dB(1/m)]	Level AV [dB(uV/m)]	Level PK dB(uV/m)	LimitAV dB(uV/m)	LimitPK [dB(uV/m)]	Margin AV [dB]	Margin PK [dB]	Height (cm)	Angle (Deg)	Pass/ Fail
1	2833.45	H	47.3	58.1	-9.1	38.2	49	54	74	-15.8	-25	122	40.1	Pass
2	10400	V	45.7	59.8	3.2	48.9	63	54	74	-5.1	-11	172	1.1	Pass
3	15599.492	V	34.1	47.2	8.3	42.4	55.5	54	74	-11.6	-18.5	237	354.3	Pass

**1GHz-40GHz – 802.11n(HT20) – 5240MHz**

Antenna Polarity & Test Distance: Vertical and Horizontal at 3m														
No.	Frequency (MHz)	Polarization (H/V)	Reading AV [dB(uV)]	Reading PK [dB(uV)]	Factor [dB(1/m)]	Level AV [dB(uV/m)]	Level PK dB(uV/m)	LimitAV dB(uV/m)	LimitPK [dB(uV/m)]	Margin AV [dB]	Margin PK [dB]	Height (cm)	Angle (Deg)	Pass/ Fail
1	2836	H	49.2	59.9	-9.1	40.1	50.8	54	74	-13.9	-23.2	108	53.8	Pass
2	10478.802	V	45	59.1	3.4	48.4	62.5	54	74	-5.6	-11.5	122	0.1	Pass
3	15719.793	V	33.6	47.1	8.5	42.1	55.6	54	74	-11.9	-18.4	100	0.6	Pass

**1GHz-40GHz – 802.11n(HT40) – 5190MHz**

Antenna Polarity & Test Distance: Vertical and Horizontal at 3m														
No.	Frequency (MHz)	Polarization (H/V)	Reading AV [dB(uV)]	Reading PK [dB(uV)]	Factor [dB(1/m)]	Level AV [dB(uV/m)]	Level PK dB(uV/m)	LimitAV dB(uV/m)	LimitPK [dB(uV/m)]	Margin AV [dB]	Margin PK [dB]	Height (cm)	Angle (Deg)	Pass/ Fail
1	2836.387	H	55.8	-9.1	34.5	46.7	54	74	19.5	-19.5	-27.3	366	218	Pass
2	10379.895	V	55.6	3.1	43.5	58.7	54	74	10.5	-10.5	-15.3	137	53.8	Pass
3	15569.199	V	46.6	8.2	41.9	54.8	54	74	12.1	-12.1	-19.2	151	84.6	Pass

**1GHz-40GHz – 802.11n(HT40) – 5230MHz**

Antenna Polarity & Test Distance: Vertical and Horizontal at 3m														
No.	Frequency (MHz)	Polarization (H/V)	Reading AV [dB(uV)]	Reading PK [dB(uV)]	Factor [dB(1/m)]	Level AV [dB(uV/m)]	Level PK dB(uV/m)	LimitAV dB(uV/m)	LimitPK [dB(uV/m)]	Margin AV [dB]	Margin PK [dB]	Height (cm)	Angle (Deg)	Pass/ Fail
1	2836.473	H	47.7	58	-9.1	38.6	48.9	54	74	-15.4	-25.1	172	267.5	Pass
2	10459.889	V	42.9	57.5	3.4	46.3	60.9	54	74	-7.7	-13.1	180	60.9	Pass
3	15689.248	V	33.5	47.2	8.5	42	55.7	54	74	-12	-18.3	194	0	Pass

**1GHz-40GHz – 802.11ac(VHT80) – 5210MHz**

Antenna Polarity & Test Distance: Vertical and Horizontal at 3m														
No.	Frequency (MHz)	Polarization (H/V)	Reading AV [dB(uV)]	Reading PK [dB(uV)]	Factor [dB(1/m)]	Level AV [dB(uV/m)]	Level PK dB(uV/m)	LimitAV dB(uV/m)	LimitPK [dB(uV/m)]	Margin AV [dB]	Margin PK [dB]	Height (cm)	Angle (Deg)	Pass/ Fail
1	2836.365	H	49.5	59	-9.1	40.4	49.9	54	74	-13.6	-24.1	265	278.4	Pass
2	10419.808	V	38.3	53.4	3.3	41.6	56.7	54	74	-12.4	-17.3	165	45.5	Pass
3	15629.445	V	33.5	47	8.4	41.9	55.4	54	74	12.1	-18.6	201	91.5	Pass

**1GHz-40GHz – 802.11a – 5745MHz**

Antenna Polarity & Test Distance: Vertical and Horizontal at 3m														
No.	Frequency (MHz)	Polarization (H/V)	Reading AV [dB(uV)]	Reading PK [dB(uV)]	Factor [dB(1/m)]	Level AV [dB(uV/m)]	Level PK dB(uV/m)	LimitAV dB(uV/m)	LimitPK [dB(uV/m)]	Margin AV [dB]	Margin PK [dB]	Height (cm)	Angle (Deg)	Pass/ Fail
1	2834.936	H	50.9	61.1	-9.1	41.8	52	54	74	-12.2	-22	122	43.4	Pass
2	11490.036	V	40.1	54.4	4	44.1	58.4	54	74	-9.9	-15.6	130	289	Pass
3	17235.616	V	32.1	45.6	11.2	43.3	56.8	54	74	-10.7	-17.2	280	61	Pass



## 1GHz-40GHz – 802.11a – 5785MHz

Antenna Polarity & Test Distance: Vertical and Horizontal at 3m														
No.	Frequency (MHz)	Polarization (H/V)	Reading AV [dB(uV)]	Reading PK [dB(uV)]	Factor [dB(1/m)]	Level AV [dB(uV/m)]	Level PK [dB(uV/m)]	LimitAV [dB(uV/m)]	LimitPK [dB(uV/m)]	Margin AV [dB]	Margin PK [dB]	Height (cm)	Angle (Deg)	Pass/ Fail
1	1850.887	H	52.3	61	-11.2	41.1	49.8	54	74	-12.9	-24.2	165	67.4	Pass
2	11558.22	V	38.5	54.1	4.2	42.7	58.3	54	74	-11.3	-15.7	244	327.8	Pass
3	17355.462	V	32.1	45.9	11.3	43.4	57.2	54	74	-10.6	-16.8	102	183.7	Pass

## 1GHz-40GHz – 802.11a – 5825MHz

Antenna Polarity & Test Distance: Vertical and Horizontal at 3m														
No.	Frequency (MHz)	Polarization (H/V)	Reading AV [dB(uV)]	Reading PK [dB(uV)]	Factor [dB(1/m)]	Level AV [dB(uV/m)]	Level PK [dB(uV/m)]	LimitAV [dB(uV/m)]	LimitPK [dB(uV/m)]	Margin AV [dB]	Margin PK [dB]	Height (cm)	Angle (Deg)	Pass/ Fail
1	1847.49	H	53.6	62.7	-11.3	42.3	51.4	54	74	-11.7	-22.6	136	53.5	Pass
2	11648.909	V	43.4	56.7	4.4	47.8	61.1	54	74	-6.2	-12.9	187	339.1	Pass
3	17475.696	V	31.8	45.4	12.3	44.1	57.7	54	74	-9.9	-16.3	358	211.8	Pass

## 1GHz-40GHz – 802.11n(HT20) – 5745MHz

Antenna Polarity & Test Distance: Vertical and Horizontal at 3m														
No.	Frequency (MHz)	Polarization (H/V)	Reading AV [dB(uV)]	Reading PK [dB(uV)]	Factor [dB(1/m)]	Level AV [dB(uV/m)]	Level PK [dB(uV/m)]	LimitAV [dB(uV/m)]	LimitPK [dB(uV/m)]	Margin AV [dB]	Margin PK [dB]	Height (cm)	Angle (Deg)	Pass/ Fail
1	1850.19	V	49	58.9	-11.2	37.8	47.7	54	74	-16.2	-26.3	323	0.3	Pass
2	11489.997	H	40.3	54.9	4	44.3	58.9	54	74	-9.7	-15.1	222	359.9	Pass
3	17234.19	H	32	45.3	11.2	43.2	56.5	54	74	-10.8	-17.5	230	327	Pass

## 1GHz-40GHz – 802.11n(HT20) – 5785MHz

Antenna Polarity & Test Distance: Vertical and Horizontal at 3m														
No.	Frequency (MHz)	Polarization (H/V)	Reading AV [dB(uV)]	Reading PK [dB(uV)]	Factor [dB(1/m)]	Level AV [dB(uV/m)]	Level PK [dB(uV/m)]	LimitAV [dB(uV/m)]	LimitPK [dB(uV/m)]	Margin AV [dB]	Margin PK [dB]	Height (cm)	Angle (Deg)	Pass/ Fail
1	2834.952	H	47.3	58	-9.1	38.2	48.9	54	74	-15.8	-25.1	122	40.7	Pass
2	11569.942	V	43.8	58.2	4.2	48	62.4	54	74	-6	--11.6	222	297.3	Pass
3	17356.226	V	32	45.8	11.3	43.3	57.1	54	74	-10.7	16.9	158	0	Pass

## 1GHz-40GHz – 802.11n(HT20) – 5825MHz

Antenna Polarity & Test Distance: Vertical and Horizontal at 3m														
No.	Frequency (MHz)	Polarization (H/V)	Reading AV [dB(uV)]	Reading PK [dB(uV)]	Factor [dB(1/m)]	Level AV [dB(uV/m)]	Level PK [dB(uV/m)]	LimitAV [dB(uV/m)]	LimitPK [dB(uV/m)]	Margin AV [dB]	Margin PK [dB]	Height (cm)	Angle (Deg)	Pass/ Fail
1	2834.812	H	49.1	60	-9.1	40	50.9	54	74	-14	-23.1	108	52.9	Pass
2	11650.944	V	44.3	58.5	4.4	48.7	62.9	54	74	-5.3	-11.1	222	298.8	Pass
3	17474.644	V	31.8	44.8	12.3	44.1	57.1	54	74	-9.9	-16.9	244	224.8	Pass

## 1GHz-40GHz – 802.11n(HT40) – 5755MHz

Antenna Polarity & Test Distance: Vertical and Horizontal at 3m														
No.	Frequency (MHz)	Polarization (H/V)	Reading AV [dB(uV)]	Reading PK [dB(uV)]	Factor [dB(1/m)]	Level AV [dB(uV/m)]	Level PK [dB(uV/m)]	LimitAV [dB(uV/m)]	LimitPK [dB(uV/m)]	Margin AV [dB]	Margin PK [dB]	Height (cm)	Angle (Deg)	Pass/ Fail
1	2836.441	H	48.1	57.9	-9.1	39	48.8	54	74	-15	-25.2	194	262.2	Pass
2	11511.321	V	40	54.3	4.1	44.1	58.4	54	74	-9.9	-15.6	244	310.3	Pass
3	17625.452	V	31.6	45.1	11.7	43.3	56.8	54	74	-10.7	-17.2	244	163	Pass

## 1GHz-40GHz – 802.11n(HT40)– 5795MHz

Antenna Polarity & Test Distance: Vertical and Horizontal at 3m														
No.	Frequency (MHz)	Polarization (H/V)	Reading AV [dB(uV)]	Reading PK [dB(uV)]	Factor [dB(1/m)]	Level AV [dB(uV/m)]	Level PK [dB(uV/m)]	LimitAV [dB(uV/m)]	LimitPK [dB(uV/m)]	Margin AV [dB]	Margin PK [dB]	Height (cm)	Angle (Deg)	Pass/ Fail
1	2836.397	H	48.4	58.2	-9.1	39.3	49.1	54	74	-14.7	-24.9	215	238.9	Pass
2	11589.976	V	41.9	56.1	4.3	46.2	60.4	54	74	-7.8	-13.6	222	298.9	Pass
3	17383.822	V	32.1	45.3	11.6	43.7	56.9	54	74	-10.3	-17.1	365	191.5	Pass

## 1GHz-40GHz – 802.11ac(VHT80) – 5775MHz

Antenna Polarity & Test Distance: Vertical and Horizontal at 3m														
No.	Frequency (MHz)	Polarization (H/V)	Reading AV [dB(uV)]	Reading PK [dB(uV)]	Factor [dB(1/m)]	Level AV [dB(uV/m)]	Level PK [dB(uV/m)]	LimitAV [dB(uV/m)]	LimitPK [dB(uV/m)]	Margin AV [dB]	Margin PK [dB]	Height (cm)	Angle (Deg)	Pass/ Fail
1	2836.313	H	48.6	58.6	-9.1	39.5	49.5	54	74	-14.5	-24.5	100	209.1	Pass
2	11550.06	V	36.9	51.4	4.1	41	55.5	54	74	-13	-18.5	165	298.4	Pass
3	17324.472	V	32.2	45.6	11.1	43.3	56.7	54	74	-10.7	-17.3	287	145.3	Pass

**RESTRICTED BAND Test Plots**  
**802.11a – 5180MHz**

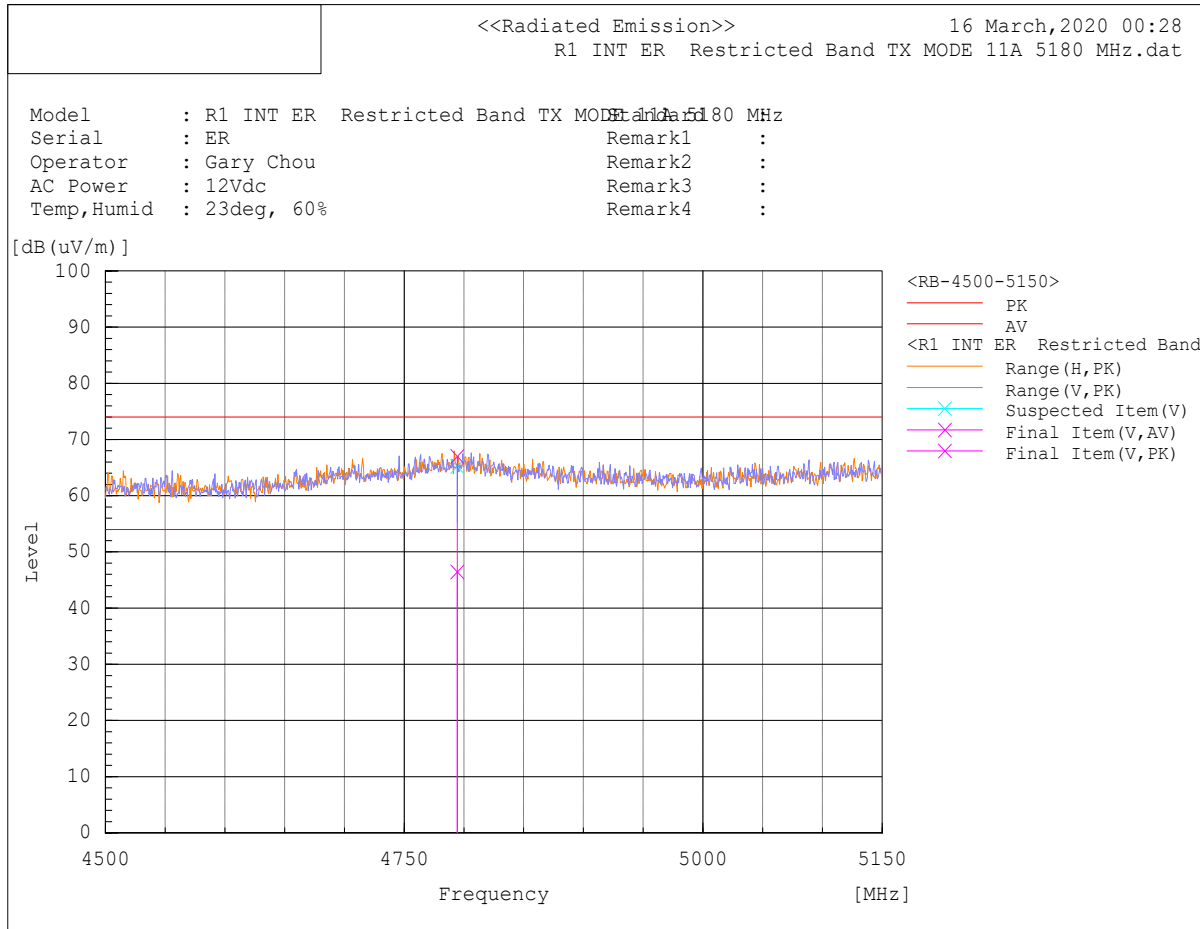

Antenna Polarity & Test Distance: Vertical and Horizontal at 3m

No.	Frequency (MHz)	Polarization (H/V)	Reading AV [dB(uV)]	Reading PK [dB(uV)]	Factor [dB(1/m)]	Level AV [dB(uV/m)]	Level PK dB(uV/m)	Limit\AV dB(uV/m)	Limit\PK [dB(uV/m)]	Margin AV [dB]	Margin PK [dB]	Height (cm)	Angle (Deg)	Pass/Fail
1	4794.45	V	6.8	27.3	39.7	46.5	67	54	74	-7.5	-7	152	264.6	Pass

**RESTRICTED BAND**  
**802.11n(HT20) – 5180MHz**

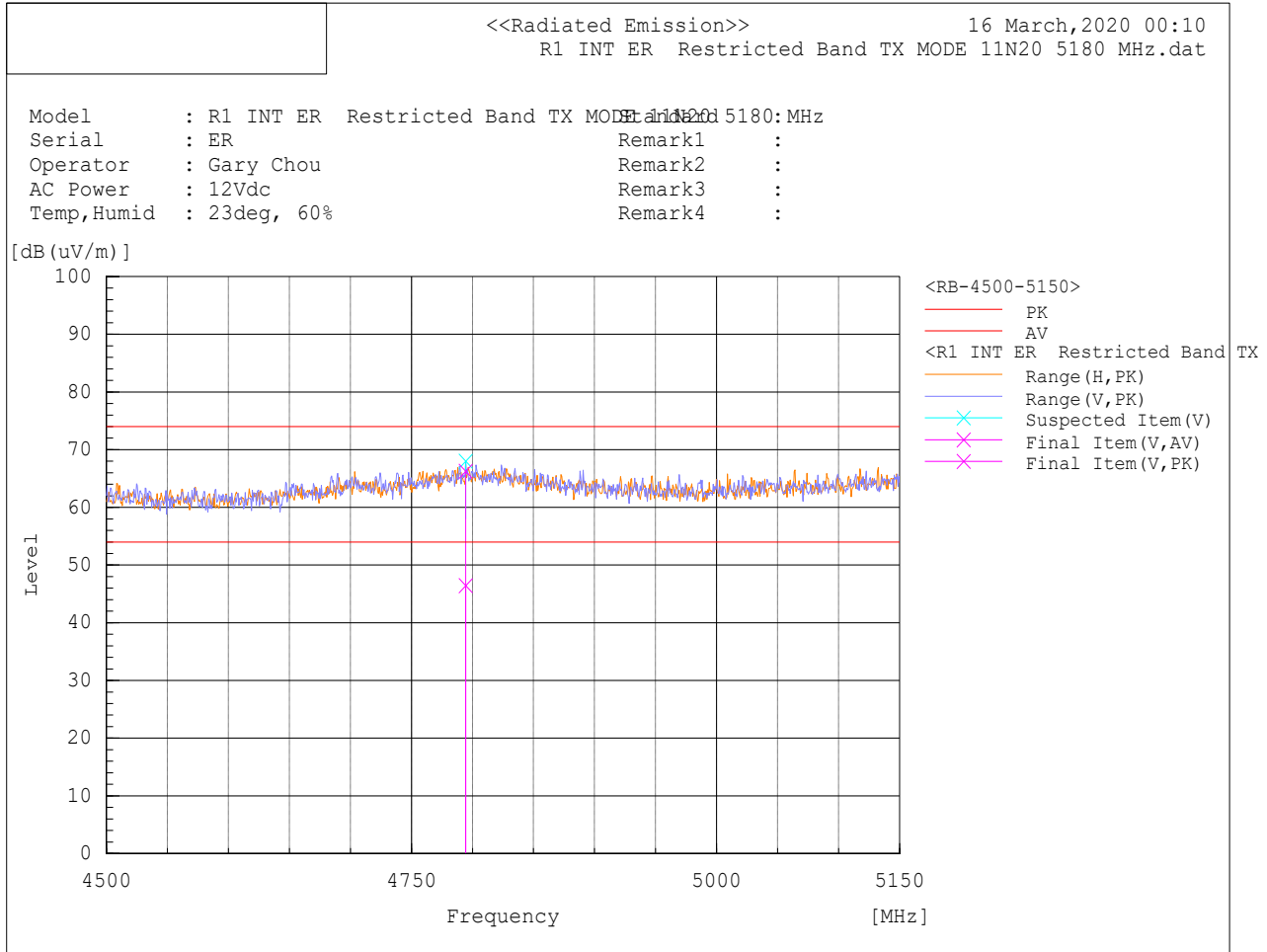

Antenna Polarity & Test Distance: Vertical and Horizontal at 3m														
No.	Frequency (MHz)	Polarization (H/V)	Reading AV [dB(uV)]	Reading PK [dB(uV)]	Factor [dB(1/m)]	Level AV [dB(uV/m)]	Level PK dB(uV/m)	Limit\AV dB(uV/m)	Limit\PK [dB(uV/m)]	Margin AV [dB]	Margin PK [dB]	Height (cm)	Angle (Deg)	Pass/Fail
1	4794.45	V	6.7	26.6	39.7	46.4	66.3	54	74	-7.6	-7.7	195	201.3	Pass

**RESTRICTED BAND**  
**802.11n(HT40) – 5190MHz**

<<Radiated Emission>> 15 March, 2020 23:48  
 R1 INT ER Restricted Band TX MODE 11N40 5190 MHz.dat

Model : R1 INT ER Restricted Band TX MODE 11N40 5190:MHz  
 Serial : ER Remark1 :  
 Operator : Gary Chou Remark2 :  
 AC Power : 12Vdc Remark3 :  
 Temp, Humid : 23deg, 60% Remark4 :

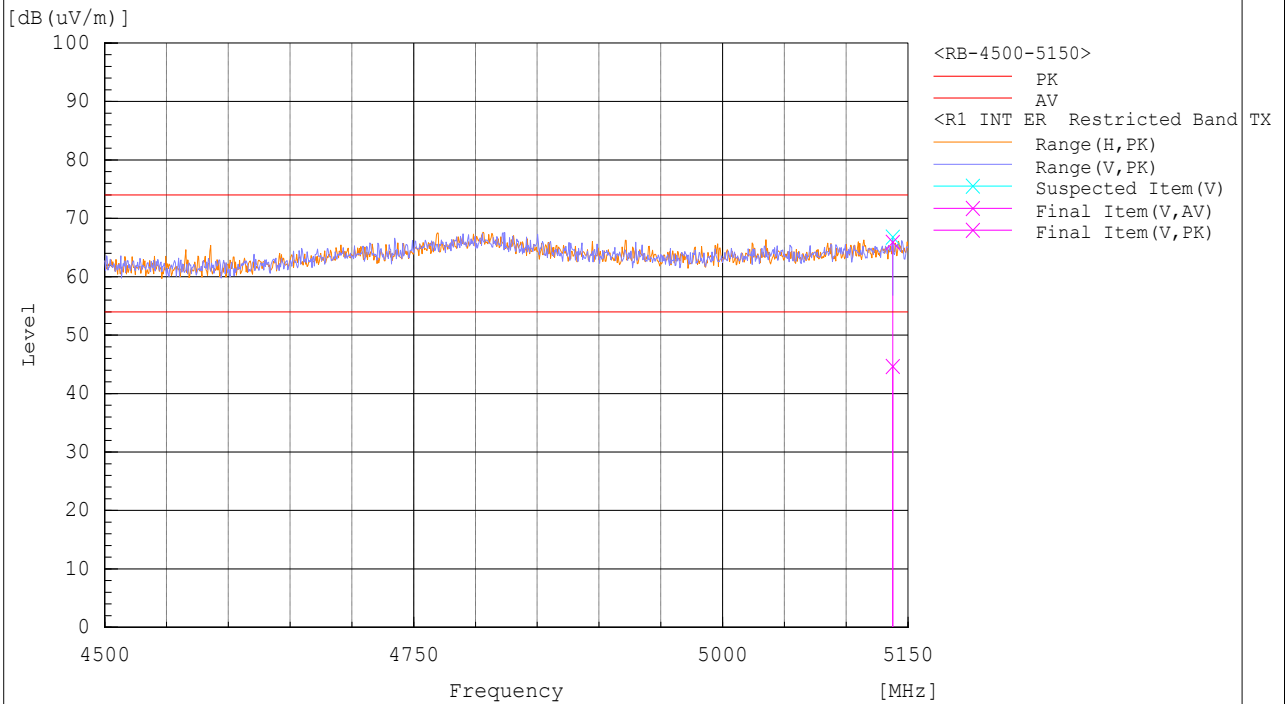

Antenna Polarity & Test Distance: Vertical and Horizontal at 3m

No.	Frequency (MHz)	Polarization (H/V)	Reading AV [dB(uV)]	Reading PK [dB(uV)]	Factor [dB(1/m)]	Level AV [dB(uV/m)]	Level PK dB(uV/m)	Limit\AV dB(uV/m)	Limit\PK [dB(uV/m)]	Margin AV [dB]	Margin PK [dB]	Height (cm)	Angle (Deg)	Pass/Fail
1	5137.65	V	5.2	26.4	39.5	44.7	65.9	54	74	-9.3	-8.1	141	333.4	Pass

**RESTRICTED BAND**  
**802.11n(VHT80) – 5210MHz**

<<Radiated Emission>> 15 March,2020 23:19  
 R1 INT ER Restricted Band TX MODE 11AC80 5210 MHz.dat

Model : R1 INT ER Restricted Band TX MODE 11AC80 5210 MHz  
 Serial : ER Remark1 :  
 Operator : Gary Chou Remark2 :  
 AC Power : 12Vdc Remark3 :  
 Temp,Humid : 23deg, 60% Remark4 :

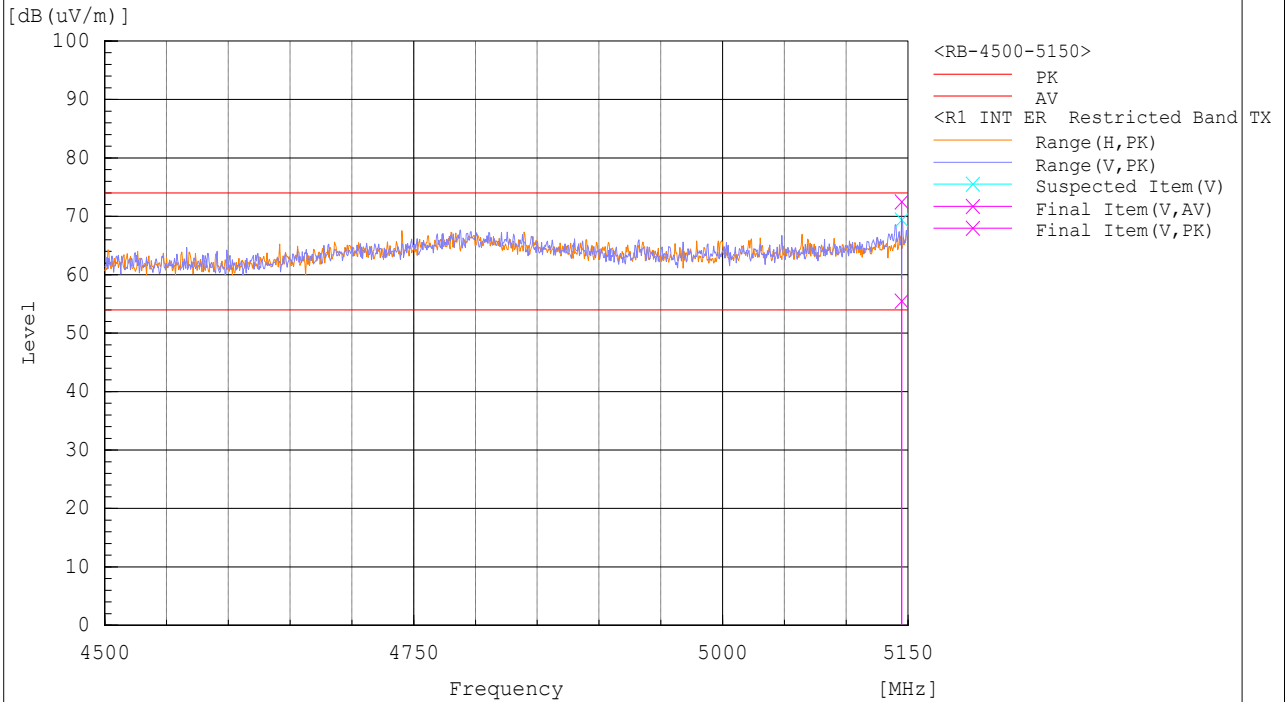

Antenna Polarity & Test Distance: Vertical and Horizontal at 3m

No.	Frequency (MHz)	Polarization (H/V)	Reading AV [dB(uV)]	Reading PK [dB(uV)]	Factor [dB(1/m)]	Level AV [dB(uV/m)]	Level PK [dB(uV/m)]	Limit\AV [dB(uV/m)]	Limit\PK [dB(uV/m)]	Margin AV [dB]	Margin PK [dB]	Height (cm)	Angle (Deg)	Pass/Fail
1	5144.801	V	16	33	39.5	55.5	72.5	54	74	-1.5	-1.5	112	330.8	Pass

Band Edge Test Plots for U-NII-1 Band:

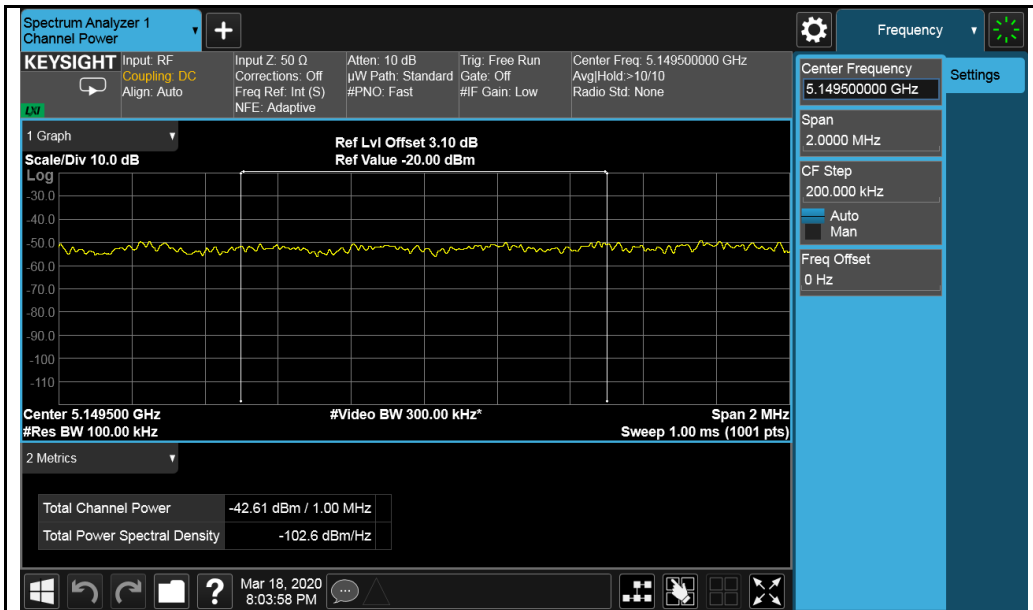

802.11a-5180MHz

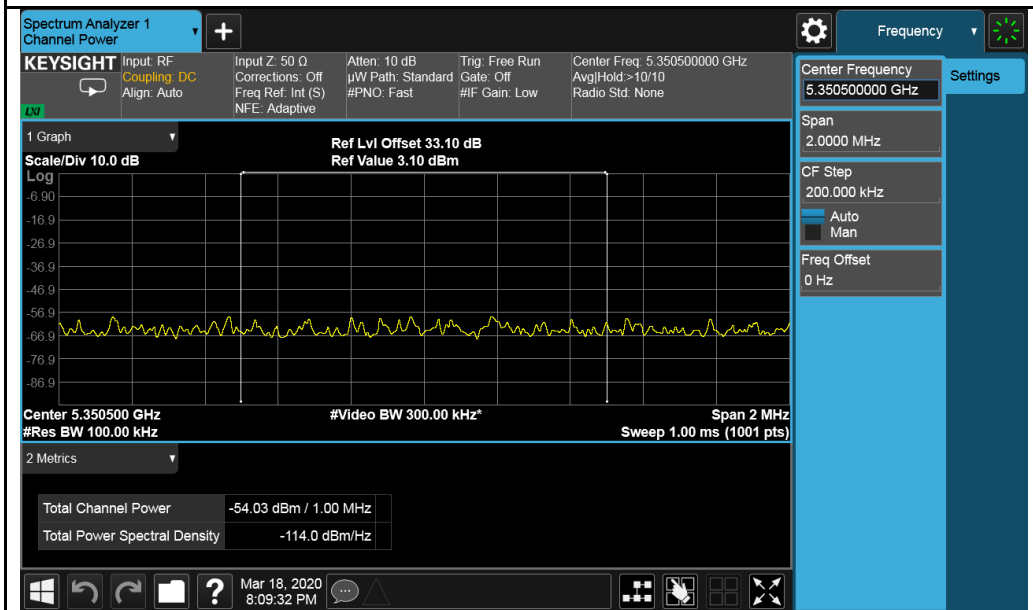

802.11a-5240MHz

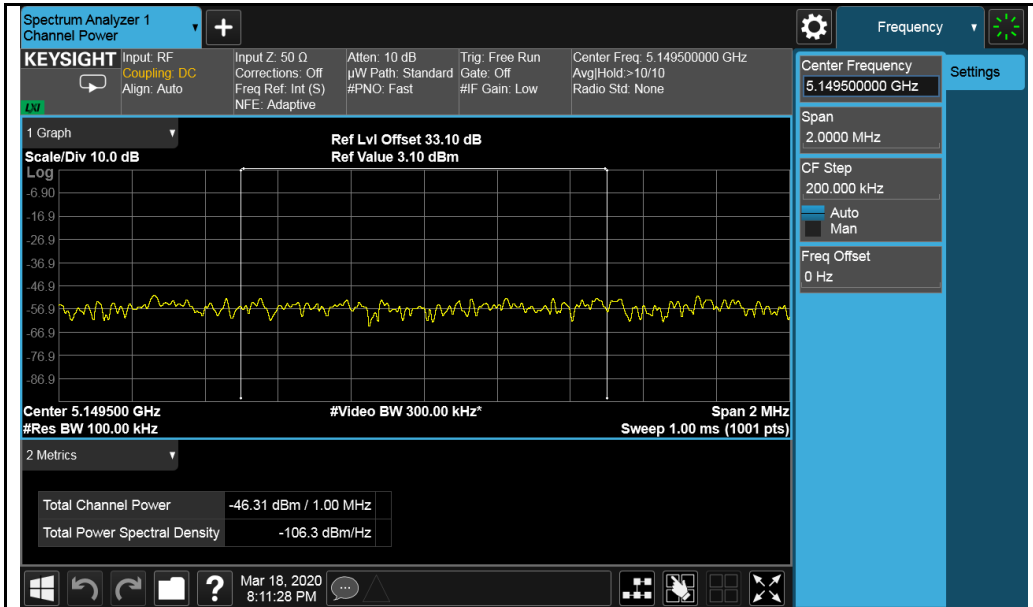

802.11n(HT20)-5180MHz

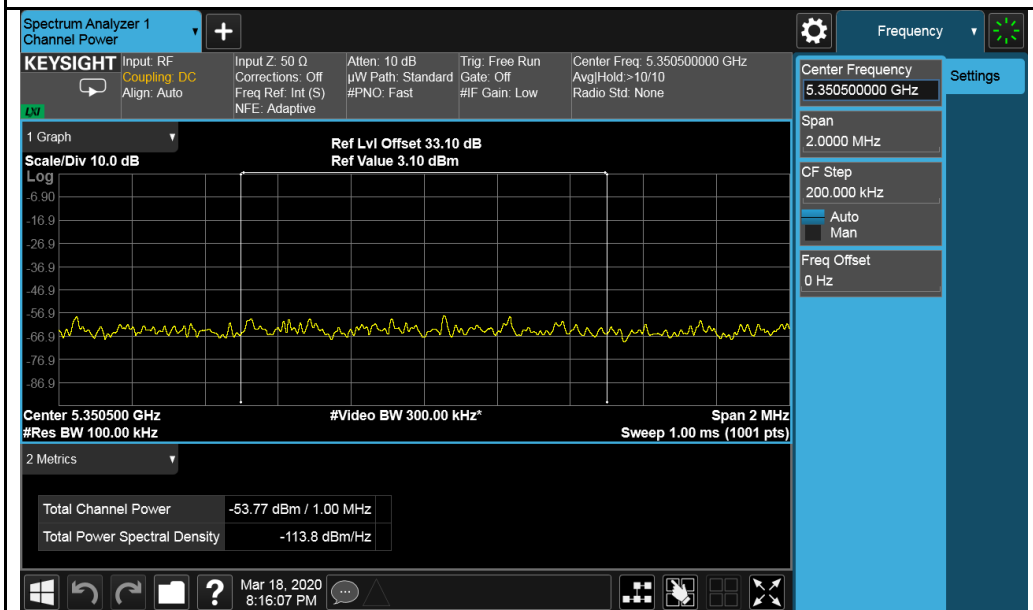

802.11n(HT40)-5240MHz



Test Plots for U-NII-3 Band:

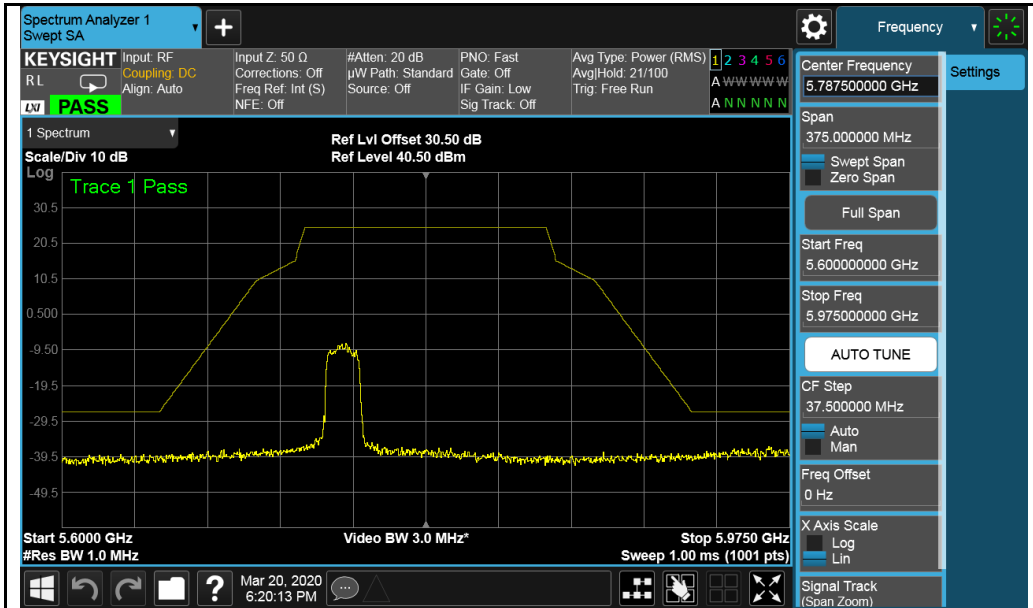

802.11a-5745MHz

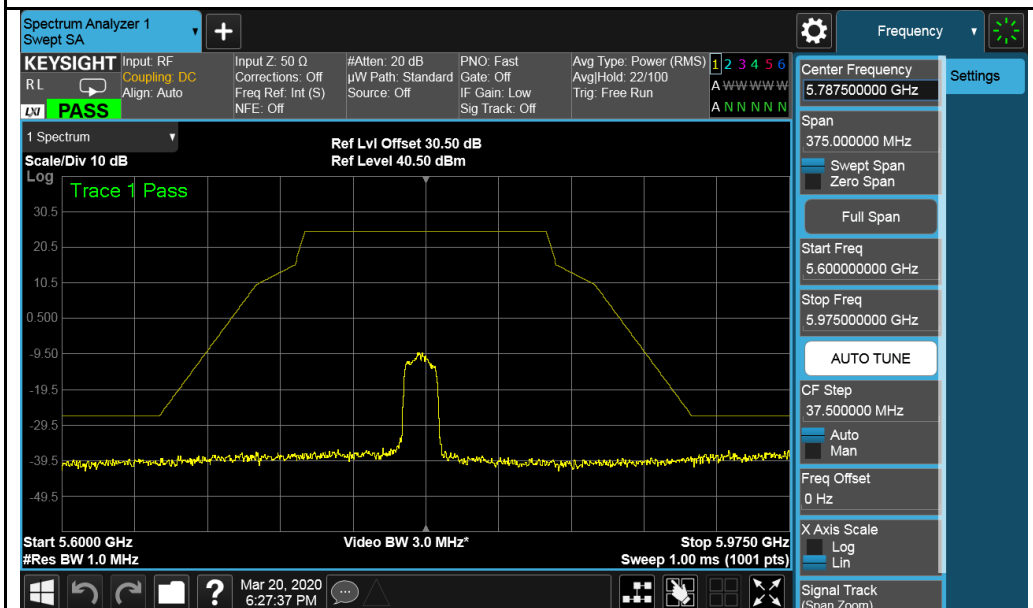

802.11a-5785MHz

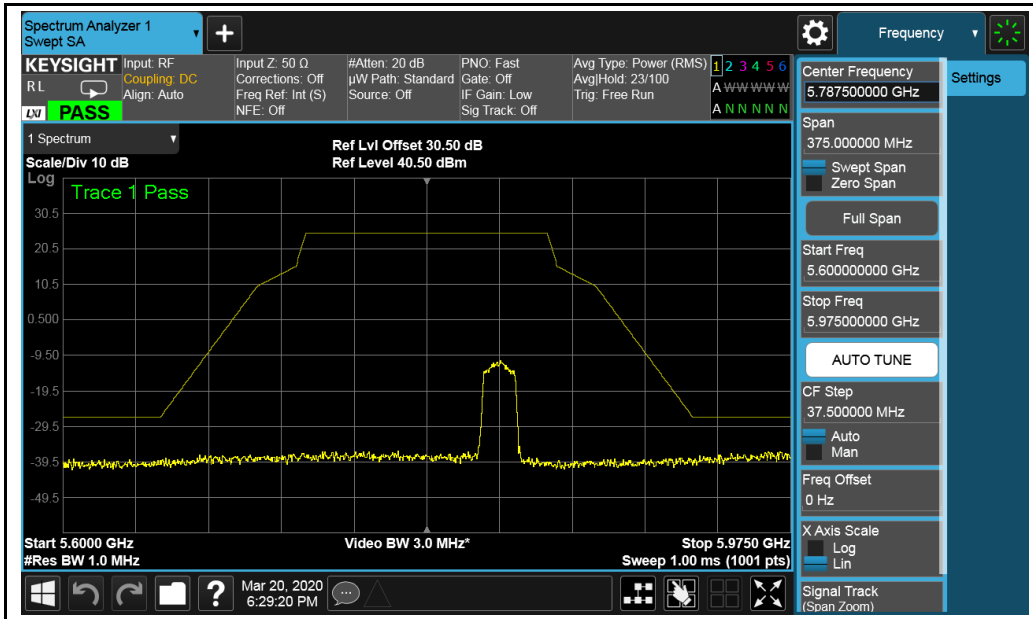

802.11a-5825MHz



802.11n(HT20)-5745MHz

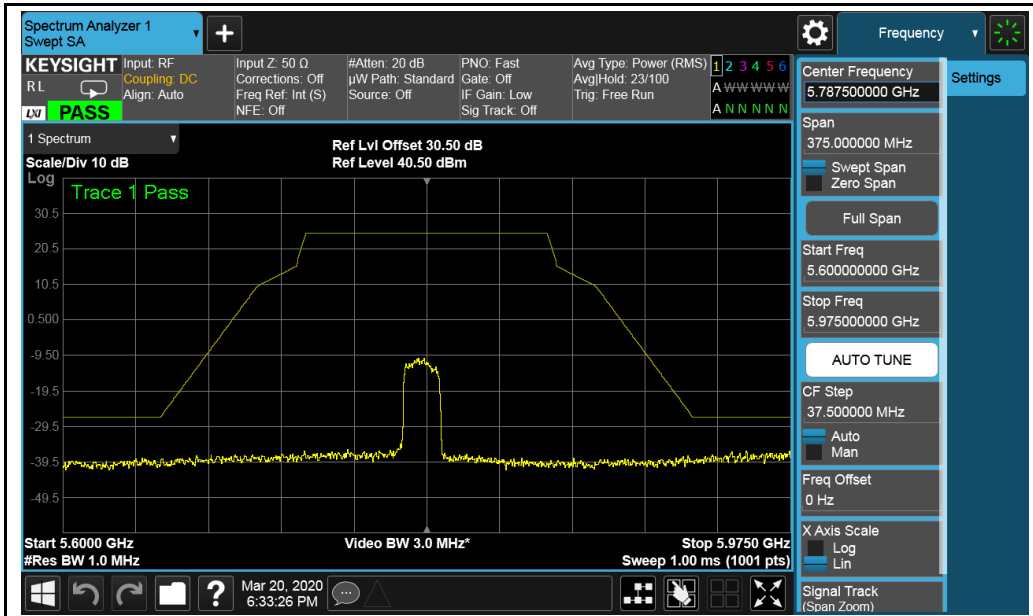

802.11n(HT20)-5785MHz

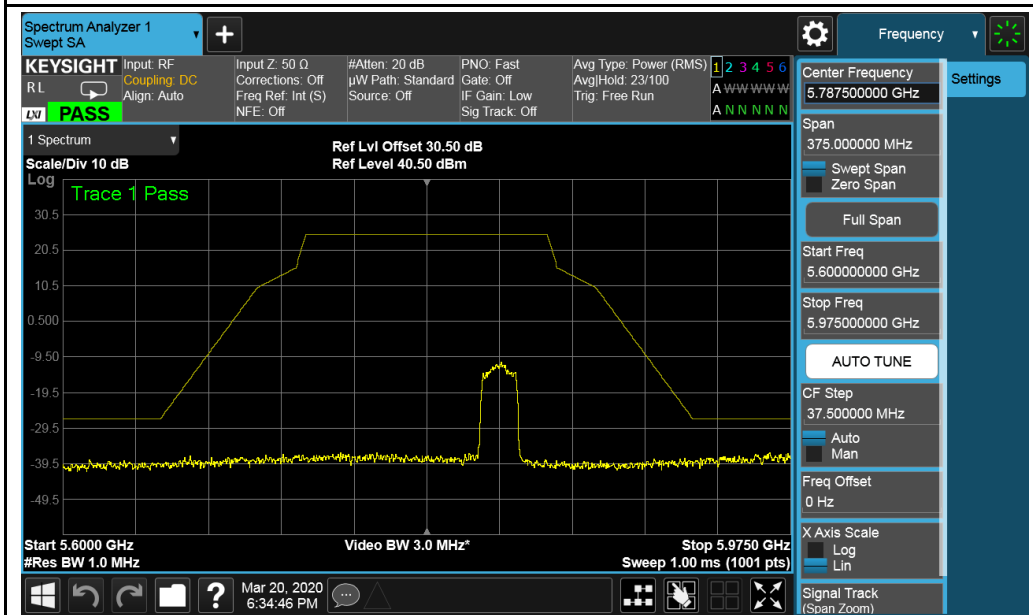

802.11n(HT20)-5825MHz



802.11n(HT40)-5755MHz

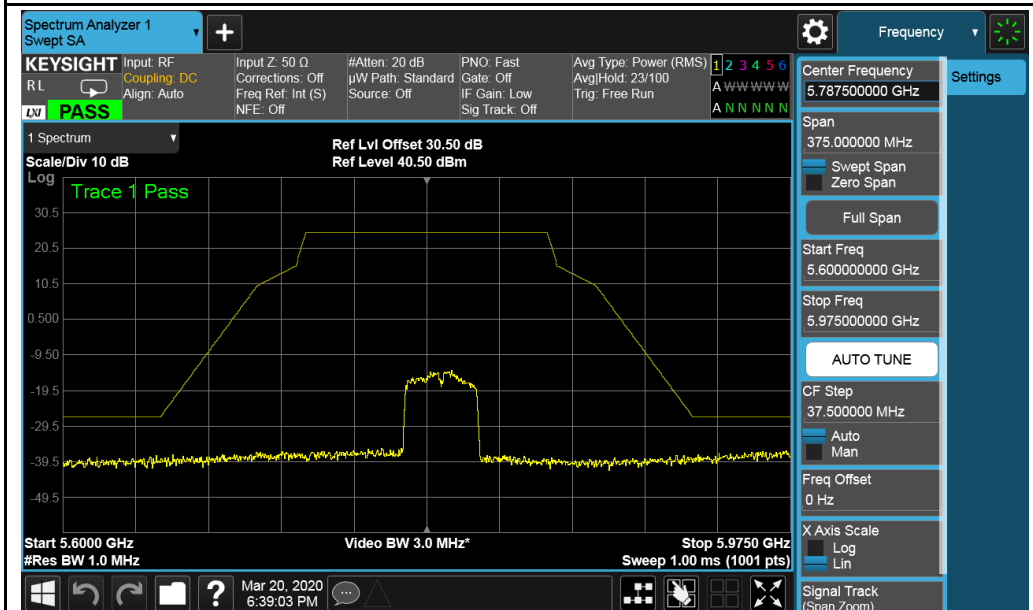

802.11n(HT40)-5795MHz

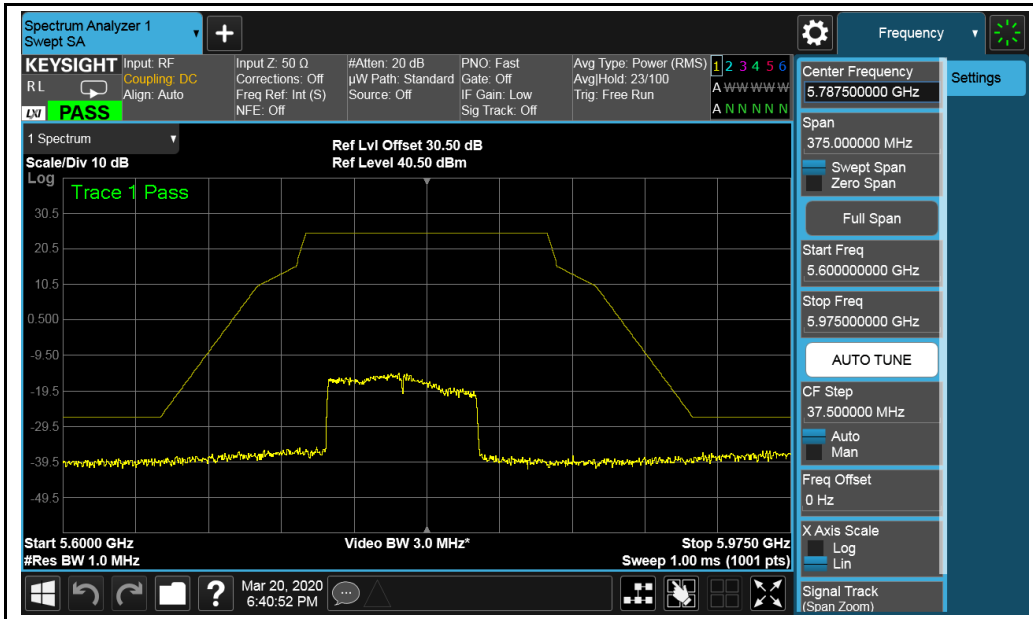

802.11n ac(VHT80)-5775MHz

### 4.3 Transmit Power Measurement

#### 4.3.1 Limits of Transmit Power Measurement

Operation Band	EUT Category		Limit
U-NII-1		Outdoor Access Point	1 Watt (30 dBm) (Max. e.i.r.p $\leq$ 125mW(21 dBm) at any elevation angle above 30 degrees as measured from the horizon)
		Fixed point-to-point Access Point	1 Watt (30 dBm)
		Indoor Access Point	1 Watt (30 dBm)
	√	Client device	250mW (24 dBm)
U-NII-2A	---		250mW (24 dBm) or 11 dBm+10 log B*
U-NII-2C	---		250mW (24 dBm) or 11 dBm+10 log B*
U-NII-3	√		1 Watt (30 dBm)

\*B is the 26 dB emission bandwidth in megahertz

Per KDB 662911 Method of conducted output power measurement on IEEE 802.11 devices,

Array Gain = 0 dB (i.e., no array gain) for  $N_{ANT} \leq 4$ ;

Array Gain = 0 dB (i.e., no array gain) for channel widths  $\geq 40$  MHz for any  $N_{ANT}$ ;

Array Gain =  $5 \log(N_{ANT}/N_{SS})$  dB or 3 dB, whichever is less for 20-MHz channel widths with  $N_{ANT} \geq 5$ .

For power measurements on all other devices: Array Gain =  $10 \log(N_{ANT}/N_{SS})$  dB.

#### 4.3.2 Test Setup FOR POWER OUTPUT MEASUREMENT

##### ◆ Power Meter Measurement

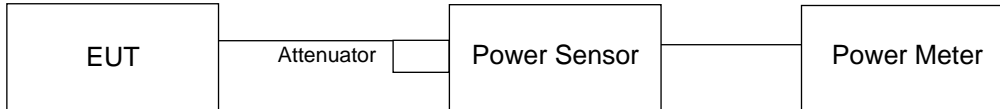

##### ◆ Spectrum Measurement

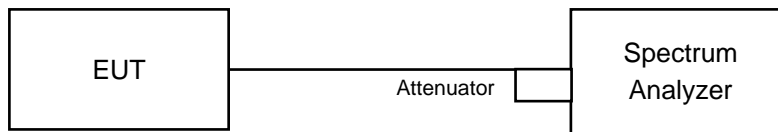

#### FOR 26dB OCCUPIED BANDWIDTH

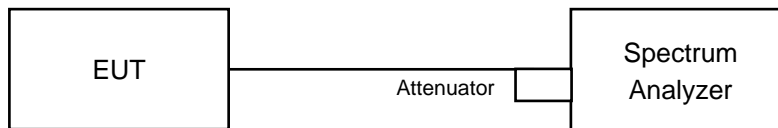

#### 4.3.3 Test Instruments

Refer to section 4.1.2 to get information of above instrument.

#### 4.3.4 Test Procedure

##### For Average Power Measurement

##### For 802.11a, 802.11n (HT20), 802.11n (HT40)

Method PM is used to perform output power measurement, trigger and gating function of wide band power meter is enabled to measure max output power of TX on burst and set the detector to AVERAGE. Duty factor is not added to measured value.

##### For 802.11ac (VHT80)

- 1) Set span to encompass the entire 26 dB EBW (or, alternatively, the entire 99% occupied bandwidth) of the signal.
- 2) Set sweep trigger to "free run".
- 3) Set RBW = 1 MHz.
- 4) Set VBW ≥ 3 MHz
- 5) Number of points in sweep ≥ 2 Span / RBW.
- 6) Sweep time ≤ (number of points in sweep) \* T
- 7) Using emission bandwidth to determine the frequency span for integration the channel bandwidth.
- 8) Detector = RMS.
- 9) Trace mode = max hold.
- 10) Allow max hold to run for at least 60 seconds, or longer as needed to allow the trace to stabilize.

#### ◆ Power Meter Measurement

Method PM is used to perform output power measurement, trigger and gating function of wide band power meter is enabled to measure max output power of TX on burst. Duty factor is not added to measured value.

#### ◆ Spectrum Measurement

Follow FCC KDB 789033 UNII test procedure:

Method SA-1

1. Set span to encompass the entire emission bandwidth (EBW) of the signal.
2. Set RBW = 1MHz.
3. Set the VBW  $\geq 3 \times$  RBW.
4. Number of points in sweep  $\geq 2$  Span / RBW.
5. Sweep time = auto.
6. Set trigger to free run (duty cycle  $\geq 98$  percent)
7. Detector = RMS.
8. Trace average at least 100 traces in power averaging mode
9. Compute power by integrating the spectrum across the 26 dB EBW of the signal.

Follow FCC KDB 789033 UNII test procedure:

Method SA-2

1. Set span to encompass the emission bandwidth (EBW) of the signal.
2. Set RBW = 1MHz.
3. Set the VBW  $\geq 3 \times$  RBW.
4. Number of points in sweep  $\geq 2$  Span / RBW.
5. Sweep time = auto.
6. Detector = RMS.
7. Trace average at least 100 traces in power averaging mode
8. Compute power by integrating the spectrum across the 26 dB EBW of the signal.
9. Duty factor need added to measured value (duty cycle  $< 98$  percent).

#### FOR 26dB OCCUPIED BANDWIDTH

1. Set RBW = approximately 1% of the emission bandwidth.
2. Set the VBW  $>$  RBW.
3. Detector = Peak.
4. Trace mode = max hold.
5. Measure the maximum width of the emission that is 26 dB down from the peak of the emission. Compare this with the RBW setting of the analyzer. Readjust RBW and repeat measurement as needed until the RBW/EBW ratio is approximately 1%.

#### 4.3.5 Deviation from Test Standard

No deviation.

#### 4.3.6 EUT Operating Condition

The software provided by client to enable the EUT under transmission condition continuously at lowest, middle and highest channel frequencies individually.



#### 4.3.7 Test Results

##### Output Power measurement result for UNII-1 Band

Type	Test mode	Freq (MHz)	CH	Conducted Power (dBm)	Limit (dBm)	Result
Output Power	802.11a	5180	Low	6.230	24	Pass
		5200	Mid	5.285	24	Pass
		5240	High	5.958	24	Pass
	802.11n-HT20	5180	Low	8.032	24	Pass
		5200	Mid	7.072	24	Pass
		5240	High	5.780	24	Pass
	802.11n-HT40	5190	Low	6.042	24	Pass
		5230	High	4.715	24	Pass
	802.11ac-VHT80	5210	Low	4.864	24	Pass

##### Output Power measurement result for UNII-3 Band

Type	Test mode	Freq (MHz)	CH	Conducted Power (dBm)	Limit (dBm)	Result
Output Power	802.11a	5745	Low	3.384	30	Pass
		5785	Mid	4.433	30	Pass
		5825	High	4.882	30	Pass
	802.11n-HT20	5745	Low	3.573	30	Pass
		5785	Mid	4.450	30	Pass
		5825	High	4.755	30	Pass
	802.11n-HT40	5755	Low	3.336	30	Pass
		5795	High	4.138	30	Pass
	802.11ac-VHT80	5775	Low	4.088	30	Pass

## 4.4 26dB Bandwidth & 6dB Bandwidth Measurement

### 4.4.1 Limits of 6 dB Bandwidth Measurement

The minimum of 6 dB Bandwidth Measurement is 0.5 MHz.

### 4.4.2 Test Setup

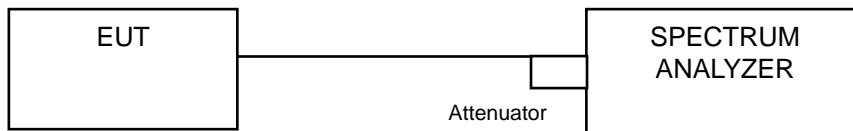

### 4.4.3 Test Instruments

Refer to section 4.1.2 to get information of above instrument.

### 4.4.4 Test Procedure

26dB Emission bandwidth measurement procedure (Other than 5.725-5.85 GHz)

- Allow the trace to stabilize.
- Use the spectrum analyzer built-in measurement function to determine the 26dB BW.  
Set RBW = around 1% of emission bandwidth  
Set VBW > RBW  
Detector = Peak  
Trace mode = max hold
- Capture the plot.
- Repeat above steps for different test channel and other modulation type.

6 dB Minimum emission bandwidth measurement procedure

- Allow the trace to stabilize.
- Use the spectrum analyzer built-in measurement function to determine the 6dB BW.  
Set RBW = 100 KHz  
Set VBW  $\geq 3 \times$  RBW  
Detector = Peak  
Trace mode = max hold  
Sweep = auto couple
- Capture the plot.
- Repeat above steps for different test channel and other modulation type.

#### 4.4.5 Test Results

##### 26dB Bandwidth measurement result for UNII-1 Band

Type	Test mode	Freq (MHz)	CH	Result (MHz)
26dB BW	802.11a	5180	Low	21.236
		5200	Mid	20.998
		5240	High	20.832
	802.11n-HT20	5180	Low	21.036
		5200	Mid	20.751
		5240	High	21.745
	802.11n-HT40	5190	Low	38.930
		5230	High	49.031
	802.11ac-VHT80	5210	Low	91.017

##### 6dB Bandwidth measurement result for UNII-3 Band

Type	Test mode	Freq (MHz)	CH	Result (MHz)	Limit (MHz)	Result
6dB BW	802.11a	5745	Low	16.058	0.5	Pass
		5785	Mid	16.332	0.5	Pass
		5825	High	16.321	0.5	Pass
	802.11n-HT20	5745	Low	17.576	0.5	Pass
		5785	Mid	17.579	0.5	Pass
		5825	High	17.535	0.5	Pass
	802.11n-HT40	5755	Low	35.888	0.5	Pass
		5795	High	35.674	0.5	Pass
	802.11ac-VHT80	5775	Low	72.682	0.5	Pass

Occupied Bandwidth Test Plots  
UNII-1 Band

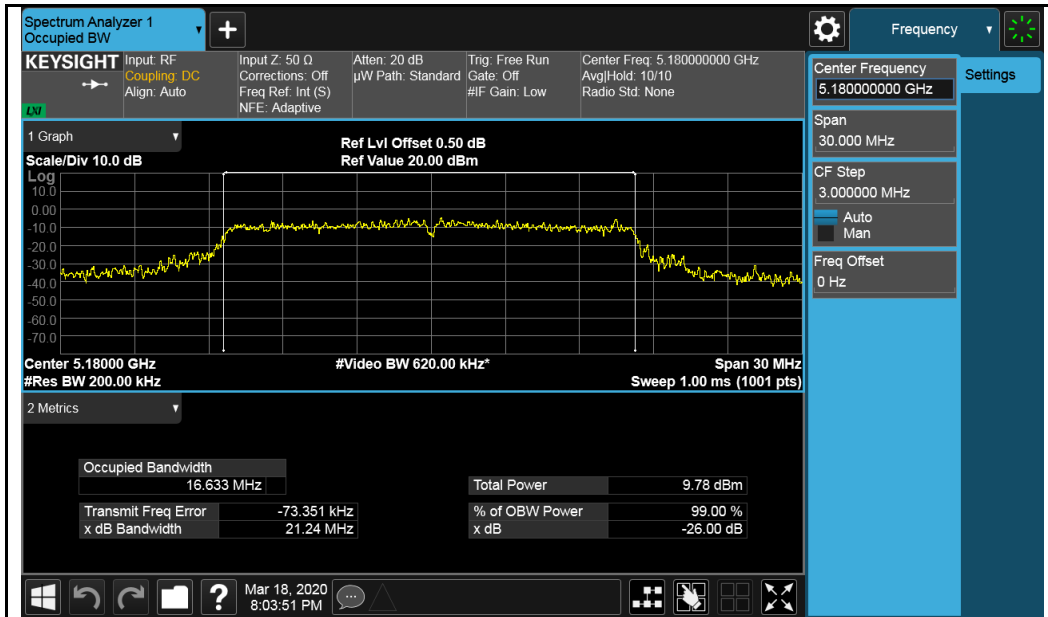

802.11a-5180MHz

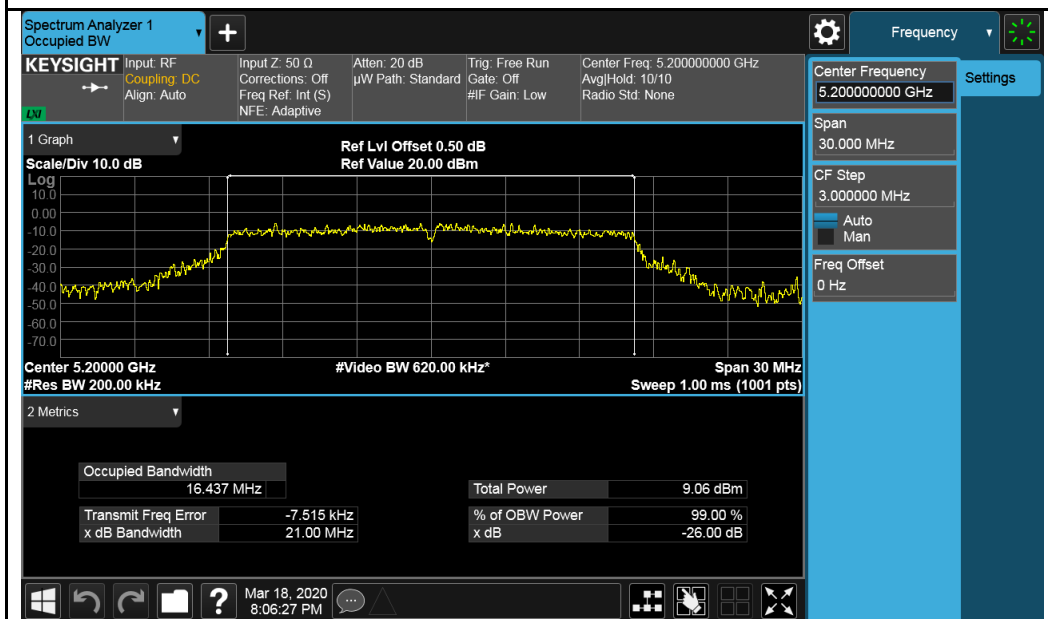

802.11a-5200MHz

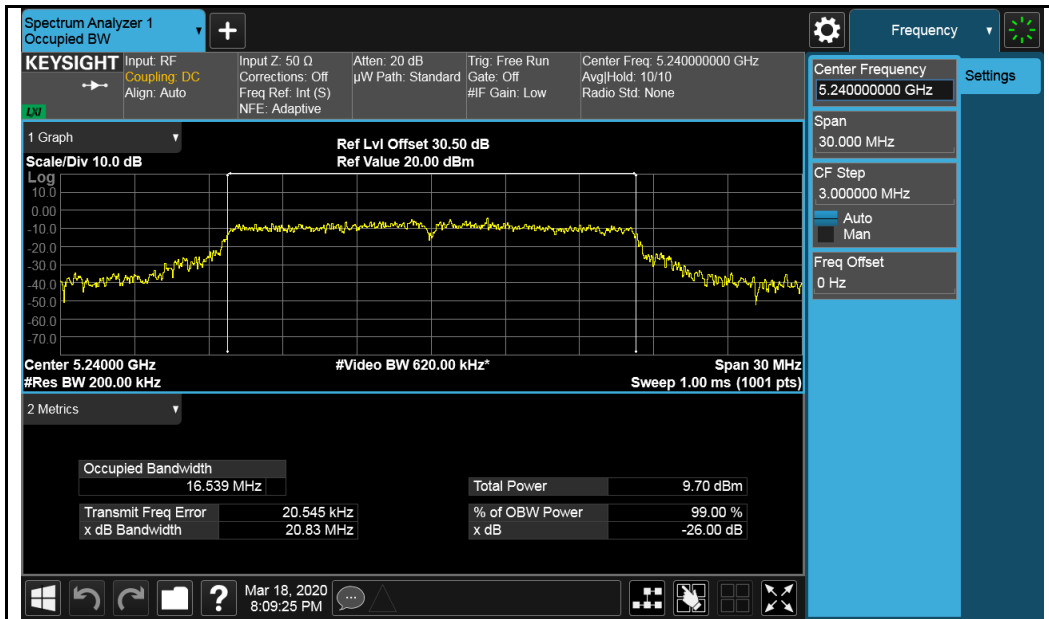

802.11a-5240MHz

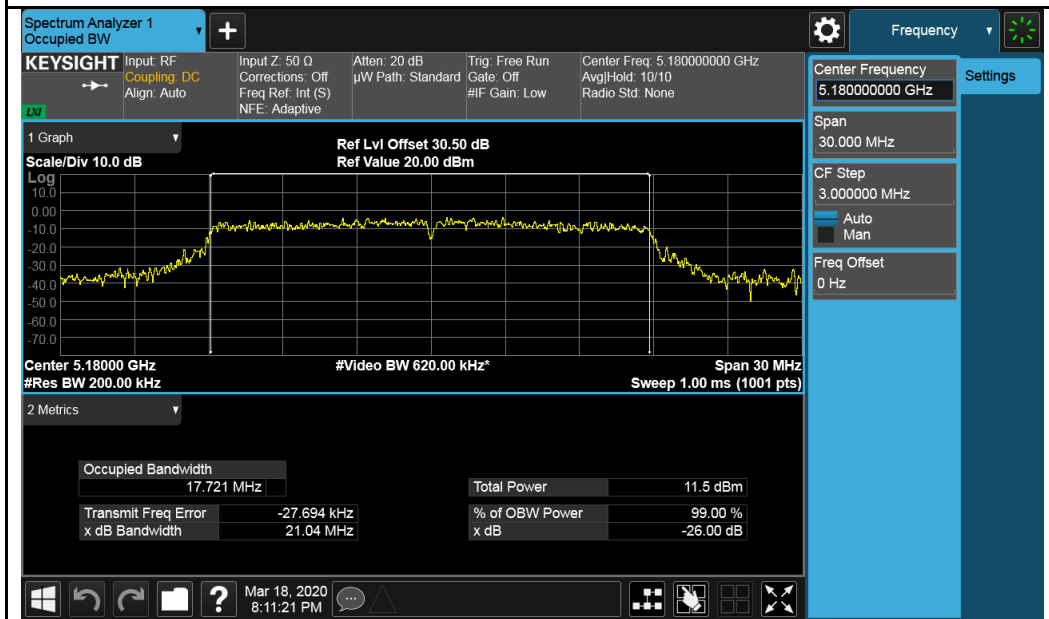

802.11n-HT20-5180MHz

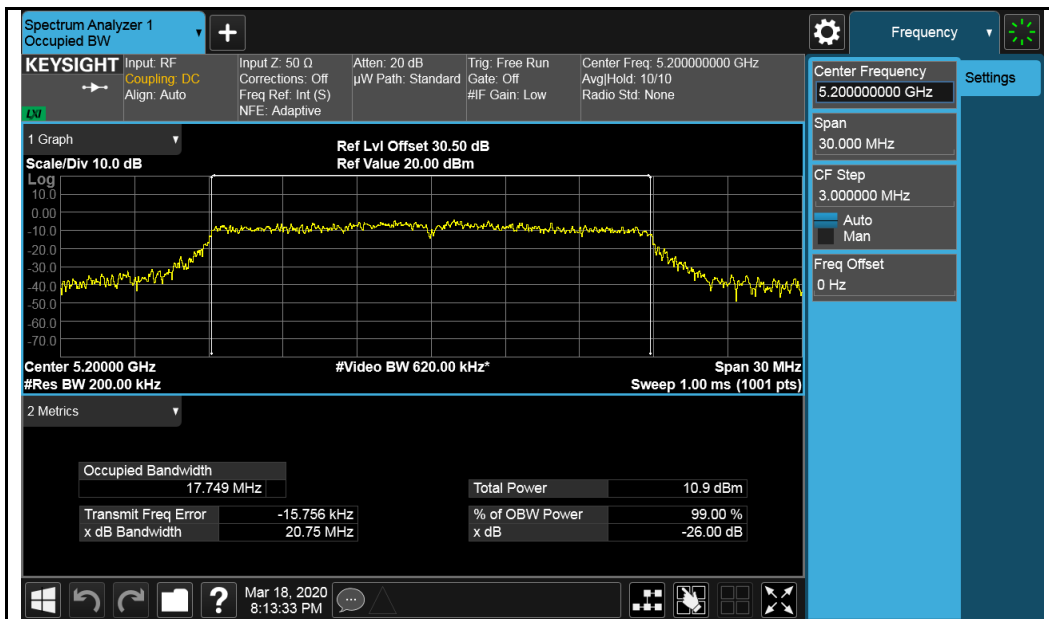

802.11n-HT20-5200MHz

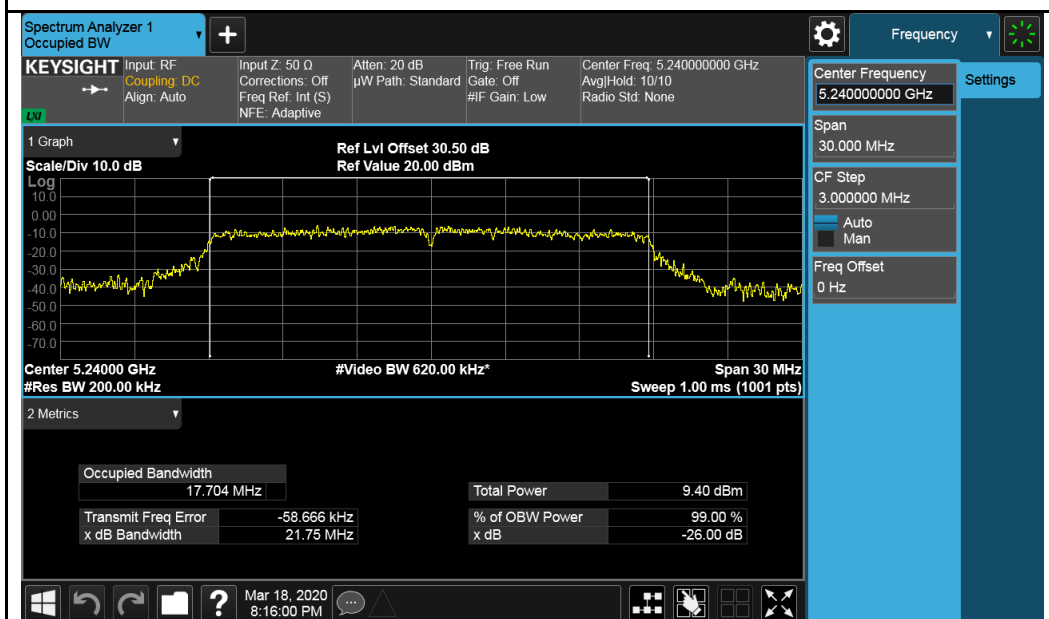

802.11n-HT20-5240MHz

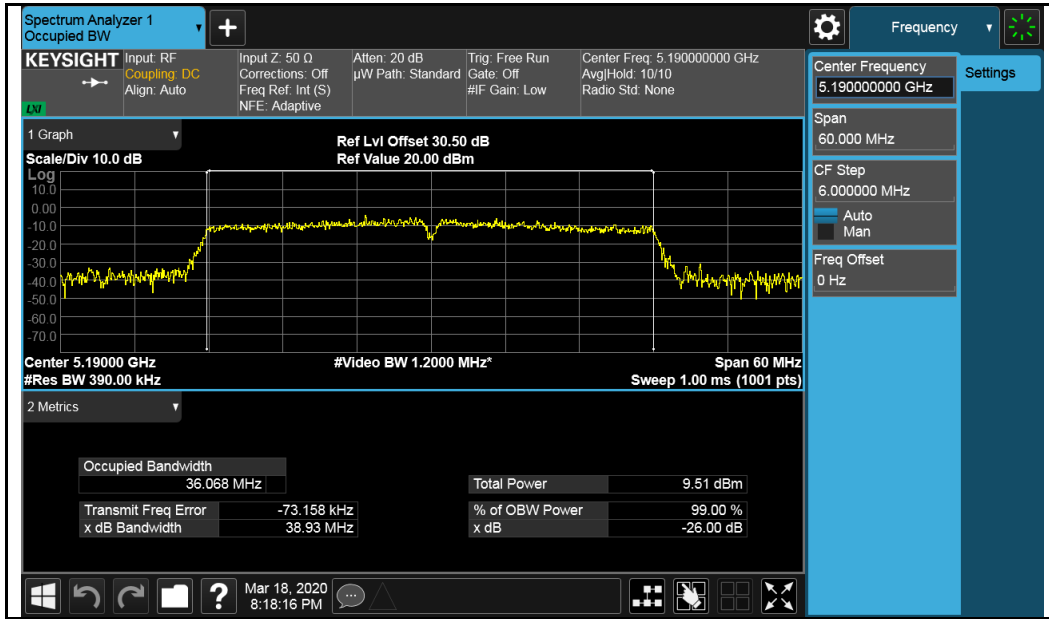

802.11n-HT40-5190MHz

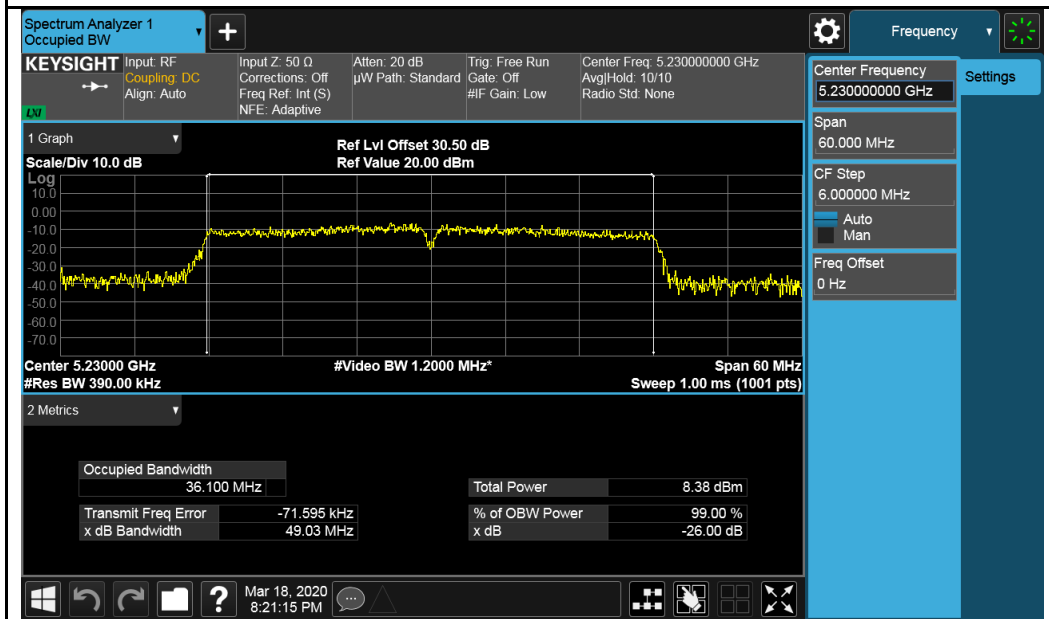

802.11n-HT40-5230MHz

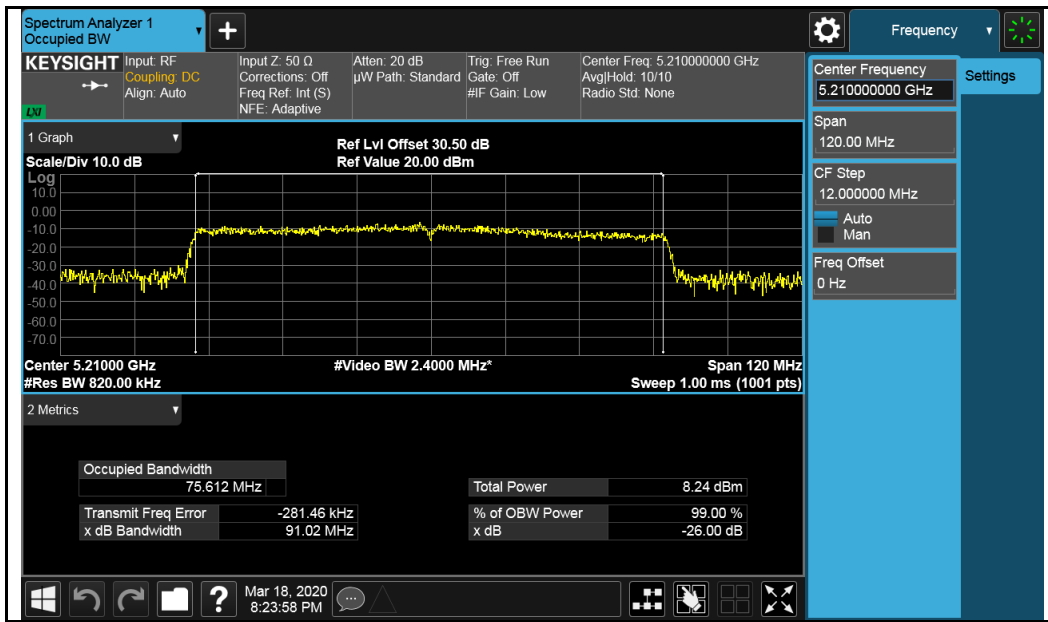

802.11ac-VHT80-5210MHz



6dB Bandwidth Test Plots  
U-NII-3 Band:

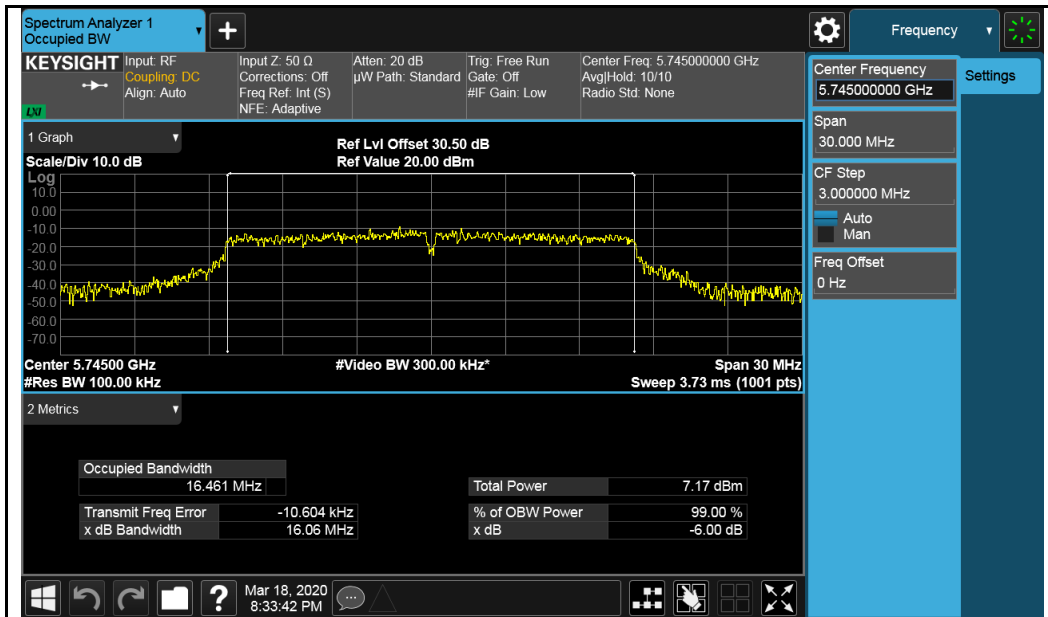

802.11a-5745MHz

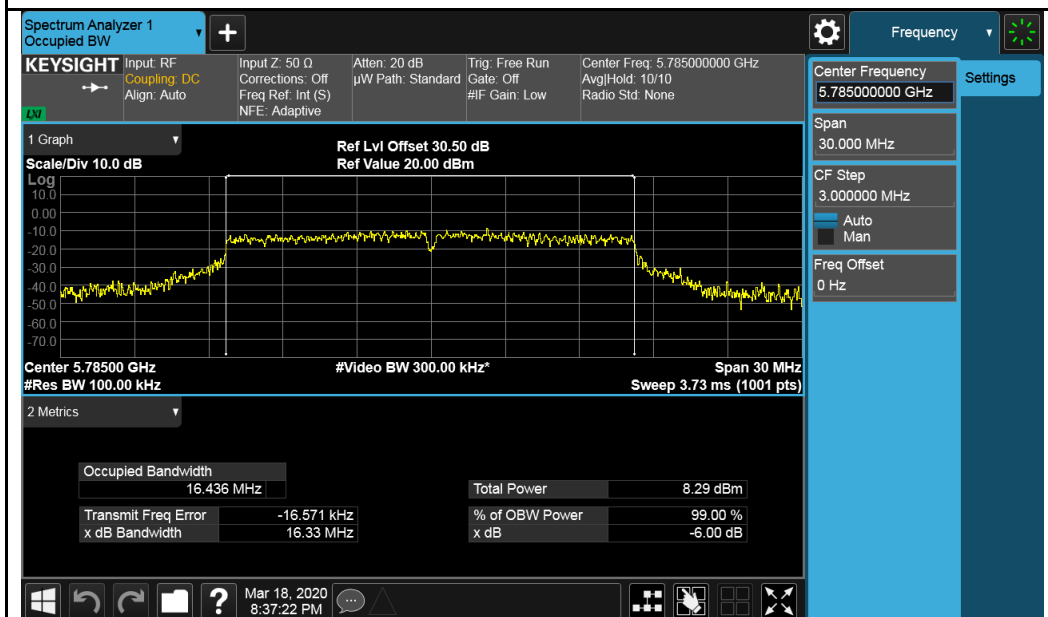

802.11a-5785MHz

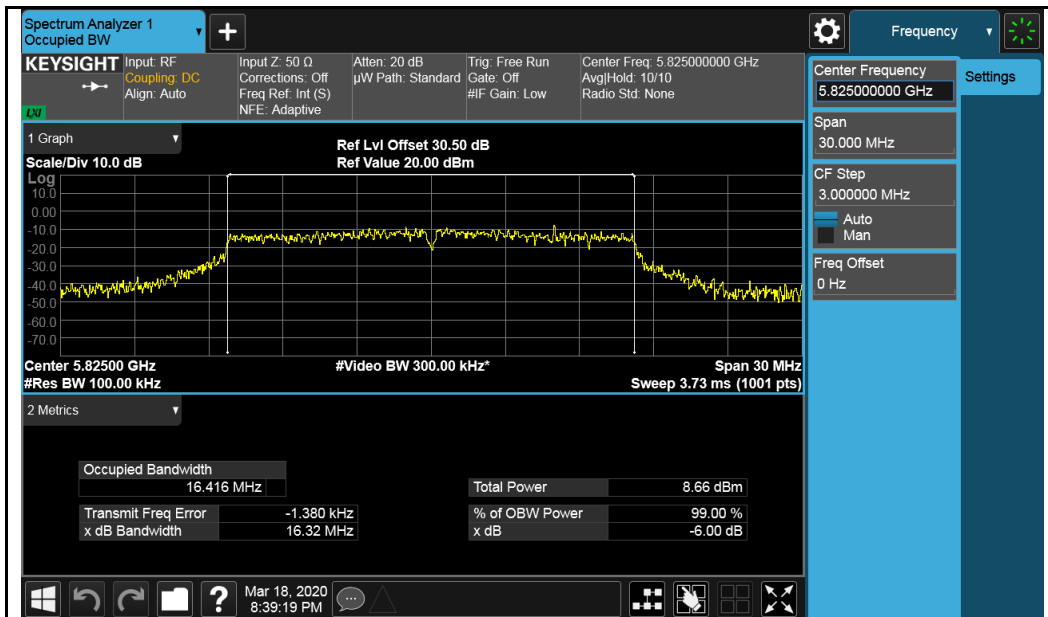

802.11a-5825MHz

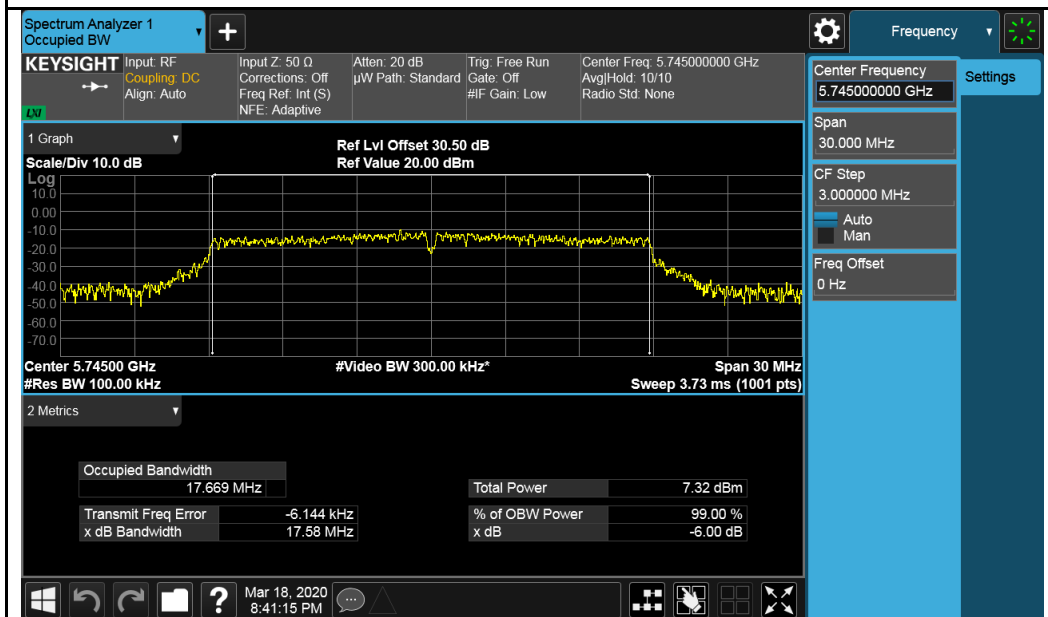

802.11n-HT20-5745MHz

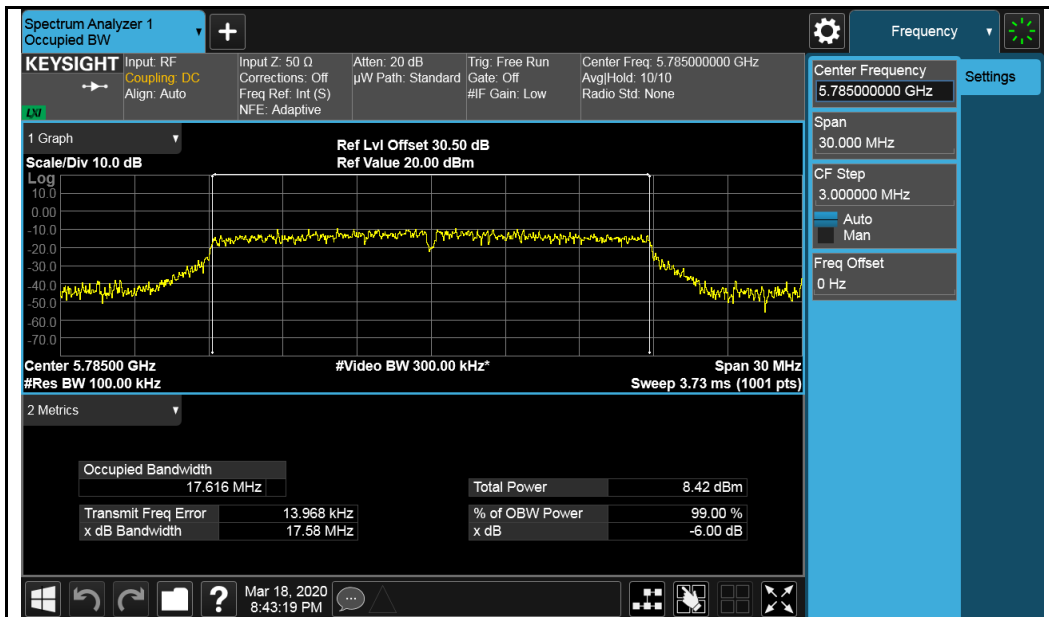

802.11n-HT20-5785MHz

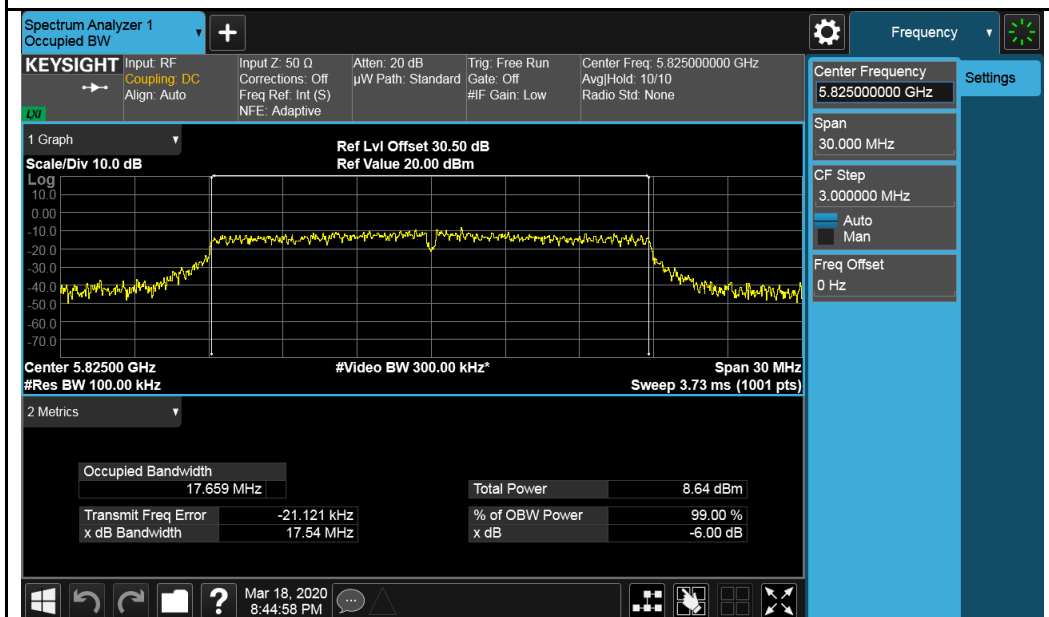

802.11n-HT20-5825MHz

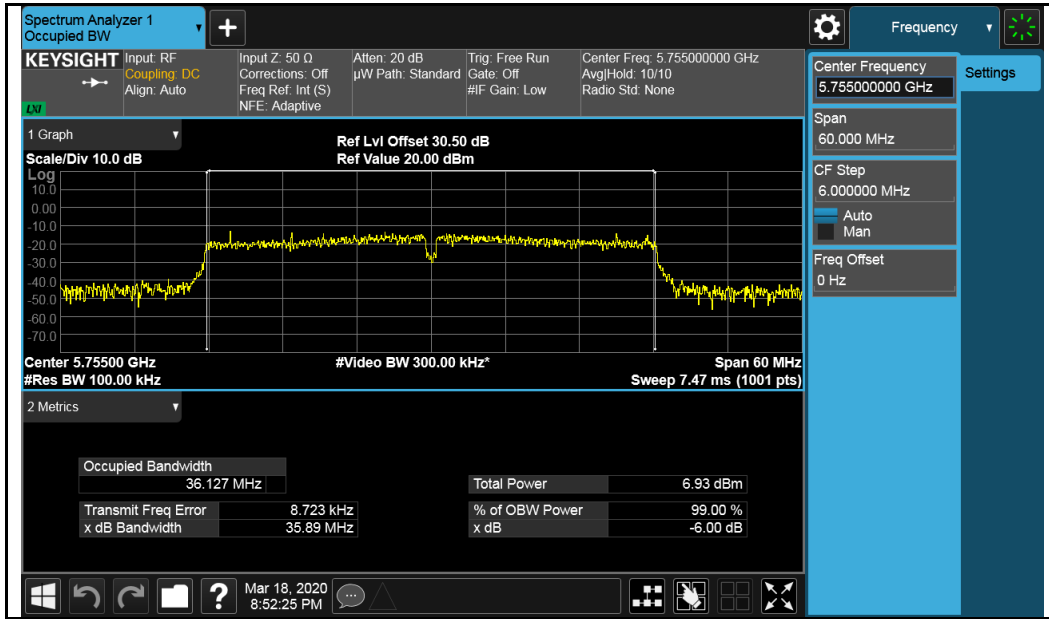

802.11n-HT40-5755MHz

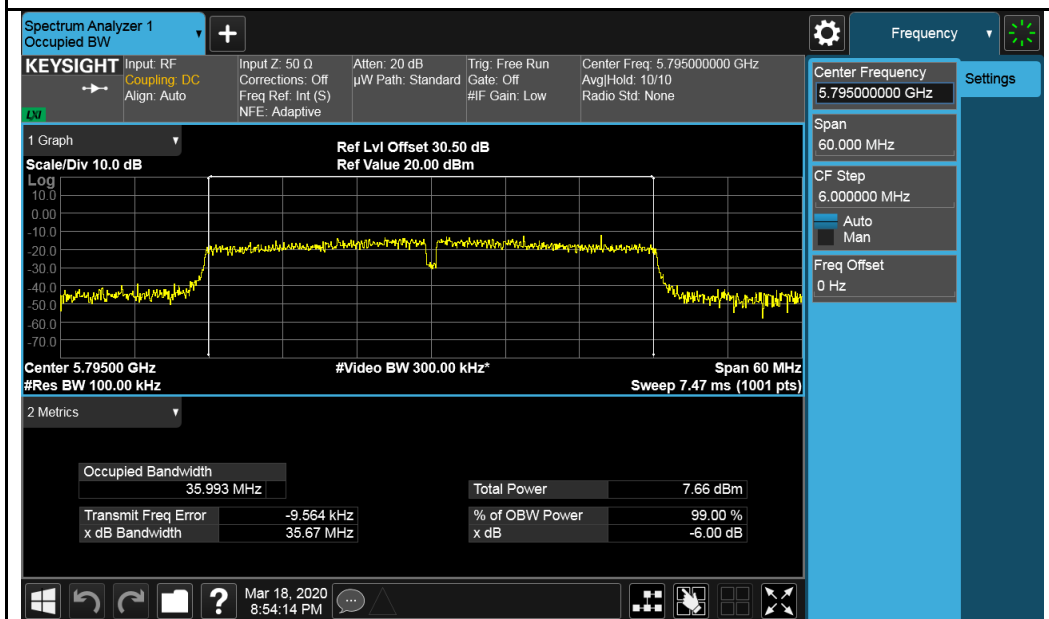

802.11n-HT40-5795MHz

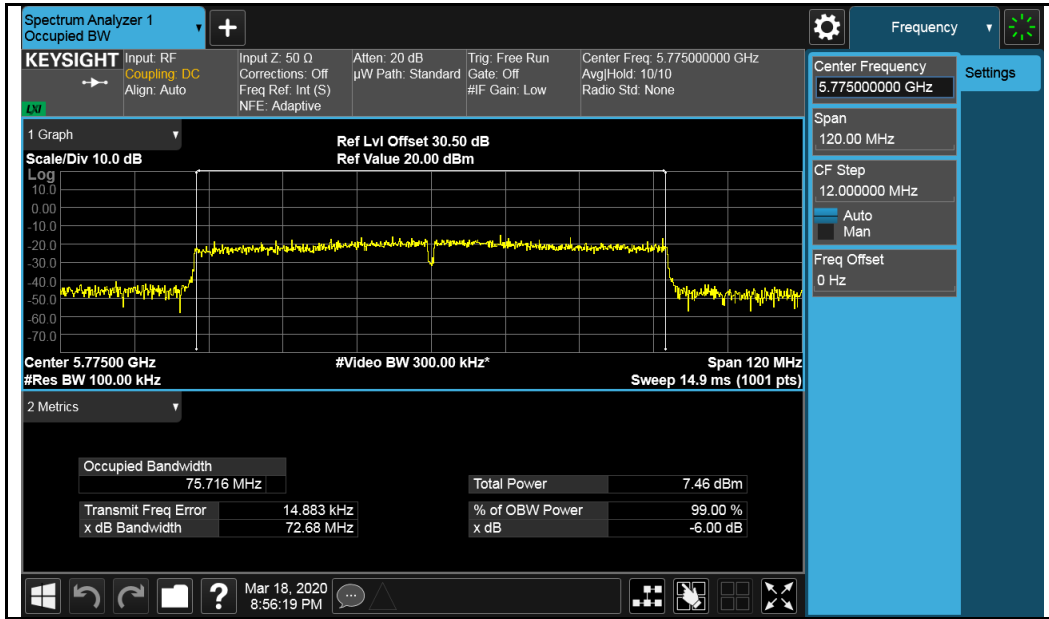

802.11ac-VHT80-5775MHz

## 4.5 Peak Power Spectral Density Measurement

### 4.5.1 Limits of Peak Power Spectral Density Measurement

Operation Band	EUT Category		Limit
U-NII-1		Outdoor Access Point	17dBm/ MHz
		Fixed point-to-point Access Point	
		Indoor Access Point	
	√	Client device	11dBm/ MHz
U-NII-2A	---		11dBm/ MHz
U-NII-2C	---		11dBm/ MHz
U-NII-3	√		30dBm/ 500kHz

### 4.5.2 Test Setup

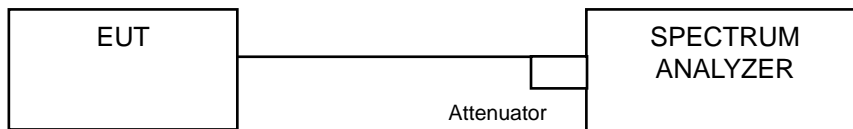

### 4.5.3 Test Instruments

Refer to section 4.1.2 to get information of above instrument.

### 4.5.4 Test Procedure

#### For U-NII-1, U-NII-2A, U-NII-2C band:

Using method SA-1

1. Set span to encompass the entire emission bandwidth (EBW) of the signal.
2. Set RBW = 1 MHz, Set VBW ≥ 3 MHz, Detector = RMS
3. Sweep time = auto, trigger set to "free run".
4. Trace average at least 100 traces in power averaging mode.
5. Record the max value

#### For U-NII-3:

1. Set span to encompass the entire emission bandwidth (EBW) of the signal.
2. Set RBW = 300 kHz, Set VBW ≥ 1 MHz, Detector = RMS
3. Use the peak marker function to determine the maximum power level in any 300 kHz band segment within the fundamental EBW.
4. Scale the observed power level to an equivalent value in 500 kHz by adjusting (reducing) the measured power by a bandwidth correction factor (BWCF) where  $BWCF = 10\log(500\text{ kHz}/300\text{ kHz})$
5. Sweep time = auto, trigger set to "free run".
6. Trace average at least 100 traces in power averaging mode.
7. Record the max value

### 4.5.5 Deviation from Test Standard

No deviation.

### 4.5.6 EUT Operating Condition

Same as Item 4.3.6.

#### 4.5.7 Test Results

##### PSD measurement result for UNII-1 Band

Type	Test mode	Freq (MHz)	CH	Conducted PSD (dBm/MHz)	Limit (dBm/MHz)	Result
Output Power	802.11a	5180	Low	-4.836	11	Pass
		5200	Mid	-5.649	11	Pass
		5240	High	-5.031	11	Pass
	802.11n-HT20	5180	Low	-3.266	11	Pass
		5200	Mid	-3.895	11	Pass
		5240	High	-5.357	11	Pass
	802.11n-HT40	5190	Low	-7.676	11	Pass
		5230	High	-9.183	11	Pass
	802.11ac-VHT80	5210	Low	-12.361	11	Pass

##### PSD measurement result for UNII-3 Band

Type	Test mode	Freq (MHz)	CH	Conducted PSD (dBm/MHz)	Correction factor (dB)	Correction PSD (dBm/MHz)	Limit (dBm/MHz)	Result
Output Power	802.11a	5745	Low	-14.573	6.99	-7.583	30	Pass
		5785	Mid	-13.824	6.99	-6.834	30	Pass
		5825	High	-13.096	6.99	-6.106	30	Pass
	802.11n-HT20	5745	Low	-14.785	6.99	-7.795	30	Pass
		5785	Mid	-13.578	6.99	-6.588	30	Pass
		5825	High	-13.593	6.99	-6.603	30	Pass
	802.11n-HT40	5755	Low	-17.829	6.99	-10.839	30	Pass
		5795	High	-16.871	6.99	-9.881	30	Pass
	802.11ac-VHT80	5775	Low	-19.551	6.99	-12.561	30	Pass
NOTE	BW correction factor = $10 \log(500\text{kHz}/\text{RBW})$ , RBW was set to 100kHz during test.							

Test Plot for UNII-1 Band:



802.11a-5180MHz



802.11a-5200MHz



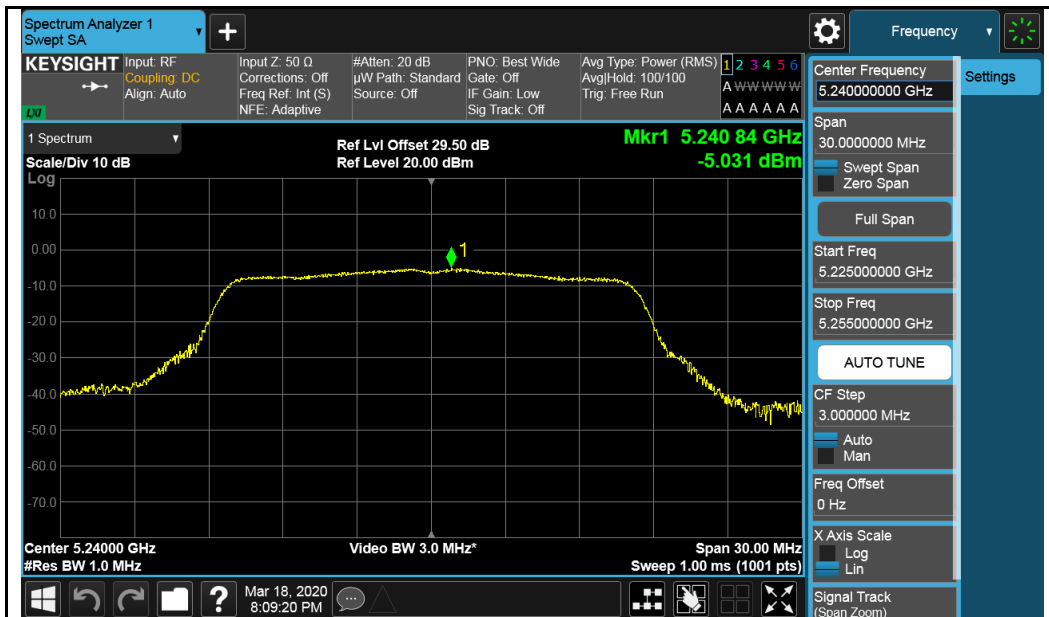

802.11a-5240MHz

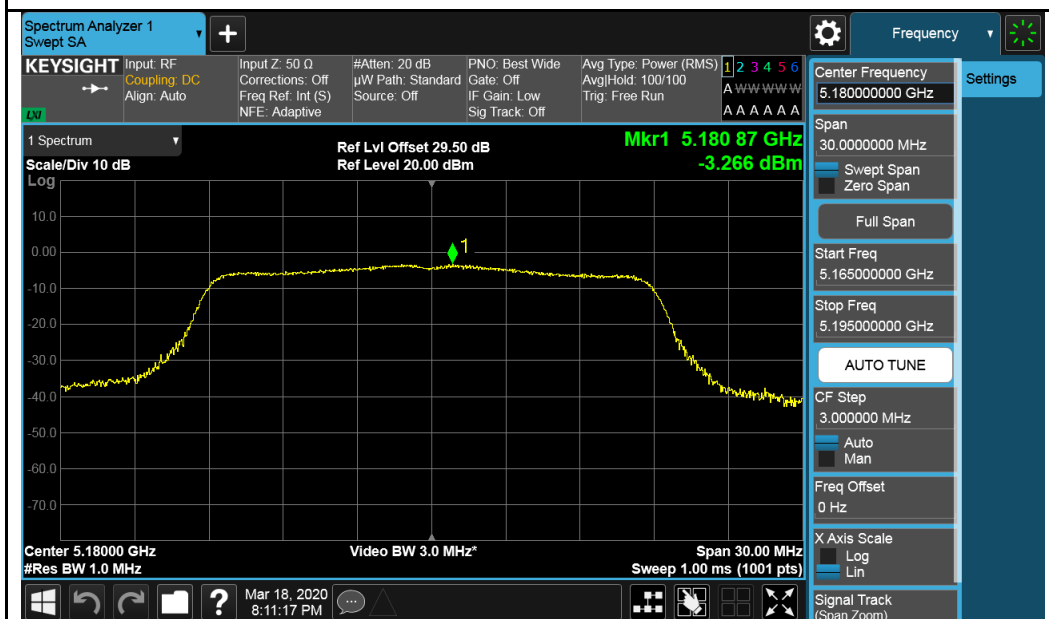

802.11n-HT20-5180MHz



802.11n-HT20-5200MHz



802.11n-HT20-5240MHz

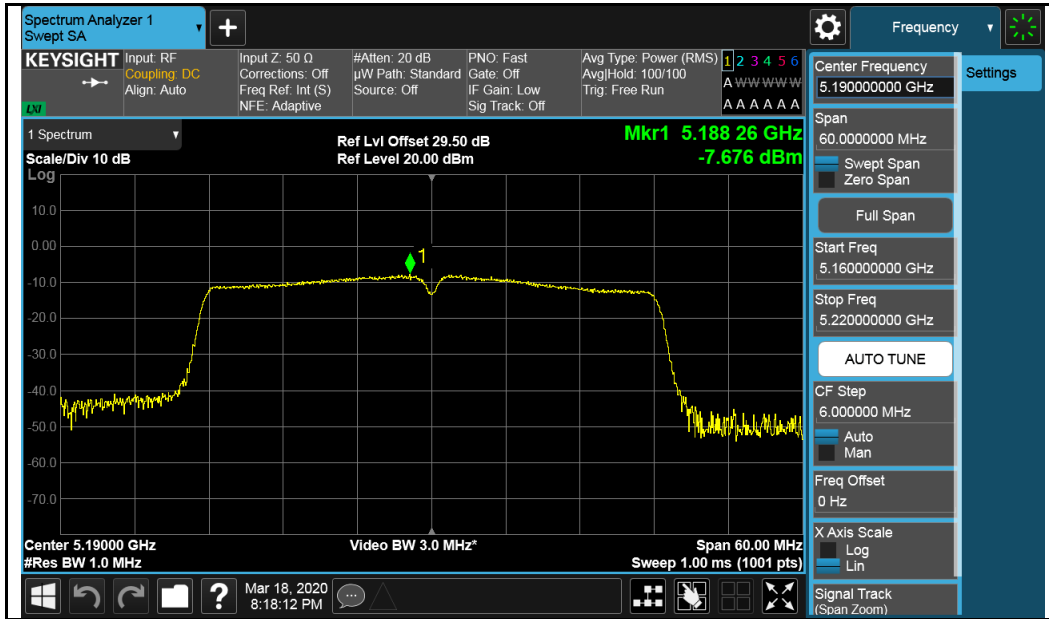

802.11n-HT40-5190MHz

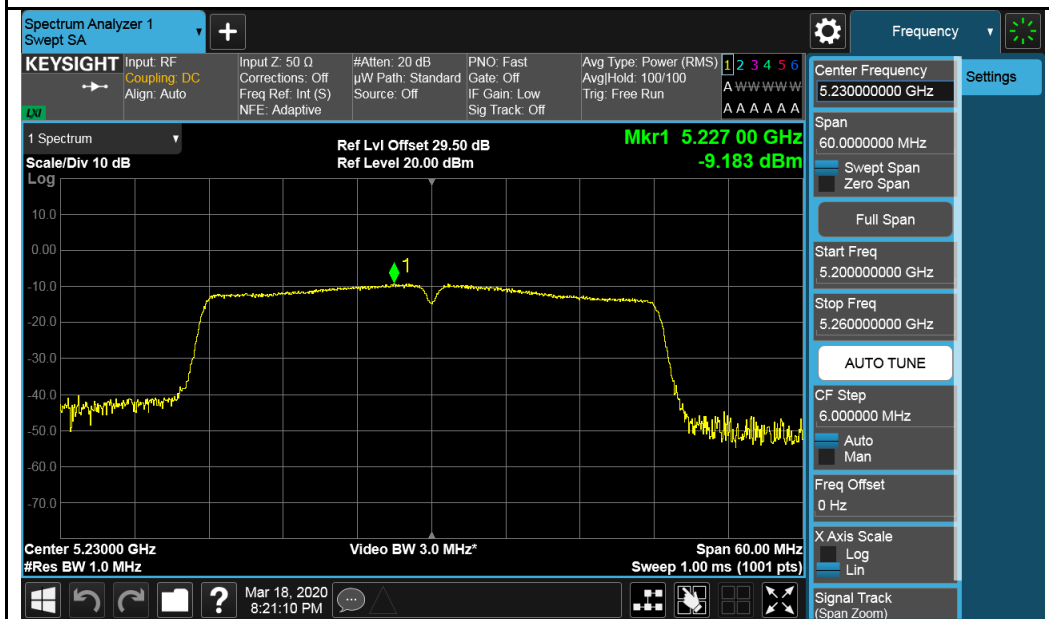

802.11n-HT40-5230MHz

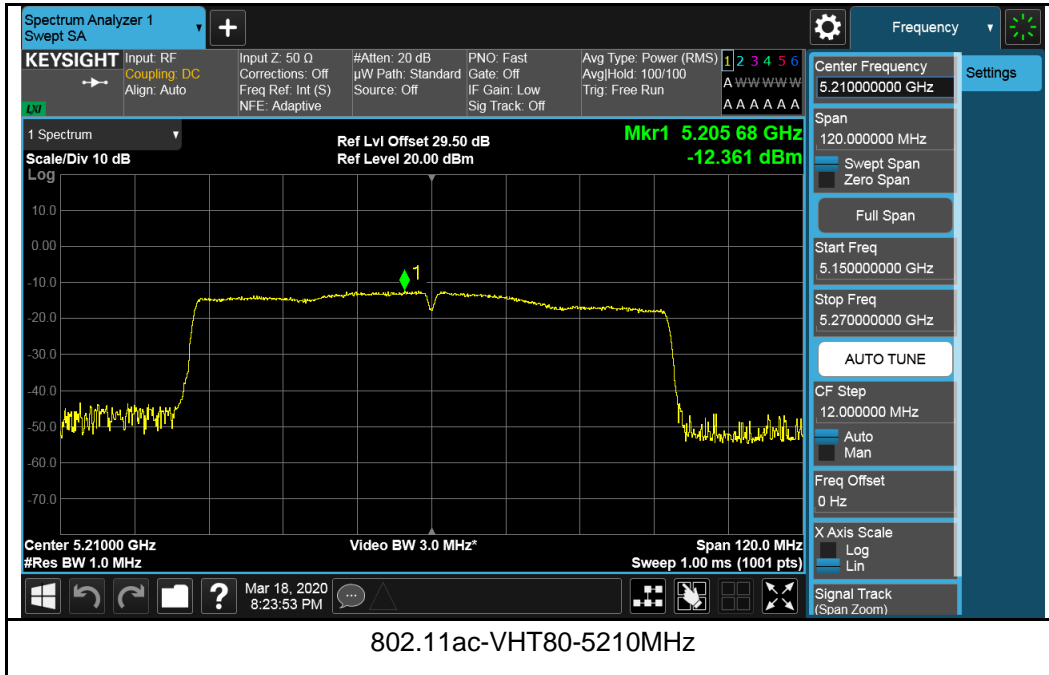

Test Plot for UNII-3 Band:

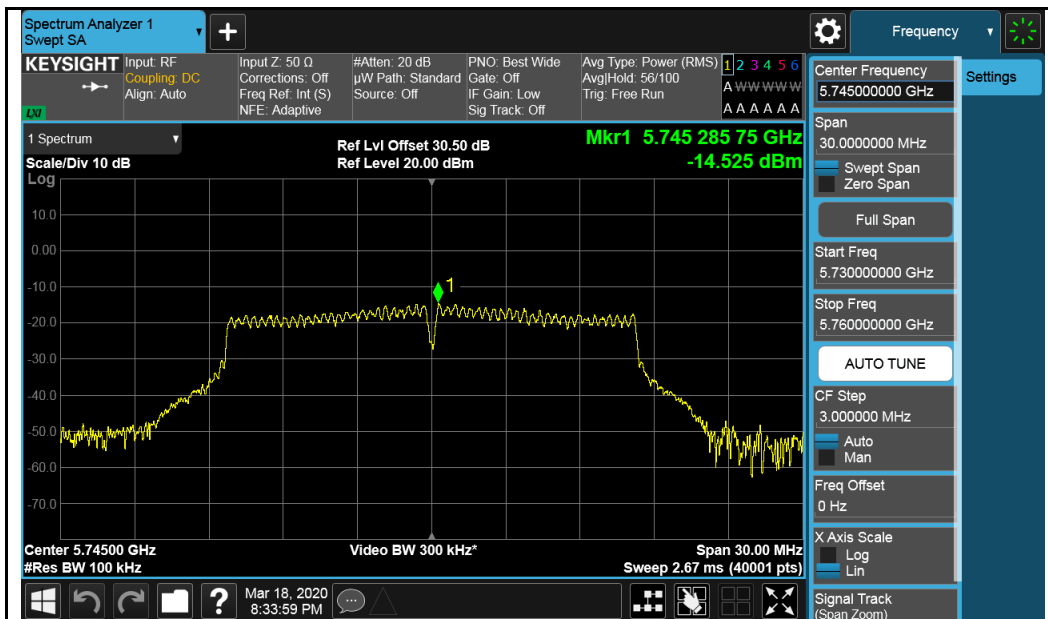

802.11a-5745MHz

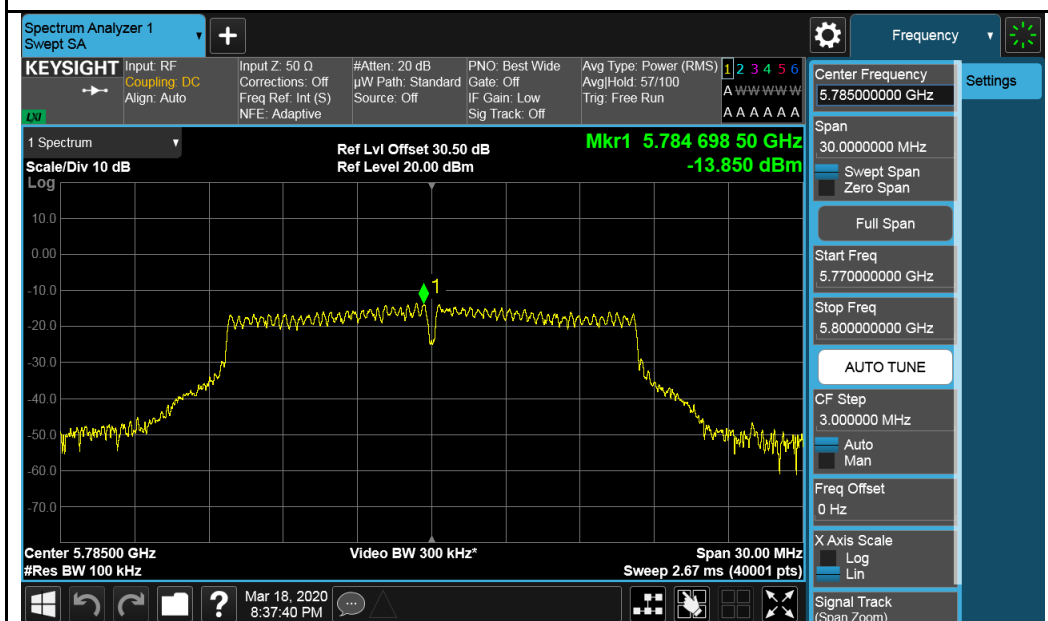

802.11a-5785MHz

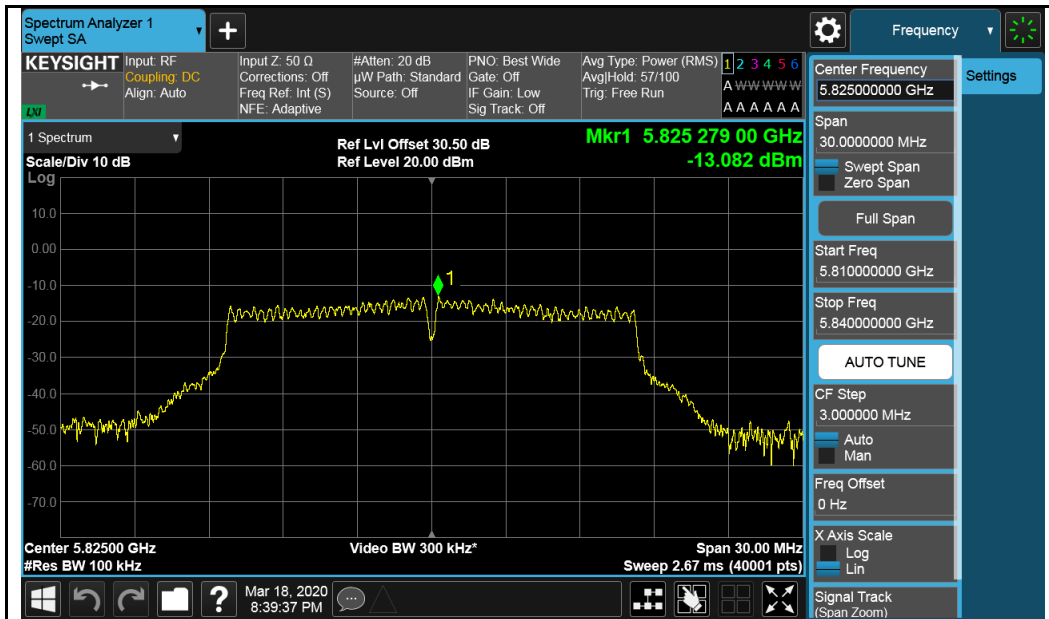

802.11a-5825MHz

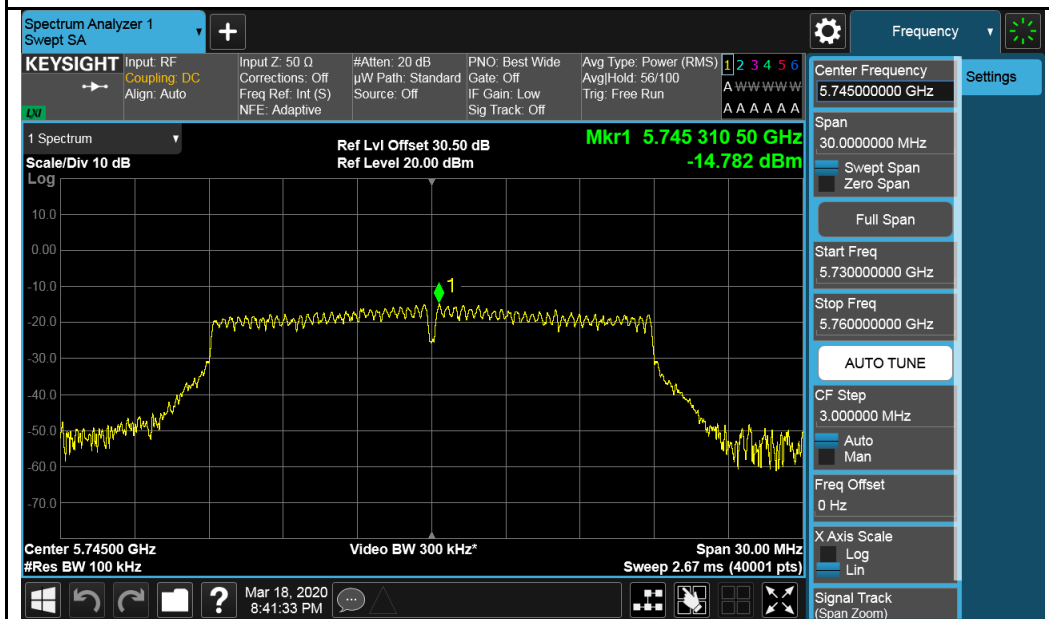

802.11n-HT20-5745MHz

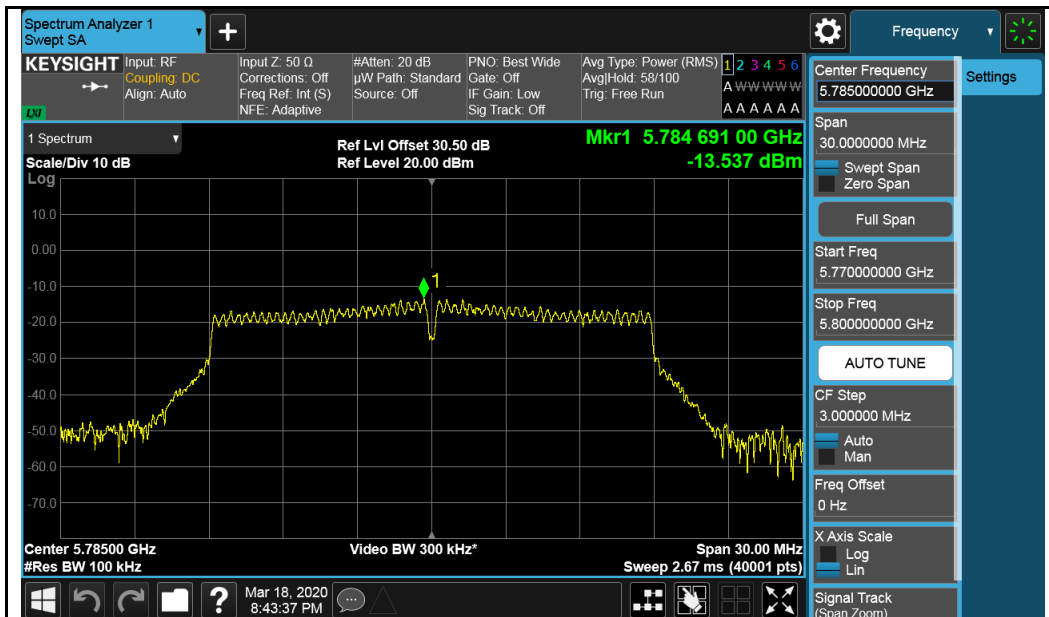

802.11n-HT20-5785MHz

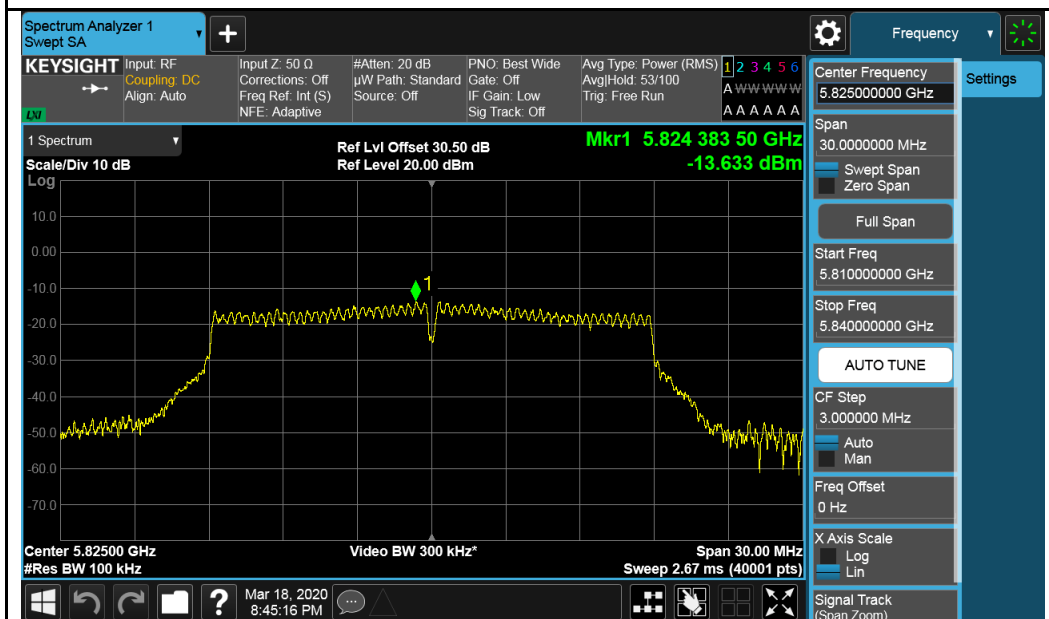

802.11n-HT20-5825MHz

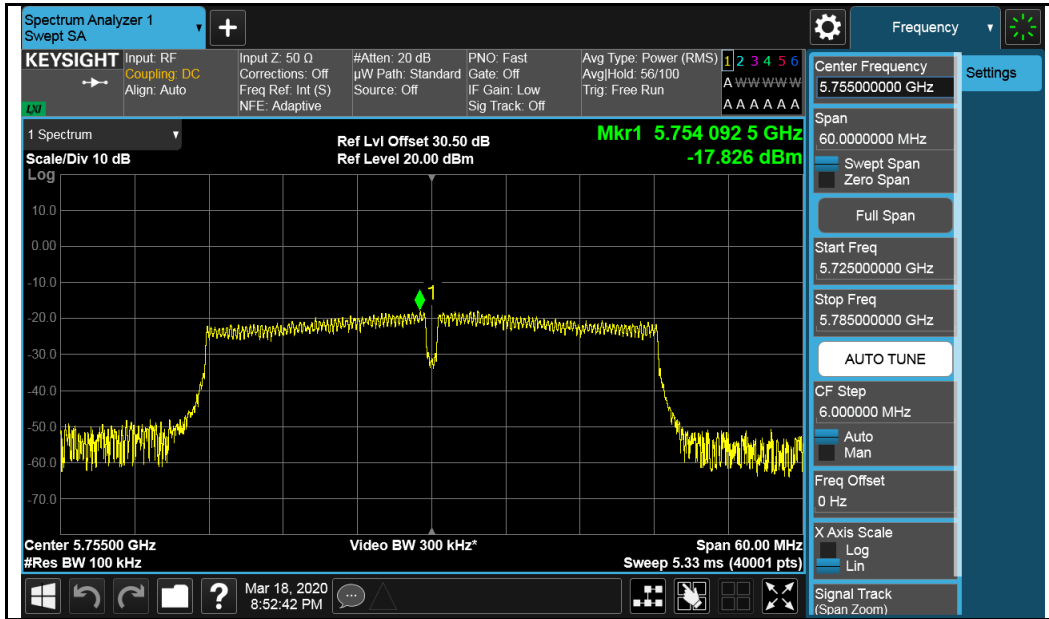

802.11n-HT40-5755MHz

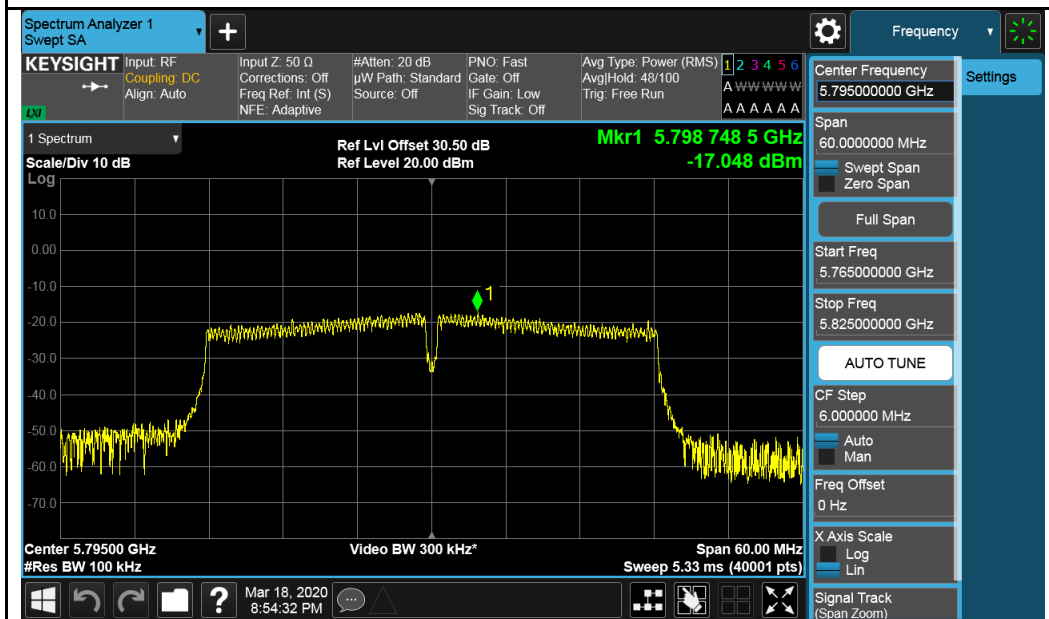

802.11n-HT40-5795MHz



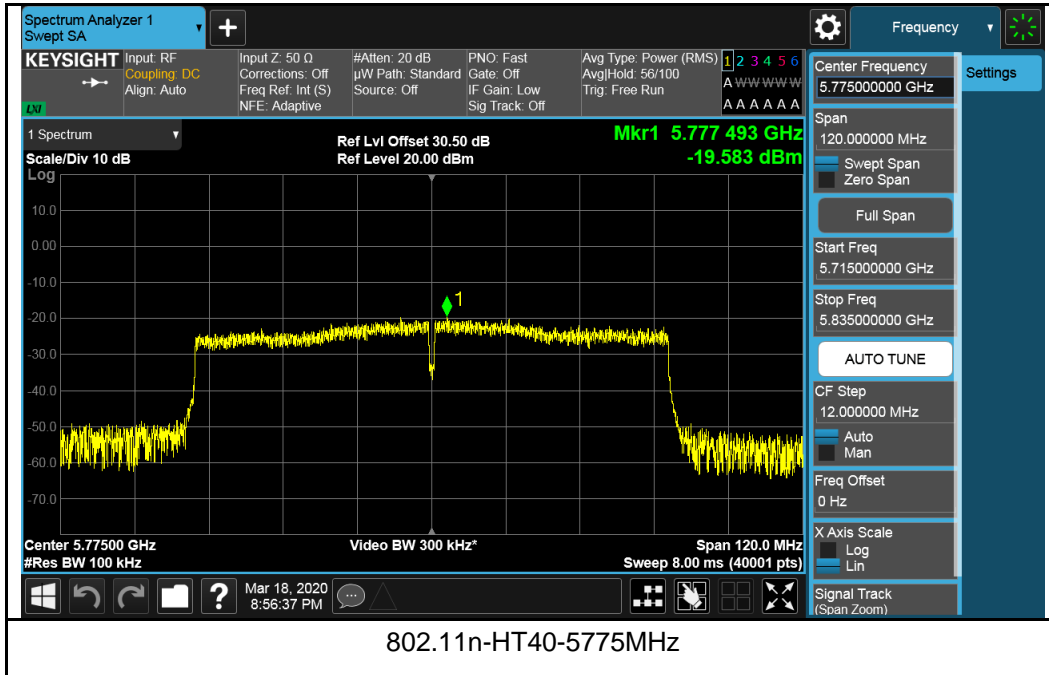

## 4.6 Frequency Stability Measurement

### 4.6.1 Limits of Frequency Stability Measurement

The frequency of the carrier signal shall be maintained within band of operation.

### 4.6.2 Test Setup

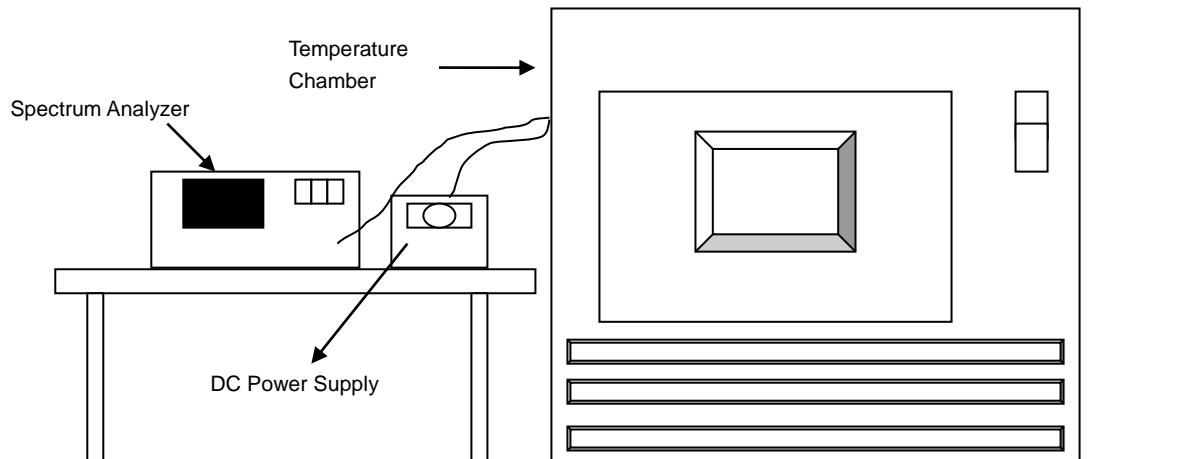

### 4.6.3 Test Instruments

Refer to section 4.1.2 to get information of above instrument.

### 4.6.4 Test Procedure

- The EUT was placed inside the environmental test chamber and powered by nominal DC voltage.
- Turn the EUT on and couple its output to a spectrum analyzer.
- Turn the EUT off and set the chamber to the highest temperature specified.
- Allow sufficient time (approximately 30 min) for the temperature of the chamber to stabilize, turn the EUT on and measure the operating frequency after 2, 5, and 10 Minutes.
- Repeat step (d) with the temperature chamber set to the next desired temperature until measurements down to the lowest specified temperature have been completed..
- The test chamber was allowed to stabilize at +20 degree C for a minimum of 30 Minutes. The supply voltage was then adjusted on the EUT from 85% to 115% and the frequency record.

### 4.6.5 Deviation from Test Standard

No deviation.

### 4.6.6 EUT Operating Condition

Set the EUT transmit at un-modulation mode to test frequency stability.

#### 4.6.7 Test Results

Frequency Stability Versus Temp.									
Operating Frequency: 5180 MHz									
TEMP. (°C)	Power Supply (Vdc)	0 Minute		2 Minute		5 Minute		10 Minute	
		Measured Frequency (MHz)	Pass/Fail	Measured Frequency (MHz)	Pass/Fail	Measured Frequency (MHz)	Pass/Fail	Measured Frequency (MHz)	Pass/Fail
50	12	5179.999	Pass	5180.05313	Pass	5179.99213	Pass	5179.99113	Pass
40	12	5180.004	Pass	5179.99413	Pass	5180.00313	Pass	5180.00313	Pass
30	12	5180.005	Pass	5180.00213	Pass	5180.00613	Pass	5180.00213	Pass
20	12	5179.997	Pass	5179.99313	Pass	5179.99213	Pass	5180.00113	Pass
10	12	5179.984	Pass	5179.98313	Pass	5179.99213	Pass	5179.99213	Pass
0	12	5179.999	Pass	5179.99213	Pass	5179.99113	Pass	5180.99113	Pass
-10	12	5179.995	Pass	5179.99713	Pass	5180.00313	Pass	5179.99213	Pass
-20	12	5179.998	Pass	5179.99413	Pass	5180.00613	Pass	5179.98213	Pass
-30	12	5179.991	Pass	5179.99213	Pass	5180.00313	Pass	5179.99813	Pass

Frequency Stability Versus Voltage									
Operating Frequency: 5180 MHz									
TEMP. (°C)	Power Supply (Vdc)	0 Minute		2 Minute		5 Minute		10 Minute	
		Measured Frequency (MHz)	Pass/Fail	Measured Frequency (MHz)	Pass/Fail	Measured Frequency (MHz)	Pass/Fail	Measured Frequency (MHz)	Pass/Fail
20	13.8	5180.005	Pass	5179.992	Pass	5180.004	Pass	5179.9940	Pass
	12	5179.996	Pass	5179.996	Pass	5179.992	Pass	5180.9970	Pass
	10.2	5179.983	Pass	5180.006	Pass	5179.991	Pass	5179.9950	Pass

## 5 Pictures of Test Arrangements

Please refer to the attached file (Test Setup Photo).

## Appendix – Information on the Testing Laboratories

Bureau Veritas is a global leader in testing, inspection and certification (TIC) services. We help businesses improve safety, sustainability and productivity; and our clients include the majority of leading brands in retail, manufacturing and other industries. With a presence in every major country around the world, our quality assurance and compliance solutions are vital in helping our customers enhance product quality and concept-to-consumer journeys. We also assist with increasing speed to market, profitability and brand equity throughout the supply chain. Bureau Veritas is a leading wireless/IoT testing, inspection, audit and certification provider, with a global network of test laboratories to support the IoT industry in areas of connectivity, security, interoperability as well as quality, health & safety, and environmental/chemical requirements.

If you have any comments, please feel free to contact us at the following:

**Milpitas EMC/RF/Safety/Telecom Lab**

775 Montague Expressway, Milpitas, CA 95035

Tel: +1 408 526 1188

**Sunnyvale OTA/Bluetooth Lab**

1293 Anvilwood Avenue, Sunnyvale, CA

94089

Tel: +1 669 600 5293

**Littleton EMC/RF/Safety/Environmental Lab**

1 Distribution Center Cir #1, Littleton, MA 01460

Tel: +1 978 486 8880

**Email:** [sales.eaw@us.bureauveritas.com](mailto:sales.eaw@us.bureauveritas.com)

**Web Site:** [www.cps.bureauveritas.com](http://www.cps.bureauveritas.com)

The address and road map of all our labs can be found in our web site also.

--- END ---