

6

5

4

3

2

REVISION RECORD

LTR	ECO NO:	APPROVED:	DATE:

PCB1  
PCB\_SIZE

- MK
- MK1
- MK2
- MK3

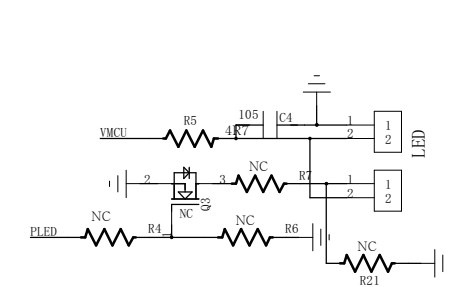
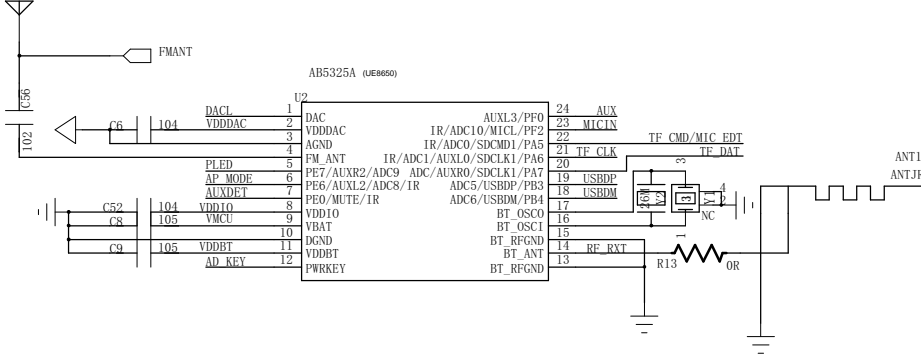

LED

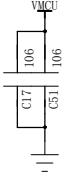
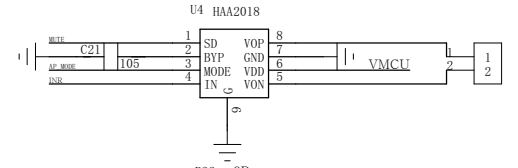
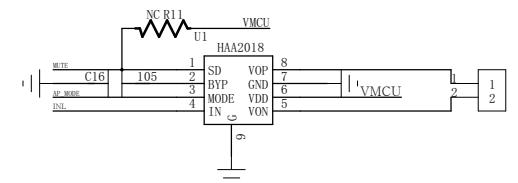
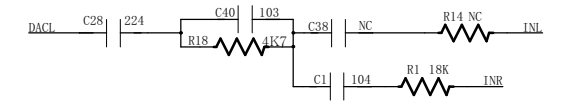
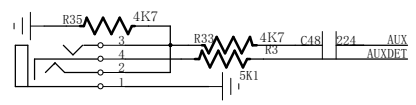

MASTER

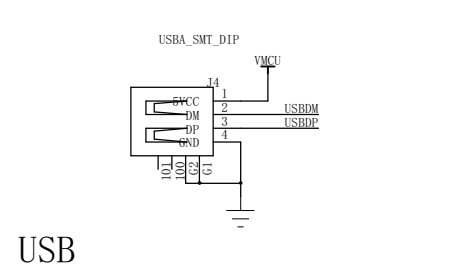
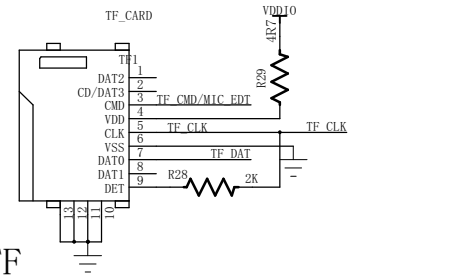

USB

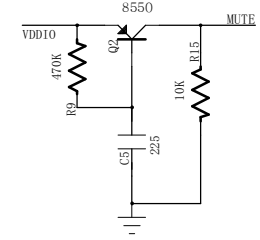
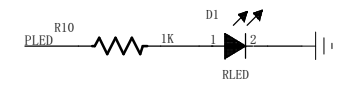

TF

A

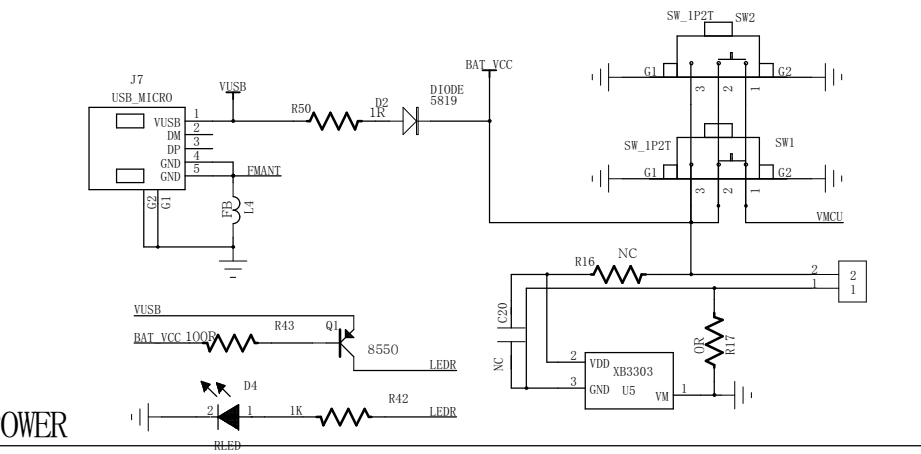

POWER

KEY-BORD

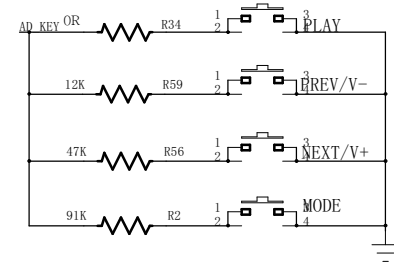

MIC

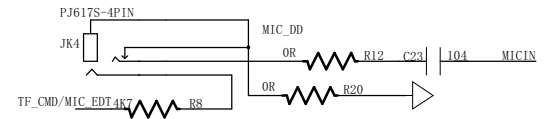

D

C

B

A