

MCU

Chip packaging: SSOP-24

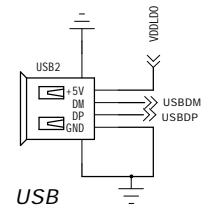

USB

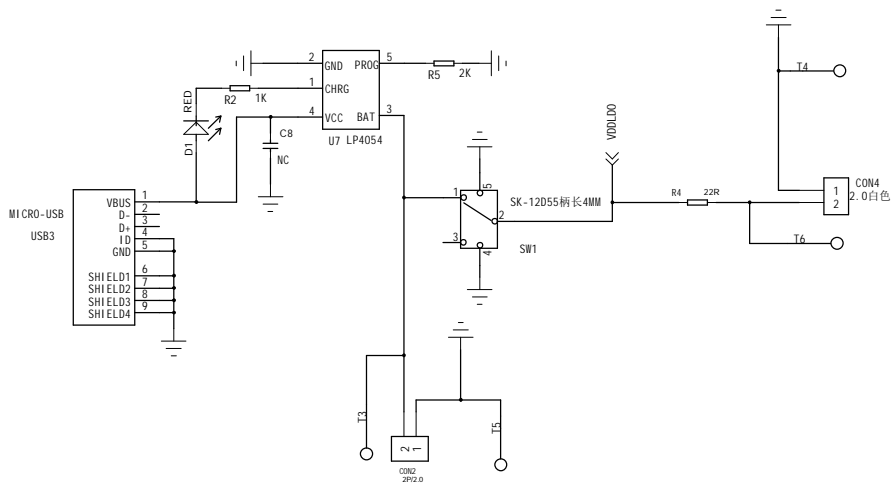
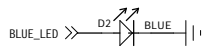
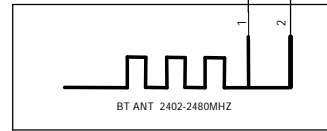
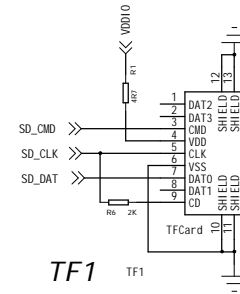
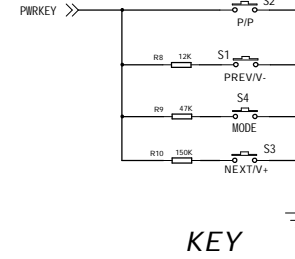

TF1

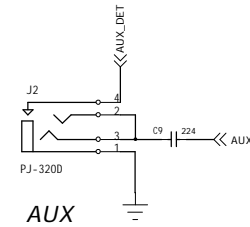

AUX

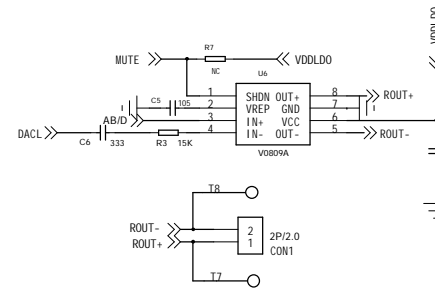

6

5

4

3

2

1

D

C

B

A

D

C

B

A

REVISION RECORD			
LTR	ECO NO:	APPROVED:	DATE:

COMPANY:			
TITLE:			
DRAWN:	DATED:		
CHECKED:	DATED:		
QUALITY CONTROL:	DATED:		
RELEASED:	DATED:		
CODE:	SIZE:	DRAWING NO:	REV:
	A3		
SCALE:			SHEET: 2 OF 2