

FCC TEST REPORT

For

Shenzhen Neon Industrial Co., LTD

Smart bracelet

Model No.: X9

Prepared for : Shenzhen Neon Industrial Co., LTD
Address : 1/F, C6, Hengfeng Industrial Park, Xi xiang Town, Baoan District, Shenzhen, China

Prepared by : Shenzhen LCS Compliance Testing Laboratory Ltd.
Address : 1/F., Xingyuan Industrial Park, Tongda Road, Bao'an Avenue, Bao'an District, Shenzhen, Guangdong, China

Tel : (+86)755-82591330
Fax : (+86)755-82591332
Web : www.LCS-cert.com
Mail : webmaster@LCS-cert.com

Date of receipt of test sample : April 22, 2017
Number of tested samples : 1
Serial number : Prototype
Date of Test : April 22, 2017 ~ May 22, 2017
Date of Report : May 22, 2017

**FCC TEST REPORT
FCC CFR 47 PART 15 C(15.247): 2016**

Report Reference No. : **LCS170422003AE**

Date of Issue : May 22, 2017

Testing Laboratory Name..... : **Shenzhen LCS Compliance Testing Laboratory Ltd.**

Address : 1/F., Xingyuan Industrial Park, Tongda Road, Bao'an Avenue,
Bao'an District, Shenzhen, Guangdong, China

Testing Location/ Procedure : Full application of Harmonised standards
Partial application of Harmonised standards
Other standard testing method

Applicant's Name..... : **Shenzhen Neon Industrial Co., LTD**

Address : 1/F, C6, Hengfeng Industrial Park, Xi xiang Town, Baoan District,
Shenzhen, China

Test Specification

Standard..... : FCC CFR 47 PART 15 C(15.247): 2016

Test Report Form No. : LCSEMC-1.0

TRF Originator : Shenzhen LCS Compliance Testing Laboratory Ltd.

Master TRF : Dated 2011-03

Shenzhen LCS Compliance Testing Laboratory Ltd. All rights reserved.

This publication may be reproduced in whole or in part for non-commercial purposes as long as the Shenzhen LCS Compliance Testing Laboratory Ltd. is acknowledged as copyright owner and source of the material. Shenzhen LCS Compliance Testing Laboratory Ltd. takes no responsibility for and will not assume liability for damages resulting from the reader's interpretation of the reproduced material due to its placement and context.

EUT Description. : **Smart bracelet**

Trade Mark..... : iwear

Model/ Type reference : X9

Ratings : DC 3.7V by battery(75mAh)
Charging voltage: 5.0V^{DC}, 1A

Result : **Positive**

Compiled by:



Linda He/ File administrators

Supervised by:



Glin Lu/ Technique principal

Approved by:



Gavin Liang/ Manager

FCC -- TEST REPORT

Test Report No. : LCS170422003AE	<u>May 22, 2017</u> Date of issue
---	--------------------------------------

Type / Model.....	: Smart bracelet
EUT.....	: X9

Applicant.....	: Shenzhen Neon Industrial Co., LTD
Address.....	: 1/F, C6, Hengfeng Industrial Park, Xi xiang Town, Baoan District, Shenzhen, China
Telephone.....	: /
Fax.....	: /

Manufacturer.....	: Shenzhen Neon Industrial Co., LTD
Address.....	: 1/F, C6, Hengfeng Industrial Park, Xi xiang Town, Baoan District, Shenzhen, China
Telephone.....	: /
Fax.....	: /

Factory.....	: Shenzhen Neon Industrial Co., LTD
Address.....	: 1/F, C6, Hengfeng Industrial Park, Xi xiang Town, Baoan District, Shenzhen, China
Telephone.....	: /
Fax.....	: /

Test Result	Positive
--------------------	-----------------

The test report merely corresponds to the test sample.

It is not permitted to copy extracts of these test result without the written permission of the test laboratory.

Revision History

Revision	Issue Date	Revisions	Revised By
00	May 22, 2017	Initial Issue	Gavin Liang

TABLE OF CONTENTS

1. GENERAL INFORMATION	6
1.1. DESCRIPTION OF DEVICE (EUT)	6
1.2. HOST SYSTEM CONFIGURATION LIST AND DETAILS	7
1.3. EXTERNAL I/O CABLE	7
1.4. DESCRIPTION OF TEST FACILITY	7
1.5. STATEMENT OF THE MEASUREMENT UNCERTAINTY	7
1.6. MEASUREMENT UNCERTAINTY	7
1.7. DESCRIPTION OF TEST MODES	8
2. TEST METHODOLOGY	9
2.1. EUT CONFIGURATION	9
2.2. EUT EXERCISE	9
2.3. GENERAL TEST PROCEDURES	9
3. SYSTEM TEST CONFIGURATION.....	10
3.1. JUSTIFICATION	10
3.2. EUT EXERCISE SOFTWARE.....	10
3.3. SPECIAL ACCESSORIES	10
3.4. BLOCK DIAGRAM/SCHEMATICS.....	10
3.5. EQUIPMENT MODIFICATIONS	10
3.6. TEST SETUP.....	10
4. SUMMARY OF TEST RESULTS.....	11
5. TEST RESULT	12
5.1. ON TIME AND DUTY CYCLE	12
5.2. MAXIMUM CONDUCTED OUTPUT POWER MEASUREMENT.....	14
5.3. POWER SPECTRAL DENSITY MEASUREMENT	16
5.4. 6 dB SPECTRUM BANDWIDTH MEASUREMENT	19
5.5. RADIATED EMISSIONS MEASUREMENT.....	21
5.6. CONDUCTED SPURIOUS EMISSIONS AND BAND EDGES TEST.....	30
5.7. AC POWER LINE CONDUCTED EMISSIONS.....	33
5.8. BAND-EDGE MEASUREMENTS FOR RADIATED EMISSIONS.....	36
5.9. ANTENNA REQUIREMENTS.....	39
6. LIST OF MEASURING EQUIPMENTS.....	41
7. TEST SETUP PHOTOGRAPHS OF EUT.....	42
8. EXTERIOR PHOTOGRAPHS OF THE EUT.....	42
9. INTERIOR PHOTOGRAPHS OF THE EUT	42

1. GENERAL INFORMATION

1.1. Description of Device (EUT)

EUT	: Smart bracelet
Model Number	: X9
Model Declaration	: /
Test Model	: X9
Power Supply	: DC 3.7V by battery(75mAh) Charging voltage: 5.0V, 1A
Hardware Version	: X9_51822_ Min V4.0
Software Version	: GetFit3.0
Frequency Range	: 2402~2480MHz
Bluetooth Version	: V4.0
Channel Number	: 40 Channels for Bluetooth V4.0(DTS)
Modulation Technology	: GFSK for Bluetooth V4.0(DTS)
Data Rates	: Bluetooth V4.0(DTS): 1Mbps
Antenna Type And Gain	: Internal antenna, 2.71dBi

1.2. Host System Configuration List and Details

Manufacturer	Description	Model	Serial Number	Certificate
Lenovo	PC	B470	--	DOC
Lenovo	AC/DC ADAPTER	ADP-90DDB	--	DOC

1.3. External I/O Cable

I/O Port Description	Quantity	Cable
Charge Interface	1	N/A

1.4. Description of Test Facility

CNAS Registration Number. is L4595.

FCC Registration Number. is 899208.

Industry Canada Registration Number. is 9642A-1.

ESMD Registration Number. is ARCB0108.

UL Registration Number. is 100571-492.

TUV SUD Registration Number. is SCN1081.

TUV RH Registration Number. is UA 50296516-001

The 3m-Semi anechoic test site fulfils CISPR 16-1-4 according to ANSI C63.10 and CISPR 16-1-4:2010 SVSWR requirement for radiated emission above 1GHz.

1.5. Statement of the Measurement Uncertainty

The data and results referenced in this document are true and accurate. The reader is cautioned that there may be errors within the calibration limits of the equipment and facilities. The measurement uncertainty was calculated for all measurements listed in this test report acc. To CISPR 16 – 4 “Specification for radio disturbance and immunity measuring apparatus and methods – Part 4: Uncertainty in EMC Measurements” and is documented in the LCS quality system acc. To DIN EN ISO/IEC 17025. Furthermore, component and process variability of devices similar to that tested may result in additional deviation. The manufacturer has the sole responsibility of continued compliance of the device.

1.6. Measurement Uncertainty

Test Item	Frequency Range	Uncertainty	Note
Radiation Uncertainty	9KHz~30MHz	±3.10dB	(1)
	30MHz~200MHz	±2.96dB	(1)
	200MHz~1000MHz	±3.10dB	(1)
	1GHz~26.5GHz	±3.80dB	(1)
	26.5GHz~40GHz	±3.90dB	(1)
Conduction Uncertainty	150kHz~30MHz	±1.63dB	(1)
Power disturbance	30MHz~300MHz	±1.60dB	(1)

(1). This uncertainty represents an expanded uncertainty expressed at approximately the 95% confidence level using a coverage factor of k=2.

1.7. Description of Test Modes

The EUT has been tested under operating condition.

This test was performed with EUT in X, Y, Z position and the worst case was found when EUT in X position.

Pre-test AC conducted emission at both power adapter and charge from PC mode, recorded worst case.

Pre-test AC conducted emission at both voltage AC 120V/60Hz and AC 240V/50Hz, recorded worst case.

Worst-case mode and channel used for 150 kHz-30 MHz power line conducted emissions was the mode and channel with the highest output power, which was determined to be BT LE mode (Low Channel).

Worst-case mode and channel used for 9kHz-1000 MHz radiated emissions was the mode and channel with the highest output power, that was determined to be BT LE mode(Low Channel).

Worst-Case data rates were utilized from preliminary testing of the Chipset, worst-case data rates used during the testing are as follows:

BT LE: 1 Mbps, DSSS.

BLE 4.0

Frequency Band	Channel No.	Frequency(MHz)	Channel No.	Frequency(MHz)
2402~2480MHz	1	2402	21	2442
	2	2404	--	--
	3	2406	--	--
	--	--	38	2476
	--	--	39	2478
	20	2440	40	2480

2. TEST METHODOLOGY

All measurements contained in this report were conducted with ANSI C63.10-2013, American National Standard of Procedures for Compliance Testing of Unlicensed Wireless Devices.

The radiated testing was performed at an antenna-to-EUT distance of 3 meters. All radiated and conducted emissions measurement was performed at Shenzhen LCS Compliance Testing Laboratory Ltd.

2.1. EUT Configuration

The EUT configuration for testing is installed on RF field strength measurement to meet the Commissions requirement and operating in a manner that intends to maximize its emission characteristics in a continuous normal application.

2.2. EUT Exercise

The EUT was operated in the engineering mode to fix the TX frequency that was for the purpose of the measurements.

According to FCC's request, Test Procedure KDB558074 D01 DTS Meas. Guidance v03r05 and KDB 6622911 are required to be used for this kind of FCC 15.247 digital modulation device.

According to its specifications, the EUT must comply with the requirements of the Section 15.203, 15.205, 15.207, 15.209 and 15.247 under the FCC Rules Part 15 Subpart C.

2.3. General Test Procedures

2.3.1 Conducted Emissions

The EUT is placed on the turntable, which is 0.8 m above ground plane. According to the requirements in Section 6.2.1 of ANSI C63.10-2013 Conducted emissions from the EUT measured in the frequency range between 0.15 MHz and 30MHz using Quasi-peak and average detector modes.

2.3.2 Radiated Emissions

The EUT is placed on a turn table, which is 0.8 m above ground plane. The turntable shall rotate 360 degrees to determine the position of maximum emission level. EUT is set 3m away from the receiving antenna, which varied from 1m to 4m to find out the highest emission. And also, each emission was to be maximized by changing the polarization of receiving antenna both horizontal and vertical. In order to find out the maximum emissions, exploratory radiated emission measurements were made according to the requirements in Section 6.3 of ANSI C63.10-2013

3. SYSTEM TEST CONFIGURATION

3.1. Justification

The system was configured for testing in a continuous transmit condition. The duty cycle is 100% and the average correction factor is 0.

3.2. EUT Exercise Software

The system was configured for testing in a continuous transmits condition and change test channels by software (nrfgostudio_win-32_1.21.2_installer) provided by application.

3.3. Special Accessories

No.	Equipment	Manufacturer	Model No.	Serial No.	Length	shielded/ unshielded	Notes
1	PC	Lenovo	Ideapad	A131101550	/	/	DOC
2	Power adapter	Lenovo	CPA-A090	36200414	1.00m	unshielded	DOC

3.4. Block Diagram/Schematics

Please refer to the related document

3.5. Equipment Modifications

Shenzhen LCS Compliance Testing Laboratory Ltd. has not done any modification on the EUT.

3.6. Test Setup

Please refer to the test setup photo.

4. SUMMARY OF TEST RESULTS

Applied Standard: FCC Part 15 Subpart C		
FCC Rules	Description of Test	Result
§15.247(b)	Maximum Conducted Output Power	Compliant
§15.247(e)	Power Spectral Density	Compliant
§15.247(a)(2)	6dB Bandwidth	Compliant
§15.247(a)	Occupied Bandwidth	Compliant
§15.209, §15.247(d)	Radiated and Conducted Spurious Emissions	Compliant
§15.205	Emissions at Restricted Band	Compliant
§15.207(a)	Conducted Emissions	Compliant
§15.203	Antenna Requirements	Compliant
§15.247(i)§2.1093	RF Exposure	Compliant

5. TEST RESULT

5.1. On Time and Duty Cycle

5.1.1. Standard Applicable

None; for reporting purpose only.

5.1.2. Measuring Instruments and Setting

Please refer to section 6 of equipment list in this report. The following table is the setting of the spectrum analyzer.

5.1.3. Test Procedures

1. Set the center frequency of the spectrum analyzer to the transmitting frequency;
2. Set the span=0MHz, RBW=8MHz, VBW=50MHz, Sweep time=5ms;
3. Detector = peak;
4. Trace mode = Single hold.

5.1.4. Test Setup Layout

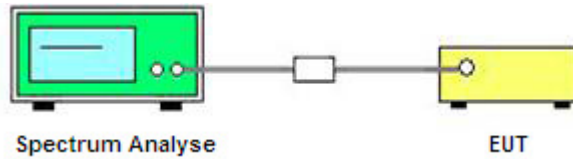

5.1.5. EUT Operation during Test

The EUT was programmed to be in continuously transmitting mode.

5.1.6. Test result

Mode	On Time B (ms)	Period (ms)	Duty Cycle x (Linear)	Duty Cycle (%)	Duty Cycle Correction Factor (dB)	1/B Minimum VBW (KHz)
BT LE	5.0	5.0	1	100	0	0.01

On Time and Duty Cycle

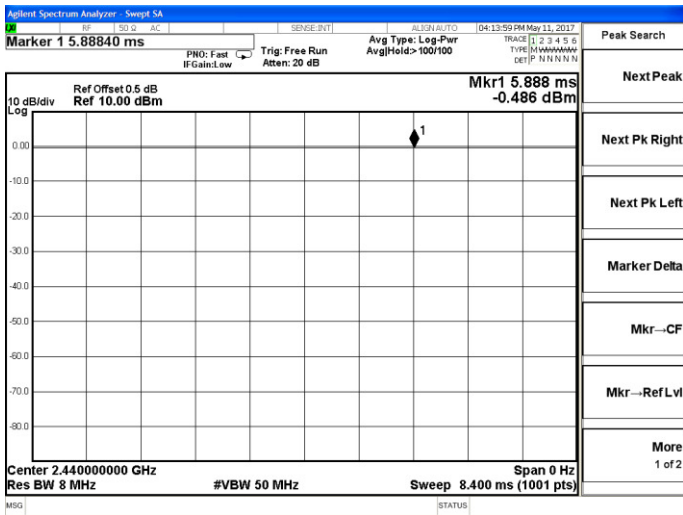

Channel 19 / 2440 MHz

5.2. Maximum Conducted Output Power Measurement

5.2.1. Standard Applicable

For systems using digital modulation in the 902-928 MHz, 2400-2483.5 MHz, and 5725-5850 MHz bands: 1 Watt. As an alternative to a peak power measurement, compliance with the one Watt limit can be based on a measurement of the maximum conducted output power. Maximum Conducted Output Power is defined as the total transmit power delivered to all antennas and antenna elements averaged across all symbols in the signaling alphabet when the transmitter is operating at its maximum power control level. Power must be summed across all antennas and antenna elements. The average must not include any time intervals during which the transmitter is off or is transmitting at a reduced power level. If multiple modes of operation are possible (e.g., alternative modulation methods), the maximum conducted output power is the highest total transmit power occurring in any mode.

5.2.2. Test Procedures

The transmitter output (antenna port) was connected to the spectrum analyzer.

According to KDB558074 D01 DTS Measurement Guidance Section 9.1 Maximum peak conducted output power 9.1.1.

This procedure shall be used when the measurement instrument has available a resolution bandwidth that is greater than the DTS bandwidth.

- a) Set the RBW \geq DTS bandwidth.
- b) Set VBW $\geq 3 \times$ RBW.
- c) Set span $\geq 3 \times$ RBW
- d) Sweep time = auto couple.
- e) Detector = peak.
- f) Trace mode = max hold.
- g) Allow trace to fully stabilize.
- h) Use peak marker function to determine the peak amplitude level.

5.2.3. Test Setup Layout

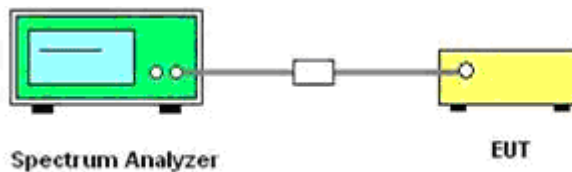

5.2.4. EUT Operation during Test

The EUT was programmed to be in continuously transmitting mode.

5.2.5. Test Result of Maximum Conducted Output Power

Temperature	24.8°C	Humidity	51.2%
Test Engineer	Demi Lin	Configurations	BT LE

Test Mode	Channel	Frequency (MHz)	Measured Maximum Peak Power (dBm)	Limits (dBm)	Verdict
GFSK-BLE	0	2402	1.784	30	PASS
	19	2440	1.223		
	39	2480	0.580		

Remark:

1. Test results including cable loss;
2. please refer to following plots;

Maximum Peak Output Power

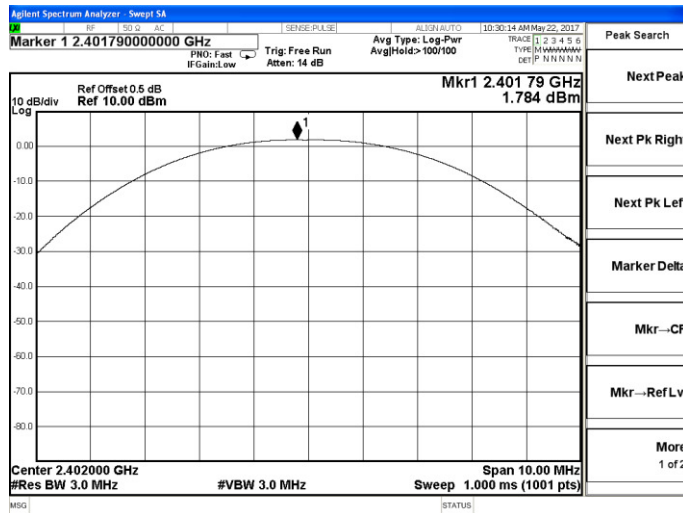

Channel 0 / 2402 MHz

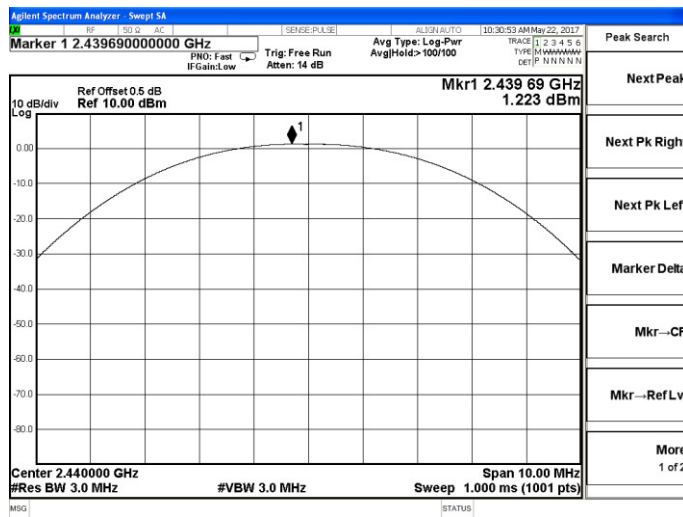

Channel 19 / 2440 MHz

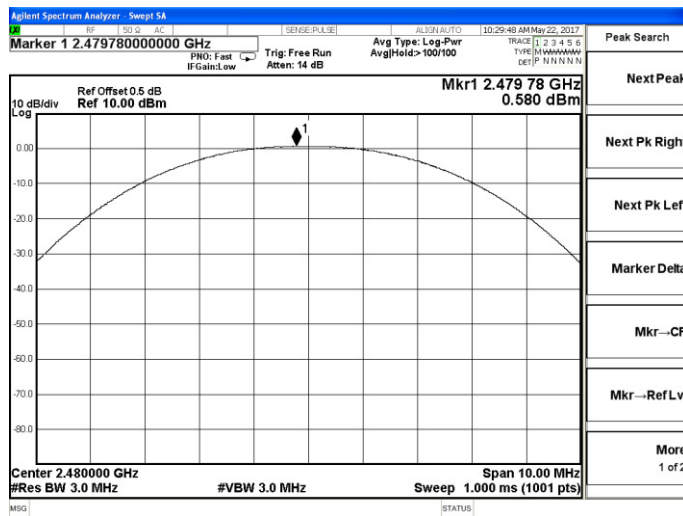

Channel 39 / 2480 MHz

5.3. Power Spectral Density Measurement

5.3.1. Standard Applicable

According to §15.247(e): For digitally modulated systems, the power spectral density conducted from the intentional radiator to the antenna shall not be greater than 8 dBm in any 3 kHz band during any time interval of continuous transmission.

5.3.2. Measuring Instruments and Setting

Please refer to section 6 of equipment list in this report. The following table is the setting of Spectrum Analyzer.

5.3.3. Test Procedures

1. Use this procedure when the maximum peak conducted output power in the fundamental emission is used to demonstrate compliance.
2. The power was monitored at the coupler port with a Spectrum Analyzer. The power level was set to the maximum level.
3. Set the RBW = 100 kHz.
4. Set the VBW $\geq 3 \times$ RBW
5. Set the span to 1.5 times the DTS channel bandwidth.
6. Detector = peak.
7. Sweep time = auto couple.
8. Trace mode = max hold.
9. Allow trace to fully stabilize.
10. Use the peak marker function to determine the maximum power level.
11. If measured value exceeds limit, reduce RBW (no less than 3 kHz) and repeat.
12. The resulting peak PSD level must be 8 dBm.

5.3.4. Test Setup Layout

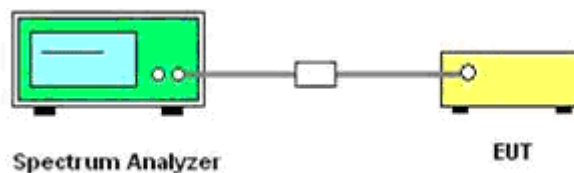

5.3.5. EUT Operation during Test

The EUT was programmed to be in continuously transmitting mode.

5.3.6. Test Result of Power Spectral Density

Temperature	24.8°C	Humidity	51.2%
Test Engineer	Demi Lin	Configurations	BT LE

Test Mode	Channel	Frequency (MHz)	Measured Peak Power Spectral Density (dBm/100KHz)	Limits (dBm/3KHz)	Verdict
GFSK-BLE	0	2402	-0.937	8	PASS
	19	2440	-1.193		
	39	2480	-0.547		

Remark:

1. *Test results including cable loss;*
2. *please refer to following plots;*

Peak Power Spectral Density

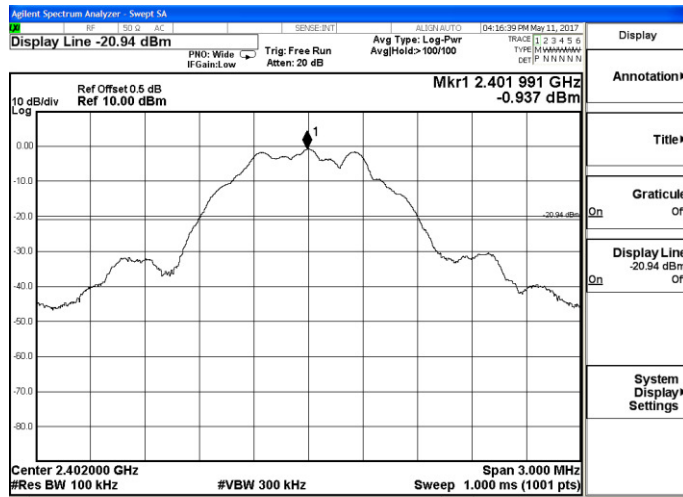

Channel 0 / 2402 MHz



Channel 19 / 2440 MHz

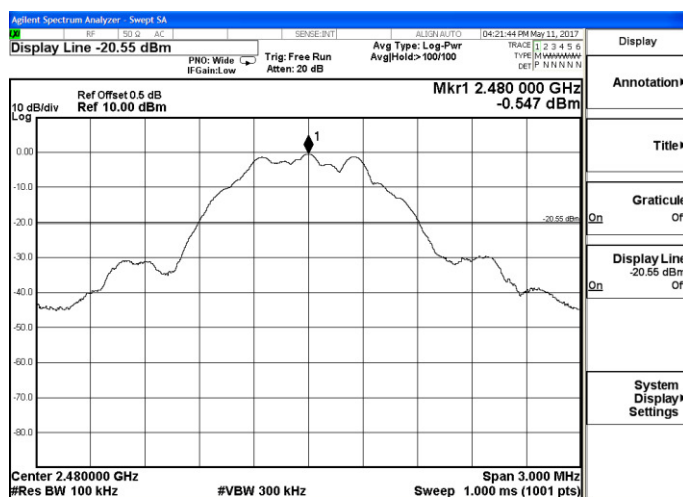

Channel 39 / 2480 MHz

5.4. 6 dB Spectrum Bandwidth Measurement

5.4.1. Standard Applicable

According to §15.247(a) (2): For digital modulation systems, the minimum 6 dB bandwidth shall be at least 500 kHz.

5.4.2. Measuring Instruments and Setting

Please refer to section 6 of equipment list in this report. The following table is the setting of the Spectrum Analyzer.

Spectrum Parameter	Setting
Attenuation	Auto
Span Frequency	> RBW
Detector	Peak
Trace	Max Hold
Sweep Time	1ms

5.4.3. Test Procedures

1. The transmitter output (antenna port) was connected to the spectrum analyzer in peak hold mode.
2. The resolution bandwidth and the video bandwidth were set according to KDB558074.
3. Measured the spectrum width with power higher than 6dB below carrier.

5.4.4. Test Setup Layout

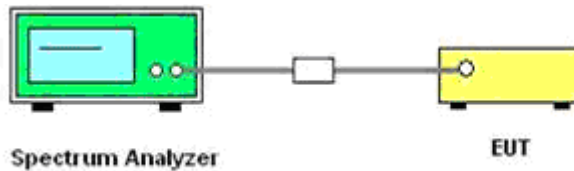

5.4.5. EUT Operation during Test

The EUT was programmed to be in continuously transmitting mode.

5.4.6. Test Result of 6dB Spectrum Bandwidth

Temperature	24.8°C	Humidity	51.2%
Test Engineer	Demi Lin	Configurations	BT LE

Test Mode	Channel	Frequency (MHz)	6dB Bandwidth (KHz)	Limits (KHz)	Verdict
GFSK-BLE	0	2402	693.00	500	PASS
	19	2440	691.10		
	39	2480	689.30		

Remark:

1. Test results including cable loss;
2. please refer to following plots;

6dB Bandwidth

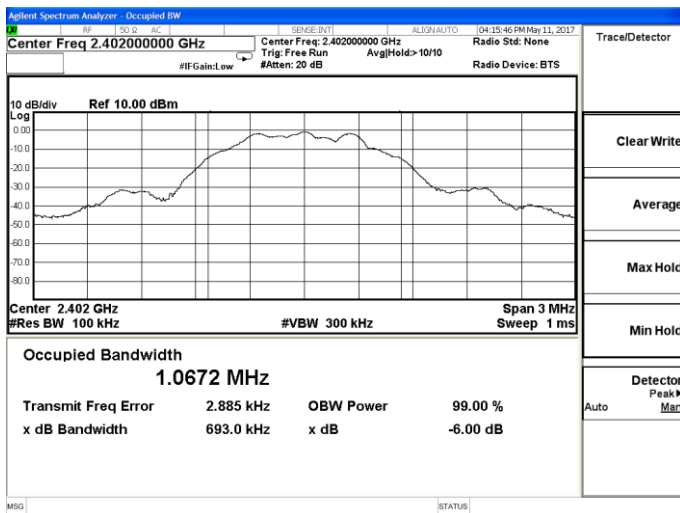

Channel 0 / 2402 MHz

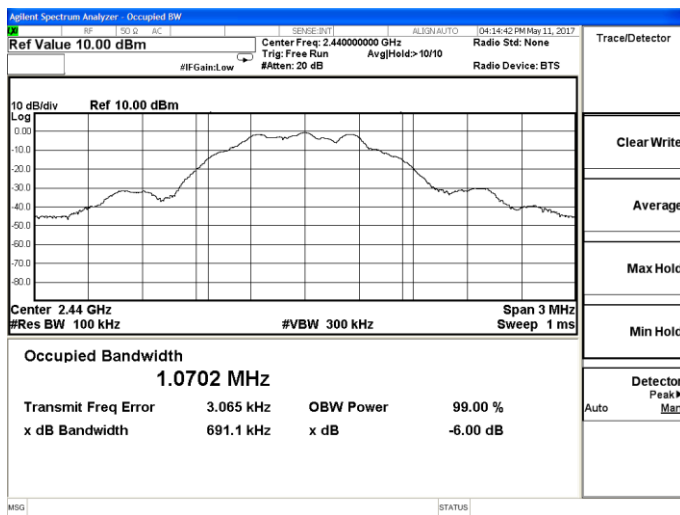

Channel 19 / 2440 MHz

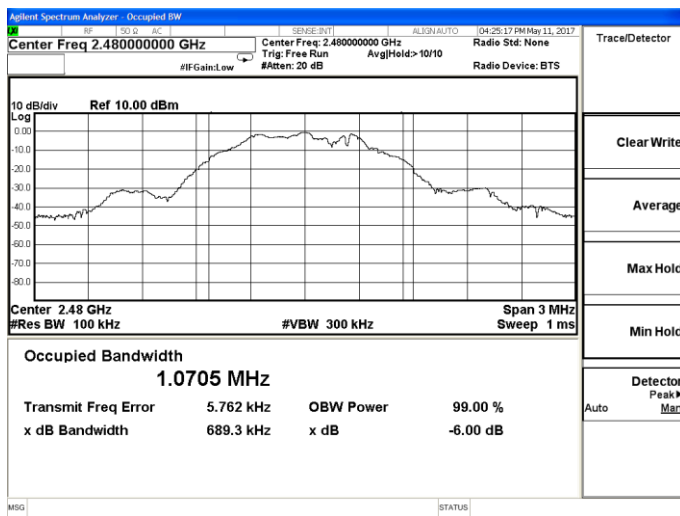

Channel 39 / 2480 MHz

5.5. Radiated Emissions Measurement

5.5.1. Standard Applicable

15.205 (a) Except as shown in paragraph (d) of this section, only spurious emissions are permitted in any of the frequency bands listed below:

MHz	MHz	MHz	GHz
0.090-0.110	16.42-16.423	399.9-410	4.5-5.15
\1 0.495-0.505	16.69475-16.69525	608-614	5.35-5.46
2.1735-2.1905	16.80425-16.80475	960-1240	7.25-7.75
4.125-4.128	25.5-25.67	1300-1427	8.025-8.5
4.17725-4.17775	37.5-38.25	1435-1626.5	9.0-9.2
4.20725-4.20775	73-74.6	1645.5-1646.5	9.3-9.5
6.215-6.218	74.8-75.2	1660-1710	10.6-12.7
6.26775-6.26825	108-121.94	1718.8-1722.2	13.25-13.4
6.31175-6.31225	123-138	2200-2300	14.47-14.5
8.291-8.294	149.9-150.05	2310-2390	15.35-16.2
8.362-8.366	156.52475-156.52525	2483.5-2500	17.7-21.4
8.37625-8.38675	156.7-156.9	2690-2900	22.01-23.12
8.41425-8.41475	162.0125-167.17	3260-3267	23.6-24.0
12.29-12.293	167.72-173.2	3332-3339	31.2-31.8
12.51975-12.52025	240-285	3345.8-3358	36.43-36.5
12.57675-12.57725	322-335.4	3600-4400	(2\)
13.36-13.41			

\1\ Until February 1, 1999, this restricted band shall be 0.490-0.510 MHz.

\2\ Above 38.6

According to §15.247 (d): 20dBc in any 100 kHz bandwidth outside the operating frequency band. In case the emission fall within the restricted band specified on 15.205(a), then the 15.209(a) limit in the table below has to be followed.

Frequencies (MHz)	Field Strength (microvolts/meter)	Measurement Distance (meters)
0.009~0.490	2400/F(KHz)	300
0.490~1.705	24000/F(KHz)	30
1.705~30.0	30	30
30~88	100	3
88~216	150	3
216~960	200	3
Above 960	500	3

5.5.2. Measuring Instruments and Setting

Please refer to section 6 of equipment list in this report. The following table is the setting of spectrum analyzer and receiver.

Spectrum Parameter	Setting
Attenuation	Auto
Start Frequency	1000 MHz
Stop Frequency	10 th carrier harmonic
RB / VB (Emission in restricted band)	1MHz / 1MHz for Peak, 1 MHz / 1/B kHz for Average
RB / VB (Emission in non-restricted band)	1MHz / 1MHz for Peak, 1 MHz / 1/B kHz for Average

Receiver Parameter	Setting
Attenuation	Auto
Start ~ Stop Frequency	9kHz~150kHz / RB/VB 200Hz/1KHz for QP/AVG
Start ~ Stop Frequency	150kHz~30MHz / RB/VB 9kHz/30KHz for QP/AVG
Start ~ Stop Frequency	30MHz~1000MHz / RB/VB 120kHz/1MHz for QP

5.5.3. Test Procedures

1) Sequence of testing 9 kHz to 30 MHz

Setup:

- The equipment was set up to simulate a typical usage like described in the user manual or described by manufacturer.
- If the EUT is a tabletop system, a rotatable table with 0.8 m height is used.
- If the EUT is a floor standing device, it is placed on the ground.
- Auxiliary equipment and cables were positioned to simulate normal operation conditions.
- The AC power port of the EUT (if available) is connected to a power outlet below the turntable.
- The measurement distance is 3 meter.
- The EUT was set into operation.

Premeasurement:

- The turntable rotates from 0° to 315° using 45° steps.
- The antenna height is 0.8 meter.
- At each turntable position the analyzer sweeps with peak detection to find the maximum of all emissions

Final measurement:

- Identified emissions during the premeasurement the software maximizes by rotating the turntable position (0° to 360°) and by rotating the elevation axes (0° to 360°).
- The final measurement will be done in the position (turntable and elevation) causing the highest emissions with QPK detector.
- The final levels, frequency, measuring time, bandwidth, turntable position, correction factor, margin to the limit and limit will be recorded. Also a plot with the graph of the premeasurement and the limit will be stored.

2) Sequence of testing 30 MHz to 1 GHz

Setup:

- The equipment was set up to simulate a typical usage like described in the user manual or described by manufacturer.
- If the EUT is a tabletop system, a table with 0.8 m height is used, which is placed on the ground plane.
- If the EUT is a floor standing device, it is placed on the ground plane with insulation between both.
- Auxiliary equipment and cables were positioned to simulate normal operation conditions
- The AC power port of the EUT (if available) is connected to a power outlet below the turntable.
- The measurement distance is 3 meter.
- The EUT was set into operation.

Premeasurement:

- The turntable rotates from 0° to 315° using 45° steps.
- The antenna is polarized vertical and horizontal.
- The antenna height changes from 1 to 3 meter.
- At each turntable position, antenna polarization and height the analyzer sweeps three times in peak to find the maximum of all emissions.

Final measurement:

- The final measurement will be performed with minimum the six highest peaks.
- According to the maximum antenna and turntable positions of premeasurement the software maximize the peaks by changing turntable position ($\pm 45^\circ$) and antenna movement between 1 and 4 meter.
- The final measurement will be done with QP detector with an EMI receiver.
- The final levels, frequency, measuring time, bandwidth, antenna height, antenna polarization, turntable angle, correction factor, margin to the limit and limit will be recorded. Also a plot with the graph of the premeasurement with marked maximum final measurements and the limit will be stored.

3) Sequence of testing 1 GHz to 18 GHz

Setup:

- The equipment was set up to simulate a typical usage like described in the user manual or described by manufacturer.
- If the EUT is a tabletop system, a rotatable table with 1.5 m height is used.
- If the EUT is a floor standing device, it is placed on the ground plane with insulation between both.
- Auxiliary equipment and cables were positioned to simulate normal operation conditions
- The AC power port of the EUT (if available) is connected to a power outlet below the turntable.
- The measurement distance is 3 meter.
- The EUT was set into operation.

Premeasurement:

- The turntable rotates from 0° to 315° using 45° steps.
- The antenna is polarized vertical and horizontal.
- The antenna height scan range is 1 meter to 2.5 meter.
- At each turntable position and antenna polarization the analyzer sweeps with peak detection to find the maximum of all emissions.

Final measurement:

- The final measurement will be performed with minimum the six highest peaks.
- According to the maximum antenna and turntable positions of premeasurement the software maximize the peaks by changing turntable position ($\pm 45^\circ$) and antenna movement between 1 and 4 meter. This procedure is repeated for both antenna polarizations.
- The final measurement will be done in the position (turntable, EUT-table and antenna polarization) causing the highest emissions with Peak and Average detector.
- The final levels, frequency, measuring time, bandwidth, turntable position, EUT-table position, antenna polarization, correction factor, margin to the limit and limit will be recorded. Also a plot with the graph of the premeasurement with marked maximum final measurements and the limit will be stored.

4) Sequence of testing above 18 GHz

Setup:

- The equipment was set up to simulate a typical usage like described in the user manual or described by manufacturer.
- If the EUT is a tabletop system, a rotatable table with 1.5 m height is used.
- If the EUT is a floor standing device, it is placed on the ground plane with insulation between both.
- Auxiliary equipment and cables were positioned to simulate normal operation conditions
- The AC power port of the EUT (if available) is connected to a power outlet below the turntable.
- The measurement distance is 1 meter.
- The EUT was set into operation.

Premeasurement:

- The antenna is moved spherical over the EUT in different polarizations of the antenna.

Final measurement:

- The final measurement will be performed at the position and antenna orientation for all detected emissions that were found during the premeasurements with Peak and Average detector.
- The final levels, frequency, measuring time, bandwidth, correction factor, margin to the limit and limit will be recorded. Also a plot with the graph of the premeasurement and the limit will be stored.

5.5.4. Test Setup Layout

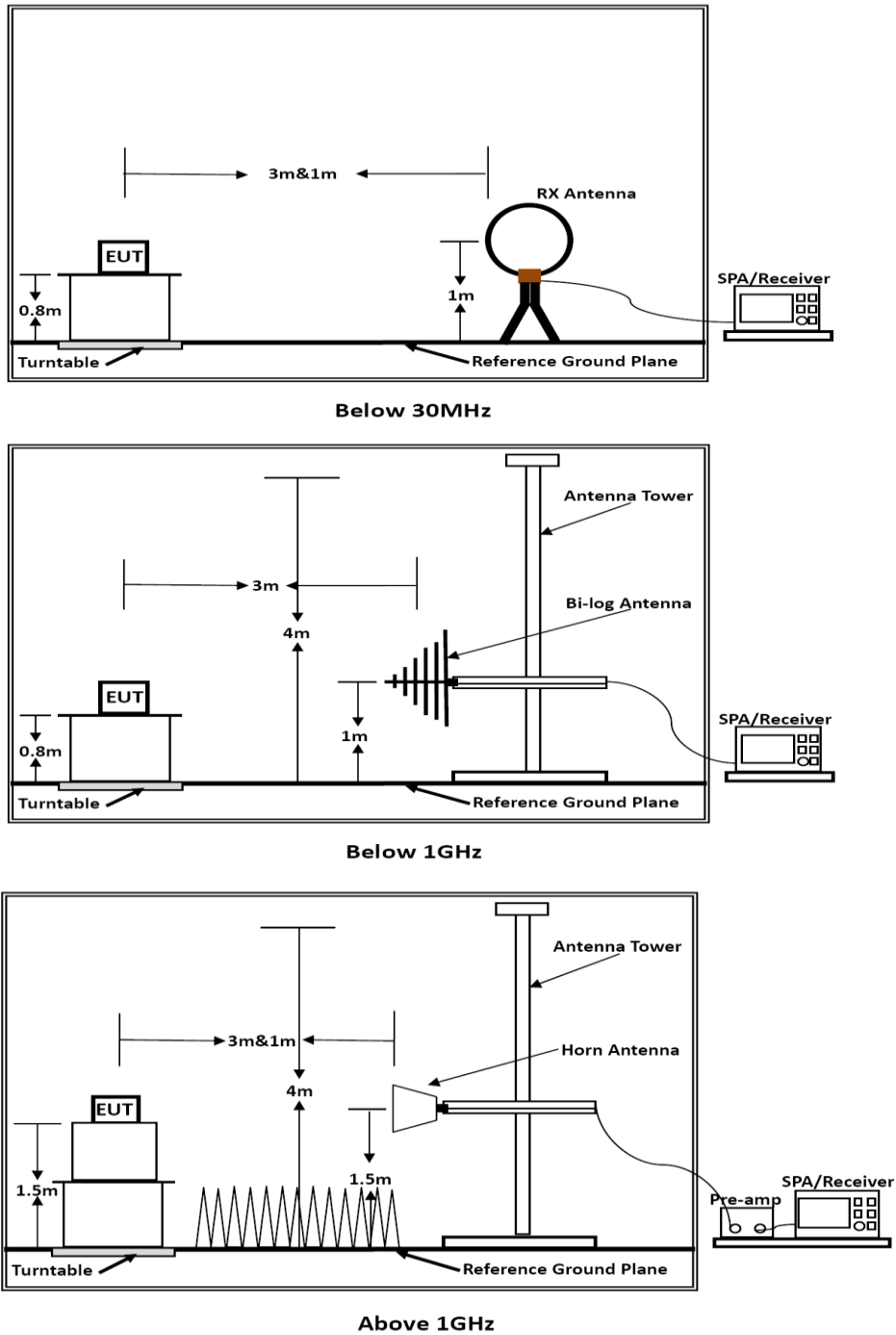

Above 10 GHz shall be extrapolated to the specified distance using an extrapolation factor of 20 dB/decade from 3m to 1.5m.

Distance extrapolation factor = $20 \log (\text{specific distance [3m]} / \text{test distance [1.5m]})$ (dB);
Limit line = specific limits (dBuV) + distance extrapolation factor [6 dB].

5.5.5. EUT Operation during Test

The EUT was programmed to be in continuously transmitting mode.

5.5.6. Results of Radiated Emissions (9 kHz~30MHz)

Temperature	24.0°C	Humidity	46.0%
Test Engineer	Demi Lin	Configurations	BT LE

Freq. (MHz)	Level (dBuV)	Over Limit (dB)	Over Limit (dBuV)	Remark
-	-	-	-	See Note

Note:

The amplitude of spurious emissions which are attenuated by more than 20 dB below the permissible value has no need to be reported.

Distance extrapolation factor = 40 log (specific distance / test distance) (dB);
 Limit line = specific limits (dBuV) + distance extrapolation factor.

5.5.7. Results of Radiated Emissions (30MHz~1GHz)

Temperature	24.0°C	Humidity	46.0%
Test Engineer	Demi Lin	Configurations	BT LE (Low CH)

Test result for BT LE (Low Channel)

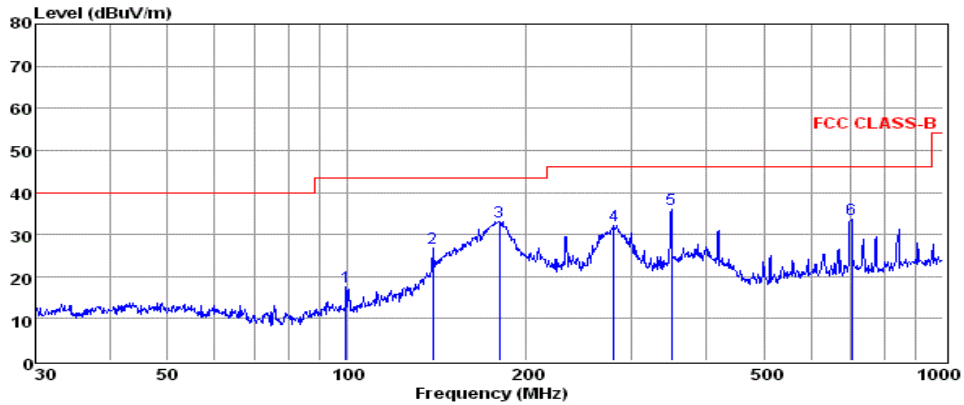

pol: VERTICAL

	Freq	Reading	CabLos	Antfac	Measured	Limit	Over	Remark
	MHz	dBuV	dB	dB/m	dBuV/m	dBuV/m	dB	
1	99.53	3.86	0.61	13.13	17.60	43.50	-25.90	QP
2	139.36	17.77	0.75	8.24	26.76	43.50	-16.74	QP
3	180.02	22.56	0.89	9.68	33.13	43.50	-10.37	QP
4	280.02	18.33	1.01	12.67	32.01	46.00	-13.99	QP
5	350.48	20.56	1.15	14.28	35.99	46.00	-10.01	QP
6	701.76	13.11	1.70	18.83	33.64	46.00	-12.36	QP

Note: 1. All readings are Quasi-peak values.
 2. Measured= Reading + Antenna Factor + Cable Loss
 3. The emission that are 20db below the official limit are not reported

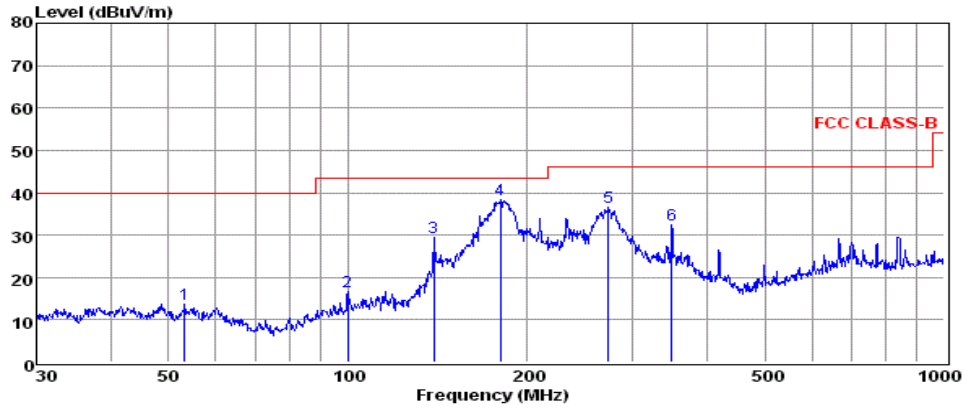

pol: HORIZONTAL

	Freq	Reading	CabLos	Antfac	Measured	Limit	Over	Remark
	MHz	dBuV	dB	dB/m	dBuV/m	dBuV/m	dB	
1	53.13	0.09	0.46	13.11	13.66	40.00	-26.34	QP
2	99.88	2.77	0.60	13.15	16.52	43.50	-26.98	QP
3	139.36	20.51	0.75	8.24	29.50	43.50	-14.00	QP
4	180.02	27.80	0.89	9.68	38.37	43.50	-5.13	QP
5	273.23	23.02	1.04	12.46	36.52	46.00	-9.48	QP
6	349.25	17.07	1.13	14.26	32.46	46.00	-13.54	QP

Note: 1. All readings are Quasi-peak values.
 2. Measured= Reading + Antenna Factor + Cable Loss
 3. The emission that are 20db below the official limit are not reported

Note:

- 1). Pre-scan all modes and recorded the worst case results in this report (BT LE (Low Channel)). Emission level (dBuV/m) = 20 log Emission level (uV/m).
- 2). Corrected Reading: Antenna Factor + Cable Loss + Read Level - Preamp Factor = Level.

5.5.8. Results for Radiated Emissions (Above 1GHz)

BT LE

Channel 0 / 2402 MHz

Freq. MHz	Reading dBuV	Ant. Fac. dB/m	Pre. Fac. dB	Cab. Loss dB	Measured dBuV/m	Limit dBuV/m	Margin dB	Remark	Pol.
4804.00	55.55	33.06	35.04	3.94	57.51	74.00	-16.49	Peak	Horizontal
4804.00	39.68	33.06	35.04	3.94	41.64	54.00	-12.36	Average	Horizontal
12010.00	53.34	33.16	35.06	3.96	55.40	74.00	-18.60	Peak	Horizontal
12010.00	42.48	33.16	35.06	3.96	44.54	54.00	-9.46	Average	Horizontal
4804.00	59.36	33.06	35.04	3.94	61.32	74.00	-12.68	Peak	Vertical
4804.00	42.72	33.06	35.04	3.94	44.68	54.00	-9.32	Average	Vertical
12010.00	55.38	33.16	35.06	3.96	57.44	74.00	-16.56	Peak	Vertical
12010.00	40.64	33.16	35.06	3.96	42.70	54.00	-11.30	Average	Vertical

Channel 19 / 2440 MHz

Freq. MHz	Reading dBuv	Ant. Fac. dB/m	Pre. Fac. dB	Cab. Loss dB	Measured dBuv/m	Limit dBuv/m	Margin dB	Remark	Pol.
4880.00	54.56	33.16	35.15	3.96	56.53	74.00	-17.47	Peak	Horizontal
4880.00	43.15	33.16	35.15	3.96	45.12	54.00	-8.88	Average	Horizontal
12200.00	53.14	33.26	35.17	3.98	55.21	74.00	-18.79	Peak	Horizontal
12200.00	40.62	33.26	35.17	3.98	42.69	54.00	-11.31	Average	Horizontal
4880.00	59.02	33.16	35.15	3.96	60.99	74.00	-13.01	Peak	Vertical
4880.00	42.80	33.16	35.15	3.96	44.77	54.00	-9.23	Average	Vertical
12200.00	55.61	33.26	35.17	3.98	57.68	74.00	-16.32	Peak	Vertical
12200.00	43.87	33.26	35.17	3.98	45.94	54.00	-8.06	Average	Vertical

Channel 39 / 2480 MHz

Freq. MHz	Reading dBuv	Ant. Fac. dB/m	Pre. Fac. dB	Cab. Loss dB	Measured dBuv/m	Limit dBuv/m	Margin dB	Remark	Pol.
4960.00	54.44	33.26	35.14	3.98	56.54	74.00	-17.46	Peak	Horizontal
4960.00	42.00	33.26	35.14	3.98	44.10	54.00	-9.90	Average	Horizontal
12400.00	50.25	33.36	35.16	4.00	52.45	74.00	-21.55	Peak	Horizontal
12400.00	42.12	33.36	35.16	4.00	44.32	54.00	-9.68	Average	Horizontal
4960.00	59.75	33.26	35.14	3.98	61.85	74.00	-12.15	Peak	Vertical
4960.00	42.54	33.26	35.14	3.98	44.64	54.00	-9.36	Average	Vertical
12400.00	57.05	33.36	35.16	4.00	59.25	74.00	-14.75	Peak	Vertical
12400.00	43.09	33.36	35.16	4.00	45.29	54.00	-8.71	Average	Vertical

Notes:

- 1). Measuring frequencies from 9k~10th harmonic or 26.5GHz (which is less), No emission found between lowest internal used/generated frequency to 30MHz.
- 2). Radiated emissions measured in frequency range from 9k~10th harmonic or 26.5GHz (which is less) were made with an instrument using Peak detector mode.
- 3). Data of measurement within this frequency range shown " --- " in the table above means the reading of emissions are attenuated more than 20dB below the permissible limits or the field strength is too small to be measured.

5.6. Conducted Spurious Emissions and Band Edges Test

5.6.1. Standard Applicable

According to §15.247 (d): In any 100 kHz bandwidth outside the frequency band in which the spread spectrum or digitally modulated intentional radiator is operating, the radio frequency power that is produced by the intentional radiator shall be at least 20 dB below that in the 100 kHz bandwidth within the band that contains the highest level of the desired power, based on either an RF conducted or a radiated measurement. Attenuation below the general limits specified in Section 15.209(a) is not required. In addition, radiated emissions which fall in the restricted bands, as defined in Section 15.205(a), must also comply with the radiated emission limits specified in Section 15.209(a) (see Section 15.205(c)).

5.6.2. Measuring Instruments and Setting

Please refer to section 6 of equipment list in this report. The following table is the setting of the spectrum analyzer.

Spectrum Parameter	Setting
Detector	Peak
Attenuation	Auto
RB / VB (Emission in restricted band)	100KHz/300KHz
RB / VB (Emission in non-restricted band)	100KHz/300KHz

5.6.3. Test Procedures

The transmitter output is connected to a spectrum analyzer. The resolution bandwidth is set to 100 kHz. The video bandwidth is set to 300 kHz

The spectrum from 9 kHz to 26.5GHz is investigated with the transmitter set to the lowest, middle, and highest channels.

5.6.4. Test Setup Layout

This test setup layout is the same as that shown in section 5.4.4.

5.6.5. EUT Operation during Test

The EUT was programmed to be in continuously transmitting mode.

5.6.6. Test Results of Conducted Spurious Emissions

Temperature	24.8°C	Humidity	51.2%
Test Engineer	Demi Lin	Configurations	BT LE

Test Mode	Channel	Frequency (MHz)	Spurious RF Conducted Emission (dBc)	Limits (dBc)	Verdict
GFSK - BLE	0	2402	<-20	-20	PASS
	19	2440	<-20		
	39	2480	<-20		

Remark:

1. Measured RF conducted spurious emissions at difference data rate for each mode and recorded worst case for each mode.
2. Test results including cable loss;
3. “---“means that the fundamental frequency not for 15.209 limits requirement.
4. please refer to following plots;

RF Conducted Spurious Emissions

Channel 0 / 2402 MHz

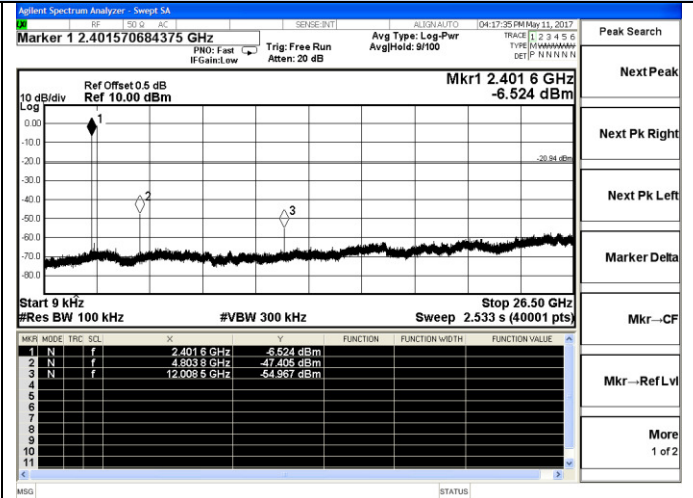
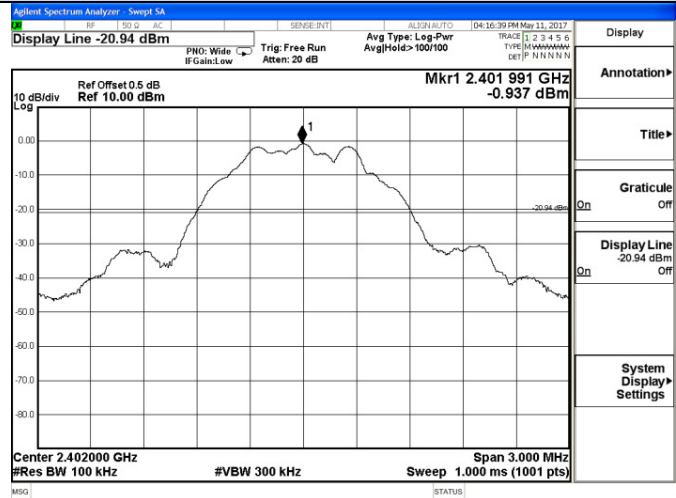

2401 – 2403 MHz

9 KHz – 26.5 GHz

Channel 19 / 2440 MHz

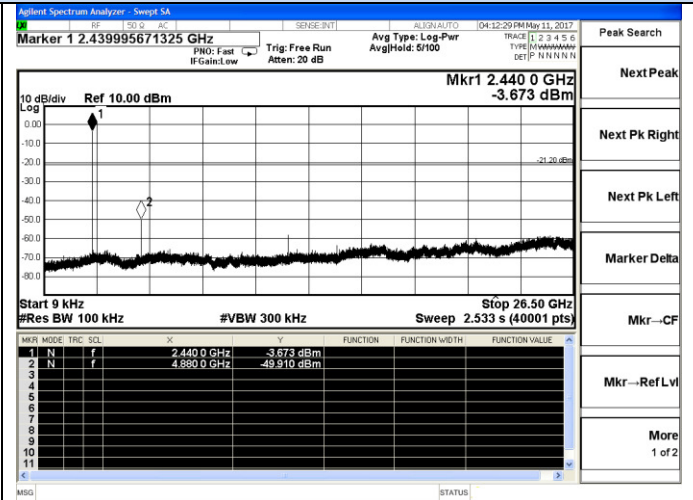
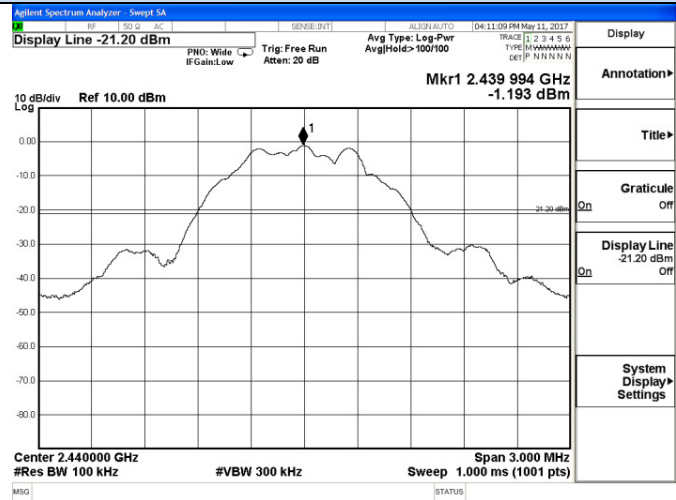

2439 – 2441 MHz

9 KHz – 26.5 GHz

Channel 39 / 2480 MHz

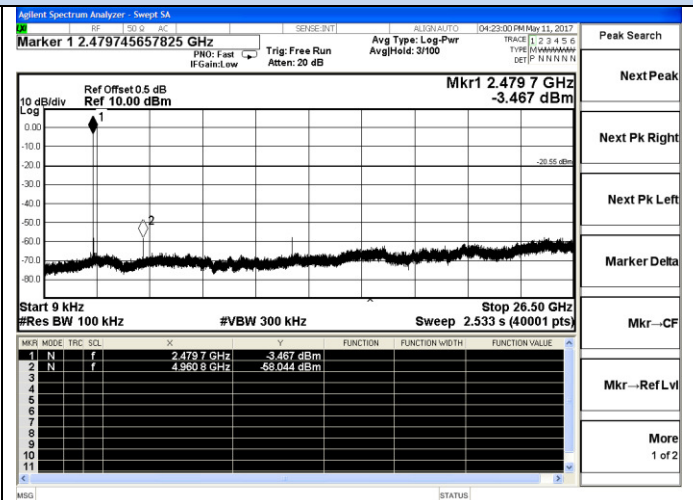
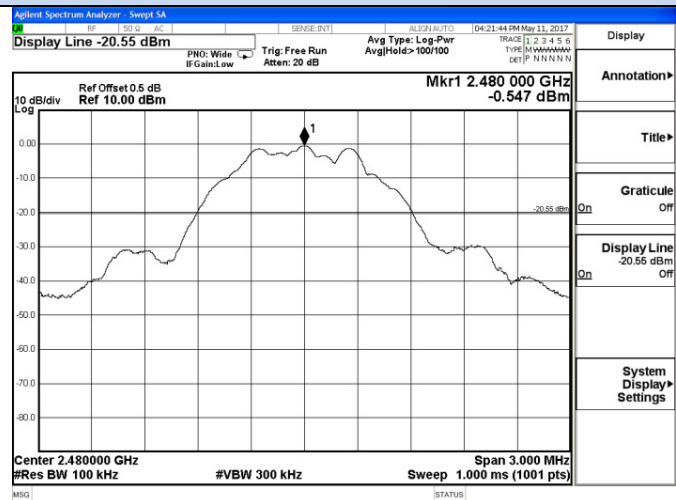

2479 – 2481 MHz

9 KHz – 26.5 GHz

Band-edge measurements for conducted emissions

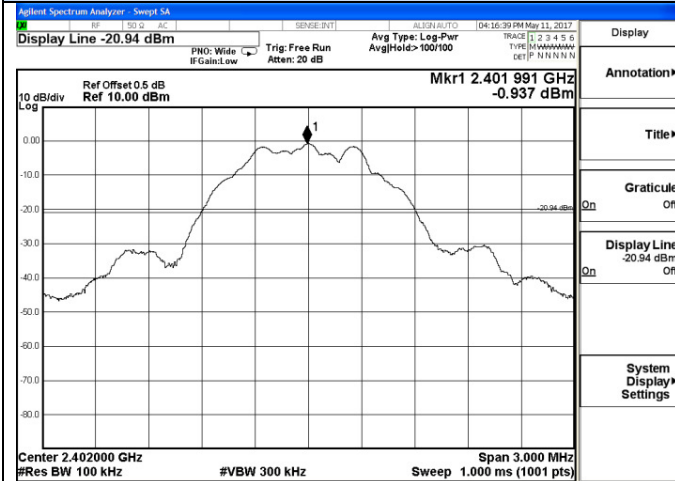

2401 – 2403 MHz

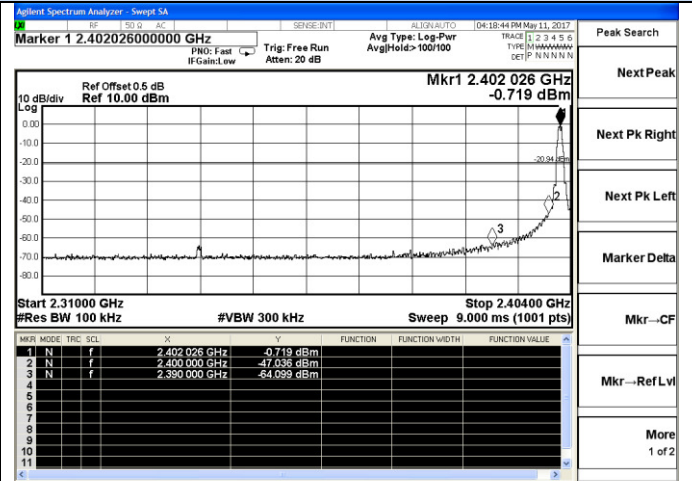

Channel 0 / 2402 MHz



2479 – 2481 MHz

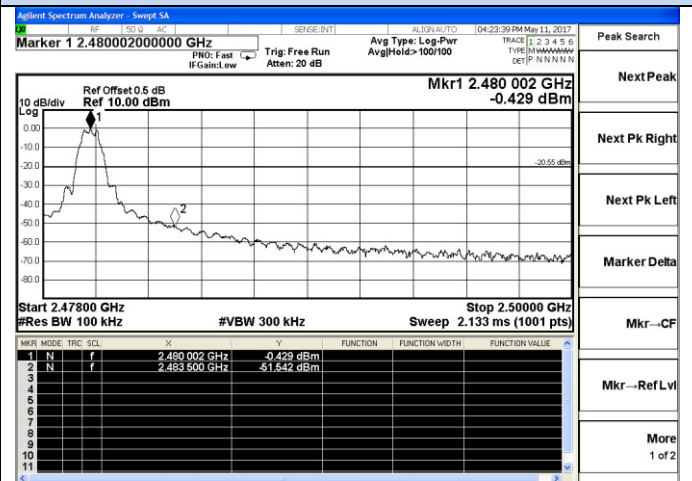

Channel 39 / 2480 MHz

5.7. AC Power line conducted emissions

5.7.1 Standard Applicable

According to §15.207 (a): For an intentional radiator which is designed to be connected to the public utility (AC) power line, the radio frequency voltage that is conducted back onto the AC power line on any frequency or frequencies within the band 150 kHz to 30 MHz shall not exceed 250 microvolts (The limit decreases linearly with the logarithm of the frequency in the range 0.15 MHz to 0.50 MHz). The limits at specific frequency range are listed as follows:

Frequency Range (MHz)	Limits (dBµV)	
	Quasi-peak	Average
0.15 to 0.50	66 to 56	56 to 46
0.50 to 5	56	46
5 to 30	60	50

* Decreasing linearly with the logarithm of the frequency

5.7.2 Block Diagram of Test Setup

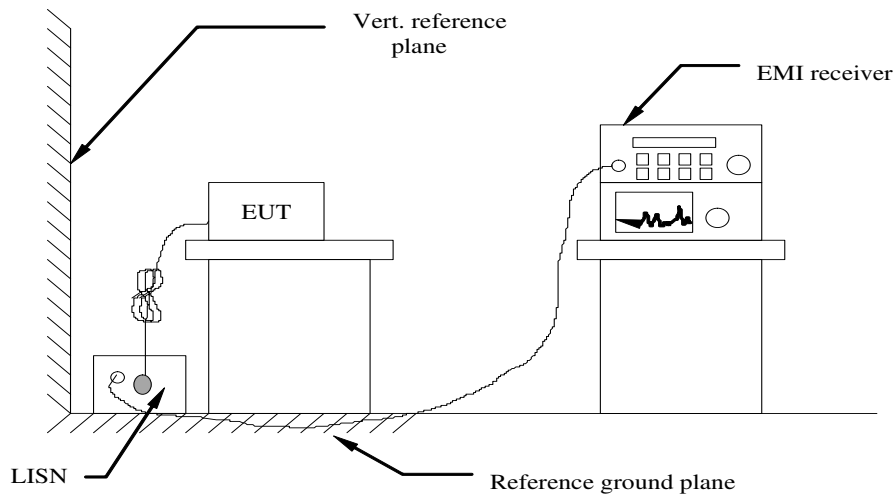

5.7.3 Test Results

PASS

The test data please refer to following page.

AC Conducted Emission of power adapter @ AC 120V/60Hz (worst case)

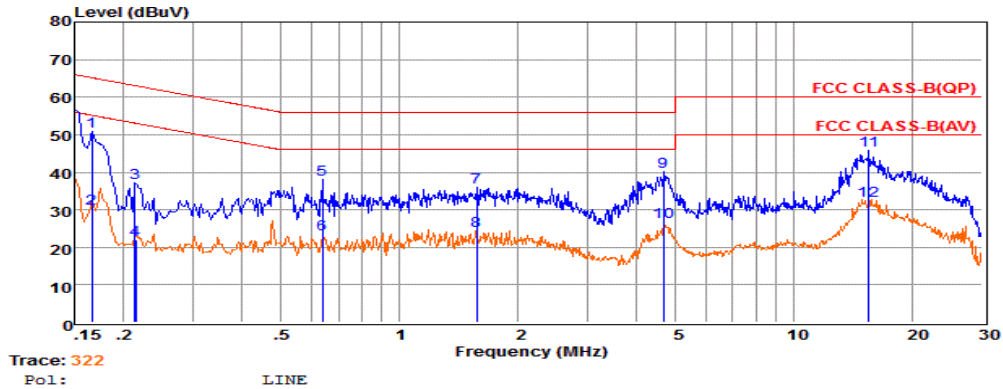

Line	Freq MHz	Reading dBuV	LISNFac dB	CabLos dB	Aux2Fac dB	Measured dB	Limit dBuV	Over dBuV	Remark
1	0.17	31.33	9.59	0.02	10.00	50.94	65.16	-14.22	QP
2	0.17	10.65	9.59	0.02	10.00	30.26	55.16	-24.90	Average
3	0.21	17.58	9.63	0.03	10.00	37.24	63.05	-25.81	QP
4	0.21	2.28	9.63	0.03	10.00	21.94	53.05	-31.11	Average
5	0.64	18.32	9.63	0.04	10.00	37.99	56.00	-18.01	QP
6	0.64	3.70	9.63	0.04	10.00	23.37	46.00	-22.63	Average
7	1.57	16.15	9.64	0.05	10.00	35.84	56.00	-20.16	QP
8	1.57	4.68	9.64	0.05	10.00	24.37	46.00	-21.63	Average
9	4.67	20.30	9.65	0.06	10.00	40.01	56.00	-15.99	QP
10	4.67	6.98	9.65	0.06	10.00	26.69	46.00	-19.31	Average
11	15.47	25.99	9.71	0.10	10.00	45.80	60.00	-14.20	QP
12	15.47	12.65	9.71	0.10	10.00	32.46	50.00	-17.54	Average

Remarks: 1. Measured = Reading +Cable Loss +Aux2 Fac.
2. The emission levels that are 20dB below the official limit are not reported.

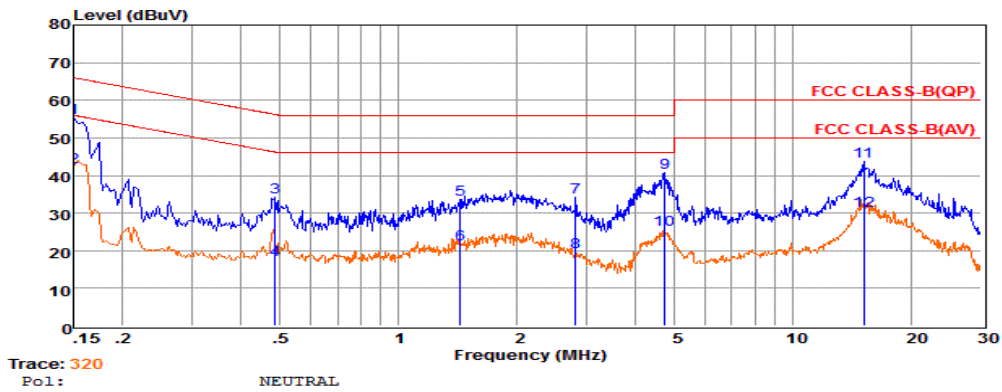

Line	Freq MHz	Reading dBuV	LISNFac dB	CabLos dB	Aux2Fac dB	Measured dB	Limit dBuV	Over dBuV	Remark
1	0.15	35.48	9.70	0.02	10.00	55.20	66.00	-10.80	QP
2	0.15	22.51	9.70	0.02	10.00	42.23	55.99	-13.76	Average
3	0.49	14.45	9.62	0.04	10.00	34.11	56.23	-22.12	QP
4	0.49	-2.02	9.62	0.04	10.00	17.64	46.23	-28.59	Average
5	1.43	13.97	9.63	0.05	10.00	33.65	56.00	-22.35	QP
6	1.43	1.90	9.63	0.05	10.00	21.58	46.00	-24.42	Average
7	2.81	14.45	9.64	0.05	10.00	34.14	56.00	-21.86	QP
8	2.81	0.00	9.64	0.05	10.00	19.69	46.00	-26.31	Average
9	4.75	21.11	9.66	0.06	10.00	40.83	56.00	-15.17	QP
10	4.75	6.00	9.66	0.06	10.00	25.72	46.00	-20.28	Average
11	15.15	23.76	9.74	0.10	10.00	43.60	60.00	-16.40	QP
12	15.15	10.90	9.74	0.10	10.00	30.74	50.00	-19.26	Average

Remarks: 1. Measured = Reading +Cable Loss +Aux2 Fac.
2. The emission levels that are 20dB below the official limit are not reported.

AC Conducted Emission of power adapter @ AC 240V/50Hz (worst case)

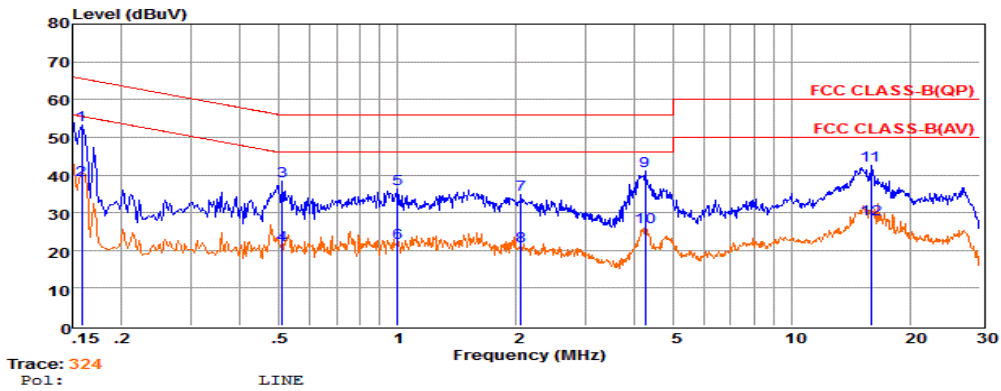

	Freq	Reading	LISNFac	CabLos	Aux2Fac	Measured	Limit	Over	Remark
	MHz	dBuV	dB	dB	dB	dB	dBuV	dBuV	dB
1	0.16	33.59	9.58	0.02	10.00	53.19	65.56	-12.37	QP
2	0.16	19.02	9.58	0.02	10.00	38.62	55.55	-16.93	Average
3	0.51	18.84	9.62	0.04	10.00	38.50	56.00	-17.50	QP
4	0.51	1.61	9.62	0.04	10.00	21.27	46.00	-24.73	Average
5	1.00	16.51	9.63	0.05	10.00	36.19	56.00	-19.81	QP
6	1.00	2.19	9.63	0.05	10.00	21.87	46.00	-24.13	Average
7	2.05	15.22	9.64	0.05	10.00	34.91	56.00	-21.09	QP
8	2.06	1.56	9.64	0.05	10.00	21.25	46.00	-24.75	Average
9	4.25	21.26	9.65	0.06	10.00	40.97	56.00	-15.03	QP
10	4.25	6.51	9.65	0.06	10.00	26.22	46.00	-19.78	Average
11	15.89	22.55	9.72	0.11	10.00	42.38	60.00	-17.62	QP
12	15.89	8.48	9.72	0.11	10.00	28.31	50.00	-21.69	Average

Remarks: 1. Measured = Reading +Cable Loss +Aux2 Fac.
2. The emission levels that are 20dB below the official limit are not reported.

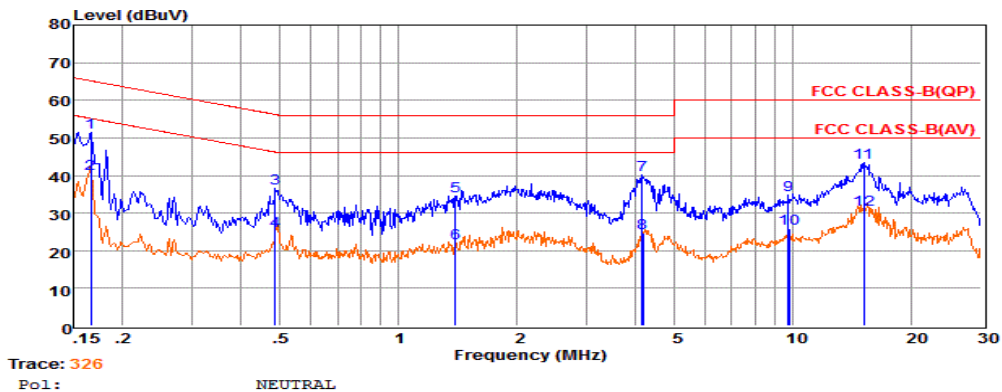

	Freq	Reading	LISNFac	CabLos	Aux2Fac	Measured	Limit	Over	Remark
	MHz	dBuV	dB	dB	dB	dB	dBuV	dBuV	dB
1	0.17	31.86	9.66	0.02	10.00	51.54	65.16	-13.62	QP
2	0.17	20.65	9.66	0.02	10.00	40.33	55.16	-14.83	Average
3	0.49	17.06	9.62	0.04	10.00	36.72	56.23	-19.51	QP
4	0.49	5.63	9.62	0.04	10.00	25.29	46.23	-20.94	Average
5	1.40	14.91	9.63	0.05	10.00	34.59	56.00	-21.41	QP
6	1.40	2.47	9.63	0.05	10.00	22.15	46.00	-23.85	Average
7	4.16	20.56	9.65	0.06	10.00	40.27	56.00	-15.73	QP
8	4.16	5.04	9.65	0.06	10.00	24.75	46.00	-21.25	Average
9	9.76	14.89	9.72	0.08	10.00	34.69	60.00	-25.31	QP
10	9.76	6.21	9.72	0.08	10.00	26.01	50.00	-23.99	Average
11	15.15	23.50	9.74	0.10	10.00	43.34	60.00	-16.66	QP
12	15.15	11.12	9.74	0.10	10.00	30.96	50.00	-19.04	Average

Remarks: 1. Measured = Reading +Cable Loss +Aux2 Fac.
2. The emission levels that are 20dB below the official limit are not reported.

5.8. Band-edge measurements for radiated emissions

5.8.1 Standard Applicable

In any 100 kHz bandwidth outside the frequency band in which the spread spectrum or digitally modulated intentional radiator is operating, the radio frequency power that is produced by the intentional radiator shall be at least 20 dB below that in the 100 kHz bandwidth within the band that contains the highest level of the desired power, based on either an RF conducted or a radiated measurement, provided the transmitter demonstrates compliance with the peak conducted power limits. If the transmitter complies with the conducted power limits based on the use of RMS averaging over a time interval, as permitted under paragraph (b)(3) of this section, the attenuation required under this paragraph shall be 30 dB instead of 20 dB. Attenuation below the general limits specified in §15.209(a) is not required. In addition, radiated emissions which fall in the restricted bands, as defined in §15.205(a), must also comply with the radiated emission limits specified in §15.209(a) (see §15.205(c)).

5.8.2. Test Setup Layout

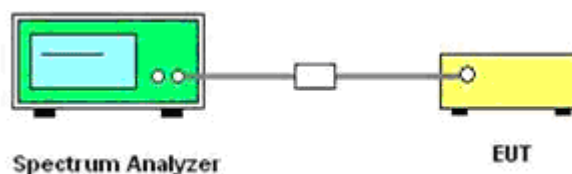

5.8.3. Measuring Instruments and Setting

Please refer to section 6 of equipment list in this report. The following table is the setting of Spectrum Analyzer.

5.8.4. Test Procedures

According to KDB 558074 D01 V03 for Antenna-port conducted measurement. Antenna-port conducted measurements may also be used as an alternative to radiated measurements for demonstrating compliance in the restricted frequency bands. If conducted measurements are performed, then proper impedance matching must be ensured and an additional radiated test for cabinet/case spurious emissions is required.

1. Check the calibration of the measuring instrument using either an internal calibrator or a known signal from an external generator.
2. Remove the antenna from the EUT and then connect to a low loss RF cable from the antenna port to a EMI test receiver, then turn on the EUT and make it operate in transmitting mode. Then set it to Low Channel and High Channel within its operating range, and make sure the instrument is operated in its linear range.
3. Set both RBW and VBW of spectrum analyzer to 100 kHz with a convenient frequency span including 100kHz bandwidth from band edge, for Radiated emissions restricted band RBW=1MHz, VBW=3MHz for peak detector and RBW=1MHz, VBW=1/B for Peak detector.
4. Measure the highest amplitude appearing on spectral display and set it as a reference level. Plot the graph with marking the highest point and edge frequency.
5. Repeat above procedures until all measured frequencies were complete.
6. Measure the conducted output power (in dBm) using the detector specified by the appropriate regulatory agency (see 12.2.2, 12.2.3, and 12.2.4 for guidance regarding measurement procedures for determining quasi-peak, peak, and average conducted output power, respectively).
7. Add the maximum transmit antenna gain (in dBi) to the measured output power level to determine the EIRP level (see 12.2.5 for guidance on determining the applicable antenna gain)
8. Add the appropriate maximum ground reflection factor to the EIRP level (6 dB for frequencies ≤ 30 MHz, 4.7 dB for frequencies between 30 MHz and 1000 MHz, inclusive and 0 dB for frequencies > 1000 MHz).

9. For devices with multiple antenna-ports, measure the power of each individual chain and sum the EIRP of all chains in linear terms (e.g., Watts, mW).
10. Convert the resultant EIRP level to an equivalent electric field strength using the following relationship:
 $E = \text{EIRP} - 20\log D + 104.8$

Where:

E = electric field strength in dB μ V/m,

EIRP = equivalent isotropic radiated power in dBm

D = specified measurement distance in meters.

11. Since the out-of-band characteristics of the EUT transmit antenna will often be unknown, the use of a conservative antenna gain value is necessary. Thus, when determining the EIRP based on the measured conducted power, the upper bound on antenna gain for a device with a single RF output shall be selected as the maximum in-band gain of the antenna across all operating bands, or 2 dBi, whichever is greater. However, for devices that operate in multiple frequency bands while using the same transmit antenna, the highest gain of the antenna within the operating band nearest in frequency to the restricted band emission being measured may be used in lieu of the overall highest gain when the emission is at a frequency that is within 20 percent of the nearest band edge frequency, but in no case shall a value less than 2 dBi be used.
12. Compare the resultant electric field strength level to the applicable regulatory limit.
13. Perform radiated spurious emission test duress until all measured frequencies were complete.

5.8.5 Test Results

GFSK – BLE							
Frequency (MHz)	Conducted Power (dBm)	Antenna Gain (dBi)	Ground Reflection Factor (dB)	Covert Radiated E Level At 3m (dBuV/m)	Detector	Limit (dBuV/m)	Verdict
2310.00	-60.924	2.71	0.00	36.986	Peak	74.00	PASS
2310.00	-72.755	2.71	0.00	25.155	AV	54.00	PASS
2390.00	-47.045	2.71	0.00	50.865	Peak	74.00	PASS
2390.00	-72.174	2.71	0.00	25.736	AV	54.00	PASS
2483.50	-32.847	2.71	0.00	65.063	Peak	74.00	PASS
2483.50	-70.835	2.71	0.00	27.075	AV	54.00	PASS
2500.00	-51.256	2.71	0.00	46.654	Peak	74.00	PASS
2500.00	-72.207	2.71	0.00	25.703	AV	54.00	PASS

Remark:

1. Test results including cable loss;
2. “---“means that the fundamental frequency not for 15.209 limits requirement.
3. Average Values = Average Reading Values - Duty Cycle Factor
4. please refer to following plots;

Band-edge measurements for radiated emissions

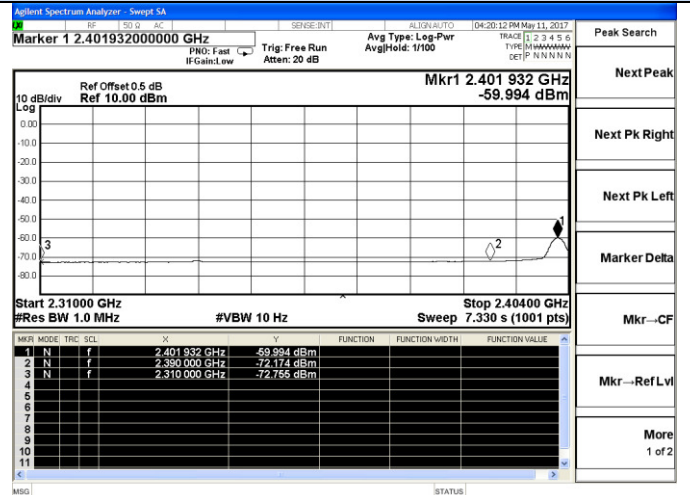
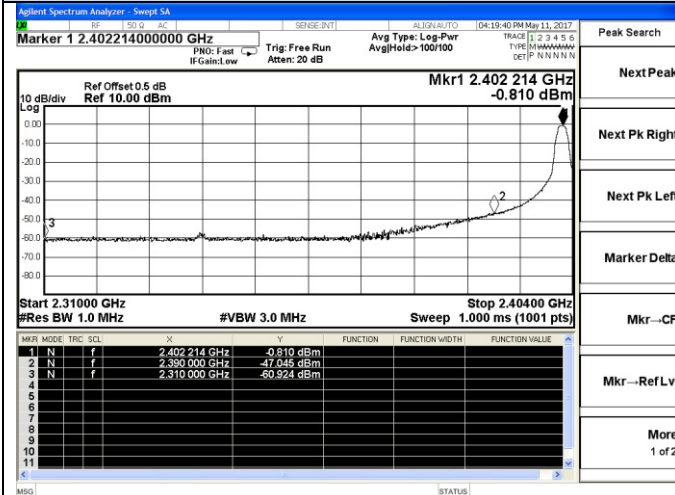

Channel 0 / 2402 MHz – Peak

Channel 0 / 2402 MHz – Average

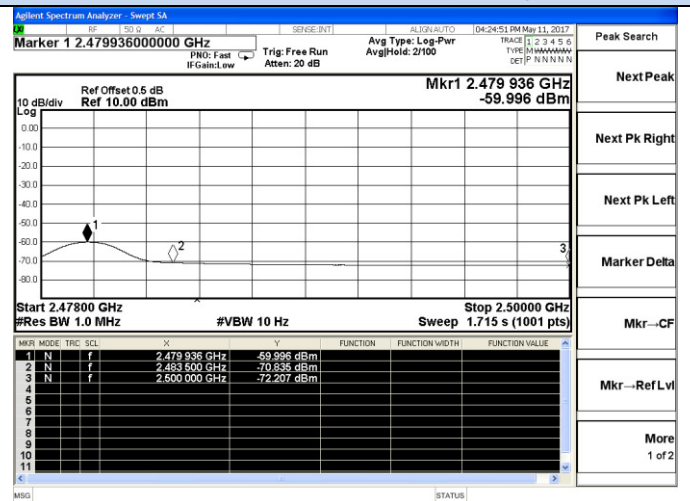
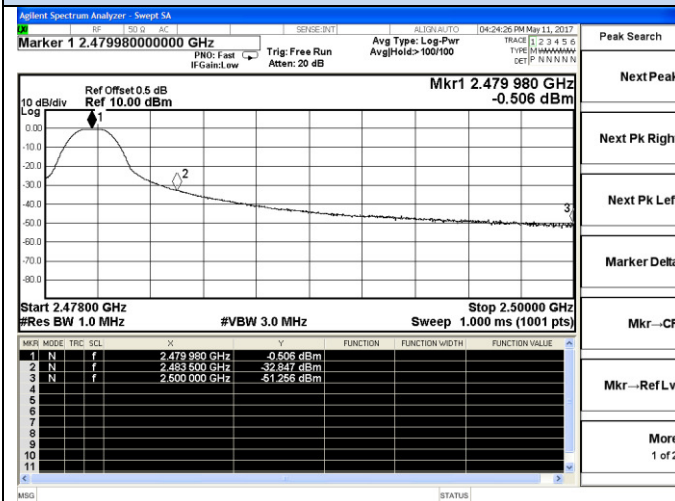

Channel 39 / 2480 MHz – Peak

Channel 39 / 2480 MHz – Average

5.9. Antenna Requirements

5.9.1 Standard Applicable

According to antenna requirement of §15.203.

An intentional radiator shall be designed to ensure that no antenna other than that furnished by the responsible party shall be used with the device. The use of a permanently attached antenna or of an antenna that uses a unique coupling to the intentional radiator shall be considered sufficient to comply with the provisions of this Section. The manufacturer may design the unit so that a broken antenna can be re-placed by the user, but the use of a standard antenna jack or electrical connector is prohibited. This requirement does not apply to carrier current devices or to devices operated under the provisions of Sections 15.211, 15.213, 15.217, 15.219, or 15.221. Further, this requirement does not apply to intentional radiators that must be professionally installed, such as perimeter protection systems and some field disturbance sensors, or to other intentional radiators which, in accordance with Section 15.31(d), must be measured at the installation site. However, the installer shall be responsible for ensuring that the proper antenna is employed so that the limits in this Part are not exceeded.

And according to §15.247(4)(1), system operating in the 2400-2483.5MHz bands that are used exclusively for fixed, point-to-point operations may employ transmitting antennas with directional gain greater than 6dBi provided the maximum peak output power of the intentional radiator is reduced by 1 dB for every 3 dB that the directional gain of the antenna exceeds 6dBi.

5.9.2 Antenna Connected Construction

5.9.2.1. Standard Applicable

According to § 15.203, an intentional radiator shall be designed to ensure that no antenna other than that furnished by the responsible party shall be used with the device.

5.9.2.2. Antenna Connector Construction

The directional gains of antenna used for transmitting is 2.71 dBi, and the antenna is an internal antenna connect to PCB board and no consideration of replacement. Please see EUT photo for details.

5.9.2.3. Results: Compliance.

Measurement

The antenna gain of the complete system is calculated by the difference of radiated power in EIRP and the conducted power of the module.

Conducted power refers ANSI C63.10:2013 Output power test procedure for DTS devices.

Radiated power refers to ANSI C63.10:2013 Radiated emissions tests.

Measurement parameters

Measurement parameter	
Detector:	Peak
Sweep Time:	Auto
Resolution bandwidth:	1MHz
Video bandwidth:	3MHz
Trace-Mode:	Max hold

Limits

FCC	IC
Antenna Gain	
6 dBi	

Note: The antenna gain of the complete system is calculated by the difference of radiated power in EIRP and the conducted power of the module.

T _{nom}	V _{nom}	Lowest Channel 2402 MHz	Middle Channel 2440 MHz	Highest Channel 2480 MHz
Conducted power [dBm] Measured with GFSK modulation		-2.870	-2.987	-3.272
Radiated power [dBm] Measured with GFSK modulation		-0.528	-0.829	-0.621
Gain [dBi] Calculated		2.342	2.158	2.651
Measurement uncertainty			± 1.6 dB (cond.) / ± 3.8 dB (rad.)	

6. LIST OF MEASURING EQUIPMENTS

Instrument	Manufacturer	Model No.	Serial No.	Characteristics	Cal Date	Due Date
EMC Receiver	R&S	ESCS 30	100174	9kHz – 2.75GHz	June 18, 2016	June 17, 2017
Signal analyzer	Agilent	E4448A(External mixers to 40GHz)	US44300469	9kHz~40GHz	July 16, 2016	July 15, 2017
Signal analyzer	Agilent	N9020A	MY50510140	9kHz~26.5GHz	October 27, 2016	October 27, 2017
LISN	MESS Tec	NNB-2/16Z	99079	9KHz-30MHz	June 18, 2016	June 17, 2017
LISN (Support Unit)	EMCO	3819/2NM	9703-1839	9KHz-30MHz	June 18, 2016	June 17, 2017
RF Cable-CON	UTIFLEX	3102-26886-4	CB049	9KHz-30MHz	June 18, 2016	June 17, 2017
ISN	SCHAFFNER	ISN ST08	21653	9KHz-30MHz	June 18, 2016	June 17, 2017
3m Semi Anechoic Chamber	SIDT FRANKONIA	SAC-3M	03CH03-HY	30M-18GHz 3m	June 18, 2016	June 17, 2017
Amplifier	SCHAFFNER	COA9231A	18667	9kHz-2GHz	June 18, 2016	June 17, 2017
Amplifier	Agilent	8449B	3008A02120	1GHz-26.5GHz	July 16, 2016	July 15, 2017
Amplifier	MITEQ	AMF-6F-260400	9121372	26.5GHz-40GHz	July 16, 2016	July 15, 2017
Loop Antenna	R&S	HFH2-Z2	860004/001	9k-30MHz	June 18, 2016	June 17, 2017
By-log Antenna	SCHWARZBECK	VULB9163	9163-470	30MHz-1GHz	June 10, 2016	June 09, 2017
Horn Antenna	EMCO	3115	6741	1GHz-18GHz	June 10, 2016	June 09, 2017
Horn Antenna	SCHWARZBECK	BBHA9170	BBHA9170154	15GHz-40GHz	June 10, 2016	June 09, 2017
RF Cable-R03m	Jye Bao	RG142	CB021	30MHz-1GHz	June 18, 2016	June 17, 2017
RF Cable-HIGH	SUHNER	SUCOFLEX 106	03CH03-HY	1GHz-40GHz	June 18, 2016	June 17, 2017
Power Meter	R&S	NRVS	100444	DC-40GHz	June 18, 2016	June 17, 2017
Power Sensor	R&S	NRV-Z51	100458	DC-30GHz	June 18, 2016	June 17, 2017
Power Sensor	R&S	NRV-Z32	10057	30MHz-6GHz	June 18, 2016	June 17, 2017
AC Power Source	HPC	HPA-500E	HPA-9100024	AC 0~300V	June 18, 2016	June 17, 2017
DC power Source	GW	GPC-6030D	C671845	DC 1V-60V	June 18, 2016	June 17, 2017
Temp. and Humidity Chamber	Giant Force	GTH-225-20-S	MAB0103-00	N/A	June 18, 2016	June 17, 2017
RF CABLE-1m	JYE Bao	RG142	CB034-1m	20MHz-7GHz	June 18, 2016	June 17, 2017
RF CABLE-2m	JYE Bao	RG142	CB)35-2m	20MHz-1GHz	June 18, 2016	June 17, 2017
EMC Test software	Audix	E3	N/A	N/A	N/A	N/A

Note: All equipment through GRGT EST calibration

7. TEST SETUP PHOTOGRAPHS OF EUT

Please refer to separated files for Test Setup Photos of the EUT.

8. EXTERIOR PHOTOGRAPHS OF THE EUT

Please refer to separated files for External Photos of the EUT.

9. INTERIOR PHOTOGRAPHS OF THE EUT

Please refer to separated files for Internal Photos of the EUT.

-----THE END OF REPORT-----