

LTE Band 40 (Band Width 5MHz, RB Size 1, RB Offset 0)

QPSK

16-QAM

38725

38725

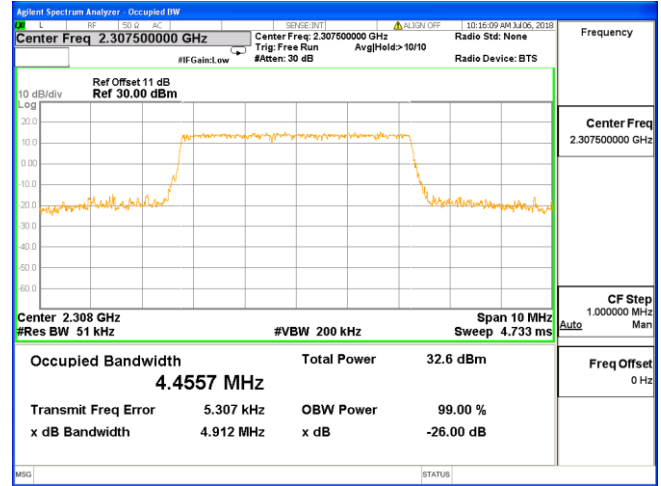
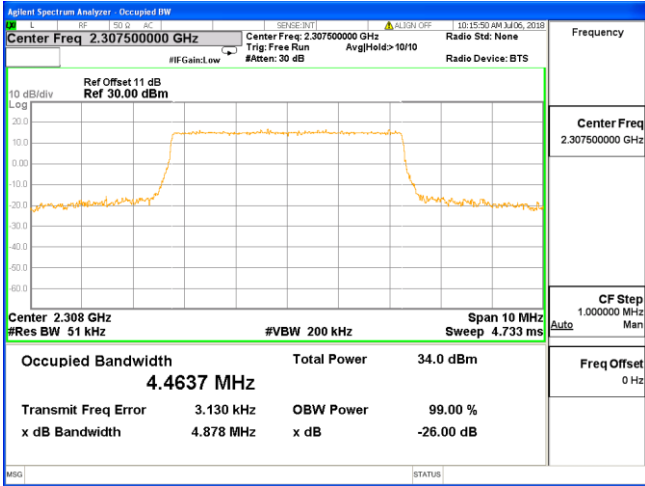

38775

38775

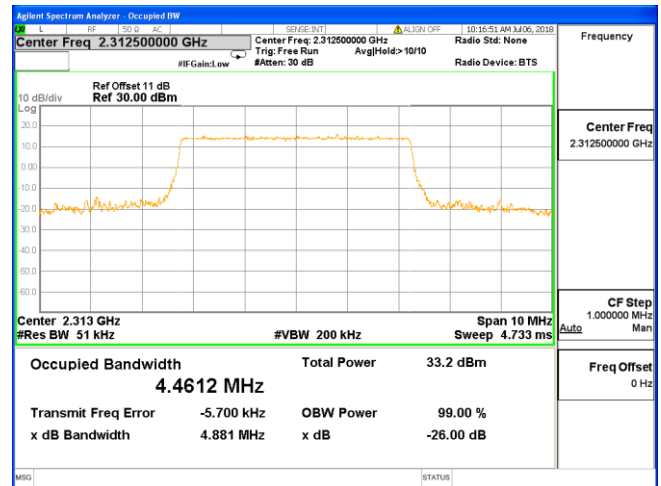
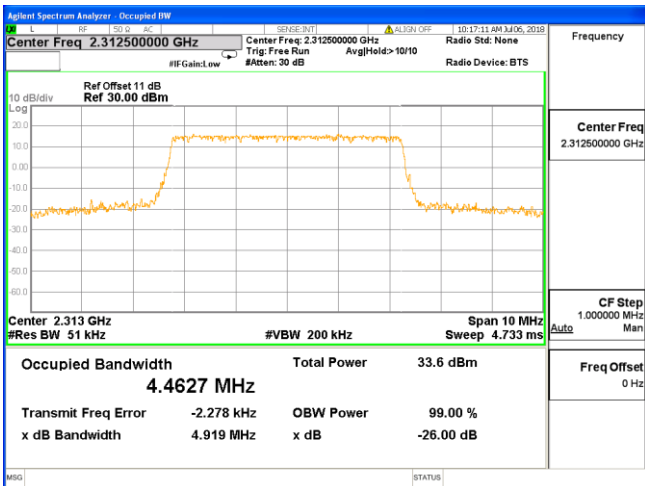

39175

39175

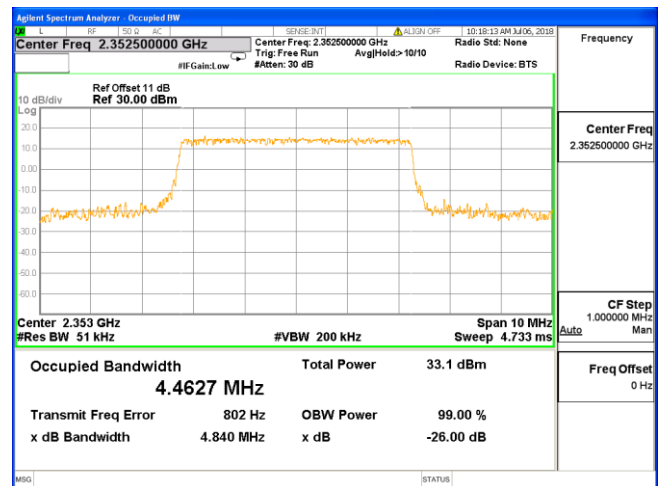
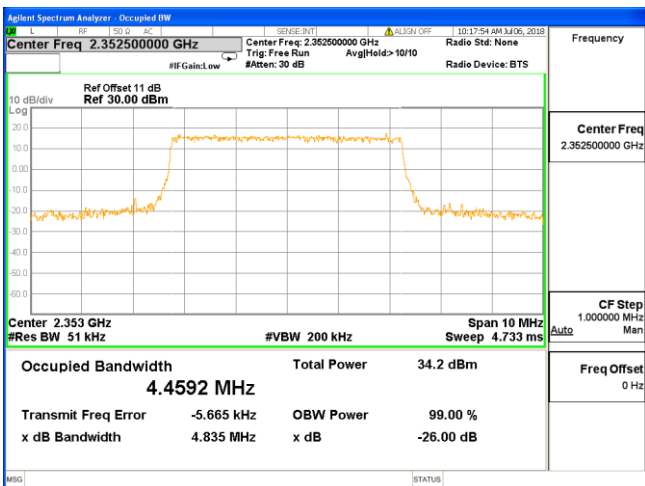

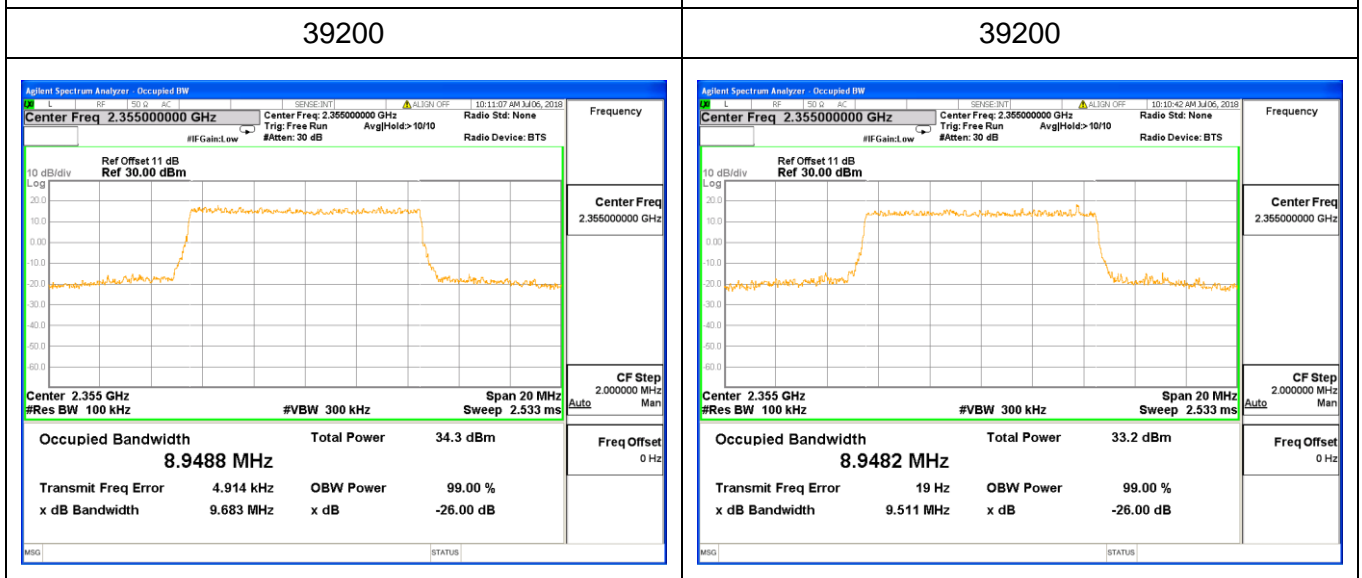
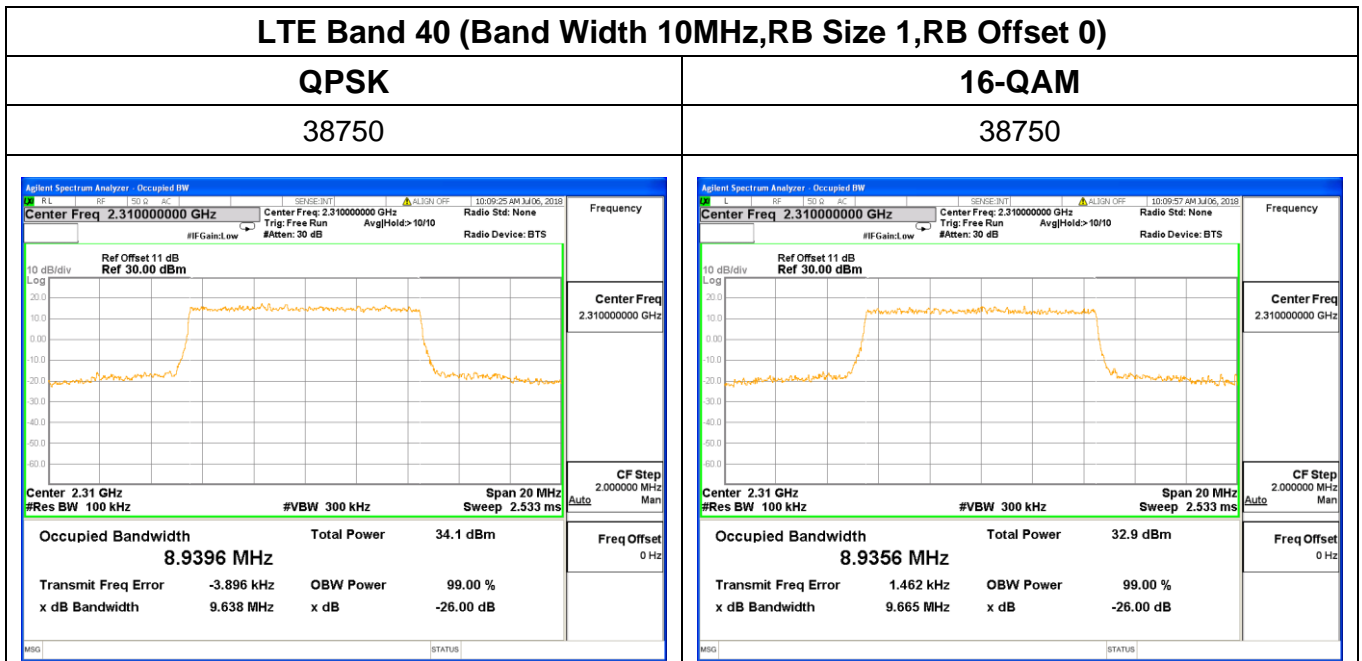
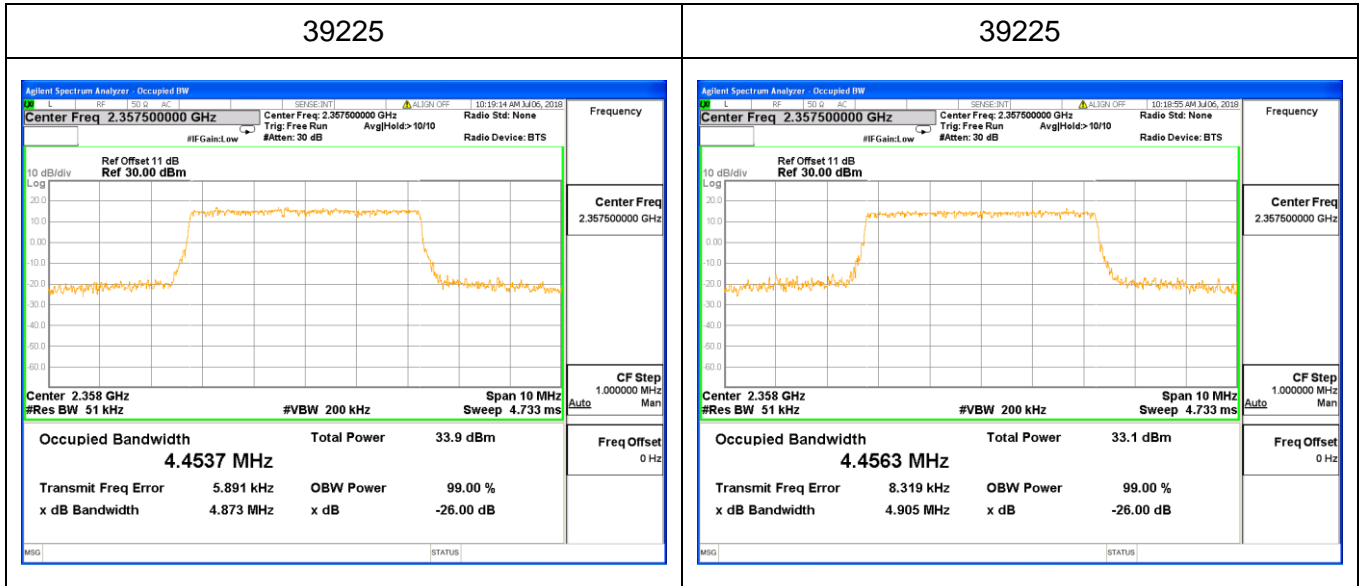

SPURIOUS EMISSIONS AT ANTENNA TERMINALS

5.4.5 Limit

The power of any emission outside a licensee's frequency block shall be attenuated below the transmitter power (P) in watts by at least $43 + 10 \log_{10}(P)$ dB (-13 dBm).

Band7: For mobile digital stations, the attenuation factor shall be not less than $40 + 10 \log(P)$ dB on all frequencies between the channel edge and 5 megahertz from the channel edge, $43 + 10 \log(P)$ dB on all frequencies between 5 megahertz and X megahertz from the channel edge, and $55 + 10 \log(P)$ dB on all frequencies more than X megahertz from the channel edge, where X is the greater of 6 megahertz or the actual emission bandwidth as defined in paragraph (m)(6) of this section. In addition, the attenuation factor shall not be less that $43 + 10 \log(P)$ dB on all frequencies between 2490.5 MHz and 2496 MHz and $55 + 10 \log(P)$ dB at or below 2490.5 MHz.

5.4.6 Test procedure

1. The RF output of the transceiver was connected to a spectrum analyzer through appropriate attenuation.
2. The resolution bandwidth of the spectrum analyzer was set at 100 kHz when below 1GHz, 1MHz when above 1 GHz; sufficient scans were taken to show the out of band Emissions if any up to 10th harmonic.
3. For the out of band: Set the RBW=100 kHz, VBW=300 kHz when below 1 GHz, RBW =1 MHz, VBW=3 MHz when above 1 GHz, Start=30MHz, Stop= 10th harmonic.
4. Band Edge Requirements: In the 1 MHz bands immediately outside and adjacent to the frequency block, a resolution bandwidth of at least 1 percent of the emission bandwidth of the fundamental emission of the transmitter may be employed to measure the out of band Emissions.

5.4.7 Test setup

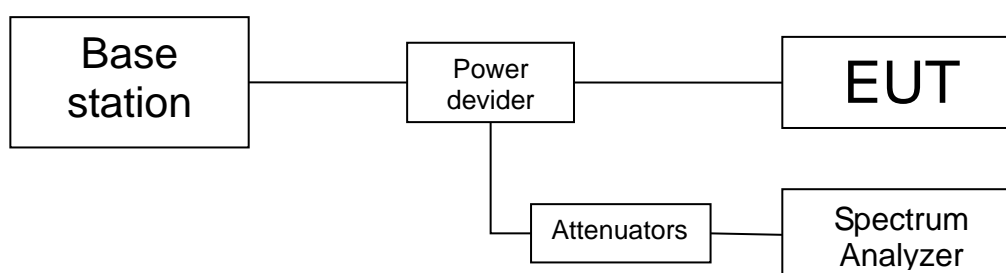

5.4.8 Test results

Note: All mode has been tested, only worst data shown in this report.

Test plots

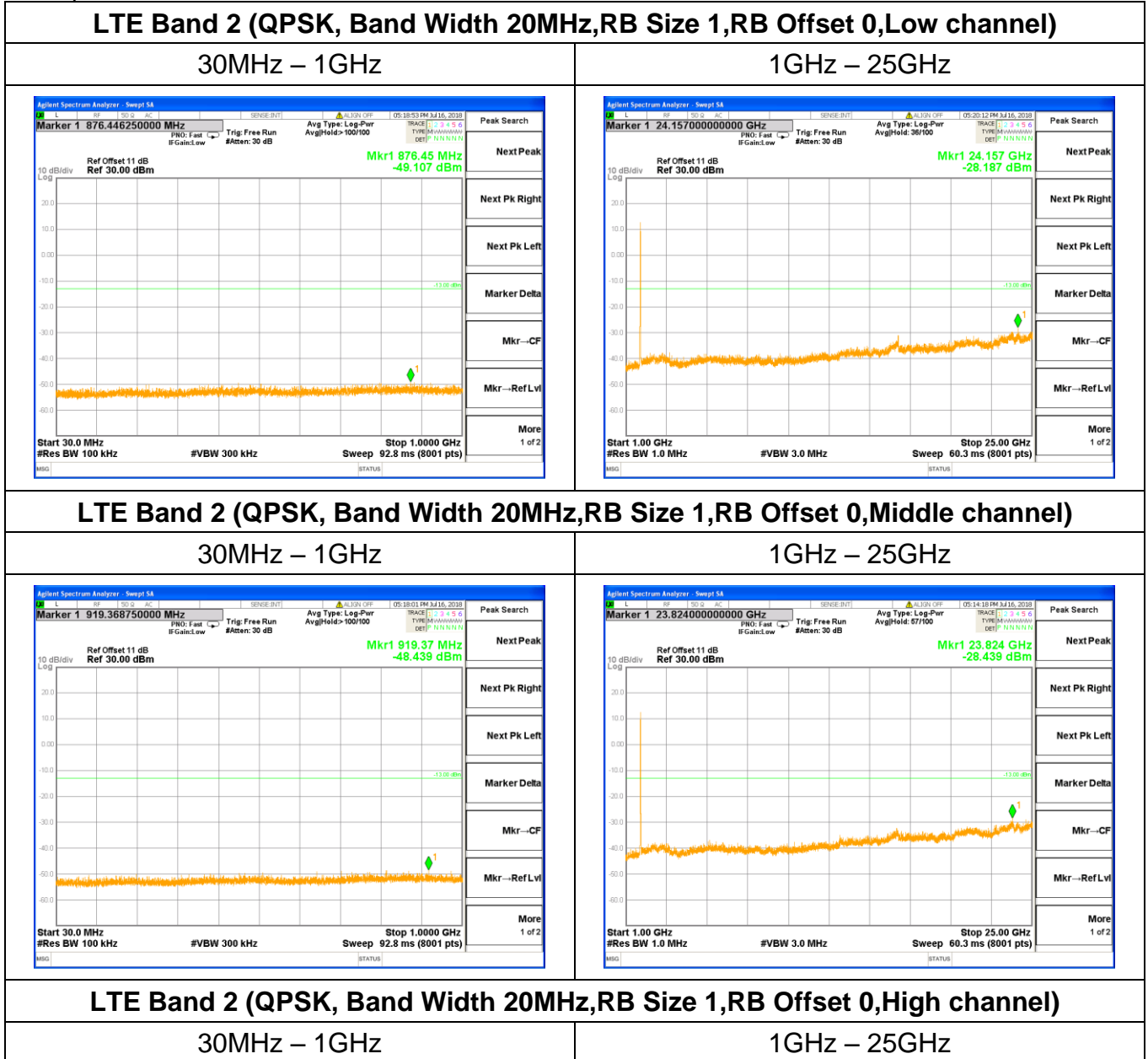

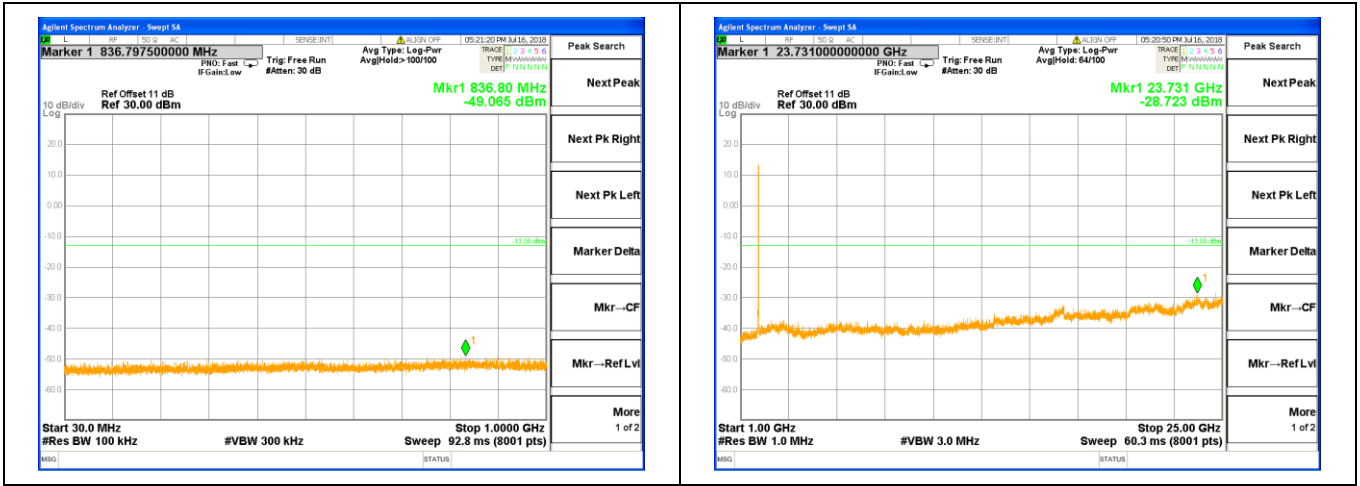

LTE Band 4 (QPSK, Band Width 20MHz, RB Size 1, RB Offset 0, Low channel)

30MHz – 1GHz

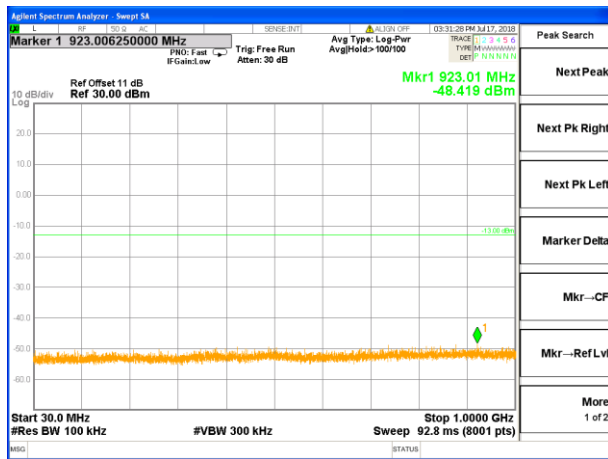

1GHz – 25GHz

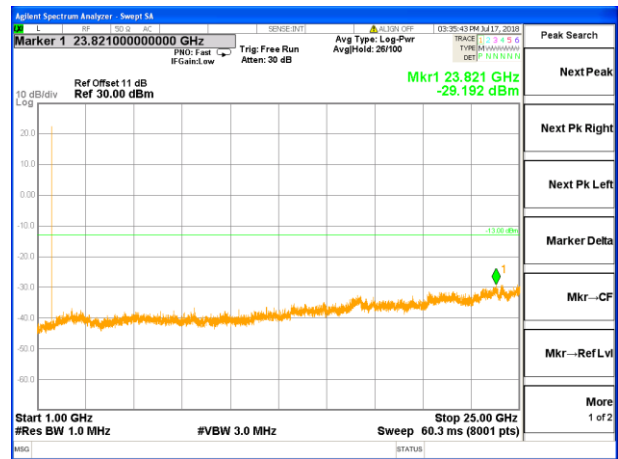

LTE Band 4 (QPSK, Band Width 20MHz, RB Size 1, RB Offset 0, Middle channel)

30MHz – 1GHz

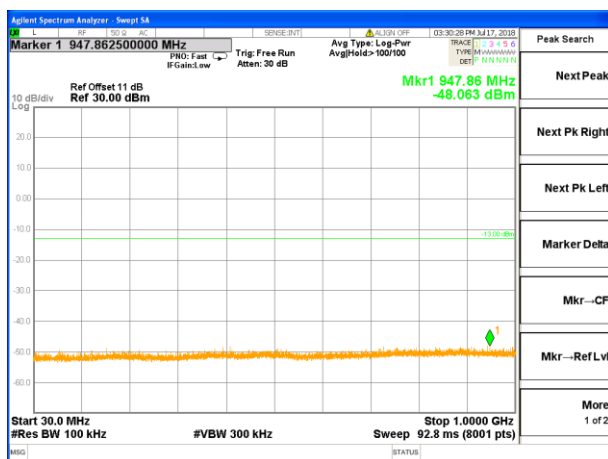

1GHz – 25GHz

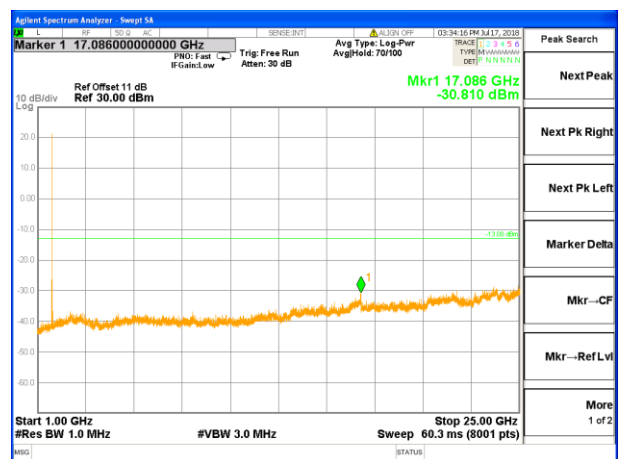

LTE Band 4 (QPSK, Band Width 20MHz, RB Size 1, RB Offset 0, High channel)

30MHz – 1GHz

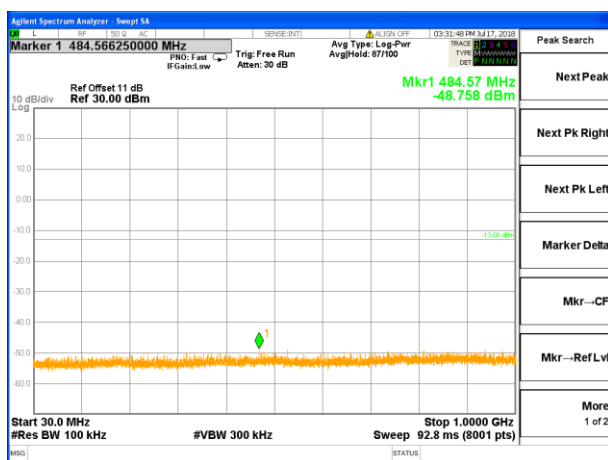

1GHz – 25GHz

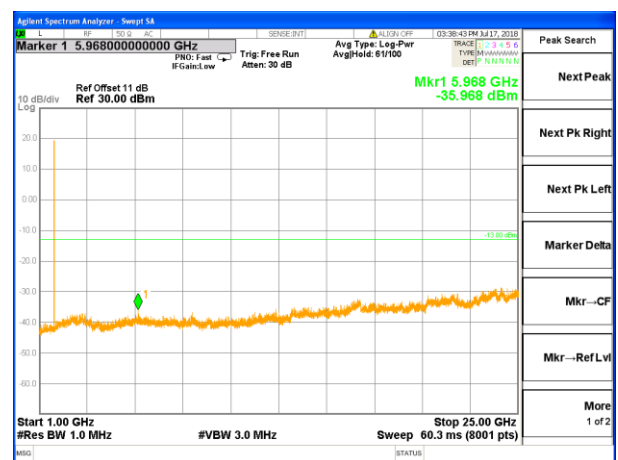

LTE Band 5 (QPSK, Band Width 10MHz, RB Size 1, RB Offset 0, Low channel)

30MHz – 1GHz

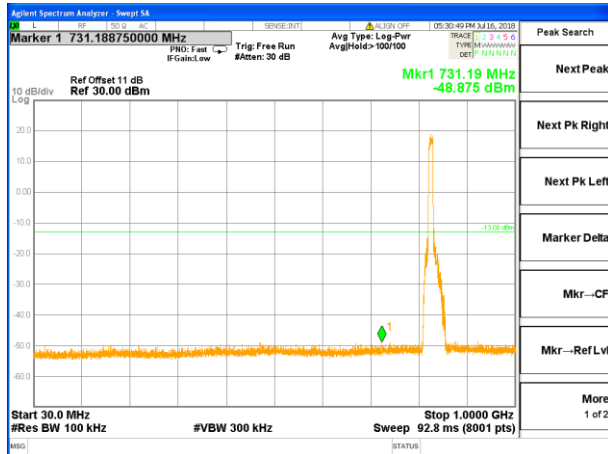

1GHz – 25GHz

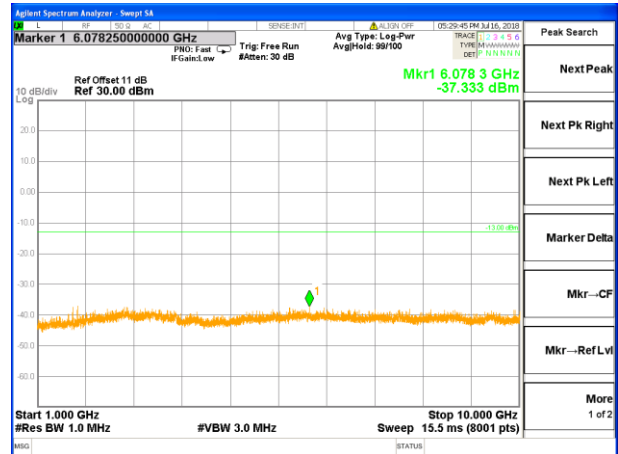

LTE Band 5 (QPSK, Band Width 10MHz, RB Size 1, RB Offset 0, Middle channel)

30MHz – 1GHz

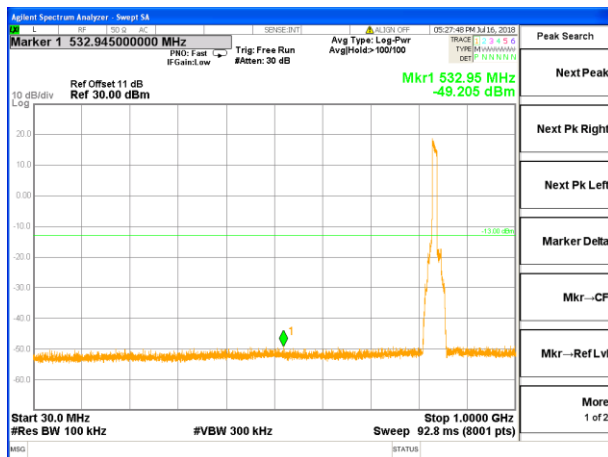

1GHz – 25GHz

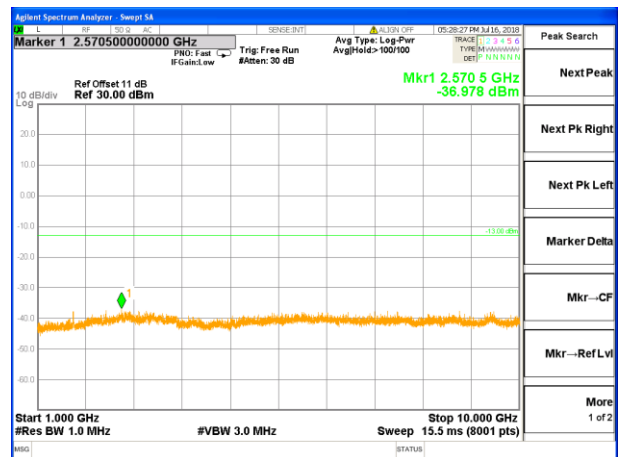

LTE Band 5 (QPSK, Band Width 10MHz, RB Size 1, RB Offset 0, High channel)

30MHz – 1GHz

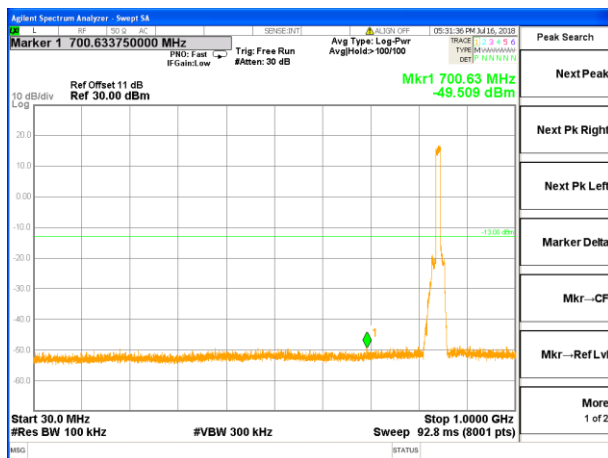

1GHz – 25GHz

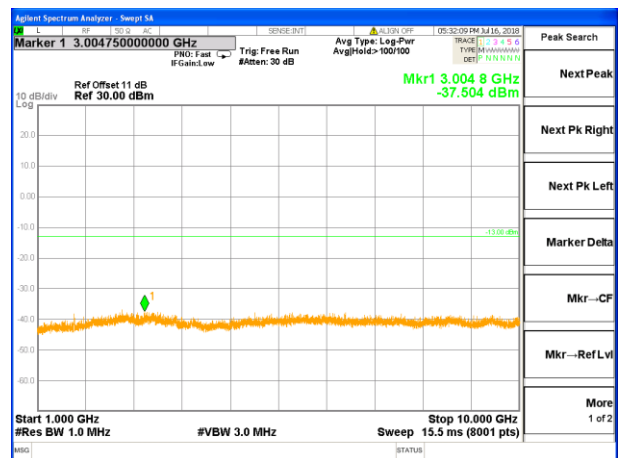

LTE Band 17 (QPSK, Band Width 10MHz, RB Size 1, RB Offset 0, Low channel)

30MHz – 1GHz

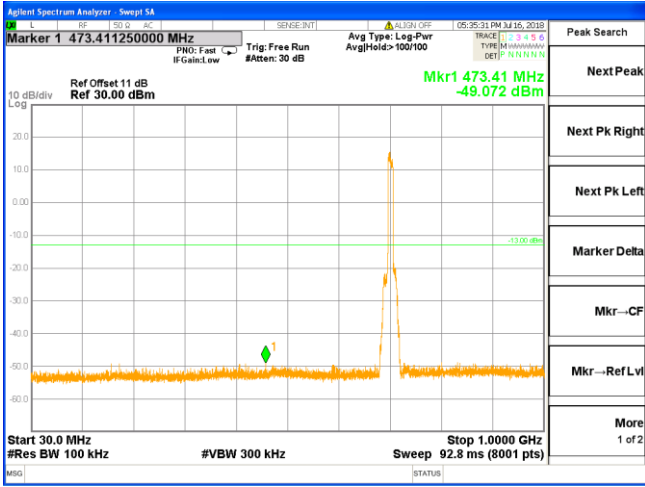

1GHz – 25GHz

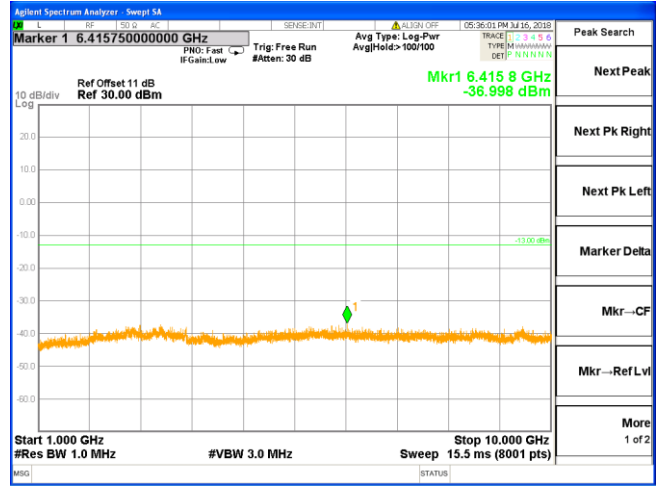

LTE Band 17 (QPSK, Band Width 10MHz, RB Size 1, RB Offset 0, Middle channel)

30MHz – 1GHz

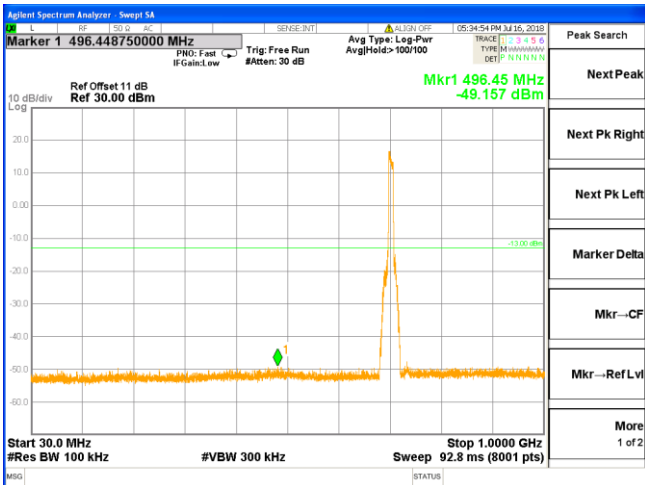

1GHz – 25GHz

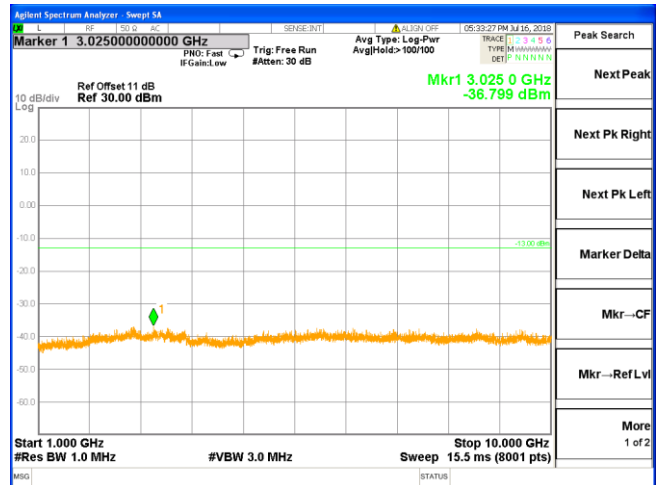

LTE Band 17 (QPSK, Band Width 10MHz, RB Size 1, RB Offset 0, High channel)

30MHz – 1GHz

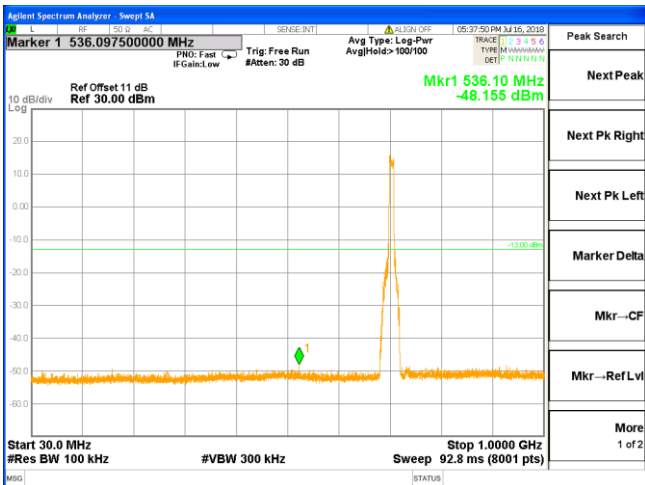

1GHz – 25GHz

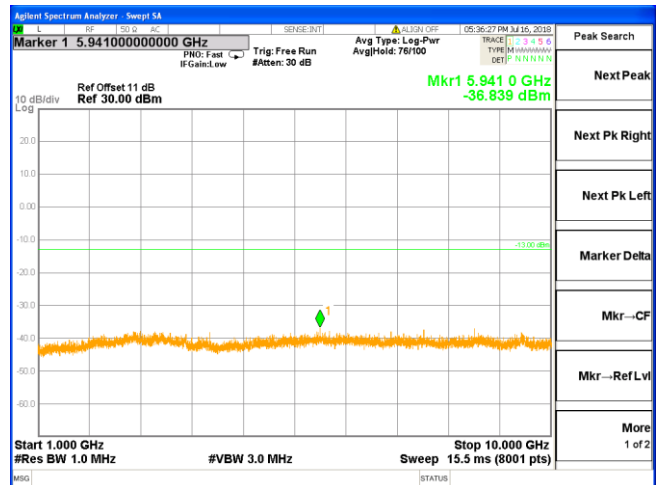

LTE Band 40 (QPSK, Band Width 10MHz, RB Size 1, RB Offset 0, CH38750)

30MHz – 1GHz

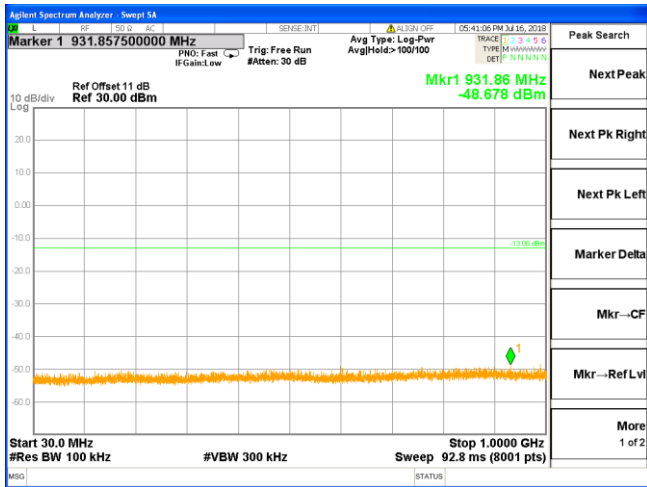

1GHz – 25GHz

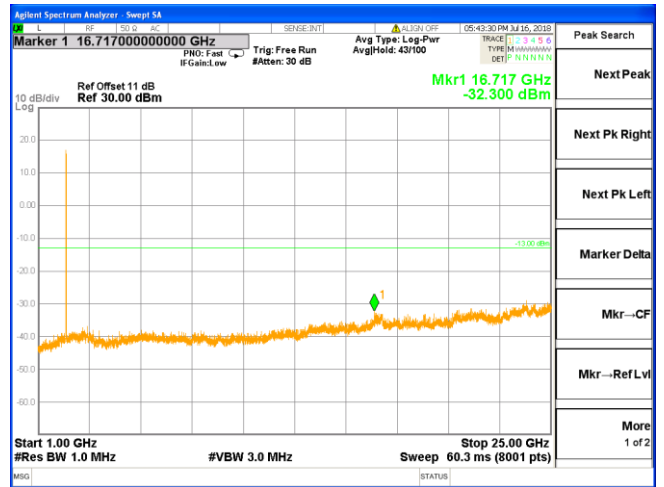

LTE Band 40 (QPSK, Band Width 10MHz, RB Size 1, RB Offset 0, CH39200)

30MHz – 1GHz

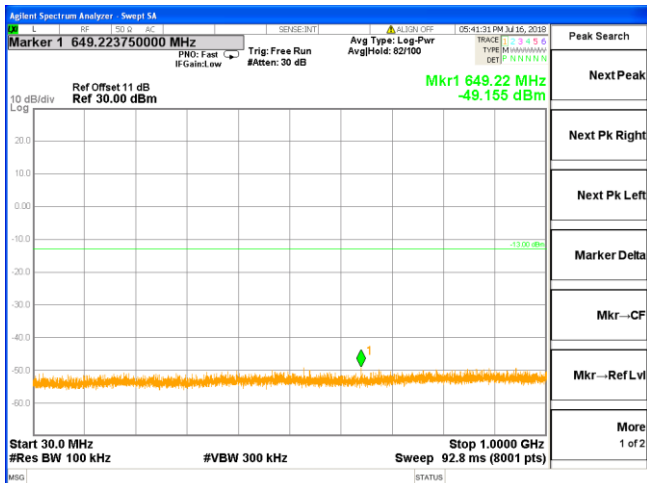

1GHz – 25GHz

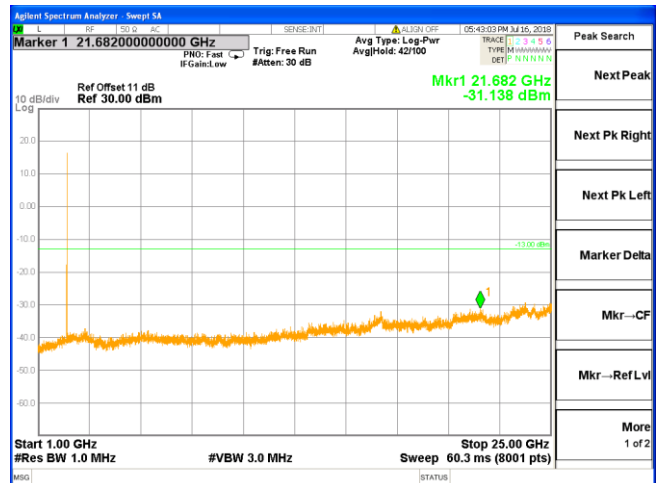

5.5 Band edge at antenna terminals

5.5.1 Limit

The power of any emission outside of the authorized operating frequency ranges must be lower than the transmitter power (P) by a factor of at least $43 + 10 \log (P)$ dB. It is measured by means of a calibrated spectrum analyzer and scanned from 30 MHz up to a frequency including its 10th harmonic.

5.5.2 Test procedure

1. The testing follows FCC KDB 971168 v03 Section 6.0.
2. The EUT was connected to spectrum analyzer and system simulator via a power divider.
3. The RF output of EUT was connected to the spectrum analyzer by RF cable and attenuator. The path loss was compensated to the results for each measurement.
4. The middle channel for the highest RF power within the transmitting frequency was measured.
5. The conducted spurious emission for the whole frequency range was taken.
6. Make the measurement with the spectrum analyzer's RBW = 1MHz, VBW = 3MHz.
7. Set spectrum analyzer with RMS detector.
8. Taking the record of maximum spurious emission.
9. The RF fundamental frequency should be excluded against the limit line in the operating frequency band.
10. The limit line is derived from $43 + 10\log(P)$ dB below the transmitter power P(Watts)
 - = $P(W) - [43 + 10\log(P)]$ (dB)
 - = $[30 + 10\log(P)]$ (dBm) - $[43 + 10\log(P)]$ (dB)
 - = -13dBm.

5.5.3 Test setup

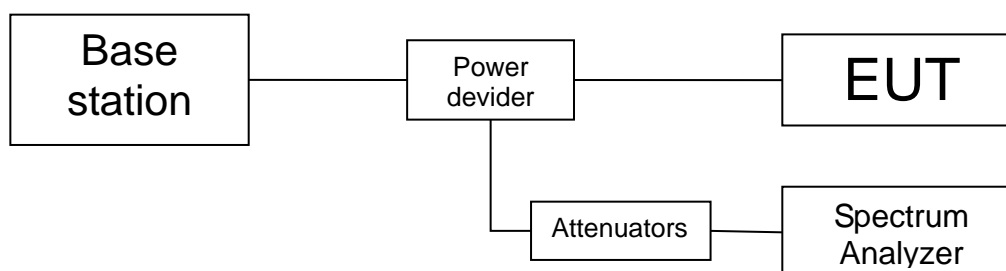

5.5.4 Test results

Note: All mode has been tested, only worst data shown in this report.

Test plots

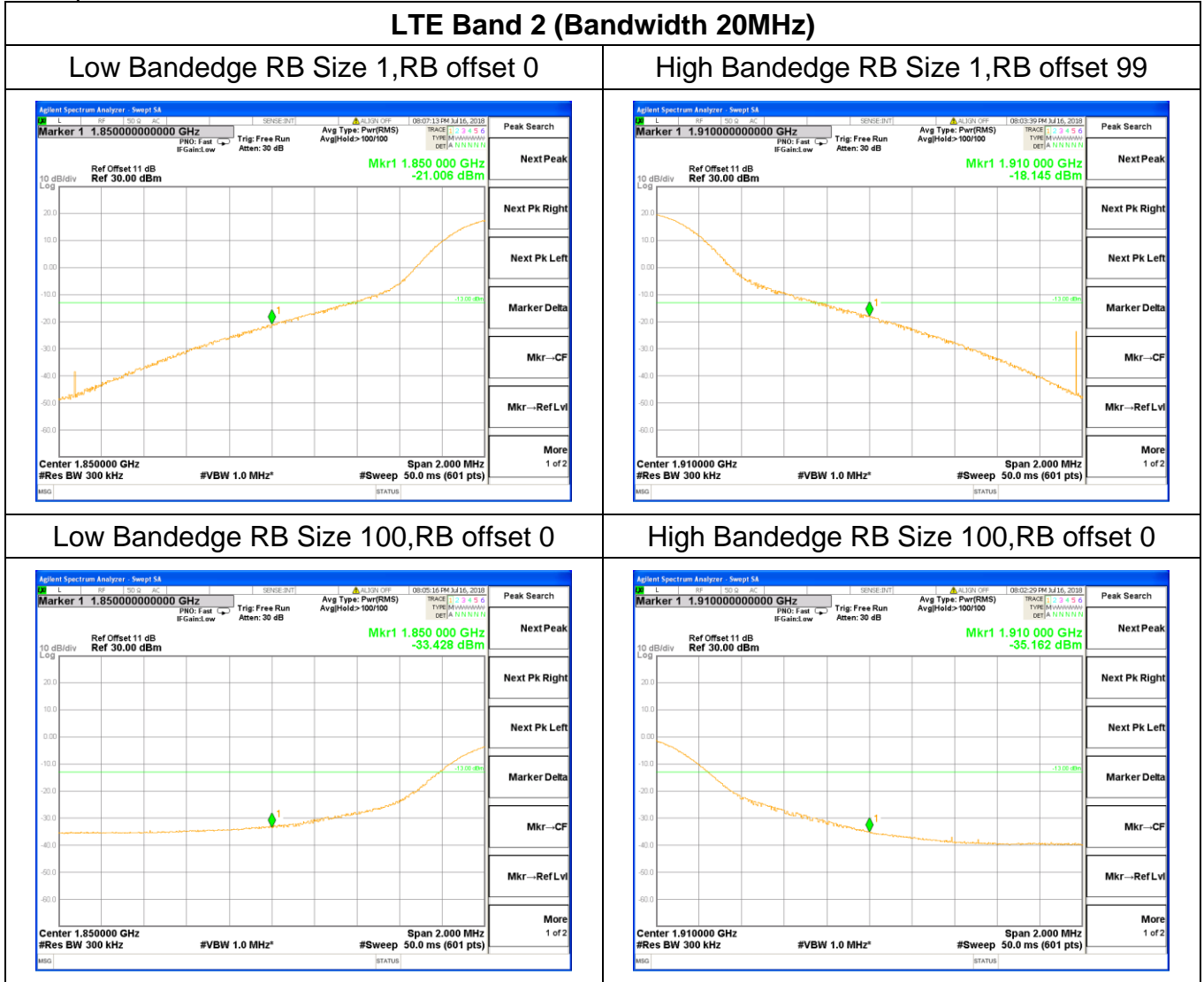

LTE Band 5 (Bandwidth 10MHz)

Low Bandedge RB Size 1, RB offset 0

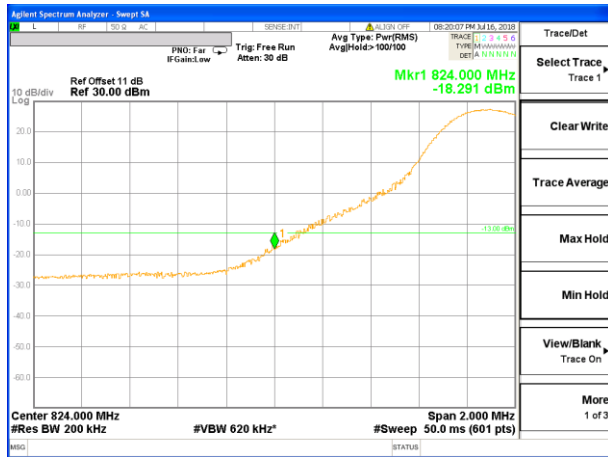

High Bandedge RB Size 1, RB offset 49

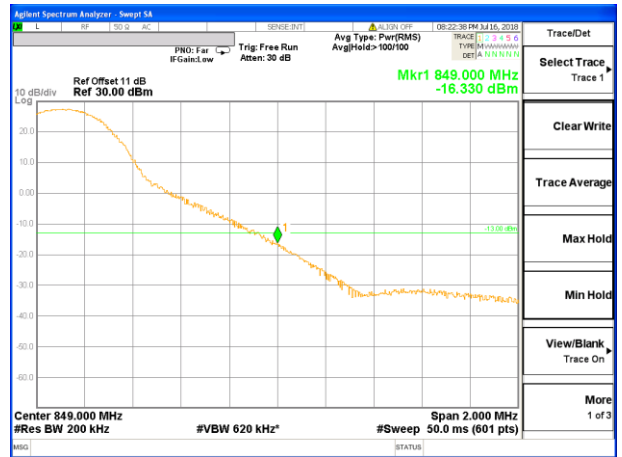

Low Bandedge RB Size 50, RB offset 0

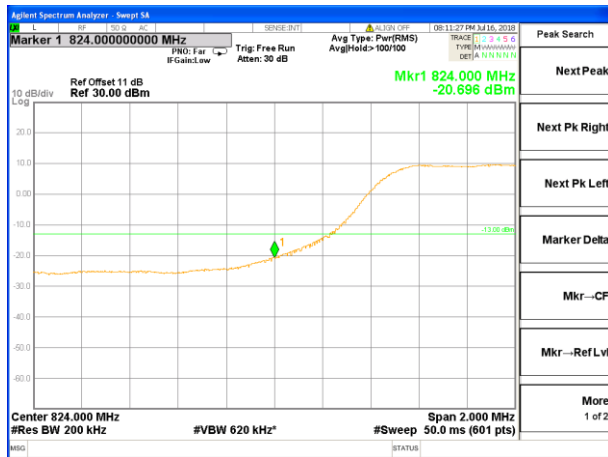

High Bandedge RB Size 50, RB offset 0

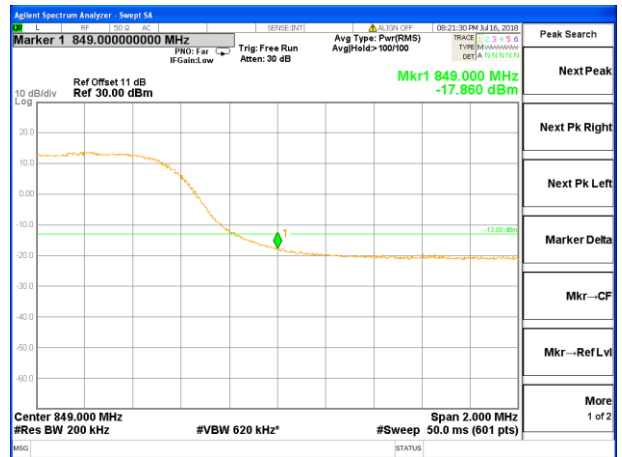

LTE Band 17 (Bandwidth 10MHz)

Low Bandedge RB Size 1, RB offset 0

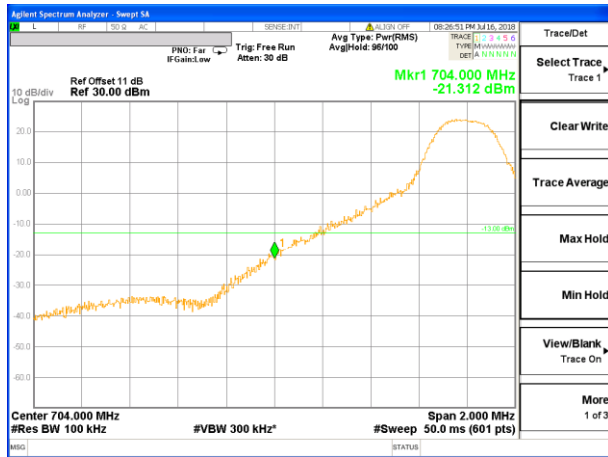

High Bandedge RB Size 1, RB offset 49

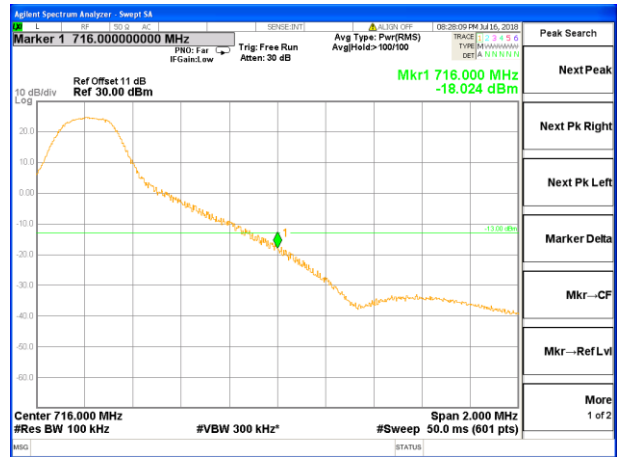

Low Bandedge RB Size 50, RB offset 0

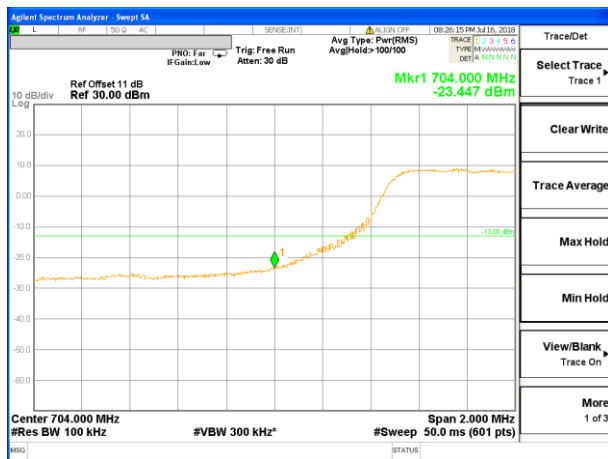

High Bandedge RB Size 50, RB offset 0

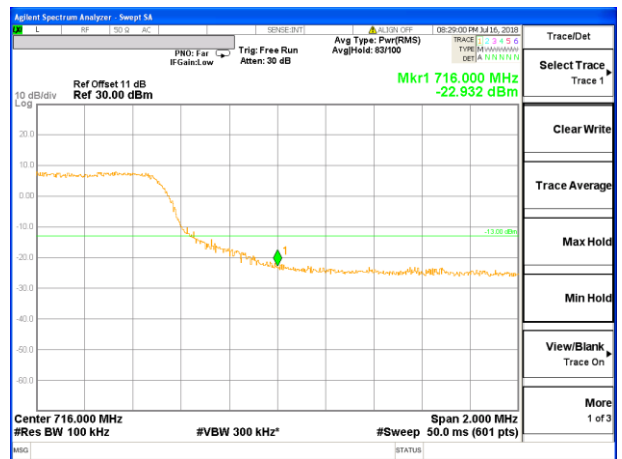

LTE Band 40 (Bandwidth 20MHz)

Low Bandedge RB Size 1, RB offset 0

High Bandedge RB Size 1, RB offset 49

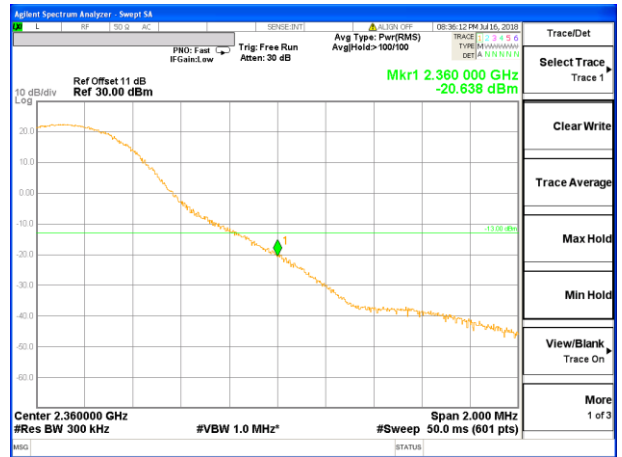
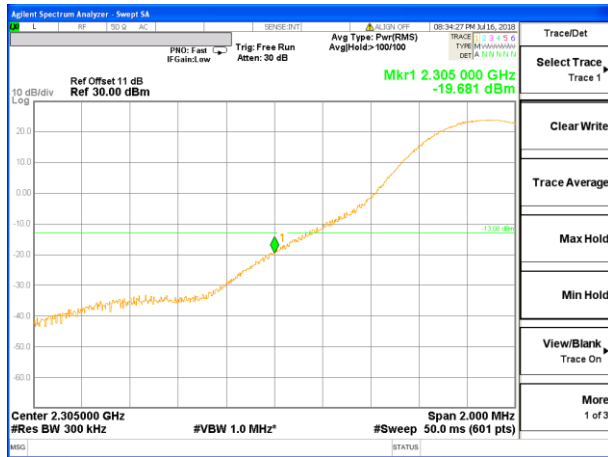

Low Bandedge RB Size 50, RB offset 0

High Bandedge RB Size 50, RB offset 0

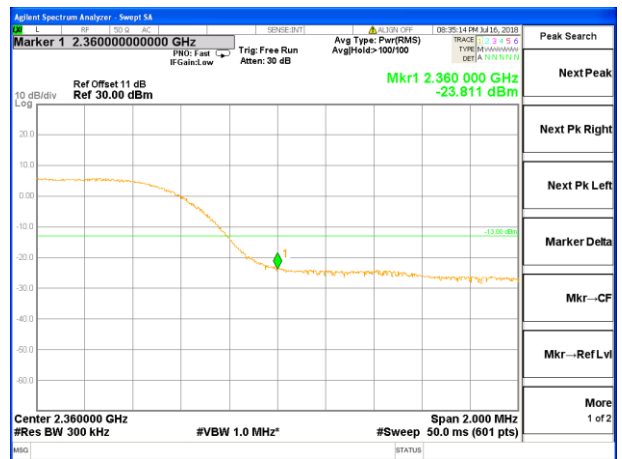
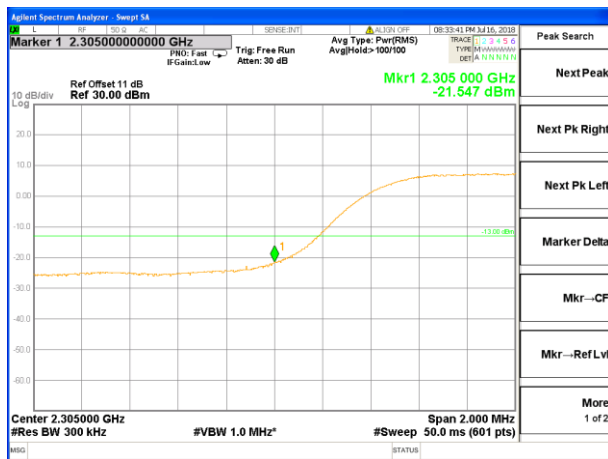

5.6 Field strength of spurious radiation measurement

5.6.1 Limit

LTE Band 2, LTE Band 4, LTE Band 5, LTE Band 17 and LTE Band 40: -13dBm,

5.6.2 Test procedure

1. The EUT was placed on an non-conductive turntable using a nonconductive support. The radiated emission at the fundamental frequency was measured at 3 m with a test antenna and EMI spectrum analyzer.
2. During the tests, the antenna height and the EUT azimuth were varied in order to identify the maximum level of emissions from the EUT. This maximization process was repeated with the EUT positioned in each of its three orthogonal orientations.
3. The frequency range up to tenth harmonic was investigated for each of three fundamental frequency (low, middle and high channels). Once spurious emission was identified, the power of the emission was determined using the substitution method.
4. The spurious emissions attenuation was calculated as the difference between radiated power at the fundamental frequency and the spurious emissions frequency. $ERP / EIRP = S.G. \text{ output (dBm)} + \text{Antenna Gain(dB/dBi)} - \text{Cable Loss (dB)}$.

5.6.3 Test setup

Radiated emission test-up frequency below 30MHz

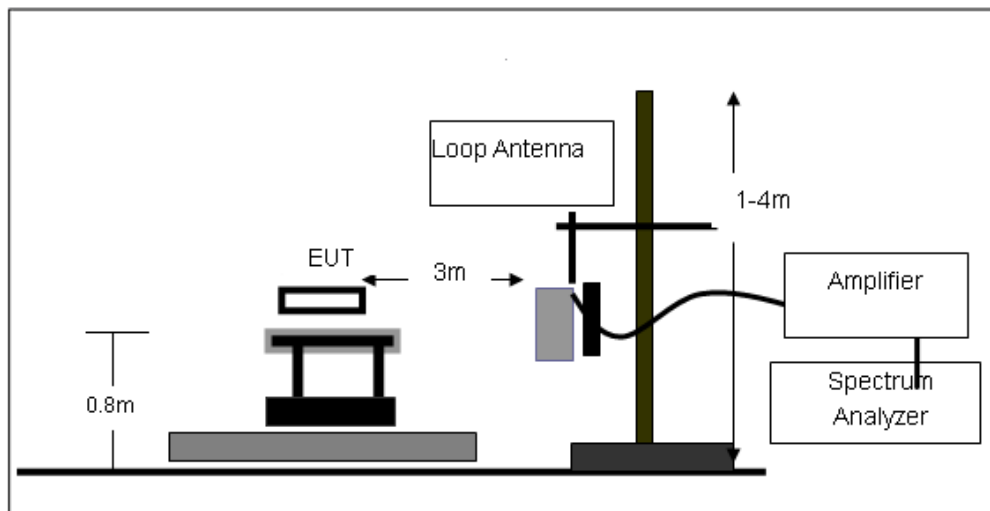

Radiated emission test-up frequency 30MHz~1GHz

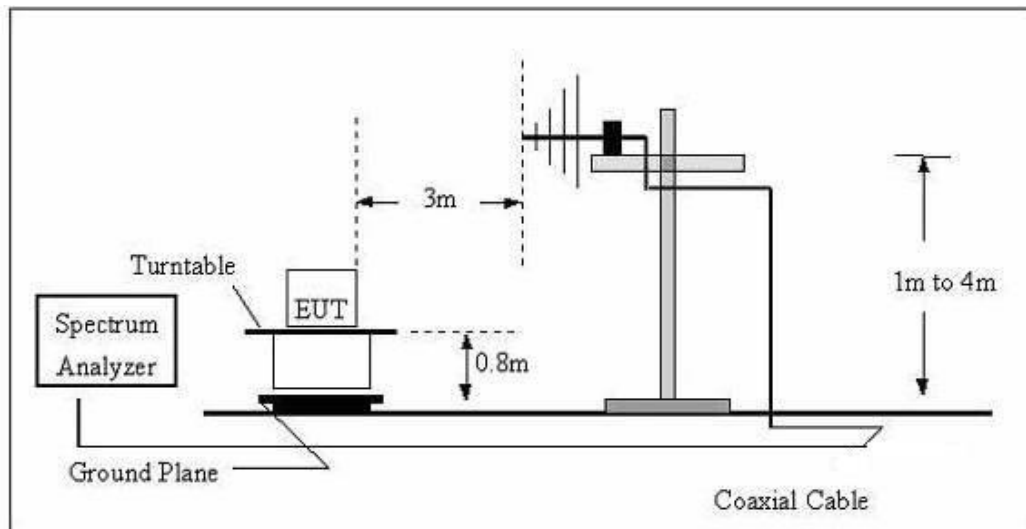

Radiated emission test-up frequency above 1GHz

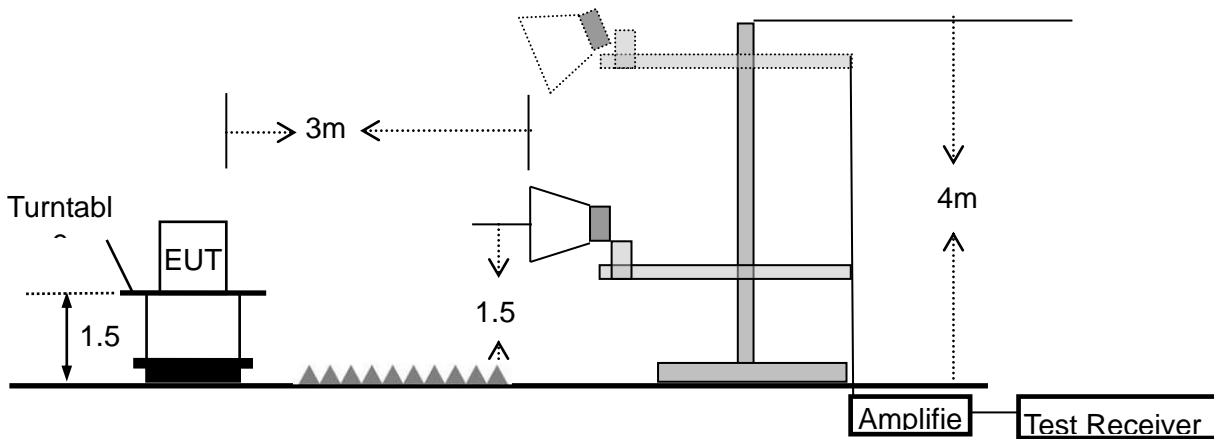

5.6.4 Test results

Note: All the configuration was tested and only the worse case was reported

LTE Band 2 (30MHz – 19GHz)

No.	Frequency(MHz)	Reading Level(dBm)	Correct Factor(dB)	Measurement(dBm)	Limit(dBm)	Margin	Result
1	277.0935	-65.26	16.13	-49.13	-13	36.13	Pass
2	410.3824	-64.97	19.5	-45.47	-13	32.47	Pass
3	603.5392	-64.09	21.6	-42.49	-13	29.49	Pass
4	12404.81	-65.61	13.15	-52.46	-13	39.46	Pass
5	14905.812	-58.81	16.21	-42.6	-13	29.6	Pass
6	15851.703	-61.03	4.08	-56.95	-13	43.95	Pass

No.	Frequency(MHz)	Reading Level(dBm)	Correct Factor(dB)	Measurement(dBm)	Limit(dBm)	Margin	Result
1	100.2286	-64.8	14.67	-50.13	-13	37.13	Pass
2	148.441	-64.79	12.37	-52.42	-13	39.42	Pass
3	478.8455	-62.75	20.86	-41.89	-13	28.89	Pass
4	11282.565	-60.12	9.96	-50.16	-13	37.16	Pass
5	12340.681	-62.7	11.01	-51.69	-13	38.69	Pass
6	12965.932	-62.75	12	-50.75	-13	37.75	Pass

LTE Band 4 (30MHz – 18GHz)

No.	Frequency(MHz)	Reading Level(dBm)	Correct Factor(dB)	Measurement(dBm)	Limit(dBm)	Margin	Result
1	369.4045	-64.11	18.49	-45.62	-13	32.62	Pass
2	459.1143	-63.71	20.47	-43.24	-13	30.24	Pass
3	656.53	-62.21	22.16	-40.05	-13	27.05	Pass
4	12741.483	-62.72	11.68	-51.04	-13	38.04	Pass
5	14008.016	-60.1	17.12	-42.98	-13	29.98	Pass
6	14505.01	-58.49	16.65	-41.84	-13	28.84	Pass

No.	Frequency(MHz)	Reading Level(dBm)	Correct Factor(dB)	Measurement(dBm)	Limit(dBm)	Margin	Result
1	212.2694	-64.02	14.34	-49.68	-13	36.68	Pass
2	325.5957	-64.84	17.34	-47.5	-13	34.5	Pass
3	431.0316	-63.75	19.91	-43.84	-13	30.84	Pass
4	13783.567	-61.16	16.67	-44.49	-13	31.49	Pass
5	14232.465	-59.3	17.11	-42.19	-13	29.19	Pass
6	14905.812	-58.81	16.21	-42.6	-13	29.6	Pass

LTE Band 5 (30MHz – 18G)

No.	Frequency(MHz)	Reading Level(dBm)	Correct Factor(dB)	Measurement(dBm)	Limit(dBm)	Margin	Result
1	293.0842	-62.76	16.51	-46.25	-13	33.25	Pass
2	810.2653	-61.36	24.15	-37.21	-13	24.21	Pass
3	958.7943	-62.05	25.98	-36.07	-13	23.07	Pass
4	11298.597	-64.53	12.03	-52.5	-13	39.5	Pass
5	12693.387	-65.11	13.48	-51.63	-13	38.63	Pass
6	12869.739	-65.02	13.64	-51.38	-13	38.38	Pass

No.	Frequency(MHz)	Reading Level(dBm)	Correct Factor(dB)	Measurement(dBm)	Limit(dBm)	Margin	Result
1	325.5957	-64.73	17.34	-47.39	-13	34.39	Pass
2	478.8455	-64.73	20.86	-43.87	-13	30.87	Pass
3	919.2866	-62.27	25.64	-36.63	-13	23.63	Pass
4	14232.465	-59.3	17.11	-42.19	-13	29.19	Pass
5	14905.812	-58.81	16.21	-42.6	-13	29.6	Pass
6	15274.549	-55.98	4.15	-51.83	-13	38.83	Pass

LTE Band 17 (30MHz – 8G)

No.	Frequency(MHz)	Reading Level(dBm)	Correct Factor(dB)	Measurement(dBm)	Limit(dBm)	Margin	Result
1	99.5279	-64.28	14.59	-49.69	-13	36.69	Pass
2	114.5146	-64.14	13.86	-50.28	-13	37.28	Pass
3	219.8448	-63.42	14.58	-48.84	-13	35.84	Pass
4	4679.359	-49.29	2.92	-46.37	-13	33.37	Pass
5	6428.858	-50.09	5.36	-44.73	-13	31.73	Pass
6	7402.806	-49.96	8.51	-41.45	-13	28.45	Pass

No.	Frequency(MHz)	Reading Level(dBm)	Correct Factor(dB)	Measurement(dBm)	Limit(dBm)	Margin	Result
1	382.5879	-64.52	18.83	-45.69	-13	32.69	Pass
2	629.4772	-62.03	21.88	-40.15	-13	27.15	Pass
3	925.7563	-61.65	25.69	-35.96	-13	22.96	Pass
4	4084.168	-51.83	9.14	-42.69	-13	29.69	Pass
5	6068.136	-51.57	5.4	-46.17	-13	33.17	Pass
6	7420.842	-50.76	10.16	-40.6	-13	27.6	Pass

LTE Band 40 (30MHz – 25G)

No.	Frequency(MHz)	Reading Level(dBm)	Correct Factor(dB)	Measurement(dBm)	Limit(dBm)	Margin	Result
1	247.6819	-64.24	15.41	-48.83	-13	35.83	Pass
2	297.2241	-64	17.61	-46.39	-13	33.39	Pass
3	510.0436	-63.54	20.52	-43.02	-13	30.02	Pass
4	4174.349	-51.65	8.56	-43.09	-13	30.09	Pass
5	5815.631	-52.28	4.55	-47.73	-13	34.73	Pass
6	7366.734	-52.63	10.08	-42.55	-13	29.55	Pass

No.	Frequency(MHz)	Reading Level(dBm)	Correct Factor(dB)	Measurement(dBm)	Limit(dBm)	Margin	Result
1	168.4138	-64.26	11.47	-52.79	-13	39.79	Pass
2	407.5144	-64.27	19.44	-44.83	-13	31.83	Pass
3	612.0642	-63.38	21.69	-41.69	-13	28.69	Pass
4	6014.028	-50.24	3.3	-46.94	-13	33.94	Pass
5	7492.986	-50.47	8.71	-41.76	-13	28.76	Pass
6	8016.032	-50.3	9.93	-40.37	-13	27.37	Pass

5.7 Frequency Stability

5.7.1 Limit

The frequency stability shall be sufficient to ensure that the fundamental emission stays within the authorized frequency block. As this transceiver is considered "Hand carried, battery powered equipment" Section 2.1055(d) (2) applies. This requires that the lower voltage for frequency stability testing be specified by the manufacturer. This transceiver is specified to operate with an input voltage of between 3.5VDC and 4.4VDC, with a nominal voltage of 3.85VDC. Operation above or below these voltage limits is prohibited by transceiver software in order to prevent improper operation as well as to protect components from overstress. These voltages represent a tolerance from -5.4% to 10.8%. For the purposes of measuring frequency stability these voltage limits are to be used.

5.7.2 Test procedure

Test Procedures for Temperature Variation:

1. The EUT was set up in the thermal chamber and connected with the system simulator.
2. With power OFF, the temperature was decreased to -30°C and the EUT was stabilized before testing. Power was applied and the maximum change in frequency was recorded within one minute.
3. With power OFF, the temperature was raised in 10°C step up to 50°C. The EUT was stabilized at each step for at least half an hour. Power was applied and the maximum frequency change was recorded within one minute.

Test Procedures for Voltage Variation

1. The testing follows FCC KDB 971168 v02r02 Section 9.0.
2. The EUT was placed in a temperature chamber at 25±5° C and connected with the system simulator.
3. The power supply voltage to the EUT was varied from 85% to 115% of the nominal value measured at the input to the EUT.
4. The variation in frequency was measured for the worst case.

5.7.3 Test setup

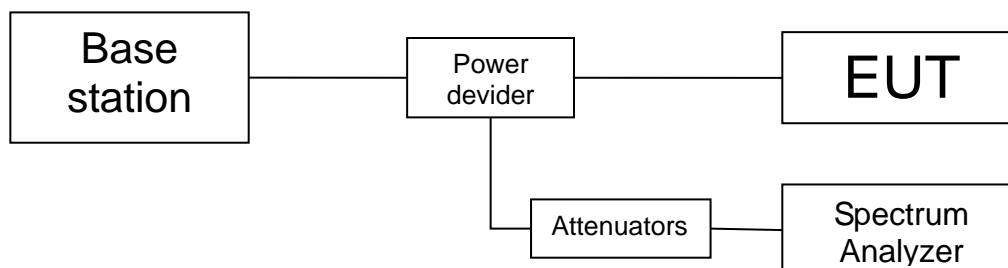

5.7.4 Test results

LTE Band 2

For Temperature Variation:

Temperature(°C)	Test channels(MHz)	Deviation (Hz)	Deviation (ppm)	Limit(ppm)	Result
50	1880	10.63	0.006	2.5	Pass
40		21.47	0.011		Pass
30		21.53	0.011		Pass
20		23.91	0.013		Pass
10		19.86	0.011		Pass
0		19.27	0.010		Pass
-10		17.79	0.009		Pass
-20		22.13	0.012		Pass
-30		17.52	0.009		Pass

For Voltage Variation

Voltage(Volt)	Test channels(MHz)	Deviation (Hz)	Deviation (ppm)	Limit(ppm)	Result
4.26	1880	17.23	0.009	2.5	Pass
3.8		21.66	0.012		Pass
3.15		15.53	0.008		Pass

LTE Band 4

For Temperature Variation:

Temperature(°C)	Test channels(MHz)	Deviation (Hz)	Deviation (ppm)	Limit(ppm)	Result
50	1732.5	13.31	0.008	2.5	Pass
40		19.21	0.011		Pass
30		14.77	0.009		Pass
20		20.98	0.012		Pass
10		24.30	0.014		Pass
0		23.35	0.013		Pass
-10		17.57	0.010		Pass
-20		19.23	0.011		Pass
-30		11.77	0.007		Pass

For Voltage Variation

Voltage(Volt)	Test channels(MHz)	Deviation (Hz)	Deviation (ppm)	Limit(ppm)	Result
4.26	1732.5	15.58	0.009	2.5	Pass
3.8		22.07	0.013		Pass
3.15		19.13	0.011		Pass

LTE Band 5

For Temperature Variation:

Temperature(°C)	Test channels(MHz)	Deviation (Hz)	Deviation (ppm)	Limit(ppm)	Result
50	836.5	12.24	0.015	2.5	Pass
40		20.25	0.024		Pass
30		17.55	0.021		Pass
20		24.49	0.029		Pass
10		25.67	0.031		Pass
0		25.23	0.030		Pass
-10		21.40	0.026		Pass
-20		22.57	0.027		Pass
-30		16.11	0.019		Pass

For Voltage Variation

Voltage(Volt)	Test channels(MHz)	Deviation (Hz)	Deviation (ppm)	Limit(ppm)	Result
4.26	836.5	16.93	0.020	2.5	Pass
3.8		15.11	0.018		Pass
3.15		17.20	0.021		Pass

LTE Band 17

For Temperature Variation:

Temperature(°C)	Test channels(MHz)	Deviation (Hz)	Deviation (ppm)	Limit(ppm)	Result
50	710	17.26	0.024	2.5	Pass
40		16.86	0.024		Pass
30		16.66	0.023		Pass
20		20.70	0.029		Pass
10		20.01	0.028		Pass
0		23.76	0.033		Pass
-10		24.61	0.035		Pass
-20		17.14	0.024		Pass
-30		17.88	0.025		Pass

For Voltage Variation

Voltage(Volt)	Test channels(MHz)	Deviation (Hz)	Deviation (ppm)	Limit(ppm)	Result
4.26	710	16.50	0.023	2.5	Pass
3.8		13.84	0.019		Pass
3.15		12.72	0.018		Pass

LTE Band 40

2305-2315MHz

For Temperature Variation:

Temperature(°C)	Test channels(MHz)	Deviation (Hz)	Deviation (ppm)	Limit(ppm)	Result
50	707.5	15.44	0.022	2.5	Pass
40		16.48	0.023		Pass
30		17.09	0.024		Pass
20		20.27	0.029		Pass
10		23.33	0.033		Pass
0		23.87	0.034		Pass
-10		22.89	0.032		Pass
-20		18.84	0.027		Pass
-30		13.05	0.018		Pass

For Voltage Variation

Voltage(Volt)	Test channels(MHz)	Deviation (Hz)	Deviation (ppm)	Limit(ppm)	Result
4.26	707.5	19.72	0.028	2.5	Pass
3.8		20.23	0.028		Pass
3.15		16.00	0.023		Pass

2350-2360MHz

For Temperature Variation:

Temperature(°C)	Test channels(MHz)	Deviation (Hz)	Deviation (ppm)	Limit(ppm)	Result
50	707.5	16.44	0.023	2.5	Pass
40		16.15	0.023		Pass
30		15.26	0.021		Pass
20		17.54	0.025		Pass
10		22.38	0.032		Pass
0		23.76	0.033		Pass
-10		22.69	0.032		Pass
-20		17.82	0.025		Pass
-30		12.46	0.018		Pass

For Voltage Variation

Voltage(Volt)	Test channels(MHz)	Deviation (Hz)	Deviation (ppm)	Limit(ppm)	Result
4.26	707.5	19.67	0.028	2.5	Pass
3.8		20.53	0.029		Pass
3.15		14.41	0.020		Pass

Photographs of the Test Setup

Radiated emission

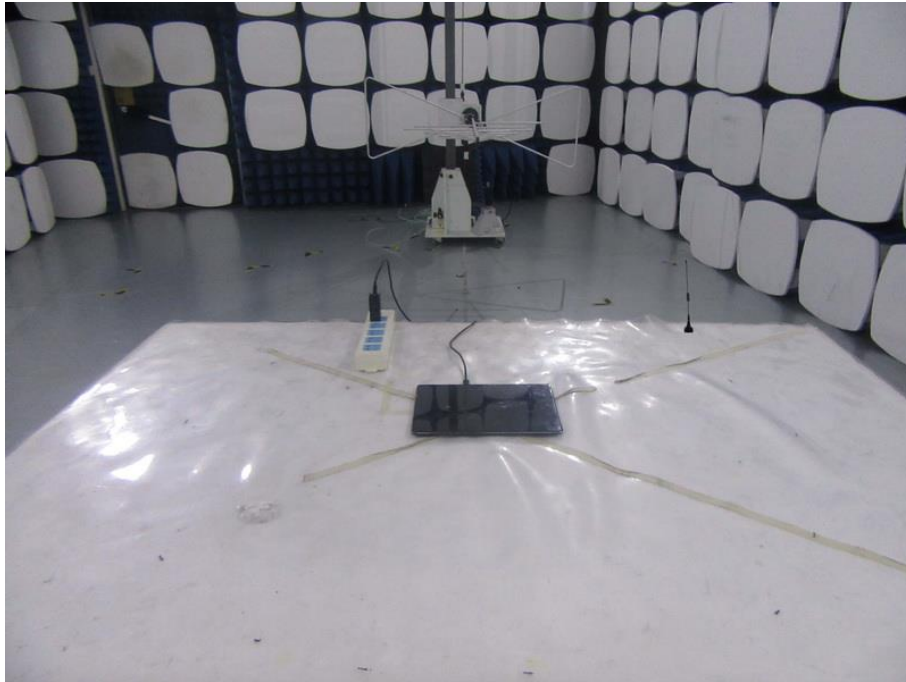

Photographs of the EUT

See the APPENDIX 1: EUT PHOTO in the report No.: MTi180724E135-1.

----END OF REPORT----