

# Test Report

FCC ID: 2AHLZ-HI9AIR

Date of issue: July 25, 2018

Report Number:	MTi180724E136
Sample Description:	Tablet PC
Model(s):	Hi9 Air-CWI546
Applicant:	CHUWI TECHNOLOGY (ShenZhen) CO., LIMITED
Address:	2 Floor Building 3 LiJinCheng Industrial park the east of Gongye road LongHua Shenzhen China
Date of Test:	Apr. 25, 2018 to July 25, 2018

Shenzhen Microtest Co., Ltd.  
<http://www.mtitest.com>

## Table of Contents

<b>1. GENERAL INFORMATION .....</b>	<b>5</b>
1.1. DESCRIPTION OF EUT .....	5
1.2. OPERATION CHANNEL LIST .....	5
1.3. TEST CHANNEL LIST .....	6
1.4. ANCILLARY EQUIPMENT LIST .....	6
1.5. DESCRIPTION OF SUPPORT UNITS .....	6
<b>2. SUMMARY OF TEST RESULTS.....</b>	<b>7</b>
<b>3. TEST FACILITIES AND ACCREDITATIONS.....</b>	<b>8</b>
3.1. TEST LABORATORY .....	8
3.2. ENVIRONMENTAL CONDITIONS .....	8
3.3. MEASUREMENT UNCERTAINTY .....	8
3.4. TEST SOFTWARE .....	8
<b>4. EQUIPMENT LIST .....</b>	<b>9</b>
<b>5. TEST RESULT .....</b>	<b>10</b>
5.1. ANTENNA REQUIREMENT .....	10
5.1.1 <i>Standard requirement</i> .....	10
5.1.2 <i>EUT Antenna</i> .....	10
5.2. PEAK OUTPUT POWER TEST.....	11
5.2.1 <i>Limit</i> .....	11
5.2.2 <i>Test setup</i> .....	11
5.2.3 <i>Test procedure</i> .....	11
5.2.4 <i>EUT operation condition</i> .....	11
5.2.5 <i>Test results</i> .....	11
5.3. CONDUCTED EMISSION .....	14
5.3.1 <i>Limits</i> .....	14
5.3.2 <i>Test setup</i> .....	14
5.3.3 <i>Test procedure</i> .....	15
5.3.4 <i>Test results</i> .....	15
5.4. RADIATED SPURIOUS EMISSION.....	20
5.4.1 <i>Limits</i> .....	20
5.4.2 <i>Test setup</i> .....	21
5.4.3 <i>Test procedure</i> .....	22
5.4.4 <i>Test results</i> .....	23
5.4.4.1 <i>Radiation emission</i> .....	23
5.4.4.2 <i>Bandedge-radiated</i> .....	27
5.4.4.3 <i>Spurious Emission in Restricted Band 3260MMHz-18000MHz</i> .....	28
5.5. POWER SPECTRAL DENSITY TEST .....	29
5.5.1 <i>Limit</i> .....	29
5.5.2 <i>Test procedure</i> .....	29
5.5.3 <i>Test setup</i> .....	29
5.5.4 <i>EUT operation conditions</i> .....	29
5.5.5 <i>Test results</i> .....	30
5.6. 6dB BANDWIDTH .....	32
5.6.1 <i>Limit</i> .....	32
5.6.2 <i>TEST PROCEDURE</i> .....	32
5.6.3 <i>TEST SETUP</i> .....	32
5.6.4 <i>EUT operation conditions</i> .....	32
5.6.5 <i>Test Result</i> .....	32
5.7. CONDUCTED BANDEDGE .....	35
5.7.1 <i>Limits</i> .....	35
5.7.2 <i>Test setup</i> .....	35

5.7.3 Test procedure.....35  
5.7.4 EUT operation conditions.....35  
5.7.5 Test Result .....35

**PHOTOGRAPHS OF THE TEST SETUP ..... 37**

**PHOTOGRAPHS OF THE EUT ..... 39**

## PRODUCT INFORMATION

Applicant's name: CHUWI TECHNOLOGY (ShenZhen) CO., LIMITED

Address: 2 Floor Building 3 LiJinCheng Industrial park the east of Gongye road LongHua Shenzhen China

Manufacture's Name: Shenzhen Sunty Technology Co., Ltd.

Address: F7-8, Building 7, ZhongYunTai Industry Park, Songbai Road, Shiyuan Street, Bao'an District, Shenzhen, China.

Product name: Tablet PC

Trademark: CHUWI

Model name: Hi9 Air-CWI546

Standards: FCC Part 15.247

Test Procedure: ANSI C63.10:2013  
KDB 174176 D01 Line Conducted FAQ v01r01

*This device described above has been tested by Shenzhen Microtest Co., Ltd and the test results show that the equipment under test (EUT) is in compliance with the FCC requirements. And it is applicable only to the tested sample identified in the report.*

Tested by:

*Leo Su*

Leo Su

July 25, 2018

Reviewed by:

*Blue Zheng*

Blue Zheng

July 25, 2018

Approved by:

*Smith Chen*

Smith Chen

July 25, 2018

## 1. General Information

### 1.1. Description of EUT

Product name:	Tablet PC
Model name:	Hi9 Air-CWI546
Serial model:	N/A
Difference in series models:	N/A
Operation frequency:	2402-2480MHz
Modulation type:	GFSK
Bit Rate of transmitter:	1 Mbps
Antenna type:	Integral Antenna
Antenna gain:	1.07dBi
Max. output power:	1.680dBm
Hardware version:	X970-97WCB
Software version:	V1.0
Power supply:	DC 3.8V from Battery or DC 5V from adapter
Adapter information:	Model:JHD-AP013U-050200BB-B Input:100-240V~ 50/60Hz 0.35A Output:5V 2A
Battery:	DC 3.8V 8000mAh

### 1.2. Operation channel list

Channel No.	Frequency (MHz)	Channel No.	Frequency (MHz)	Channel No.	Frequency (MHz)	Channel No.	Frequency (MHz)
0	2402	10	2422	20	2442	30	2462
1	2404	11	2424	21	2444	31	2464
2	2406	12	2426	22	2446	32	2466
3	2408	13	2428	23	2448	33	2468
4	2410	14	2430	24	2450	34	2470
5	2412	15	2432	25	2452	35	2472
6	2414	16	2434	26	2454	36	2474
7	2416	17	2436	27	2456	37	2476
8	2418	18	2438	28	2458	38	2478
9	2420	19	2440	29	2460	39	2480

1.3. Test channel list

Channel	Channel	Frequency (MHz)
Low	00	2402
Middle	19	2440
High	39	2480

1.4. Ancillary equipment list

Equipment	Model	S/N	Manufacturer	Certificate type
Adapter	HW-059200CHQ	/	HUAWEI	/

1.5. Description of Support Units

The EUT has been tested as an independent unit together with other necessary accessories or support units. The following support units or accessories were used to form a representative test configuration during the tests.

Item	Equipment	Brand	Model/Type No.	Series No.	Note
/	/	/	/	/	
/	/	/	/	/	

Note:

(1)The support equipment was authorized by Declaration of Confirmation.

(2)For detachable type I/O cable should be specified the length in cm in 『Length』 column.

## 2. Summary of Test Results

Test procedures according to the technical standards:

No.	Standard Section	Test Item	Result	Remark
1	15.207	Conducted Emission	Pass	
2	15.247 (a)(2)	6dB Bandwidth	Pass	
3	15.247 (b)	Peak Output Power	Pass	
4	15.247 (d) & 15.209	Radiated Spurious Emission	Pass	
5	15.247 (e)	Power Spectral Density	Pass	
6	15.205	Band Edge Emission	Pass	
7	15.203	Antenna Requirement	Pass	

### 3. Test Facilities and Accreditations

#### 3.1. Test laboratory

Test Laboratory	Shenzhen Microtest Co., Ltd
Location	No.102A & 302A, East Block, Hengfang Industrial Park, Xingye Road, Xixiang, Bao'an District, Shenzhen, Guangdong, China
FCC Registration No.:	448573

#### 3.2. Environmental conditions

Temperature:	20°C~30°C
Humidity	30%~70%
Atmospheric pressure	98kPa~101kPa

#### 3.3. Measurement uncertainty

The reported uncertainty of measurement  $y \pm U$  where expanded uncertainty  $U$  is based on a standard uncertainty multiplied by a coverage factor of  $k=2$  providing a level of confidence of approximately 95 %

No.	Item	Uncertainty
1	Conducted Emission Test	$\pm 1.38\text{dB}$
2	RF power, conducted	$\pm 0.16\text{dB}$
3	Spurious emissions, conducted	$\pm 0.21\text{dB}$
4	All emissions, radiated(<1G)	$\pm 4.68\text{dB}$
5	All emissions, radiated(>1G)	$\pm 4.89\text{dB}$
6	Temperature	$\pm 0.5^\circ\text{C}$
7	Humidity	$\pm 2\%$

#### 3.4. Test software

Software Name	Manufacturer	Model	Version
RF Test System	Farad	LZ-RF	Lz_Rf 3A3



#### 4. Equipment list

Equipment No.	Equipment Name	Manufacturer	Model	Serial No.	Calibration date	Due date
MTI-E001	Spectrum Analyzer	Agilent	E4407B	MY41441082	2017/09/18	2018/09/17
MTI-E002	CMU 200 universal radio communication tester	Rohde&schwarz	CMU 200	114587	2017/09/18	2018/09/17
MTI-E004	EMI Test Receiver	Rohde&schwarz	ESPI	1000314	2017/09/18	2018/09/17
MTI-E006	Broadband antenna	schwarzbeck	VULB9163	872	2017/09/18	2018/09/17
MTI-E007	Horn antenna	schwarzbeck	BBHA9120D	1201	2017/09/18	2018/09/17
MTI-E014	amplifier	America	8447D	3113A06150	2017/09/18	2018/09/17
MTI-E015	Conduction Immunity Signal Generator	Schloder	CDG6000	126A1343/2015	2017/09/18	2018/09/17
MTI-E016	Coupled decoupling network	Schloder	CDA M2/M3	A2210332/2015	2017/09/18	2018/09/17
MTI-E032	Comprehensive test instrument	Rohde&schwarz	CMW500	124192	2018/04/13	2019/04/12
MTI-E034	amplifier	Agilent	8449B	3008A02400	2017/08/22	2018/08/21
MTI-E040	Spectrum analyzer	Agilent	N9020A	MY49100060	2018/03/05	2019/03/04
MTI-E041	Signal generator	Agilent	N5182A	MY49060455	2018/02/23	2019/02/22
MTI-E042	Analog signal generator	Agilent	E4421B	GB40051240	2018/02/23	2019/02/22
MTI-E043	Power sensor	Dare Instruments	RPR3006W	16I00054SN016	2018/02/29	2019/02/28
MTI-E047	10dB attenuator	Mini-Circuits	UNAT-10+	15542	2018/05/24	2019/05/23
MTI-E049	spectrum analyzer	Rohde&schwarz	FSP-38	100019	2017/09/18	2018/09/17
MTI-E050	PSG Signal generator	Agilent	E8257D	MY46520873	2017/09/18	2018/09/17
MTI-E051	Active Loop Antenna 9kHz - 30MHz	Schwarzbeck	FMZB 1519 B	00044	2018/02/26	2019/02/25
MTI-E052	18-40GHz amplifier	Chengdu step Micro Technology	ZLNA-18-40G-21	1608001	2017/09/18	2018/09/17
MTI-E053	15-40G Antenna	Schwarzbeck	BBHA9170	BBHA9170582	2017/09/18	2018/09/17

Note: the calibration interval of the above test instruments is 12 months and the calibrations are traceable to international system unit (SI).

## 5. Test Result

### 5.1. Antenna requirement

#### 5.1.1 Standard requirement

15.203 requirement: For intentional device, according to 15.203: an intentional radiator shall be designed to ensure that no antenna other than that furnished by the responsible party shall be used with the device

#### 5.1.2 EUT Antenna

The EUT antenna is integral antenna (1.07dBi). It comply with the standard requirement. In case of replacement of broken antenna the same antenna type must be used.

5.2. Peak output power test

5.2.1 Limit

FCC Part15 Subpart C			
Section	Test Item	Limit	Frequency Range (MHz)
15.247(b)(3)	Peak output power	1 watt or 30dBm	2400-2483.5

5.2.2 Test setup



5.2.3 Test procedure

- (1) The EUT was directly connected to the spectrum analyzer and antenna output port as show in the block diagram above.
- (2) Spectrum Setting:  
 RBW=1MHz, VBW=3MHz, Detector=Peak (If 20dB BW ≤1 MHz)  
 RBW=3MHz, VBW=10MHz, Detector=Peak (If 20dB BW > 1 MHz)
- (3) The EUT was set to continuously transmitting in the max power during the test.

5.2.4 EUT operation condition

The EUT tested system was configured as the statements of 2.4 Unless otherwise a special operating condition is specified in the follows during the testing.

5.2.5 Test results

EUT :	Tablet PC	Model Name :	Hi9 Air-CWI546
Temperature :	25 °C	Relative Humidity :	60%
Pressure :	1012 hPa	Test Voltage :	DC 3.8V by battery

TX BLE mode

Test Channe	Frequency	Maximum Conducted Output Power(PK)	LIMIT
	(MHz)	(dBm)	dBm
CH01	2402	-0.443	30
CH20	2440	0.664	30
CH40	2480	1.680	30

///

2402MHz

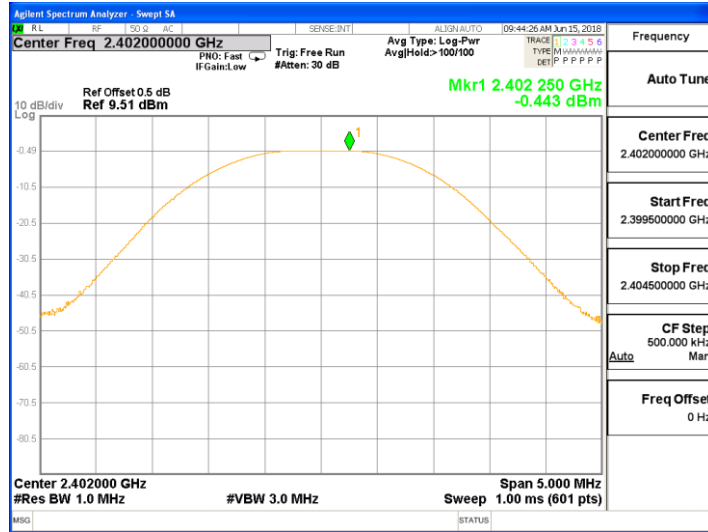

2440MHz

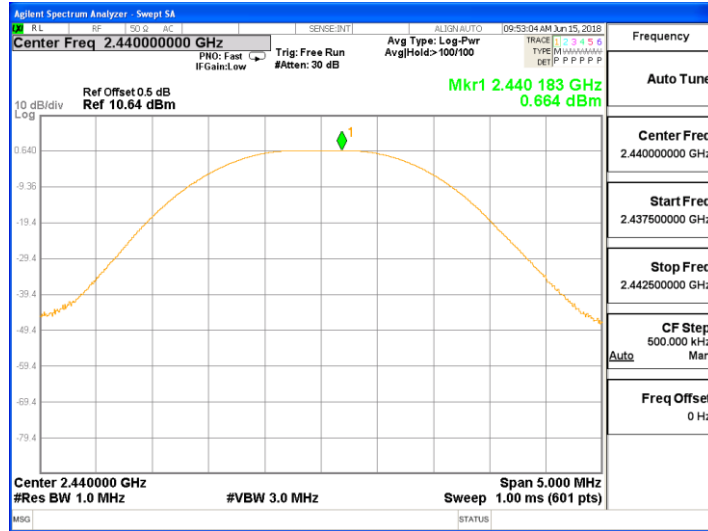

2480MHz

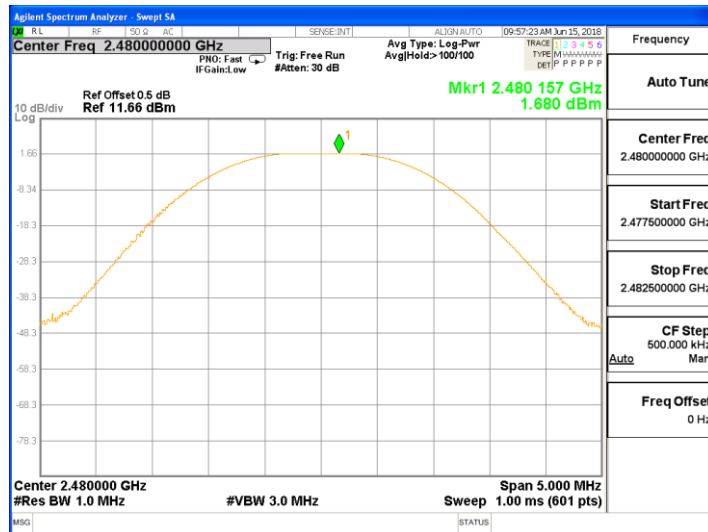

### 5.3. Conducted emission

#### 5.3.1 Limits

FREQUENCY (MHz)	Class B (dBuV)	
	Quasi-peak	Average
0.15 -0.5	66 - 56 *	56 - 46 *
0.50 -5.0	56.00	46.00
5.0 -30.0	60.00	50.00

Note

(1)The tighter limit applies at the band edges.

(2)The limit of " \* " marked band means the limitation decreases linearly with the logarithm of the frequency in the range.

#### 5.3.2 Test setup

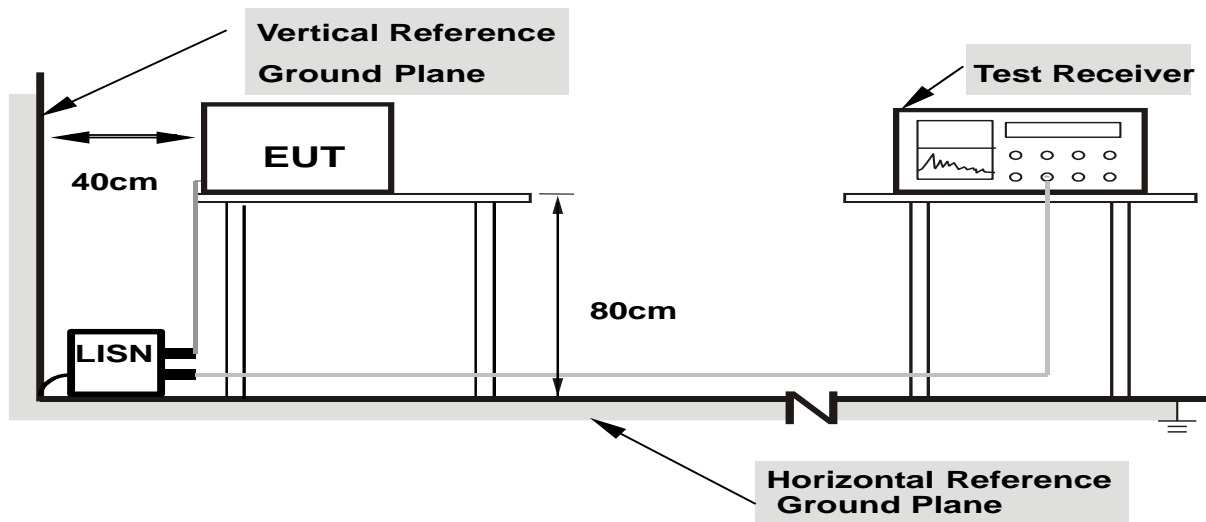

**Note: 1.Support units were connected to second LISN.**

**2.Both of LISNs (AMN) are 80 cm from EUT and at least 80 from other units and other metal planes**

### 5.3.3 Test procedure

#### a. EUT Operating Conditions

The EUT was configured for testing in a typical fashion (as a customer would normally use it). The EUT has been programmed to continuously transmit during test. This operating condition was tested and used to collect the included data.

#### b. The following table is the setting of the receiver

Receiver Parameters	Setting
Attenuation	10 dB
Start Frequency	0.15 MHz
Stop Frequency	30 MHz
IF Bandwidth	9 kHz

- c. The EUT was placed 0.8 meters from the horizontal ground plane with EUT being connected to the power mains through a line impedance stabilization network (LISN). All other support equipments powered from additional LISN(s). The LISN provide 50 Ohm/ 50uH of coupling impedance for the measuring instrument.
- d. Interconnecting cables that hang closer than 40 cm to the ground plane shall be folded back and forth in the center forming a bundle 30 to 40 cm long.
- e. I/O cables that are not connected to a peripheral shall be bundled in the center. The end of the cable may be terminated, if required, using the correct terminating impedance. The overall length shall not exceed 1 m.
- f. LISN at least 80 cm from nearest part of EUT chassis.

For the actual test configuration, please refer to the related Item –EUT Test Photos.

### 5.3.4 Test results

Test data

EUT :	Tablet PC	Model Name. :	Hi9 Air-CWI546
Temperature :	26 °C	Relative Humidity :	54%
Pressure :	1010hPa	Phase :	L
Test Voltage :	DC 5V from adapter AC 120V/60Hz	Test Mode :	Normal link

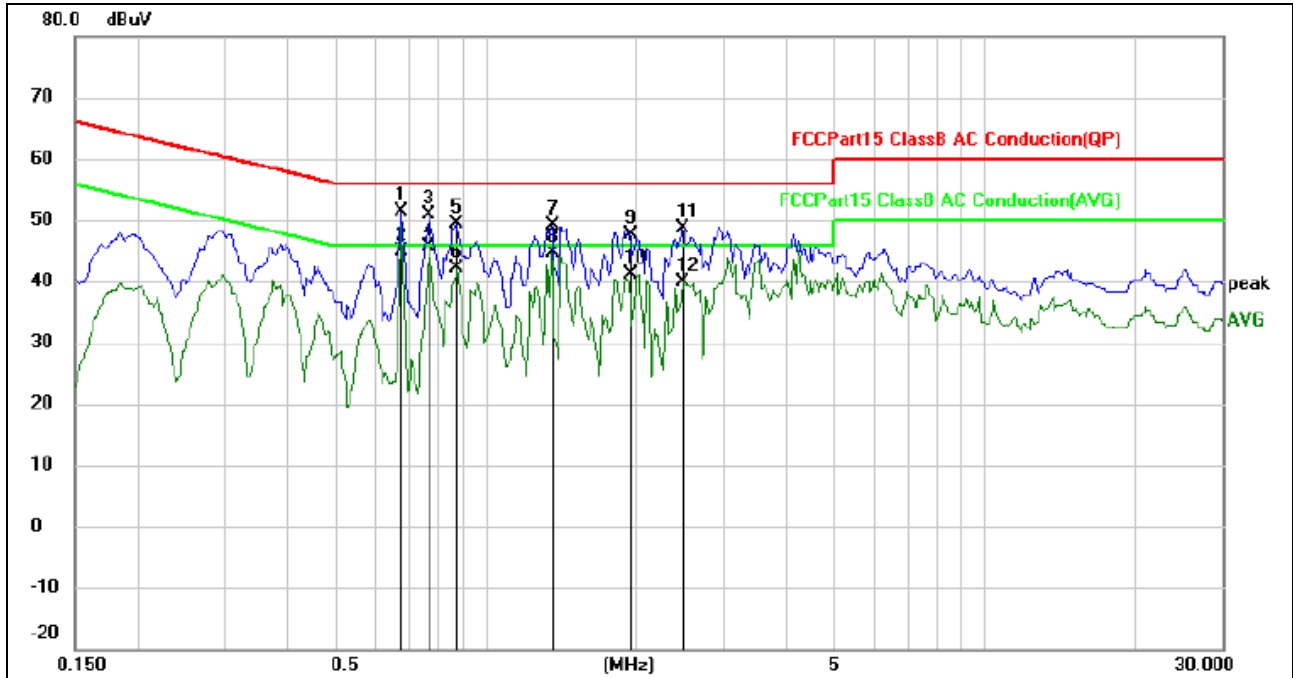

No.	Mk.	Freq.	Reading Level	Correct Factor	Measurement	Limit	Over	Detector	Comment
		MHz	dBuV	dB	dBuV	dBuV	dB		
1		0.6773	51.49	-0.03	51.46	56.00	-4.54	QP	
2		0.6773	45.03	-0.03	45.00	46.00	-1.00	AVG	
3		0.7711	51.01	-0.03	50.98	56.00	-5.02	QP	
4	*	0.7711	45.69	-0.03	45.66	46.00	-0.34	AVG	
5		0.8727	49.32	-0.04	49.28	56.00	-6.72	QP	
6		0.8727	42.26	-0.04	42.22	46.00	-3.78	AVG	
7		1.3569	49.09	-0.04	49.05	56.00	-6.95	QP	
8		1.3569	44.75	-0.04	44.71	46.00	-1.29	AVG	
9		1.9391	47.79	-0.05	47.74	56.00	-8.26	QP	
10		1.9391	41.25	-0.05	41.20	46.00	-4.80	AVG	
11		2.4820	48.69	-0.05	48.64	56.00	-7.36	QP	
12		2.4820	40.02	-0.05	39.97	46.00	-6.03	AVG	



EUT :	Tablet PC	Model Name. :	Hi9 Air-CWI546
Temperature :	26 °C	Relative Humidity :	54%
Pressure :	1010hPa	Phase :	N
Test Voltage :	DC 5V from adapter AC 120V/60Hz	Test Mode :	Normal link

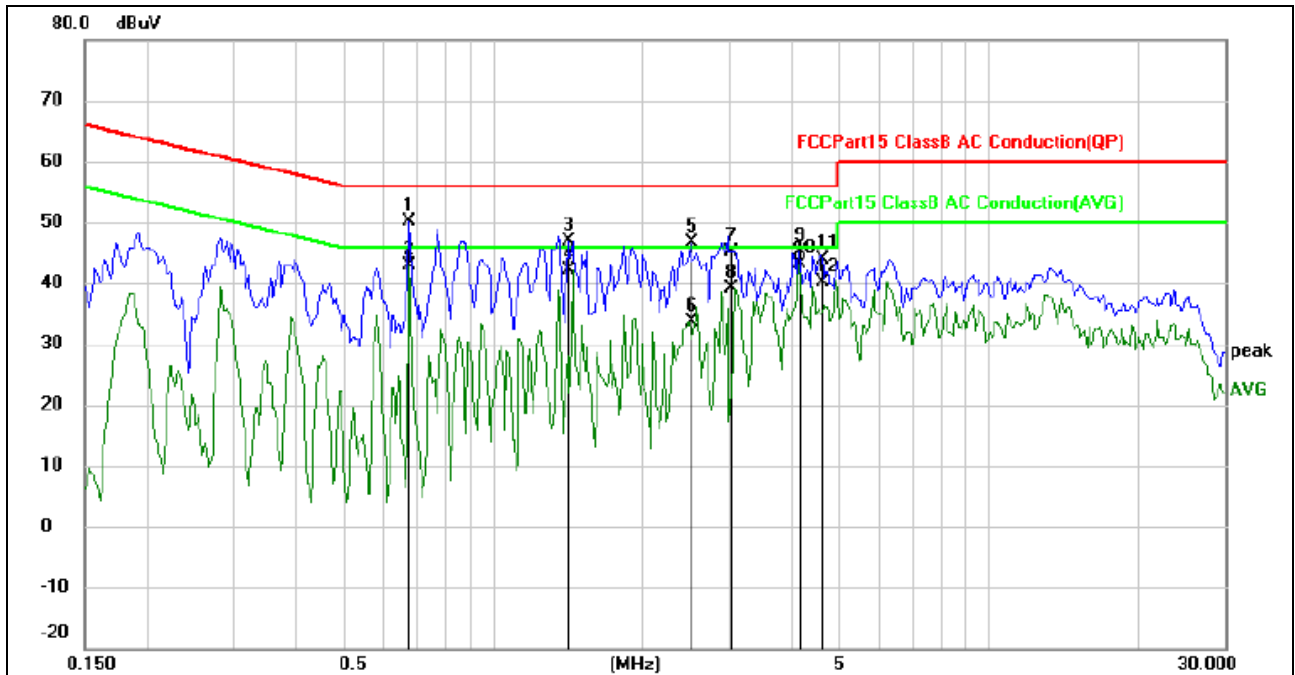

No.	Mk.	Freq. MHz	Reading Level dBuV	Correct Factor dB	Measure- ment dBuV	Limit dBuV	Over dB	Detector	Comment
1		0.6773	50.27	-0.03	50.24	56.00	-5.76	QP	
2		0.6773	42.92	-0.03	42.89	46.00	-3.11	AVG	
3		1.4234	46.96	-0.04	46.92	56.00	-9.08	QP	
4		1.4234	42.20	-0.04	42.16	46.00	-3.84	AVG	
5		2.5016	46.59	-0.05	46.54	56.00	-9.46	QP	
6		2.5016	33.72	-0.05	33.67	46.00	-12.33	AVG	
7		3.0253	45.26	-0.04	45.22	56.00	-10.78	QP	
8		3.0253	39.20	-0.04	39.16	46.00	-6.84	AVG	
9		4.1367	45.08	-0.05	45.03	56.00	-10.97	QP	
10	*	4.1367	43.07	-0.05	43.02	46.00	-2.98	AVG	
11		4.6223	44.04	-0.06	43.98	56.00	-12.02	QP	
12		4.6223	40.14	-0.06	40.08	46.00	-5.92	AVG	

EUT :	Tablet PC	Model Name. :	Hi9 Air-CWI546
Temperature :	26 °C	Relative Humidity :	54%
Pressure :	1010hPa	Phase :	L
Test Voltage :	DC 5V from adapter AC 240V/60Hz	Test Mode :	Normal link

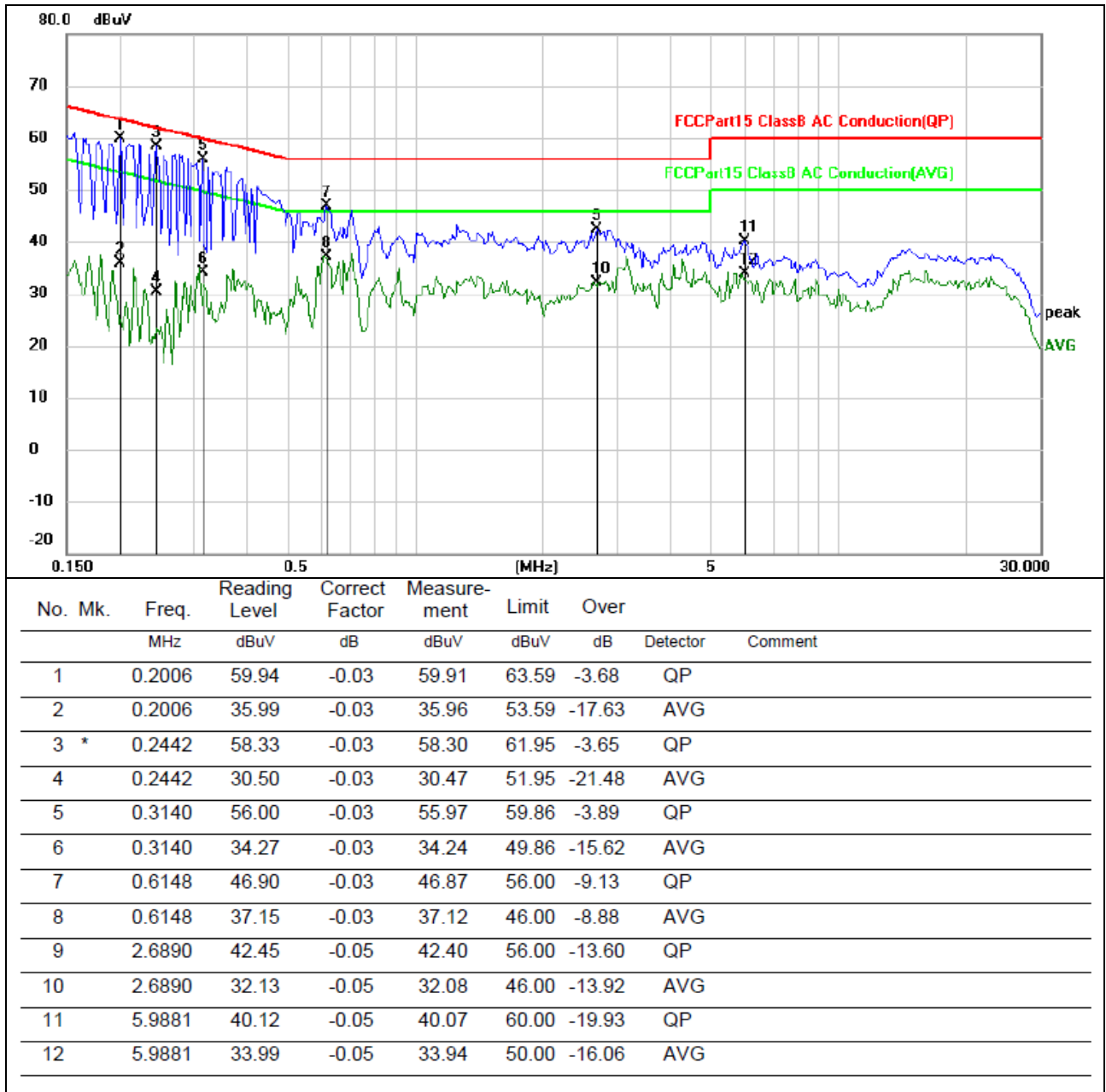

EUT :	Tablet PC	Model Name. :	Hi9 Air-CWI546
Temperature :	26 °C	Relative Humidity :	54%
Pressure :	1010hPa	Phase :	N
Test Voltage :	DC 5V from adapter AC 240V/60Hz	Test Mode :	Normal link

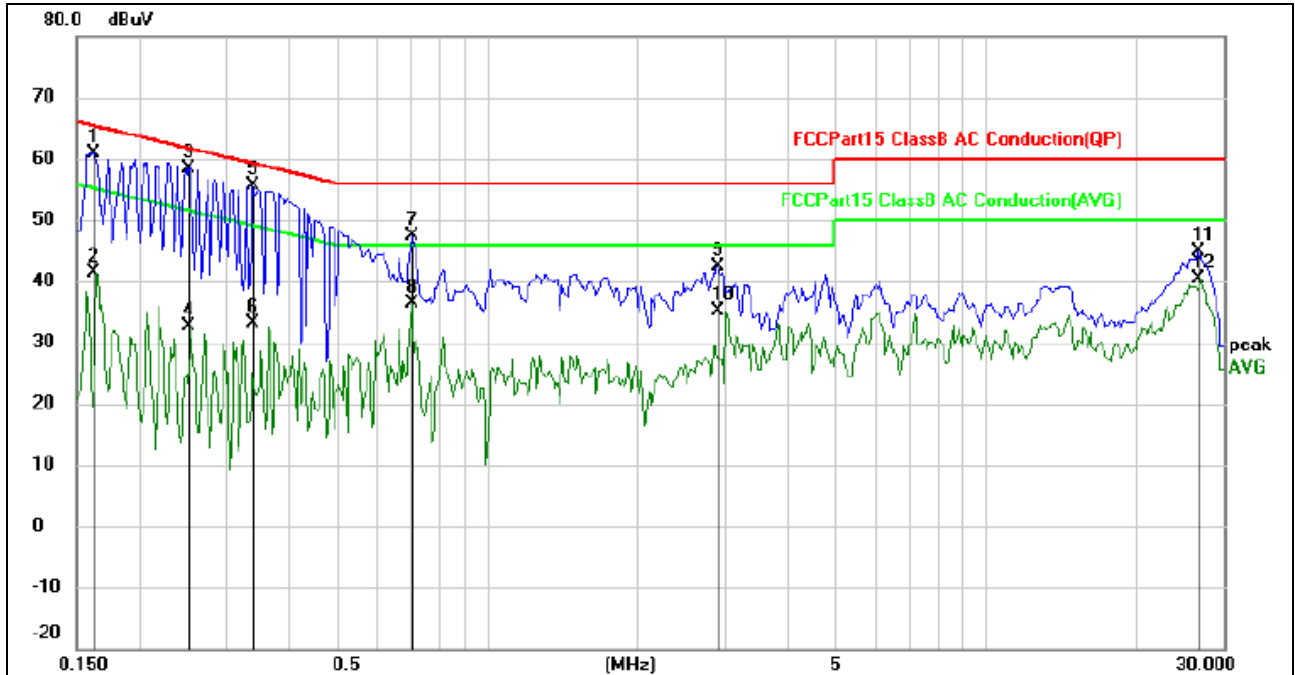

No.	Mk.	Freq. MHz	Reading Level dBuV	Correct Factor dB	Measure- ment dBuV	Limit dBuV	Over dB	Detector	Comment
1		0.1617	60.90	-0.03	60.87	65.38	-4.51	QP	
2		0.1617	41.38	-0.03	41.35	55.38	-14.03	AVG	
3	*	0.2519	58.34	-0.03	58.31	61.69	-3.38	QP	
4		0.2519	32.71	-0.03	32.68	51.69	-19.01	AVG	
5		0.3375	55.65	-0.03	55.62	59.26	-3.64	QP	
6		0.3375	33.10	-0.03	33.07	49.26	-16.19	AVG	
7		0.7046	47.33	-0.03	47.30	56.00	-8.70	QP	
8		0.7046	36.31	-0.03	36.28	46.00	-9.72	AVG	
9		2.8921	42.35	-0.04	42.31	56.00	-13.69	QP	
10		2.8921	35.07	-0.04	35.03	46.00	-10.97	AVG	
11		26.5742	45.19	-0.34	44.85	60.00	-15.15	QP	
12		26.5742	40.74	-0.34	40.40	50.00	-9.60	AVG	

## 5.4 Radiated spurious emission

### 5.4.1 Limits

Frequency (MHz)	Field Strength (micorvolts/meter)	Measurement Distance (meters)
0.009~0.490	2400/F(KHz)	300
0.490~1.705	24000/F(KHz)	30
1.705~30.0	30	30
30~88	100	3
88~216	150	3
216~960	200	3
Above 960	500	3

Spectrum Parameter	Setting
Attenuation	Auto
Start Frequency	1000 MHz
Stop Frequency	10th carrier harmonic
RB / VB (emission in restricted band)	1 MHz / 1 MHz for Peak, 1 MHz / 10Hz for Average

Receiver Parameter	Setting
Attenuation	Auto
Start ~ Stop Frequency	9kHz~150kHz / RB 200Hz for QP
Start ~ Stop Frequency	150kHz~30MHz / RB 9kHz for QP
Start ~ Stop Frequency	30MHz~1000MHz / RB 120kHz for QP

5.4.2 Test setup

Radiated emission test-up frequency below 30MHz

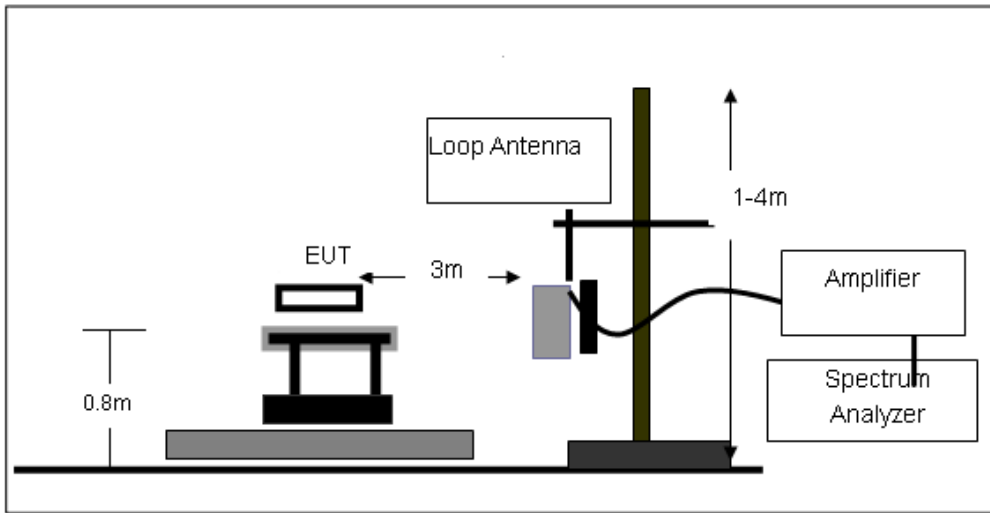

Radiated emission test-up frequency 30MHz~1GHz

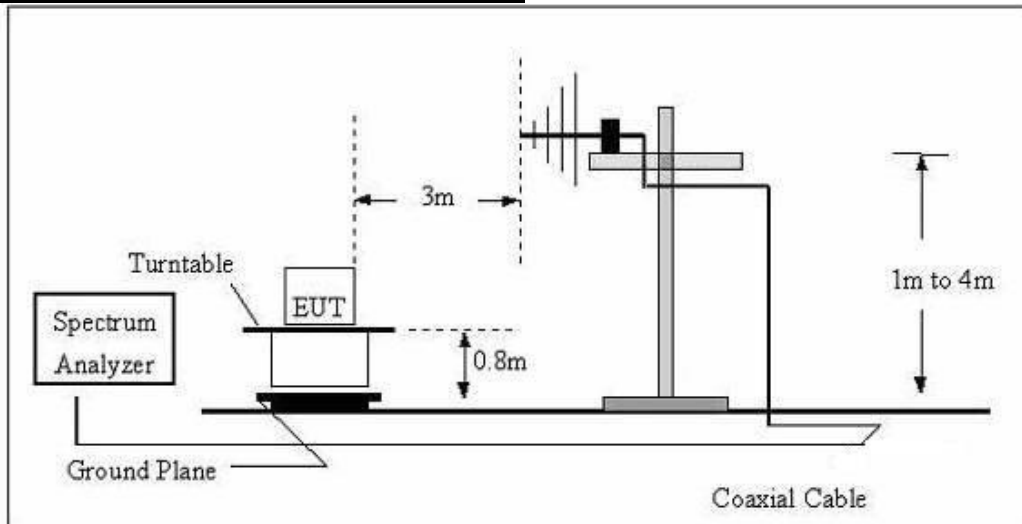

Radiated emission test-up frequency above 1GHz

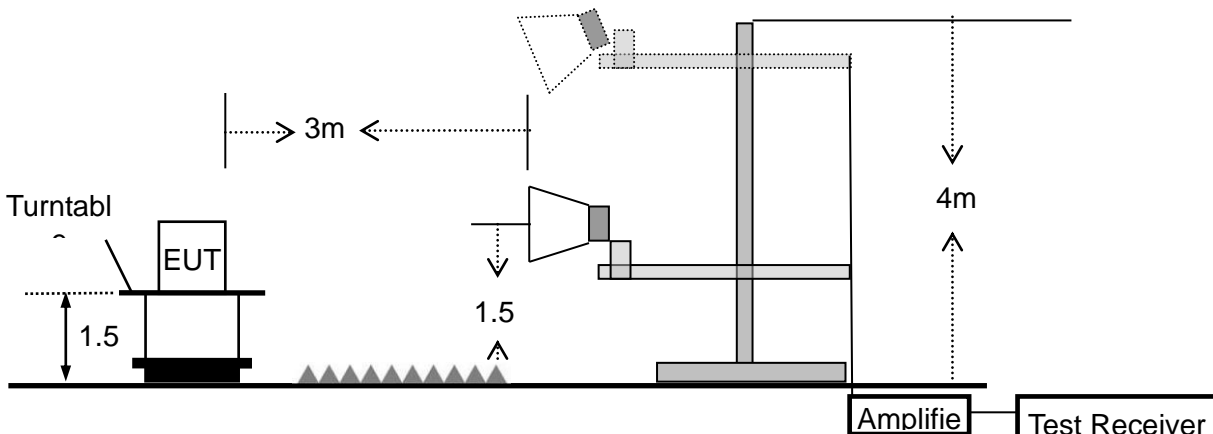

### 5.4.3 Test procedure

- a. EUT operating conditions. The EUT tested system was configured as the statements of 2.4 Unless otherwise a special operating condition is specified in the follows during the testing.
- b. The measuring distance of at 3 m shall be used for measurements at frequency up to 1GHz. For frequencies above 1GHz, any suitable measuring distance may be used.
- c. The EUT was placed on the top of a rotating table 0.8 meters above the ground at a 3 meter shield area test site. The table was rotated 360 degrees to determine the position of the highest radiation.
- d. The height of the equipment or of the substitution antenna shall be 0.8 m; the height of the test antenna shall vary between 1 m to 4 m. Both horizontal and vertical polarizations of the antenna are set to make the measurement.
- e. The initial step in collecting conducted emission data is a spectrum analyzer peak detector mode pre-scanning the measurement frequency range. Significant peaks are then marked and then Quasi Peak detector mode re-measured.
- f. If the Peak Mode measured value compliance with and lower than Quasi Peak Mode Limit, the EUT shall be deemed to meet QP Limits and then no additional QP Mode measurement performed.
- g. For the actual test configuration, please refer to the related Item –EUT Test photos.

Note: Both horizontal and vertical antenna polarities were tested and performed pretest to three orthogonal axis. The worst case emissions were reported.

During the radiated emission test, the Spectrum Analyzer was set with the following configurations:

Frequency Band (MHz)	Function	Resolution bandwidth	Video Bandwidth
30 to 1000	QP	120 kHz	300 kHz
Above 1000	Peak	1 MHz	1 MHz
	Average	1 MHz	10 Hz

Note: for the frequency ranges below 30 MHz, a narrower RBW is used for these ranges but the measured value should add a RBW correction factor (RBWCF) where  $RBWCF [dB] = 10 \cdot \lg(100 [kHz] / \text{narrower RBW [kHz]})$ . , the narrower RBW is 1 kHz and RBWCF is 20 dB for the frequency 9 kHz to 150 kHz, and the narrower RBW is 10 kHz and RBWCF is 10 dB for the frequency 150 kHz to 30 MHz.

5.4.4 Test results

5.4.4.1 Radiation emission

Below 30MHz

EUT:	Tablet PC	Model Name:	Hi9 Air-CWI546
Temperature:	20 °C	Relative Humidity:	48%
Pressure:	1010 hPa	Test Voltage:	DC 5V from adapter
Test Mode:	TX	Polarization :	--

Freq.	Reading	Limit	Margin	State
(MHz)	(dBuV/m)	(dBuV/m)	(dB)	P/F
--	--	--	--	Pass
--	--	--	--	Pass

Note:

The amplitude of spurious emissions which are attenuated by more than 20dB below the permissible value has no need to be reported.

Distance extrapolation factor =  $40 \log(\text{specific distance}/\text{test distance})$ (dB);

Limit line = specific limits(dBuV) + distance extrapolation factor.

Between 30MHz – 1GHz:

All the modulation modes have been tested, and the worst result was report as below:

EUT :	Tablet PC	Model Name :	Hi9 Air-CW1546
Relative Humidity:	52%	Phase:	H
Pressure:	1010 hPa	Test Voltage :	DC 5V from adapter
Test Mode :	Normal link		

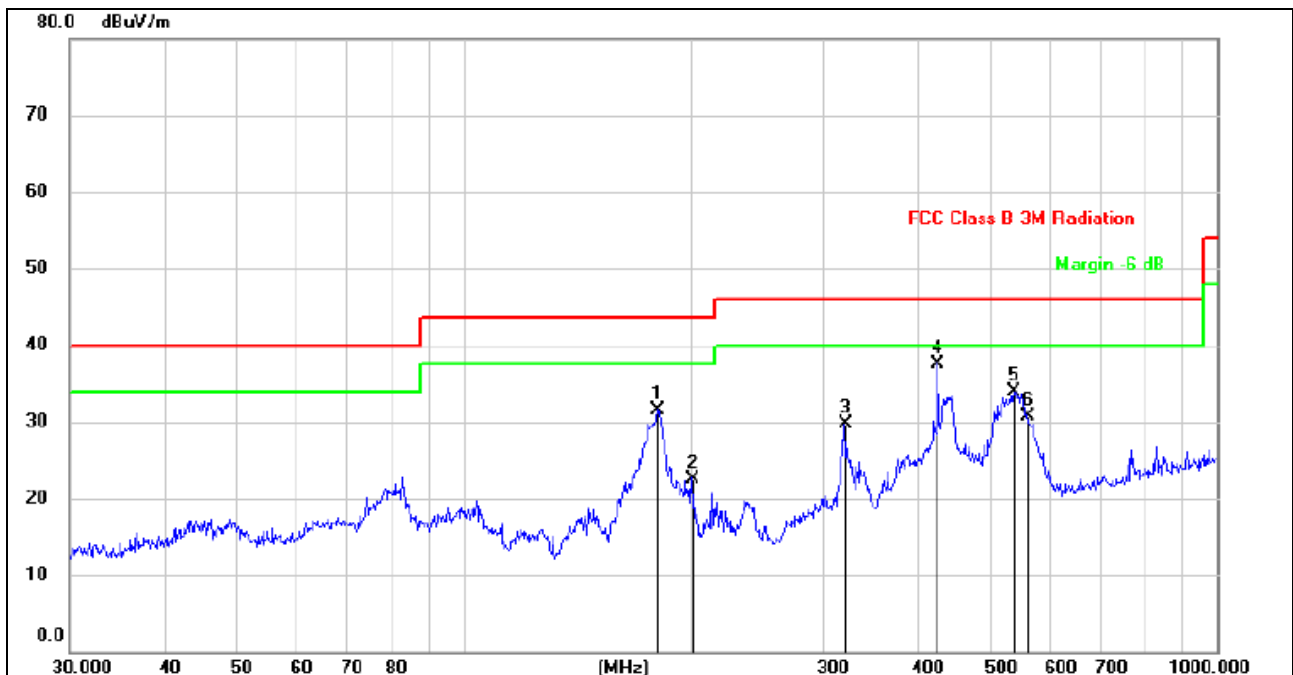

No.	Mk.	Freq. MHz	Reading Level dBuV	Correct Factor dBuV/m	Measure- ment dBuV/m	Limit dBuV/m	Over dB	Detector
1		180.6488	46.29	-14.69	31.60	43.50	-11.90	QP
2		200.6881	34.30	-11.70	22.60	43.50	-20.90	QP
3		319.9370	37.91	-8.21	29.70	46.00	-16.30	QP
4	*	426.5210	43.76	-6.16	37.60	46.00	-8.40	QP
5		537.5891	39.08	-5.18	33.90	46.00	-12.10	QP
6		558.7302	36.03	-5.23	30.80	46.00	-15.20	QP



EUT :	Tablet PC	Model Name :	Hi9 Air-CWI546
Relative Humidity:	52%	Phase:	L
Pressure:	1010 hPa	Test Voltage :	DC 5V from adapter
Test Mode :	Normal link		

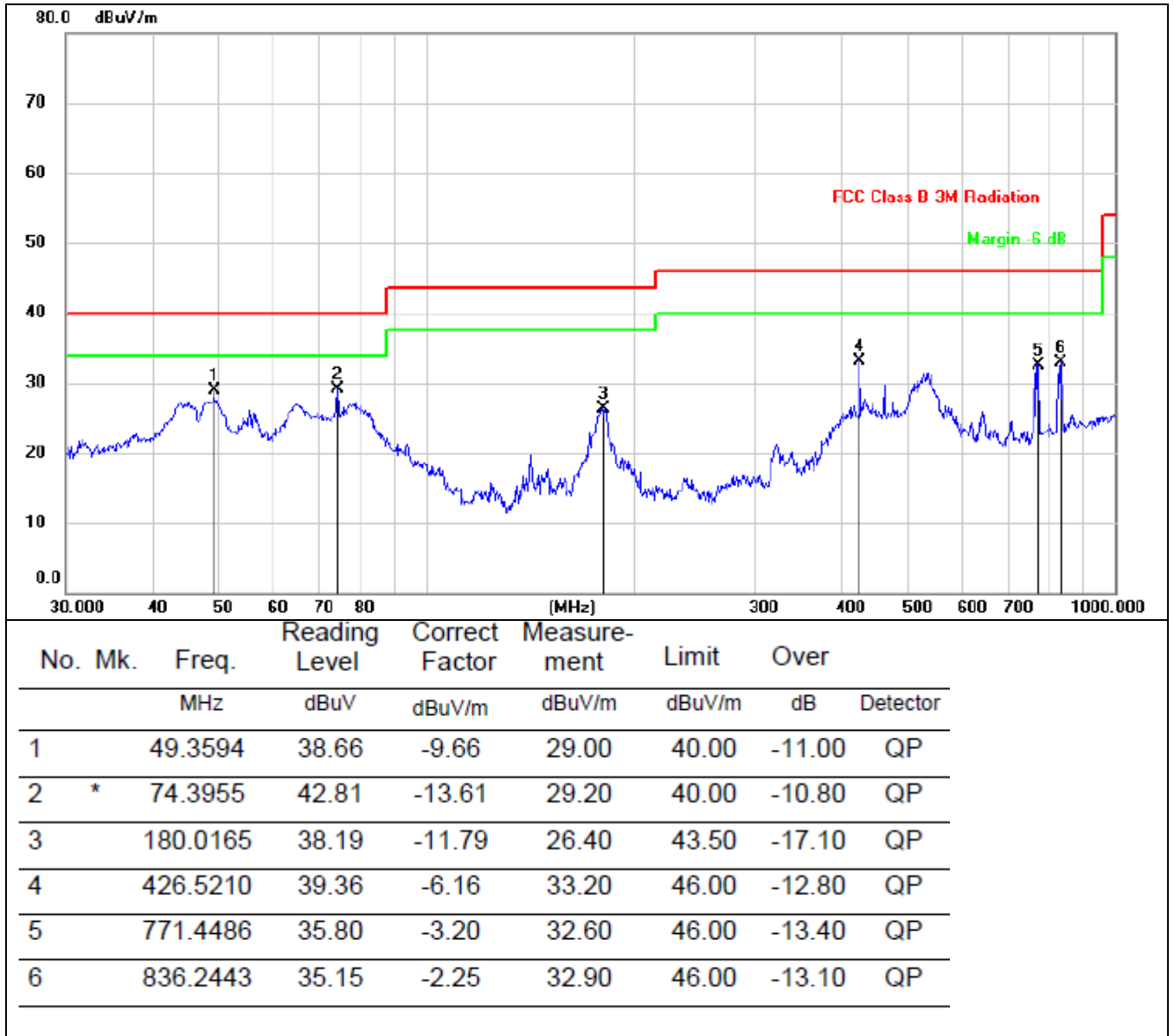

**1G-25GHz**

- Note: (1) All Readings are Peak Value (VBW=3MHz) and AV Value (VBW=10Hz).  
 (2) Emission Level= Antenna Factor + Cable Loss + Read Level - Preamp Factor  
 (3) All other emissions more than 20dB below the limit.

All the modulation modes have been tested, and the worst result was report as below:

Frequency (MHz)	Read Level (dBμV)	Cable loss (dB)	Antenna Factor dB/m	Preamp Factor (dB)	Emission Level (dBμV/m)	Limits (dBμV/m)	Margin (dB)	Remark	Comment
Low Channel (2402 MHz)-Above 1G									
4804.338	63.04	5.21	35.59	44.30	59.54	74.00	-14.46	Pk	Vertical
4804.338	41.46	5.21	35.59	44.30	37.96	54.00	-16.04	AV	Vertical
7206.107	61.83	6.48	36.27	44.60	59.98	74.00	-14.02	Pk	Vertical
7206.107	42.28	6.48	36.27	44.60	40.43	54.00	-13.57	AV	Vertical
4804.169	63.42	5.21	35.55	44.30	59.88	74.00	-14.12	Pk	Horizontal
4804.169	42.00	5.21	35.55	44.30	38.46	54.00	-15.54	AV	Horizontal
7206.214	62.22	6.48	36.27	44.52	60.45	74.00	-13.55	Pk	Horizontal
7206.214	41.24	6.48	36.27	44.52	39.47	54.00	-14.53	AV	Horizontal
Mid Channel (2440 MHz)-Above 1G									
4880.473	63.28	5.21	35.66	44.20	59.95	74.00	-14.05	Pk	Vertical
4880.473	43.23	5.21	35.66	44.20	39.90	54.00	-14.10	AV	Vertical
7320.265	65.28	7.10	36.50	44.43	64.45	74.00	-9.55	Pk	Vertical
7320.265	42.08	7.10	36.50	44.43	41.25	54.00	-12.75	AV	Vertical
4880.366	61.95	5.21	35.66	44.20	58.62	74.00	-15.38	Pk	Horizontal
4880.366	40.93	5.21	35.66	44.20	37.60	54.00	-16.40	AV	Horizontal
7320.234	59.58	7.10	36.50	44.43	58.75	74.00	-15.25	Pk	Horizontal
7320.234	43.53	7.10	36.50	44.43	42.70	54.00	-11.30	AV	Horizontal
High Channel (2480 MHz)- Above 1G									
4960.482	63.70	5.21	35.52	44.21	60.22	74.00	-13.78	Pk	Vertical
4960.482	41.63	5.21	35.52	44.21	38.15	54.00	-15.85	AV	Vertical
7440.131	64.60	7.10	36.53	44.60	63.63	74.00	-10.37	Pk	Vertical
7440.131	49.01	7.10	36.53	44.60	48.04	54.00	-5.96	AV	Vertical
4960.326	64.38	5.21	35.52	44.21	60.90	74.00	-13.10	Pk	Horizontal
4960.326	44.88	5.21	35.52	44.21	41.40	54.00	-12.60	AV	Horizontal
7440.199	63.93	7.10	36.53	44.60	62.96	74.00	-11.04	Pk	Horizontal
7440.199	44.52	7.10	36.53	44.60	43.55	54.00	-10.45	AV	Horizontal

5.4.4.2 Bandedge-radiated

- Note: (1) All Readings are Peak Value (VBW=3MHz) and AV Value (VBW=10Hz).  
 (2) Emission Level= Antenna Factor + Cable Loss + Read Level - Preamp Factor  
 (3) All other emissions more than 20dB below the limit.

All the modulation modes have been tested, and the worst result was report as below:

Frequency (MHz)	Meter Reading (dBμV)	Cable Loss (dB)	Antenna Factor dB/m	Preamp Factor (dB)	Emission Level (dBμV/m)	Limits (dBμV/m)	Margin (dB)	Detector Type	Comment
GFSK									
2310.00	64.25	2.97	27.80	43.80	51.22	74	-22.78	Pk	Horizontal
2310.00	42.50	2.97	27.80	43.80	29.47	54	-24.53	AV	Horizontal
2310.00	62.24	2.97	27.80	43.80	49.21	74	-24.79	Pk	Vertical
2310.00	42.32	2.97	27.80	43.80	29.29	54	-24.71	AV	Vertical
2390.00	64.40	3.14	27.21	43.80	50.95	74	-23.05	Pk	Vertical
2390.00	43.85	3.14	27.21	43.80	30.40	54	-23.60	AV	Vertical
2390.00	63.12	3.14	27.21	43.80	49.67	74	-24.33	Pk	Horizontal
2390.00	41.70	3.14	27.21	43.80	28.25	54	-25.75	AV	Horizontal
2483.50	62.21	3.58	27.70	44.00	49.49	74	-24.51	Pk	Vertical
2483.50	42.60	3.58	27.70	44.00	29.88	54	-24.12	AV	Vertical
2483.50	65.81	3.58	27.70	44.00	53.09	74	-20.91	Pk	Horizontal
2483.50	44.22	3.58	27.70	44.00	31.50	54	-22.50	AV	Horizontal

5.4.4.3 Spurious Emission in Restricted Band 3260MMHz-18000MHZ

All the modulation modes have been tested, and the worst result was report as below:

Frequency (MHz)	Reading Level (dB $\mu$ V)	Cable Loss (dB)	Antenna Factor (dB/m)	Preamp Factor (dB)	Emission Level (dB $\mu$ V/m)	Limits (dB $\mu$ V/m)	Margin (dB)	Detector Type	Comment
3260	62.36	4.04	29.57	44.70	51.27	74	-22.73	Pk	Vertical
3260	56.60	4.04	29.57	44.70	45.51	54	-8.49	AV	Vertical
3260	65.35	4.04	29.57	44.70	54.26	74	-19.74	Pk	Horizontal
3260	57.32	4.04	29.57	44.70	46.23	54	-7.77	AV	Horizontal
3332	65.14	4.26	29.87	44.40	54.87	74	-19.13	Pk	Vertical
3332	55.34	4.26	29.87	44.40	45.07	54	-8.93	AV	Vertical
3332	64.63	4.26	29.87	44.40	54.36	74	-19.64	Pk	Horizontal
3332	51.32	4.26	29.87	44.40	41.05	54	-12.95	AV	Horizontal
17797	44.24	10.99	43.95	43.50	55.68	74	-18.32	Pk	Vertical
17797	34.00	10.99	43.95	43.50	45.44	54	-8.56	AV	Vertical
17788	44.51	11.81	43.69	44.60	55.41	74	-18.59	Pk	Horizontal
17788	35.65	11.81	43.69	44.60	46.55	54	-7.45	AV	Horizontal

## 5.5 Power spectral density test

### 5.5.1 Limit

FCC Part15 (15.247) , Subpart C			
Section	Test Item	Limit	Frequency Range (MHz)
15.247	Power Spectral Density	8 dBm (in any 3KHz)	2400-2483.5

### 5.5.2 Test procedure

1. Set analyzer center frequency to DTS channel center frequency.
2. Set the span to 1.5 times the DTS channel bandwidth.
3. Set the RBW  $\geq$  3 kHz.
4. Set the VBW  $\geq$  3 x RBW.
5. Detector = peak.
6. Sweep time = auto couple.
7. Trace mode = max hold.
8. Allow trace to fully stabilize.
9. Use the peak marker function to determine the maximum amplitude level.
10. If measured value exceeds limit, reduce RBW (no less than 3 kHz) and repeat.

### 5.5.3 Test setup



### 5.5.4 EUT operation conditions

The EUT tested system was configured as the statements of 2.1 Unless otherwise a special operating condition is specified in the follows during the testing

5.5.5 Test results

EUT :	Tablet PC	Model Name :	Hi9 Air-CWI546
Temperature :	25 °C	Relative Humidity :	60%
Pressure :	1015 hPa	Test Voltage :	DC 3.8V by battery
Test Mode :	TX Mode /CH00, CH19, CH39		

Frequency	Power Density (dBm/3KHz)	Limit (dBm/3KHz)	Result
2402 MHz	-14.278	8	PASS
2440 MHz	-13.678	8	PASS
2480 MHz	-11.791	8	PASS

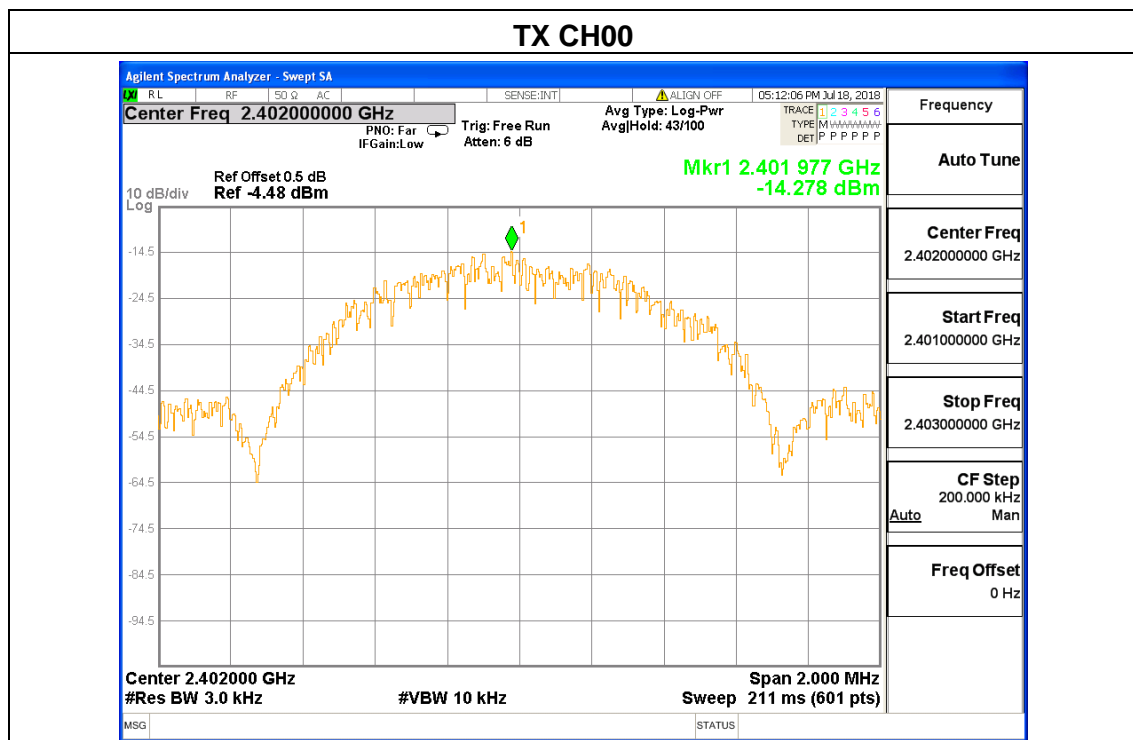

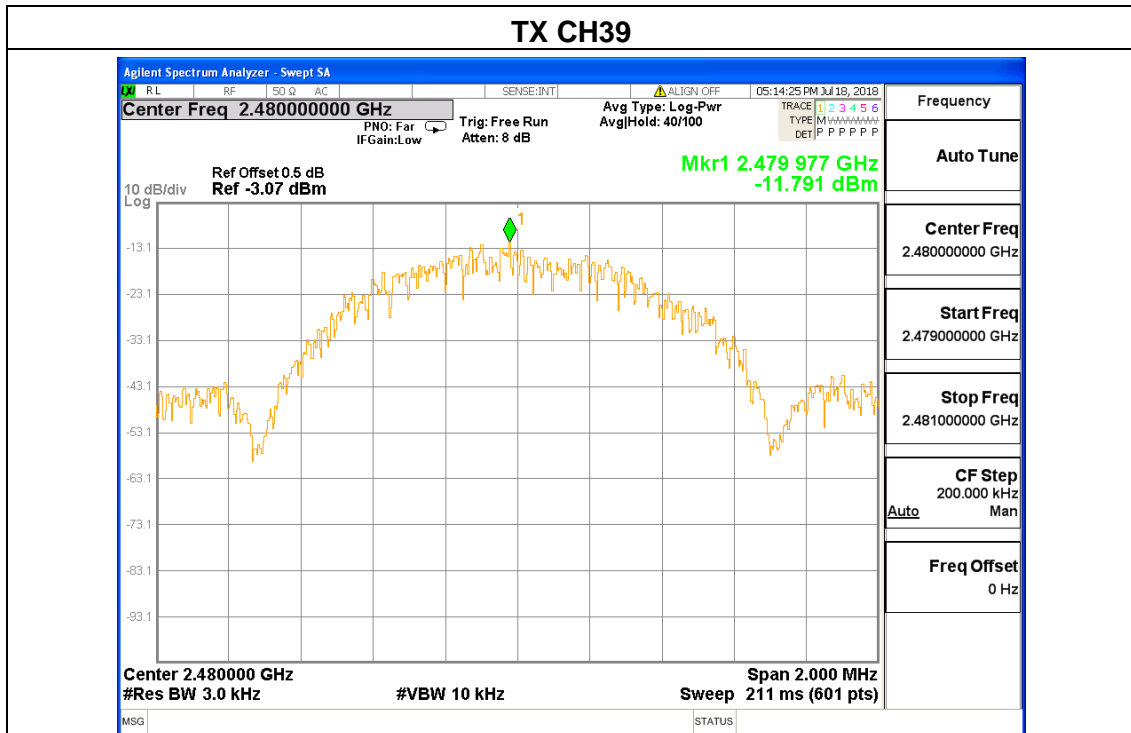
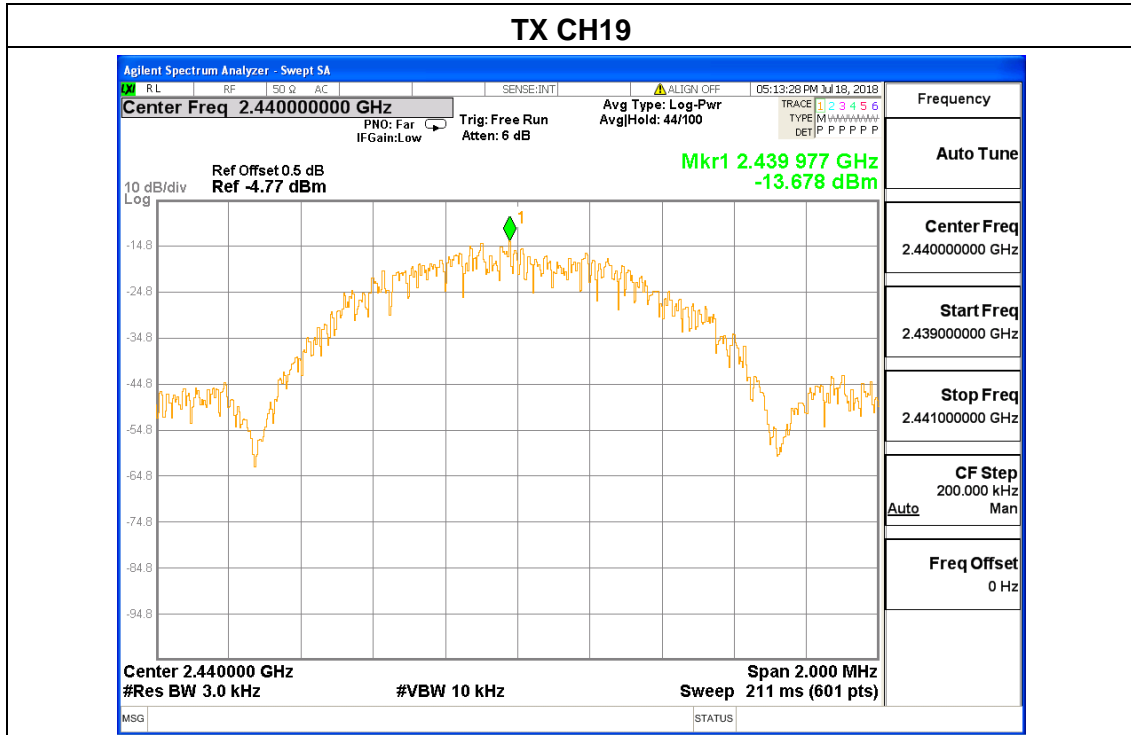

5.6 6dB bandwidth

5.6.1 Limit

FCC Part15 (15.247) , Subpart C			
Section	Test Item	Limit	Frequency Range (MHz)
15.247(a)(2)	Bandwidth	$\geq 500\text{KHz}$ (6dB bandwidth)	2400-2483.5

5.6.2 TEST PROCEDURE

1. Set RBW= 100 kHz.
2. Set the video bandwidth (VBW)  $\geq 3 \times$  RBW.
3. Detector = Peak.
4. Trace mode = max hold.
5. Sweep = auto couple.
6. Allow the trace to stabilize.
7. Measure the maximum width of the emission that is constrained by the frequencies associated with the two outermost amplitude points (upper and lower) that are attenuated by 6 dB relative to the maximum level measured in the fundamental emission.

5.6.3 TEST SETUP

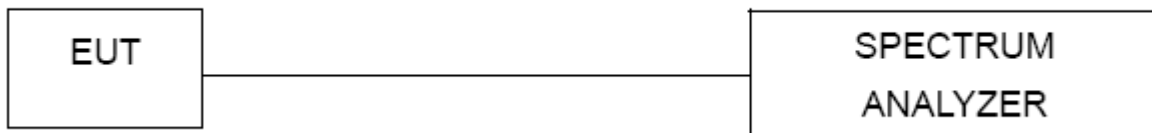

5.6.4 EUT operation conditions

The EUT tested system was configured as the statements of 2.1 Unless otherwise a special operating condition is specified in the follows during the testing

5.6.5 Test Result



EUT :	Tablet PC	Model Name :	Hi9 Air-CWI546
Temperature :	25 °C	Relative Humidity :	60%
Pressure :	1012 hPa	Test Voltage :	DC 3.8V by battery
Test Mode :	TX Mode /CH00, CH19, CH39		

Channel	Frequency (MHz)	6dB bandwidth (KHz)	Limit (kHz)	Result
Low	2402	640.3	500	Pass
Middle	2440	642.7	500	Pass
High	2480	646.5	500	Pass

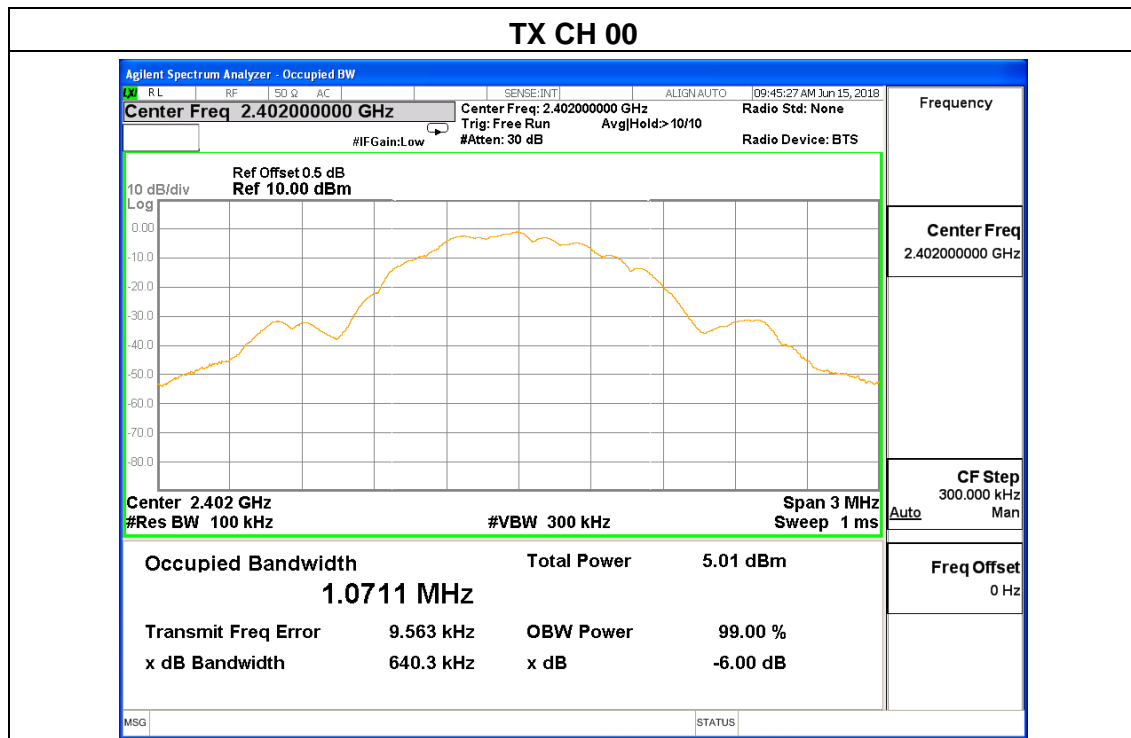

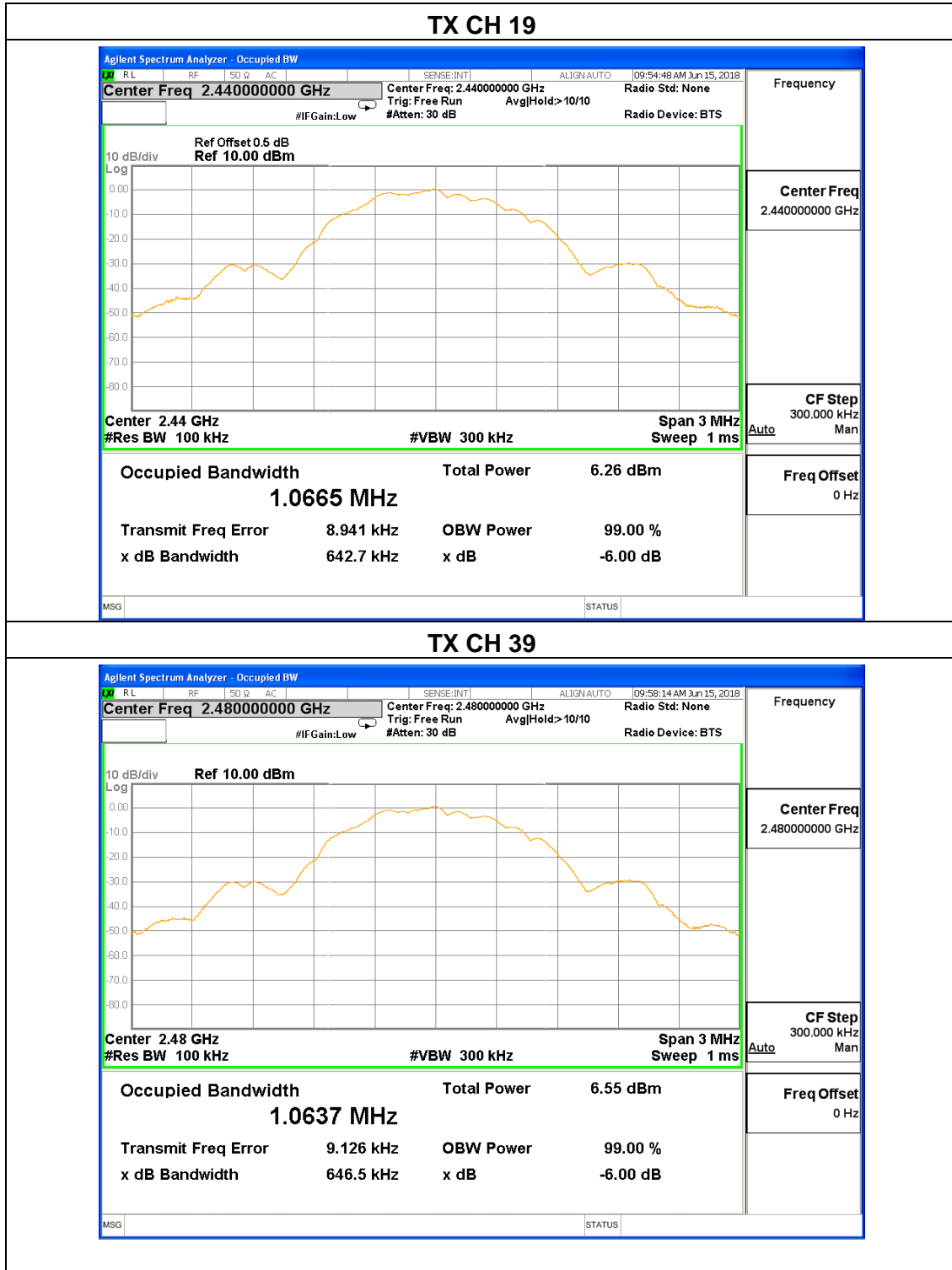

## 5.7 Conducted bandedge

### 5.7.1 Limits

In any 100 kHz bandwidth outside the frequency band in which the spread spectrum or digitally modulated intentional radiator is operating, the radio frequency power that is produced by the intentional radiator shall be at least 20 dB below that in the 100 kHz bandwidth within the band that contains the highest level of the desired power, based on either an RF conducted or a radiated measurement, provided the transmitter demonstrates compliance with the peak conducted power limits. If the transmitter complies with the conducted power limits based on the use of RMS averaging over a time interval, as permitted under paragraph (b)(3) of this section, the attenuation required under this paragraph shall be 30 dB instead of 20 dB. Attenuation below the general limits specified in §15.209(a) is not required. In addition, radiated emissions which fall in the restricted bands, as defined in §15.205(a), must also comply with the radiated emission limits specified in §15.209(a) (see §15.205(c)).

### 5.7.2 Test setup



### 5.7.3 Test procedure

- a) Check the calibration of the measuring instrument using either an internal calibrator or a known signal from an external generator.
- b) Position the EUT without connection to measurement instrument. Turn on the EUT and connect its antenna terminal to measurement instrument via a low loss cable. Then set it to any one measured frequency within its operating range, and make sure the instrument is operated in its linear range.
- c) Set RBW to 100 kHz and VBW of spectrum analyzer to 300 kHz with a convenient frequency span including 100 kHz bandwidth from band edge.
- d) Measure the highest amplitude appearing on spectral display and set it as a reference level. Plot the graph with marking the highest point and edge frequency.
- e) Repeat above procedures until all measured frequencies were complete.

### 5.7.4 EUT operation conditions

The EUT tested system was configured as the statements of 2.1 Unless otherwise a special operating condition is specified in the follows during the testing

### 5.7.5 Test Result

EUT :	Tablet PC	Model Name :	Hi9 Air-CWI546
Temperature :	25 °C	Relative Humidity :	60%
Pressure :	1012 hPa	Test Voltage :	DC 3.8V by battery
Test Mode :	TX Mode /CH00, CH39		

BLE: Band Edge, Left Side

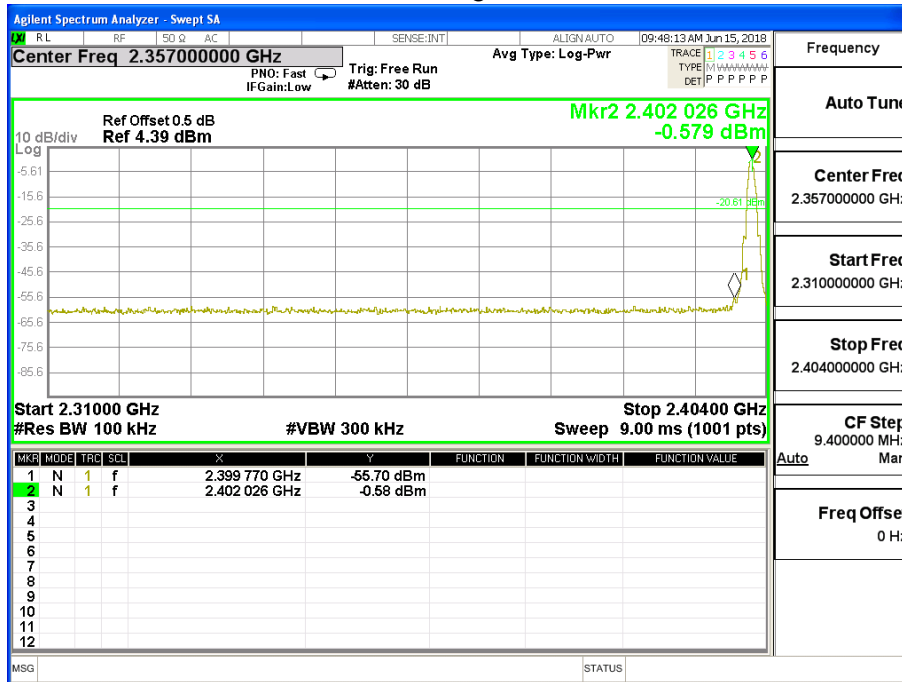

BLE: Band Edge, Right Side

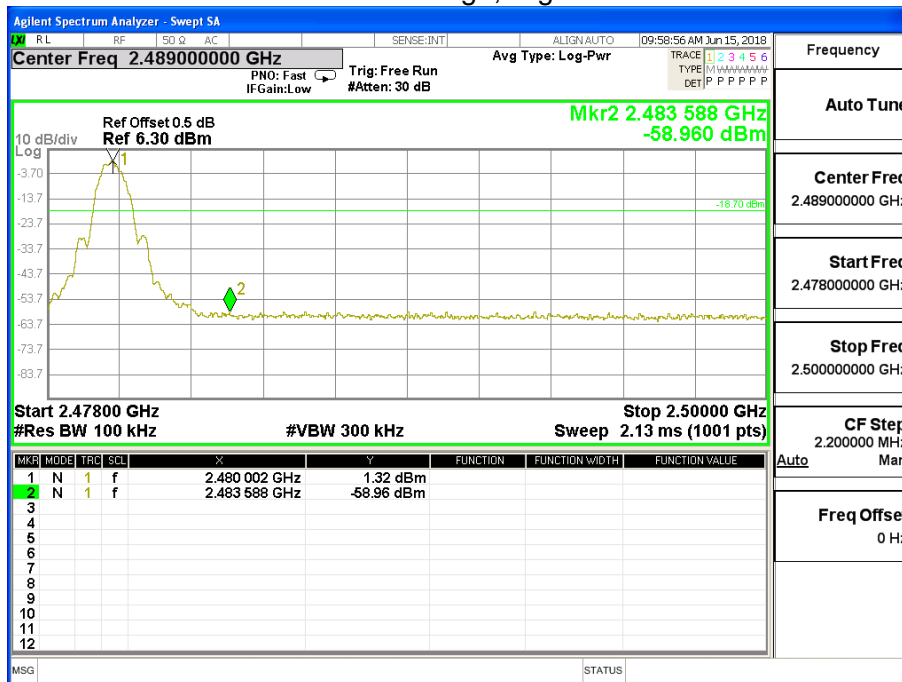

**Photographs of the Test Setup**

Radiated emission

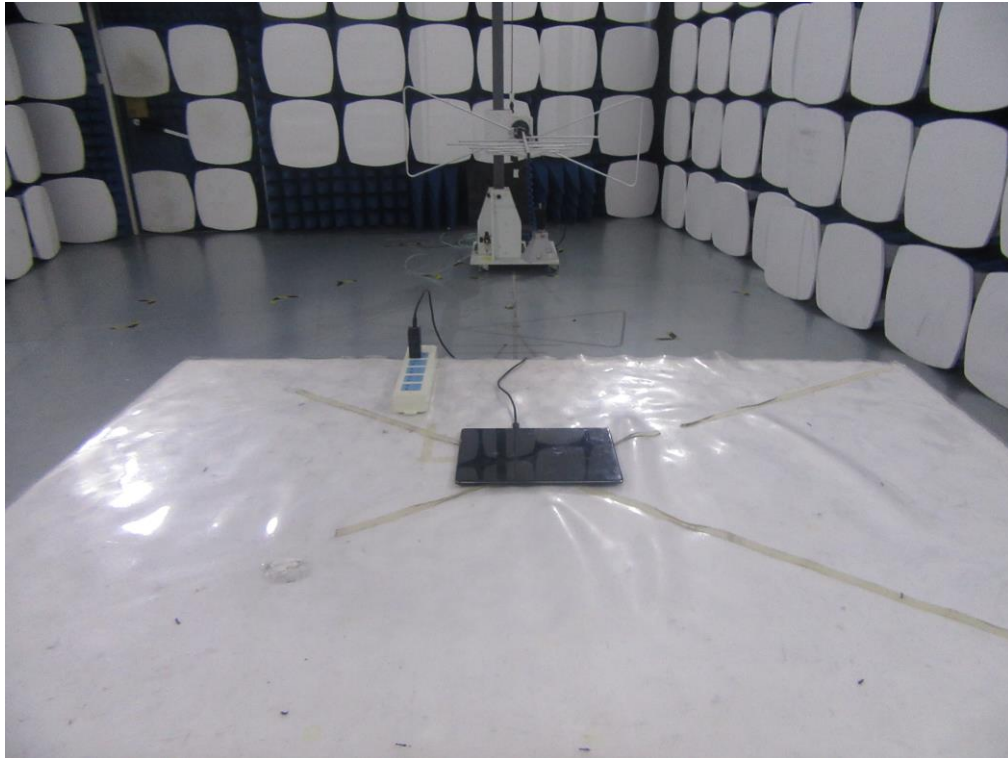

Conducted emission



## **Photographs of the EUT**

See the APPENDIX 1: EUT PHOTO in the report No.: MTi180724E135-1.

**----END OF REPORT----**