

TEST REPORT

Product : Portable PC
Trade mark : CHUWI
Model/Type reference : GemiBook
Serial Number : N/A
Report Number : EED32M00298803
FCC ID : 2AHLZ-GEMIBOOK
Date of Issue : Nov. 09, 2020
Test Standards : 47 CFR Part 15Subpart C
Test result : PASS

Prepared for:

CHUWI TECHNOLOGY (ShenZhen) CO., LIMITED
2 Floor Building 3 LiJinCheng Industrial park
the east of Gongye road LongHua, Shenzhen, China

Prepared by:

Centre Testing International Group Co., Ltd.
Hongwei Industrial Zone, Bao'an 70 District,
Shenzhen, Guangdong, China
TEL: +86-755-3368 3668
FAX: +86-755-3368 3385

Compiled by:

Sunlight Sun

Sunlight Sun

Reviewed by:

Jok Yang

Jok Yang

Approved by:

Aaron Ma

Aaron Ma

Date:

Nov. 09, 2020



Check No: 4762111346

2 Version

Version No.	Date	Description
00	Nov. 09, 2020	Original

3 Test Summary

Test Item	Test Requirement	Test method	Result
Antenna Requirement	47 CFR Part 15 Subpart C Section 15.203/15.247 (c)	ANSI C63.10-2013	PASS
AC Power Line Conducted Emission	47 CFR Part 15 Subpart C Section 15.207	ANSI C63.10-2013	PASS
Conducted Peak Output Power	47 CFR Part 15 Subpart C Section 15.247 (b)(3)	ANSI C63.10-2013	PASS
6dB Occupied Bandwidth	47 CFR Part 15 Subpart C Section 15.247 (a)(2)	ANSI C63.10-2013	PASS
Power Spectral Density	47 CFR Part 15 Subpart C Section 15.247 (e)	ANSI C63.10-2013	PASS
Band-edge for RF Conducted Emissions	47 CFR Part 15 Subpart C Section 15.247(d)	ANSI C63.10-2013	PASS
RF Conducted Spurious Emissions	47 CFR Part 15 Subpart C Section 15.247(d)	ANSI C63.10-2013	PASS
Radiated Spurious Emissions	47 CFR Part 15 Subpart C Section 15.205/15.209	ANSI C63.10-2013	PASS
Restricted bands around fundamental frequency (Radiated Emission)	47 CFR Part 15 Subpart C Section 15.205/15.209	ANSI C63.10-2013	PASS

Remark:

Test according to ANSI C63.4-2014 & ANSI C63.10-2013.

Company Name and Address shown on Report, the sample(s) and sample Information was/ were provided by the applicant who should be responsible for the authenticity which CTI hasn't verified.

4 Content

1 COVER PAGE	1
2 VERSION	2
3 TEST SUMMARY	3
4 CONTENT	4
5 TEST REQUIREMENT	5
5.1 TEST SETUP.....	5
5.1.1 For Conducted test setup.....	5
5.1.2 For Radiated Emissions test setup.....	5
5.1.3 For Conducted Emissions test setup.....	6
5.2 TEST ENVIRONMENT.....	6
5.3 TEST CONDITION.....	6
6 GENERAL INFORMATION	8
6.1 CLIENT INFORMATION.....	8
6.2 GENERAL DESCRIPTION OF EUT.....	8
6.3 PRODUCT SPECIFICATION SUBJECTIVE TO THIS STANDARD.....	8
6.4 DESCRIPTION OF SUPPORT UNITS.....	10
6.5 TEST LOCATION.....	10
6.6 DEVIATION FROM STANDARDS.....	10
6.7 ABNORMALITIES FROM STANDARD CONDITIONS.....	10
6.8 OTHER INFORMATION REQUESTED BY THE CUSTOMER.....	10
6.9 MEASUREMENT UNCERTAINTY (95% CONFIDENCE LEVELS, $K=2$).....	10
7 EQUIPMENT LIST	11
8 RADIO TECHNICAL REQUIREMENTS SPECIFICATION	14
Appendix A): Conducted Peak Output Power.....	19
Appendix B): 6dB Occupied Bandwidth.....	25
Appendix C): Band-edge for RF Conducted Emissions.....	43
Appendix D): RF Conducted Spurious Emissions.....	48
Appendix E): Power Spectral Density.....	62
Appendix F): Antenna Requirement.....	68
Appendix G): AC Power Line Conducted Emission.....	69
Appendix H): Restricted bands around fundamental frequency (Radiated).....	72
Appendix I): Radiated Spurious Emissions.....	105
PHOTOGRAPHS OF TEST SETUP	113
PHOTOGRAPHS OF EUT CONSTRUCTIONAL DETAILS	116

5 Test Requirement

5.1 Test setup

5.1.1 For Conducted test setup

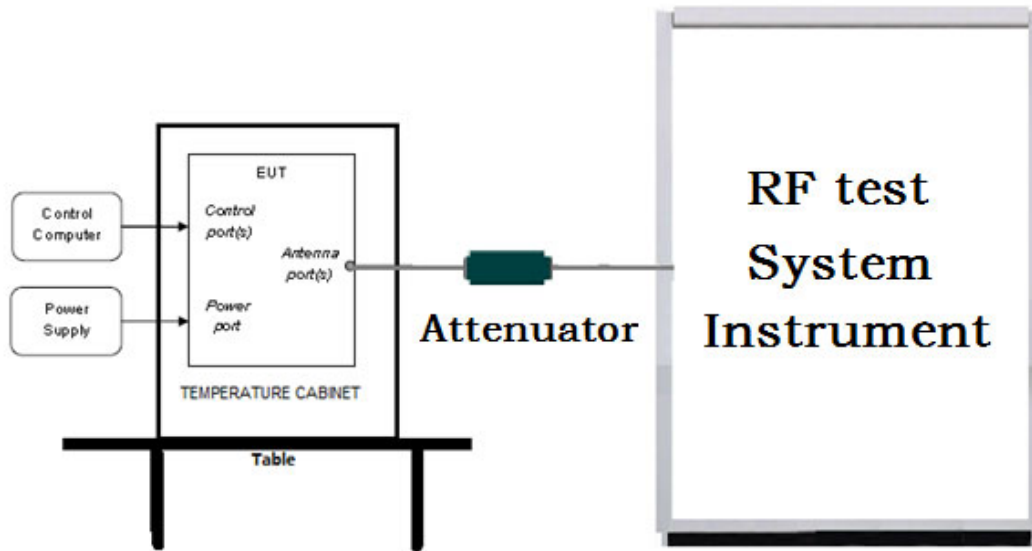

5.1.2 For Radiated Emissions test setup

Radiated Emissions setup:

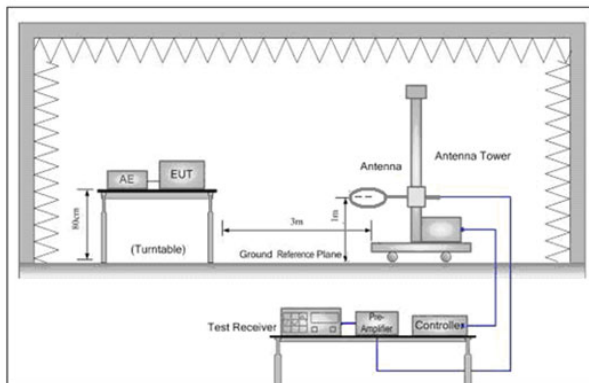

Figure 1. Below 30MHz

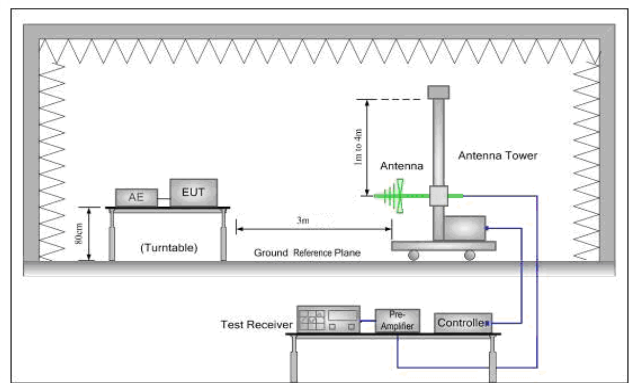

Figure 2. 30MHz to 1GHz

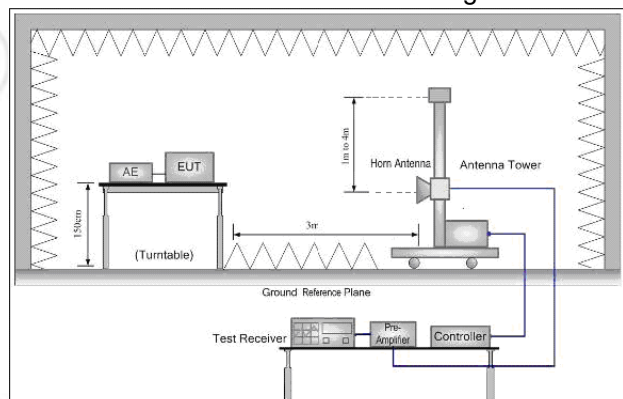
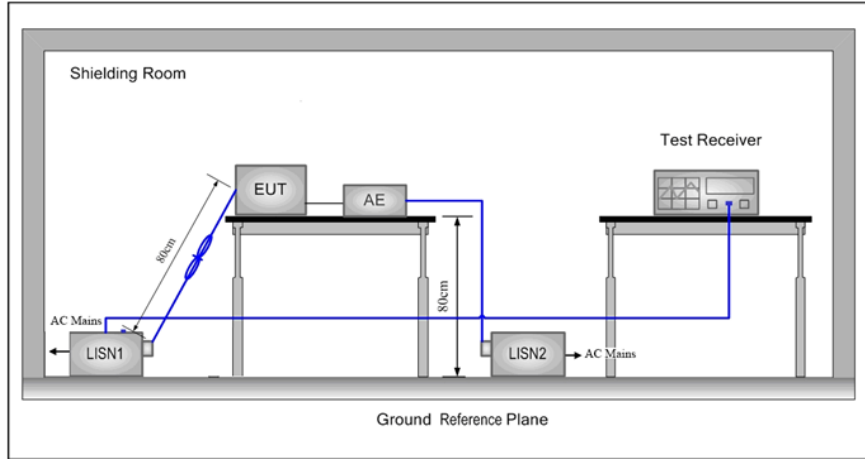

Figure 3. Above 1GHz

5.1.3 For Conducted Emissions test setup
Conducted Emissions setup



5.2 Test Environment

Operating Environment:	
Temperature:	24.0 °C
Humidity:	54 % RH
Atmospheric Pressure:	1010mbar

5.3 Test Condition

Test channel:

Test Mode	Tx/Rx	RF Channel		
		Low(L)	Middle(M)	High(H)
802.11b/g/n(HT20)	2412MHz ~2462 MHz	Channel 1	Channel 6	Channel11
		2412MHz	2437MHz	2462MHz
802.11n(HT40)	2422MHz ~2452 MHz	Channel 3	Channel 6	Channel 9
		2422MHz	2437MHz	2452MHz
Transmitting mode:	Keep the EUT in transmitting mode with all kind of modulation and all kind of data rate.			

Test mode:

Pre-scan under all rate at lowest channel

Mode	802.11b				X				
Data Rate	1Mbps	2Mbps	5.5Mbps	11Mbps					
Power(dBm)	13.43	13.41	13.38	13.35					
Mode	802.11g								
Data Rate	6Mbps	9Mbps	12Mbps	18Mbps	24Mbps	36Mbps	48Mbps	54Mbps	
Power(dBm)	12.98	12.95	12.93	12.90	12.88	12.85	12.83	12.81	
Mode	802.11n (HT20)								
Data Rate	6.5Mbps	13Mbps	19.5Mbps	26Mbps	39Mbps	52Mbps	58.5Mbps	65Mbps	
Power(dBm)	11.22	11.20	11.17	11.14	11.12	11.10	11.08	11.05	
Mode	802.11n (HT40)								
Data Rate	13.5Mbps	27Mbps	40.5Mbps	54Mbps	81Mbps	108Mbps	121.5Mbps	135Mbps	
Power(dBm)	10.74	10.72	10.7	10.68	10.65	10.63	10.62	10.6	

Through Pre-scan, 1Mbps of rate is the worst case of 802.11b; 6Mbps of rate is the worst case of 802.11g; 6.5Mbps of rate is the worst case of 802.11n(HT20); 13.5Mbps of rate is the worst case of 802.11n(HT40).

6 General Information

6.1 Client Information

Applicant:	CHUWI TECHNOLOGY (ShenZhen) CO., LIMITED
Address of Applicant:	2 Floor Building 3 LiJinCheng Industrial park the east of Gongye road LongHua, Shenzhen, China
Manufacturer:	CHUWI TECHNOLOGY (ShenZhen) CO., LIMITED
Address of Manufacturer:	2 Floor Building 3 LiJinCheng Industrial park the east of Gongye road LongHua, Shenzhen, China
Factory:	JIANGSU LUCKYSTAR INTELLIGENT & TECHNOLOGY CO., LTD
Address of Factory:	Inelligent Terminal Pioneer Park (D) ,Yanlong Street Office, Yandu District, Yancheng City, Jiangsu Province

6.2 General Description of EUT

Product Name:	Portable PC	
Model No.(EUT):	GemiBook	
Trade mark:	CHUWI	
Frequency Range of Operation:	IEEE 802.11b/g/n(HT20)(HT40): 2400MHz to 2483.5MHz	
Power Supply:	Adapter	Model:A241-1202000D Input:100-240V~ 50/60Hz 0.8A Output:12.0V---2.0A 24.0W
	Battery	Model:5059B4-2S-1 2ICP5/59/115 Norminal Voltage:7.6Vd.c. Rated Capacity:5000mAh 38Wh
Sample Received Date:	Sep. 21, 2020	
Sample tested Date:	Sep. 21, 2020 to Oct.22, 2020	

6.3 Product Specification subjective to this standard

Operation Frequency:	IEEE 802.11b/g/n(HT20): 2412MHz to 2462MHz IEEE 802.11n(HT40): 2422MHz to 2452MHz
Channel Numbers:	IEEE 802.11b/g, IEEE 802.11n HT20: 11 Channels IEEE 802.11n HT40: 7 Channels
Channel Separation:	5MHz
Type of Modulation:	IEEE for 802.11b: DSSS(CCK,DQPSK,DBPSK) IEEE for 802.11g :OFDM(64QAM, 16QAM, QPSK, BPSK) IEEE for 802.11n(HT20 and HT40) : OFDM (64QAM, 16QAM,QPSK,BPSK)
Test Power Grade:	Default
Test Software of EUT:	DRTU
Antenna Type and Gain:	Type: FPC antenna Gain:1.15 dBi
Test Voltage:	Battery 7.6V

Operation Frequency each of channel(802.11b/g/n HT20)							
Channel	Frequency	Channel	Frequency	Channel	Frequency	Channel	Frequency
1	2412MHz	4	2427MHz	7	2442MHz	10	2457MHz
2	2417MHz	5	2432MHz	8	2447MHz	11	2462MHz
3	2422MHz	6	2437MHz	9	2452MHz		
Operation Frequency each of channel(802.11n HT40)							
Channel	Frequency	Channel	Frequency	Channel	Frequency		
3	2422MHz	6	2437MHz	9	2452MHz		
4	2427MHz	7	2442MHz				
5	2432MHz	8	2447MHz				

6.4 Description of Support Units

The EUT has been tested independently

6.5 Test Location

All tests were performed at:

Centre Testing International Group Co., Ltd
Building C, Hongwei Industrial Park Block 70, Bao'an District, Shenzhen, China
Telephone: +86 (0) 755 33683668 Fax: +86 (0) 755 33683385

No tests were sub-contracted.

FCC Designation No.: CN1164

6.6 Deviation from Standards

None.

6.7 Abnormalities from Standard Conditions

None.

6.8 Other Information Requested by the Customer

None.

6.9 Measurement Uncertainty (95% confidence levels, k=2)

No.	Item	Measurement Uncertainty
1	Radio Frequency	7.9×10^{-8}
2	RF power, conducted	0.46dB (30MHz-1GHz)
		0.55dB (1GHz-18GHz)
3	Radiated Spurious emission test	4.3dB (30MHz-1GHz)
		4.5dB (1GHz-12.75GHz)
4	Conduction emission	3.5dB (9kHz to 150kHz)
		3.1dB (150kHz to 30MHz)
5	Temperature test	0.64°C
6	Humidity test	3.8%
7	DC power voltages	0.026%

7 Equipment List

RF test system					
Equipment	Manufacturer	Mode No.	Serial Number	Cal. Date (mm-dd-yyyy)	Cal. Due date (mm-dd-yyyy)
Spectrum Analyzer	Keysight	N9010A	MY54510339	02-17-2020	02-16-2021
Signal Generator	Keysight	N5182B	MY53051549	02-17-2020	02-16-2021
Temperature/ Humidity Indicator	biaozhi	HM10	1804186	06-29-2020	06-28-2021
High-pass filter	Sinoscite	FL3CX03WG18N M12-0398-002	---	---	---
High-pass filter	MICRO-TRONICS	SPA-F-63029-4	---	---	---
DC Power	Keysight	E3642A	MY56376072	02-17-2020	02-16-2021
PC-1	Lenovo	R4960d	---	---	---
BT&WI-FI Automatic control	R&S	OSP120	101374	02-17-2020	02-16-2021
RF control unit	JS Tonscend	JS0806-2	158060006	02-17-2020	02-16-2021
BT&WI-FI Automatic test software	JS Tonscend	JS1120-3	---	---	---

Conducted disturbance Test					
Equipment	Manufacturer	Model No.	Serial Number	Cal. date (mm-dd-yyyy)	Cal. Due date (mm-dd-yyyy)
Receiver	R&S	ESCI	100435	04-28-2020	04-27-2021
Temperature/ Humidity Indicator	Defu	TH128	/	---	---
LISN	R&S	ENV216	100098	03-05-2020	03-04-2021
Barometer	changchun	DYM3	1188	---	---

3M Semi/full-anechoic Chamber					
Equipment	Manufacturer	Model No.	Serial Number	Cal. date (mm-dd-yyyy)	Cal. Due date (mm-dd-yyyy)
3M Chamber & Accessory Equipment	TDK	SAC-3	---	05-24-2019	05-23-2022
TRILOG Broadband Antenna	Schwarzbeck	VULB9163	9163-618	05-16-2020	05-15-2021
Loop Antenna	Schwarzbeck	FMZB 1519B	1519B-076	04-25-2018	04-24-2021
Receiver	R&S	ESCI7	100938-003	10-21-2019 10-16-2020	10-20-2020 10-15-2021
Multi device Controller	matturo	NCD/070/107 11112	---	---	---
Temperature/ Humidity Indicator	Shanghai qixiang	HM10	1804298	06-29-2020	06-28-2021
Cable line	Fulai(7M)	SF106	5219/6A	---	---
Cable line	Fulai(6M)	SF106	5220/6A	---	---
Cable line	Fulai(3M)	SF106	5216/6A	---	---
Cable line	Fulai(3M)	SF106	5217/6A	---	---

3M full-anechoic Chamber					
Equipment	Manufacturer	Model No.	Serial Number	Cal. date (mm-dd-yyyy)	Cal. Due date (mm-dd-yyyy)
RSE Automatic test software	JS Tonscend	JS36-RSE	10166	---	---
Receiver	Keysight	N9038A	MY57290136	03-05-2020	03-04-2021
Spectrum Analyzer	Keysight	N9020B	MY57111112	03-05-2020	03-04-2021
Spectrum Analyzer	Keysight	N9030B	MY57140871	03-05-2020	03-04-2021
TRILOG Broadband Antenna	Schwarzbeck	VULB 9163	9163-1148	04-25-2018	04-24-2021
Horn Antenna	Schwarzbeck	BBHA 9170	9170-832	04-25-2018	04-24-2021
Horn Antenna	ETS-LINDGREN	3117	00057407	07-10-2018	07-09-2021
Preamplifier	EMCI	EMC184055SE	980596	05-20-2020	05-19-2021
Preamplifier	EMCI	EMC001330	980563	04-22-2020	04-21-2021
Preamplifier	JS Tonscend	980380	EMC051845 SE	01-09-2020	01-08-2021
Temperature/Humidity Indicator	biaozhi	GM1360	EE1186631	04-27-2020	04-26-2021
Fully Anechoic Chamber	TDK	FAC-3	---	01-17-2018	01-16-2021
Filter bank	JS Tonscend	JS0806-F	188060094	04-10-2018	04-09-2021
Cable line	Times	SFT205-NMSM-2.50M	394812-0001	---	---
Cable line	Times	SFT205-NMSM-2.50M	394812-0002	---	---
Cable line	Times	SFT205-NMSM-2.50M	394812-0003	---	---
Cable line	Times	SFT205-NMSM-2.50M	393495-0001	---	---
Cable line	Times	EMC104-NMNM-1000	SN160710	---	---
Cable line	Times	SFT205-NMSM-3.00M	394813-0001	---	---
Cable line	Times	SFT205-NMNM-1.50M	381964-0001	---	---
Cable line	Times	SFT205-NMSM-7.00M	394815-0001	---	---
Cable line	Times	HF160-KMKM-3.00M	393493-0001	---	---

8 Radio Technical Requirements Specification

Reference documents for testing:

No.	Identity	Document Title
1	FCC Part15C	Subpart C-Intentional Radiators
2	ANSI C63.10-2013	American National Standard for Testing Unlicensed Wireless Devices

Test Results List:

Test Requirement	Test method	Test item	Verdict	Note
Part15C Section 15.247 (b)(3)	ANSI C63.10	Conducted Peak Output Power	PASS	Appendix A)
Part15C Section 15.247 (a)(2)	ANSI C63.10	6dB Occupied Bandwidth	PASS	Appendix B)
Part15C Section 15.247(d)	ANSI C63.10	Band-edge for RF Conducted Emissions	PASS	Appendix C)
Part15C Section 15.247(d)	ANSI C63.10	RF Conducted Spurious Emissions	PASS	Appendix D)
Part15C Section 15.247 (e)	ANSI C63.10	Power Spectral Density	PASS	Appendix E)
Part15C Section 15.203/15.247 (c)	ANSI C63.10	Antenna Requirement	PASS	Appendix F)
Part15C Section 15.207	ANSI C63.10	AC Power Line Conducted Emission	PASS	Appendix G)
Part15C Section 15.205/15.209	ANSI C63.10	Restricted bands around fundamental frequency (Radiated Emission)	PASS	Appendix H)
Part15C Section 15.205/15.209	ANSI C63.10	Radiated Spurious Emissions	PASS	Appendix I)

EUT DUTY CYCLE
Test Graph

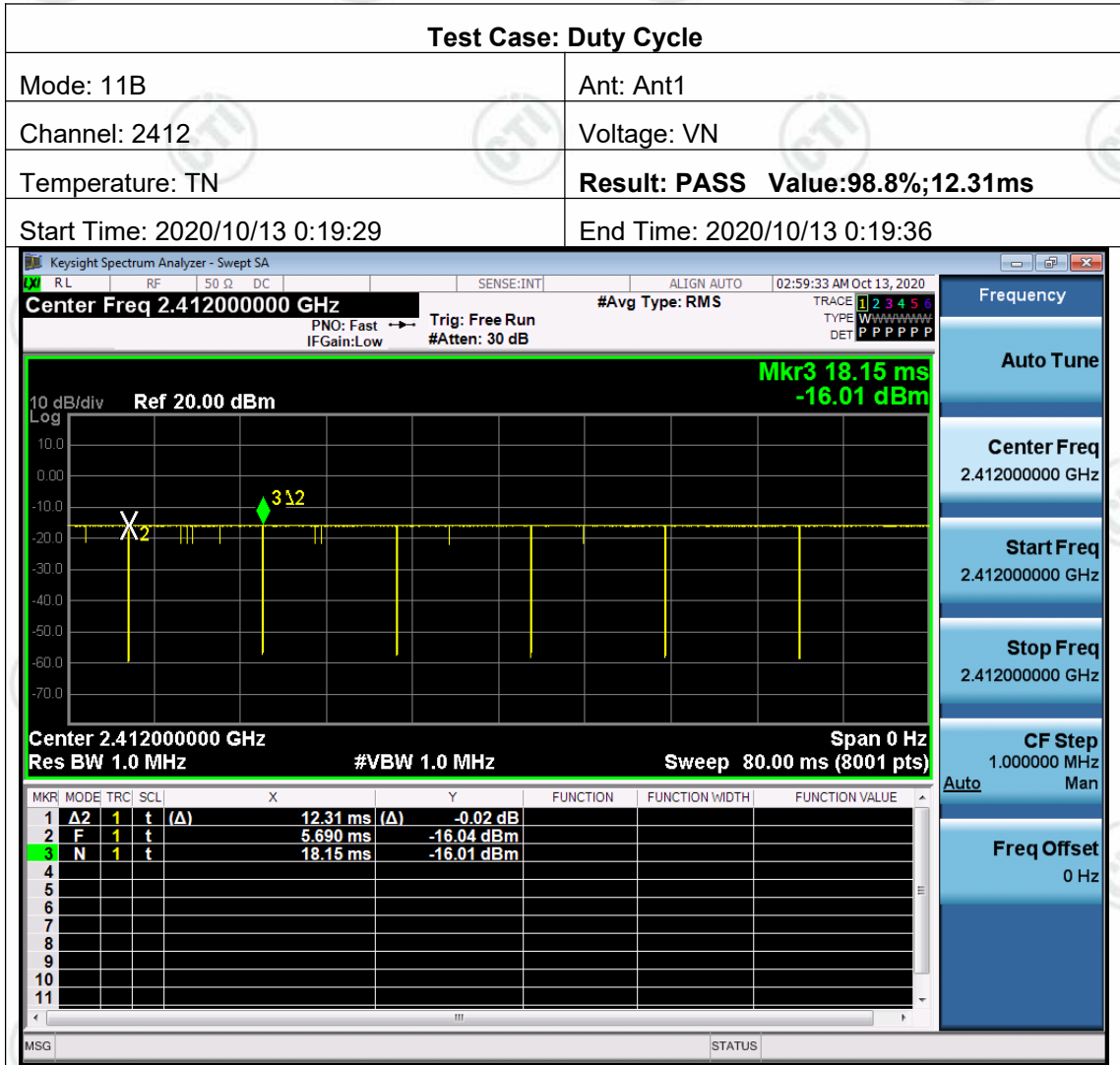

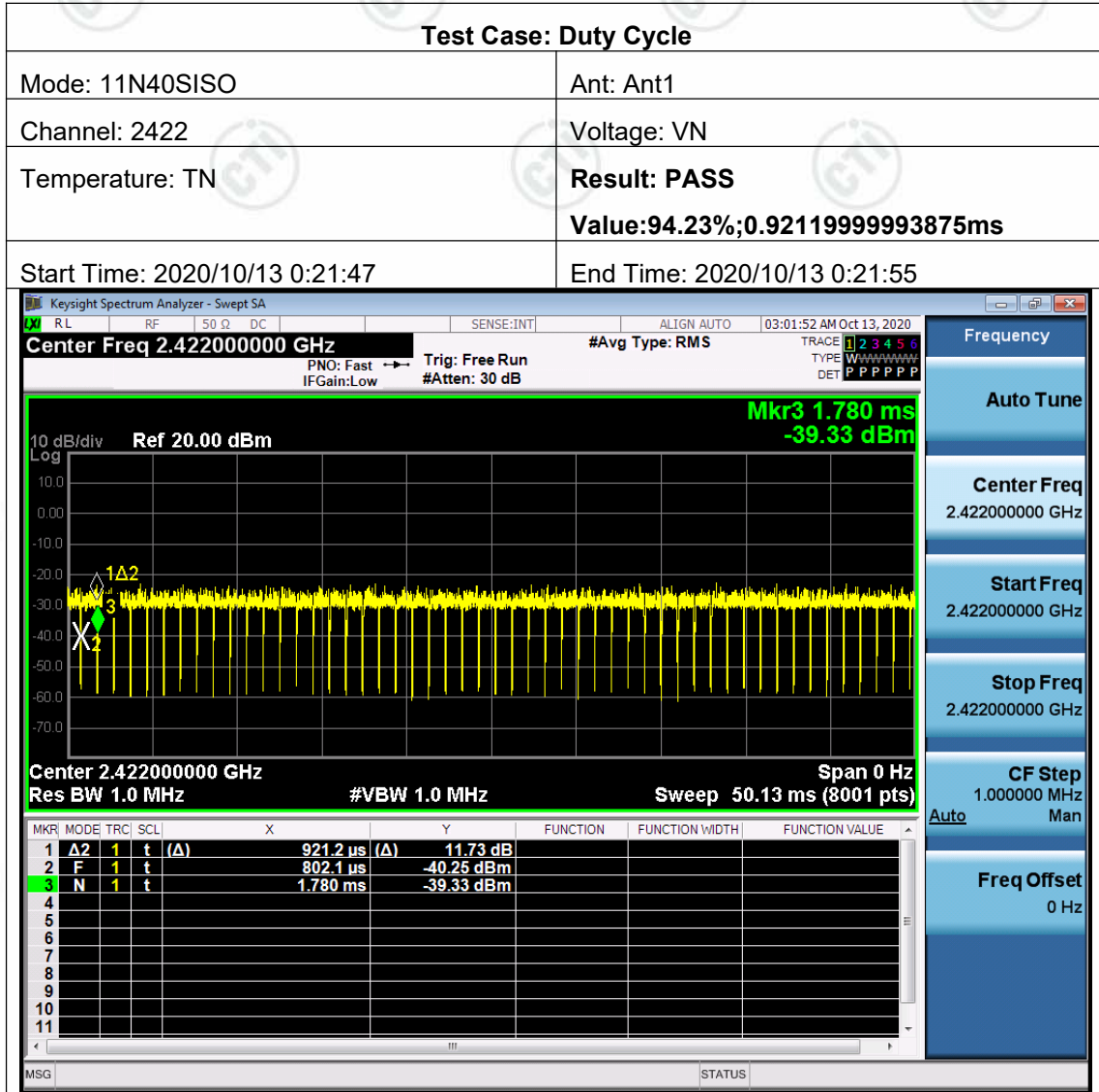

Appendix A): Conducted Peak Output Power

Test Limit

According to §15.247(b)(3),

Peak output power :

For systems using digital modulation in the 2400-2483.5 MHz: 1 Watt(30 dBm), base on the use of antennas with directional gain not exceed 6 dBi. If transmitting antennas of directional gain greater than 6dBi are used the peak output power the conducted output power from the intentional radiator shall be reduced by the amount in dB that the directional gain of the antenna exceeds 6 dBi. In case of point-to-point operation, the limit has to be reduced by 1dB for every 3 dB that the directional gain of the antenna exceeds 6 dBi.

Limit	<input checked="" type="checkbox"/> Antenna not exceed 6 dBi : 30dBm <input type="checkbox"/> Antenna with DG greater than 6 dBi : [Limit = 30 – (DG – 6)] <input type="checkbox"/> Point-to-point operation :
-------	---

Average output power : For reporting purposes only.

Test Procedure

Test method Refer as KDB 558074 D01.

1. The EUT RF output connected to spectrum analyzer by RF cable.
2. Setting maximum power transmit of EUT.
3. Spectrum analyzer settings are as follows :
 - a) Set the RBW = 1 MHz.
 - b) Set the VBW ≥ [3 × RBW].
 - c) Set the span ≥ [1.5 × DTS bandwidth].
 - d) Detector = peak.
 - e) Sweep time = auto couple.
 - f) Trace mode = max hold.
 - g) Allow trace to fully stabilize.
 - h) Use the instrument's band/channel power measurement function with the band limits set equal to the DTS bandwidth edges
4. Measure and record the result in the test report.

Test Setup

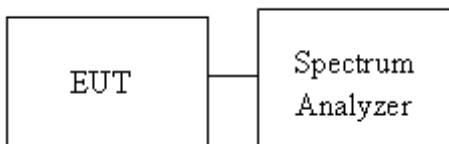

Test Result

Mode	Channel	Conducted Peak Output Power [dBm]	Verdict
11B	LCH	13.43	PASS
11B	MCH	13.94	PASS
11B	HCH	13.16	PASS
11G	LCH	12.98	PASS
11G	MCH	12.74	PASS
11G	HCH	12.96	PASS
11N20SISO	LCH	11.22	PASS
11N20SISO	MCH	11.71	PASS
11N20SISO	HCH	11.93	PASS
11N40SISO	LCH	10.74	PASS
11N40SISO	MCH	10.92	PASS
11N40SISO	HCH	11.04	PASS

Test Graph

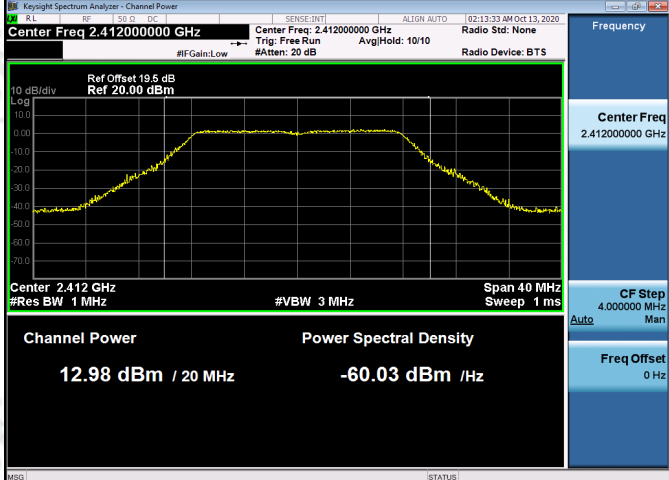
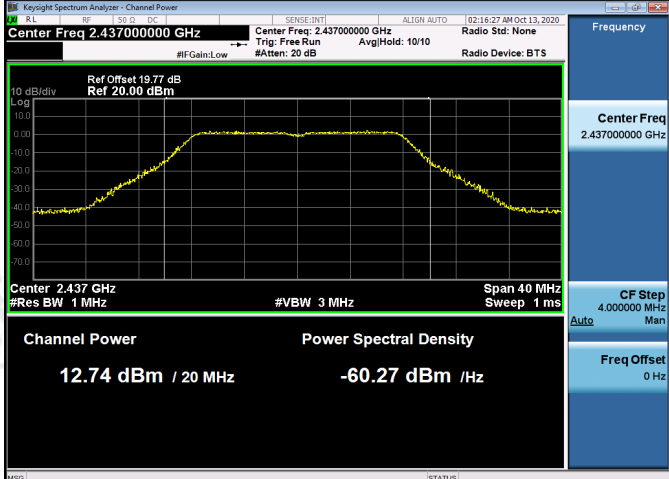
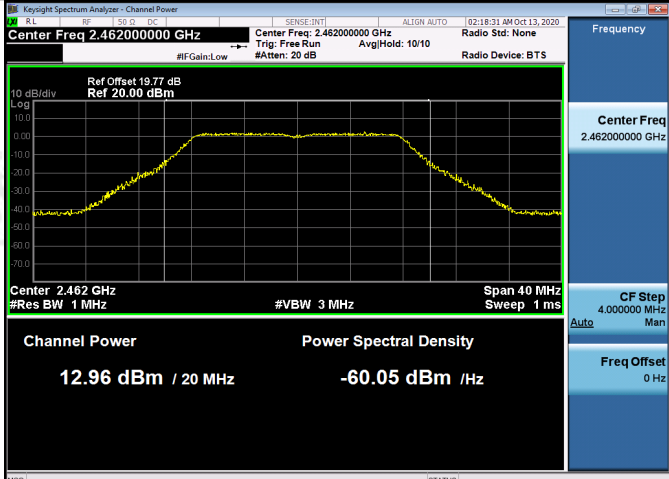

<p>11G/LCH</p>	 <p>Keysight Spectrum Analyzer - Channel Power</p> <p>Center Freq 2.412000000 GHz</p> <p>Ref Offset 19.5 dB Ref 20.00 dBm</p> <p>Channel Power: 12.98 dBm / 20 MHz</p> <p>Power Spectral Density: -60.03 dBm /Hz</p>
<p>11G/MCH</p>	 <p>Keysight Spectrum Analyzer - Channel Power</p> <p>Center Freq 2.437000000 GHz</p> <p>Ref Offset 19.77 dB Ref 20.00 dBm</p> <p>Channel Power: 12.74 dBm / 20 MHz</p> <p>Power Spectral Density: -60.27 dBm /Hz</p>
<p>11G/HCH</p>	 <p>Keysight Spectrum Analyzer - Channel Power</p> <p>Center Freq 2.462000000 GHz</p> <p>Ref Offset 19.77 dB Ref 20.00 dBm</p> <p>Channel Power: 12.96 dBm / 20 MHz</p> <p>Power Spectral Density: -60.05 dBm /Hz</p>

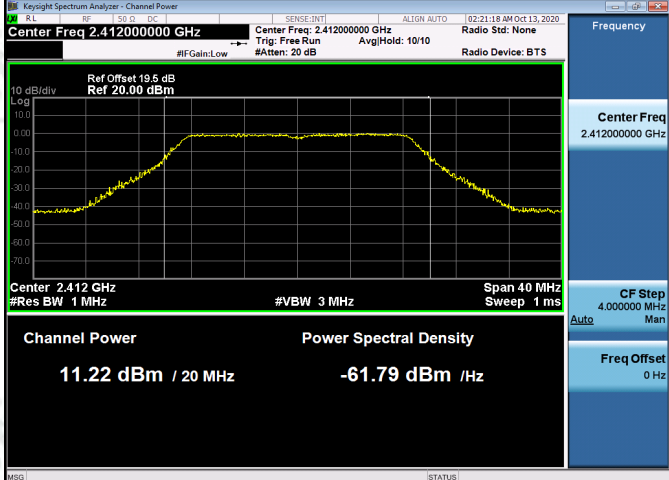
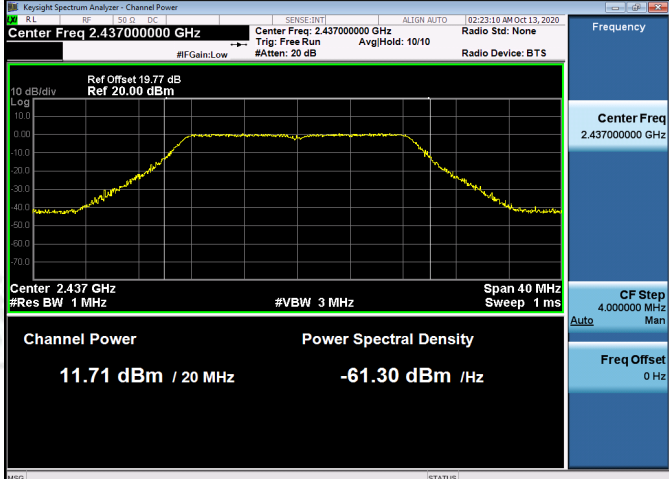
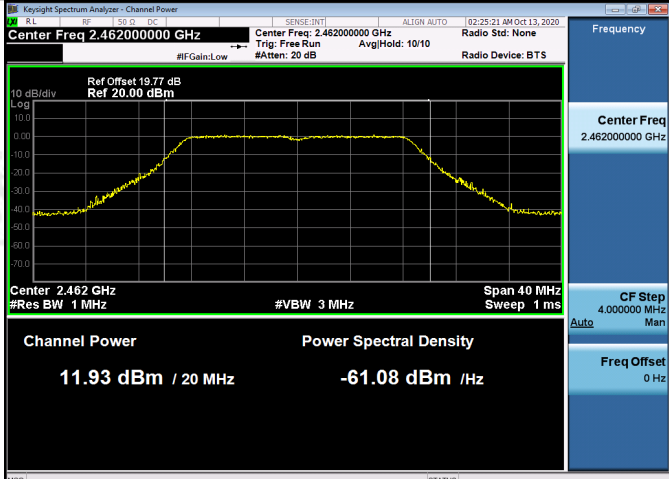
<p>11N20SISO/LCH</p>	 <p>Keysight Spectrum Analyzer - Channel Power</p> <p>Center Freq 2.412000000 GHz</p> <p>Ref Offset 19.5 dB Ref 20.00 dBm</p> <p>Channel Power: 11.22 dBm / 20 MHz</p> <p>Power Spectral Density: -61.79 dBm /Hz</p> <p>Center 2.412 GHz #Res BW 1 MHz #VBW 3 MHz Span 40 MHz Sweep 1 ms</p>
<p>11N20SISO/MCH</p>	 <p>Keysight Spectrum Analyzer - Channel Power</p> <p>Center Freq 2.437000000 GHz</p> <p>Ref Offset 19.77 dB Ref 20.00 dBm</p> <p>Channel Power: 11.71 dBm / 20 MHz</p> <p>Power Spectral Density: -61.30 dBm /Hz</p> <p>Center 2.437 GHz #Res BW 1 MHz #VBW 3 MHz Span 40 MHz Sweep 1 ms</p>
<p>11N20SISO/HCH</p>	 <p>Keysight Spectrum Analyzer - Channel Power</p> <p>Center Freq 2.462000000 GHz</p> <p>Ref Offset 19.77 dB Ref 20.00 dBm</p> <p>Channel Power: 11.93 dBm / 20 MHz</p> <p>Power Spectral Density: -61.08 dBm /Hz</p> <p>Center 2.462 GHz #Res BW 1 MHz #VBW 3 MHz Span 40 MHz Sweep 1 ms</p>

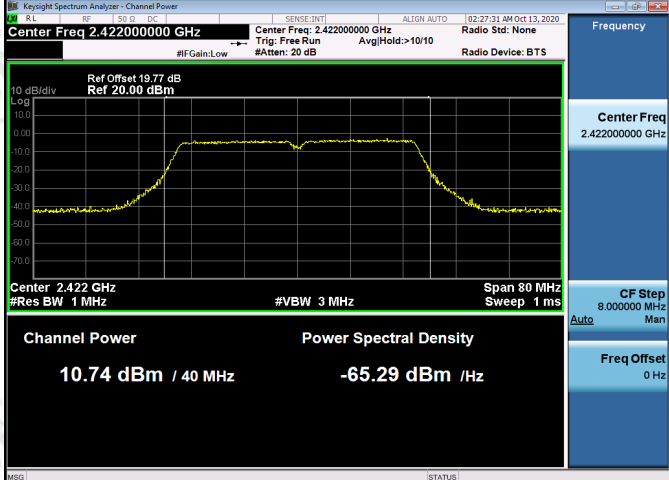
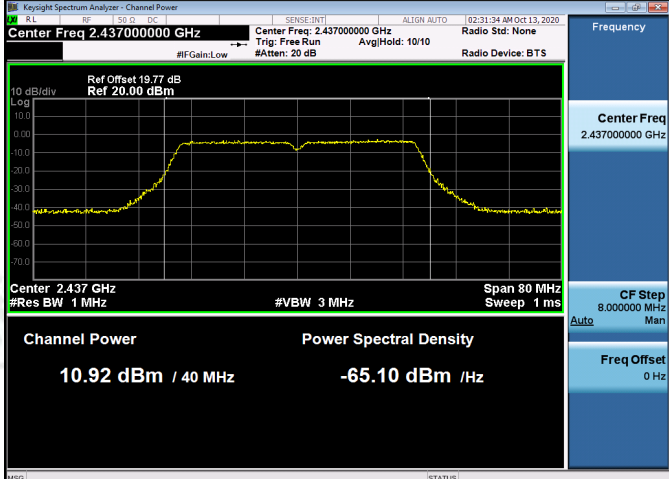
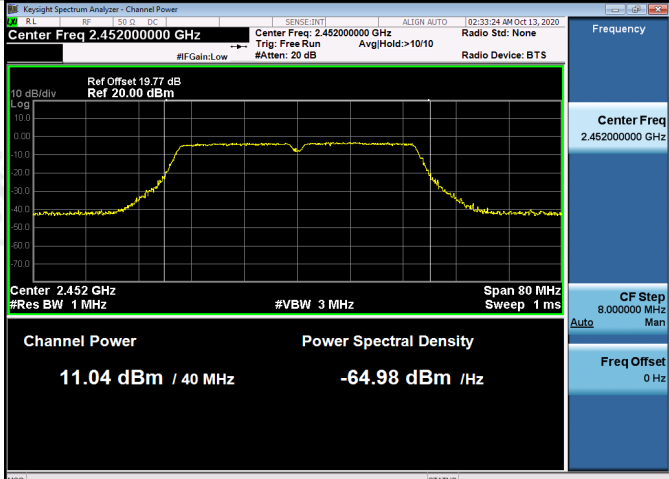
<p>11N40SISO/LCH</p>	 <p>Keysight Spectrum Analyzer - Channel Power</p> <p>Center Freq 2.422000000 GHz</p> <p>Ref Offset 19.77 dB Ref 20.00 dBm</p> <p>Center 2.422 GHz #Res BW 1 MHz</p> <p>Channel Power: 10.74 dBm / 40 MHz</p> <p>Power Spectral Density: -65.29 dBm /Hz</p>
<p>11N40SISO/MCH</p>	 <p>Keysight Spectrum Analyzer - Channel Power</p> <p>Center Freq 2.437000000 GHz</p> <p>Ref Offset 19.77 dB Ref 20.00 dBm</p> <p>Center 2.437 GHz #Res BW 1 MHz</p> <p>Channel Power: 10.92 dBm / 40 MHz</p> <p>Power Spectral Density: -65.10 dBm /Hz</p>
<p>11N40SISO/HCH</p>	 <p>Keysight Spectrum Analyzer - Channel Power</p> <p>Center Freq 2.452000000 GHz</p> <p>Ref Offset 19.77 dB Ref 20.00 dBm</p> <p>Center 2.452 GHz #Res BW 1 MHz</p> <p>Channel Power: 11.04 dBm / 40 MHz</p> <p>Power Spectral Density: -64.98 dBm /Hz</p>

Appendix B): 6dB Occupied Bandwidth

Test Limit

According to §15.247(a)(2),

6 dB Bandwidth :

Limit	Shall be at least 500kHz
-------	--------------------------

Occupied Bandwidth(99%) : For reporting purposes only.

Test Procedure

Test method Refer as KDB 558074 D01 and ANSI C63.10: 2013 clause 6.9.2,

1. The EUT RF output connected to the spectrum analyzer by RF cable.
2. Setting maximum power transmit of EUT
3. SA set RBW =100KHz , VBW = 300KHz and Detector = Peak, to measurement 6dB Bandwidth
4. SA set RBW = 1% ~ 5% OBW, VBW = three times the RBW and Detector = Peak, to measurement 99% Bandwidth
5. Measure and record the result of 6 dB Bandwidth and 99% Bandwidth. in the test report.

Test Setup

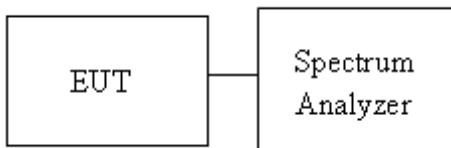

Test Result

Mode	Channel	6dB Bandwidth [MHz]	99% OBW [MHz]	Verdict
11B	LCH	10.11	13.503	PASS
11B	MCH	10.09	13.494	PASS
11B	HCH	10.10	13.474	PASS
11G	LCH	16.34	16.831	PASS
11G	MCH	16.35	16.783	PASS
11G	HCH	16.33	16.768	PASS
11N20SISO	LCH	17.57	17.927	PASS
11N20SISO	MCH	17.58	17.895	PASS
11N20SISO	HCH	17.58	17.895	PASS
11N40SISO	LCH	35.73	36.510	PASS
11N40SISO	MCH	36.31	36.535	PASS
11N40SISO	HCH	36.07	36.502	PASS

Test Graph
6 dB Bandwidth

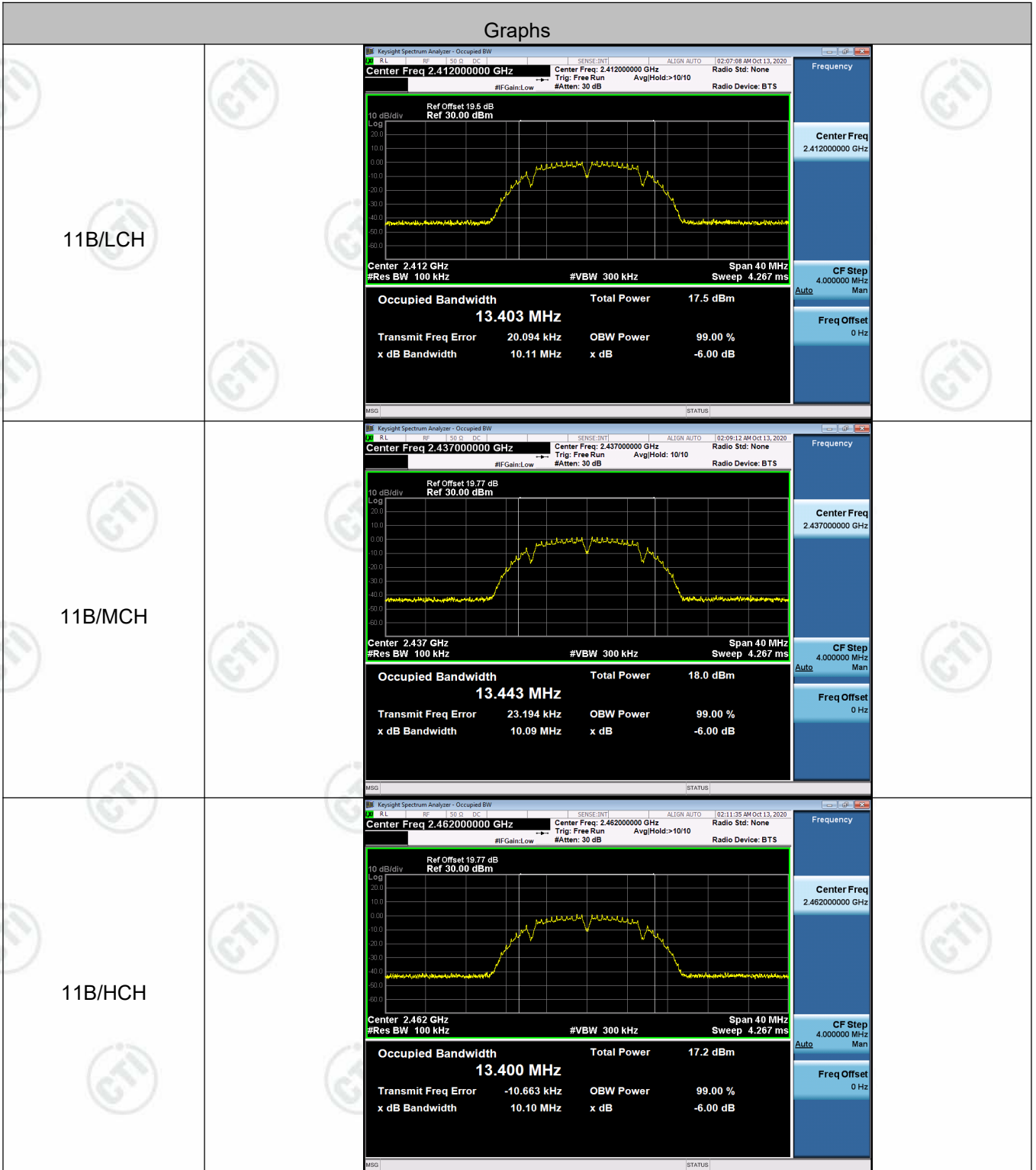

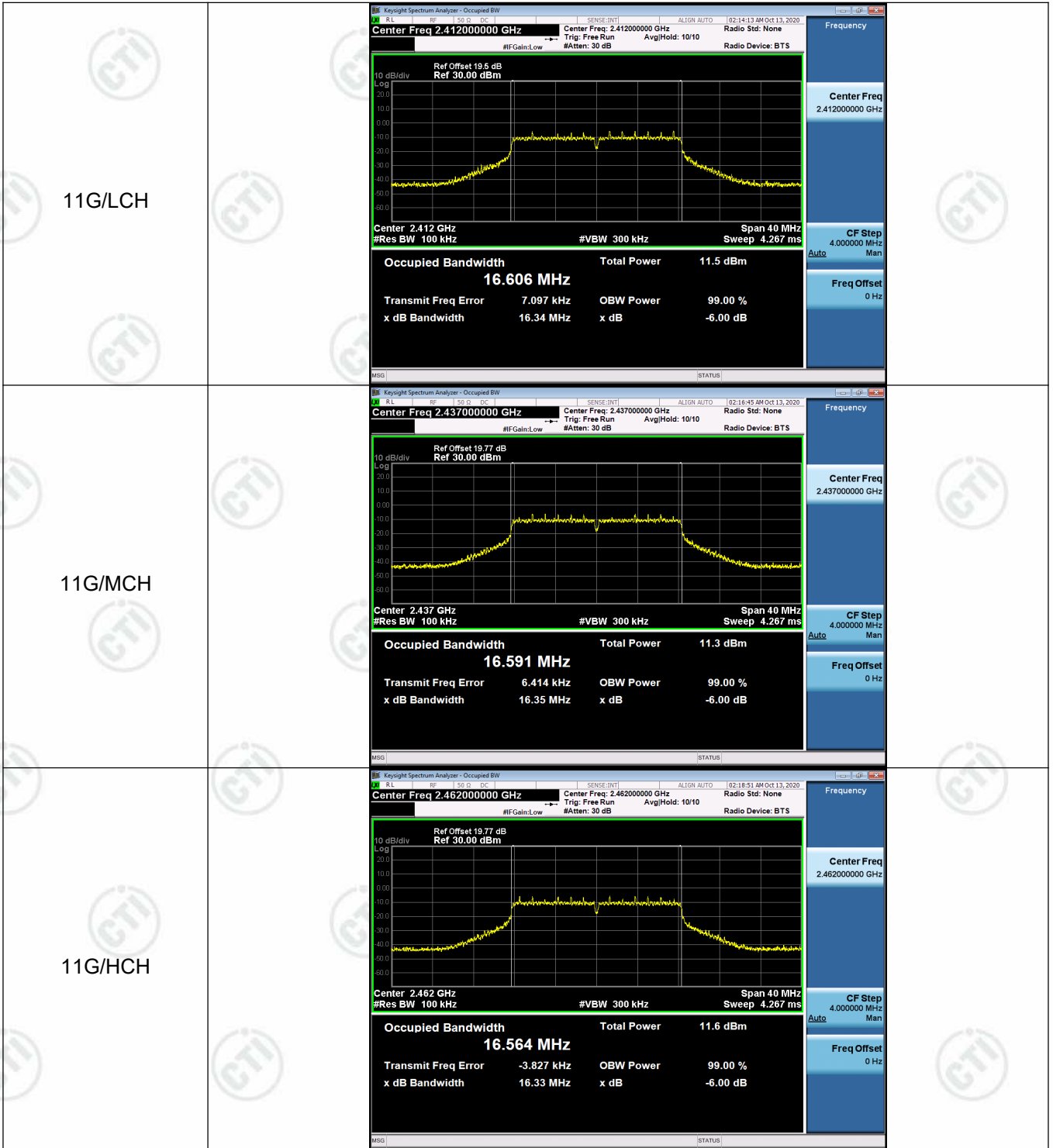

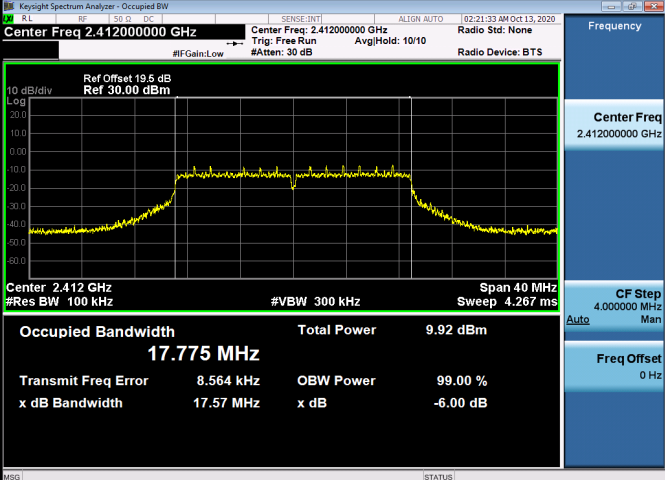
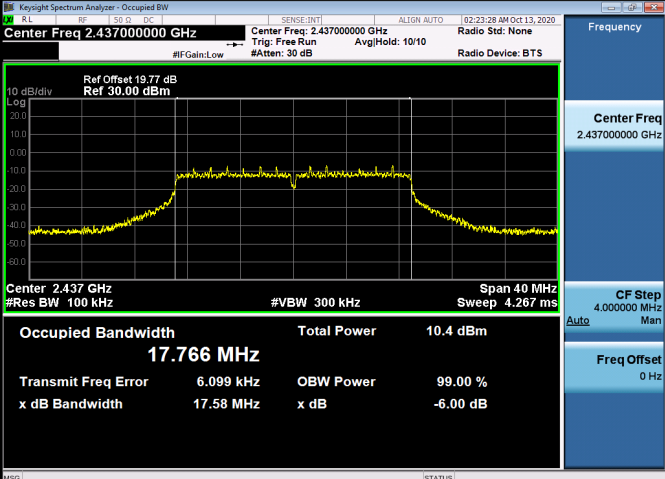
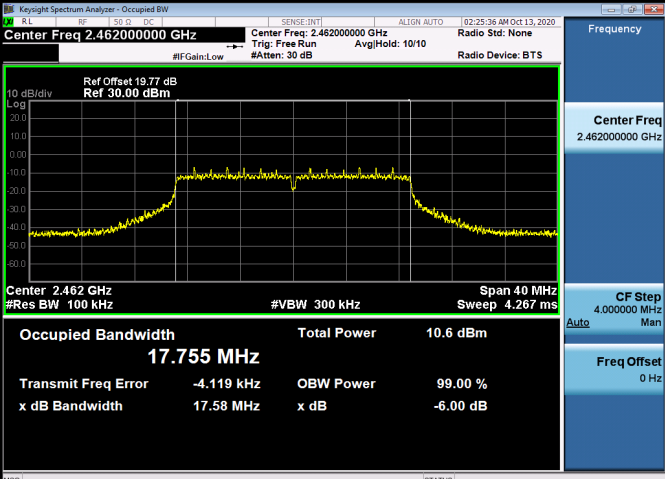
<p>11N20SISO/LCH</p>	 <p>Keyight Spectrum Analyzer - Occupied BW</p> <p>Center Freq 2.41200000 GHz</p> <p>Center Freq: 2.41200000 GHz</p> <p>Ref Offset 19.5 dB</p> <p>Ref 30.00 dBm</p> <p>Center 2.412 GHz</p> <p>#Res BW 100 kHz</p> <p>#VBW 300 kHz</p> <p>Span 40 MHz</p> <p>Sweep 4.267 ms</p> <p>Occupied Bandwidth 17.775 MHz</p> <p>Total Power 9.92 dBm</p> <p>Transmit Freq Error 8.564 kHz</p> <p>OBW Power 99.00 %</p> <p>x dB Bandwidth 17.57 MHz</p> <p>x dB -6.00 dB</p>
<p>11N20SISO/MCH</p>	 <p>Keyight Spectrum Analyzer - Occupied BW</p> <p>Center Freq 2.43700000 GHz</p> <p>Center Freq: 2.43700000 GHz</p> <p>Ref Offset 19.77 dB</p> <p>Ref 30.00 dBm</p> <p>Center 2.437 GHz</p> <p>#Res BW 100 kHz</p> <p>#VBW 300 kHz</p> <p>Span 40 MHz</p> <p>Sweep 4.267 ms</p> <p>Occupied Bandwidth 17.766 MHz</p> <p>Total Power 10.4 dBm</p> <p>Transmit Freq Error 6.099 kHz</p> <p>OBW Power 99.00 %</p> <p>x dB Bandwidth 17.58 MHz</p> <p>x dB -6.00 dB</p>
<p>11N20SISO/HCH</p>	 <p>Keyight Spectrum Analyzer - Occupied BW</p> <p>Center Freq 2.46200000 GHz</p> <p>Center Freq: 2.46200000 GHz</p> <p>Ref Offset 19.77 dB</p> <p>Ref 30.00 dBm</p> <p>Center 2.462 GHz</p> <p>#Res BW 100 kHz</p> <p>#VBW 300 kHz</p> <p>Span 40 MHz</p> <p>Sweep 4.267 ms</p> <p>Occupied Bandwidth 17.755 MHz</p> <p>Total Power 10.6 dBm</p> <p>Transmit Freq Error -4.119 kHz</p> <p>OBW Power 99.00 %</p> <p>x dB Bandwidth 17.58 MHz</p> <p>x dB -6.00 dB</p>

<p>11N40SISO/LCH</p>	<p>Keyight Spectrum Analyzer - Occupied BW</p> <p>Center Freq 2.422000000 GHz</p> <p>Center Freq 2.422000000 GHz</p> <p>Ref Offset 19.77 dB Ref 30.00 dBm</p> <p>Center 2.422 GHz #Res BW 100 kHz</p> <p>Span 80 MHz Sweep 8 ms</p> <p>#VBW 300 kHz</p> <p>Occupied Bandwidth 36.273 MHz Total Power 9.30 dBm</p> <p>Transmit Freq Error 20.990 kHz OBW Power 99.00 %</p> <p>x dB Bandwidth 35.73 MHz x dB -6.00 dB</p>
<p>11N40SISO/MCH</p>	<p>Keyight Spectrum Analyzer - Occupied BW</p> <p>Center Freq 2.437000000 GHz</p> <p>Center Freq 2.437000000 GHz</p> <p>Ref Offset 19.77 dB Ref 20.00 dBm</p> <p>Center 2.437 GHz #Res BW 100 kHz</p> <p>Span 80 MHz Sweep 8 ms</p> <p>#VBW 300 kHz</p> <p>Occupied Bandwidth 36.277 MHz Total Power 9.55 dBm</p> <p>Transmit Freq Error 18.261 kHz OBW Power 99.00 %</p> <p>x dB Bandwidth 36.31 MHz x dB -6.00 dB</p>
<p>11N40SISO/HCH</p>	<p>Keyight Spectrum Analyzer - Occupied BW</p> <p>Center Freq 2.452000000 GHz</p> <p>Center Freq 2.452000000 GHz</p> <p>Ref Offset 19.77 dB Ref 30.00 dBm</p> <p>Center 2.452 GHz #Res BW 100 kHz</p> <p>Span 80 MHz Sweep 8 ms</p> <p>#VBW 300 kHz</p> <p>Occupied Bandwidth 36.248 MHz Total Power 9.69 dBm</p> <p>Transmit Freq Error 3.110 kHz OBW Power 99.00 %</p> <p>x dB Bandwidth 36.07 MHz x dB -6.00 dB</p>

Occupied Bandwidth(99%)

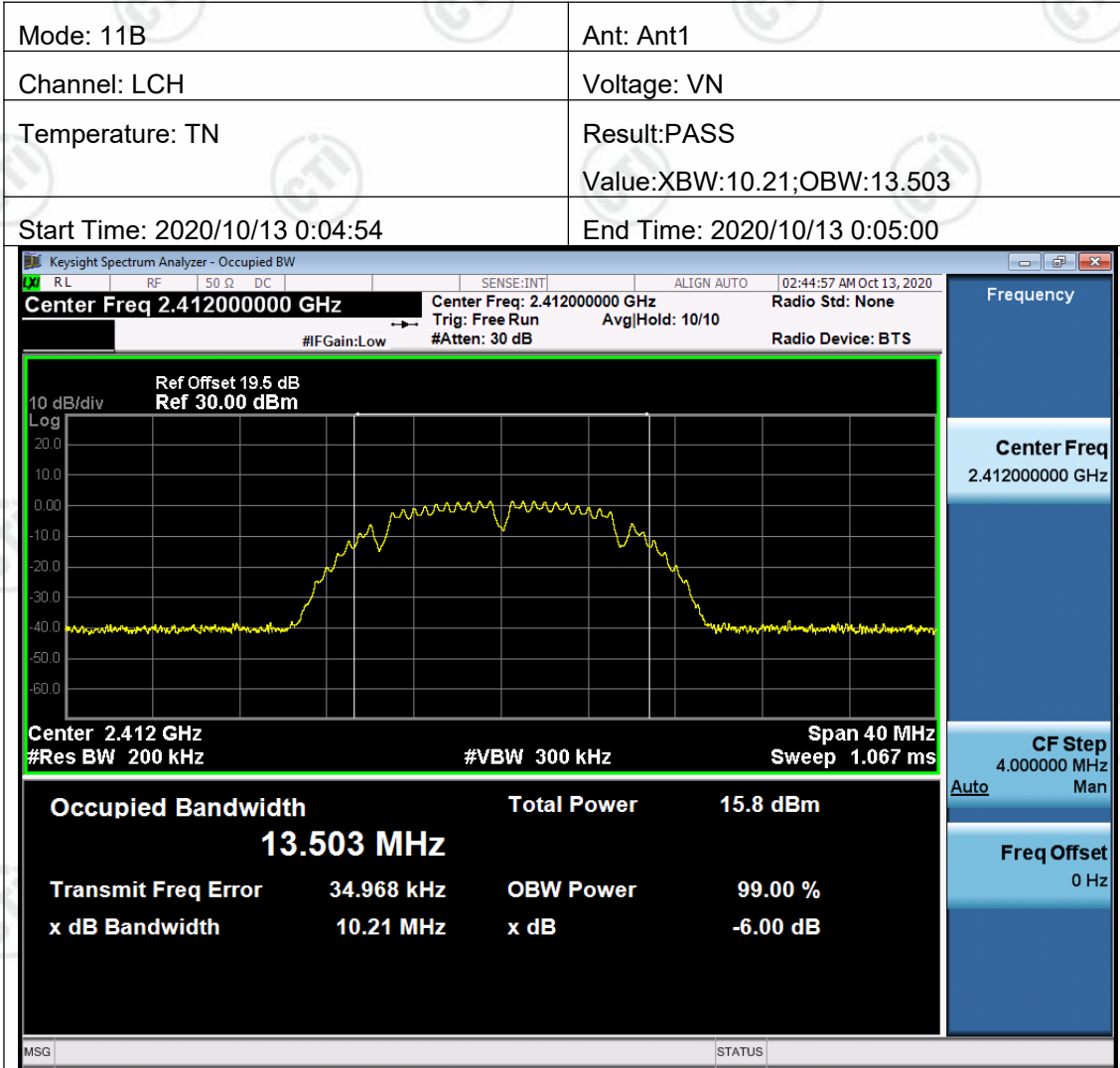

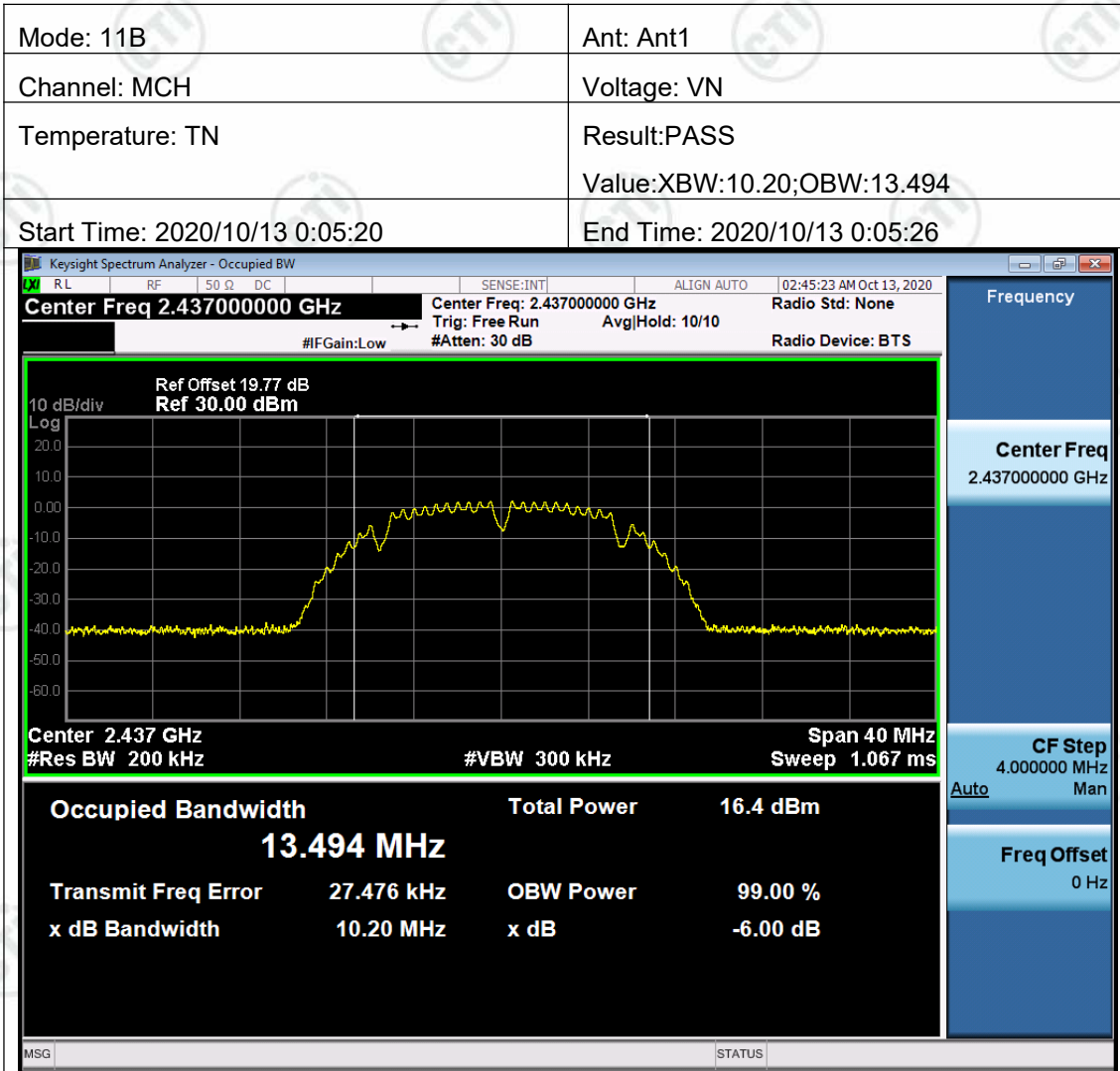

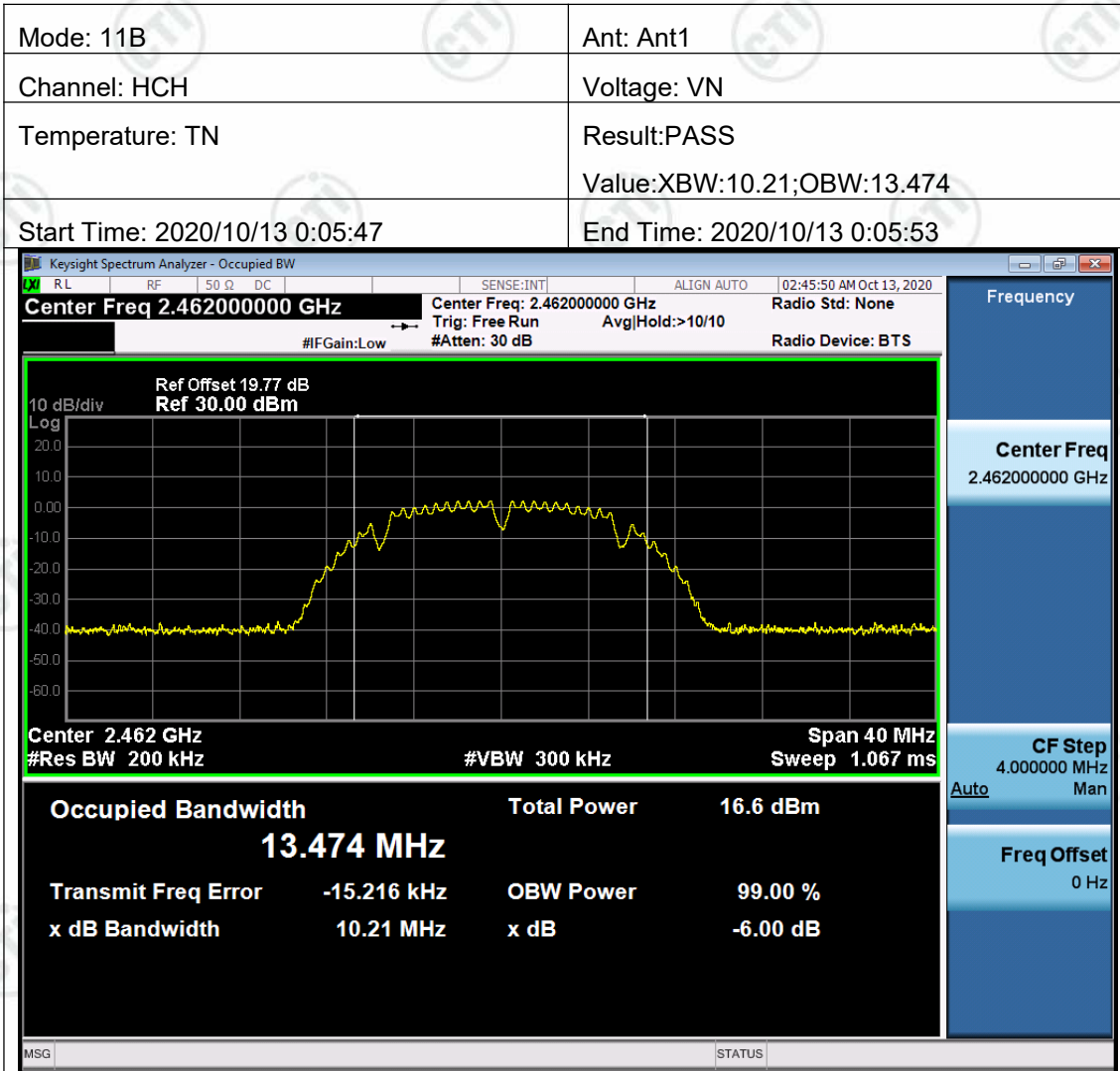

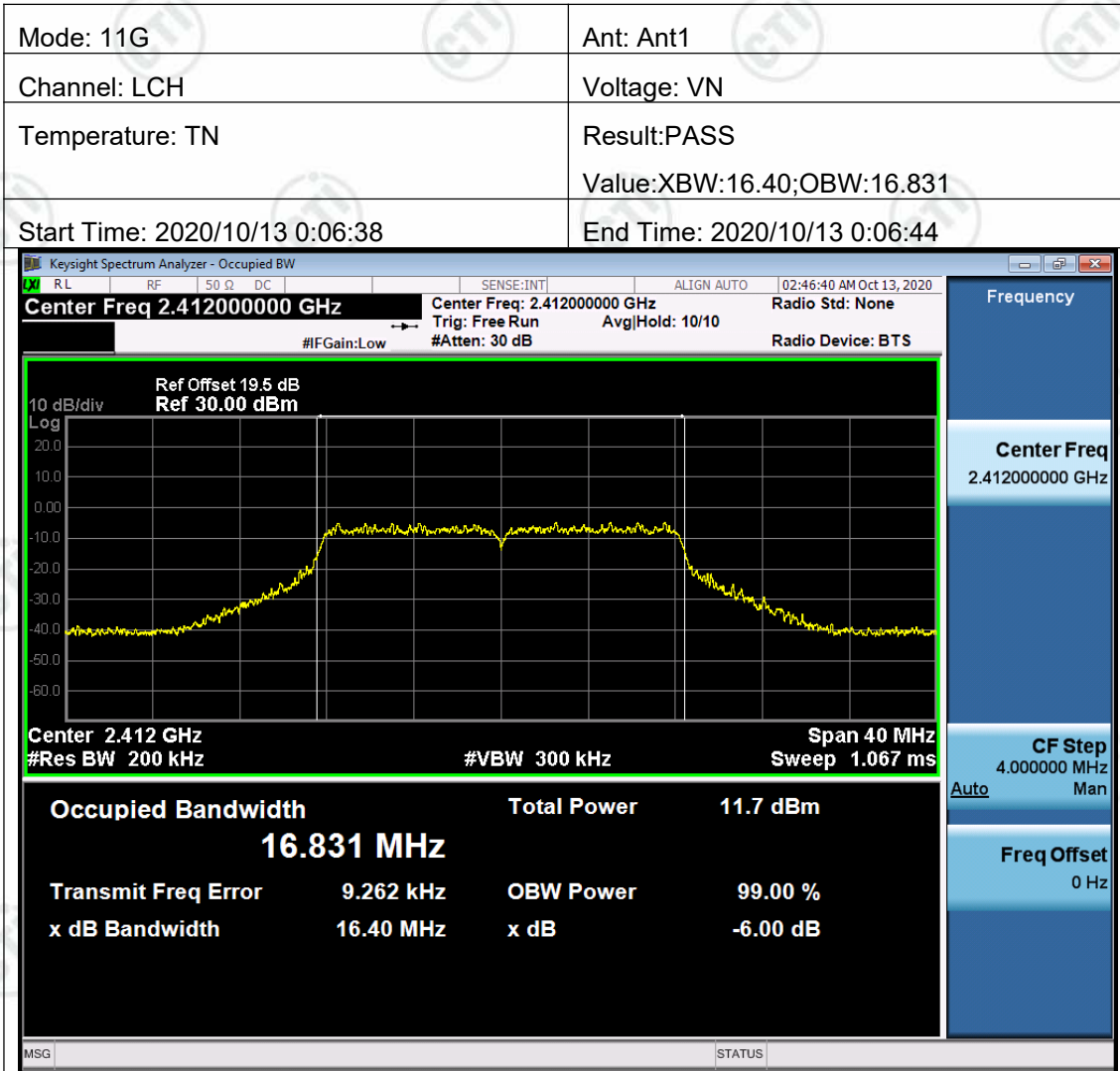

Mode: 11G	Ant: Ant1
Channel: MCH	Voltage: VN
Temperature: TN	Result:PASS Value:XBW:16.42;OBW:16.783
Start Time: 2020/10/13 0:07:02	End Time: 2020/10/13 0:07:09

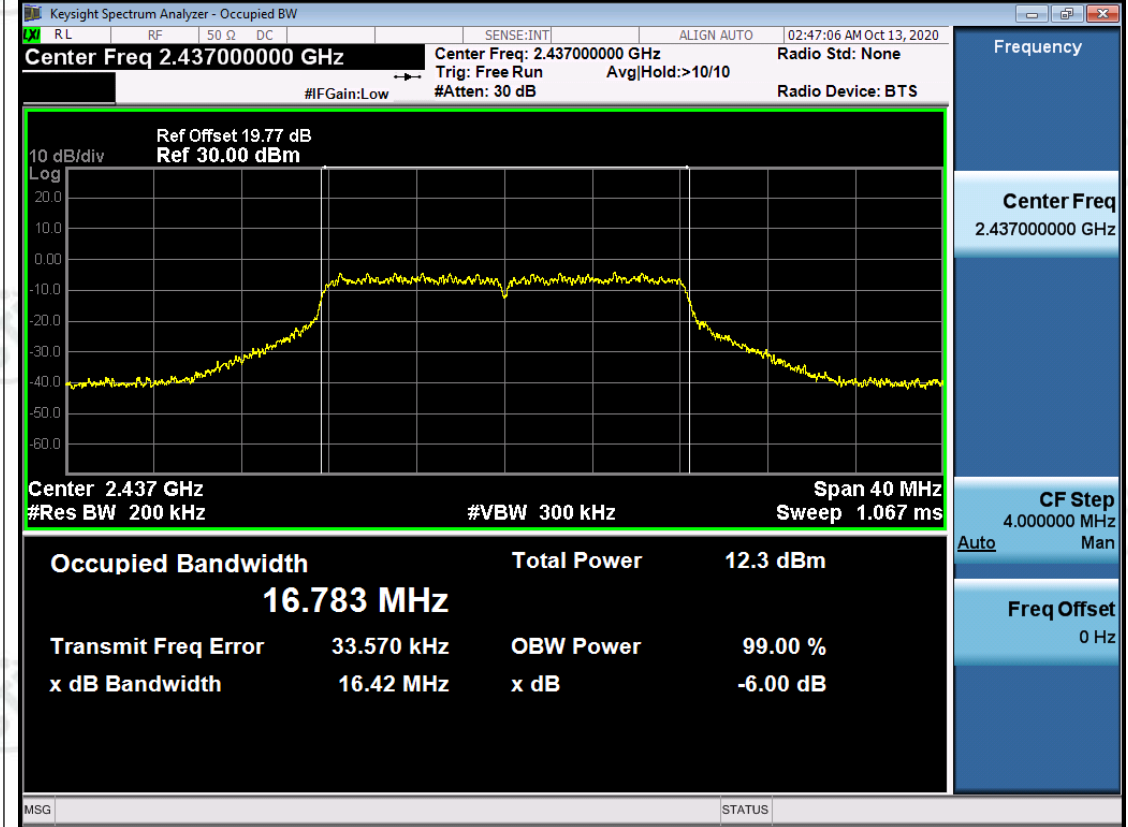

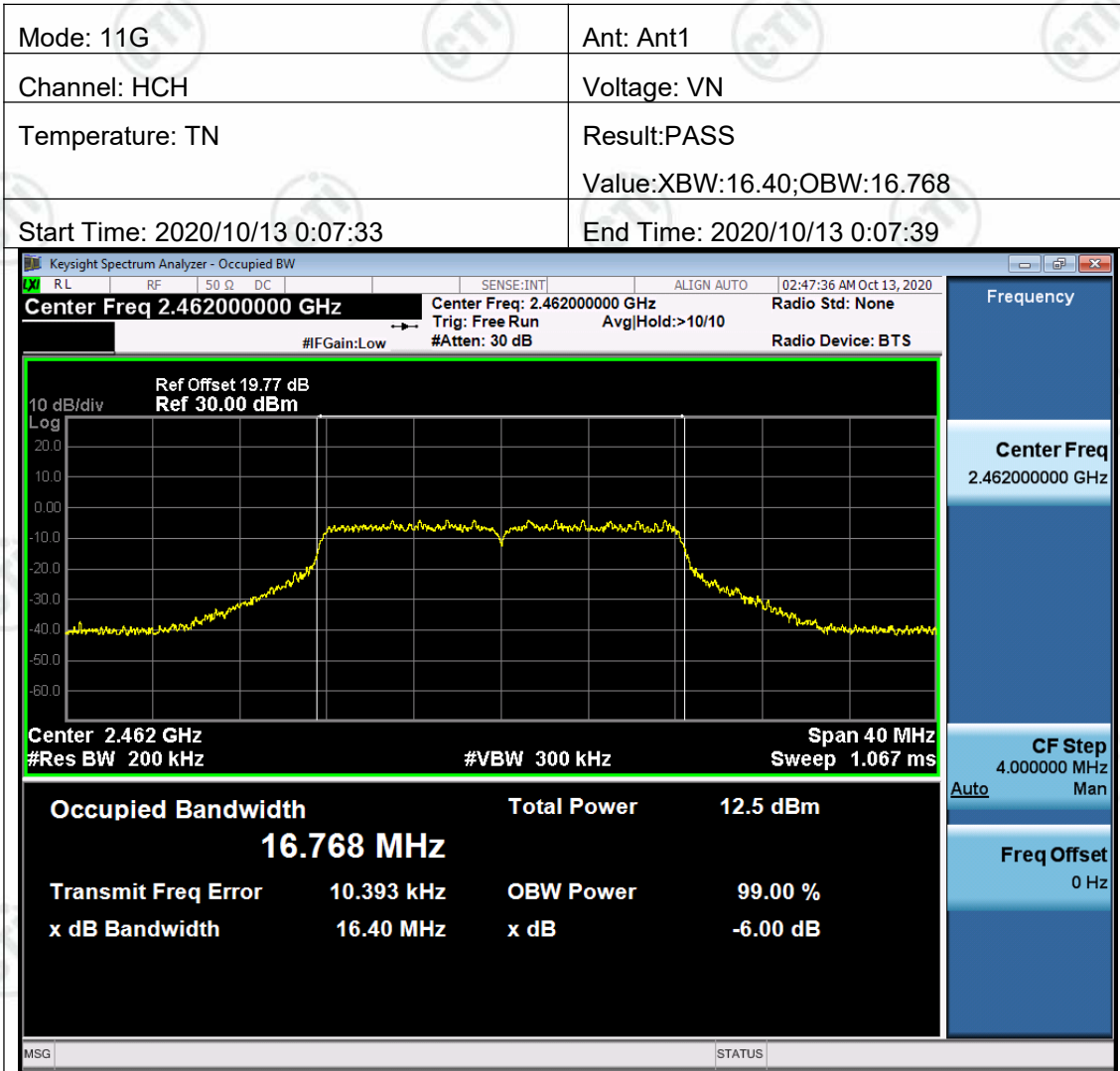

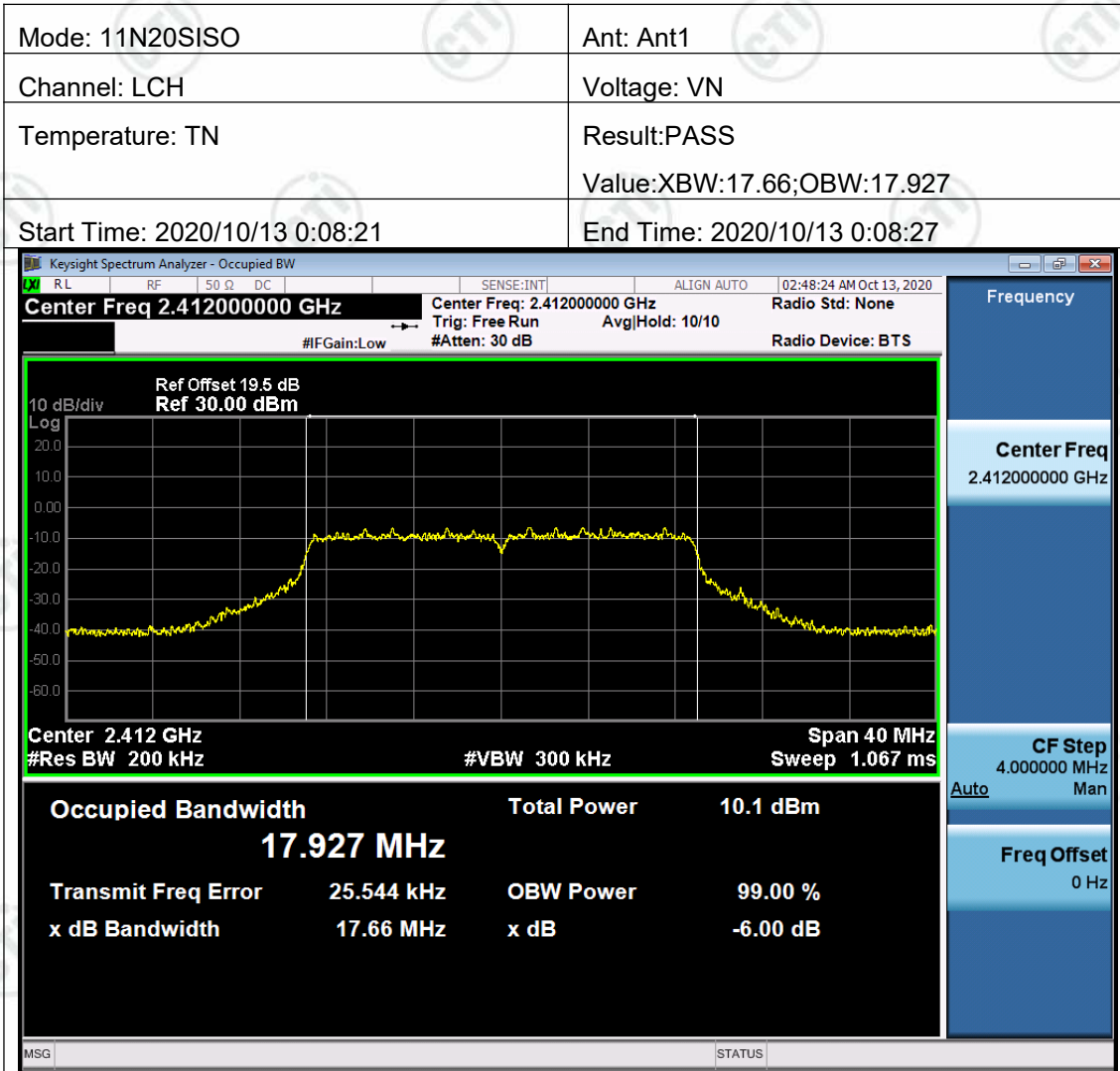

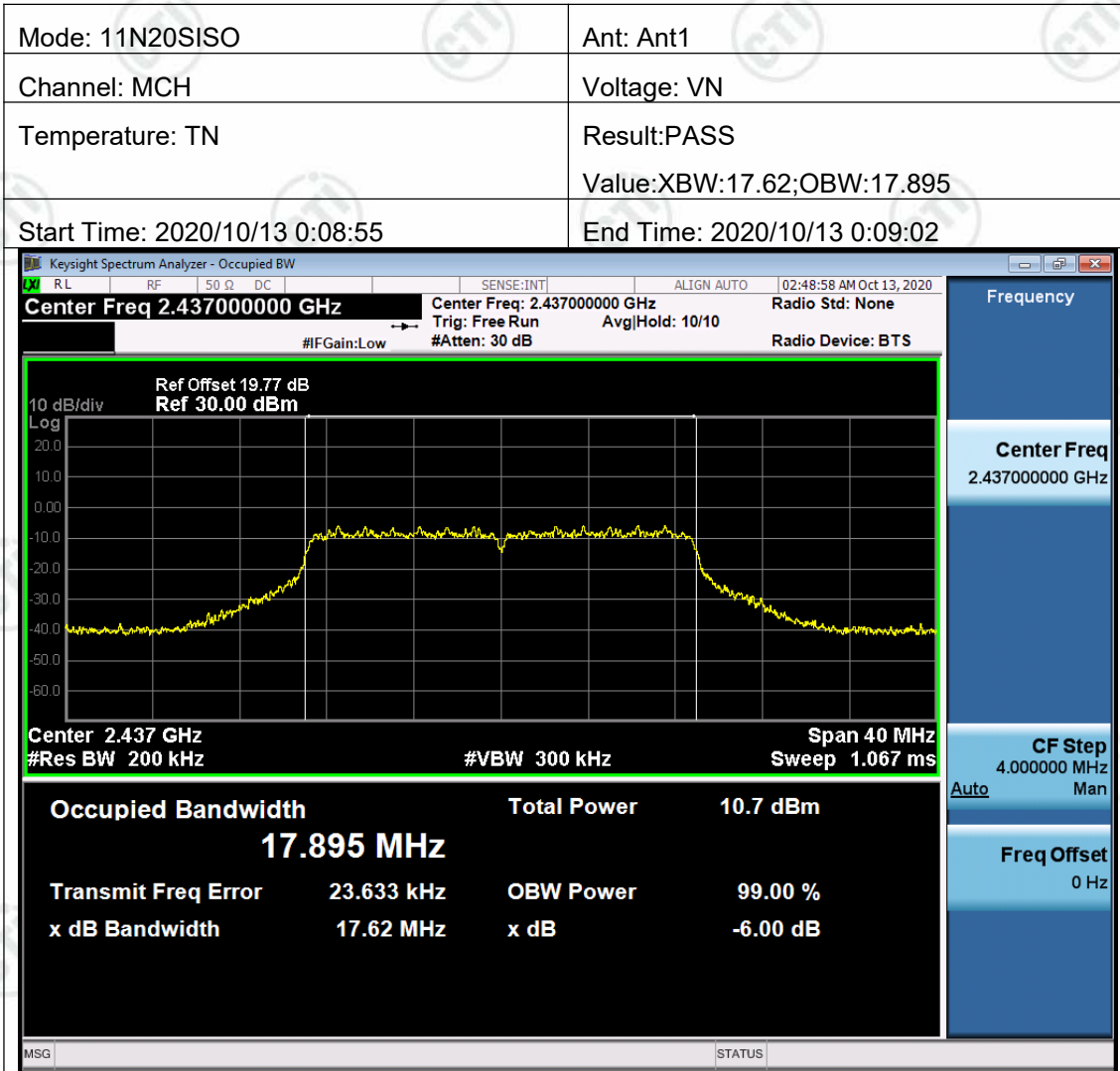

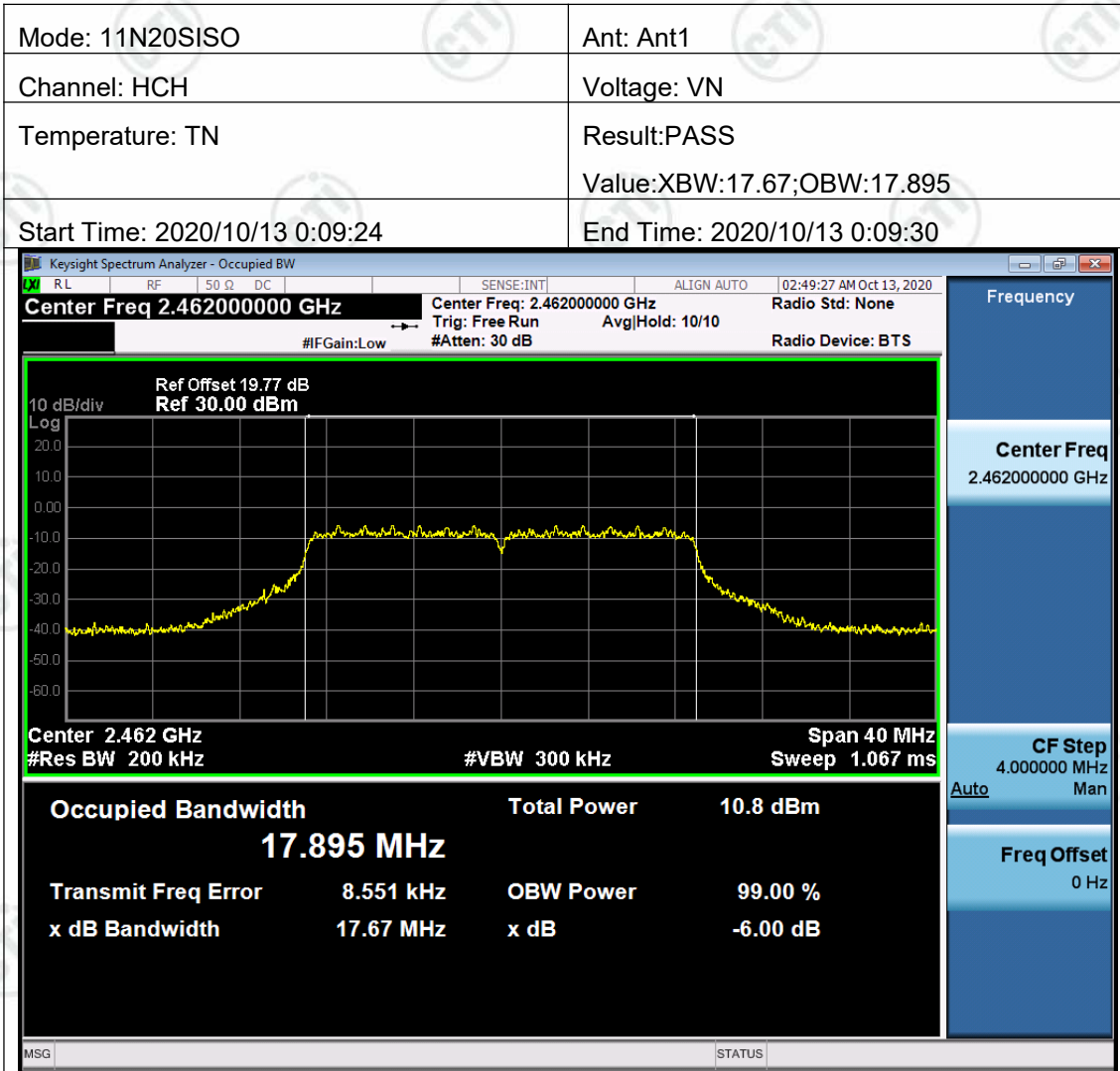

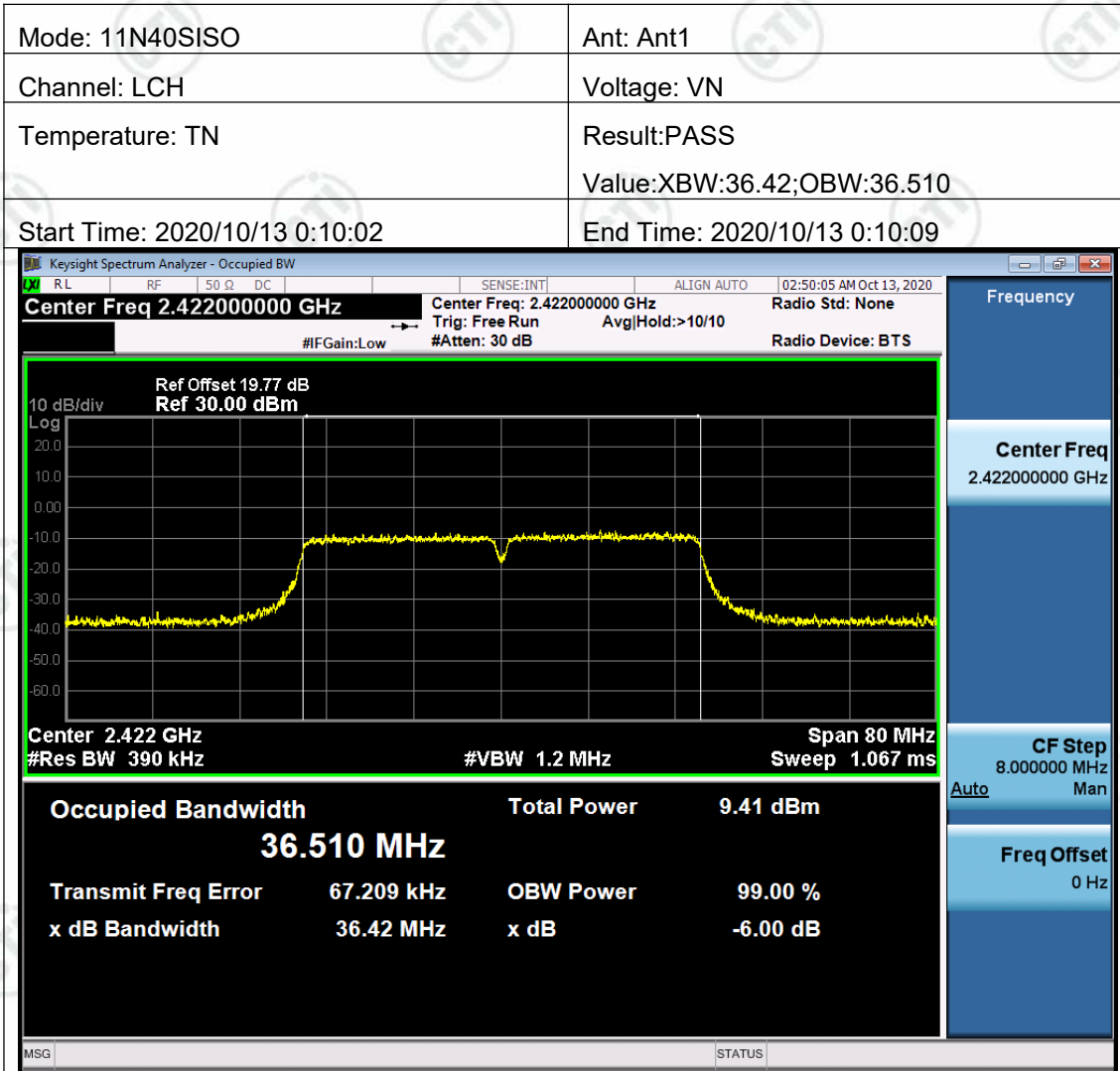

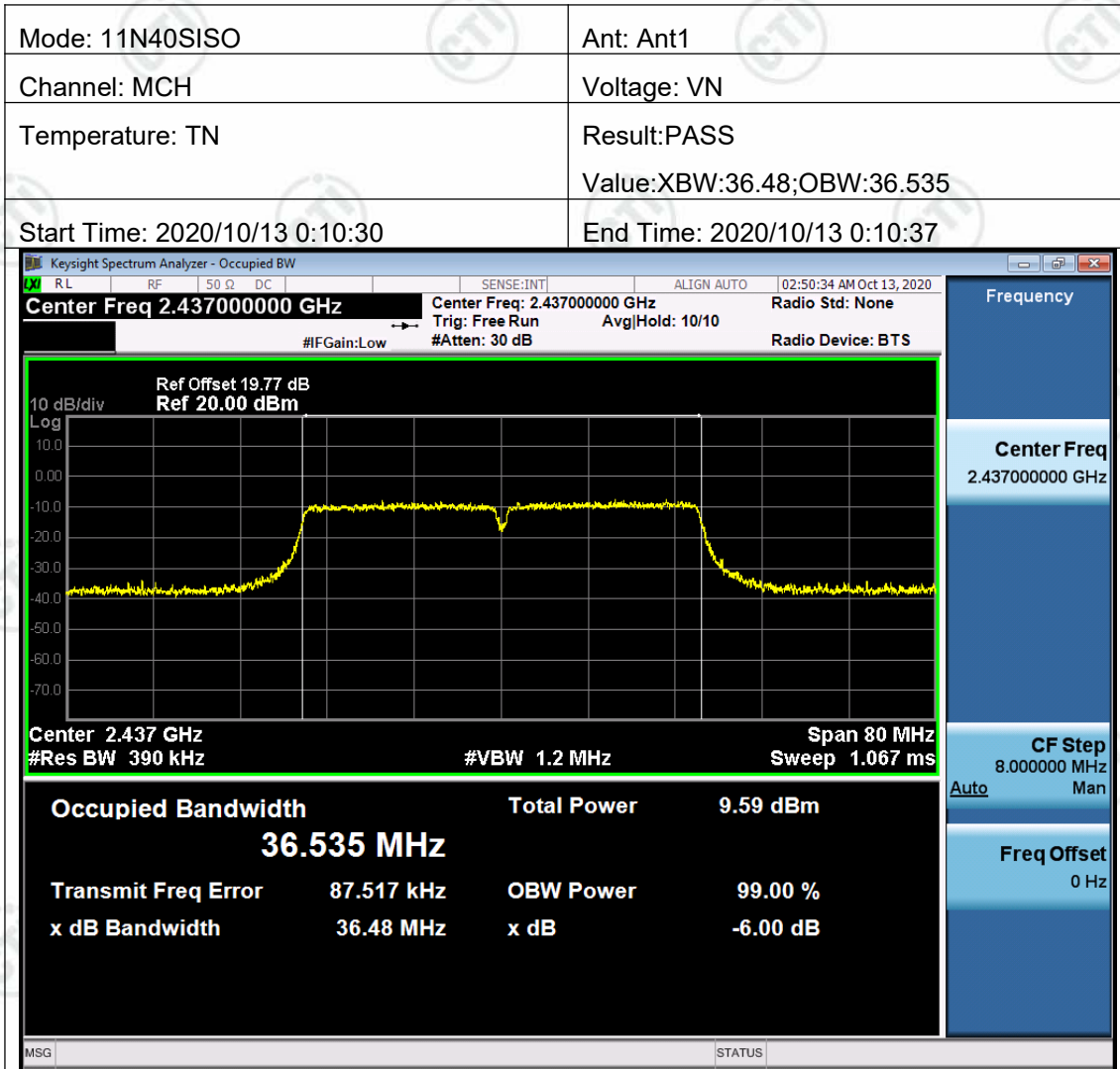

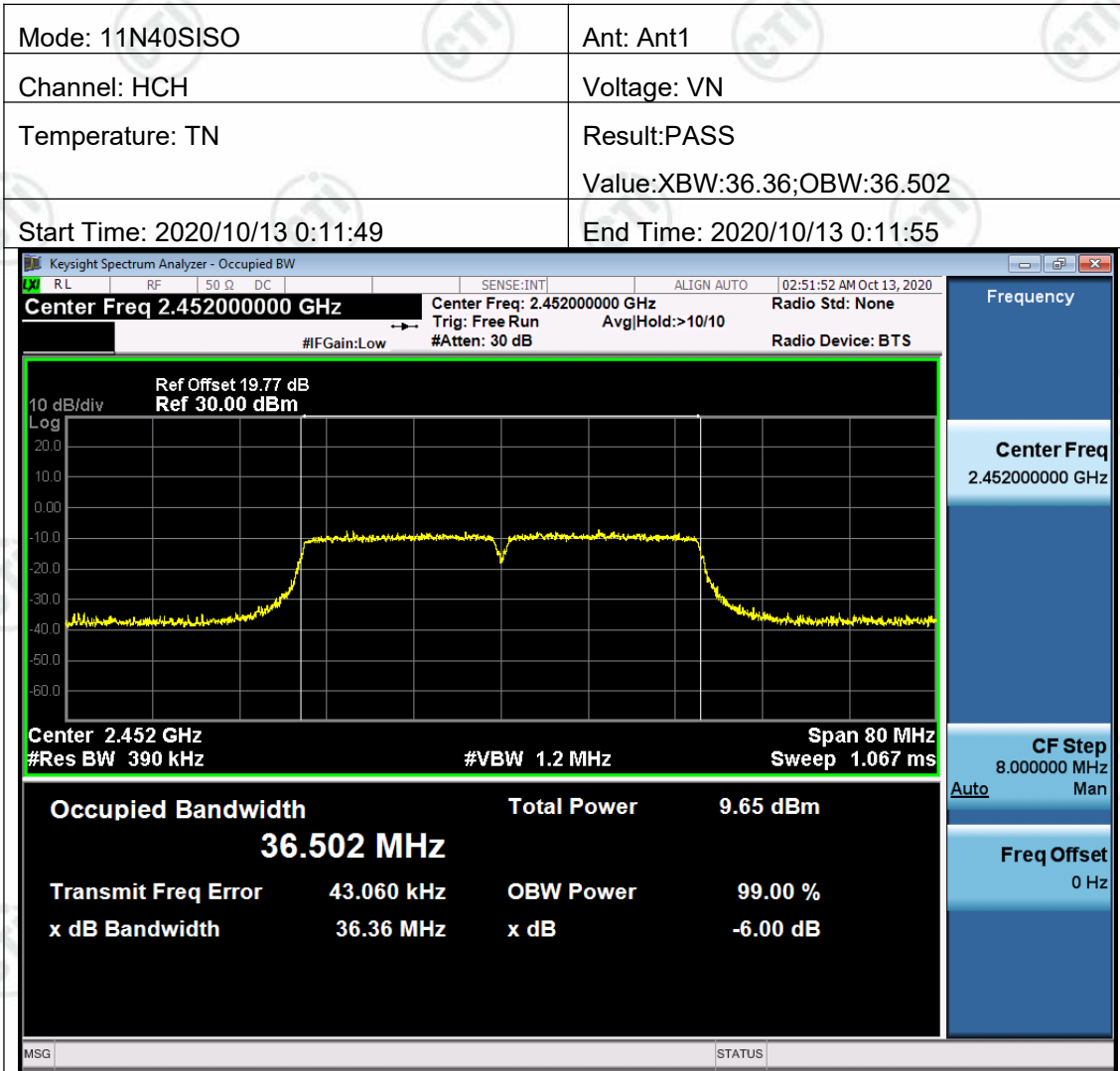

Appendix C): Band-edge for RF Conducted Emissions

Test Limit

According to §15.247(d),

In any 100 kHz bandwidth outside the authorized frequency band,

Non-restricted bands shall be attenuated at least 20 dB/30 dB relative to the maximum PSD level in 100 kHz by RF conducted or a radiated measurement which fall in the restricted bands, as defined in §15.205(a), must also comply with the radiated emission limits specified in §15.209(a).

Test Procedure

Test method Refer as KDB 558074 D01.

1. EUT RF output port connected to the SA by RF cable, and the path loss was compensated to result.
2. SA setting, RBW=100kHz, VBW=300kHz, Detector=Peak, Trace mode = max hold, SWT = Auto.
3. In any 100 kHz bandwidth outside the authorized frequency band, shall be attenuated at least 20 dB relative to the maximum in-band peak PSD level in 100 kHz when conducted power procedure is used. If the transmitter complies with the conducted power limits based on the use of RMS averaging over a time interval, the attenuation required under this paragraph shall be 30 dB instead of 20 dB.

Test Setup



Result Table

Mode	Channel	Carrier Power[dBm]	Max.Spurious Level [dBm]	Limit [dBm]	Verdict
11B	LCH	1.082	-50.265	-28.92	PASS
11B	HCH	0.875	-49.401	-29.13	PASS
11G	LCH	-5.880	-49.597	-35.88	PASS
11G	HCH	-5.677	-49.258	-35.68	PASS
11N20SISO	LCH	-7.256	-50.088	-37.26	PASS
11N20SISO	HCH	-6.756	-49.432	-36.76	PASS
11N40SISO	LCH	-11.474	-50.403	-41.47	PASS
11N40SISO	HCH	-10.848	-50.010	-40.85	PASS

Test Graph

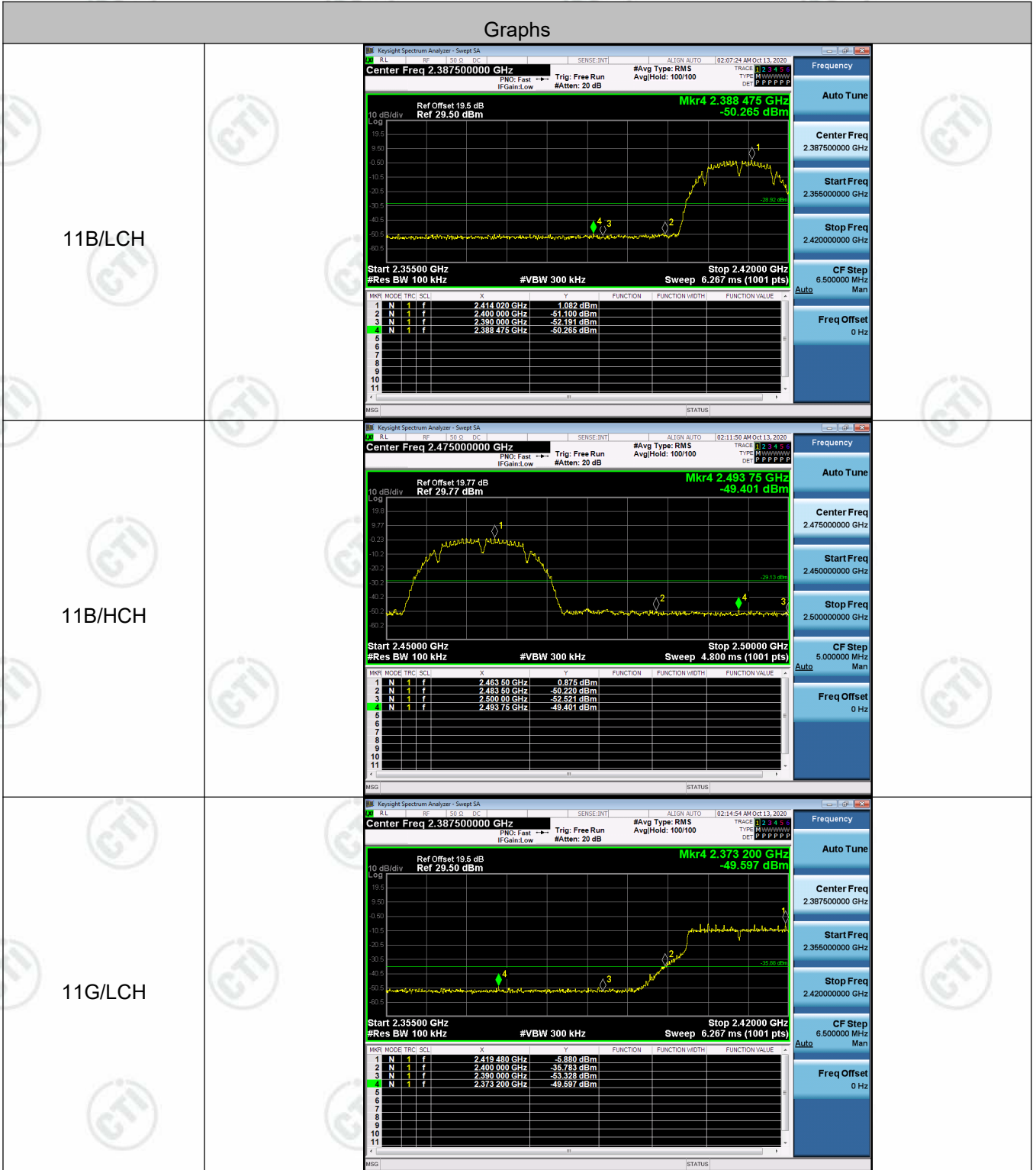

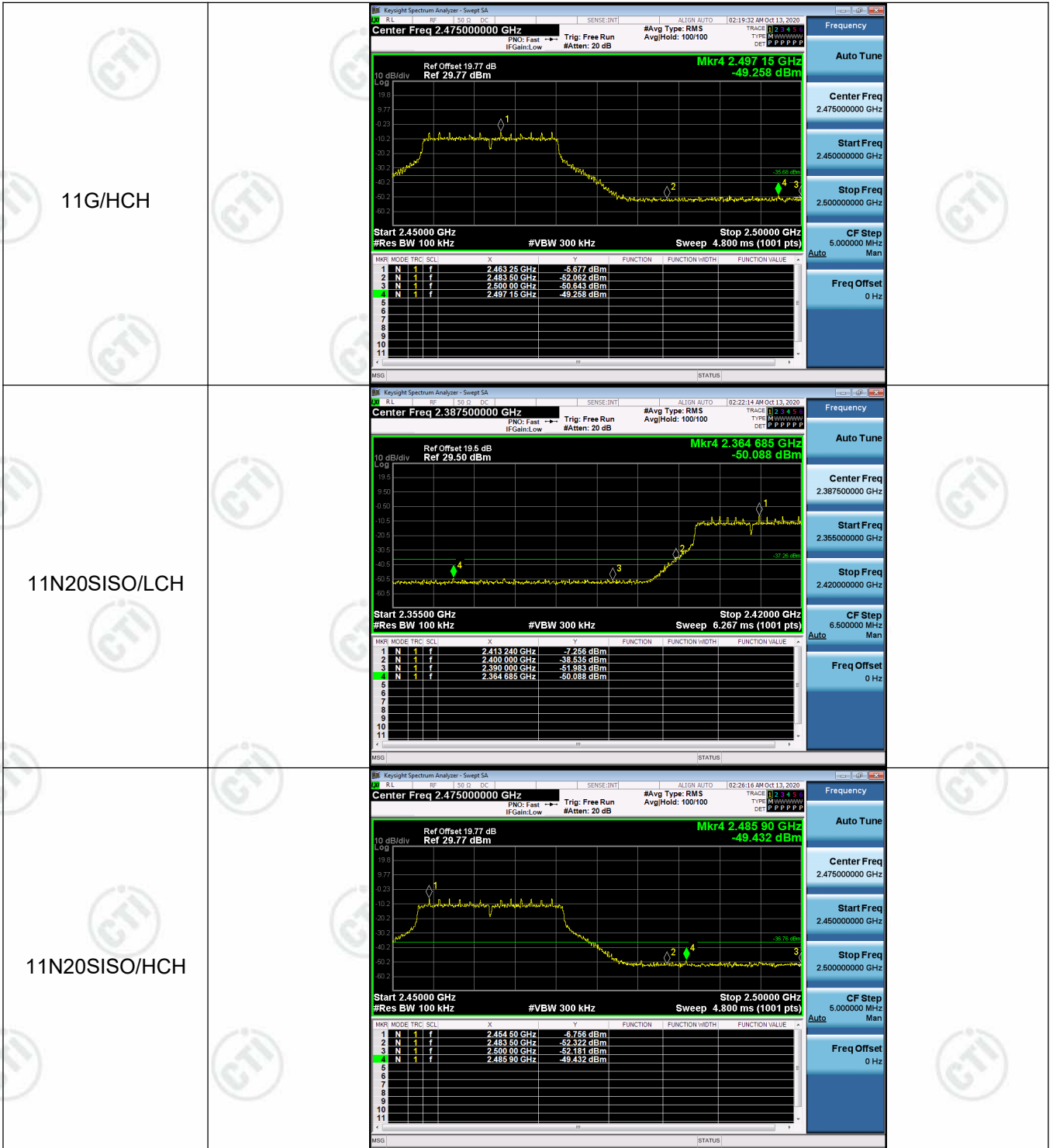



Appendix D): RF Conducted Spurious Emissions

Test Limit

According to §15.247(d),

In any 100 kHz bandwidth outside the authorized frequency band,

Non-restricted bands shall be attenuated at least 20 dB/30 dB relative to the maximum PSD level in 100 kHz by RF conducted or a radiated measurement which fall in the restricted bands, as defined in §15.205(a), must also comply with the radiated emission limits specified in §15.209(a).

Test Procedure

Test method Refer as KDB 558074 D01.

1. EUT RF output port connected to the SA by RF cable, and the path loss was compensated to result.
2. SA setting, RBW=100kHz, VBW=300kHz, Detector=Peak, Trace mode = max hold, SWT = Auto.
3. In any 100 kHz bandwidth outside the authorized frequency band, shall be attenuated at least 20 dB relative to the maximum in-band peak PSD level in 100 kHz when conducted power procedure is used. If the transmitter complies with the conducted power limits based on the use of RMS averaging over a time interval, the attenuation required under this paragraph shall be 30 dB instead of 20 dB.

Test Setup

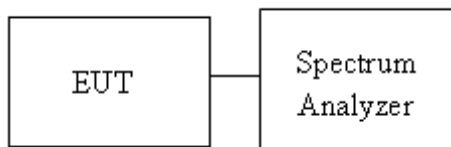

Result Table

Mode	Channel	Pref [dBm]	Puw[dBm]	Verdict
11B	LCH	1.064	<Limit	PASS
11B	MCH	1.394	<Limit	PASS
11B	HCH	0.852	<Limit	PASS
11G	LCH	-5.594	<Limit	PASS
11G	MCH	-5.843	<Limit	PASS
11G	HCH	-5.74	<Limit	PASS
11N20SISO	LCH	-7.125	<Limit	PASS
11N20SISO	MCH	-6.85	<Limit	PASS
11N20SISO	HCH	-6.632	<Limit	PASS
11N40SISO	LCH	-10.716	<Limit	PASS
11N40SISO	MCH	-10.507	<Limit	PASS
11N40SISO	HCH	-10.606	<Limit	PASS

Test Graph







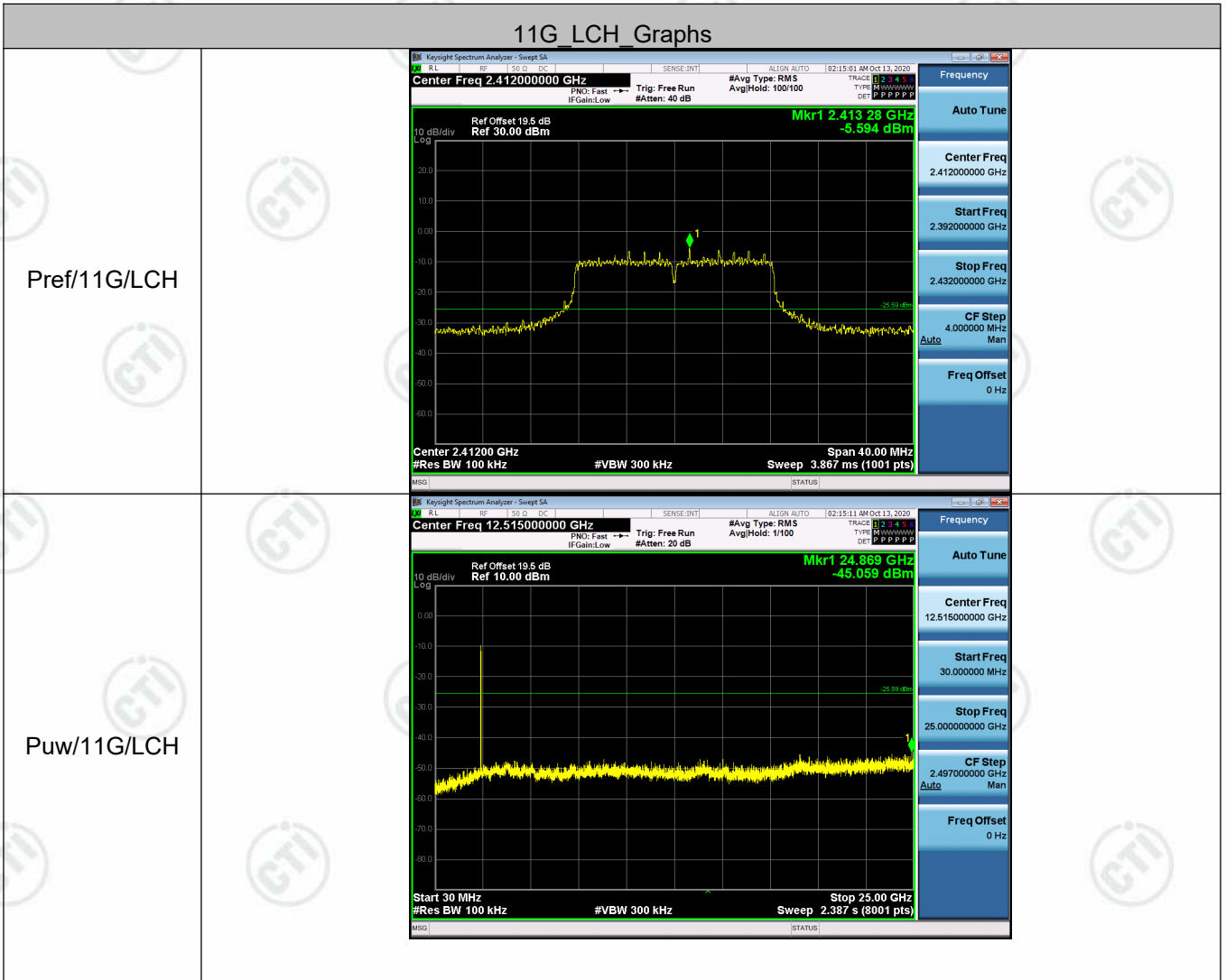



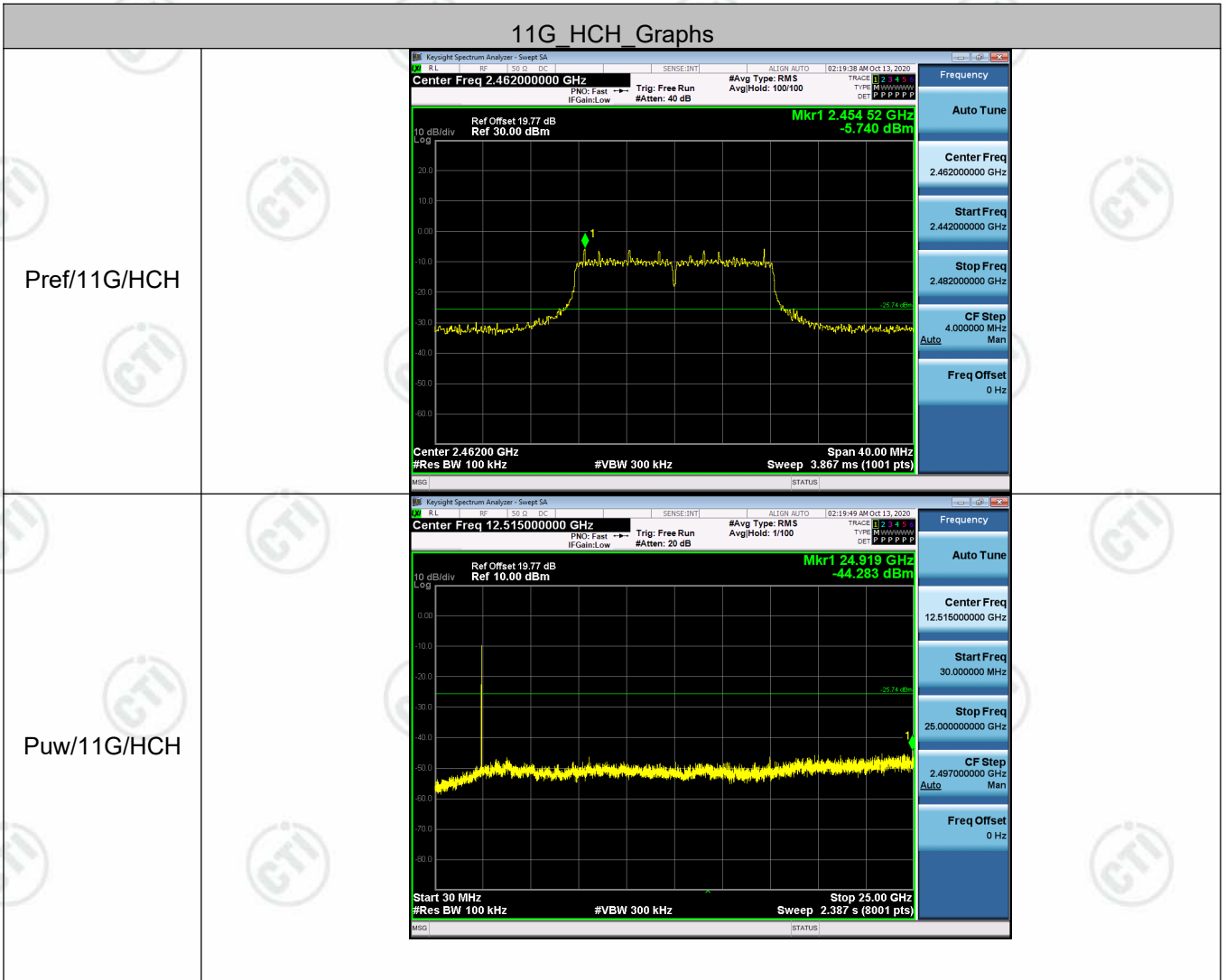

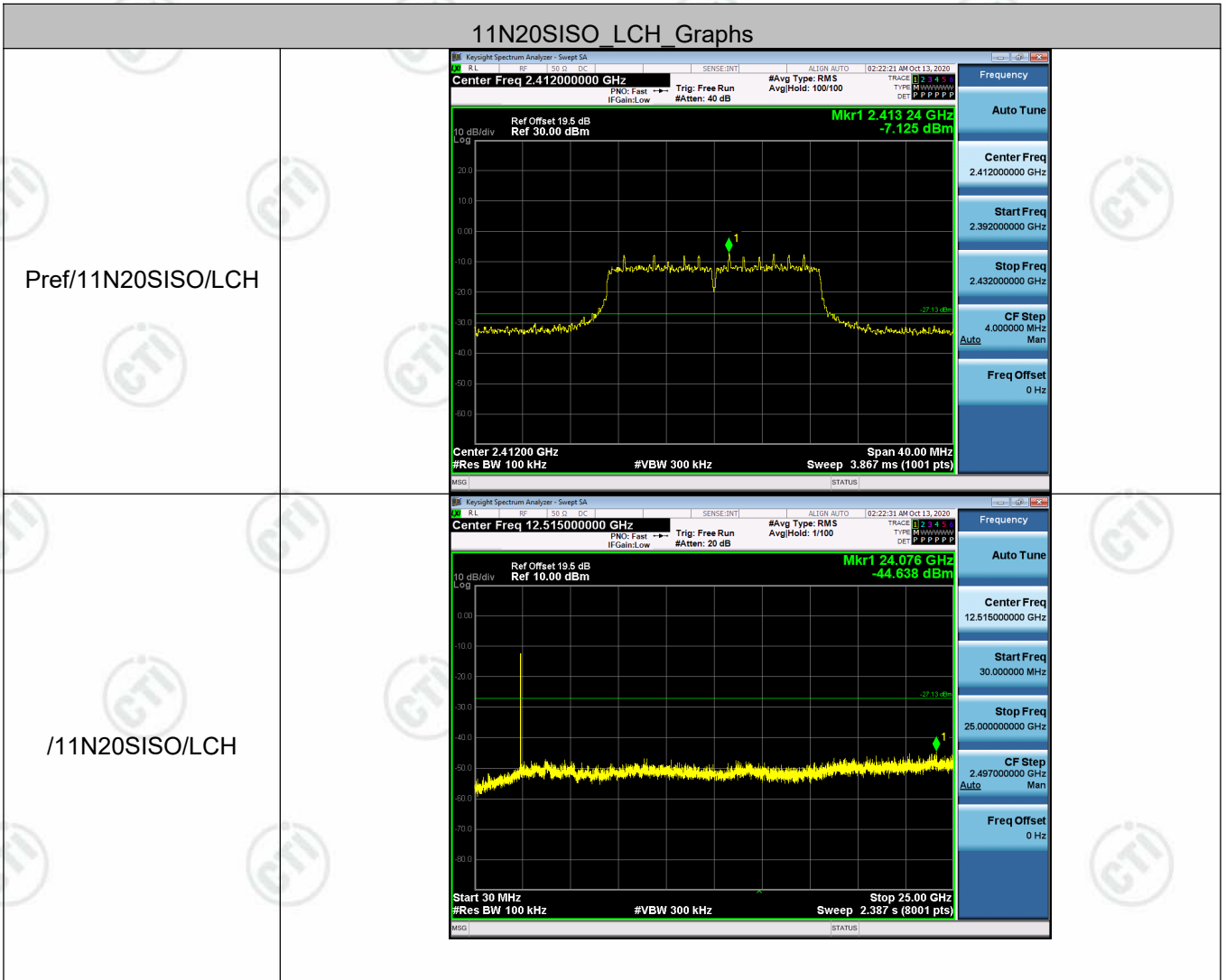

11N20SISO MCH Graphs

Pref/11N20SISO/MCH

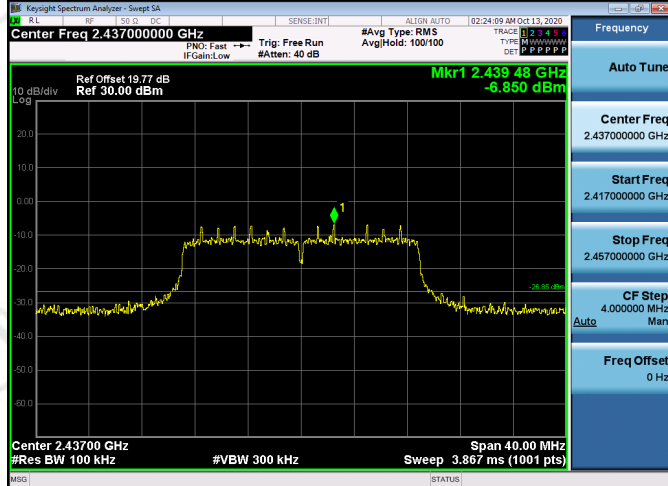

Puw/11N20SISO/MCH

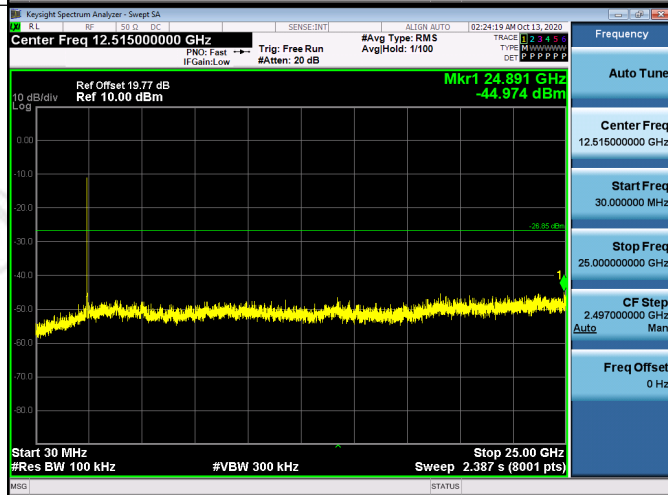

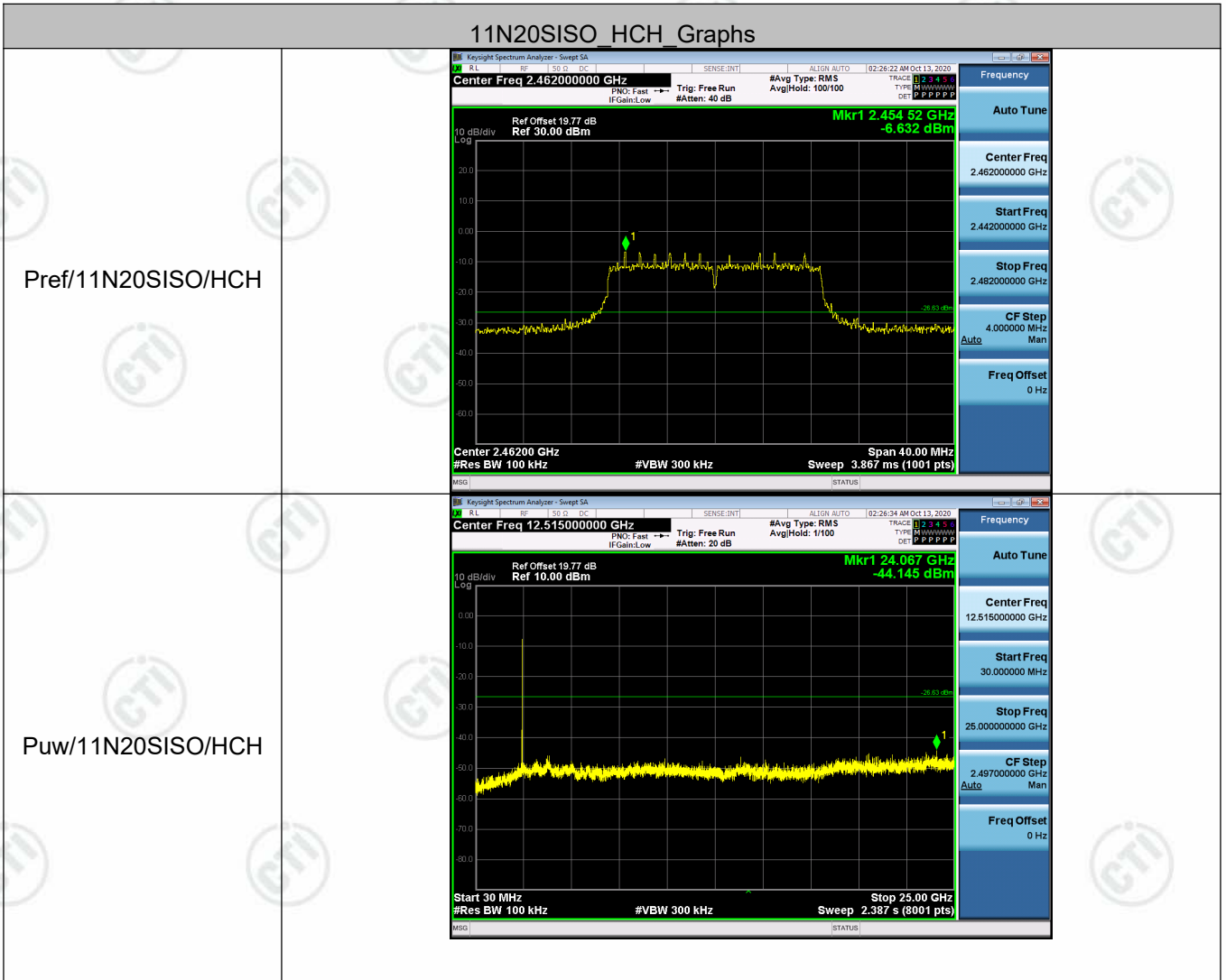

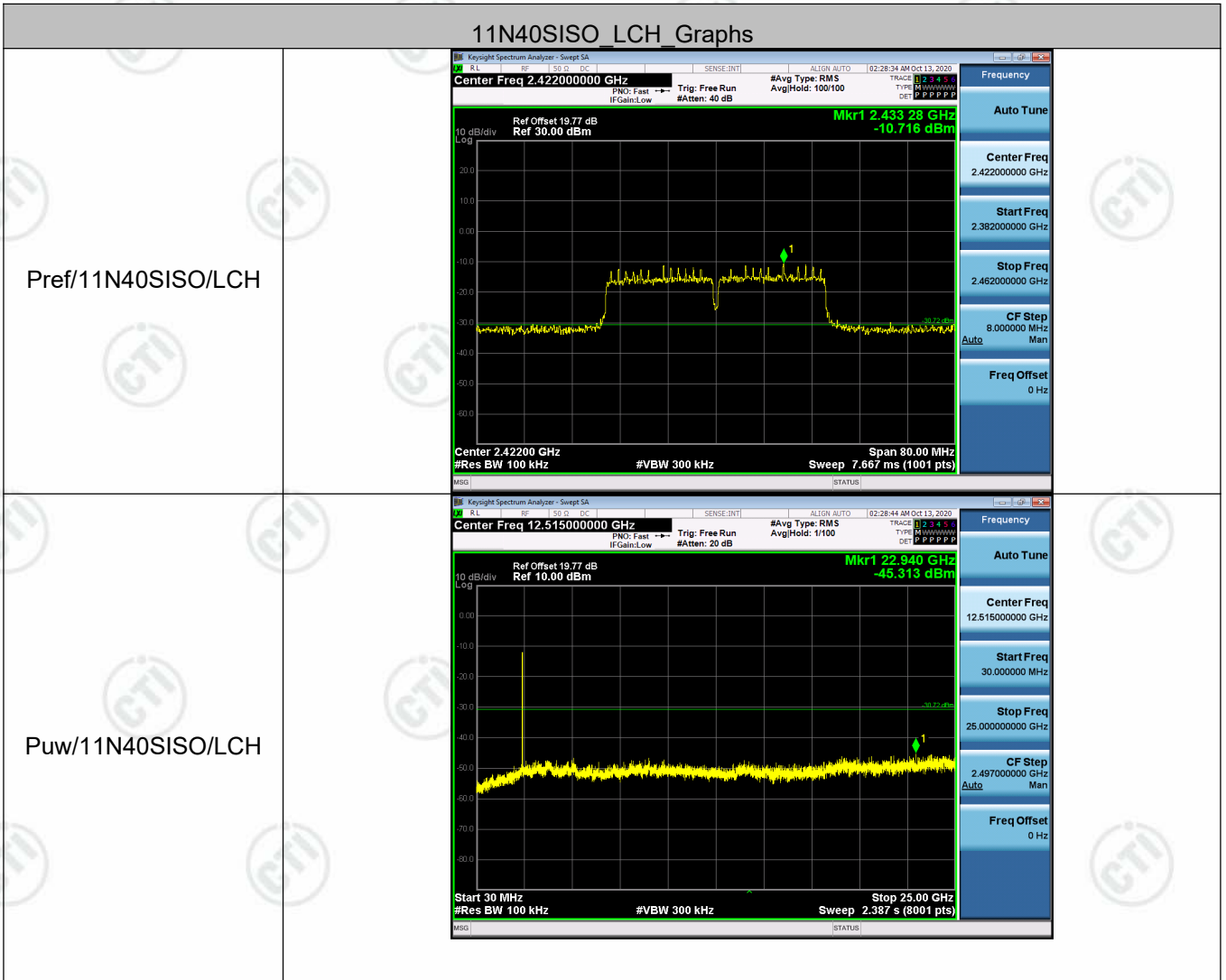

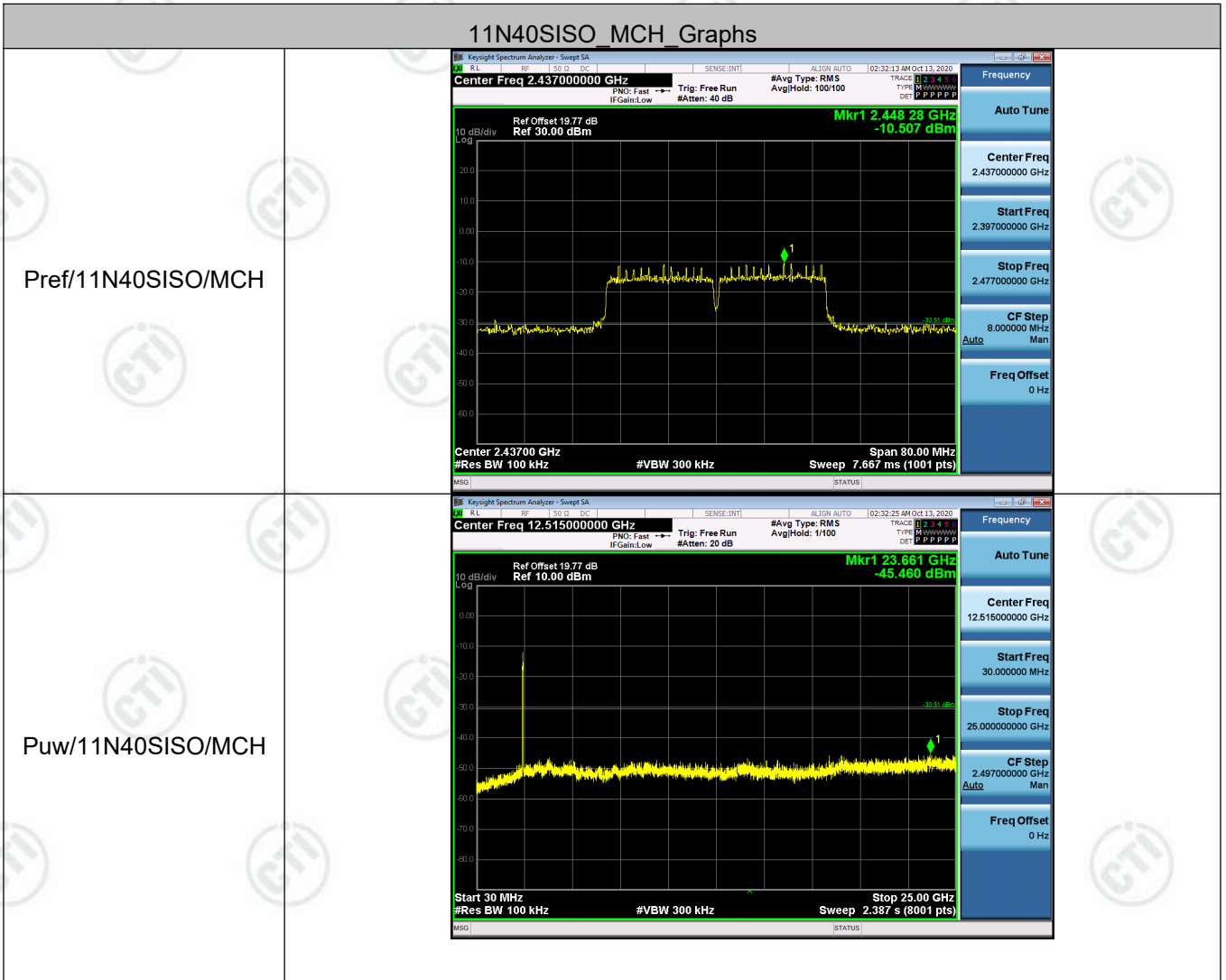



Appendix E): Power Spectral Density

Test Limit

According to §15.247(e),

For digitally modulated systems, the power spectral density conducted from the intentional radiator to the antenna shall not be greater than 8 dBm in any 3 kHz band during any time interval of continuous transmission.

Limit	<input checked="" type="checkbox"/> Antenna not exceed 6 dBi : 8dBm <input type="checkbox"/> Antenna with DG greater than 6 dBi : [Limit = 8 – (DG – 6)] <input type="checkbox"/> Point-to-point operation :
-------	---

Test Procedure

Test method Refer as KDB 558074 D01.

1. The EUT RF output connected to the spectrum analyzer by RF cable.
2. Setting maximum power transmit of EUT
3. SA set RBW = 3kHz, VBW = 10kHz, Span = 1.5 times DTS Bandwidth (6 dB BW), Detector = Peak, Sweep Time = Auto and Trace = Max hold.
4. The path loss was compensated to the results for each measurement by SA.
5. Mark the maximum level.
6. Measure and record the result of power spectral density. in the test report.

Test Setup

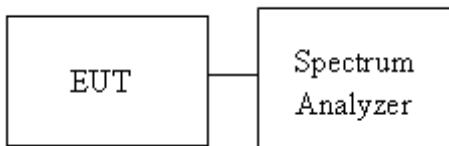

Result Table

Mode	Channel	Power Spectral Density [dBm]	Verdict
11B	LCH	-12.494	PASS
11B	MCH	-12.478	PASS
11B	HCH	-13.149	PASS
11G	LCH	-19.825	PASS
11G	MCH	-20.976	PASS
11G	HCH	-19.672	PASS
11N20SISO	LCH	-21.612	PASS
11N20SISO	MCH	-21.116	PASS
11N20SISO	HCH	-20.652	PASS
11N40SISO	LCH	-25.492	PASS
11N40SISO	MCH	-25.487	PASS
11N40SISO	HCH	-25.421	PASS

Test Graph

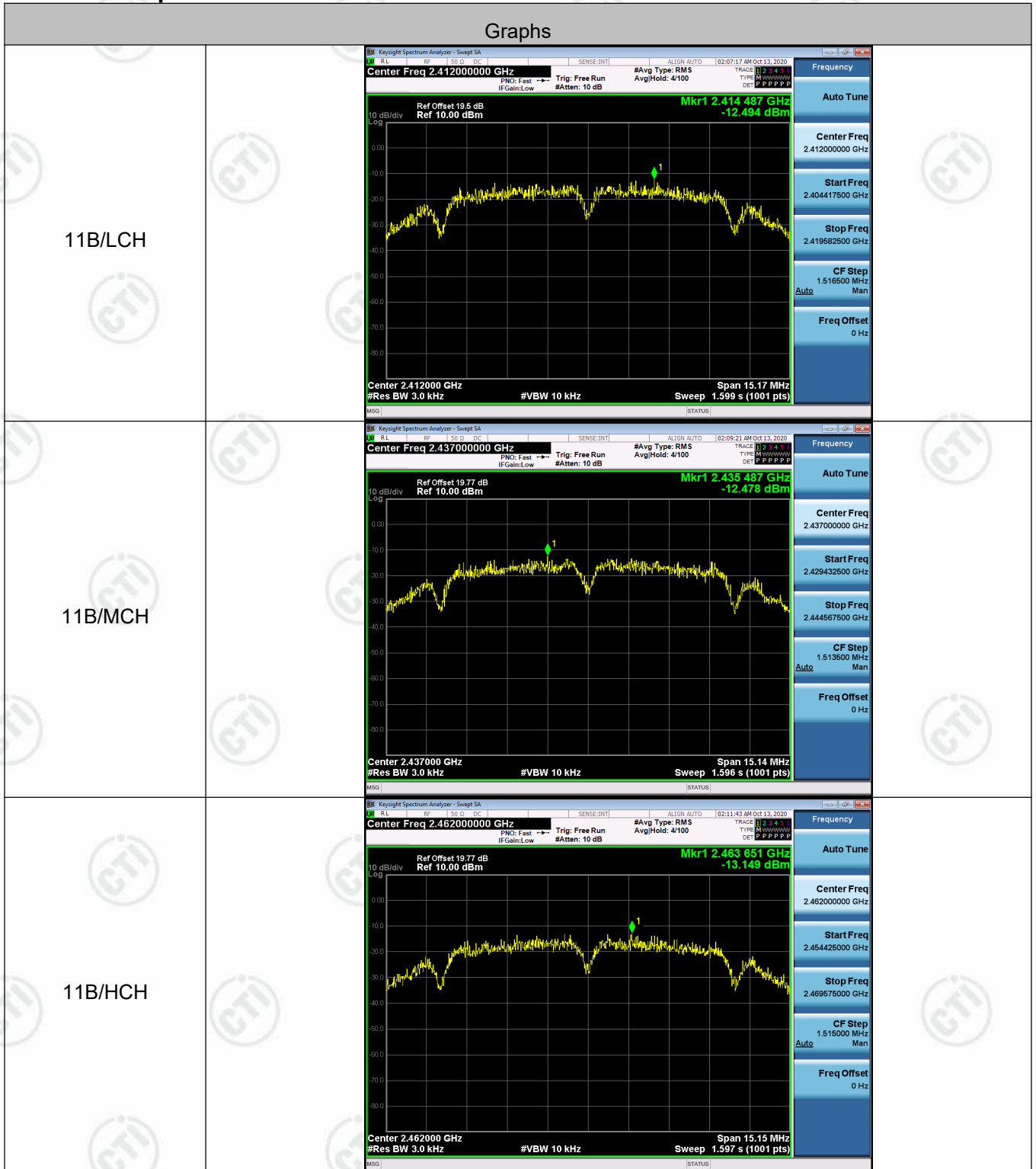

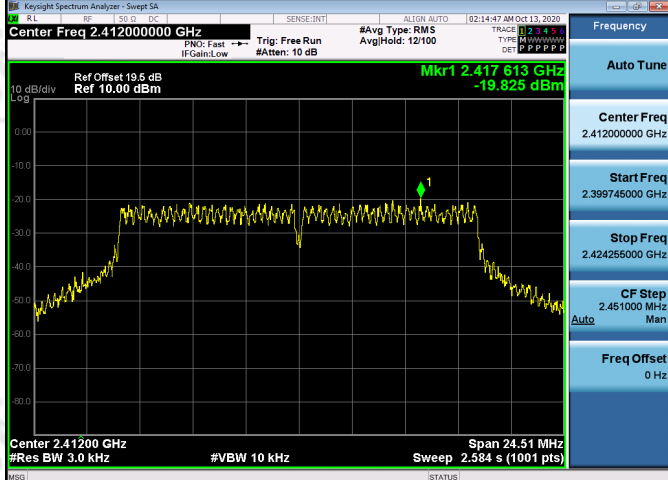
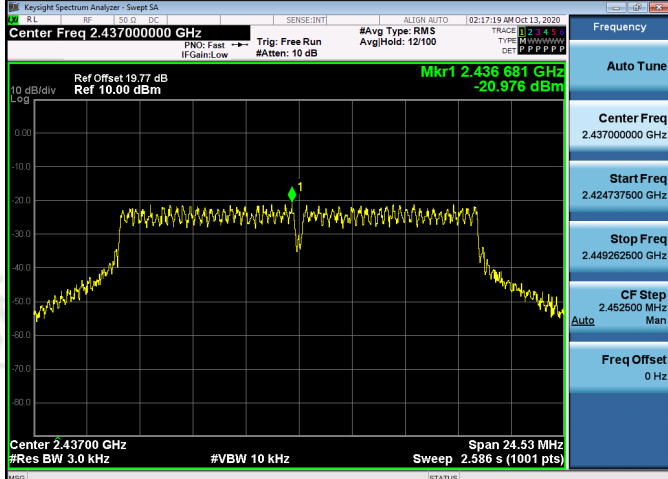
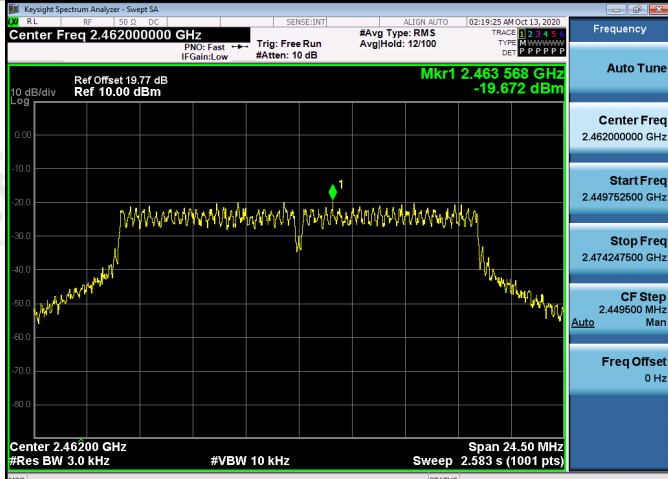
<p>11G/LCH</p>	 <p>Keyight Spectrum Analyzer - Swept SA Center Freq 2.41200000 GHz Ref Offset 19.5 dB Ref 10.00 dBm Mkr1 2.417 613 GHz -19.825 dBm Center 2.41200 GHz #Res BW 3.0 kHz #VBW 10 kHz Span 24.51 MHz Sweep 2.584 s (1001 pts)</p>
<p>11G/MCH</p>	 <p>Keyight Spectrum Analyzer - Swept SA Center Freq 2.43700000 GHz Ref Offset 19.77 dB Ref 10.00 dBm Mkr1 2.436 681 GHz -20.976 dBm Center 2.43700 GHz #Res BW 3.0 kHz #VBW 10 kHz Span 24.53 MHz Sweep 2.586 s (1001 pts)</p>
<p>11G/HCH</p>	 <p>Keyight Spectrum Analyzer - Swept SA Center Freq 2.46200000 GHz Ref Offset 19.77 dB Ref 10.00 dBm Mkr1 2.463 568 GHz -19.672 dBm Center 2.46200 GHz #Res BW 3.0 kHz #VBW 10 kHz Span 24.50 MHz Sweep 2.583 s (1001 pts)</p>

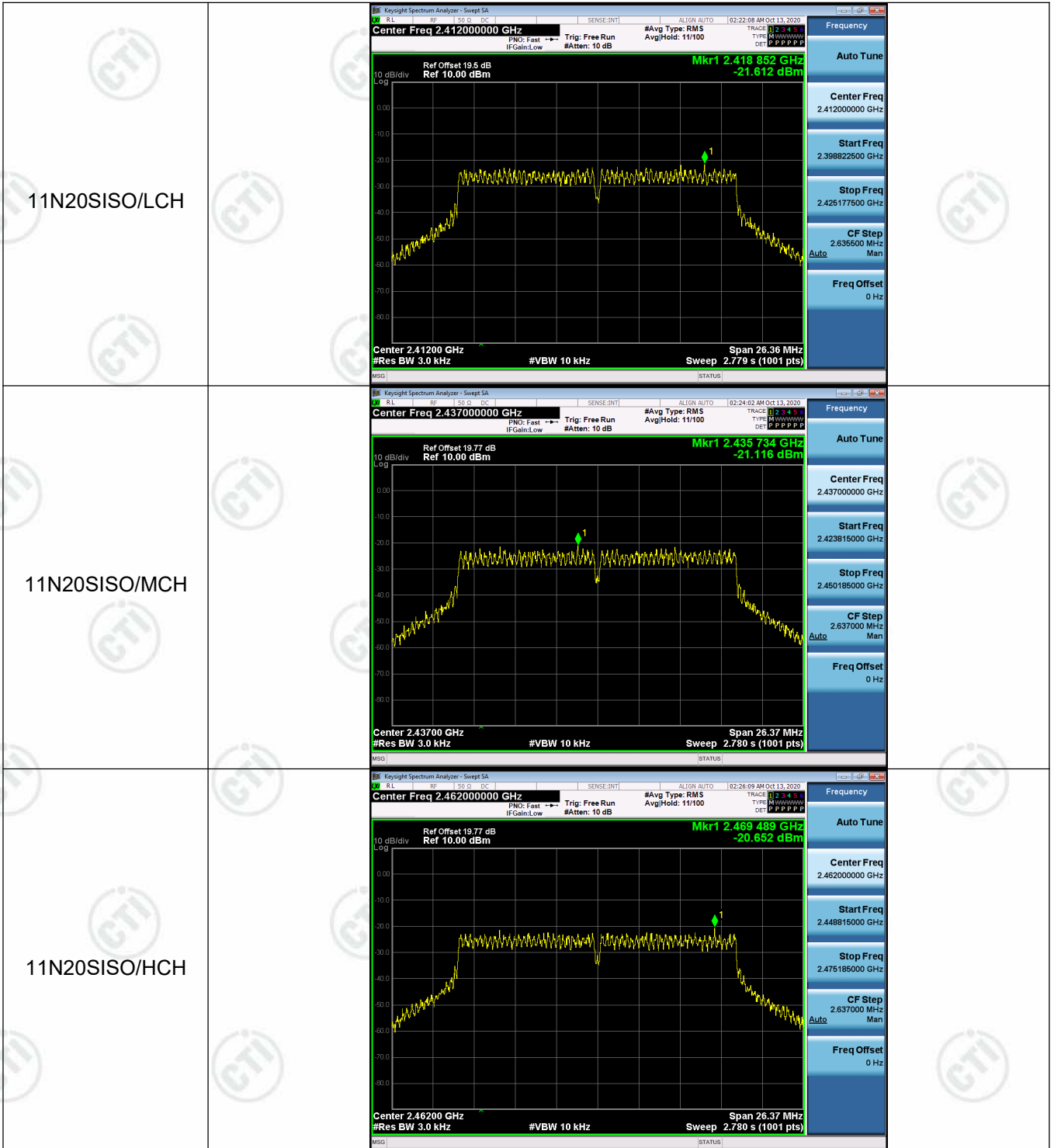

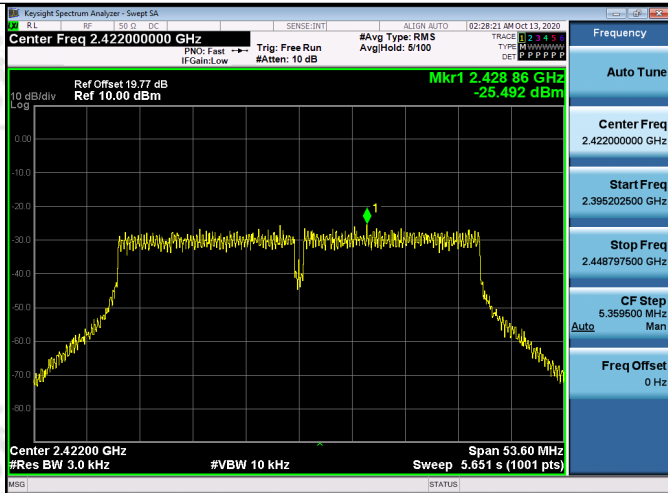
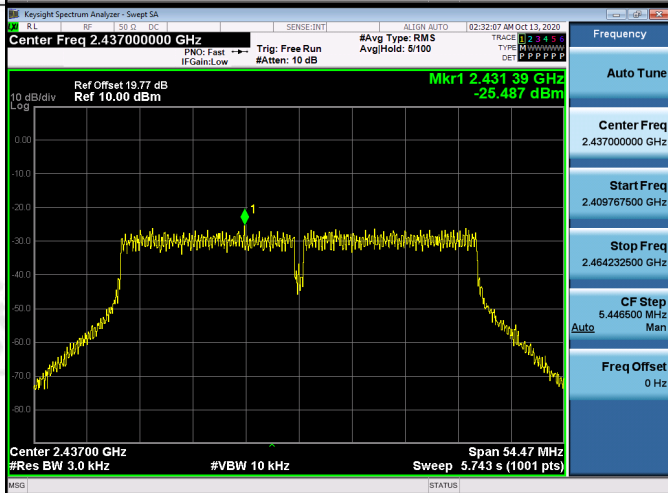
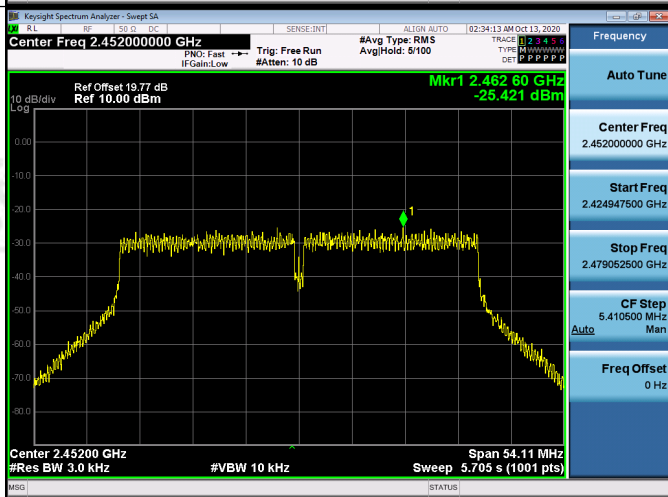
<p>11N40SISO/LCH</p>	 <p>Keyight Spectrum Analyzer - Sweep SA Center Freq 2.42200000 GHz Ref Offset 19.77 dB Ref 10.00 dBm Mkr1 2.428 86 GHz -25.492 dBm Center 2.42200 GHz #Res BW 3.0 kHz #VBW 10 kHz Span 53.60 MHz Sweep 5.651 s (1001 pts)</p>
<p>11N40SISO/MCH</p>	 <p>Keyight Spectrum Analyzer - Sweep SA Center Freq 2.43700000 GHz Ref Offset 19.77 dB Ref 10.00 dBm Mkr1 2.431 39 GHz -25.487 dBm Center 2.43700 GHz #Res BW 3.0 kHz #VBW 10 kHz Span 54.47 MHz Sweep 5.743 s (1001 pts)</p>
<p>11N40SISO/HCH</p>	 <p>Keyight Spectrum Analyzer - Sweep SA Center Freq 2.45200000 GHz Ref Offset 19.77 dB Ref 10.00 dBm Mkr1 2.462 80 GHz -25.421 dBm Center 2.45200 GHz #Res BW 3.0 kHz #VBW 10 kHz Span 54.11 MHz Sweep 5.705 s (1001 pts)</p>

Appendix F): Antenna Requirement

15.203 requirement:

An intentional radiator shall be designed to ensure that no antenna other than that furnished by the responsible party shall be used with the device. The use of a permanently attached antenna or of an antenna that uses a unique coupling to the intentional radiator, the manufacturer may design the unit so that a broken antenna can be replaced by the user, but the use of a standard antenna jack or electrical connector is prohibited.

15.247(b) (4) requirement:

The conducted output power limit specified in paragraph (b) of this section is based on the use of antennas with directional gains that do not exceed 6 dBi. Except as shown in paragraph (c) of this section, if transmitting antennas of directional gain greater than 6 dBi are used, the conducted output power from the intentional radiator shall be reduced below the stated values in paragraphs (b)(1), (b)(2), and (b)(3) of this section, as appropriate, by the amount in dB that the directional gain of the antenna exceeds 6 dBi.

EUT Antenna:



The antenna is FPC antenna. The best case gain of the antenna is 1.15dBi.

Appendix G): AC Power Line Conducted Emission

<p>Test Procedure:</p>	<p>Test frequency range :150KHz-30MHz</p> <ol style="list-style-type: none"> 1) The mains terminal disturbance voltage test was conducted in a shielded room. 2) The EUT was connected to AC power source through a LISN 1 (Line Impedance Stabilization Network) which provides a 50Ω/50μH + 5Ω linear impedance. The power cables of all other units of the EUT were connected to a second LISN 2, which was bonded to the ground reference plane in the same way as the LISN 1 for the unit being measured. A multiple socket outlet strip was used to connect multiple power cables to a single LISN provided the rating of the LISN was not exceeded. 3) The tabletop EUT was placed upon a non-metallic table 0.8m above the ground reference plane. And for floor-standing arrangement, the EUT was placed on the horizontal ground reference plane, 4) The test was performed with a vertical ground reference plane. The rear of the EUT shall be 0.4 m from the vertical ground reference plane. The vertical ground reference plane was bonded to the horizontal ground reference plane. The LISN 1 was placed 0.8 m from the boundary of the unit under test and bonded to a ground reference plane for LISNs mounted on top of the ground reference plane. This distance was between the closest points of the LISN 1 and the EUT. All other units of the EUT and associated equipment was at least 0.8 m from the LISN 2. 5) In order to find the maximum emission, the relative positions of equipment and all of the interface cables must be changed according to ANSI C63.10 on conducted measurement. 														
<p>Limit:</p>	<table border="1" data-bbox="464 1115 1331 1339"> <thead> <tr> <th rowspan="2">Frequency range (MHz)</th> <th colspan="2">Limit (dBμV)</th> </tr> <tr> <th>Quasi-peak</th> <th>Average</th> </tr> </thead> <tbody> <tr> <td>0.15-0.5</td> <td>66 to 56*</td> <td>56 to 46*</td> </tr> <tr> <td>0.5-5</td> <td>56</td> <td>46</td> </tr> <tr> <td>5-30</td> <td>60</td> <td>50</td> </tr> </tbody> </table> <p>* The limit decreases linearly with the logarithm of the frequency in the range 0.15 MHz to 0.50 MHz. NOTE : The lower limit is applicable at the transition frequency</p>	Frequency range (MHz)	Limit (dBμV)		Quasi-peak	Average	0.15-0.5	66 to 56*	56 to 46*	0.5-5	56	46	5-30	60	50
Frequency range (MHz)	Limit (dBμV)														
	Quasi-peak	Average													
0.15-0.5	66 to 56*	56 to 46*													
0.5-5	56	46													
5-30	60	50													

Measurement Data

An initial pre-scan was performed on the live and neutral lines with peak detector.

Quasi-Peak and Average measurement were performed at the frequencies with maximized peak emission were detected.

Live line:

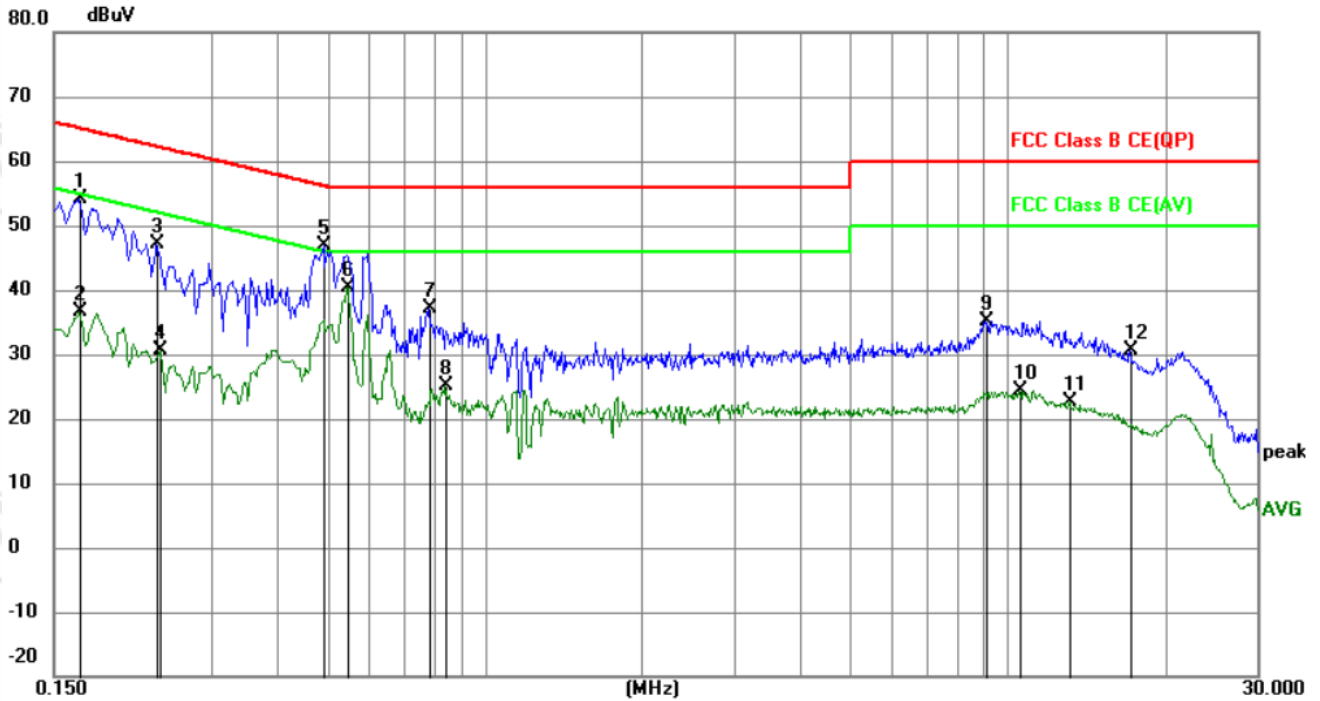

No.	Mk.	Freq. MHz	Reading Level dBuV	Correct Factor dB	Measure- ment dBuV	Limit dBuV	Margin dB	Detector	Comment
1		0.1680	44.27	9.87	54.14	65.06	-10.92	QP	
2		0.1680	26.68	9.87	36.55	55.06	-18.51	AVG	
3		0.2355	37.24	9.94	47.18	62.25	-15.07	QP	
4		0.2400	20.73	9.95	30.68	52.10	-21.42	AVG	
5		0.4920	36.87	9.95	46.82	56.13	-9.31	QP	
6	*	0.5460	30.27	10.01	40.28	46.00	-5.72	AVG	
7		0.7799	27.28	9.86	37.14	56.00	-18.86	QP	
8		0.8430	15.34	9.85	25.19	46.00	-20.81	AVG	
9		9.1005	25.37	9.78	35.15	60.00	-24.85	QP	
10		10.5540	14.47	9.80	24.27	50.00	-25.73	AVG	
11		13.1370	12.70	9.87	22.57	50.00	-27.43	AVG	
12		17.1645	20.60	9.95	30.55	60.00	-29.45	QP	

Neutral line:

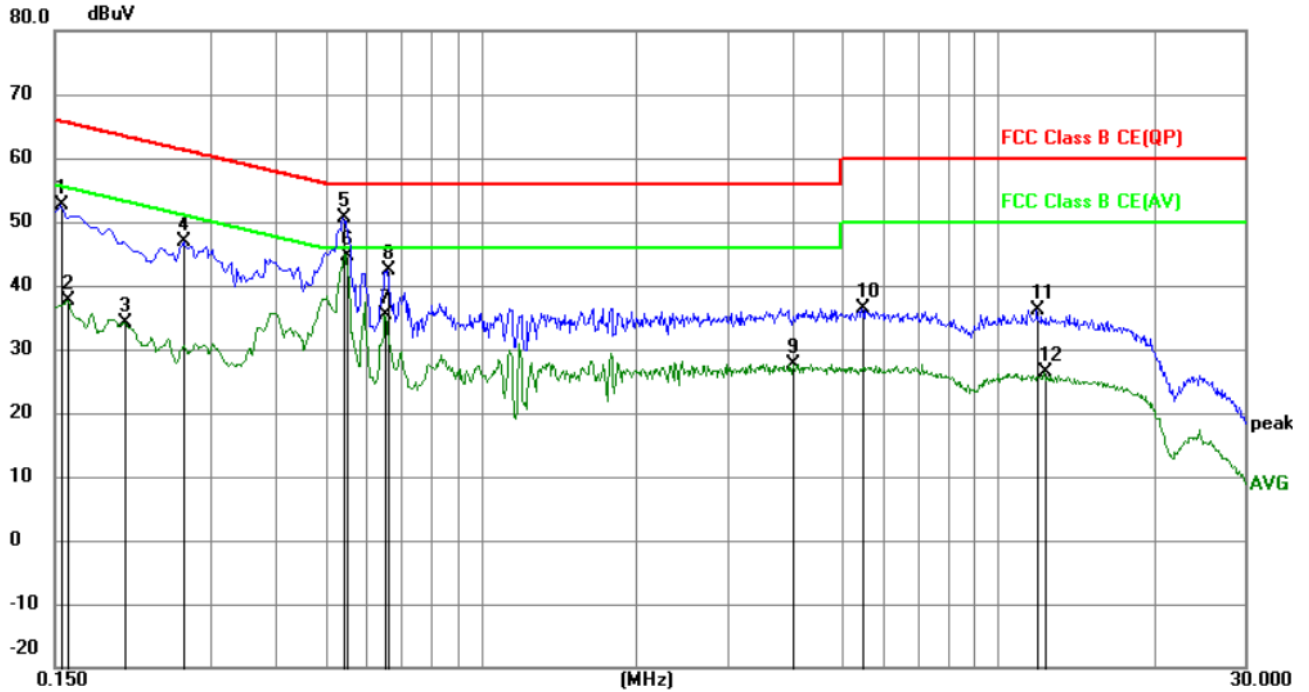

No.	Mk.	Freq. MHz	Reading Level dBuV	Correct Factor dB	Measure- ment dBuV	Limit dBuV	Margin dB	Detector	Comment
1		0.1545	42.64	9.87	52.51	65.75	-13.24	QP	
2		0.1590	27.74	9.87	37.61	55.52	-17.91	AVG	
3		0.2040	24.33	9.88	34.21	53.45	-19.24	AVG	
4		0.2670	36.90	10.00	46.90	61.21	-14.31	QP	
5		0.5415	40.67	10.00	50.67	56.00	-5.33	QP	
6	*	0.5505	34.69	10.01	44.70	46.00	-1.30	AVG	
7		0.6540	25.33	9.97	35.30	46.00	-10.70	AVG	
8		0.6585	32.45	9.96	42.41	56.00	-13.59	QP	
9		4.0245	17.96	9.78	27.74	46.00	-18.26	AVG	
10		5.4510	26.54	9.78	36.32	60.00	-23.68	QP	
11		11.9220	26.37	9.84	36.21	60.00	-23.79	QP	
12		12.2729	16.50	9.85	26.35	50.00	-23.65	AVG	

Notes:

1. The following Quasi-Peak and Average measurements were performed on the EUT:
2. Final Test Level =Receiver Reading + LISN Factor + Cable Loss.

Appendix H): Restricted bands around fundamental frequency (Radiated)

Receiver Setup:	<table border="1"> <thead> <tr> <th>Frequency</th> <th>Detector</th> <th>RBW</th> <th>VBW</th> <th>Remark</th> </tr> </thead> <tbody> <tr> <td>30MHz-1GHz</td> <td>Quasi-peak</td> <td>120kHz</td> <td>300kHz</td> <td>Quasi-peak</td> </tr> <tr> <td rowspan="2">Above 1GHz</td> <td>Peak</td> <td>1MHz</td> <td>3MHz</td> <td>Peak</td> </tr> <tr> <td>Peak</td> <td>1MHz</td> <td>10Hz</td> <td>Average</td> </tr> </tbody> </table>	Frequency	Detector	RBW	VBW	Remark	30MHz-1GHz	Quasi-peak	120kHz	300kHz	Quasi-peak	Above 1GHz	Peak	1MHz	3MHz	Peak	Peak	1MHz	10Hz	Average	
Frequency	Detector	RBW	VBW	Remark																	
30MHz-1GHz	Quasi-peak	120kHz	300kHz	Quasi-peak																	
Above 1GHz	Peak	1MHz	3MHz	Peak																	
	Peak	1MHz	10Hz	Average																	
Test Procedure:	<p>Below 1GHz test procedure as below:</p> <p>Test method Refer as KDB 558074 D01</p> <ol style="list-style-type: none"> The EUT was placed on the top of a rotating table 0.8 meters above the ground at a 3 meter semi-anechoic chamber. The table was rotated 360 degrees to determine the position of the highest radiation. The EUT was set 3 meters away from the interference-receiving antenna, which was mounted on the top of a variable-height antenna tower. The antenna height is varied from one meter to four meters above the ground to determine the maximum value of the field strength. Both horizontal and vertical polarizations of the antenna are set to make the measurement. For each suspected emission, the EUT was arranged to its worst case and then the antenna was tuned to heights from 1 meter to 4 meters and the rotatable was turned from 0 degrees to 360 degrees to find the maximum reading. The test-receiver system was set to Peak Detect Function and Specified Bandwidth with Maximum Hold Mode. Place a marker at the end of the restricted band closest to the transmit frequency to show compliance. Also measure any emissions in the restricted bands. Save the spectrum analyzer plot. Repeat for each power and modulation for lowest and highest channel <p>Above 1GHz test procedure as below:</p> <ol style="list-style-type: none"> Different between above is the test site, change from Semi- Anechoic Chamber to fully Anechoic Chamber change form table 0.8 meter to 1.5 meter(Above 18GHz the distance is 1 meter and table is 1.5 meter). Test the EUT in the lowest channel , the Highest channel The radiation measurements are performed in X, Y, Z axis positioning for Transmitting mode, and found the X axis positioning which it is worse case. Repeat above procedures until all frequencies measured was complete. 																				
Limit:	<table border="1"> <thead> <tr> <th>Frequency</th> <th>Limit (dBμV/m @3m)</th> <th>Remark</th> </tr> </thead> <tbody> <tr> <td>30MHz-88MHz</td> <td>40.0</td> <td>Quasi-peak Value</td> </tr> <tr> <td>88MHz-216MHz</td> <td>43.5</td> <td>Quasi-peak Value</td> </tr> <tr> <td>216MHz-960MHz</td> <td>46.0</td> <td>Quasi-peak Value</td> </tr> <tr> <td>960MHz-1GHz</td> <td>54.0</td> <td>Quasi-peak Value</td> </tr> <tr> <td rowspan="2">Above 1GHz</td> <td>54.0</td> <td>Average Value</td> </tr> <tr> <td>74.0</td> <td>Peak Value</td> </tr> </tbody> </table>	Frequency	Limit (dB μ V/m @3m)	Remark	30MHz-88MHz	40.0	Quasi-peak Value	88MHz-216MHz	43.5	Quasi-peak Value	216MHz-960MHz	46.0	Quasi-peak Value	960MHz-1GHz	54.0	Quasi-peak Value	Above 1GHz	54.0	Average Value	74.0	Peak Value
Frequency	Limit (dB μ V/m @3m)	Remark																			
30MHz-88MHz	40.0	Quasi-peak Value																			
88MHz-216MHz	43.5	Quasi-peak Value																			
216MHz-960MHz	46.0	Quasi-peak Value																			
960MHz-1GHz	54.0	Quasi-peak Value																			
Above 1GHz	54.0	Average Value																			
	74.0	Peak Value																			

Test plot as follows:

Mode:	802.11 b(1Mbps) Transmitting	Channel:	2412
Remark:	PK		

Test Graph

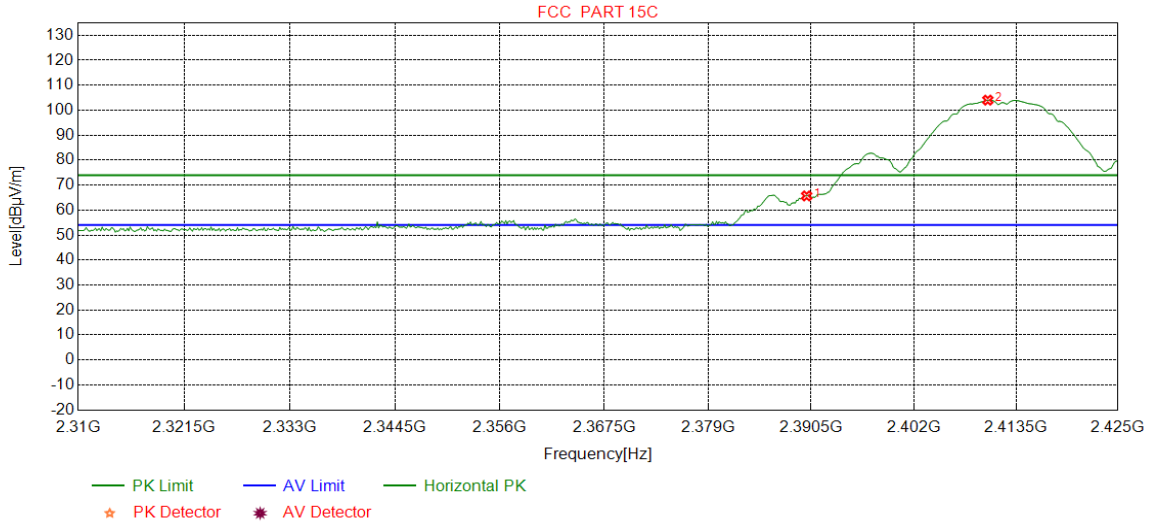

NO	Freq. [MHz]	Ant Factor [dB]	Cable loss [dB]	Pream gain [dB]	Reading [dBµV]	Level [dBµV/m]	Limit [dBµV/m]	Margin [dB]	Result	Polarity
1	2390.0000	32.25	13.37	-43.12	63.17	65.67	74.00	8.33	Pass	Horizontal
2	2410.3191	32.27	13.35	-43.12	101.53	104.03	74.00	-30.03	Pass	Horizontal

Mode:	802.11 b(1Mbps) Transmitting	Channel:	2412
Remark:	PK		

Test Graph

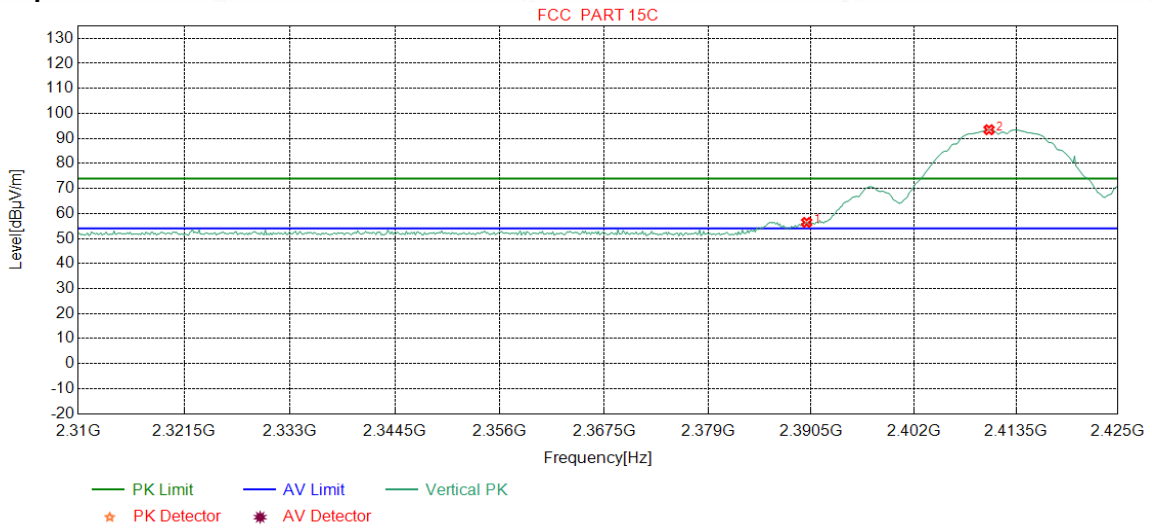

NO	Freq. [MHz]	Ant Factor [dB]	Cable loss [dB]	Pream gain [dB]	Reading [dBµV]	Level [dBµV/m]	Limit [dBµV/m]	Margin [dB]	Result	Polarity
1	2390.0000	32.25	13.37	-43.12	53.95	56.45	74.00	17.55	Pass	Vertical
2	2410.4631	32.27	13.35	-43.12	90.97	93.47	74.00	-19.47	Pass	Vertical

Mode:	802.11 b(1Mbps) Transmitting	Channel:	2412
Remark:	AV		

Test Graph

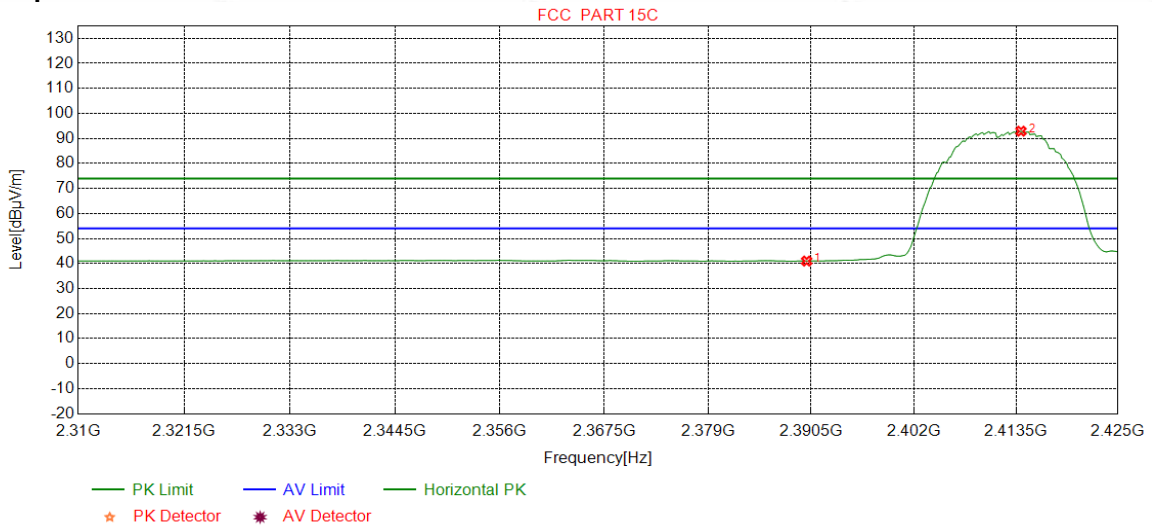

NO	Freq. [MHz]	Ant Factor [dB]	Cable loss [dB]	Pream gain [dB]	Reading [dBµV]	Level [dBµV/m]	Limit [dBµV/m]	Margin [dB]	Result	Polarity
1	2390.0000	32.25	13.37	-43.12	38.49	40.99	54.00	13.01	Pass	Horizontal
2	2414.0613	32.28	13.36	-43.11	90.37	92.90	54.00	-38.90	Pass	Horizontal

Mode:	802.11 b(1Mbps) Transmitting	Channel:	2412
Remark:	AV		

Test Graph

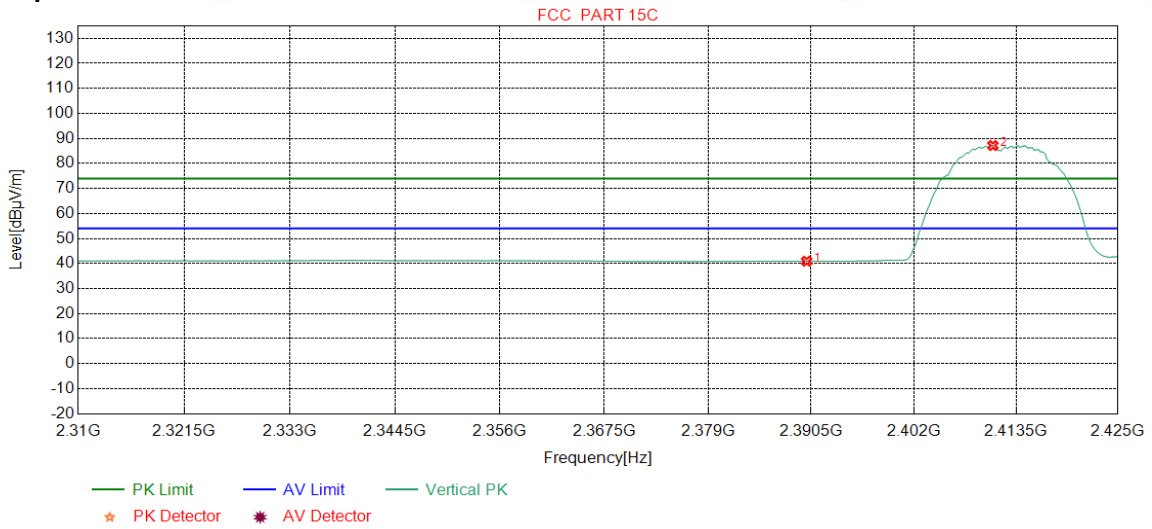

NO	Freq. [MHz]	Ant Factor [dB]	Cable loss [dB]	Pream gain [dB]	Reading [dBµV]	Level [dBµV/m]	Limit [dBµV/m]	Margin [dB]	Result	Polarity
1	2390.0000	32.25	13.37	-43.12	38.42	40.92	54.00	13.08	Pass	Vertical
2	2410.8949	32.28	13.35	-43.12	84.65	87.16	54.00	-33.16	Pass	Vertical

Mode:	802.11 b(1Mbps) Transmitting	Channel:	2462
Remark:	PK		

Test Graph

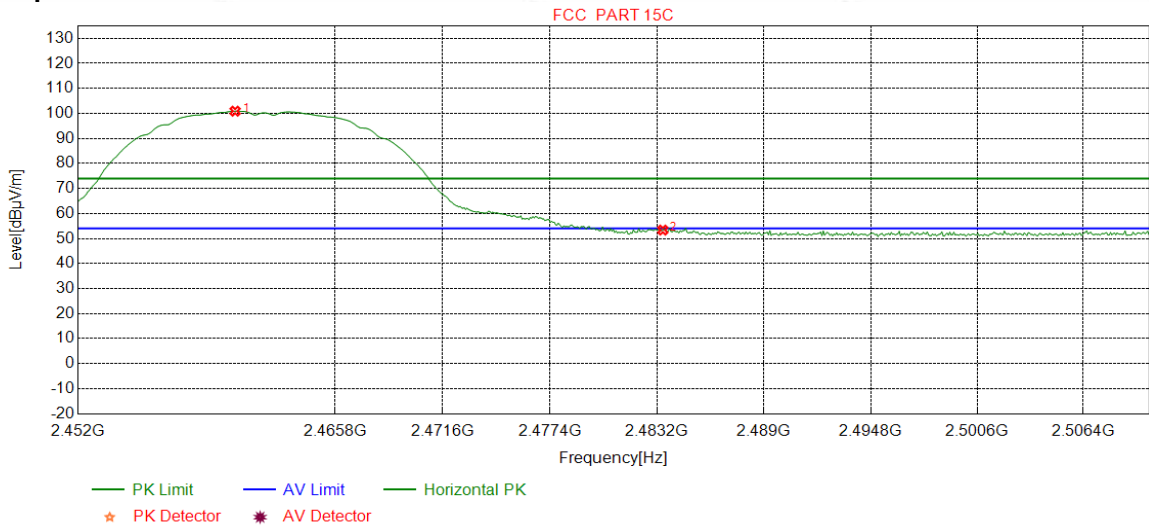

NO	Freq. [MHz]	Ant Factor [dB]	Cable loss [dB]	Pream gain [dB]	Reading [dBµV]	Level [dBµV/m]	Limit [dBµV/m]	Margin [dB]	Result	Polarity
1	2460.4205	32.34	13.48	-43.10	98.17	100.89	74.00	-26.89	Pass	Horizontal
2	2483.5000	32.38	13.38	-43.11	50.72	53.37	74.00	20.63	Pass	Horizontal

Mode:	802.11 b(1Mbps) Transmitting	Channel:	2462
Remark:	PK		

Test Graph

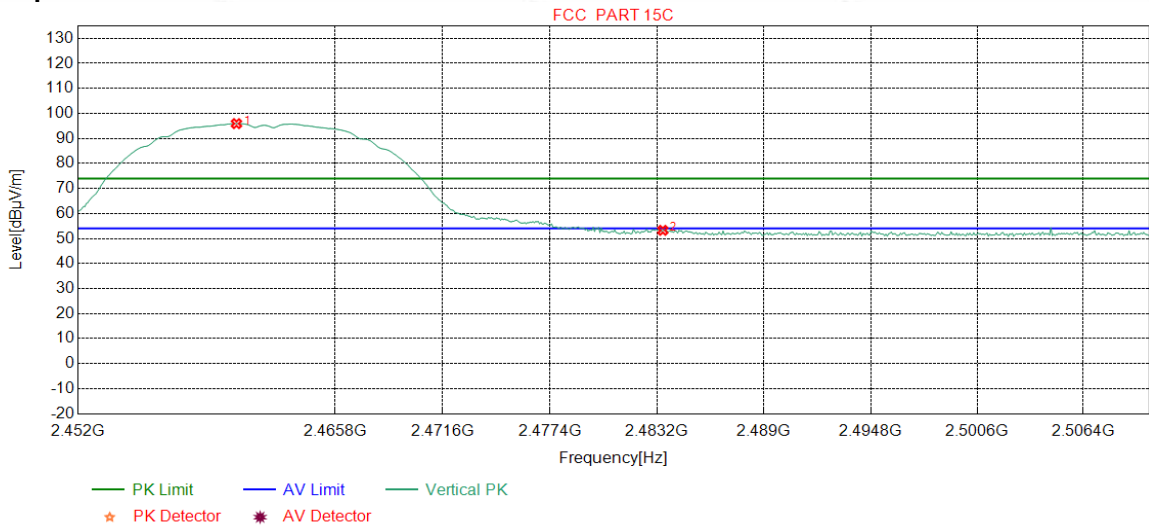

NO	Freq. [MHz]	Ant Factor [dB]	Cable loss [dB]	Pream gain [dB]	Reading [dBµV]	Level [dBµV/m]	Limit [dBµV/m]	Margin [dB]	Result	Polarity
1	2460.4931	32.34	13.48	-43.10	93.20	95.92	74.00	-21.92	Pass	Vertical
2	2483.5000	32.38	13.38	-43.11	50.62	53.27	74.00	20.73	Pass	Vertical

Mode:	802.11 b(1Mbps) Transmitting	Channel:	2462
Remark:	AV		

Test Graph

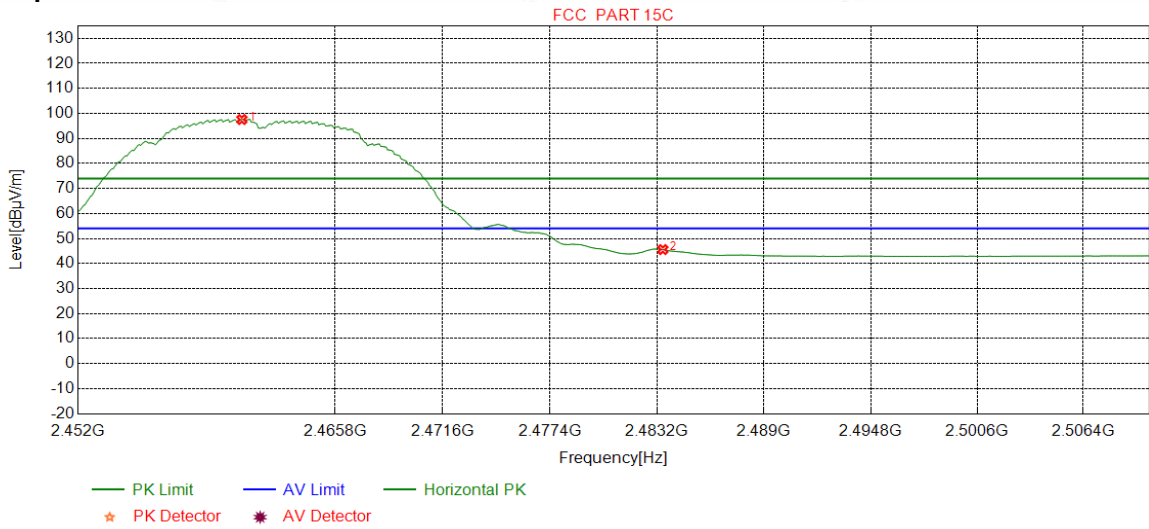

NO	Freq. [MHz]	Ant Factor [dB]	Cable loss [dB]	Pream gain [dB]	Reading [dBµV]	Level [dBµV/m]	Limit [dBµV/m]	Margin [dB]	Result	Polarity
1	2460.7835	32.35	13.48	-43.11	94.84	97.56	54.00	-43.56	Pass	Horizontal
2	2483.5000	32.38	13.38	-43.11	42.93	45.58	54.00	8.42	Pass	Horizontal

Mode:	802.11 b(1Mbps) Transmitting	Channel:	2462
Remark:	AV		

Test Graph

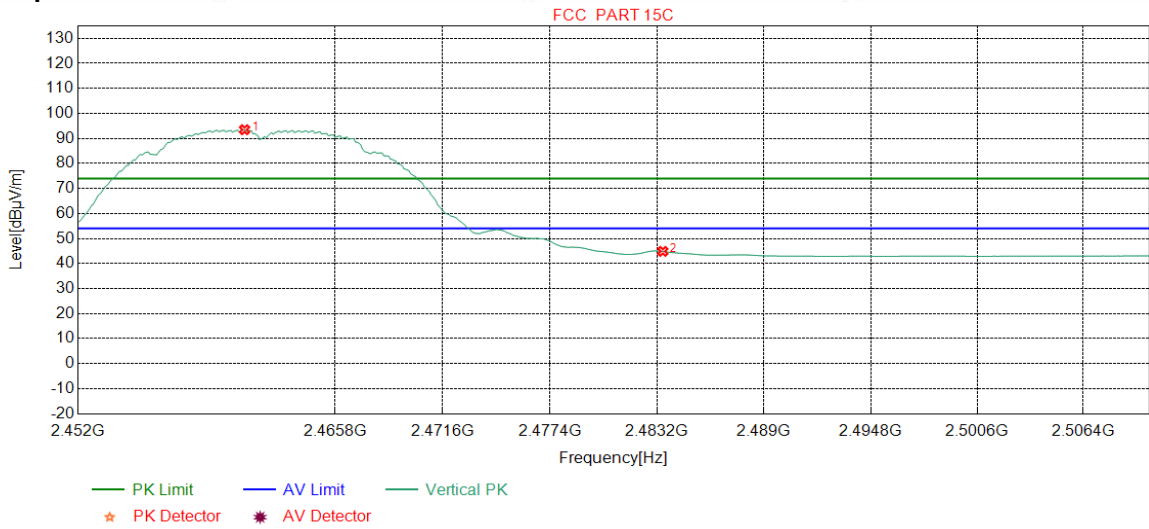

NO	Freq. [MHz]	Ant Factor [dB]	Cable loss [dB]	Pream gain [dB]	Reading [dBµV]	Level [dBµV/m]	Limit [dBµV/m]	Margin [dB]	Result	Polarity
1	2460.9287	32.35	13.48	-43.11	90.78	93.50	54.00	-39.50	Pass	Vertical
2	2483.5000	32.38	13.38	-43.11	42.21	44.86	54.00	9.14	Pass	Vertical

Mode:	802.11 g(6Mbps) Transmitting	Channel:	2412
Remark:	PK		

Test Graph

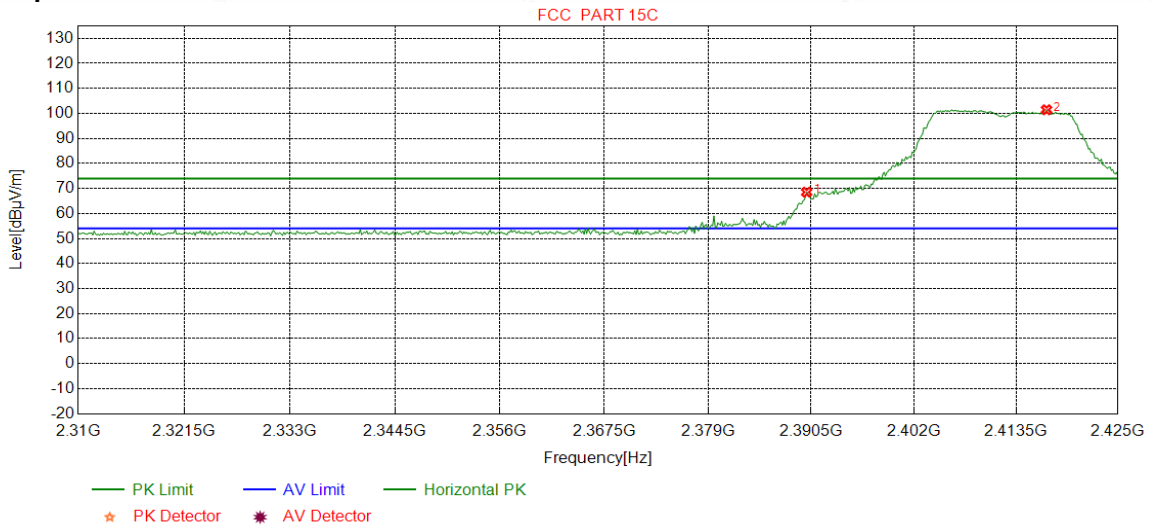

NO	Freq. [MHz]	Ant Factor [dB]	Cable loss [dB]	Pream gain [dB]	Reading [dBµV]	Level [dBµV/m]	Limit [dBµV/m]	Margin [dB]	Result	Polarity
1	2390.0000	32.25	13.37	-43.12	66.03	68.53	74.00	5.47	Pass	Horizontal
2	2416.9399	32.28	13.38	-43.11	98.90	101.45	74.00	-27.45	Pass	Horizontal

Mode:	802.11 g(6Mbps) Transmitting	Channel:	2412
Remark:	PK		

Test Graph

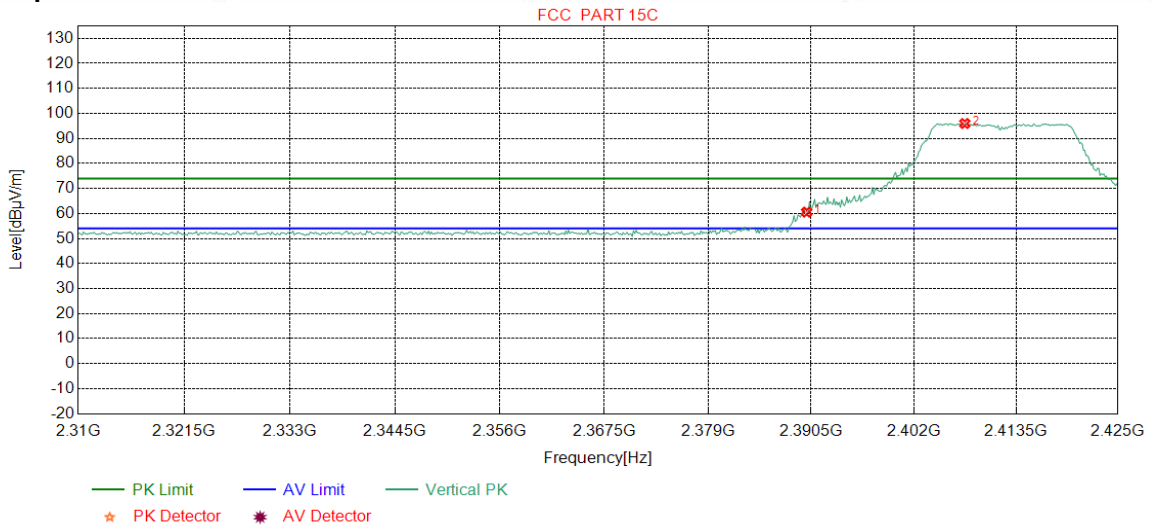

NO	Freq. [MHz]	Ant Factor [dB]	Cable loss [dB]	Pream gain [dB]	Reading [dBµV]	Level [dBµV/m]	Limit [dBµV/m]	Margin [dB]	Result	Polarity
1	2390.0000	32.25	13.37	-43.12	58.05	60.55	74.00	13.45	Pass	Vertical
2	2407.7284	32.27	13.34	-43.12	93.48	95.97	74.00	-21.97	Pass	Vertical

Mode:	802.11 g(6Mbps) Transmitting	Channel:	2412
Remark:	AV		

Test Graph

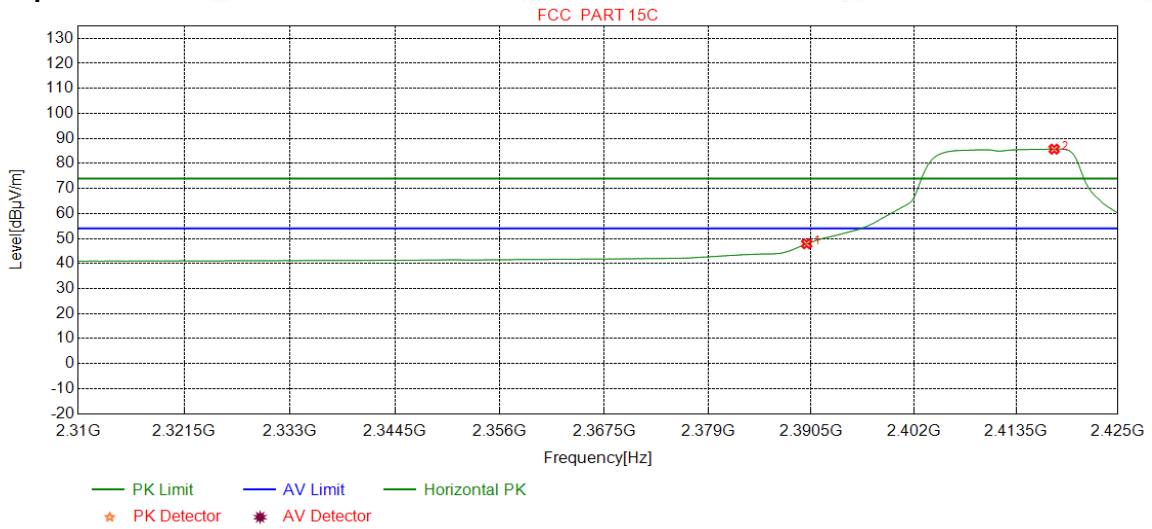

NO	Freq. [MHz]	Ant Factor [dB]	Cable loss [dB]	Pream gain [dB]	Reading [dBµV]	Level [dBµV/m]	Limit [dBµV/m]	Margin [dB]	Result	Polarity
1	2390.0000	32.25	13.37	-43.12	45.40	47.90	54.00	6.10	Pass	Horizontal
2	2417.8035	32.28	13.38	-43.11	83.17	85.72	54.00	-31.72	Pass	Horizontal

Mode:	802.11 g(6Mbps) Transmitting	Channel:	2412
Remark:	AV		

Test Graph

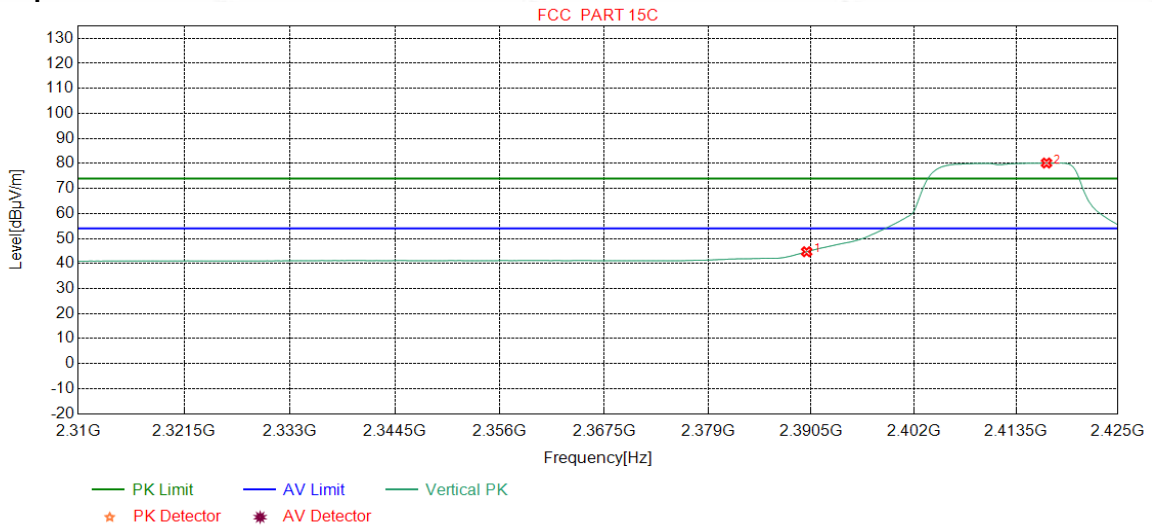

NO	Freq. [MHz]	Ant Factor [dB]	Cable loss [dB]	Pream gain [dB]	Reading [dBµV]	Level [dBµV/m]	Limit [dBµV/m]	Margin [dB]	Result	Polarity
1	2390.0000	32.25	13.37	-43.12	42.22	44.72	54.00	9.28	Pass	Vertical
2	2416.9399	32.28	13.38	-43.11	77.62	80.17	54.00	-26.17	Pass	Vertical

Mode:	802.11 g(6Mbps) Transmitting	Channel:	2462
Remark:	PK		

Test Graph

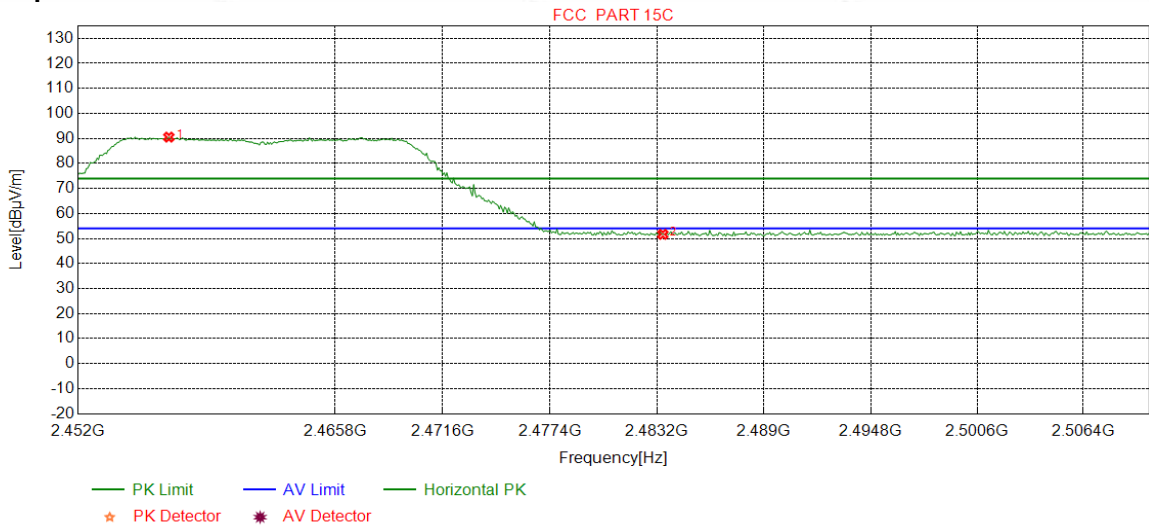

NO	Freq. [MHz]	Ant Factor [dB]	Cable loss [dB]	Pream gain [dB]	Reading [dBµV]	Level [dBµV/m]	Limit [dBµV/m]	Margin [dB]	Result	Polarity
1	2456.8636	32.34	13.50	-43.11	87.79	90.52	74.00	-16.52	Pass	Horizontal
2	2483.5000	32.38	13.38	-43.11	49.01	51.66	74.00	22.34	Pass	Horizontal

Mode:	802.11 g(6Mbps) Transmitting	Channel:	2462
Remark:	PK		

Test Graph

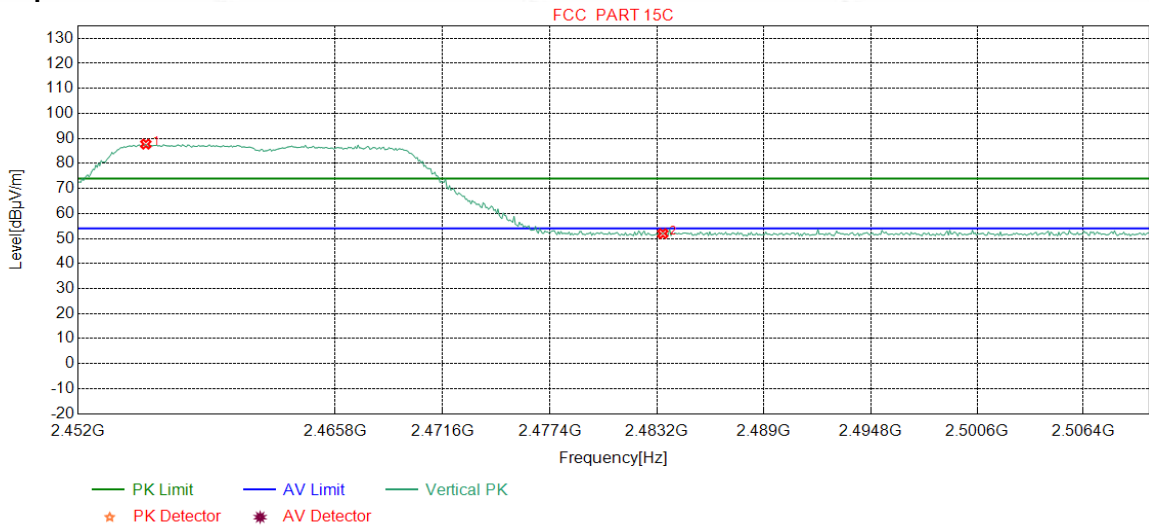

NO	Freq. [MHz]	Ant Factor [dB]	Cable loss [dB]	Pream gain [dB]	Reading [dBµV]	Level [dBµV/m]	Limit [dBµV/m]	Margin [dB]	Result	Polarity
1	2455.6295	32.34	13.50	-43.11	85.00	87.73	74.00	-13.73	Pass	Vertical
2	2483.5000	32.38	13.38	-43.11	49.29	51.94	74.00	22.06	Pass	Vertical

Mode:	802.11 g(6Mbps) Transmitting	Channel:	2462
Remark:	AV		

Test Graph

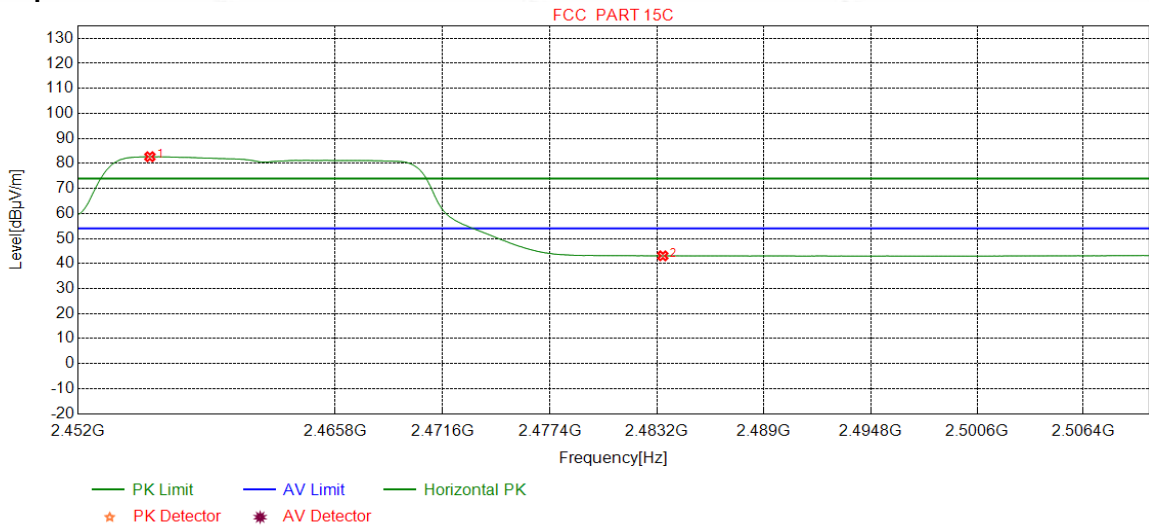

NO	Freq. [MHz]	Ant Factor [dB]	Cable loss [dB]	Pream gain [dB]	Reading [dBµV]	Level [dBµV/m]	Limit [dBµV/m]	Margin [dB]	Result	Polarity
1	2455.8473	32.34	13.50	-43.11	79.96	82.69	54.00	-28.69	Pass	Horizontal
2	2483.5000	32.38	13.38	-43.11	40.42	43.07	54.00	10.93	Pass	Horizontal

Mode:	802.11 g(6Mbps) Transmitting	Channel:	2462
Remark:	AV		

Test Graph

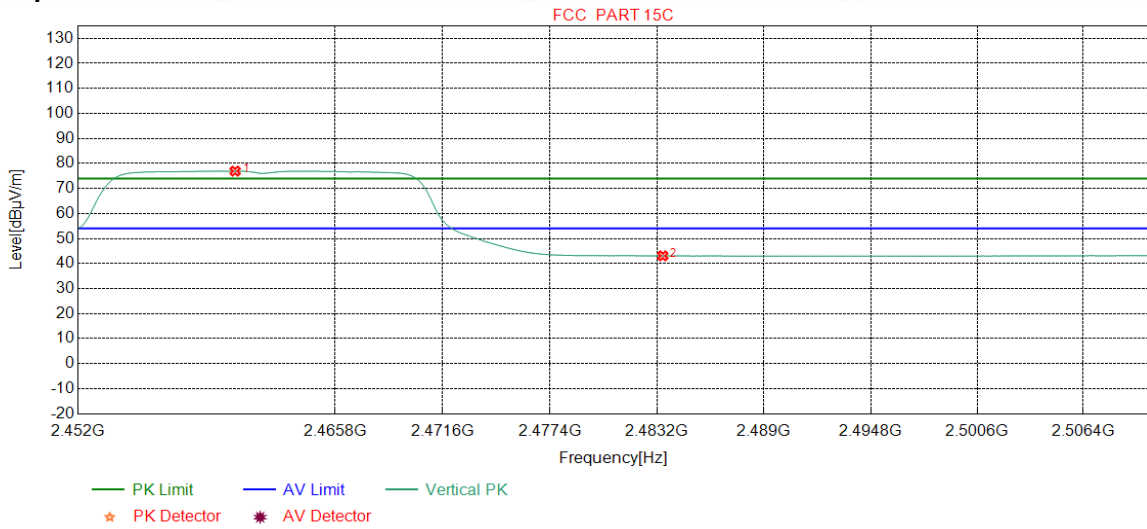

NO	Freq. [MHz]	Ant Factor [dB]	Cable loss [dB]	Pream gain [dB]	Reading [dBµV]	Level [dBµV/m]	Limit [dBµV/m]	Margin [dB]	Result	Polarity
1	2460.4205	32.34	13.48	-43.10	74.21	76.93	54.00	-22.93	Pass	Vertical
2	2483.5000	32.38	13.38	-43.11	40.42	43.07	54.00	10.93	Pass	Vertical

Mode:	802.11 n(HT20) (6.5Mbps) Transmitting	Channel:	2412
Remark:	PK		

Test Graph

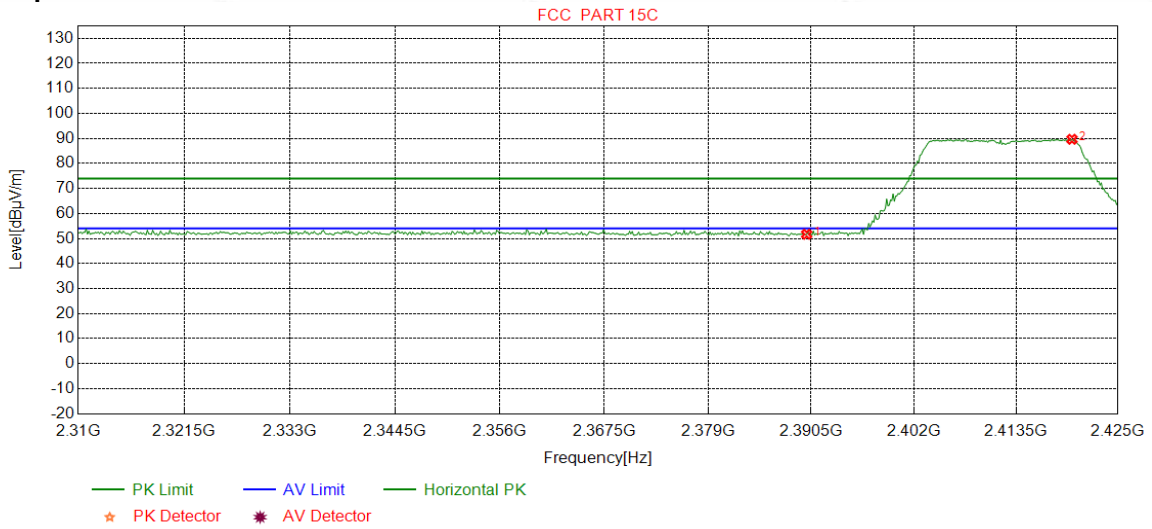

NO	Freq. [MHz]	Ant Factor [dB]	Cable loss [dB]	Pream gain [dB]	Reading [dBµV]	Level [dBµV/m]	Limit [dBµV/m]	Margin [dB]	Result	Polarity
1	2390.0000	32.25	13.37	-43.12	49.19	51.69	74.00	22.31	Pass	Horizontal
2	2419.8185	32.29	13.39	-43.12	87.10	89.66	74.00	-15.66	Pass	Horizontal

Mode:	802.11 n(HT20) (6.5Mbps) Transmitting	Channel:	2412
Remark:	PK		

Test Graph

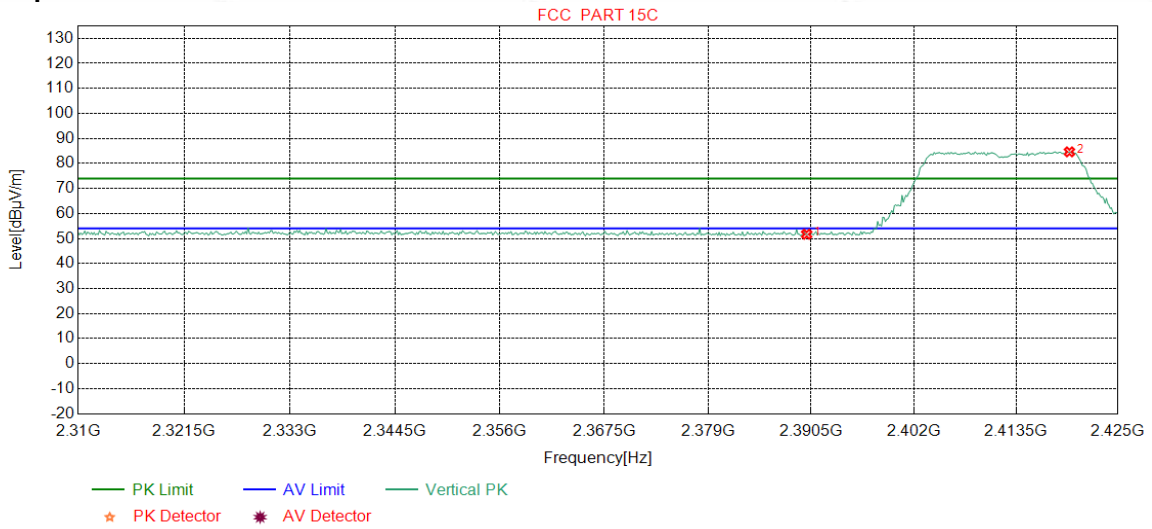

NO	Freq. [MHz]	Ant Factor [dB]	Cable loss [dB]	Pream gain [dB]	Reading [dBµV]	Level [dBµV/m]	Limit [dBµV/m]	Margin [dB]	Result	Polarity
1	2390.0000	32.25	13.37	-43.12	49.20	51.70	74.00	22.30	Pass	Vertical
2	2419.5307	32.29	13.39	-43.12	82.07	84.63	74.00	-10.63	Pass	Vertical

Mode:	802.11 n(HT20) (6.5Mbps) Transmitting	Channel:	2412
Remark:	AV		

Test Graph

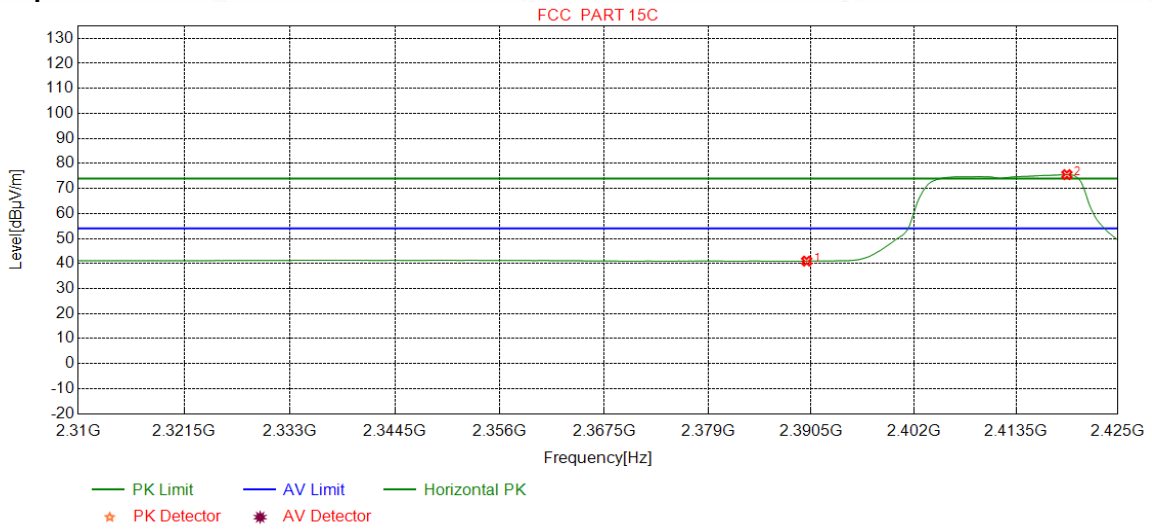

NO	Freq. [MHz]	Ant Factor [dB]	Cable loss [dB]	Pream gain [dB]	Reading [dBµV]	Level [dBµV/m]	Limit [dBµV/m]	Margin [dB]	Result	Polarity
1	2390.0000	32.25	13.37	-43.12	38.47	40.97	54.00	13.03	Pass	Horizontal
2	2419.2428	32.29	13.39	-43.12	72.97	75.53	54.00	-21.53	Pass	Horizontal

Mode:	802.11 n(HT20) (6.5Mbps) Transmitting	Channel:	2412
Remark:	AV		

Test Graph

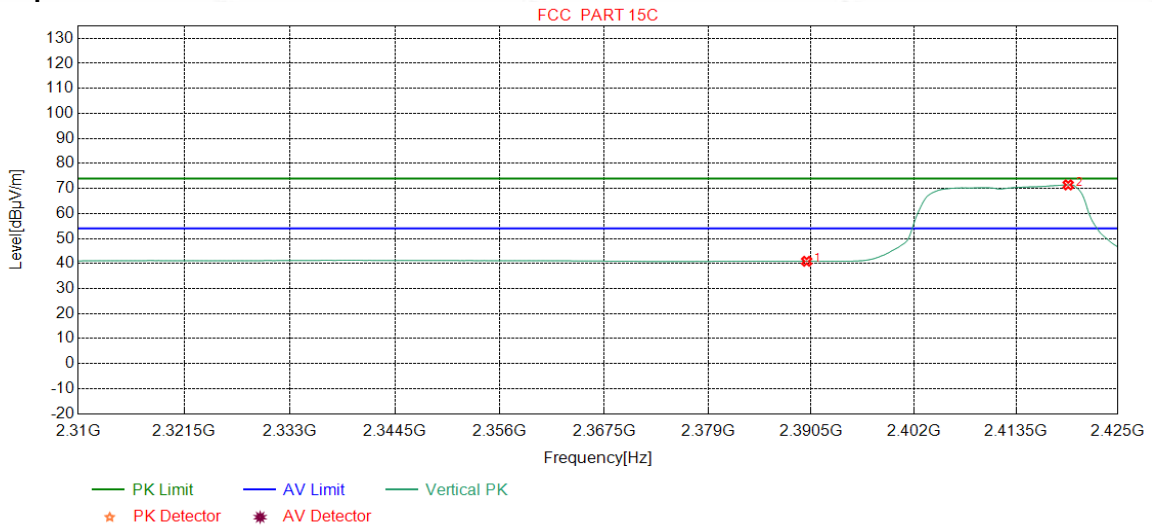

NO	Freq. [MHz]	Ant Factor [dB]	Cable loss [dB]	Pream gain [dB]	Reading [dBµV]	Level [dBµV/m]	Limit [dBµV/m]	Margin [dB]	Result	Polarity
1	2390.0000	32.25	13.37	-43.12	38.40	40.90	54.00	13.10	Pass	Vertical
2	2419.3867	32.29	13.39	-43.12	68.87	71.43	54.00	-17.43	Pass	Vertical

Mode:	802.11 n(HT20) (6.5Mbps) Transmitting	Channel:	2462
Remark:	PK		

Test Graph

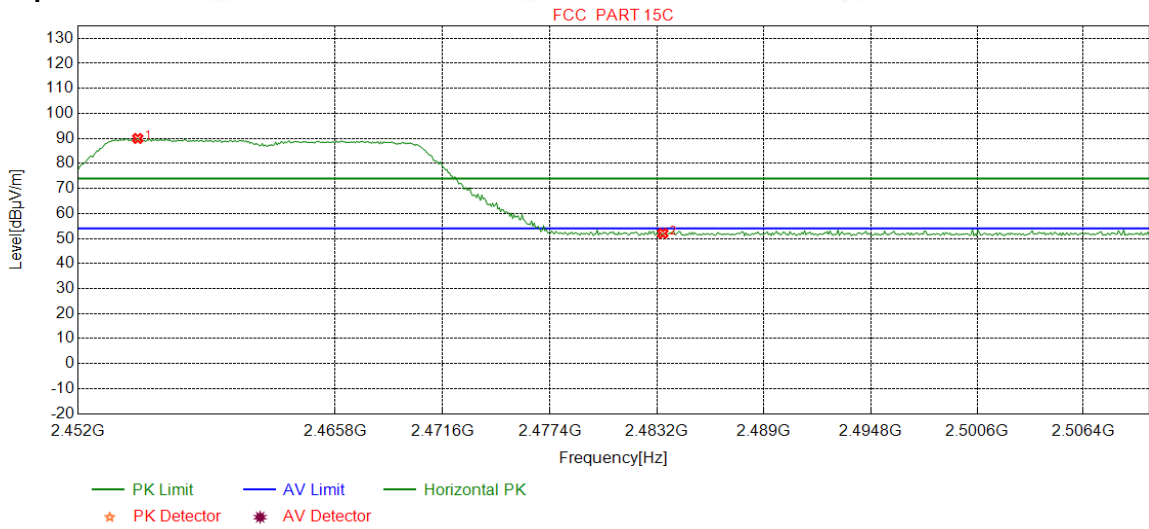

NO	Freq. [MHz]	Ant Factor [dB]	Cable loss [dB]	Pream gain [dB]	Reading [dBµV]	Level [dBµV/m]	Limit [dBµV/m]	Margin [dB]	Result	Polarity
1	2455.1940	32.34	13.51	-43.12	87.26	89.99	74.00	-15.99	Pass	Horizontal
2	2483.5000	32.38	13.38	-43.11	49.40	52.05	74.00	21.95	Pass	Horizontal

Mode:	802.11 n(HT20) (6.5Mbps) Transmitting	Channel:	2462
Remark:	PK		

Test Graph

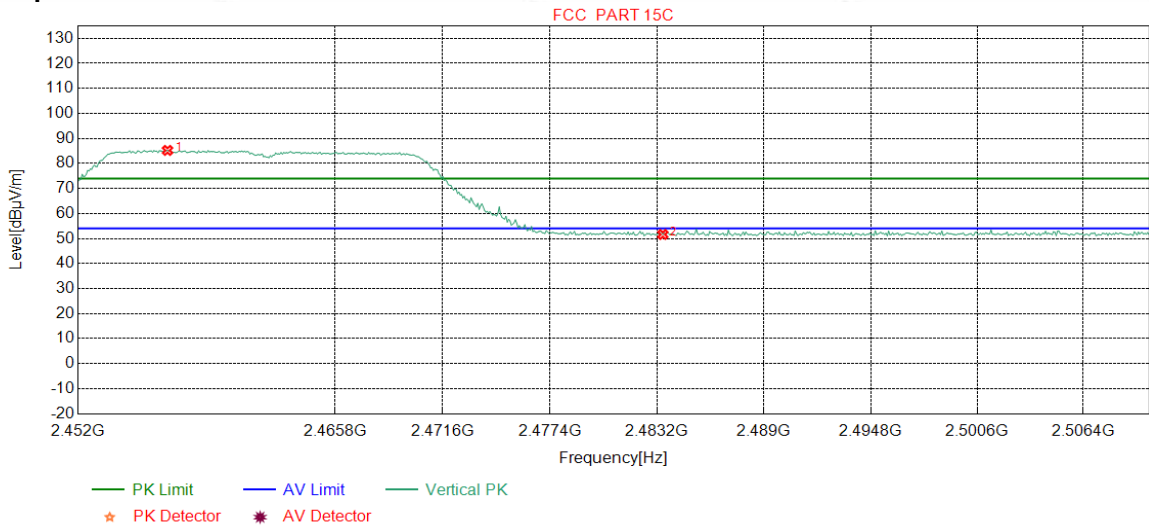

NO	Freq. [MHz]	Ant Factor [dB]	Cable loss [dB]	Pream gain [dB]	Reading [dBµV]	Level [dBµV/m]	Limit [dBµV/m]	Margin [dB]	Result	Polarity
1	2456.7910	32.34	13.50	-43.11	82.48	85.21	74.00	-11.21	Pass	Vertical
2	2483.5000	32.38	13.38	-43.11	48.95	51.60	74.00	22.40	Pass	Vertical

Mode:	802.11 n(HT20) (6.5Mbps) Transmitting	Channel:	2462
Remark:	AV		

Test Graph

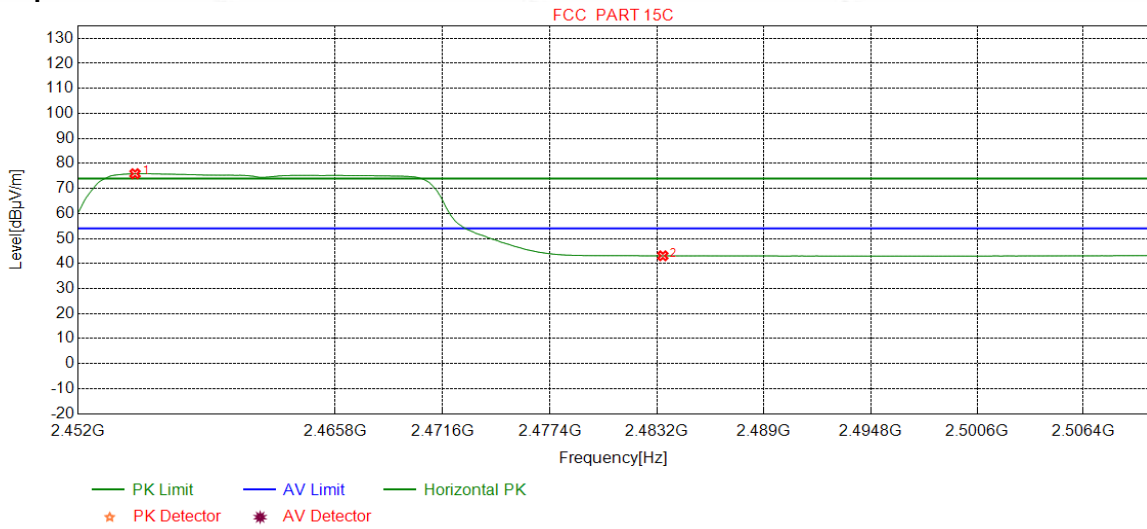

NO	Freq. [MHz]	Ant Factor [dB]	Cable loss [dB]	Pream gain [dB]	Reading [dBµV]	Level [dBµV/m]	Limit [dBµV/m]	Margin [dB]	Result	Polarity
1	2455.0488	32.34	13.51	-43.12	73.17	75.90	54.00	-21.90	Pass	Horizontal
2	2483.5000	32.38	13.38	-43.11	40.44	43.09	54.00	10.91	Pass	Horizontal

Mode:	802.11 n(HT20) (6.5Mbps) Transmitting	Channel:	2462
Remark:	AV		

Test Graph

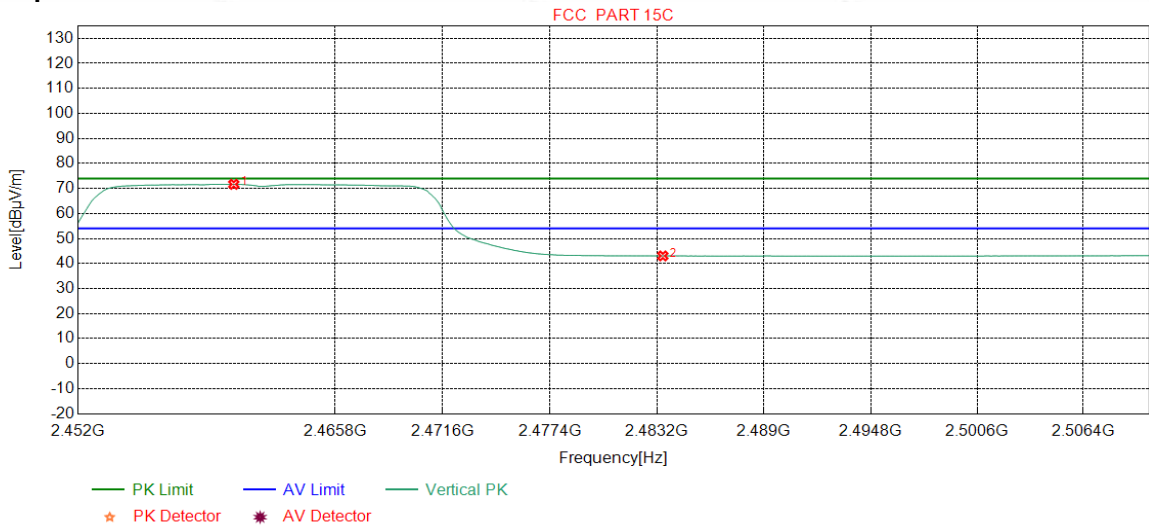

NO	Freq. [MHz]	Ant Factor [dB]	Cable loss [dB]	Pream gain [dB]	Reading [dBµV]	Level [dBµV/m]	Limit [dBµV/m]	Margin [dB]	Result	Polarity
1	2460.3479	32.34	13.48	-43.10	68.94	71.66	54.00	-17.66	Pass	Vertical
2	2483.5000	32.38	13.38	-43.11	40.39	43.04	54.00	10.96	Pass	Vertical

Mode:	802.11 n(HT40) (13.5Mbps) Transmitting	Channel:	2422
Remark:	PK		

Test Graph

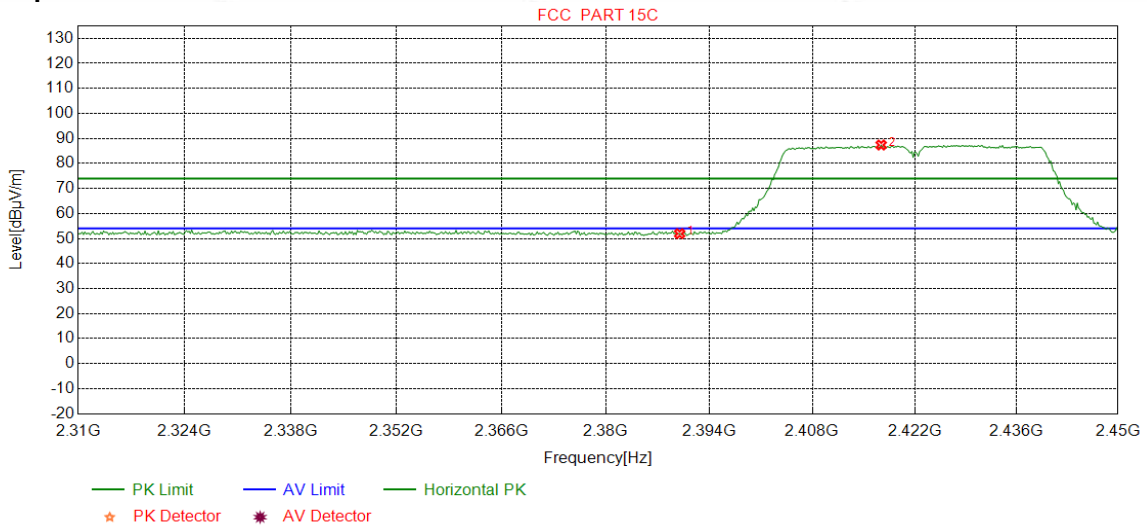

NO	Freq. [MHz]	Ant Factor [dB]	Cable loss [dB]	Pream gain [dB]	Reading [dBµV]	Level [dBµV/m]	Limit [dBµV/m]	Margin [dB]	Result	Polarity
1	2390.0000	32.25	13.37	-43.12	49.45	51.95	74.00	22.05	Pass	Horizontal
2	2417.4093	32.28	13.38	-43.11	84.82	87.37	74.00	-13.37	Pass	Horizontal

Mode:	802.11 n(HT40) (13.5Mbps) Transmitting	Channel:	2422
Remark:	PK		

Test Graph

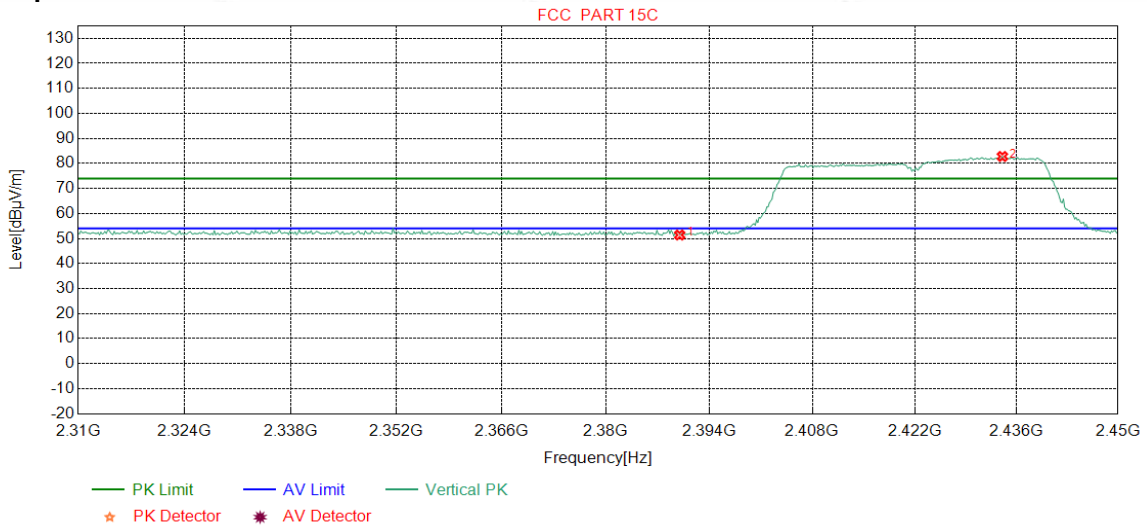

NO	Freq. [MHz]	Ant Factor [dB]	Cable loss [dB]	Pream gain [dB]	Reading [dBµV]	Level [dBµV/m]	Limit [dBµV/m]	Margin [dB]	Result	Polarity
1	2390.0000	32.25	13.37	-43.12	48.90	51.40	74.00	22.60	Pass	Vertical
2	2434.0551	32.31	13.46	-43.12	80.13	82.78	74.00	-8.78	Pass	Vertical

Mode:	802.11 n(HT40) (13.5Mbps) Transmitting	Channel:	2422
Remark:	AV		

Test Graph

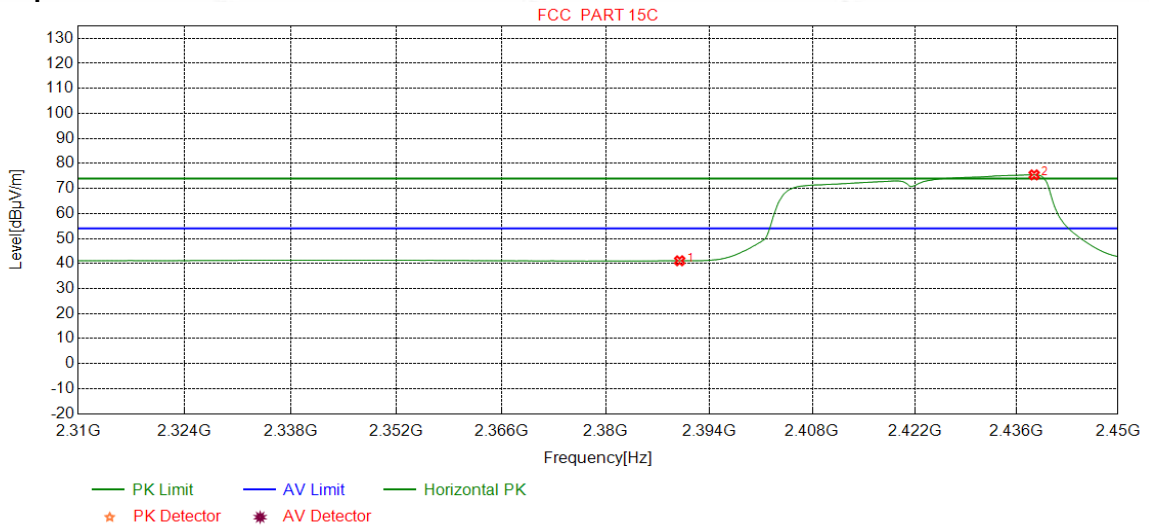

NO	Freq. [MHz]	Ant Factor [dB]	Cable loss [dB]	Pream gain [dB]	Reading [dBµV]	Level [dBµV/m]	Limit [dBµV/m]	Margin [dB]	Result	Polarity
1	2390.0000	32.25	13.37	-43.12	38.60	41.10	54.00	12.90	Pass	Horizontal
2	2438.4355	32.31	13.48	-43.11	72.75	75.43	54.00	-21.43	Pass	Horizontal

Mode:	802.11 n(HT40) (13.5Mbps) Transmitting	Channel:	2422
Remark:	AV		

Test Graph

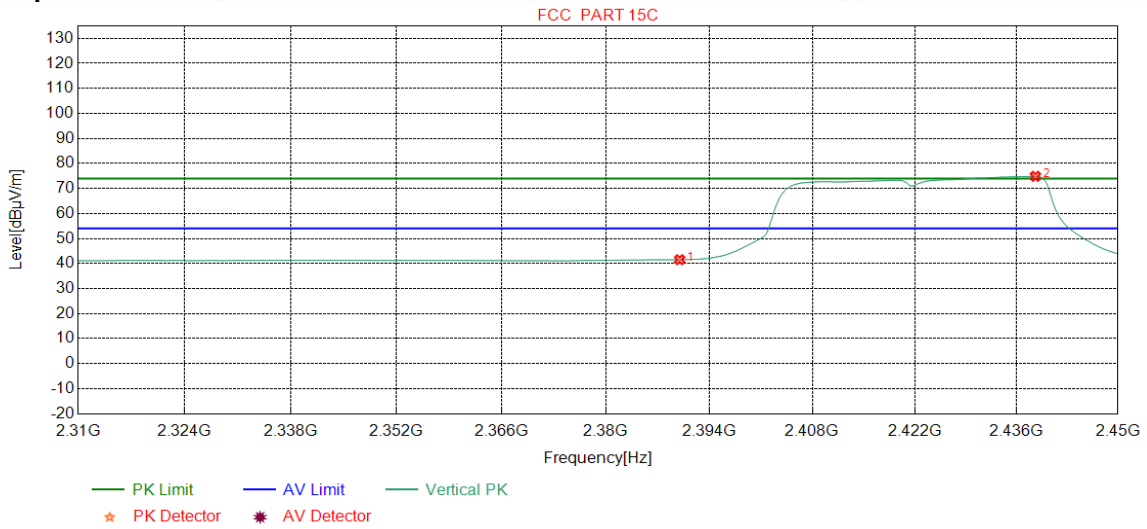

NO	Freq. [MHz]	Ant Factor [dB]	Cable loss [dB]	Pream gain [dB]	Reading [dBµV]	Level [dBµV/m]	Limit [dBµV/m]	Margin [dB]	Result	Polarity
1	2390.0000	32.25	13.37	-43.12	39.04	41.54	54.00	12.46	Pass	Vertical
2	2438.6108	32.31	13.48	-43.11	72.18	74.86	54.00	-20.86	Pass	Vertical

Mode:	802.11 n(HT40) (13.5Mbps) Transmitting	Channel:	2452
Remark:	PK		

Test Graph

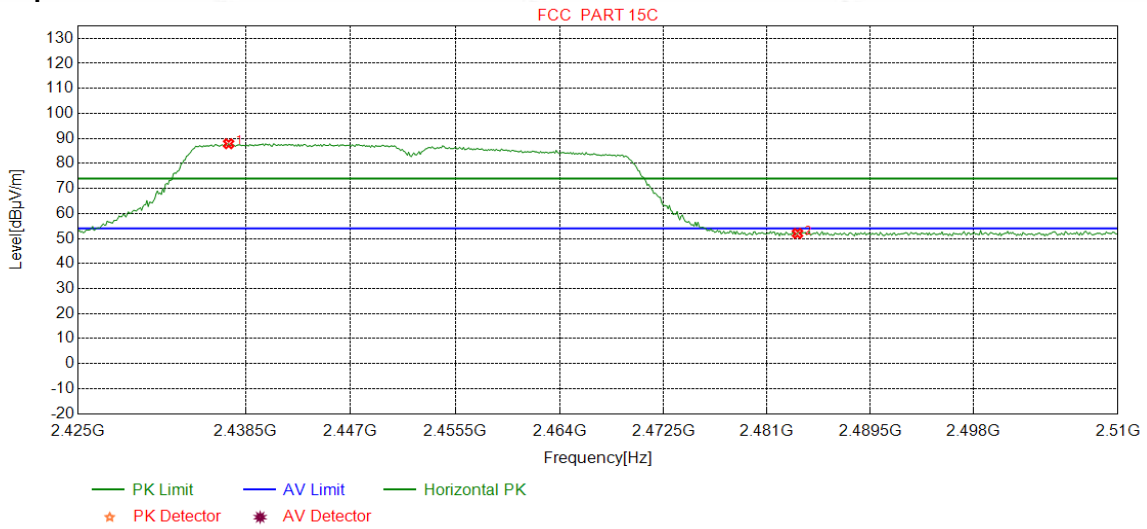

NO	Freq. [MHz]	Ant Factor [dB]	Cable loss [dB]	Pream gain [dB]	Reading [dBµV]	Level [dBµV/m]	Limit [dBµV/m]	Margin [dB]	Result	Polarity
1	2437.1277	32.31	13.47	-43.11	85.20	87.87	74.00	-13.87	Pass	Horizontal
2	2483.5000	32.38	13.38	-43.11	49.38	52.03	74.00	21.97	Pass	Horizontal

Mode:	802.11 n(HT40) (13.5Mbps) Transmitting	Channel:	2452
Remark:	PK		

Test Graph

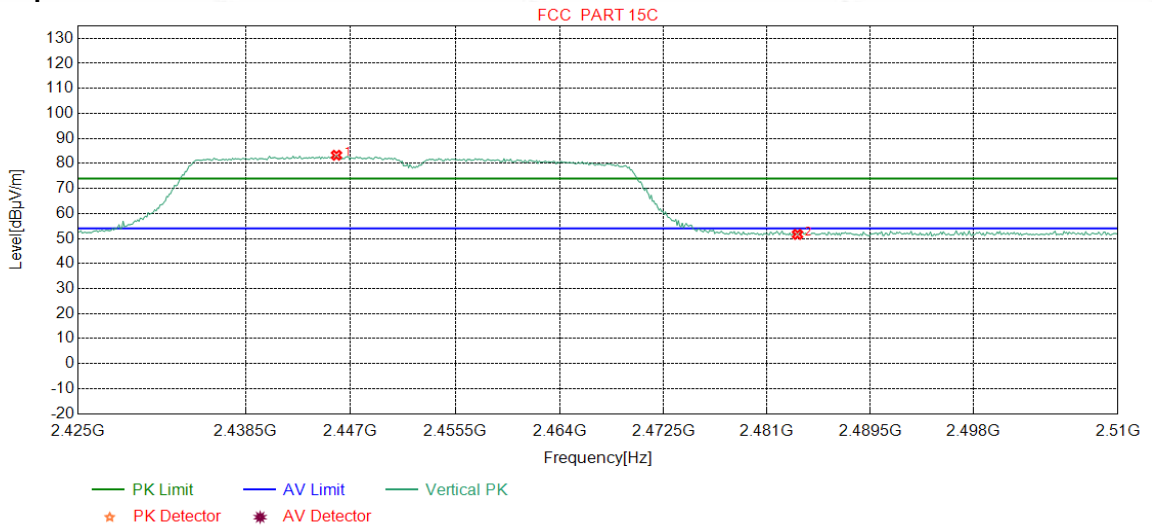

NO	Freq. [MHz]	Ant Factor [dB]	Cable loss [dB]	Pream gain [dB]	Reading [dBµV]	Level [dBµV/m]	Limit [dBµV/m]	Margin [dB]	Result	Polarity
1	2445.8511	32.32	13.51	-43.11	80.56	83.28	74.00	-9.28	Pass	Vertical
2	2483.5000	32.38	13.38	-43.11	48.99	51.64	74.00	22.36	Pass	Vertical

Mode:	802.11 n(HT40) (13.5Mbps) Transmitting	Channel:	2452
Remark:	AV		

Test Graph

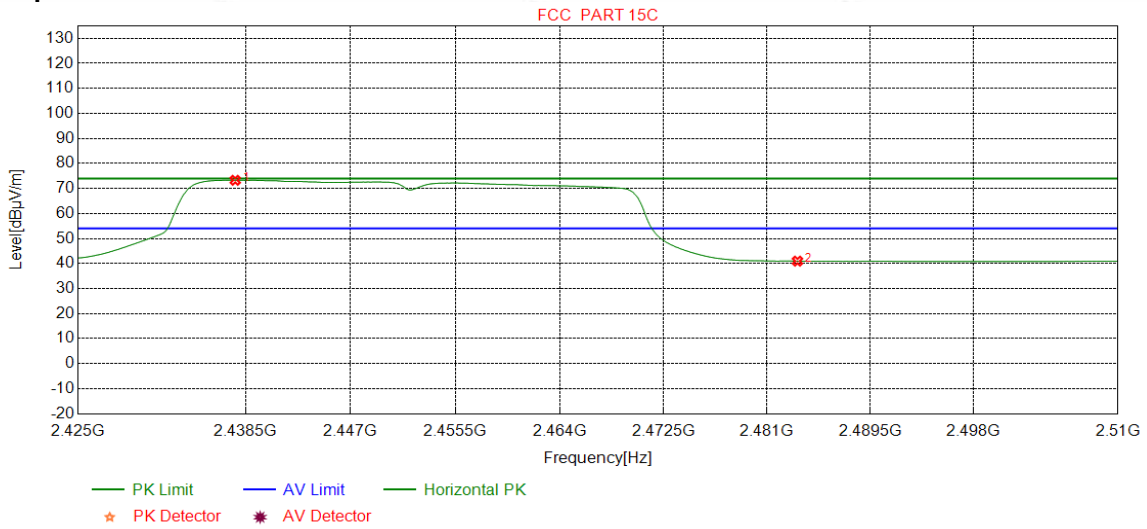

NO	Freq. [MHz]	Ant Factor [dB]	Cable loss [dB]	Pream gain [dB]	Reading [dBµV]	Level [dBµV/m]	Limit [dBµV/m]	Margin [dB]	Result	Polarity
1	2437.6596	32.31	13.47	-43.11	70.60	73.27	54.00	-19.27	Pass	Horizontal
2	2483.5000	32.38	13.38	-43.11	38.31	40.96	54.00	13.04	Pass	Horizontal

Mode:	802.11 n(HT40) (13.5Mbps) Transmitting	Channel:	2452
Remark:	AV		

Test Graph

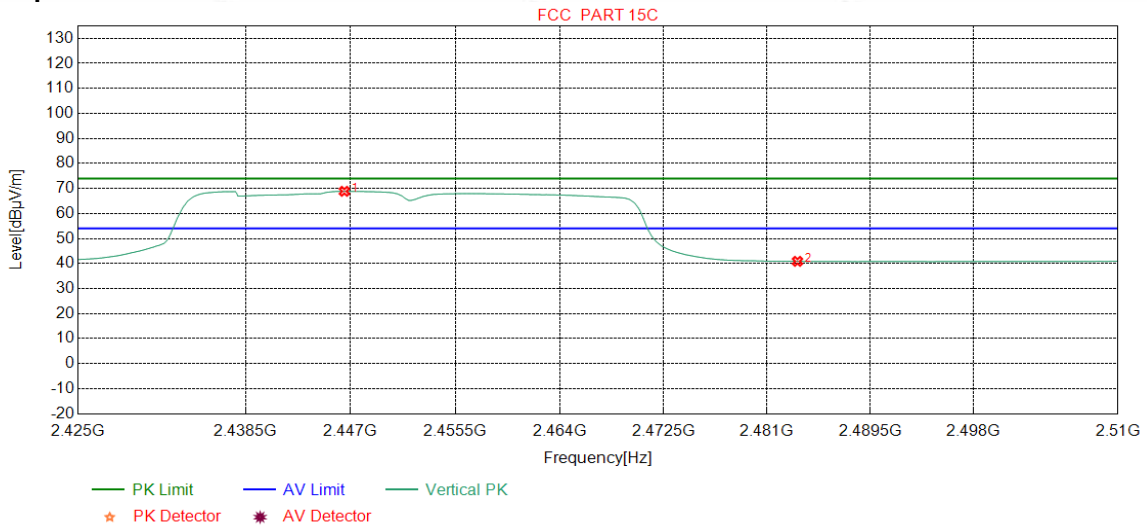

NO	Freq. [MHz]	Ant Factor [dB]	Cable loss [dB]	Pream gain [dB]	Reading [dBµV]	Level [dBµV/m]	Limit [dBµV/m]	Margin [dB]	Result	Polarity
1	2446.4894	32.33	13.51	-43.11	66.14	68.87	54.00	-14.87	Pass	Vertical
2	2483.5000	32.38	13.38	-43.11	38.23	40.88	54.00	13.12	Pass	Vertical

Note:

1) Through Pre-scan transmitting mode and charge+transmitter mode with all kind of modulation and data rate, find the 1Mbps of rate is the worst case of 802.11b; 6Mbps of rate is the worst case of 802.11g; 6.5Mbps of rate is the worst case of 802.11n(HT20) ; 13.5Mbps of rate is the worst case of 802.11n(HT40),and then Only the worst case is recorded in the report.

2) The field strength is calculated by adding the Antenna Factor, Cable Factor & Pre-amplifier. The basic equation with a sample calculation is as follows:

Final Test Level =Receiver Reading - Correct Factor

Correct Factor = Pre-amplifier Factor– Antenna Factor–Cable Factor

Appendix I): Radiated Spurious Emissions

Receiver Setup:	Frequency	Detector	RBW	VBW	Remark
	0.009MHz-0.090MHz	Peak	10kHz	30kHz	Peak
	0.009MHz-0.090MHz	Average	10kHz	30kHz	Average
	0.090MHz-0.110MHz	Quasi-peak	10kHz	30kHz	Quasi-peak
	0.110MHz-0.490MHz	Peak	10kHz	30kHz	Peak
	0.110MHz-0.490MHz	Average	10kHz	30kHz	Average
	0.490MHz -30MHz	Quasi-peak	10kHz	30kHz	Quasi-peak
	30MHz-1GHz	Quasi-peak	120kHz	300kHz	Quasi-peak
	Above 1GHz	Peak	1MHz	3MHz	Peak
Peak		1MHz	10Hz	Average	
Test Procedure:					
Below 1GHz test procedure as below:					
<p>a. The EUT was placed on the top of a rotating table 0.8 meters above the ground at a 3 meter semi-anechoic chamber. The table was rotated 360 degrees to determine the position of the highest radiation.</p> <p>b. The EUT was set 3 meters away from the interference-receiving antenna, which was mounted on the top of a variable-height antenna tower.</p> <p>c. The antenna height is varied from one meter to four meters above the ground to determine the maximum value of the field strength. Both horizontal and vertical polarizations of the antenna are set to make the measurement.</p> <p>d. For each suspected emission, the EUT was arranged to its worst case and then the antenna was tuned to heights from 1 meter to 4 meters (for the test frequency of below 30MHz, the antenna was tuned to heights 1 meter) and the rotatable was turned from 0 degrees to 360 degrees to find the maximum reading.</p> <p>e. The test-receiver system was set to Peak Detect Function and Specified Bandwidth with Maximum Hold Mode.</p> <p>f. If the emission level of the EUT in peak mode was 10dB lower than the limit specified, then testing could be stopped and the peak values of the EUT would be reported. Otherwise the emissions that did not have 10dB margin would be re-tested one by one using peak, quasi-peak or average method as specified and then reported in a data sheet.</p>					
Above 1GHz test procedure as below:					
<p>g. Different between above is the test site, change from Semi- Anechoic Chamber to fully Anechoic Chamber and change form table 0.8 meter to 1.5 meter(Above 18GHz the distance is 1 meter and table is 1.5 meter).</p> <p>h. Test the EUT in the lowest channel, the middle channel ,the Highest channel .</p> <p>i. The radiation measurements are performed in X, Y, Z axis positioning for Transmitting mode, and found the X axis positioning which it is worse case.</p> <p>j. Repeat above procedures until all frequencies measured was complete.</p>					
Limit:	Frequency	Field strength (microvolt/meter)	Limit (dB μ V/m)	Remark	Measurement distance (m)
	0.009MHz-0.490MHz	2400/F(kHz)	-	-	300
	0.490MHz-1.705MHz	24000/F(kHz)	-	-	30
	1.705MHz-30MHz	30	-	-	30
	30MHz-88MHz	100	40.0	Quasi-peak	3
	88MHz-216MHz	150	43.5	Quasi-peak	3
	216MHz-960MHz	200	46.0	Quasi-peak	3
	960MHz-1GHz	500	54.0	Quasi-peak	3
	Above 1GHz	500	54.0	Average	3
<p>Note: 15.35(b), Unless otherwise specified, the limit on peak radio frequency emissions is 20dB above the maximum permitted average emission limit applicable to the equipment under test. This peak limit applies to the total peak emission level radiated by the device.</p>					

Radiated Spurious Emissions test Data:

Radiated Emission below 1GHz

During the test, the Radiates Emission from 30MHz to 1GHz was performed in all modes with all channels, 11b Channel 2437MHz was selected as the worst condition. The test data of the worst-case condition was recorded in this report.

Mode:		802.11 b(1Mbps) Transmitting				Channel:		2437		
NO	Freq. [MHz]	Ant Factor [dB]	Cable loss [dB]	Pream gain [dB]	Reading [dB μ V]	Level [dB μ V/m]	Limit [dB μ V/m]	Margin [dB]	Result	Polarity
1	46.2006	13.20	0.76	-31.81	38.63	20.78	40.00	19.22	Pass	H
2	83.5494	7.92	1.05	-31.97	43.87	20.87	40.00	19.13	Pass	H
3	150.0010	7.55	1.45	-32.01	44.70	21.69	43.50	21.81	Pass	H
4	249.8240	12.20	1.88	-31.91	53.49	35.66	46.00	10.34	Pass	H
5	600.0290	19.00	2.96	-31.50	42.99	33.45	46.00	12.55	Pass	H
6	909.9750	22.16	3.60	-31.48	38.14	32.42	46.00	13.58	Pass	H
7	45.9096	13.20	0.76	-31.79	37.90	20.07	40.00	19.93	Pass	V
8	84.5195	8.14	1.06	-31.99	45.66	22.87	40.00	17.13	Pass	V
9	250.0180	12.20	1.88	-31.90	46.89	29.07	46.00	16.93	Pass	V
10	411.4421	15.58	2.42	-31.83	38.26	24.43	46.00	21.57	Pass	V
11	600.0290	19.00	2.96	-31.50	44.06	34.52	46.00	11.48	Pass	V
12	909.9750	22.16	3.60	-31.48	39.22	33.50	46.00	12.50	Pass	V

Transmitter Emission above 1GHz

Mode:		802.11 b (1Mbps) Transmitting				Channel:		2412			
NO	Freq. [MHz]	Ant Factor [dB]	Cable loss [dB]	Pream gain [dB]	Reading [dBμV]	Level [dBμV/m]	Limit [dBμV/m]	Margin [dB]	Result	Polarity	Remark
1	1170.4170	28.07	2.68	-42.92	55.30	43.13	74.00	30.87	Pass	H	Peak
2	2068.1068	31.80	3.57	-43.19	50.10	42.28	74.00	31.72	Pass	H	Peak
3	3755.0503	33.60	4.35	-43.04	49.41	44.32	74.00	29.68	Pass	H	Peak
4	4824.0000	34.50	4.61	-42.80	48.29	44.60	74.00	29.40	Pass	H	Peak
5	7236.0000	36.34	5.79	-42.16	45.60	45.57	74.00	28.43	Pass	H	Peak
6	9648.0000	37.66	6.72	-42.10	47.35	49.63	74.00	24.37	Pass	H	Peak
7	1235.4235	28.14	2.67	-42.85	51.41	39.37	74.00	34.63	Pass	V	Peak
8	1815.8816	30.48	3.34	-42.75	50.28	41.35	74.00	32.65	Pass	V	Peak
9	3055.0037	33.22	4.82	-43.10	49.80	44.74	74.00	29.26	Pass	V	Peak
10	4824.0000	34.50	4.61	-42.80	48.66	44.97	74.00	29.03	Pass	V	Peak
11	7236.0000	36.34	5.79	-42.16	45.97	45.94	74.00	28.06	Pass	V	Peak
12	9648.0000	37.66	6.72	-42.10	47.27	49.55	74.00	24.45	Pass	V	Peak

Mode:		802.11 b (1Mbps) Transmitting				Channel:		2437			
NO	Freq. [MHz]	Ant Factor [dB]	Cable loss [dB]	Pream gain [dB]	Reading [dBμV]	Level [dBμV/m]	Limit [dBμV/m]	Margin [dB]	Result	Polarity	Remark
1	1170.2170	28.07	2.68	-42.92	55.63	43.46	74.00	30.54	Pass	H	Peak
2	3066.0044	33.23	4.79	-43.10	50.15	45.07	74.00	28.93	Pass	H	Peak
3	4217.0811	34.10	4.49	-42.91	48.83	44.51	74.00	29.49	Pass	H	Peak
4	4874.0000	34.50	4.78	-42.80	48.25	44.73	74.00	29.27	Pass	H	Peak
5	7311.0000	36.41	5.85	-42.14	45.58	45.70	74.00	28.30	Pass	H	Peak
6	9748.0000	37.70	6.77	-42.10	47.72	50.09	74.00	23.91	Pass	H	Peak
7	1160.2160	28.06	2.68	-42.93	52.13	39.94	74.00	34.06	Pass	V	Peak
8	1780.8781	30.25	3.29	-42.70	50.67	41.51	74.00	32.49	Pass	V	Peak
9	3055.0037	33.22	4.82	-43.10	50.13	45.07	74.00	28.93	Pass	V	Peak
10	4874.0000	34.50	4.78	-42.80	48.02	44.50	74.00	29.50	Pass	V	Peak
11	7311.0000	36.41	5.85	-42.14	46.95	47.07	74.00	26.93	Pass	V	Peak
12	9748.0000	37.70	6.77	-42.10	46.85	49.22	74.00	24.78	Pass	V	Peak

Mode:		802.11 b (1Mbps) Transmitting				Channel:		2462			
NO	Freq. [MHz]	Ant Factor [dB]	Cable loss [dB]	Pream gain [dB]	Reading [dBμV]	Level [dBμV/m]	Limit [dBμV/m]	Margin [dB]	Result	Polarity	Remark
1	1170.6171	28.07	2.68	-42.92	54.30	42.13	74.00	31.87	Pass	H	Peak
2	2018.7019	31.73	3.50	-43.20	51.65	43.68	74.00	30.32	Pass	H	Peak
3	2993.5994	33.19	4.53	-43.10	50.64	45.26	74.00	28.74	Pass	H	Peak
4	4924.0000	34.50	4.85	-42.80	48.11	44.66	74.00	29.34	Pass	H	Peak
5	7386.0000	36.49	5.85	-42.13	45.92	46.13	74.00	27.87	Pass	H	Peak
6	9848.0000	37.74	6.83	-42.10	45.20	47.67	74.00	26.33	Pass	H	Peak
7	1552.6553	28.75	3.03	-43.00	50.92	39.70	74.00	34.30	Pass	V	Peak
8	3036.0024	33.21	4.86	-43.10	49.58	44.55	74.00	29.45	Pass	V	Peak
9	3958.0639	33.77	4.34	-43.01	50.41	45.51	74.00	28.49	Pass	V	Peak
10	4924.0000	34.50	4.85	-42.80	48.64	45.19	74.00	28.81	Pass	V	Peak
11	7386.0000	36.49	5.85	-42.13	48.34	48.55	74.00	25.45	Pass	V	Peak
12	9848.0000	37.74	6.83	-42.10	46.38	48.85	74.00	25.15	Pass	V	Peak

Mode:		802.11 g (6Mbps) Transmitting				Channel:		2412			
NO	Freq. [MHz]	Ant Factor [dB]	Cable loss [dB]	Pream gain [dB]	Reading [dBμV]	Level [dBμV/m]	Limit [dBμV/m]	Margin [dB]	Result	Polarity	Remark
1	1169.8170	28.07	2.68	-42.92	54.89	42.72	74.00	31.28	Pass	H	Peak
2	1648.2648	29.38	3.14	-42.79	51.34	41.07	74.00	32.93	Pass	H	Peak
3	3363.0242	33.35	4.53	-43.10	49.74	44.52	74.00	29.48	Pass	H	Peak
4	4824.0000	34.50	4.61	-42.80	47.06	43.37	74.00	30.63	Pass	H	Peak
5	7236.0000	36.34	5.79	-42.16	45.14	45.11	74.00	28.89	Pass	H	Peak
6	9648.0000	37.66	6.72	-42.10	46.08	48.36	74.00	25.64	Pass	H	Peak
7	1363.8364	28.26	2.84	-42.71	51.26	39.65	74.00	34.35	Pass	V	Peak
8	1841.2841	30.65	3.37	-42.81	50.23	41.44	74.00	32.56	Pass	V	Peak
9	3070.0047	33.23	4.79	-43.11	50.11	45.02	74.00	28.98	Pass	V	Peak
10	4824.0000	34.50	4.61	-42.80	47.29	43.60	74.00	30.40	Pass	V	Peak
11	7236.0000	36.34	5.79	-42.16	47.05	47.02	74.00	26.98	Pass	V	Peak
12	9648.0000	37.66	6.72	-42.10	46.10	48.38	74.00	25.62	Pass	V	Peak

Mode:		802.11 g (6Mbps) Transmitting				Channel:		2437			
NO	Freq. [MHz]	Ant Factor [dB]	Cable loss [dB]	Pream gain [dB]	Reading [dBμV]	Level [dBμV/m]	Limit [dBμV/m]	Margin [dB]	Result	Polarity	Remak
1	1168.2168	28.07	2.68	-42.93	53.71	41.53	74.00	32.47	Pass	H	Peak
2	2115.9116	31.86	3.60	-43.17	51.27	43.56	74.00	30.44	Pass	H	Peak
3	3772.0515	33.62	4.36	-43.05	49.68	44.61	74.00	29.39	Pass	H	Peak
4	4874.0000	34.50	4.78	-42.80	46.64	43.12	74.00	30.88	Pass	H	Peak
5	7311.0000	36.41	5.85	-42.14	46.12	46.24	74.00	27.76	Pass	H	Peak
6	9748.0000	37.70	6.77	-42.10	46.32	48.69	74.00	25.31	Pass	H	Peak
7	1171.6172	28.07	2.68	-42.92	51.59	39.42	74.00	34.58	Pass	V	Peak
8	2009.5010	31.71	3.49	-43.20	50.28	42.28	74.00	31.72	Pass	V	Peak
9	3042.0028	33.22	4.85	-43.11	50.62	45.58	74.00	28.42	Pass	V	Peak
10	4874.0000	34.50	4.78	-42.80	46.69	43.17	74.00	30.83	Pass	V	Peak
11	7311.0000	36.41	5.85	-42.14	46.18	46.30	74.00	27.70	Pass	V	Peak
12	9748.0000	37.70	6.77	-42.10	46.35	48.72	74.00	25.28	Pass	V	Peak

Mode:		802.11 g (6Mbps) Transmitting				Channel:		2462			
NO	Freq. [MHz]	Ant Factor [dB]	Cable loss [dB]	Pream gain [dB]	Reading [dBμV]	Level [dBμV/m]	Limit [dBμV/m]	Margin [dB]	Result	Polarity	Remak
1	1393.0393	28.29	2.89	-42.69	51.40	39.89	74.00	34.11	Pass	H	Peak
2	2064.3064	31.79	3.57	-43.19	51.64	43.81	74.00	30.19	Pass	H	Peak
3	2969.9970	33.15	4.46	-43.10	50.80	45.31	74.00	28.69	Pass	H	Peak
4	4924.0000	34.50	4.85	-42.80	47.31	43.86	74.00	30.14	Pass	H	Peak
5	7386.0000	36.49	5.85	-42.13	46.38	46.59	74.00	27.41	Pass	H	Peak
6	9848.0000	37.74	6.83	-42.10	46.88	49.35	74.00	24.65	Pass	H	Peak
7	1302.4302	28.20	2.75	-42.78	51.40	39.57	74.00	34.43	Pass	V	Peak
8	1861.8862	30.79	3.39	-42.86	50.05	41.37	74.00	32.63	Pass	V	Peak
9	3193.0129	33.28	4.64	-43.10	49.82	44.64	74.00	29.36	Pass	V	Peak
10	4924.0000	34.50	4.85	-42.80	47.05	43.60	74.00	30.40	Pass	V	Peak
11	7386.0000	36.49	5.85	-42.13	45.38	45.59	74.00	28.41	Pass	V	Peak
12	9848.0000	37.74	6.83	-42.10	46.88	49.35	74.00	24.65	Pass	V	Peak

Mode:		802.11 n (HT20) (6.5Mbps)				Channel:		2412			
NO	Freq. [MHz]	Ant Factor [dB]	Cable loss [dB]	Pream gain [dB]	Reading [dBμV]	Level [dBμV/m]	Limit [dBμV/m]	Margin [dB]	Result	Polarity	Remak
1	1254.4254	28.15	2.69	-42.83	52.86	40.87	74.00	33.13	Pass	H	Peak
2	1842.2842	30.66	3.37	-42.81	50.99	42.21	74.00	31.79	Pass	H	Peak
3	3068.0045	33.23	4.79	-43.10	50.74	45.66	74.00	28.34	Pass	H	Peak
4	4824.0000	34.50	4.61	-42.80	47.80	44.11	74.00	29.89	Pass	H	Peak
5	7236.0000	36.34	5.79	-42.16	45.56	45.53	74.00	28.47	Pass	H	Peak
6	9648.0000	37.66	6.72	-42.10	47.22	49.50	74.00	24.50	Pass	H	Peak
7	1279.8280	28.18	2.72	-42.80	51.64	39.74	74.00	34.26	Pass	V	Peak
8	1967.0967	31.48	3.44	-43.12	51.02	42.82	74.00	31.18	Pass	V	Peak
9	2896.5897	33.03	4.37	-43.10	50.94	45.24	74.00	28.76	Pass	V	Peak
10	4824.0000	34.50	4.61	-42.80	46.49	42.80	74.00	31.20	Pass	V	Peak
11	7236.0000	36.34	5.79	-42.16	46.33	46.30	74.00	27.70	Pass	V	Peak
12	9648.0000	37.66	6.72	-42.10	46.51	48.79	74.00	25.21	Pass	V	Peak

Mode:		802.11 n (HT20) (6.5Mbps)				Channel:		2437			
NO	Freq. [MHz]	Ant Factor [dB]	Cable loss [dB]	Pream gain [dB]	Reading [dBμV]	Level [dBμV/m]	Limit [dBμV/m]	Margin [dB]	Result	Polarity	Remak
1	1229.6230	28.13	2.67	-42.86	52.20	40.14	74.00	33.86	Pass	H	Peak
2	1800.0800	30.38	3.32	-42.71	51.13	42.12	74.00	31.88	Pass	H	Peak
3	2929.1929	33.09	4.39	-43.10	50.94	45.32	74.00	28.68	Pass	H	Peak
4	4874.0000	34.50	4.78	-42.80	46.89	43.37	74.00	30.63	Pass	H	Peak
5	7311.0000	36.41	5.85	-42.14	46.34	46.46	74.00	27.54	Pass	H	Peak
6	9748.0000	37.70	6.77	-42.10	46.96	49.33	74.00	24.67	Pass	H	Peak
7	1174.8175	28.07	2.68	-42.92	51.19	39.02	74.00	34.98	Pass	V	Peak
8	1794.8795	30.35	3.31	-42.71	51.40	42.35	74.00	31.65	Pass	V	Peak
9	3086.0057	33.23	4.75	-43.09	51.03	45.92	74.00	28.08	Pass	V	Peak
10	4874.0000	34.50	4.78	-42.80	46.87	43.35	74.00	30.65	Pass	V	Peak
11	7311.0000	36.41	5.85	-42.14	45.52	45.64	74.00	28.36	Pass	V	Peak
12	9748.0000	37.70	6.77	-42.10	46.86	49.23	74.00	24.77	Pass	V	Peak

Mode:		802.11 n (HT20) (6.5Mbps)				Channel:		2462			
NO	Freq. [MHz]	Ant Factor [dB]	Cable loss [dB]	Pream gain [dB]	Reading [dBμV]	Level [dBμV/m]	Limit [dBμV/m]	Margin [dB]	Result	Polarity	Remak
1	1332.2332	28.23	2.80	-42.75	52.15	40.43	74.00	33.57	Pass	H	Peak
2	1838.6839	30.64	3.37	-42.81	50.62	41.82	74.00	32.18	Pass	H	Peak
3	3932.0621	33.75	4.34	-43.02	50.08	45.15	74.00	28.85	Pass	H	Peak
4	4924.0000	34.50	4.85	-42.80	48.52	45.07	74.00	28.93	Pass	H	Peak
5	7386.0000	36.49	5.85	-42.13	46.72	46.93	74.00	27.07	Pass	H	Peak
6	9848.0000	37.74	6.83	-42.10	45.86	48.33	74.00	25.67	Pass	H	Peak
7	1299.2299	28.20	2.75	-42.79	51.79	39.95	74.00	34.05	Pass	V	Peak
8	1838.6839	30.64	3.37	-42.81	50.72	41.92	74.00	32.08	Pass	V	Peak
9	3101.0067	33.24	4.72	-43.10	49.71	44.57	74.00	29.43	Pass	V	Peak
10	4924.0000	34.50	4.85	-42.80	47.81	44.36	74.00	29.64	Pass	V	Peak
11	7386.0000	36.49	5.85	-42.13	45.48	45.69	74.00	28.31	Pass	V	Peak
12	9848.0000	37.74	6.83	-42.10	46.33	48.80	74.00	25.20	Pass	V	Peak

Mode:		802.11 n (HT40) (13.5Mbps)				Channel:		2422			
NO	Freq. [MHz]	Ant Factor [dB]	Cable loss [dB]	Pream gain [dB]	Reading [dBμV]	Level [dBμV/m]	Limit [dBμV/m]	Margin [dB]	Result	Polarity	Remak
1	1171.0171	28.07	2.68	-42.92	52.31	40.14	74.00	33.86	Pass	H	Peak
2	2929.9930	33.09	4.39	-43.10	50.56	44.94	74.00	29.06	Pass	H	Peak
3	3930.0620	33.74	4.34	-43.01	49.85	44.92	74.00	29.08	Pass	H	Peak
4	4844.0000	34.50	4.66	-42.80	47.05	43.41	74.00	30.59	Pass	H	Peak
5	7266.0000	36.37	5.80	-42.15	44.80	44.82	74.00	29.18	Pass	H	Peak
6	9688.0000	37.68	6.62	-42.10	46.51	48.71	74.00	25.29	Pass	H	Peak
7	1336.6337	28.24	2.80	-42.75	51.62	39.91	74.00	34.09	Pass	V	Peak
8	1725.8726	29.89	3.22	-42.68	50.14	40.57	74.00	33.43	Pass	V	Peak
9	3122.0081	33.25	4.65	-43.10	50.57	45.37	74.00	28.63	Pass	V	Peak
10	4844.0000	34.50	4.66	-42.80	47.48	43.84	74.00	30.16	Pass	V	Peak
11	7266.0000	36.37	5.80	-42.15	45.56	45.58	74.00	28.42	Pass	V	Peak
12	9688.0000	37.68	6.62	-42.10	47.69	49.89	74.00	24.11	Pass	V	Peak

Mode:		802.11 n (HT40) (13.5Mbps)				Channel:		2437			
NO	Freq. [MHz]	Ant Factor [dB]	Cable loss [dB]	Pream gain [dB]	Reading [dBμV]	Level [dBμV/m]	Limit [dBμV/m]	Margin [dB]	Result	Polarity	Remak
1	1170.0170	28.07	2.68	-42.92	54.71	42.54	74.00	31.46	Pass	H	Peak
2	1653.6654	29.41	3.14	-42.76	51.32	41.11	74.00	32.89	Pass	H	Peak
3	3066.0044	33.23	4.79	-43.10	50.36	45.28	74.00	28.72	Pass	H	Peak
4	4874.0000	34.50	4.78	-42.80	46.41	42.89	74.00	31.11	Pass	H	Peak
5	7311.0000	36.41	5.85	-42.14	45.08	45.20	74.00	28.80	Pass	H	Peak
6	9748.0000	37.70	6.77	-42.10	46.02	48.39	74.00	25.61	Pass	H	Peak
7	1278.8279	28.18	2.72	-42.81	51.17	39.26	74.00	34.74	Pass	V	Peak
8	1939.2939	31.30	3.42	-43.05	50.75	42.42	74.00	31.58	Pass	V	Peak
9	2833.3833	32.93	4.23	-43.09	50.99	45.06	74.00	28.94	Pass	V	Peak
10	4874.0000	34.50	4.78	-42.80	46.83	43.31	74.00	30.69	Pass	V	Peak
11	7311.0000	36.41	5.85	-42.14	46.23	46.35	74.00	27.65	Pass	V	Peak
12	9748.0000	37.70	6.77	-42.10	46.67	49.04	74.00	24.96	Pass	V	Peak

Mode:		802.11 n (HT40) (13.5Mbps)				Channel:		2452			
NO	Freq. [MHz]	Ant Factor [dB]	Cable loss [dB]	Pream gain [dB]	Reading [dBμV]	Level [dBμV/m]	Limit [dBμV/m]	Margin [dB]	Result	Polarity	Remak
1	1170.2170	28.0	2.68	-42.92	56.42	44.25	74.00	29.75	Pass	H	Peak
2	1716.4716	29.8	3.21	-42.67	51.14	41.51	74.00	32.49	Pass	H	Peak
3	2954.9955	33.1	4.41	-43.10	50.56	45.00	74.00	29.00	Pass	H	Peak
4	4904.0000	34.5	4.88	-42.80	47.63	44.21	74.00	29.79	Pass	H	Peak
5	7356.0000	36.4	5.85	-42.13	45.99	46.17	74.00	27.83	Pass	H	Peak
6	9808.0000	37.7	6.59	-42.10	47.62	49.83	74.00	24.17	Pass	H	Peak
7	1300.0300	28.2	2.75	-42.78	51.75	39.92	74.00	34.08	Pass	V	Peak
8	2029.1029	31.7	3.52	-43.19	51.84	43.91	74.00	30.09	Pass	V	Peak
9	3076.0051	33.2	4.77	-43.10	50.43	45.33	74.00	28.67	Pass	V	Peak
10	4904.0000	34.5	4.88	-42.80	46.48	43.06	74.00	30.94	Pass	V	Peak
11	7356.0000	36.4	5.85	-42.13	45.94	46.12	74.00	27.88	Pass	V	Peak
12	9808.0000	37.7	6.59	-42.10	46.92	49.13	74.00	24.87	Pass	V	Peak

Note:

1) The field strength is calculated by adding the Antenna Factor, Cable Factor & Preamplifier. The basic equation with a sample calculation is as follows:

Final Test Level = Receiver Reading - Correct Factor

Correct Factor = Preamplifier Factor - Antenna Factor - Cable Factor

2) Scan from 9kHz to 25GHz, the disturbance above 13GHz and below 30MHz was very low, and the above harmonics were the highest point could be found when testing, so only the above harmonics had been displayed. The amplitude of spurious emissions from the radiator which are attenuated more than 20dB below the limit need not be reported.