

FCC Radio Test Report

FCC ID: 2AHLZ-CWI535

FCC 47 CFR Part 15 Subpart C

RSS 247 Issue 1:2016

Product	:	Notebook
Trade Name	:	CHUWI
Model No.	:	CWI535
Serise Model No.	:	CWI535, CWI538, CWI533, CWI534, CWI549, CWI539, CWI540, CWI541, CWI542, CWI543, CWI544, CWI545, CWI546, CWI547, CWI548

Issued for

CHUWI TECHNOLOGY (ShenZhen) CO., LIMITED

2 Floor Building 3 LiJinCheng Industrial park the east of Gongye road LongHua
Shenzhen China

Issued by

Shenzhen ATL Testing Technology Co., Ltd.

F/4, Building 10, Dayuan Industrial Zone, Xili Town, Nanshan District, Shenzhen,
China

Tel.: +86-0755-26909822 Fax.: +86-0755-61605504

Website: www.atllab.org

Note: This report shall not be reproduced except in full, without the written approval of Shenzhen ATL Testing Technology Co., Ltd.. This document may be altered or revised by Shenzhen ATL Testing Technology Co., Ltd. personnel only, and shall be noted in the revision section of the document. The test results in the report only apply to the tested sample

TEST RESULT CERTIFICATION

Product : Notebook

Applicant..... : CHUWI TECHNOLOGY (ShenZhen) CO., LIMITED

Address : 2 Floor Building 3 LiJinCheng Industrial park the east of Gongye road LongHua Shenzhen China

Manufacturer..... : CHUWI TECHNOLOGY (ShenZhen) CO., LIMITED

Address : 2 Floor Building 3 LiJinCheng Industrial park the east of Gongye road LongHua Shenzhen China

Model No. : CWI535

Standards : FCC Part 15 Subpart C (15.247)
 : RSS 247 Issue 1: 2016

Test Method..... : ANSI C63.10: 2013
 : KDB 558074 D01 DTS Meas Guidance v04

The above equipment has been tested by Shenzhen ATL Testing Technology Co., Ltd. and found compliance with the requirements set forth in the technical standards mentioned above. The results of testing in this report apply only to the product/system, which was tested. Other similar equipment will not necessarily produce the same results due to production tolerance and measurement uncertainties.

Test..... :

Date of receipt of test item 2017-06-18

Date(s) of performance of test 2017-06-19 to 2017-06-28

Test Result..... : **Pass**

Testing by	: <i>Sifeifei</i>	Date	: 2017-06-19
	(Si feifei)		_____
Check by	: <i>XieLingling</i>	Date	: 2017-06-27
	(Xie Lingling)		_____
Approved by	: <i>Xu Peng</i>	Date	: 2017-06-28
	(Xu Peng)		_____

Table of Contents	Page
1 . TEST SUMMARY	5
1.1 TEST FACILITY	6
1.2 MEASUREMENT UNCERTAINTY	6
2 . GENERAL INFORMATION	7
2.1 GENERAL DESCRIPTION OF EUT	7
PIFA Antenna (Max. Gain: 0.85 dBi)	7
2.2 DESCRIPTION OF TEST MODES	9
2.3 DESCRIPTION OF TEST SETUP	10
2.4 DESCRIPTION TEST PERIPHERAL AND EUT PERIPHERAL	11
2.5 EUT EXERCISE SOFTWARE	11
3 . CONDUCTED EMISSION TEST	12
3.1 CONDUCTED EMISSION MEASUREMENT (Frequency Range 150KHz-30MHz)	12
3.2 TEST PROCEDURE	12
3.3 TEST SETUP	13
3.4 TEST INSTRUMENTS	13
3.5 EUT OPERATING CONDITIONS	13
3.6 TEST RESULTS	14
RADIATED EMISSION MEASUREMENT	16
3.7 RADIATED EMISSION LIMIT (Frequency Range 9KHz-1000MHz)	16
3.8 TEST PROCEDURE	16
3.9 TEST SETUP	17
3.10 TEST INSTRUMENTS	18
3.11 EUT OPERATING CONDITIONS	18
3.12 TEST RESULTS	19
4 . MAXIMUM CONDUCTED OUTPUT POWER MEASUREMENT	33
4.1 LIMITS	33
4.2 TEST PROCEDURE	33
4.3 TEST SETUP	33
4.4 TEST INSTRUMENTS	33
4.5 EUT OPERATING CONDITIONS	33
4.6 TEST RESULTS	33
5 . OCCUPIED BANDWIDTH MEASUREMENT	35
5.1 LIMITS	35

Table of Contents	Page
5.2 TEST PROCEDURE	35
5.3 TEST SETUP	35
5.4 TEST INSTRUMENTS	35
5.5 EUT OPERATING CONDITIONS	35
5.6 TEST RESULTS	35
6 . POWER SPECTRAL DENSITY	44
6.1 LIMITS	44
6.2 TEST PROCEDURE	44
6.3 TEST SETUP	44
6.4 TEST INSTRUMENTS	44
6.5 EUT OPERATING CONDITIONS	44
6.6 TEST RESULTS	44
7 . BAND EDGE AND OUT-OF-BAND EMISSION	53
7.1 LIMITS	53
7.2 TEST PROCEDURE	53
7.3 TEST SETUP	53
7.4 TEST INSTRUMENTS	54
7.5 EUT OPERATING CONDITIONS	54
7.6 TEST RESULTS	54
8 . ANTENNA REQUIREMENT	67
8.1 REQUIREMENT	67
8.2 ANTENNA CONNECTOR CONSTRUCTION	67

1. TEST SUMMARY

Test procedures according to the technical standards:

FCC Part 15 Subpart C (15.247)/RSS 247 Issue 1: 2015				
Standard Section		Test Item	Judgment	Remark
FCC	IC			
15.203	/	Antenna Requirement	PASS	
15.207	RSS-GEN 7.2.4	Conducted Emission	PASS	
15.205/ 15.209	RSS-GEN 7.2.2	Restricted Bands	PASS	
15.247(a)(2)	RSS 247 5.2 (1)	6dB Bandwidth	PASS	
15.247(b)	RSS 247 5.4 (4)	Peak Output Power	PASS	
15.247(e)	RSS 247 5.2 (2)	Power Spectral Density	PASS	
15.247(d)	RSS 247 5.5	Band Edge/Out-of-band Emission	PASS	

NOTE:

(1) "N/A" denotes test is not applicable in this Test Report

(2) The test results of this report relate only to the tested sample(s) identified in this report.

1.1 TEST FACILITY

Shenzhen ATL Testing Technology Co., Ltd.

Add. : F/4, Building 10, Dayuan Industrial Zone, Xili Town, Nanshan District, Shenzhen, China

1.2 MEASUREMENT UNCERTAINTY

The reported uncertainty of measurement $y \pm U$, where expanded uncertainty U is based on a standard uncertainty multiplied by a coverage factor of $k=2$, providing a level of confidence of approximately **95** %.

A. Conducted Emission :

The measurement uncertainty is evaluated as ± 3.2 dB.

B. Radiated Measurement :

The measurement uncertainty is evaluated as ± 3.7 dB.

2. GENERAL INFORMATION

2.1 GENERAL DESCRIPTION OF EUT

Equipment	Notebook
Model Name	CWI535
Additional Model Number(s)	CWI538, CWI533, CWI534, CWI549, CWI539, CWI540, CWI541, CWI542, CWI543, CWI544, CWI545, CWI546, CWI547, CWI548
Model Difference	All these models are identical in the same PCB layout and electrical circuit, the only difference is model name for commercial.
Frequency Range	802.11b/g/n(HT20):2412~2462 MHz 802.11n(HT40):2422~2452 MHz Bluetooth V4.0: 2402~2480 MHz (Note 2)
Modulation Type	802.11b: DSSS (BPSK/QPSK/CCK) 802.11g/n: OFDM
Data Rate	802.11b: 1/2/5.5/11 Mbps 802.11g: 6/9/12/18/24/36/48/54 Mbps 802.11n: 150 Mbps
RF Output Power	802.11b: 9.32 dBm 802.11g: 9.19 dBm 802.11n(HT20): 9.09 dBm 802.11n(HT40): 9.01 dBm
Antenna Type	PIFA Antenna (Max. Gain: 0.85 dBi)
Power Source	DC Powered by AC/DC Adapter . DC Powered by Li-ion Battery .
Power Rating	AC/DC Adapter: Input: AC 100-240V,0.8A Max. Output: DC 12, 2A. DC 7.6V from Li-ion Battery.
Remark	More details EUT technical specifications, please refer to the User's Manual.

Note:

- (1) This Test Report is FCC Part 15 Subpart C, 15.247 for IEEE 802.11b/g/n. And the Test procedure follows the FCC KDB 558074 D01 DTS Meas Guidance v03r05.
- (2) The EUT has also been tested and complied the FCC 15C for Bluetooth, and recorded in the separate test report.
- (3) Transmitting mode with antennas

Mode	TX Antenna (s)
802.11b	1
802.11g	1
802.11n(HT20)	1
802.11n(HT40)	1

(4) Channel List.

2.4 GHz Band				
Frequency Band	Channel No.	Frequency	Channel No.	Frequency
2400~2483.5MHz	1	2412 MHz	7	2442 MHz
	2	2417 MHz	8	2447 MHz
	3	2422 MHz	9	2452 MHz
	4	2427 MHz	10	2457 MHz
	5	2432 MHz	11	2462 MHz
	6	2437 MHz		

For 802.11b/g/n(HT20), use channel 1~11
 For 802.11n(HT40), use channel 3~9

2.2 DESCRIPTION OF TEST MODES

To investigate the maximum EMI emission characteristics generates from EUT, the test system was pre-scanning tested base on the consideration of following EUT operation mode or test configuration mode which possible have effect on EMI emission level. Each of these EUT operation mode(s) or test configuration mode(s) mentioned above was evaluated respectively.

Pretest Mode	Description
Mode 1	WiFi TX Mode
Mode 2	WiFi TX 802.11b Mode
Mode 3	WiFi TX 802.11g Mode
Mode 4	WiFi TX 802.11n(HT20)Mode
Mode 5	WiFi TX 802.11n(HT40) Mode

For Conducted Test	
Final Test Mode	Description
Mode 1	WiFi TX Mode

For Radiated Test	
Final Test Mode	Description
Mode 1	WiFi TX Mode
Mode 2	WiFi TX 802.11b Mode
Mode 3	WiFi TX 802.11g Mode
Mode 4	WiFi TX 802.11n(HT20)Mode
Mode 5	WiFi TX 802.11n(HT40) Mode

Note:

- (1) Software used to control the EUT for staying in continuous transmitting mode was programmed. After verification, all tests were carried out with the worst case test modes as shown below.
- (2) IEEE 802.11b Mode:
Channel (2412/2437/2462 MHz) with 1Mbps data rate were chosen for full testing.
- (3) IEEE 802.11g Mode:
Channel (2412/2437/2462 MHz) with 6 Mbps data rate were chosen for full testing.
- (4) IEEE 802.11n(HT20) Mode:
Channel (2412/2437/2462 MHz) with MCS 0 data rate were chosen for full testing.
- (5) IEEE 802.11n(HT40) Mode:
Channel (2422/2437/2452 MHz) with MCS 0 data rate were chosen for full testing.
- (6) By preliminary testing and verifying three axis (X, Y and Z) position of EUT transmitted status, it was found that "X axis" position was the worst, then the final test was executed the worst condition and test data were recorded in this report.

2.3 DESCRIPTION OF TEST SETUP

Conducted Emission

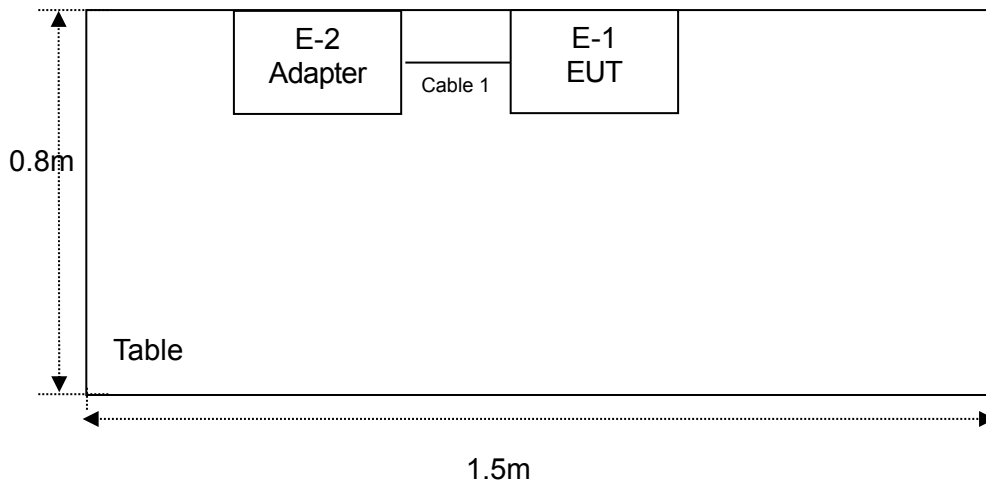

Radiated Emission

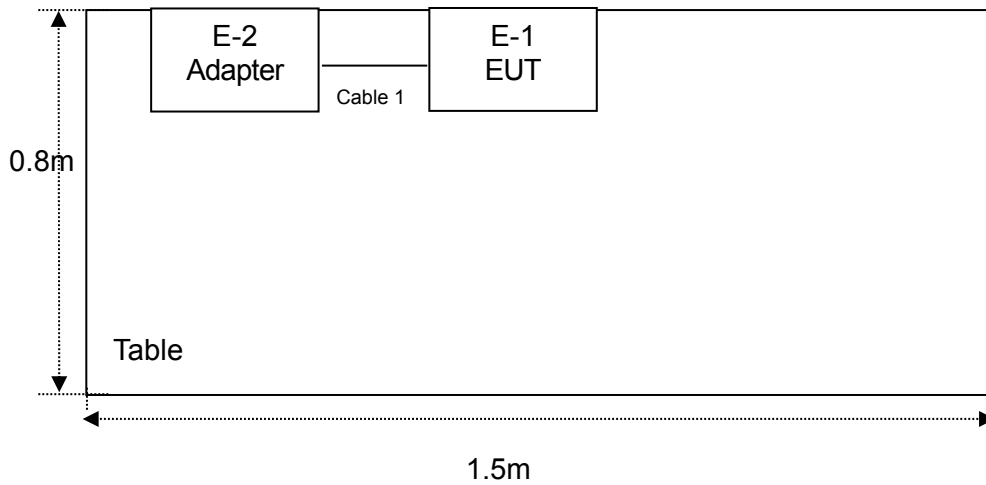

2.4 DESCRIPTION TEST PERIPHERAL AND EUT PERIPHERAL

The EUT has been tested as an independent unit together with other necessary accessories or support units. The following support units or accessories were used to form a representative test configuration during the tests.

Item	Equipment	Mfr/Brand	Model/Type No.	Series No.	Note
E-1	Notebook	N/A	CWI535	N/A	EUT
E-2	Adapter	N/A	ZX241202000	N/A	EUT

Item	Shielded Type	Ferrite Core	Length	Note
1	NO	NO	2m	

Note:

- (1) The support equipment was authorized by Declaration of Confirmation.
- (2) For detachable type I/O cable should be specified the length in cm in 『Length』 column.
- (3) “YES” means “shielded” “with core”; “NO” means “unshielded” “without core”.

2.5 EUT EXERCISE SOFTWARE

Power Parameters for Testing			
Test Software Version	N/A		
Mode	Frequency/ Parameters		
802.11b	2412 MHz	2437 MHz	2462 MHz
	DEF	DEF	DEF
802.11g	2412 MHz	2437 MHz	2462 MHz
	DEF	DEF	DEF
802.11n(HT20)	2412 MHz	2437 MHz	2462 MHz
	DEF	DEF	DEF
802.11n(HT40)	2422 MHz	2437 MHz	2452 MHz
	DEF	DEF	DEF

3. CONDUCTED EMISSION TEST

3.1 CONDUCTED EMISSION MEASUREMENT (Frequency Range 150KHz-30MHz)

FREQUENCY (MHz)	Quasi-peak	Average
	dBuV	dBuV
0.15 -0.5	66 - 56 *	56 - 46 *
0.50 -5.0	56.00	46.00
5.0 -30.0	60.00	50.00

Note:

- (1) The tighter limit applies at the band edges.
- (2) The limit of " * " marked band means the limitation decreases linearly with the logarithm of the frequency in the range.

The following table is the setting of the receiver

Receiver Parameters	Setting
Attenuation	10 dB
Start Frequency	0.15 MHz
Stop Frequency	30 MHz
IF Bandwidth	9 kHz

3.2 TEST PROCEDURE

- a. The EUT was placed 0.8 meters from the horizontal ground plane with EUT being connected to the power mains through a line impedance stabilization network (LISN). All other support equipments powered from additional LISN(s). The LISN provide 50 Ohm/ 50uH of coupling impedance for the measuring instrument.
- b. Interconnecting cables that hang closer than 40 cm to the ground plane shall be folded back and forth in the center forming a bundle 30 to 40 cm long.
- c. I/O cables that are not connected to a peripheral shall be bundled in the center. The end of the cable may be terminated, if required, using the correct terminating impedance. The overall length shall not exceed 1 m.
- d. LISN at least 80 cm from nearest part of EUT chassis.
- e. For the actual test configuration, please refer to the related Item –EUT Test Photos.

3.3 TEST SETUP

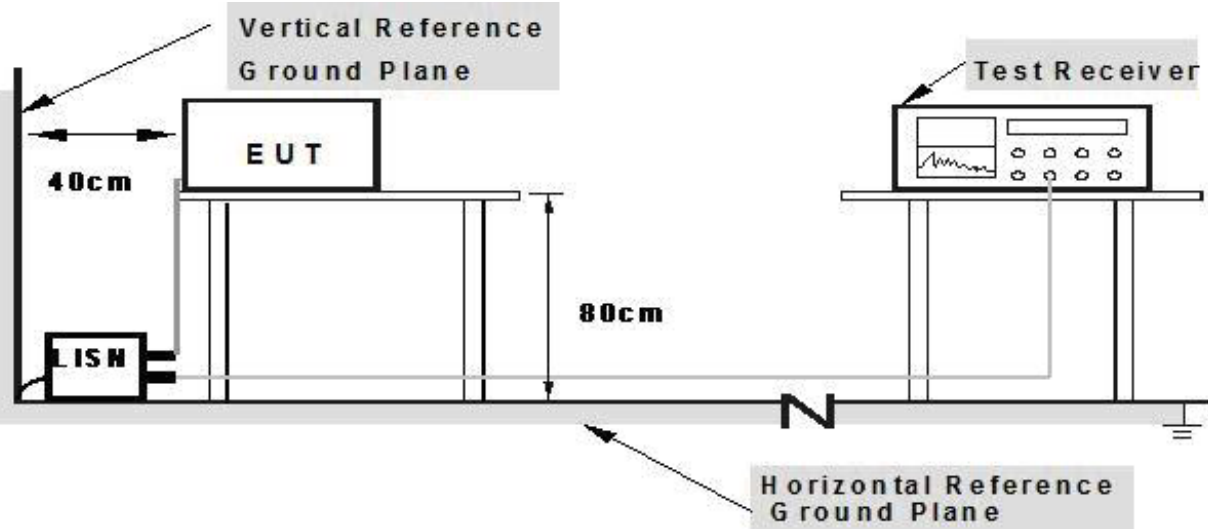

- Note: 1. Support units were connected to second LISN.**
2. Both of LISNs (AMN) are 80 cm from EUT and at least 80 from other units and other metal planes

3.4 TEST INSTRUMENTS

Equipment	Manufacturer	Type No.	Serial No.	Last calibration	Calibrated until	Calibration period
LISN	R&S	NSLK81	8126466	Jul. 04, 2016	Jul. 03. 2017	1 year
LISN	R&S	NSLK81	8126487	Jul. 04, 2016	Jul. 03. 2017	1 year
50Ω Switch	ANRITSU CORP	MP59B	6200983704	Jul. 04, 2016	Jul. 03. 2017	1 year
Test Cable	N/A	C01	N/A	Jul. 04, 2016	Jul. 03. 2017	1 year
Test Cable	N/A	C02	N/A	Jul. 04, 2016	Jul. 03. 2017	1 year
Test Cable	N/A	C03	N/A	Jul. 04, 2016	Jul. 03. 2017	1 year
EMI Test Receiver	R&S	ESCI	1166.595	Jul. 04, 2016	Jul. 03. 2017	1 year
Passive Voltage Probe	ESH2-Z3	R&S	100196	Jul. 04, 2016	Jul. 03. 2017	1 year

3.5 EUT OPERATING CONDITIONS

The EUT tested system was configured as the statements of 2.3 Unless otherwise a special operating condition is specified in the follows during the testing.

3.6 TEST RESULTS

EUT :	Notebook	Model Name. :	CWI535
Temperature :	26 °C	Relative Humidity :	56%
Pressure :	1010hPa	Test Date :	2017-06-23
Test Mode :	WIFI TX Mode (B 2412MHz)	Phase :	Line
Test Voltage :	AC 120V/ 60Hz		

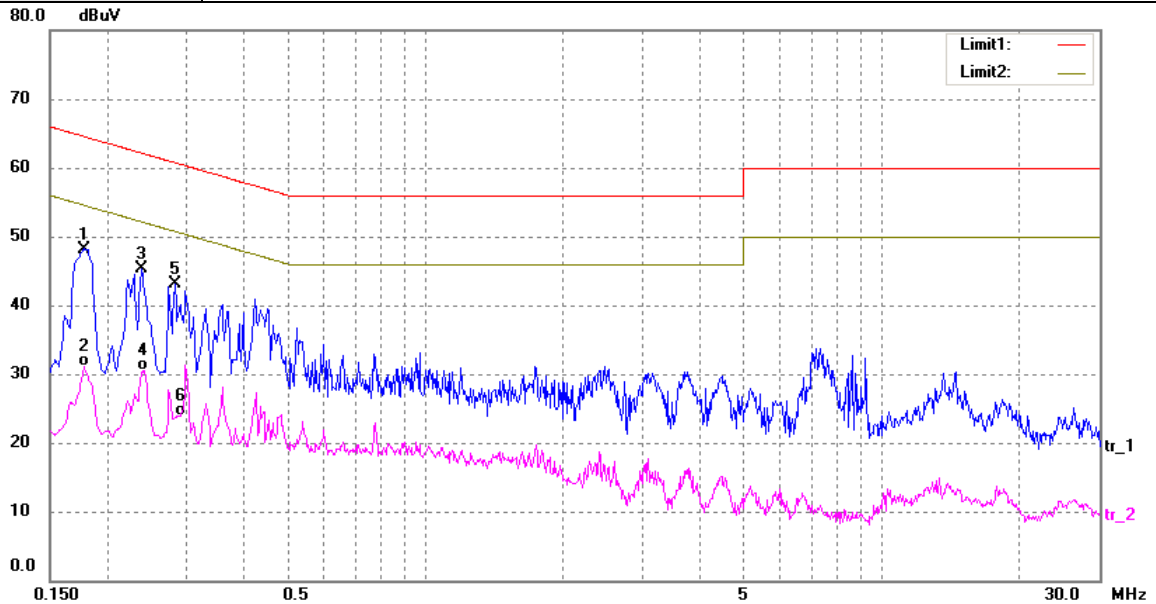

No.	Frequency (MHz)	Reading (dBuV)	Correct (dB/m)	Result (dBuV)	Limit (dBuV)	Margin (dB)	Detector
1*	0.1780	38.70	9.50	48.20	64.58	-16.38	QP
2	0.1780	21.59	9.50	31.09	54.58	-23.49	AVG
3	0.2380	35.83	9.50	45.33	62.17	-16.84	QP
4	0.2420	21.05	9.50	30.55	52.03	-21.48	AVG
5	0.2820	33.51	9.50	43.01	60.76	-17.75	QP
6	0.2878	14.31	9.50	23.81	50.59	-26.78	AVG

Remark:

1. All readings are Quasi-Peak and Average values.
2. Factor = Insertion Loss + Cable Loss.

EUT :	Notebook	Model Name. :	CWI535
Temperature :	26 °C	Relative Humidity :	56%
Pressure :	1010hPa	Test Date :	2017-06-23
Test Mode :	WIFI TX Mode (B 2412MHz)	Phase :	Neutral
Test Voltage :	AC 120V/ 60Hz		

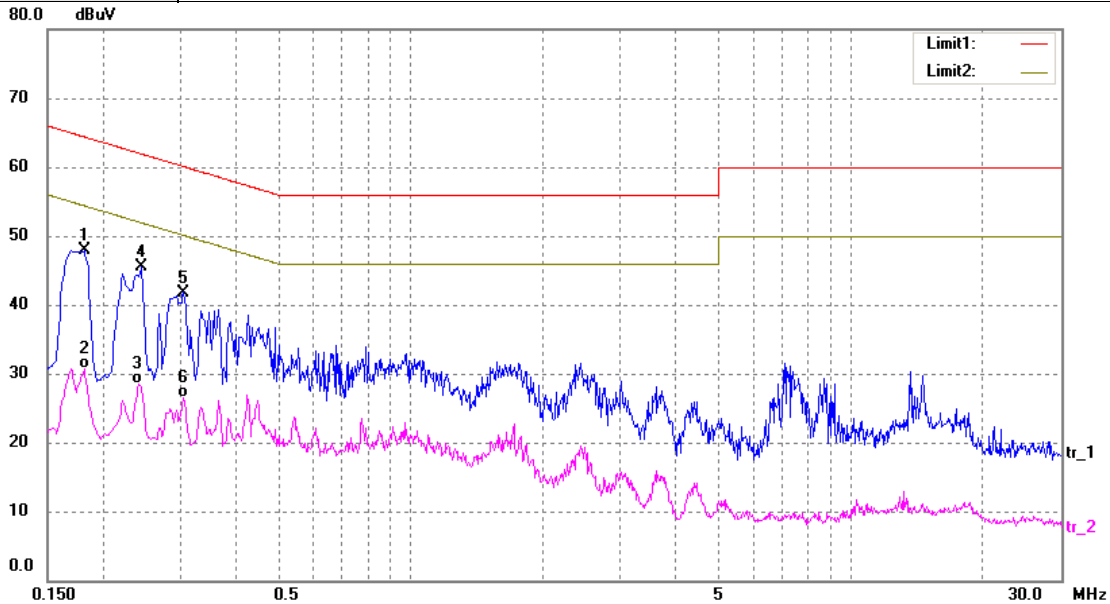

No.	Frequency (MHz)	Reading (dBuV)	Correct (dB/m)	Result (dBuV)	Limit (dBuV)	Margin (dB)	Detector
1	0.1820	38.35	9.50	47.85	64.39	-16.54	QP
2	0.1820	21.25	9.50	30.75	54.39	-23.64	AVG
3*	0.2460	36.02	9.50	45.52	61.89	-16.37	QP
4	0.2420	19.01	9.50	28.51	52.03	-23.52	AVG
5	0.3060	32.30	9.50	41.80	60.08	-18.28	QP
6	0.3060	17.04	9.50	26.54	50.08	-23.54	AVG

Remark:

1. All readings are Quasi-Peak and Average values.
2. Factor = Insertion Loss + Cable Loss.

RADIATED EMISSION MEASUREMENT

3.7 RADIATED EMISSION LIMIT (Frequency Range 9KHz-1000MHz)

20 dBc in any 100 kHz bandwidth outside the operating frequency band. In case the emission fall within the restricted band specified on 15.205(a) and RSS-210 Section 2.2&A8.5, then the 15.209(a) and RSS-General limit in the table below has to be followed.

FREQUENCY (MHz)	Field Strength (uV/m at meter)	Measurement Distance (meters)
0.009 -0.490	2400/F(KHz)	300
0.490 -1.705	24000/F(KHz)	30
1.705 -30.0	30	30
30 -88	100	3
88 -216	150	3
216~960	200	3
Above 960	500	3

RADIATED EMISSION LIMITS (Above 1000MHz)

FREQUENCY (MHz)	Distance of 3m (dBuV/m)	
	Peak	Average
Above 1000	74	54

Note:

- (1) The limit for radiated test was performed according to FCC PART 15C.
- (2) The tighter limit applies at the band edges.
- (2) Emission Level(dBuV/m)=20log Emission Level(uV/m)

The following table is the setting of the receiver

Receiver Parameter	Setting
Attenuation	Auto
Start Frequency~ Stop Frequency	9kHz~150kHz/ RB 200Hz for QP
Start Frequency~ Stop Frequency	150kHz~30MHz/ RB 9kHz for QP
Start Frequency~ Stop Frequency	30MHz~1000MHz/ RB120kHz for QP

The following table is the setting of the spectrum

Spectrum Parameter	Setting
Attenuation	Auto
Start Frequency	1000 MHz
Stop Frequency	10 th carrier harmonic
RB/ VB (emission in restricted band)	1MHz/ 3 MHz for Peak, 1MHz/ 10Hz for Average

3.8 TEST PROCEDURE

- a. The measuring distance of at 3 m shall be used for measurements at frequency up to 1GHz. For frequencies above 1GHz, any suitable measuring distance may be used.
- b. The EUT was placed on the top of a rotating table 0.8 meters above the ground at a 3 meter open area test site. The table was rotated 360 degrees to determine the position of the highest radiation.

- c. The height of the equipment or of the substitution antenna shall be 0.8 m; the height of the test antenna shall vary between 1 m to 4 m. Both horizontal and vertical polarizations of the antenna are set to make the measurement.
- d. The initial step in collecting conducted emission data is a spectrum analyzer peak detector mode pre-scanning the measurement frequency range. Significant peaks are then marked and then Quasi Peak detector mode re-measured, above 1G Average detector mode will be instead.
- e. If the Peak Mode measured value compliance with and lower than Quasi Peak Mode Limit, the EUT shall be deemed to meet QP Limits and then no additional QP Mode measurement performed.
- f. For the actual test configuration, please refer to the related Item –EUT Test Photos.

Note:

Both horizontal and vertical antenna polarities were tested.

And performed pretest to three orthogonal axis. The worst case emissions were reported.

3.9 TEST SETUP

(A) Radiated Emission Test Set-Up Frequency Below 30MHz

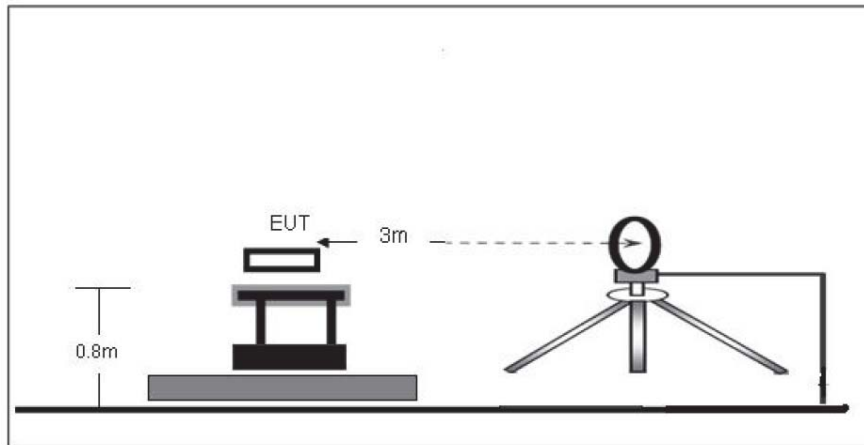

(B) Radiated Emission Test Set-Up Frequency Below 1 GHz

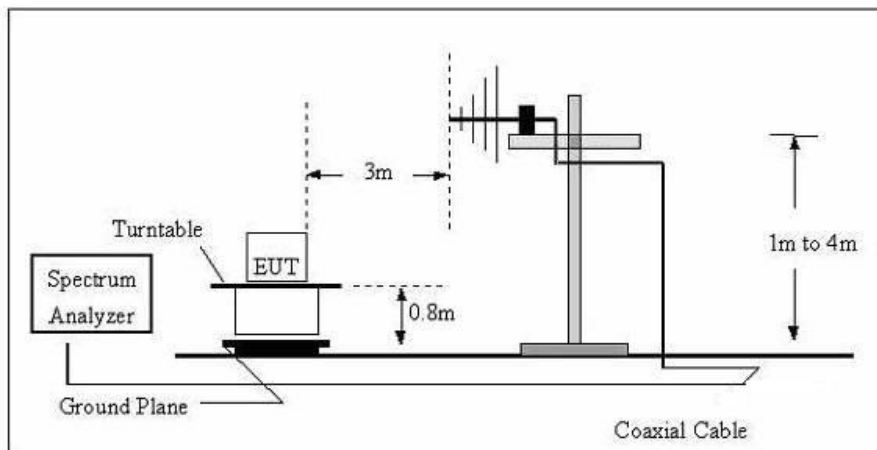

(C) Radiated Emission Test Set-Up Frequency Above 1GHz

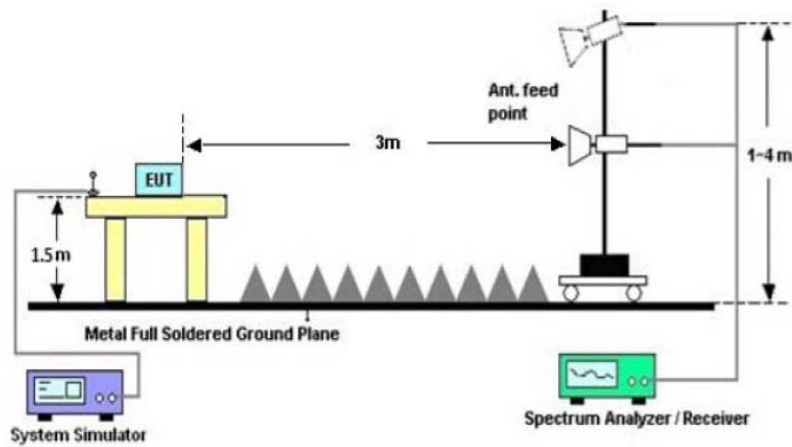

3.10 TEST INSTRUMENTS

Equipment	Manufacturer	Type No.	Serial No.	Last calibration	Calibrated until	Calibration period
Broadband Antenna	R&S	VULB 9168	VULB 9168-456	Jul. 04, 2016	Jul. 03. 2017	1 year
Test Cable	N/A	R-01	N/A	Jul. 04, 2016	Jul. 03. 2017	1 year
Test Cable	N/A	R-02	N/A	Jul. 04, 2016	Jul. 03. 2017	1 year
EMI Test Receiver	R&S	ESCI	101324	Jul. 04, 2016	Jul. 03. 2017	1 year
Antenna Mast	EM	SC100_1	N/A	N/A	N/A	N/A
Turn Table	EM	SC100	060531	N/A	N/A	N/A
50Ω Switch	Anritsu Corp	MP59B	6200983705	Jul. 04, 2016	Jul. 03. 2017	1 year
Spectrum Analyzer	R&S	FSP40	100154	Jul. 04, 2016	Jul. 03. 2017	1 year
Horn Antenna	R&S	HF906	10029	Jul. 04, 2016	Jul. 03. 2017	1 year
Amplifier	EM	EM-30180	060538	Jul. 04, 2016	Jul. 03. 2017	1 year

3.11 EUT OPERATING CONDITIONS

The EUT tested system was configured as the statements of 2.3 Unless otherwise a special operating condition is specified in the follows during the testing.

3.12 TEST RESULTS

3.12.1 TEST RESULTS (9KHz-30MHz)

Note: The amplitude of spurious emissions which are attenuated by more than 20dB below the permissible value has no need to be reported.

3.12.2 TEST RESULTS (Bellow 1GHz)

EUT :	Notebook	Model Name. :	CWI535
Temperature :	26 °C	Relative Humidity :	56%
Pressure :	1010 hPa	Test Date :	2017-06-23
Test Mode :	WIFI TX Mode (B 2412MHz)	Polarization :	Horizontal
Test Power :	AC 120V/ 60Hz		
Remark :	Only show the worse case.		

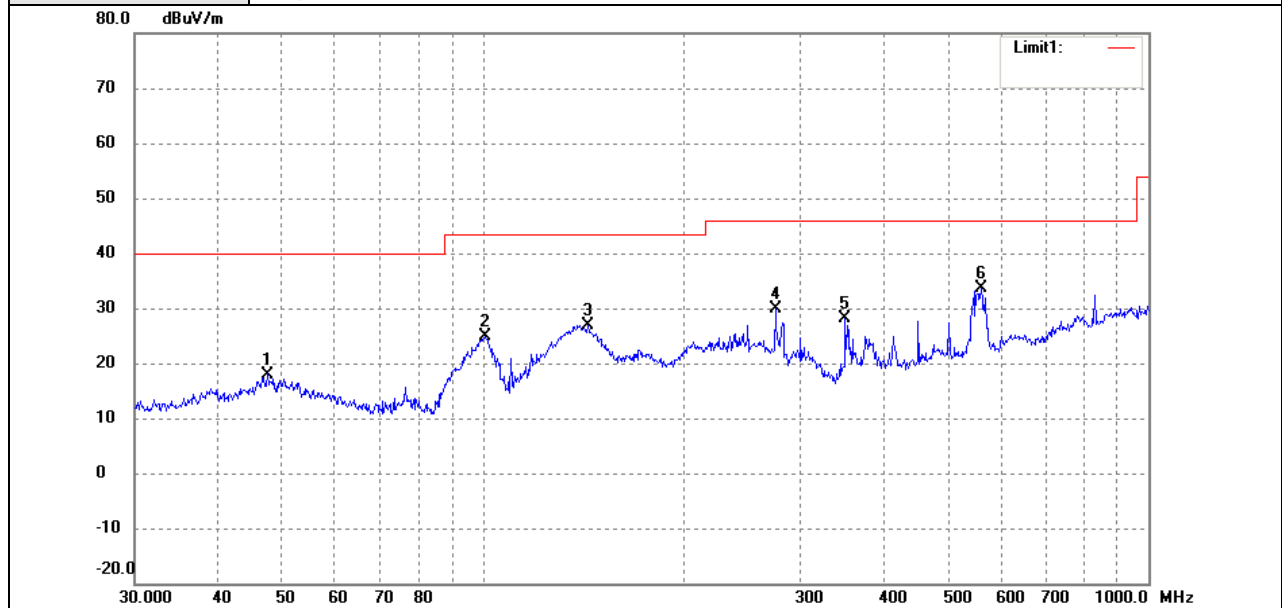

No.	Frequency (MHz)	Reading (dBuV/m)	Correct (dB/m)	Result (dBuV/m)	Limit (dBuV/m)	Margin (dB)	Remark
1	47.4918	28.55	-10.55	18.00	40.00	-22.00	peak
2	100.9339	36.32	-11.51	24.81	43.50	-18.69	peak
3	143.8295	41.68	-14.86	26.82	43.50	-16.68	peak
4	275.1570	39.43	-9.64	29.79	46.00	-16.21	peak
5	350.4768	37.04	-8.80	28.24	46.00	-17.76	peak
6	560.6928	39.43	-5.74	33.69	46.00	-12.31	peak

Remark:
Factor = Antenna Factor + Cable Loss.

EUT :	Notebook	Model Name. :	CW1535
Temperature :	26 °C	Relative Humidity :	56%
Pressure :	1010 hPa	Test Date :	2017-06-23
Test Mode :	WIFI TX Mode (B 2412MHz)	Polarization :	Vertical
Test Power :	AC 120V/ 60Hz		
Remark :	Only show the worse case.		

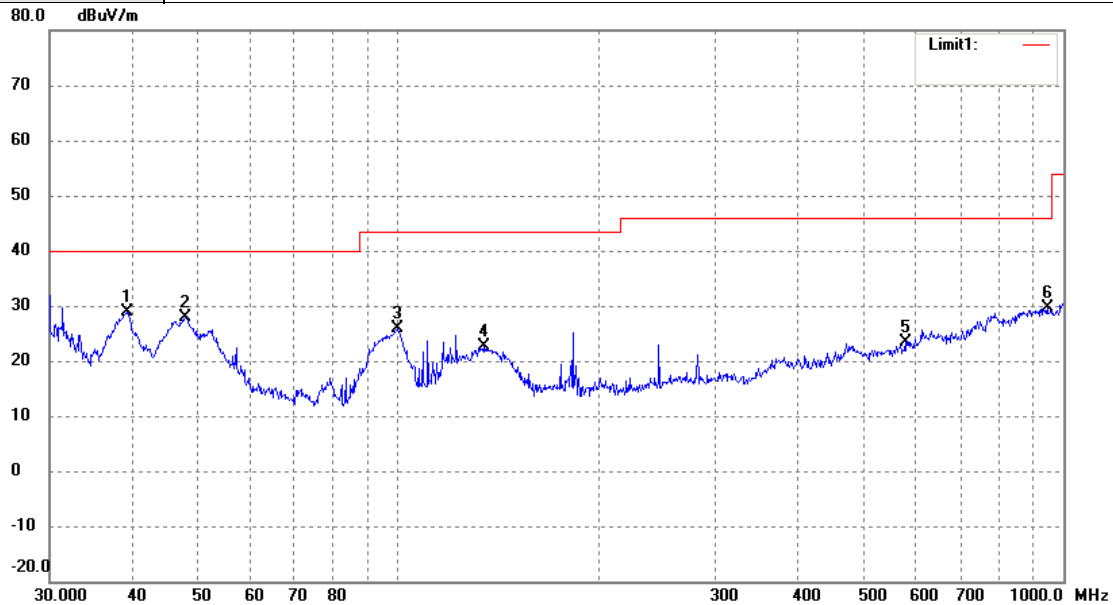

No.	Frequency (MHz)	Reading (dBuV/m)	Correct (dB/m)	Result (dBuV/m)	Limit (dBuV/m)	Margin (dB)	Remark
1	39.1616	42.04	-13.25	28.79	40.00	-11.21	peak
2	47.9940	40.20	-12.32	27.88	40.00	-12.12	peak
3	99.8777	37.25	-11.43	25.82	43.50	-17.68	peak
4	135.0319	37.14	-14.53	22.61	43.50	-20.89	peak
5	578.6699	28.72	-5.22	23.50	46.00	-22.50	peak
6	945.4399	27.52	2.09	29.61	46.00	-16.39	peak

Remark:
Factor = Antenna Factor + Cable Loss.

3.12.3 TEST RESULTS (Above 1GHz)

EUT :	Notebook	Model Name. :	CWI535
Temperature :	26 °C	Relative Humidity :	56%
Test Power :	AC 120V/ 60Hz	Pressure :	1010 hPa
Test Mode :	WIFI TX Mode (B 2412MHz)	Test Date :	2017-06-23

Remark : Only show the worse case.

Freq.	Deceiver Reading	Detector	Polar	Corrected Factor	Emission Level	Limit	Margin
MHz	dBuV	Peak/Avg	H/V	dB	dBuV /m	dBuV /m	dB
4824	59.68	Peak	H	-3.62	56.06	74	-17.94
4824	46.39	Avg	H	-3.62	42.77	54	-11.23
7236	56.06	Peak	H	-0.48	55.58	74	-18.42
7236	42.94	Avg	H	-0.48	42.46	54	-11.54
---	---	Peak	H			74	
---	---	Avg	H			54	
4824	60.63	Peak	V	-3.62	57.01	74	-16.99
4824	47.59	Avg	V	-3.62	43.97	54	-10.03
7236	54.05	Peak	V	-0.48	53.57	74	-20.43
7236	40.83	Avg	V	-0.48	40.35	54	-13.65
---	---	Peak	V			74	
---	---	Avg	V			54	

Remark:

Emission Level= Read Level+ Correct Factor

Margin= Emission Level-Limit

The testing has been conformed to 10th harmonics(1G~25G)

Other harmonics emission are lower then 20dB below the allowable Limit

EUT :	Notebook	Model Name. :	CWI535
Temperature :	26 °C	Relative Humidity :	56%
Test Power :	AC 120V/ 60Hz	Pressure :	1010 hPa
Test Mode :	WIFI TX Mode (B 2437MHz)	Test Date :	2017-06-23

Remark : Only show the worse case.

Freq.	Deceiver Reading	Detector	Polar	Corrected Factor	Emission Level	Limit	Margin
MHz	dBuV	Peak/Avg	H/V	dB	dBuV /m	dBuV /m	dB
4874	59.62	Peak	H	-3.6	56.02	74	-17.98
4874	46.86	Avg	H	-3.6	43.26	54	-10.74
7311	54.93	Peak	H	-0.46	54.47	74	-19.53
7311	41.92	Avg	H	-0.46	41.46	54	-12.54
---	---	Peak	H			74	
---	---	Avg	H			54	

4874	59.06	Peak	V	-3.6	55.46	74	-18.54
4874	45.93	Avg	V	-3.6	42.33	54	-11.67
7311	53.34	Peak	V	-0.46	52.88	74	-21.12
7311	40.79	Avg	V	-0.46	40.33	54	-13.67
---	---	Peak	V			74	
---	---	Avg	V			54	

Remark:

Emission Level= Read Level+ Correct Factor

Margin= Emission Level-Limit

The testing has been conformed to 10th harmonics(1G~25G)

Other harmonics emission are lower then 20dB below the allowable Limit

EUT :	Notebook	Model Name. :	CWI535
Temperature :	26 °C	Relative Humidity :	56%
Test Power :	AC 120V/ 60Hz	Pressure :	1010 hPa
Test Mode :	WIFI TX Mode (B 2462MHz)	Test Date :	2017-06-23

Remark : Only show the worse case.

Freq.	Deceiver Reading	Detector	Polar	Corrected Factor	Emission Level	Limit	Margin
MHz	dBuV	Peak/Avg	H/V	dB	dBuV /m	dBuV /m	dB
4924	59.74	Peak	H	-3.59	56.15	74	-17.85
4924	47.27	Avg	H	-3.59	43.68	54	-10.32
7386	55.00	Peak	H	-0.43	54.57	74	-19.43
7386	42.40	Avg	H	-0.43	41.97	54	-12.03
---	---	Peak	H			74	
---	---	Avg	H			54	

4924	59.57	Peak	V	-3.59	55.98	74	-18.02
4924	45.14	Avg	V	-3.59	41.55	54	-12.45
7386	54.10	Peak	V	-0.43	53.67	74	-20.33
7386	40.81	Avg	V	-0.43	40.38	54	-13.62
---	---	Peak	V			74	
---	---	Avg	V			54	

Remark:

Emission Level= Read Level+ Correct Factor

Margin= Emission Level-Limit

The testing has been conformed to 10th harmonics(1G~25G)

Other harmonics emission are lower then 20dB below the allowable Limit

EUT :	Notebook	Model Name. :	CWI535
Temperature :	26 °C	Relative Humidity :	56%
Test Power :	AC 120V/ 60Hz	Pressure :	1010 hPa
Test Mode :	WIFI TX Mode (G 2412MHz)	Test Date :	2017-06-23

Remark : Only show the worse case.

Freq.	Deceiver Reading	Detector	Polar	Corrected Factor	Emission Level	Limit	Margin
MHz	dBuV	Peak/Avg	H/V	dB	dBuV /m	dBuV /m	dB
4824	60.08	Peak	H	-3.62	56.46	74	-17.54
4824	47.19	Avg	H	-3.62	43.57	54	-10.43
7236	55.24	Peak	H	-0.48	54.76	74	-19.24
7236	42.14	Avg	H	-0.48	41.66	54	-12.34
---	---	Peak	H			74	
---	---	Avg	H			54	

4824	59.09	Peak	V	-3.62	55.47	74	-18.53
4824	45.88	Avg	V	-3.62	42.26	54	-11.74
7236	54.10	Peak	V	-0.48	53.62	74	-20.38
7236	40.56	Avg	V	-0.48	40.08	54	-13.92
---	---	Peak	V			74	
---	---	Avg	V			54	

Remark:

Emission Level= Read Level+ Correct Factor

Margin= Emission Level-Limit

The testing has been conformed to 10th harmonics(1G~25G)

Other harmonics emission are lower then 20dB below the allowable Limit

EUT :	Notebook	Model Name. :	CWI535
Temperature :	26 °C	Relative Humidity :	56%
Test Power :	AC 120V/ 60Hz	Pressure :	1010 hPa
Test Mode :	WIFI TX Mode (G 2437MHz)	Test Date :	2017-06-23

Remark : Only show the worse case.

Freq.	Deceiver Reading	Detector	Polar	Corrected Factor	Emission Level	Limit	Margin
MHz	dBuV	Peak/Avg	H/V	dB	dBuV /m	dBuV /m	dB
4874	60.77	Peak	H	-3.6	57.17	74	-16.83
4874	48.17	Avg	H	-3.6	44.57	54	-9.43
7311	53.02	Peak	H	-0.46	52.56	74	-21.44
7311	40.68	Avg	H	-0.46	40.22	54	-13.78
---	---	Peak	H			74	
---	---	Avg	H			54	

4874	60.28	Peak	V	-3.6	56.68	74	-17.32
4874	46.96	Avg	V	-3.6	43.36	54	-10.64
7311	55.03	Peak	V	-0.46	54.57	74	-19.43
7311	42.01	Avg	V	-0.46	41.55	54	-12.45
---	---	Peak	V			74	
---	---	Avg	V			54	

Remark:

Emission Level= Read Level+ Correct Factor

Margin= Emission Level-Limit

The testing has been conformed to 10th harmonics(1G~25G)

Other harmonics emission are lower then 20dB below the allowable Limit

EUT :	Notebook	Model Name. :	CWI535
Temperature :	26 °C	Relative Humidity :	56%
Test Power :	AC 120V/ 60Hz	Pressure :	1010 hPa
Test Mode :	WIFI TX Mode (G 2462MHz)	Test Date :	2017-06-23

Remark : Only show the worse case.

Freq.	Deceiver Reading	Detector	Polar	Corrected Factor	Emission Level	Limit	Margin
MHz	dBuV	Peak/Avg	H/V	dB	dBuV /m	dBuV /m	dB
4924	60.14	Peak	H	-3.59	56.55	74	-17.45
4924	46.70	Avg	H	-3.59	43.11	54	-10.89
7386	54.66	Peak	H	-0.43	54.23	74	-19.77
7386	41.89	Avg	H	-0.43	41.46	54	-12.54
---	---	Peak	H			74	
---	---	Avg	H			54	

4924	59.16	Peak	V	-3.59	55.57	74	-18.43
4924	44.83	Avg	V	-3.59	41.24	54	-12.76
7386	54.96	Peak	V	-0.43	54.53	74	-19.47
7386	42.48	Avg	V	-0.43	42.05	54	-11.95
---	---	Peak	V			74	
---	---	Avg	V			54	

Remark:

Emission Level= Read Level+ Correct Factor

Margin= Emission Level-Limit

The testing has been conformed to 10th harmonics(1G~25G)

Other harmonics emission are lower then 20dB below the allowable Limit

EUT :	Notebook	Model Name. :	CWI535
Temperature :	26 °C	Relative Humidity :	56%
Test Power :	AC 120V/ 60Hz	Pressure :	1010 hPa
Test Mode :	WIFI TX Mode (N20 2412MHz)	Test Date :	2017-06-23

Remark : Only show the worse case.

Freq.	Deceiver Reading	Detector	Polar	Corrected Factor	Emission Level	Limit	Margin
MHz	dBuV	Peak/Avg	H/V	dB	dBuV /m	dBuV /m	dB
4824	58.19	Peak	H	-3.62	54.57	74	-19.43
4824	45.08	Avg	H	-3.62	41.46	54	-12.54
7236	52.94	Peak	H	-0.48	52.46	74	-21.54
7236	40.16	Avg	H	-0.48	39.68	54	-14.32
---	---	Peak	H			74	
---	---	Avg	H			54	
4824	58.69	Peak	V	-3.62	55.07	74	-18.93
4824	46.26	Avg	V	-3.62	42.64	54	-11.36
7236	53.91	Peak	V	-0.48	53.43	74	-20.57
7236	40.76	Avg	V	-0.48	40.28	54	-13.72
---	---	Peak	V			74	
---	---	Avg	V			54	

Remark:

Emission Level= Read Level+ Correct Factor

Margin= Emission Level-Limit

The testing has been conformed to 10th harmonics(1G~25G)

Other harmonics emission are lower then 20dB below the allowable Limit

EUT :	Notebook	Model Name. :	CWI535
Temperature :	26 °C	Relative Humidity :	56%
Test Power :	AC 120V/ 60Hz	Pressure :	1010 hPa
Test Mode :	WIFI TX Mode (N20 2437MHz)	Test Date :	2017-06-23

Remark : Only show the worse case .

Freq.	Deceiver Reading	Detector	Polar	Corrected Factor	Emission Level	Limit	Margin
MHz	dBuV	Peak/Avg	H/V	dB	dBuV /m	dBuV /m	dB
4874	58.25	Peak	H	-3.6	54.65	74	-19.35
4874	45.46	Avg	H	-3.6	41.86	54	-12.14
7311	53.78	Peak	H	-0.46	53.32	74	-20.68
7311	37.04	Avg	H	-0.46	36.58	54	-17.42
---	---	Peak	H			74	
---	---	Avg	H			54	

4874	57.27	Peak	V	-3.6	53.67	74	-20.33
4874	44.03	Avg	V	-3.6	40.43	54	-13.57
7311	51.82	Peak	V	-0.46	51.36	74	-22.64
7311	38.82	Avg	V	-0.46	38.36	54	-15.64
---	---	Peak	V			74	
---	---	Avg	V			54	

Remark:

Emission Level= Read Level+ Correct Factor

Margin= Emission Level-Limit

The testing has been conformed to 10th harmonics(1G~25G)

Other harmonics emission are lower then 20dB below the allowable Limit

EUT :	Notebook	Model Name. :	CWI535
Temperature :	26 °C	Relative Humidity :	56%
Test Power :	AC 120V/ 60Hz	Pressure :	1010 hPa
Test Mode :	WIFI TX Mode (N20 2462MHz)	Test Date :	2017-06-23

Remark : Only show the worse case .

Freq.	Deceiver Reading	Detector	Polar	Corrected Factor	Emission Level	Limit	Margin
MHz	dBuV	Peak/Avg	H/V	dB	dBuV /m	dBuV /m	dB
4924	59.24	Peak	H	-3.59	55.65	74	-18.35
4924	46.03	Avg	H	-3.59	42.44	54	-11.56
7386	53.98	Peak	H	-0.43	53.55	74	-20.45
7386	41.49	Avg	H	-0.43	41.06	54	-12.94
---	---	Peak	H			74	
---	---	Avg	H			54	

4924	57.76	Peak	V	-3.59	54.17	74	-19.83
4924	44.85	Avg	V	-3.59	41.26	54	-12.74
7386	52.89	Peak	V	-0.43	52.46	74	-21.54
7386	39.79	Avg	V	-0.43	39.36	54	-14.64
---	---	Peak	V			74	
---	---	Avg	V			54	

Remark:

Emission Level= Read Level+ Correct Factor

Margin= Emission Level-Limit

The testing has been conformed to 10th harmonics(1G~25G)

Other harmonics emission are lower then 20dB below the allowable Limit

EUT :	Notebook	Model Name. :	CWI535
Temperature :	26 °C	Relative Humidity :	56%
Test Power :	AC 120V/ 60Hz	Pressure :	1010 hPa
Test Mode :	WIFI TX Mode (N40 2422MHz)	Test Date :	2017-06-23

Remark : Only show the worse case.

Freq.	Deceiver Reading	Detector	Polar	Corrected Factor	Emission Level	Limit	Margin
MHz	dBuV	Peak/Avg	H/V	dB	dBuV /m	dBuV /m	dB
4844	59.08	Peak	H	-3.62	55.46	74	-18.54
4844	44.98	Avg	H	-3.62	41.36	54	-12.64
7266	54.02	Peak	H	-0.48	53.54	74	-20.46
7266	41.24	Avg	H	-0.48	40.76	54	-13.24
---	---	Peak	H			74	
---	---	Avg	H			54	
4844	58.3	Peak	V	-3.62	54.68	74	-19.32
4844	45.09	Avg	V	-3.62	41.47	54	-12.53
7266	53.95	Peak	V	-0.48	53.47	74	-20.53
7266	41.79	Avg	V	-0.48	41.31	54	-12.69
---	---	Peak	V			74	
---	---	Avg	V			54	

Remark:

Emission Level= Read Level+ Correct Factor

Margin= Emission Level-Limit

The testing has been conformed to 10th harmonics(1G~25G)

Other harmonics emission are lower then 20dB below the allowable Limit

EUT :	Notebook	Model Name. :	CWI535
Temperature :	26 °C	Relative Humidity :	56%
Test Power :	AC 120V/ 60Hz	Pressure :	1010 hPa
Test Mode :	WIFI TX Mode (N40 2437MHz)	Test Date :	2017-06-23

Remark : Only show the worse case .

Freq.	Deceiver Reading	Detector	Polar	Corrected Factor	Emission Level	Limit	Margin
MHz	dBuV	Peak/Avg	H/V	dB	dBuV /m	dBuV /m	dB
4874	58.96	Peak	H	-3.6	55.36	74	-18.64
4874	47.29	Avg	H	-3.6	43.69	54	-10.31
7311	54.03	Peak	H	-0.46	53.57	74	-20.43
7311	41.7	Avg	H	-0.46	41.24	54	-12.76
---	---	Peak	H			74	
---	---	Avg	H			54	

4874	58.17	Peak	V	-3.6	54.57	74	-19.43
4874	46.28	Avg	V	-3.6	42.68	54	-11.32
7311	52.92	Peak	V	-0.46	52.46	74	-21.54
7311	40.09	Avg	V	-0.46	39.63	54	-14.37
---	---	Peak	V			74	
---	---	Avg	V			54	

Remark:

Emission Level= Read Level+ Correct Factor

Margin= Emission Level-Limit

The testing has been conformed to 10th harmonics(1G~25G)

Other harmonics emission are lower then 20dB below the allowable Limit

EUT :	Notebook	Model Name. :	CWI535
Temperature :	26 °C	Relative Humidity :	56%
Test Power :	AC 120V/ 60Hz	Pressure :	1010 hPa
Test Mode :	WIFI TX Mode (N40 2452MHz)	Test Date :	2017-06-23

Remark : Only show the worse case .

Freq.	Deceiver Reading	Detector	Polar	Corrected Factor	Emission Level	Limit	Margin
MHz	dBuV	Peak/Avg	H/V	dB	dBuV /m	dBuV /m	dB
4904	59.14	Peak	H	-3.59	55.55	74	-18.45
4904	46.05	Avg	H	-3.59	42.46	54	-11.54
7356	53.89	Peak	H	-0.43	53.46	74	-20.54
7356	42.05	Avg	H	-0.43	41.62	54	-12.38
---	---	Peak	H			74	
---	---	Avg	H			54	

4904	59.13	Peak	V	-3.59	55.54	74	-18.46
4904	45.55	Avg	V	-3.59	41.96	54	-12.04
7356	54.54	Peak	V	-0.43	54.11	74	-19.89
7356	42.98	Avg	V	-0.43	42.55	54	-11.45
---	---	Peak	V			74	
---	---	Avg	V			54	

Remark:

Emission Level= Read Level+ Correct Factor

Margin= Emission Level-Limit

The testing has been conformed to 10th harmonics(1G~25G)

Other harmonics emission are lower then 20dB below the allowable Limit

4. MAXIMUM CONDUCTED OUTPUT POWER MEASUREMENT

4.1 LIMITS

FCC Part 15.247, subpart C/ RSS 247 Section 5.4(4)	
Frequency Range (MHz)	2400~2483.5
Limits	30

4.2 TEST PROCEDURE

The measurement is according to section 9.1.2 of FCC KDB 558074 D01 DTS Meas Guidance v04.

The EUT was directly connected to the power meter and antenna output port as show in the block diagram as bellow.

4.3 TEST SETUP

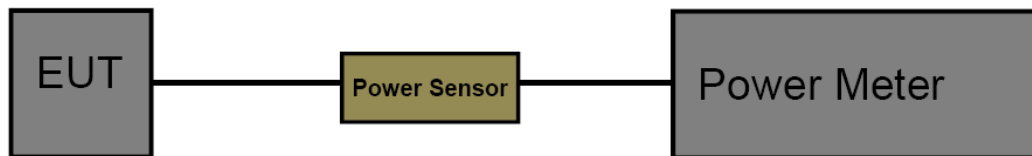

4.4 TEST INSTRUMENTS

Equipment	Manufacturer	Type No.	Serial No.	Last calibration	Calibrated until	Calibration period
P-Series Power Meter	Agilent	N1911A	MY45100482	Jul. 04, 2016	Jul. 03. 2017	1 year
Wideband Power Sensor	Agilent	N1921A	MY51200145	Jul. 04, 2016	Jul. 03. 2017	1 year

4.5 EUT OPERATING CONDITIONS

The EUT was set to continuously transmitting in the maximum power during the test.

4.6 TEST RESULTS

2.4 G Band Conducted Power			
802.11b Power			
Channel	Frequency	Conducted Power (dBm)	Max. Limit (dBm)
1	2412 MHz	9.32	30
6	2437 MHz	9.21	
11	2462 MHz	9.25	
802.11g Power			
Channel	Frequency	Conducted Power (dBm)	Max. Limit (dBm)
1	2412 MHz	9.18	30
6	2437 MHz	9.19	
11	2462 MHz	9.17	
802.11n(HT20) Power			
Channel	Frequency	Conducted Power (dBm)	Max. Limit (dBm)
1	2412 MHz	9.03	30
6	2437 MHz	9.05	
11	2462 MHz	9.09	
802.11n(HT40) Power			
Channel	Frequency	Conducted Power (dBm)	Max. Limit (dBm)
3	2422 MHz	9.01	30
6	2437 MHz	8.99	
9	2452 MHz	8.97	

5. OCCUPIED BANDWIDTH MEASUREMENT

5.1 LIMITS

FCC Part 15.247, subpart C/ RSS 247 Section 5.2(1)	
Frequency Range (MHz)	2400~2483.5
Limits	6 dB Bandwidth>500 KHz

5.2 TEST PROCEDURE

The EUT was directly connected to the power meter and antenna output port as show in the block diagram as bellow.

Spectrum Parameters	Setting
Attenuation	Auto
Span	>6 dB Bandwidth
RBW	100 kHz
VBW	$\geq 3\text{RBW}$
Detector	Peak
Trace	Max Hold
Sweep Time	Auto

5.3 TEST SETUP

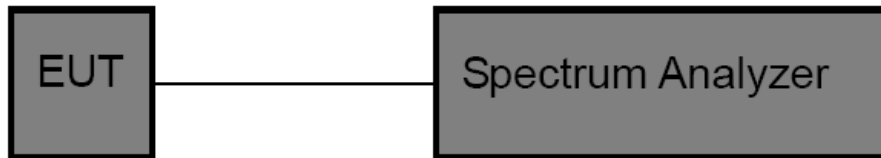

5.4 TEST INSTRUMENTS

Equipment	Manufacturer	Type No.	Serial No.	Last calibration	Calibrated until	Calibration period
Spectrum Analyzer	R&S	FSP40	100154	Jul. 04, 2016	Jul. 03. 2017	1 year
Spectrum Analyzer	Agilent	E4407B	MY41440432	Jul. 04, 2016	Jul. 03. 2017	1 year

5.5 EUT OPERATING CONDITIONS

The EUT was set to continuously transmitting in the maximum power during the test.

5.6 TEST RESULTS

801.11b Mode			
Frequency (MHz)	6dB Bandwidth (MHz)	99% OBW (MHz)	Limit
2412	9.101	14.5285	≥500 kHz
2437	8.586	13.9003	
2462	8.063	13.4579	

B Mode 2412 MHz

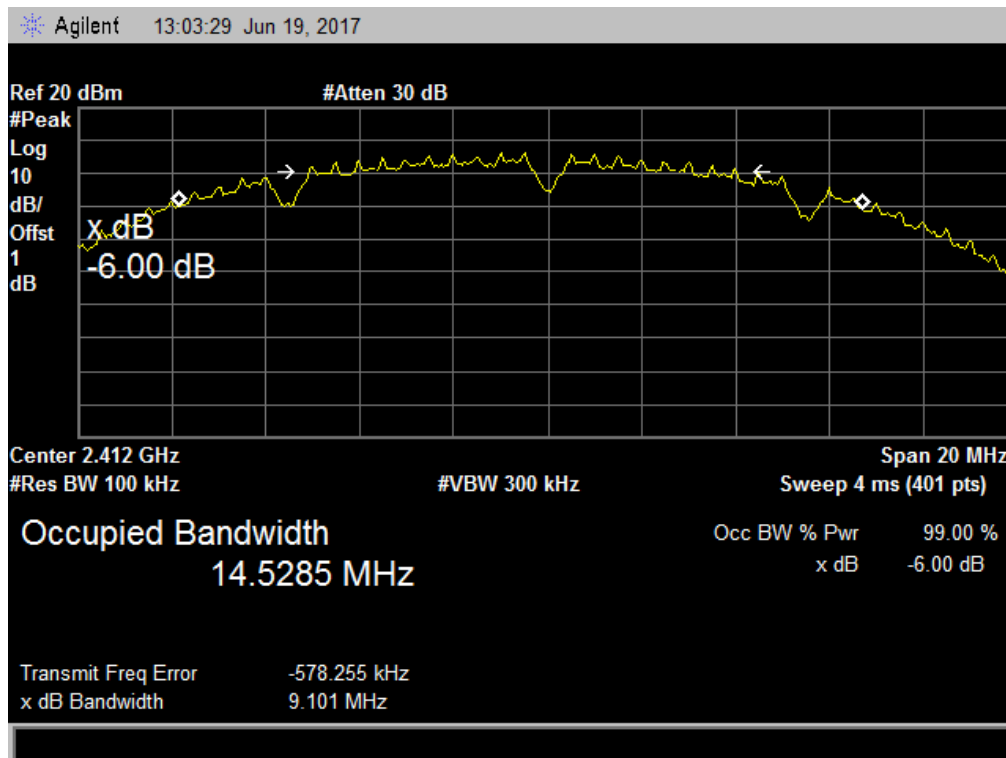

B Mode 2437 MHz

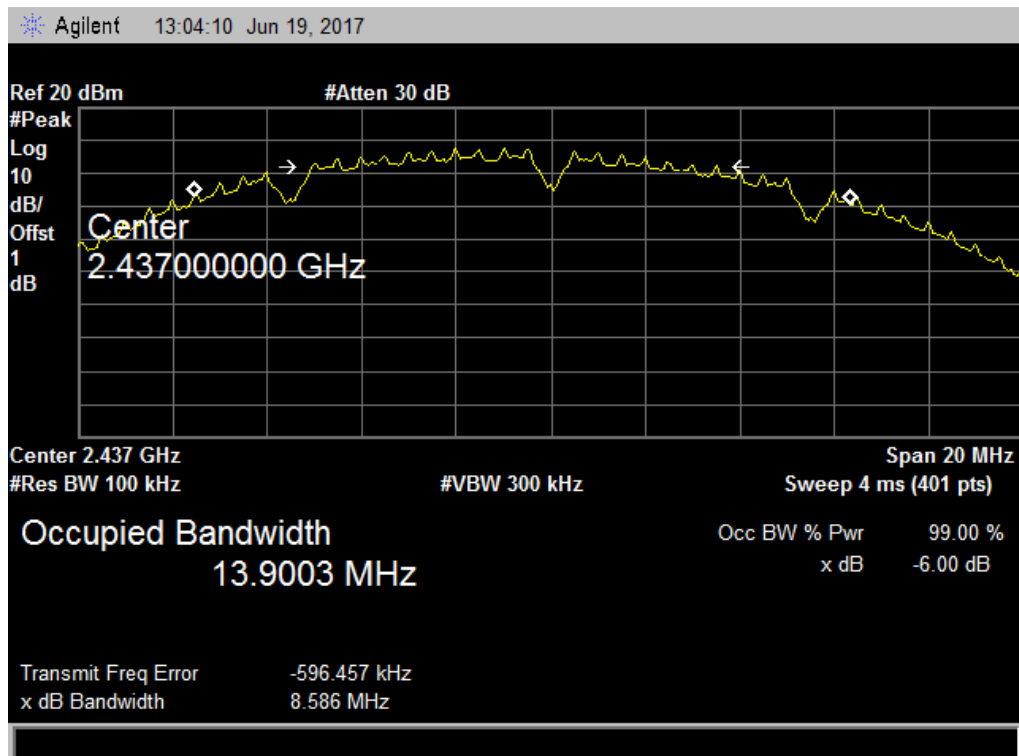

B Mode 2462 MHz

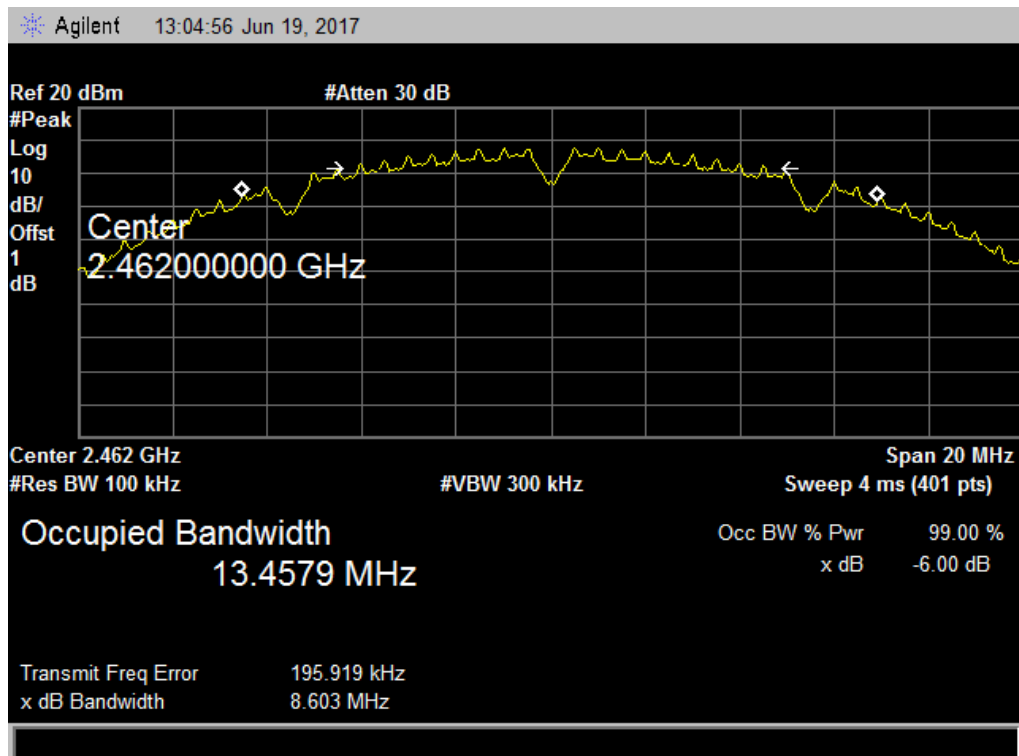

801.11g Mode			
Frequency (MHz)	6dB Bandwidth (MHz)	99% OBW (MHz)	Limit
2412	16.413	16.4593	≥500 kHz
2437	16.489	16.4842	
2462	16.456	16.4490	

G Mode 2412 MHz

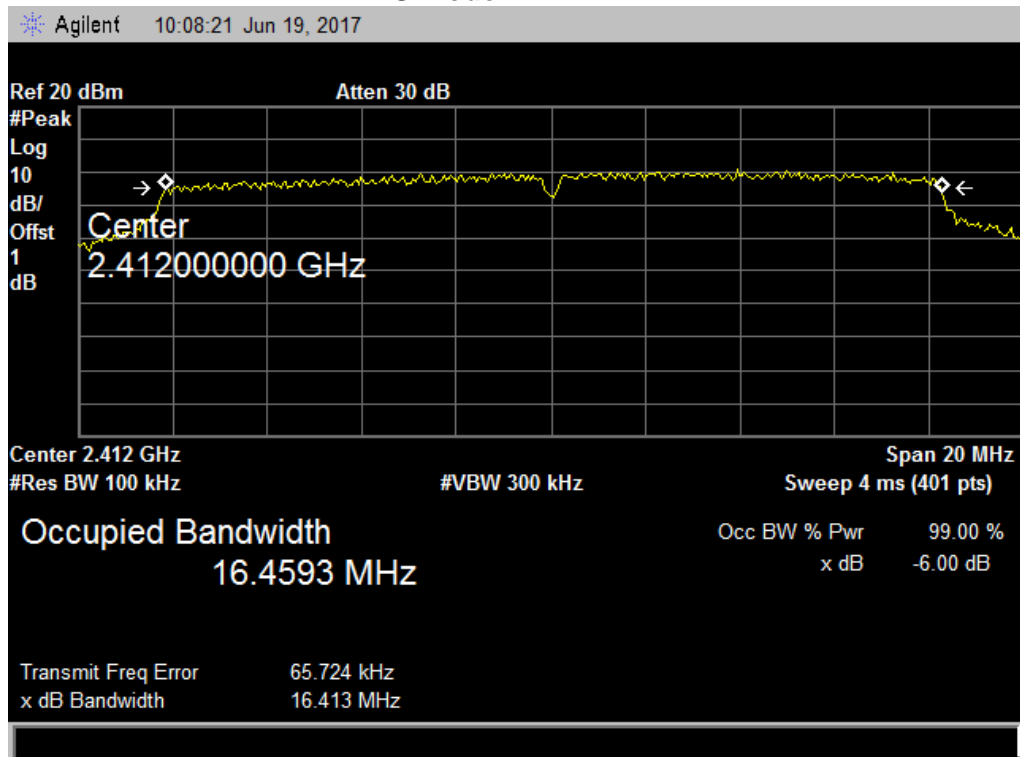

G Mode 2437 MHz

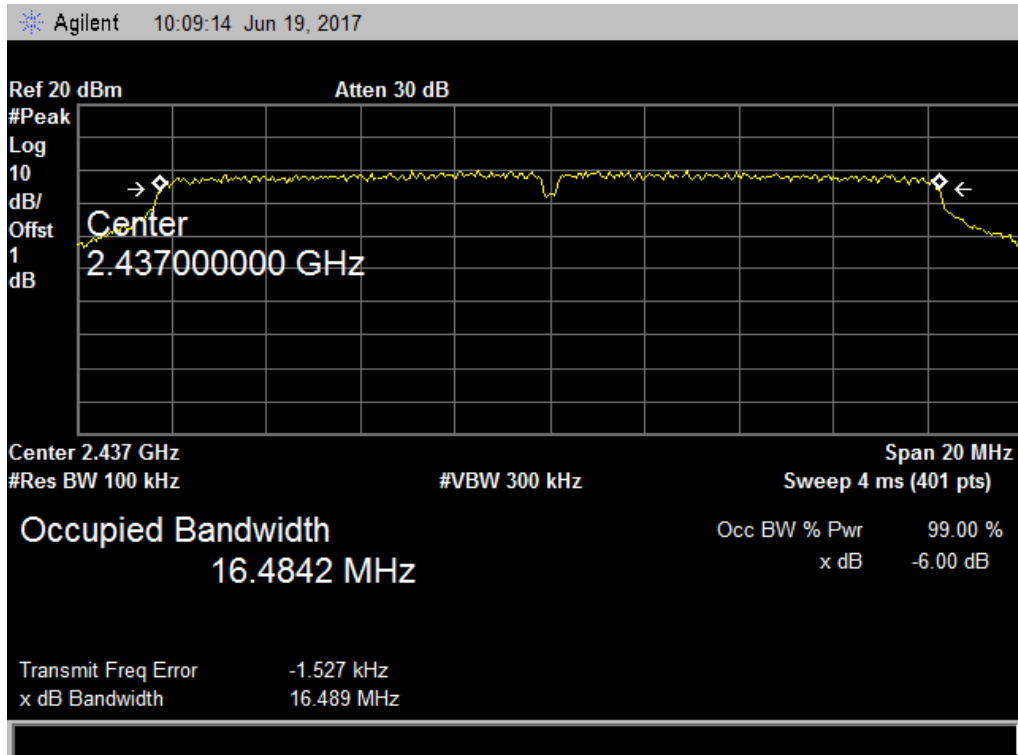

G Mode 2462 MHz

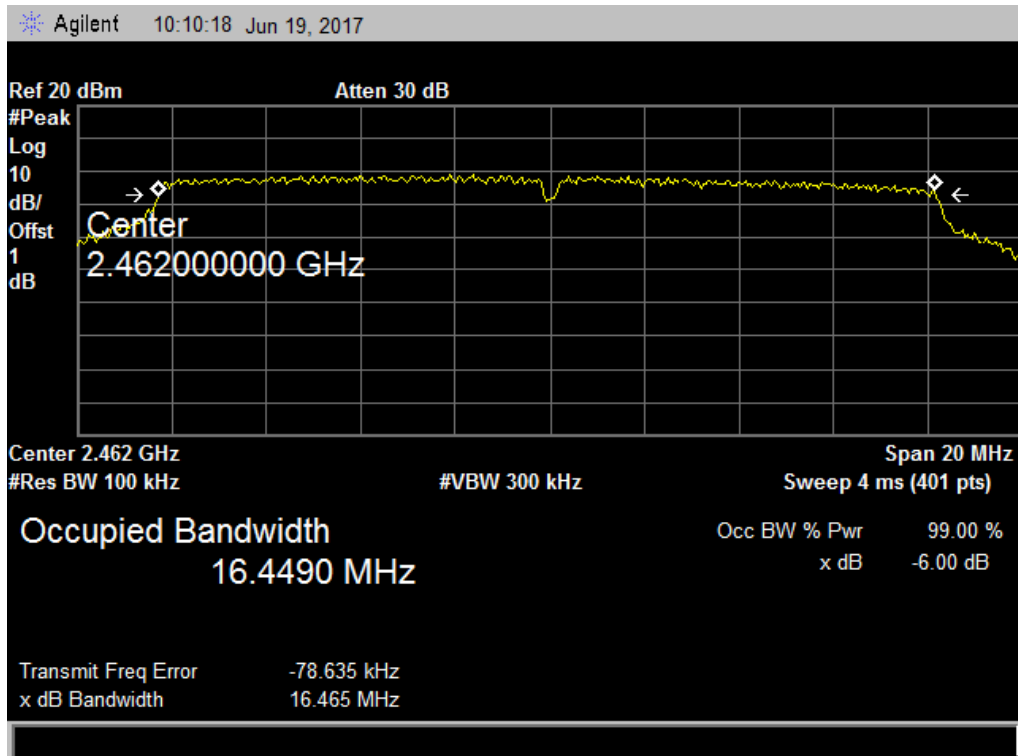

801.11n(HT20) Mode			
Frequency (MHz)	6dB Bandwidth (MHz)	99% OBW (MHz)	Limit
2412	17.706	17.6051	>=500 kHz
2437	17.776	17.6262	
2462	17.723	17.6084	

N20 Mode 2412 MHz

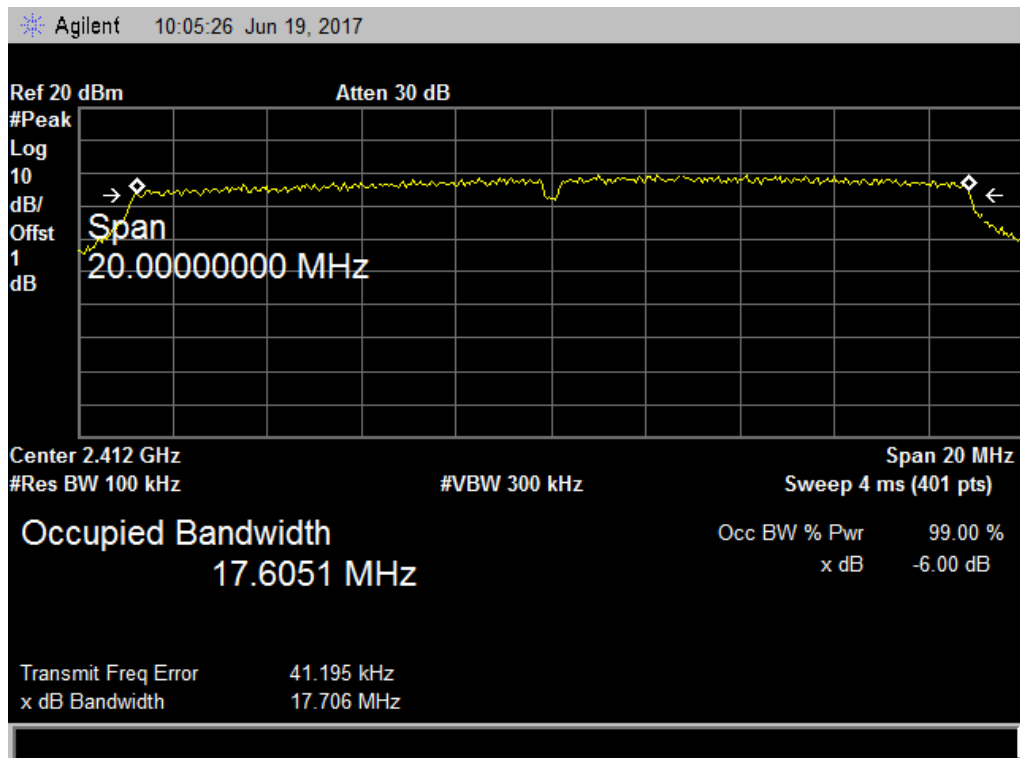

N20 Mode 2437 MHz

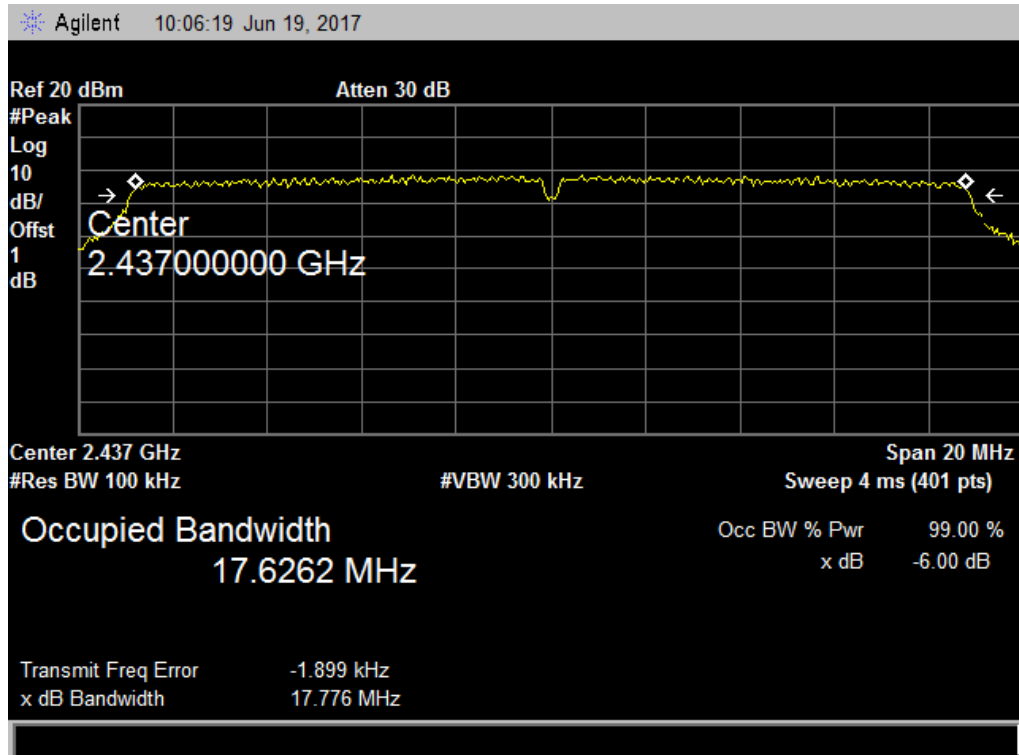

N20 Mode 2462 MHz

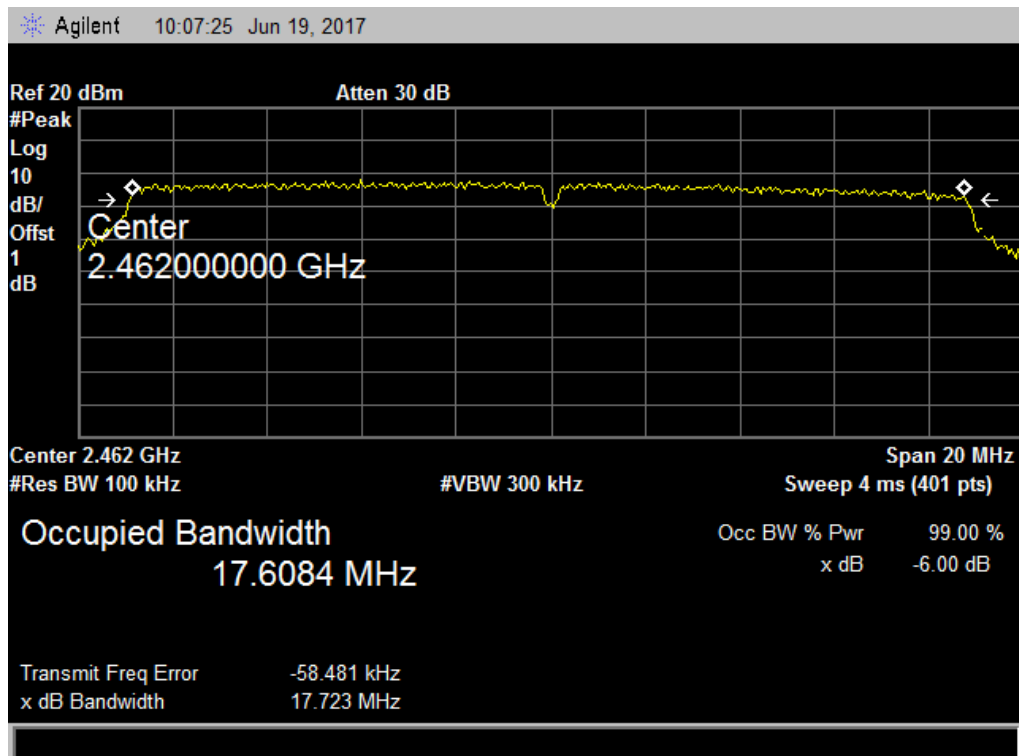

801.11n(HT40) Mode			
Frequency (MHz)	6dB Bandwidth (MHz)	99% OBW (MHz)	Limit
2422	35.700	35.7883	>=500 kHz
2437	36.488	35.9824	
2452	35.256	35.7727	

N40 Mode 2422 MHz

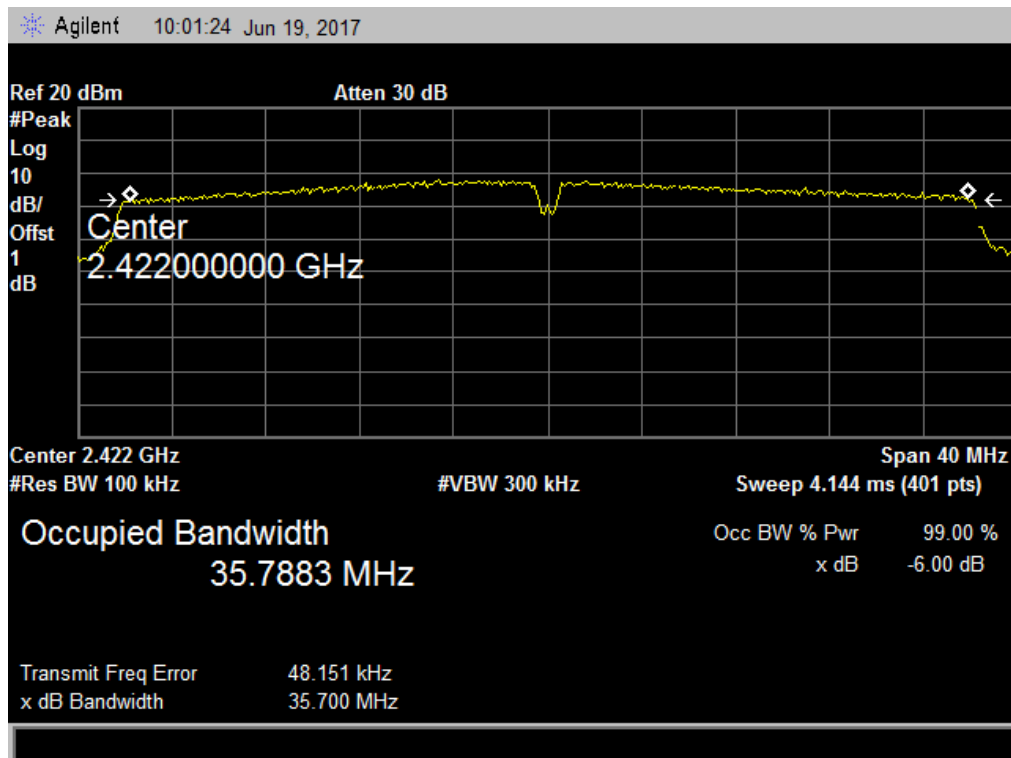

N40 Mode 2437 MHz

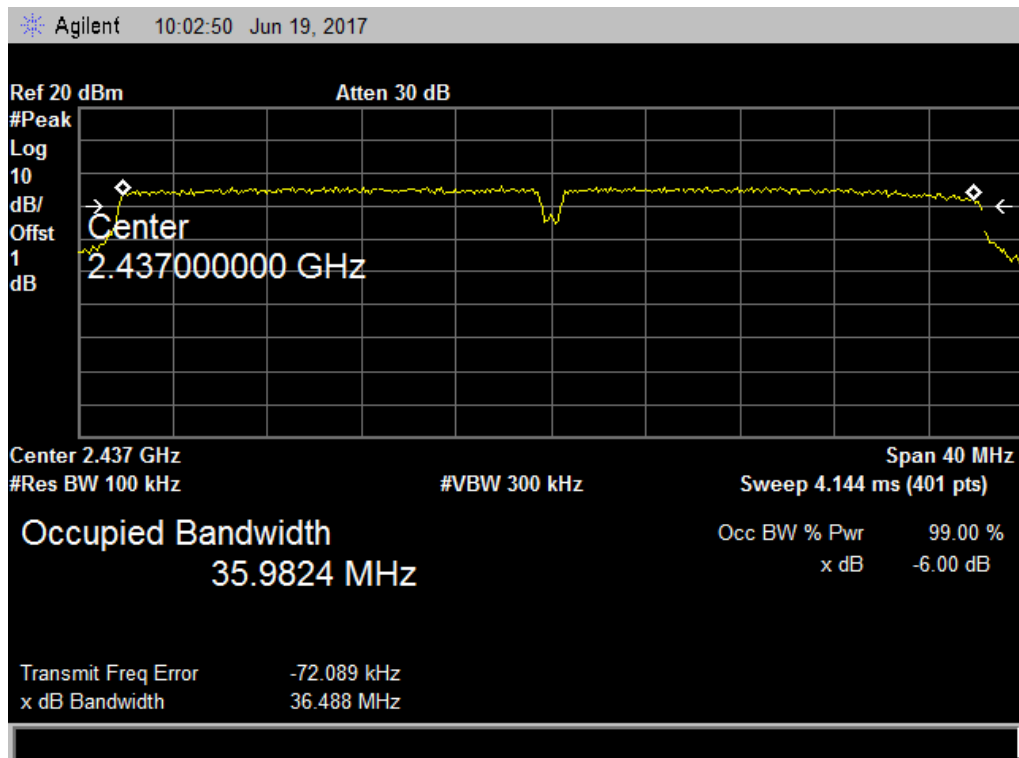

N40 Mode 2452 MHz

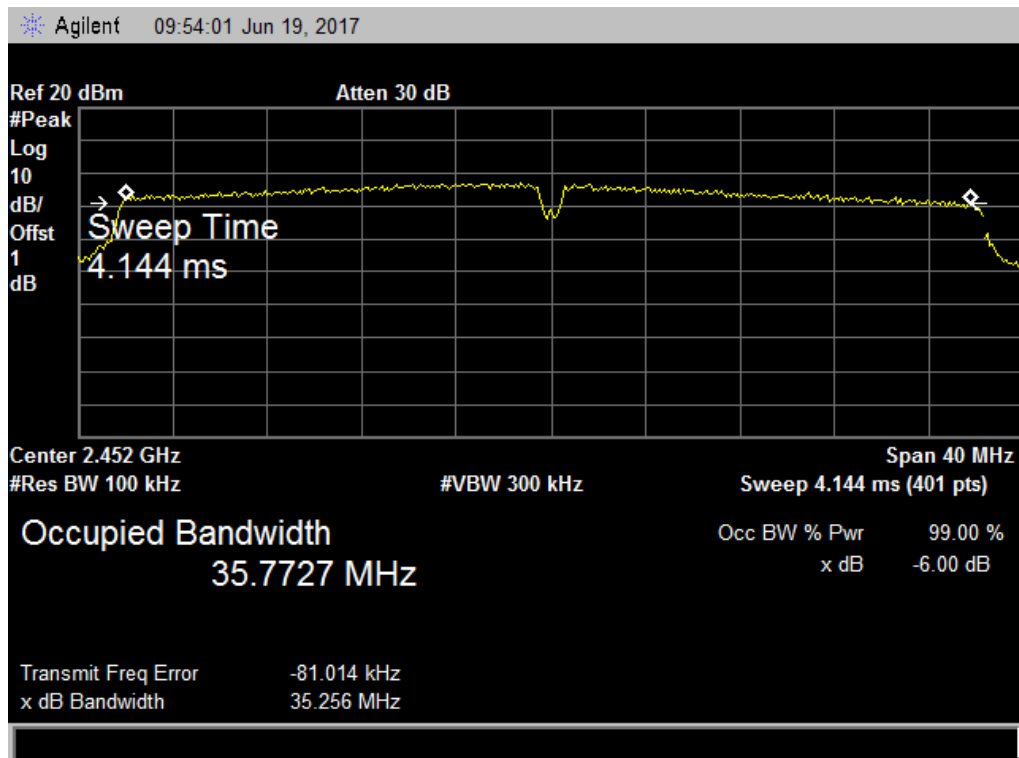

6. POWER SPECTRAL DENSITY

6.1 LIMITS

FCC Part 15.247, Subpart C/ RSS 247 Section 5.2(2)	
Frequency Range (MHz)	2400~2483.5
99% Occupied Bandwidth	8 dBm in any 3 kHz

6.2 TEST PROCEDURE

The EUT was directly connected to the power meter and antenna output port as show in the block diagram as bellow.

Spectrum Parameters	Setting
Attenuation	Auto
Span	Set the span to 1.5 times the DTS channel bandwidth
RBW	3 kHz
VBW	$\geq 3\text{RBW}$
Detector	Reak
Trace	Max Hold
Sweep Time	Auto

6.3 TEST SETUP

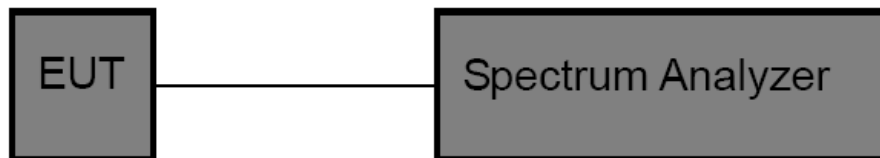

6.4 TEST INSTRUMENTS

Equipment	Manufacturer	Type No.	Serial No.	Last calibration	Calibrated until	Calibration period
Spectrum Analyzer	R&S	FSP40	100154	Jul. 04, 2015	Jul. 03. 2017	1 year
Spectrum Analyzer	Agilent	E4407B	MY41440432	Jul. 04, 2016	Jul. 03. 2017	1 year

6.5 EUT OPERATING CONDITIONS

The EUT was set to continuously transmitting in the maximum power during the test.

6.6 TEST RESULTS

801.11b Mode			
Frequency (MHz)	Power Density (3 kHz/dBm)	Limit (dBm/3KHz)	Result
2412	-10.64	8	Pass
2437	-10.48		
2462	-11.38		

B Mode 2412 MHz

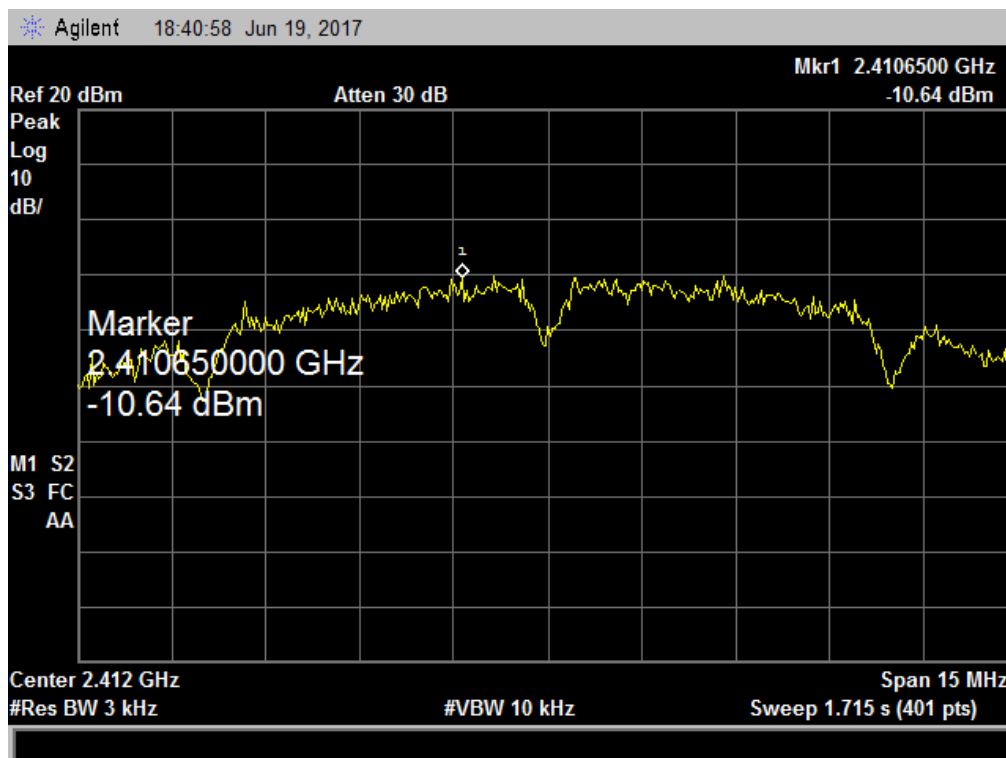

B Mode 2437 MHz

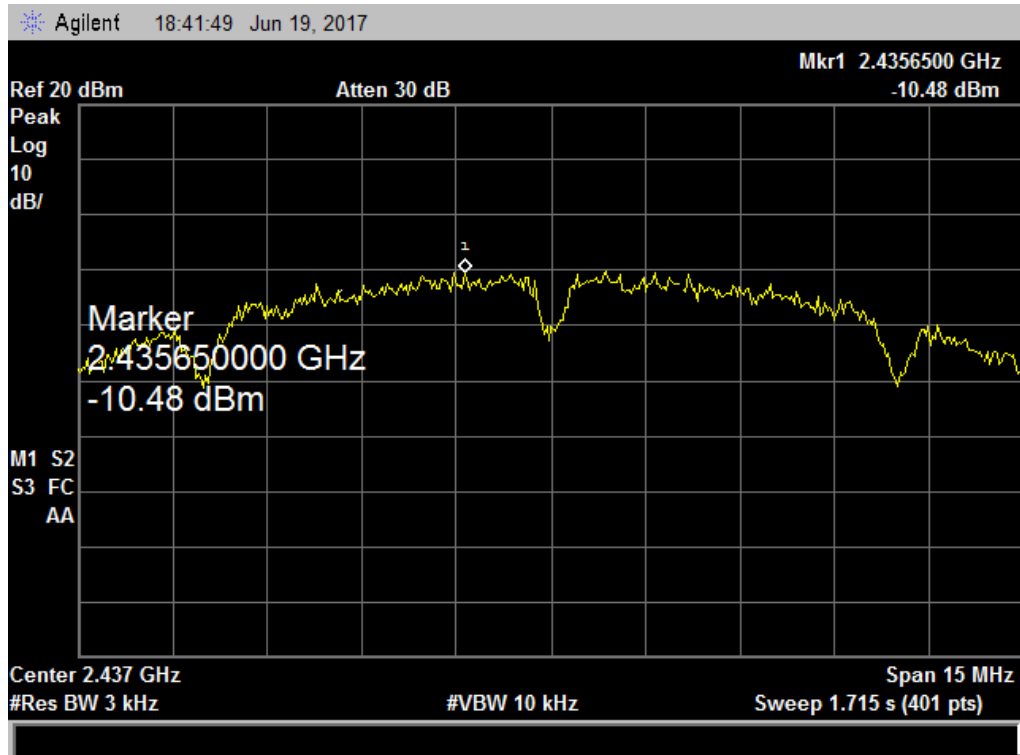

B Mode 2462 MHz

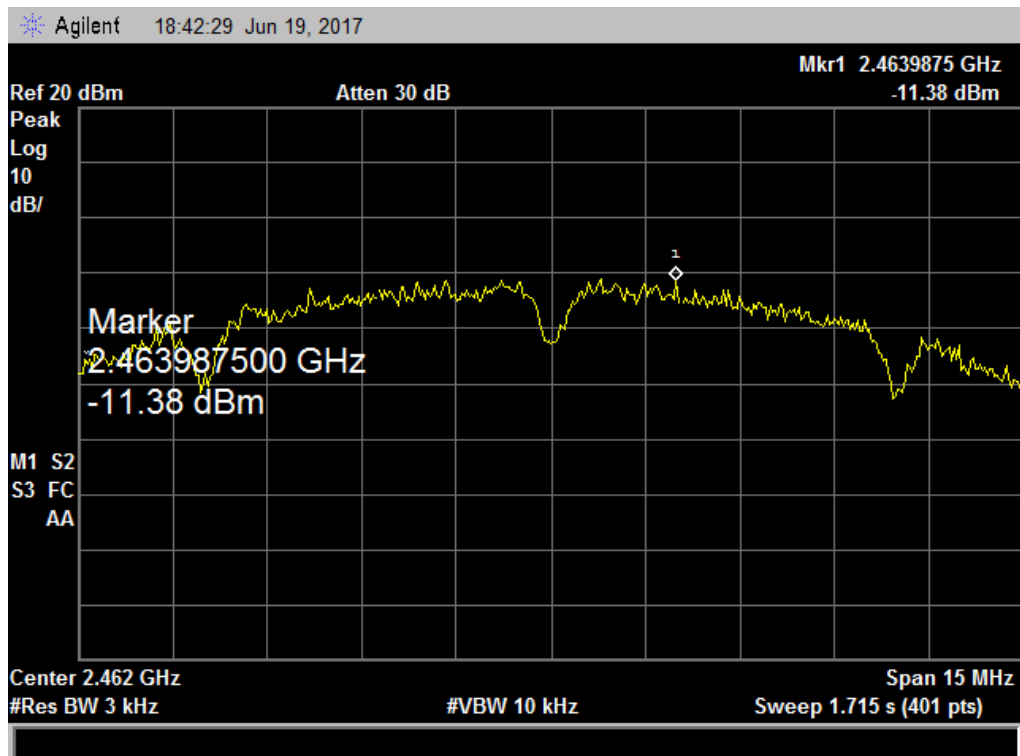

801.11g Mode			
Frequency (MHz)	Power Density (3 kHz/dBm)	Limit (dBm/3KHz)	Result
2412	-9.949	8	Pass
2437	-10.89		
2462	-8.549		

G Mode 2412 MHz

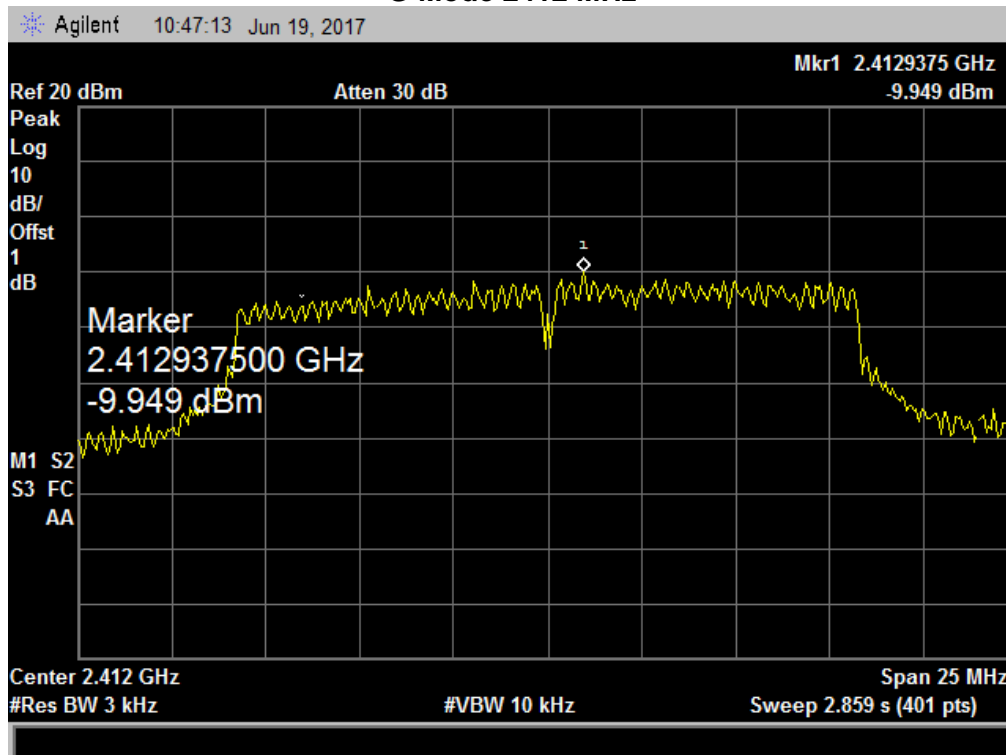

G Mode 2437 MHz

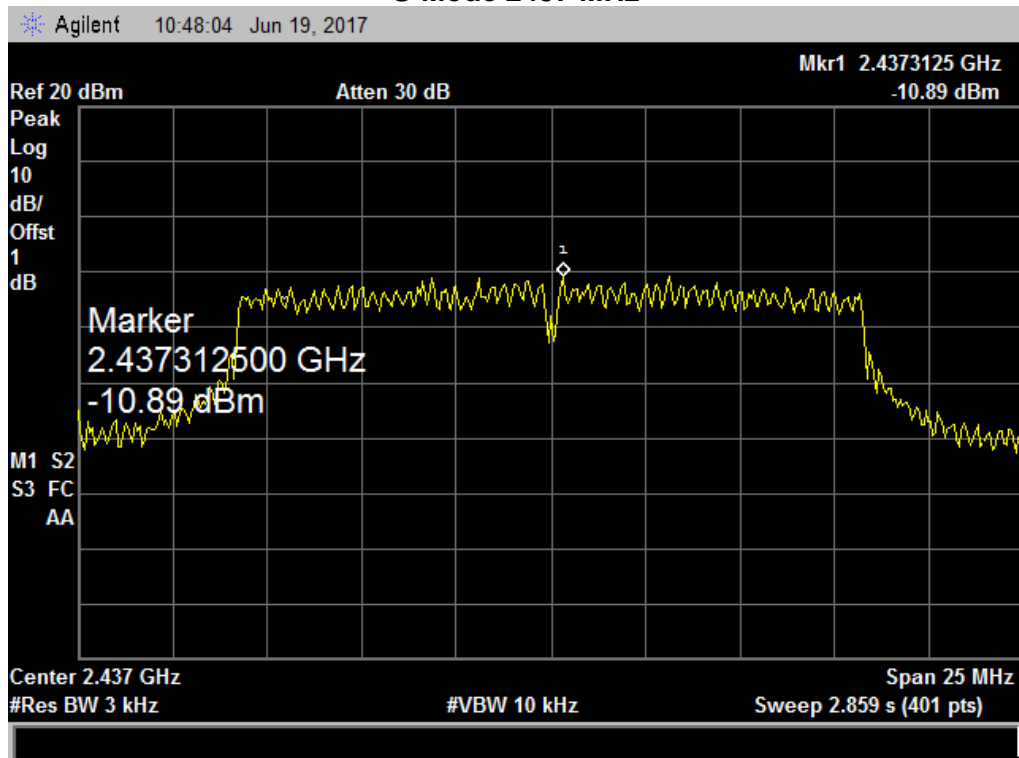

G Mode 2462 MHz

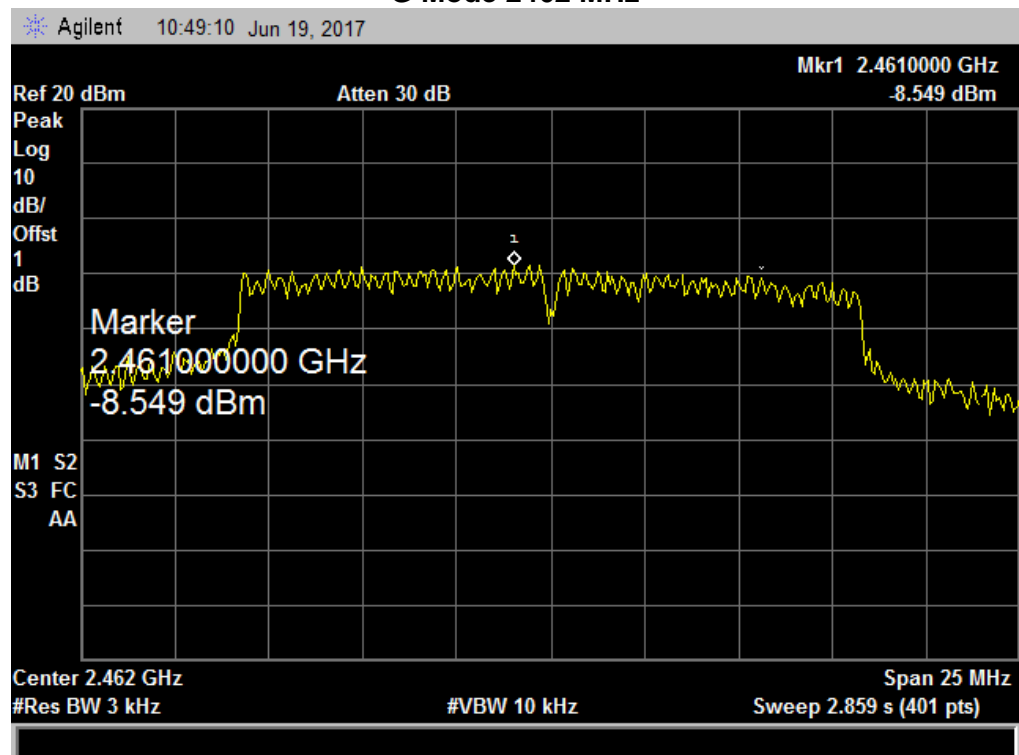

801.11 n(HT20) Mode			
Frequency (MHz)	Power Density (3 kHz/dBm)	Limit (dBm/3KHz)	Result
2412	-11.93	8	Pass
2437	-12.80		
2462	-13.46		

N (HT20) Mode 2412 MHz

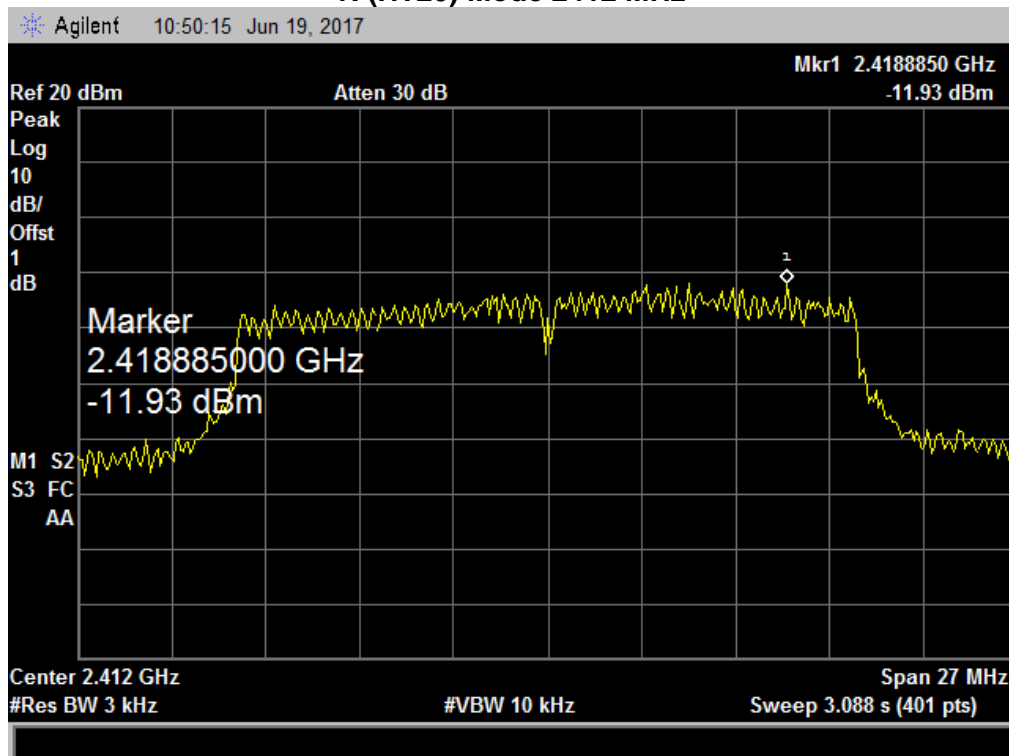

N (HT20) 2437 MHz

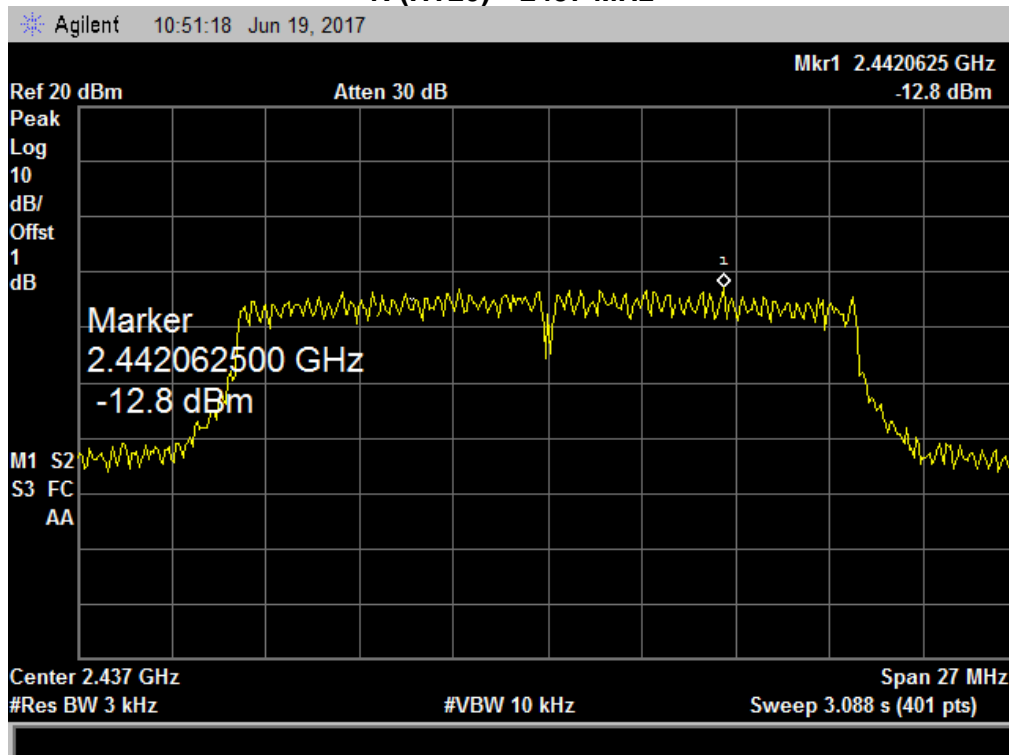

N (HT20) 2462 MHz

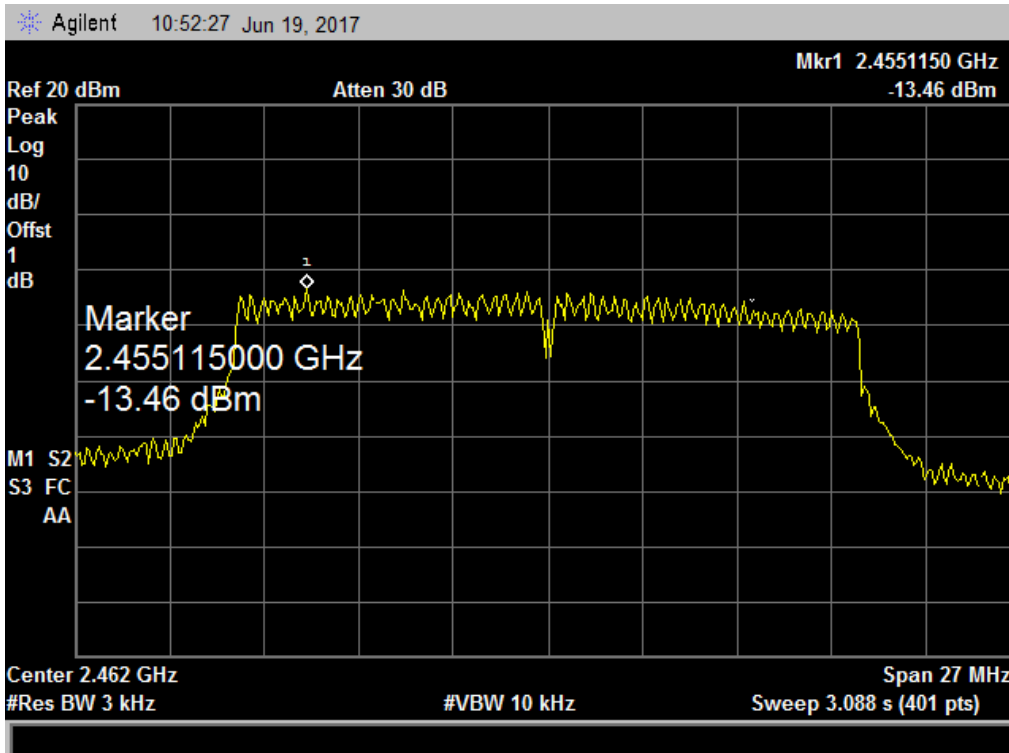

801.11 n(HT40) Mode			
Frequency (MHz)	Power Density (3 kHz/dBm)	Limit (dBm/3KHz)	Result
2422	-14.54	8	Pass
2437	-15.07		
2452	-10.03		

N (HT40) Mode 2422 MHz

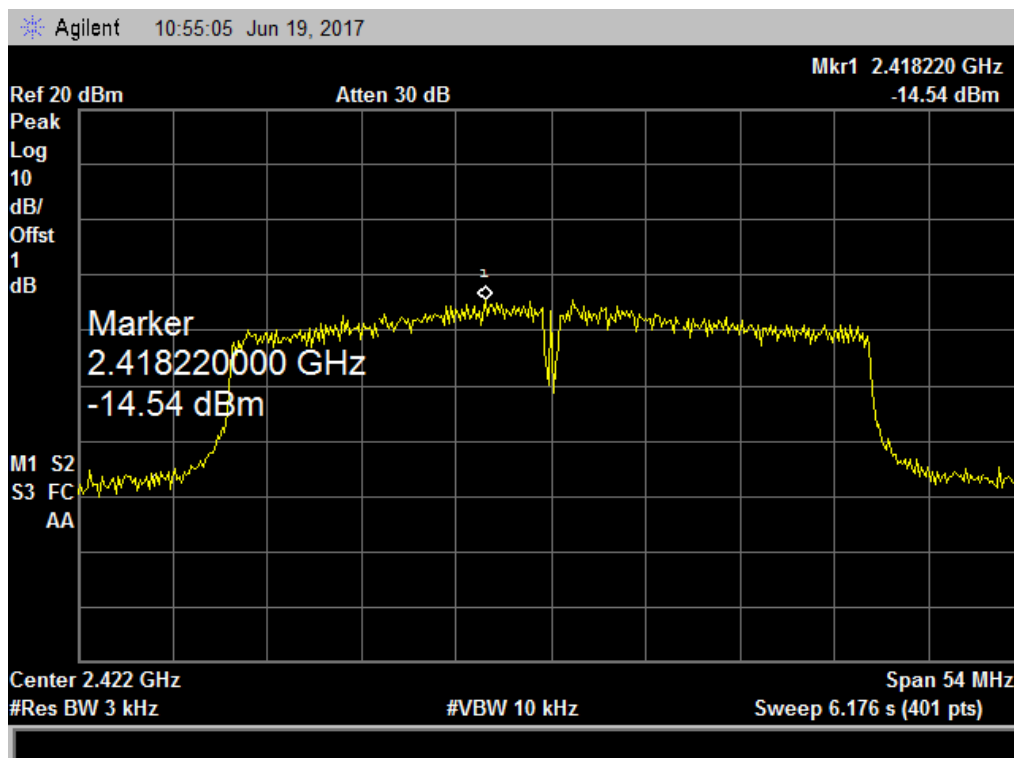

N (HT40) 2437 MHz

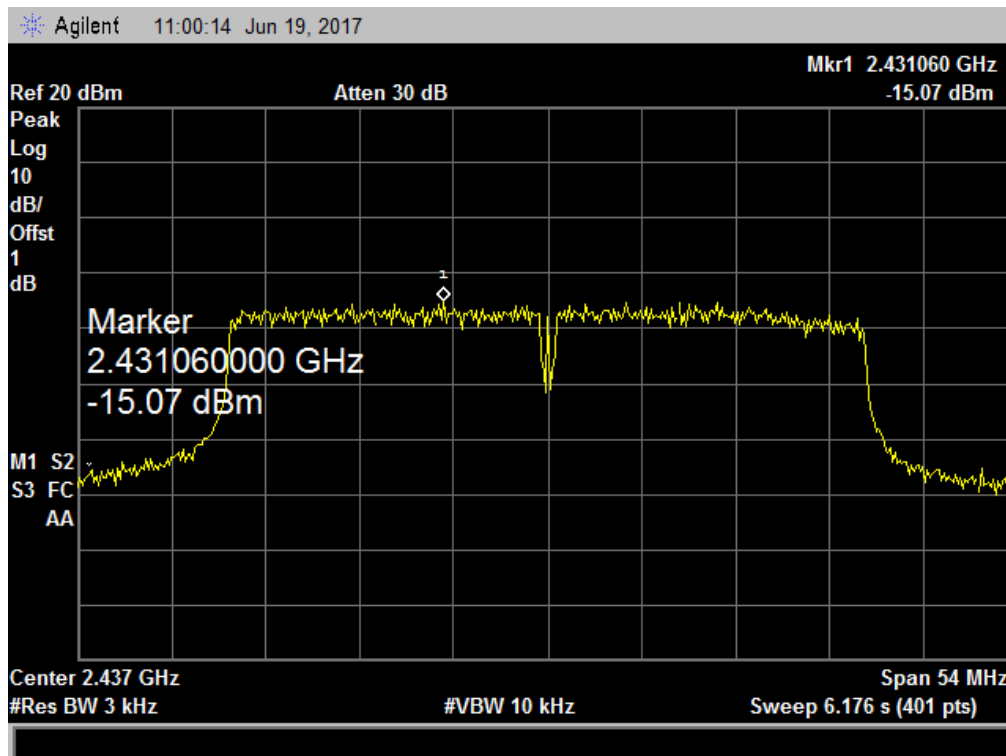

N (HT40) 2452 MHz

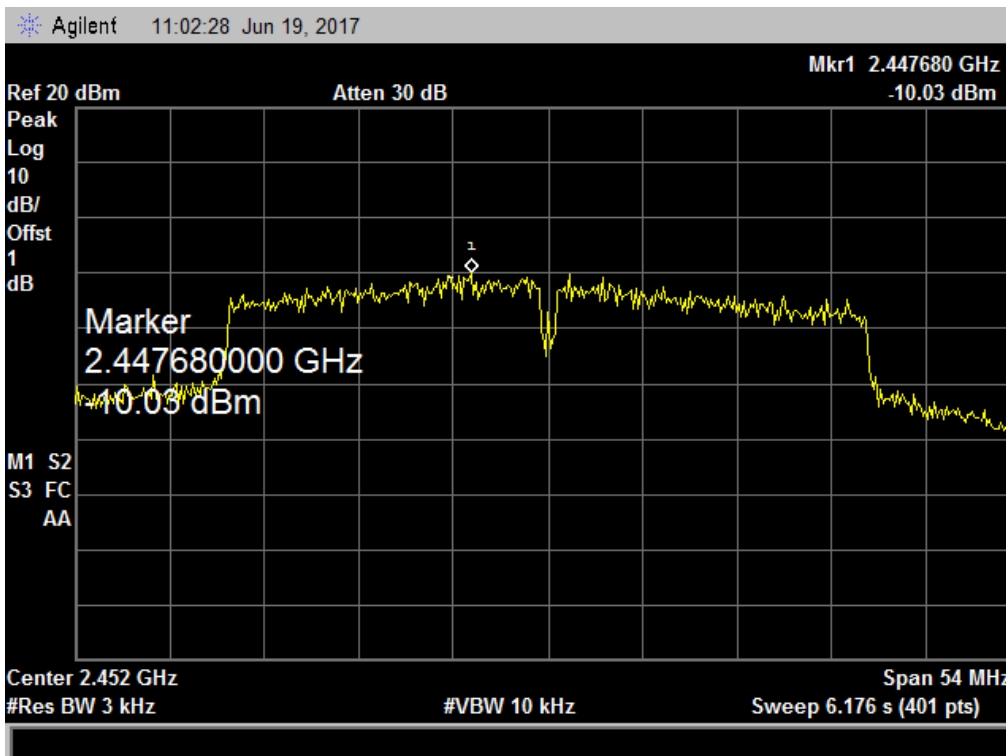

7. BAND EDGE AND OUT-OF-BAND EMISSION

7.1 LIMITS

FCC Part 15.247, Subpart C/ RSS 247 Section 5.5	
Frequency Range (MHz)	2400~2483.5
Limit	In any 100 kHz bandwidth outside the intentional radiation frequency band, the radio frequency power shall be at least 20 dB below the highest level of the desired power, based on either an RF conducted measurement, provide the transmitter demonstrates compliance with the peak conducted power limits.

7.2 TEST PROCEDURE

The EUT was directly connected to the power meter and antenna output port as show in the block diagram as bellow.

- Set frequency range to capture low band-edge from 2310 MHz up to 2390 MHz, and for up band-edge from 2483.5 MHz up to 2500 MHz
- For low band-edge set the equipment transmit at the lowest channel, and for up band-edge set the equipment transmit at the highest channel
- Set the VBW ≥ 3 RBW (100kHz/ 300kHz) for conducted measurement
- For radiated measurements the RBW set to 1 MHz, and the VBW set to 1 MHz for peak measurements and 10 Hz for average measurement

7.3 TEST SETUP

(A) Radiated Emission Test Set-Up

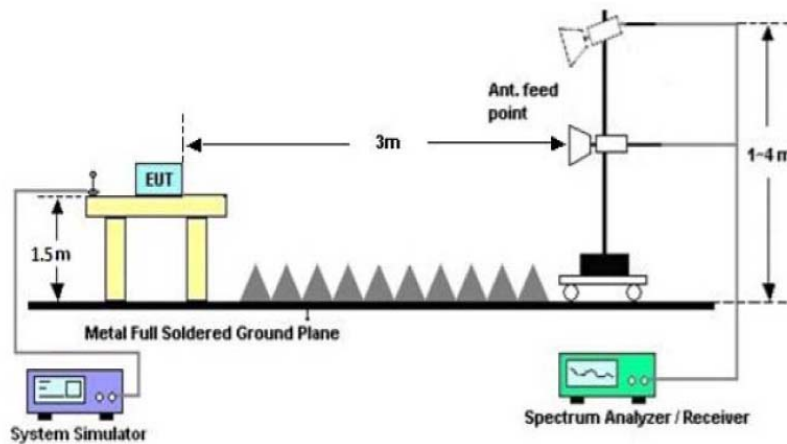

(B) Conducted Emission Test Setup

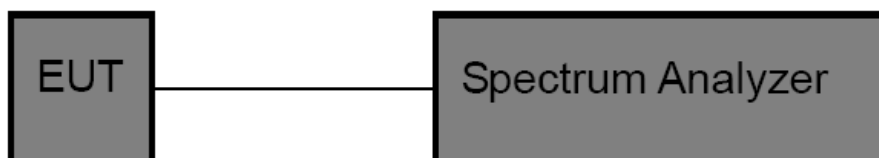

7.4 TEST INSTRUMENTS

Equipment	Manufacturer	Type No.	Serial No.	Last calibration	Calibrated until	Calibration period
Broadband Antenna	R&S	VULB 9168	VULB 9168-456	Jul. 04, 2016	Jul. 03. 2017	1 year
Test Cable	N/A	R-01	N/A	Jul. 04, 2016	Jul. 03. 2017	1 year
Test Cable	N/A	R-02	N/A	Jul. 04, 2016	Jul. 03. 2017	1 year
EMI Test Receiver	R&S	ESCI	101324	Jul. 04, 2016	Jul. 03. 2017	1 year
Spectrum Analyzer	Agilent	E4407B	MY41440432	Jul. 04, 2016	Jul. 03. 2017	1 year
Antenna Mast	EM	SC100_1	N/A	N/A	N/A	N/A
Turn Table	EM	SC100	060531	N/A	N/A	N/A
50Ω Switch	Anritsu Corp	MP59B	6200983705	Jul. 04, 2016	Jul. 03. 2017	1 year
Spectrum Analyzer	R&S	FSP40	100154	Jul. 04, 2016	Jul. 03. 2017	1 year
Horn Antenna	R&S	HF906	10029	Jul. 04, 2016	Jul. 03. 2017	1 year
Amplifier	EM	EM-30180	060538	Jul. 04, 2016	Jul. 03. 2017	1 year

7.5 EUT OPERATING CONDITIONS

The EUT was set to continuously transmitting in the maximum power during the test.

7.6 TEST RESULTS

Bandedge(Radiated Emission)

EUT :	WiFi Module	Model Name. :	CWI535
Temperature :	26 °C	Relative Humidity :	56%
Test Power :	AC 120V/ 60Hz	Pressure :	1010 hPa
Test Mode :	TX B Mode 2412MHz	Test Date :	2017-06-23

Remark : Only show the worse case-Vertical

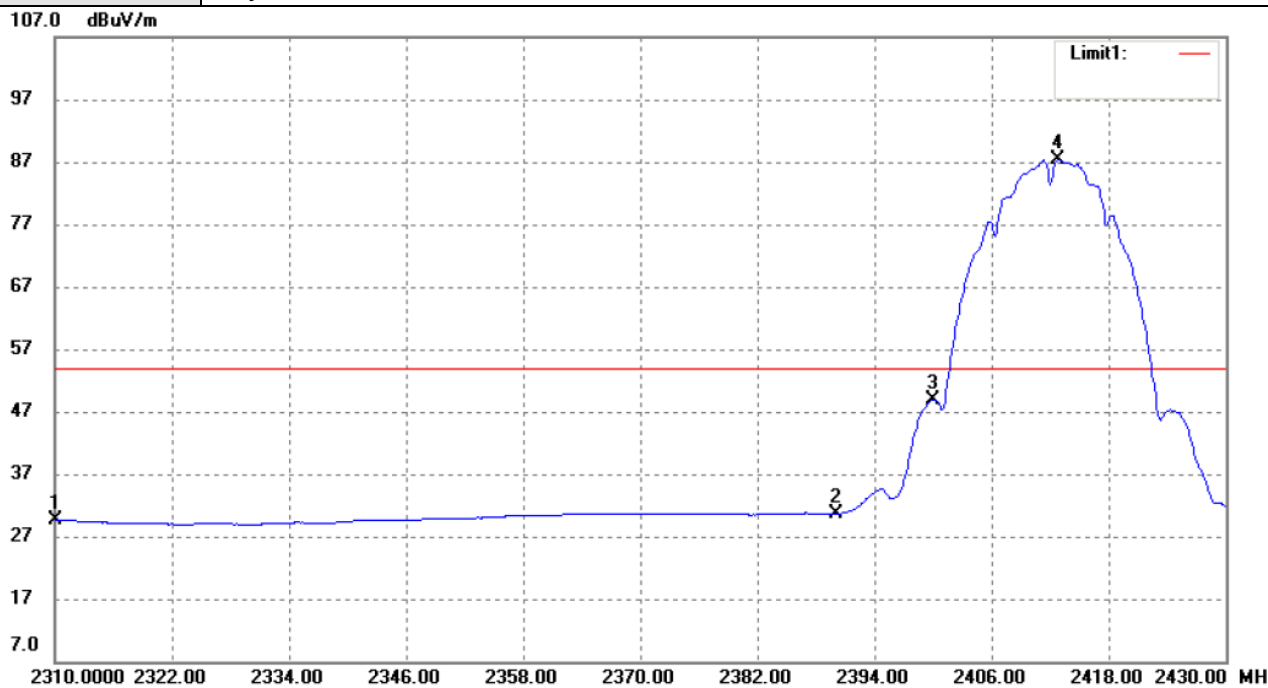

No.	Frequency (MHz)	Reading (dBuV/m)	Correct (dB/m)	Result (dBuV/m)	Limit (dBuV/m)	Margin (dB)	Remark
1	2310.000	33.95	-4.42	29.53	54.00	-24.47	Average Detector
	2310.000	44.98	-4.42	40.56	74.00	-33.44	Peak Detector
2	2390.000	34.34	-3.72	30.62	54.00	-23.38	Average Detector
	2390.000	45.43	-3.72	41.71	74.00	-32.29	Peak Detector
3	2400.000	52.53	-3.64	48.89	54.00	-5.11	Average Detector
	2400.000	58.48	-3.64	54.84	74.00	-19.16	Peak Detector
4	2412.840	90.97	-3.54	87.43	/	/	Average Detector
	2413.080	95.80	-3.54	92.26	/	/	Peak Detector

Remark:

Emission Level= Read Level+ Correct Factor

Margin= Emission Level-Limit

No report for the emission which more than 10 dB below the prescribed limit.

EUT :	WiFi Module	Model Name. :	CWI535
Temperature :	26 °C	Relative Humidity :	56%
Test Power :	AC 120V/ 60Hz	Pressure :	1010 hPa
Test Mode :	TX B Mode 2462MHz	Test Date :	2017-06-23
Remark :	Only show the worse case-Vertical		

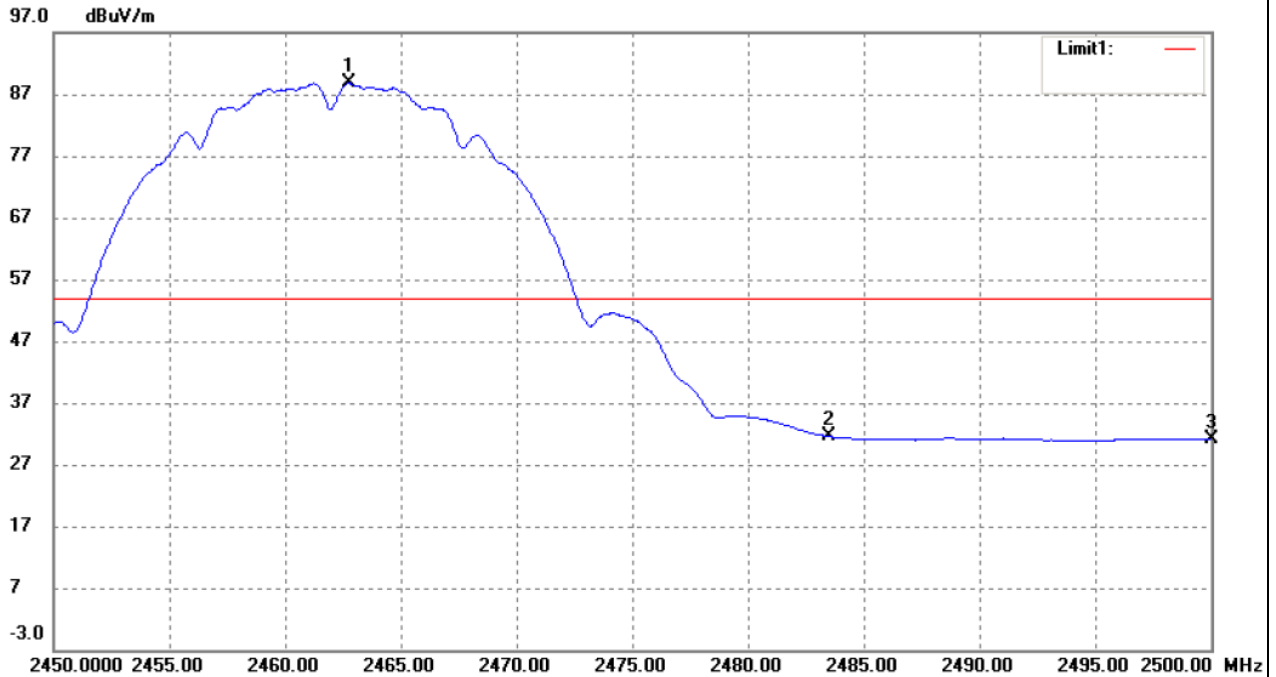

No.	Frequency (MHz)	Reading (dBuV/m)	Correct Factor(dB)	Result (dBuV/m)	Limit (dBuV/m)	Margin (dB)	Remark
1	2462.750	91.97	-3.17	88.80	/	/	Average Detector
	2463.050	96.99	-3.16	93.83	/	/	Peak Detector
2	2483.500	34.58	-3.01	31.57	54.00	-22.43	Average Detector
	2483.500	46.43	-3.01	43.42	74.00	-30.58	Peak Detector
3	2500.000	34.03	-2.88	31.15	54.00	-22.85	Average Detector
	2500.000	45.70	-2.88	42.82	74.00	-31.18	Peak Detector

Remark:

Emission Level= Read Level+ Correct Factor

Margin= Emission Level-Limit

No report for the emission which more than 10 dB below the prescribed limit.

EUT :	WiFi Module	Model Name. :	CWI535
Temperature :	26 °C	Relative Humidity :	56%
Test Power :	AC 120V/ 60Hz	Pressure :	1010 hPa
Test Mode :	TX G Mode 2412MHz	Test Date :	2017-06-23

Remark : Only show the worse case-Vertical

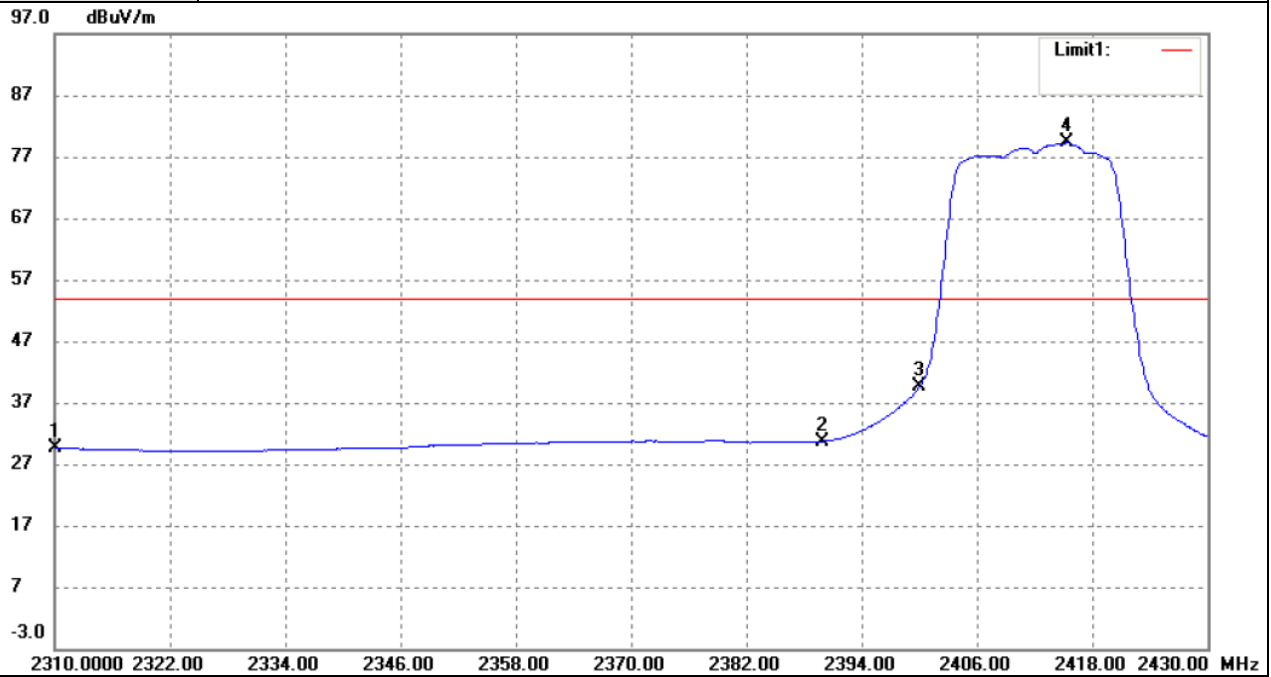

No.	Frequency (MHz)	Reading (dBuV/m)	Correct (dB/m)	Result (dBuV/m)	Limit (dBuV/m)	Margin (dB)	Remark
1	2310.000	34.03	-4.42	29.61	54.00	-24.39	Average Detector
		45.73	-4.42	41.31	74.00	-32.69	Peak Detector
2	2390.000	34.44	-3.72	30.72	54.00	-23.28	Average Detector
		46.55	-3.72	42.83	74.00	-31.17	Peak Detector
3	2400.000	43.16	-3.64	39.52	54.00	-14.48	Average Detector
		72.22	-3.64	68.58	74.00	-5.42	Peak Detector
4	2415.360	82.79	-3.52	79.27	/	/	Average Detector
		94.51	-3.52	90.99	/	/	Peak Detector

Remark:

Emission Level= Read Level+ Correct Factor

Margin= Emission Level-Limit

No report for the emission which more than 10 dB below the prescribed limit.

EUT :	WiFi Module	Model Name. :	CWI535
Temperature :	26 °C	Relative Humidity :	56%
Test Power :	AC 120V/ 60Hz	Pressure :	1010 hPa
Test Mode :	TX G Mode 2462MHz	Test Date :	2017-06-23
Remark :	Only show the worse case-Vertical		

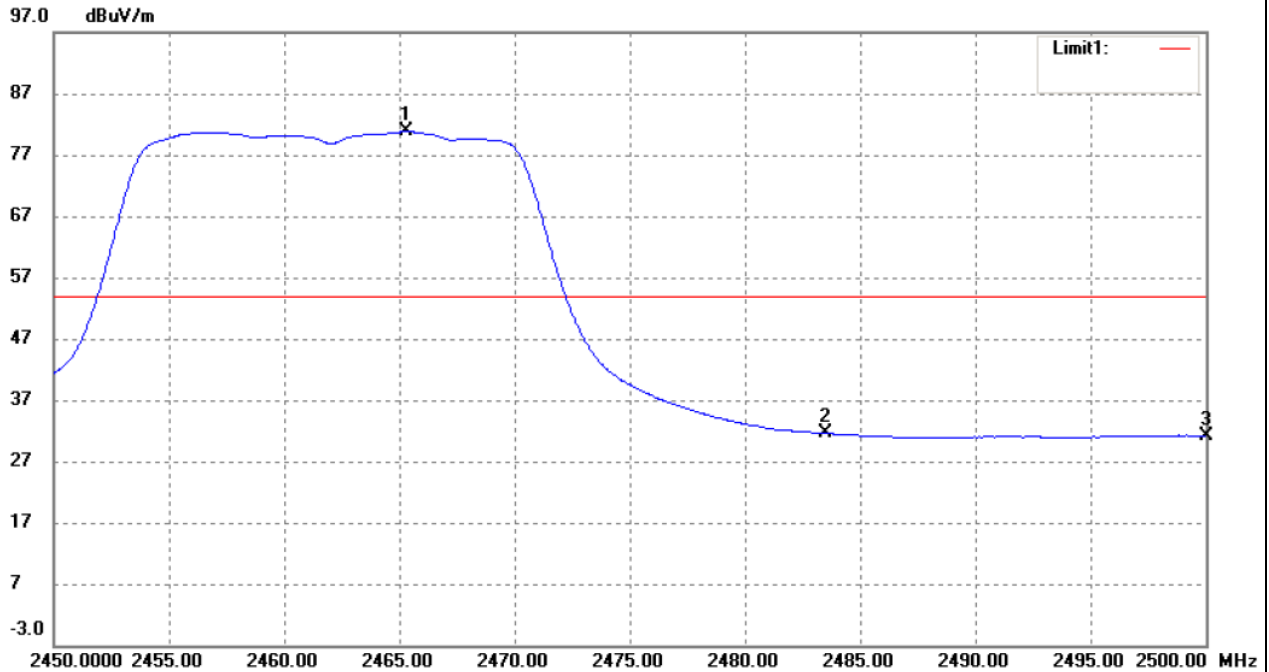

No.	Frequency (MHz)	Reading (dBuV/m)	Correct (dB/m)	Result (dBuV/m)	Limit (dBuV/m)	Margin (dB)	Remark
1	2465.300	83.97	-3.15	80.82	/	/	Average Detector
	2465.100	95.79	-3.15	92.64	/	/	Peak Detector
2	2483.500	34.58	-3.01	31.57	54.00	-22.43	Average Detector
	2483.500	47.33	-3.01	44.32	74.00	-29.68	Peak Detector
3	2500.000	34.13	-2.88	31.25	54.00	-22.75	Average Detector
	2500.000	46.58	-2.88	43.70	74.00	-30.30	Peak Detector

Remark:

Emission Level= Read Level+ Correct Factor

Margin= Emission Level-Limit

No report for the emission which more than 10 dB below the prescribed limit.

EUT :	WiFi Module	Model Name. :	CWI535
Temperature :	26 °C	Relative Humidity :	56%
Test Power :	AC 120V/ 60Hz	Pressure :	1010 hPa
Test Mode :	TX N20 Mode 2412MHz	Test Date :	2017-06-23
Remark :	Only show the worse case-Vertical		

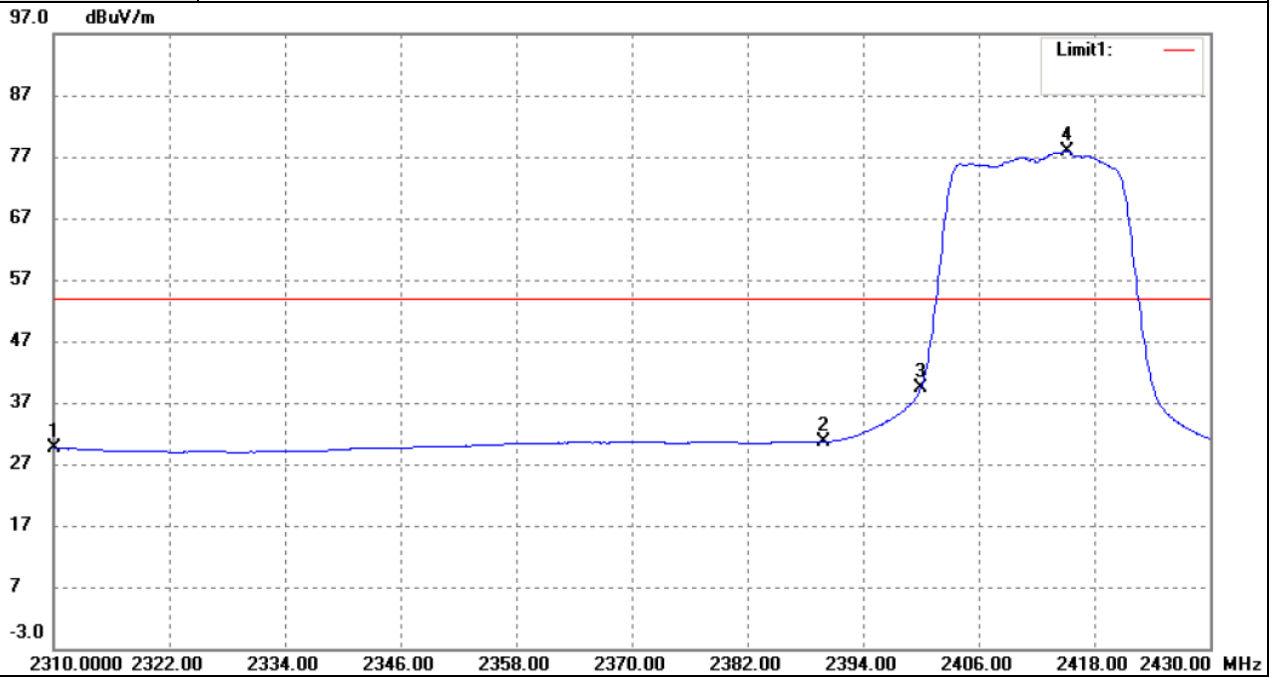

No.	Frequency (MHz)	Reading (dBuV/m)	Correct (dB/m)	Result (dBuV/m)	Limit (dBuV/m)	Margin (dB)	Remark
1	2310.000	33.94	-4.42	29.52	54.00	-24.48	Average Detector
	2310.000	46.11	-4.42	41.69	74.00	-32.31	Peak Detector
2	2390.000	34.35	-3.72	30.63	54.00	-23.37	Average Detector
	2390.000	46.19	-3.72	42.47	74.00	-31.53	Peak Detector
3	2400.000	43.02	-3.64	39.38	54.00	-14.62	Average Detector
	2400.000	71.95	-3.64	68.31	74.00	-5.69	Peak Detector
4	2415.120	81.33	-3.52	77.81	/	/	Average Detector
	2415.240	92.00	-3.52	88.48	/	/	Peak Detector

Remark:

Emission Level= Read Level+ Correct Factor

Margin= Emission Level-Limit

No report for the emission which more than 10 dB below the prescribed limit.

EUT :	WiFi Module	Model Name. :	CWI535
Temperature :	26 °C	Relative Humidity :	56%
Test Power :	AC 120V/ 60Hz	Pressure :	1010 hPa
Test Mode :	TX N20 Mode 2462MHz	Test Date :	2017-06-23
Remark :	Only show the worse case-Vertical		

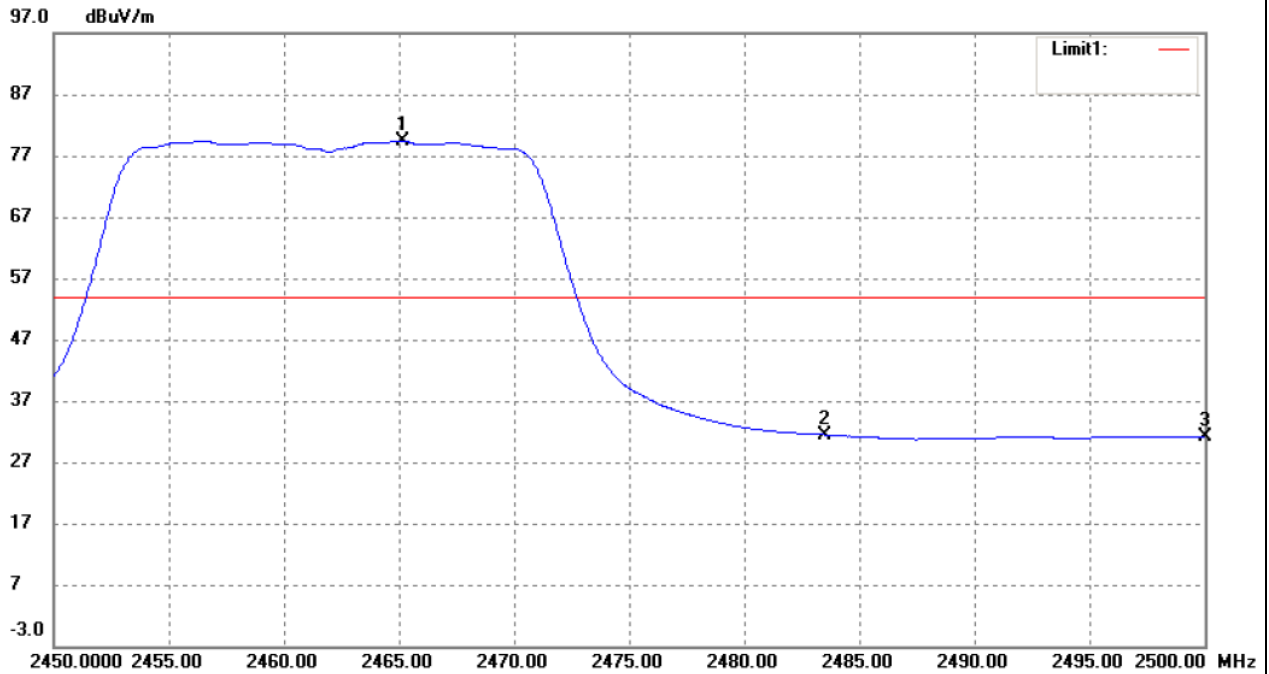

No.	Frequency (MHz)	Reading (dBuV/m)	Correct (dB/m)	Result (dBuV/m)	Limit (dBuV/m)	Margin (dB)	Remark
1	2465.150	82.62	-3.15	79.47	/	/	Average Detector
	2458.850	93.69	-3.19	90.50	/	/	Peak Detector
2	2483.500	34.51	-3.01	31.50	54.00	-22.50	Average Detector
	2483.500	47.39	-3.01	44.38	74.00	-29.62	Peak Detector
3	2500.000	34.06	-2.88	31.18	54.00	-22.82	Average Detector
	2500.000	45.37	-2.89	42.48	74.00	-31.52	Peak Detector

Remark:

Emission Level= Read Level+ Correct Factor

Margin= Emission Level-Limit

No report for the emission which more than 10 dB below the prescribed limit.

EUT :	WiFi Module	Model Name. :	CWI535
Temperature :	26 °C	Relative Humidity :	56%
Test Power :	AC 120V/ 60Hz	Pressure :	1010 hPa
Test Mode :	TX N40 Mode 2422MHz	Test Date :	2017-06-23
Remark :	Only show the worse case-Vertical		



No.	Frequency (MHz)	Reading (dBuV/m)	Correct (dB/m)	Result (dBuV/m)	Limit (dBuV/m)	Margin (dB)	Remark
1	2310.000	34.05	-4.42	29.63	54.00	-24.37	Average Detector
	2310.000	45.99	-4.42	41.57	74.00	-32.43	Peak Detector
2	2390.000	34.99	-3.72	31.27	54.00	-22.73	Average Detector
	2390.000	47.98	-3.72	44.26	74.00	-29.74	Peak Detector
3	2400.000	46.68	-3.64	43.04	54.00	-10.96	Average Detector
	2400.000	59.64	-3.64	56.00	74.00	-18.00	Peak Detector
4	2413.460	78.26	-3.53	74.73	/	/	Average Detector
	2412.620	88.65	-3.54	85.11	/	/	Peak Detector

Remark:

Emission Level= Read Level+ Correct Factor

Margin= Emission Level-Limit

No report for the emission which more than 10 dB below the prescribed limit.

EUT :	WiFi Module	Model Name. :	CWI535
Temperature :	26 °C	Relative Humidity :	56%
Test Power :	AC 120V/ 60Hz	Pressure :	1010 hPa
Test Mode :	TX N40 Mode 2452MHz	Test Date :	2017-06-23

Remark : Only show the worse case-Vertical

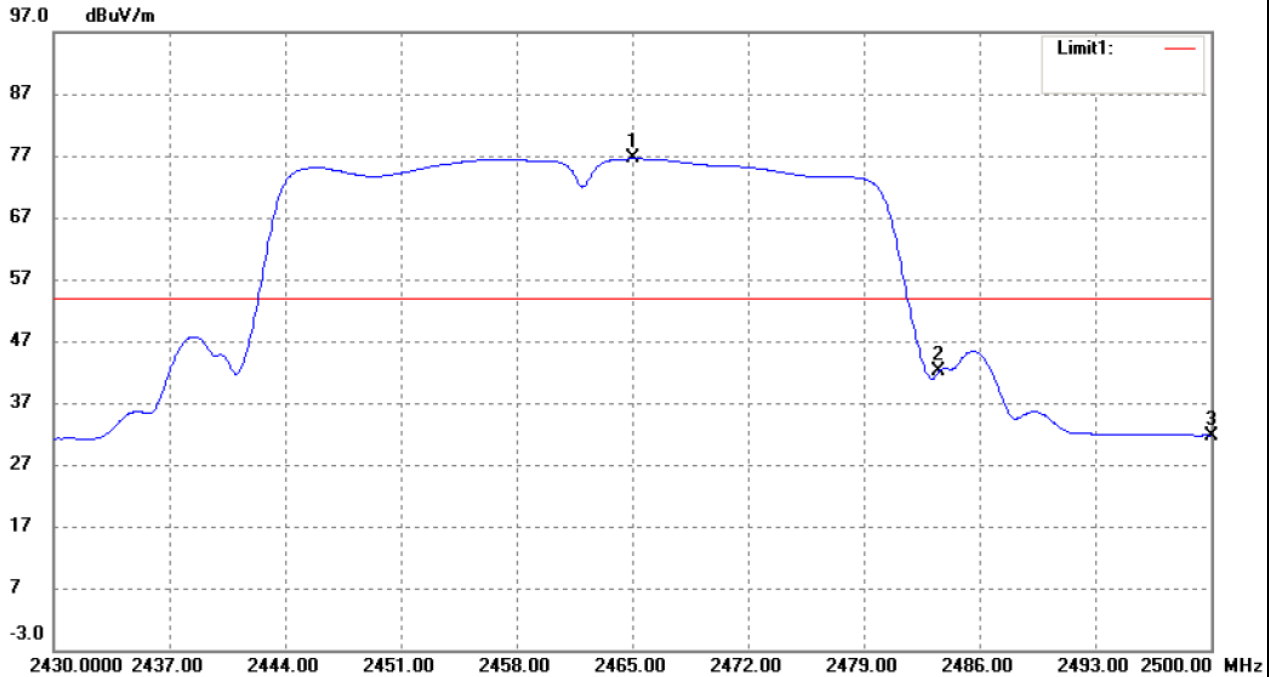

No.	Frequency (MHz)	Reading (dBuV/m)	Correct (dB/m)	Result (dBuV/m)	Limit (dBuV/m)	Margin (dB)	Remark
1	2465.000	79.69	-3.15	76.54	/	/	Average Detector
	2458.350	90.17	-3.19	86.98	/	/	Peak Detector
2	2483.500	45.15	-3.01	42.14	54.00	-11.86	Average Detector
	2483.500	60.65	-3.01	57.64	74.00	-16.36	Peak Detector
3	2500.000	34.62	-2.88	31.74	54.00	-22.26	Average Detector
	2500.000	46.72	-2.88	43.84	74.00	-30.16	Peak Detector

Remark:

Emission Level= Read Level+ Correct Factor

Margin= Emission Level-Limit

No report for the emission which more than 10 dB below the prescribed limit.

Bandedge(Conducted Emission)

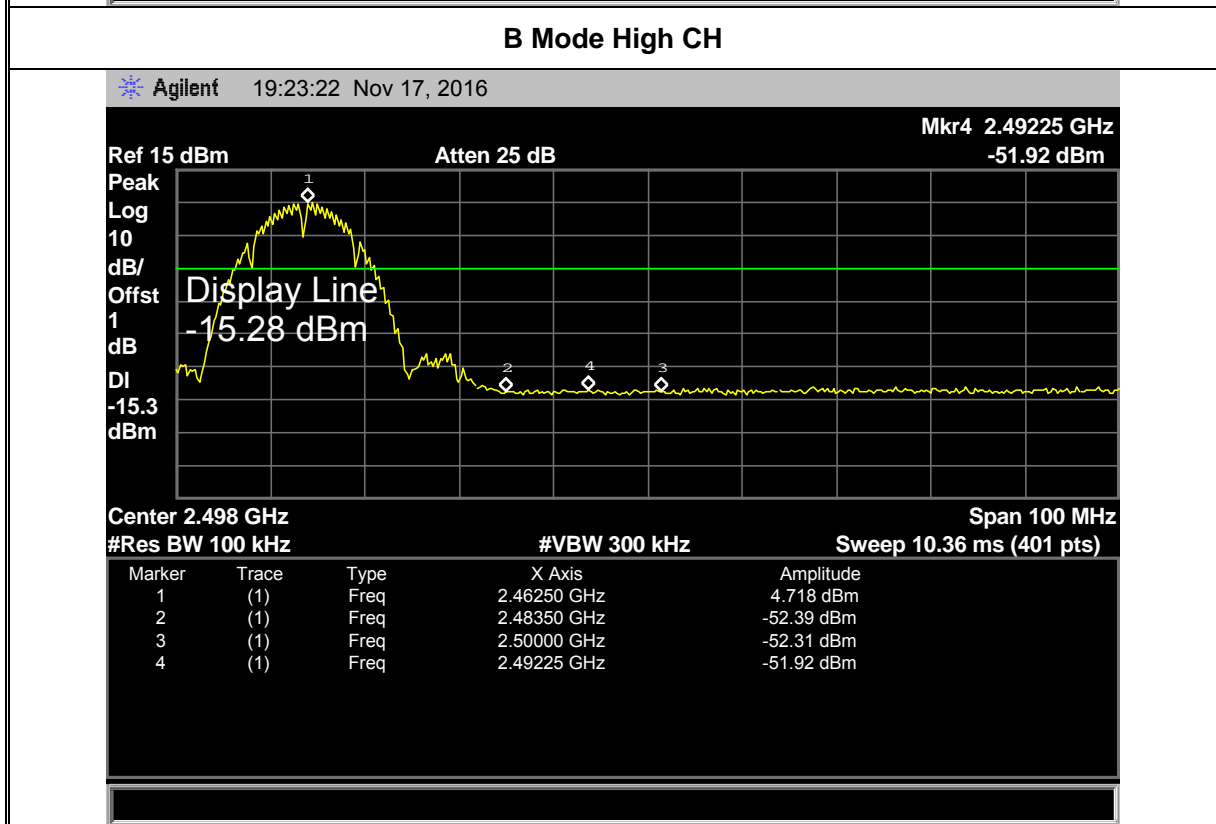
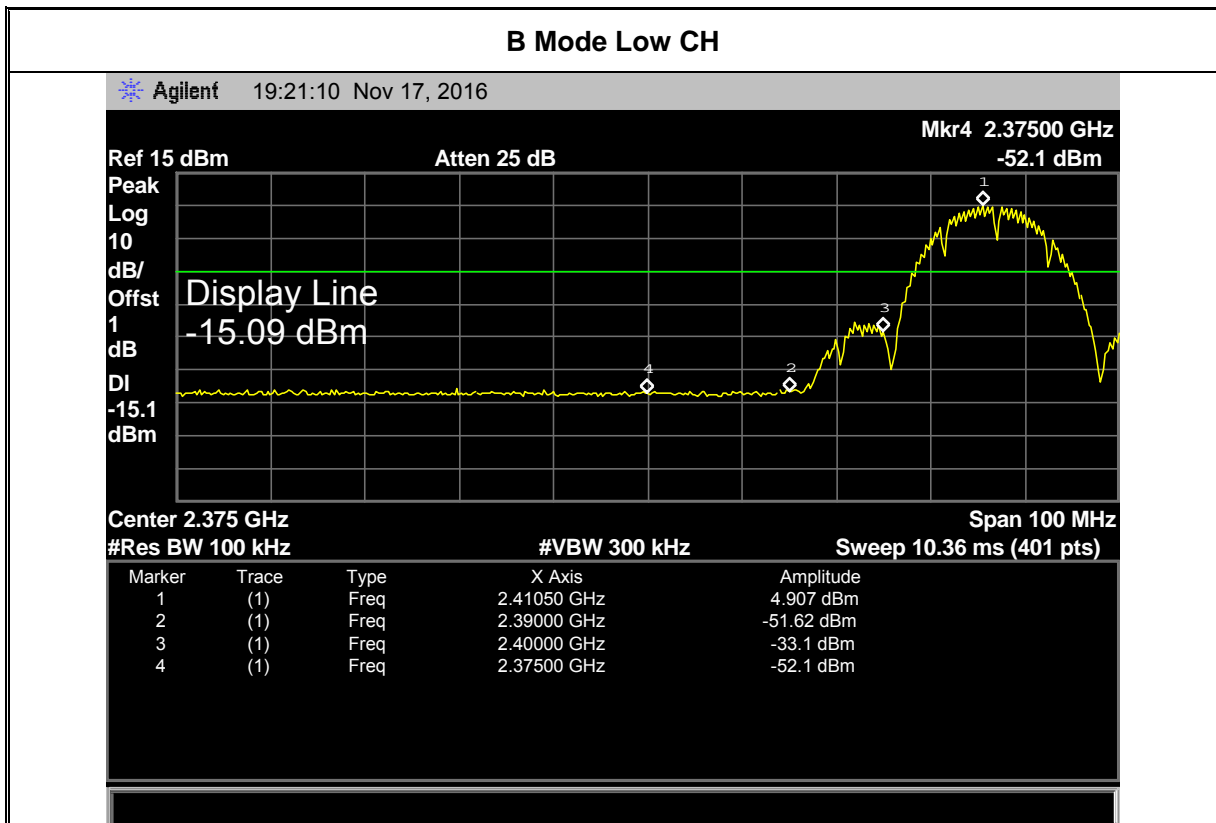

G Mode Low CH

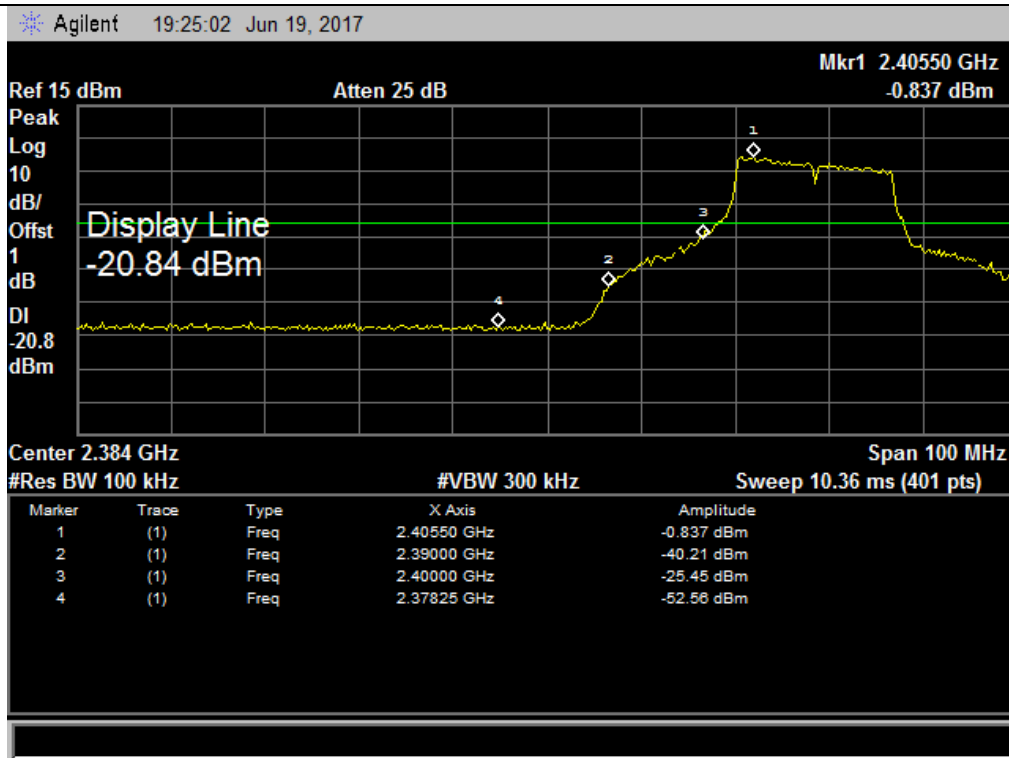

G Mode High CH

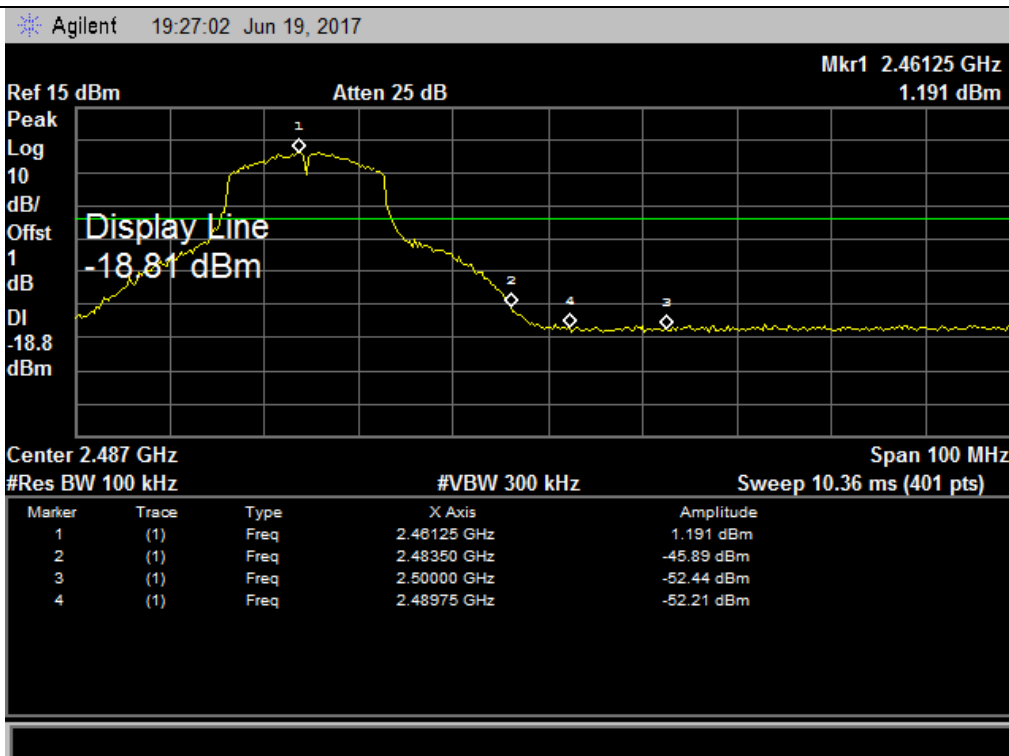

N(20) Mode Low CH

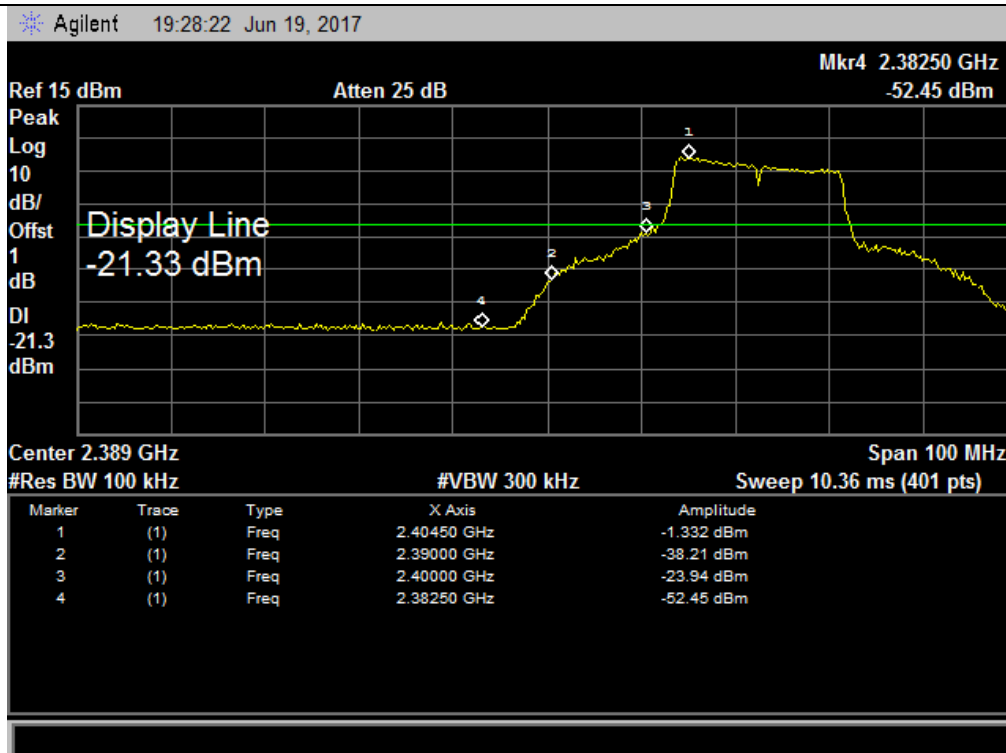

N(20) Mode High CH

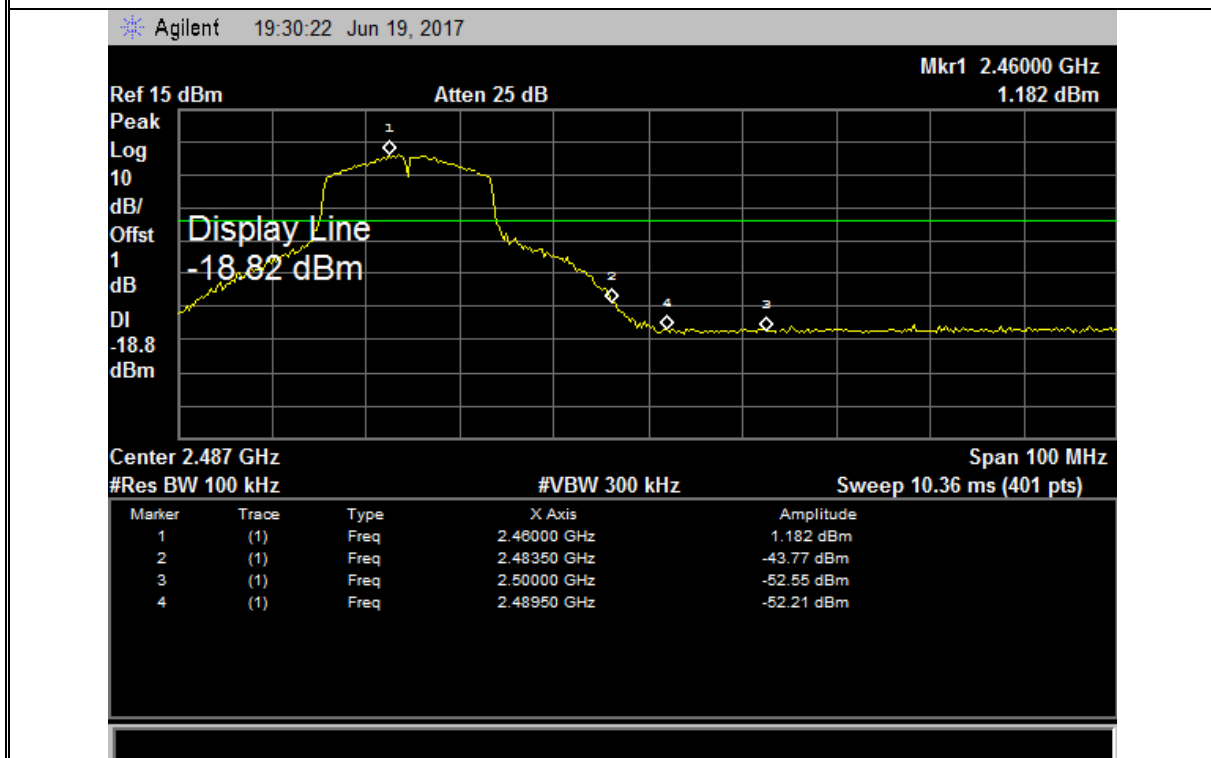

N(40) Mode Low CH

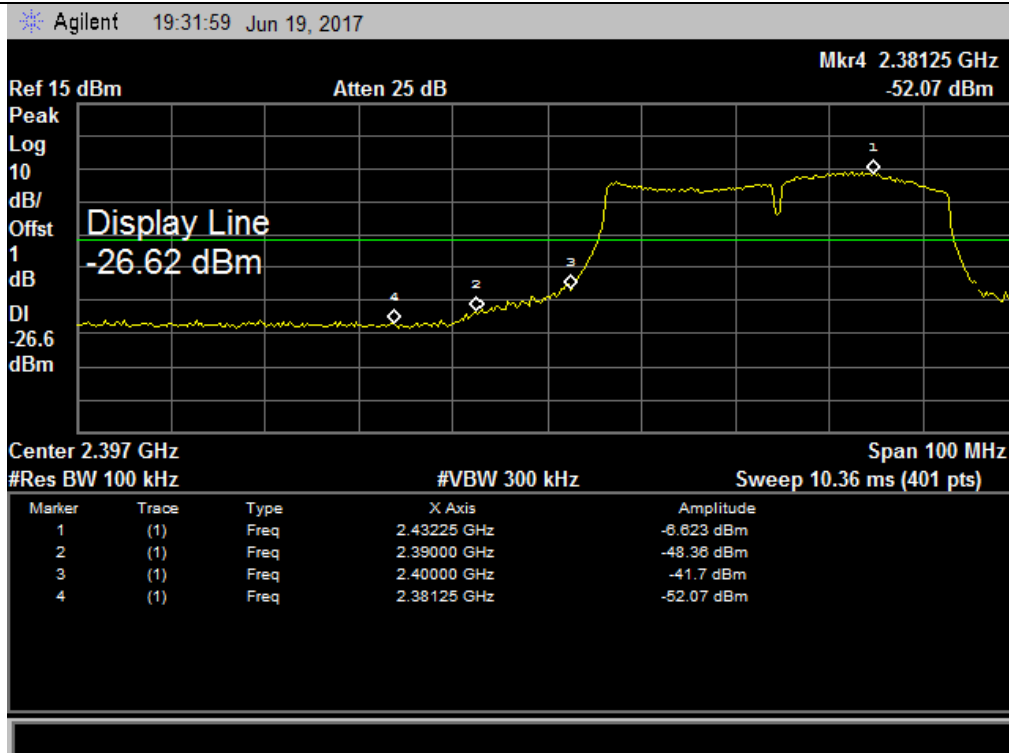

N(40) Mode High CH

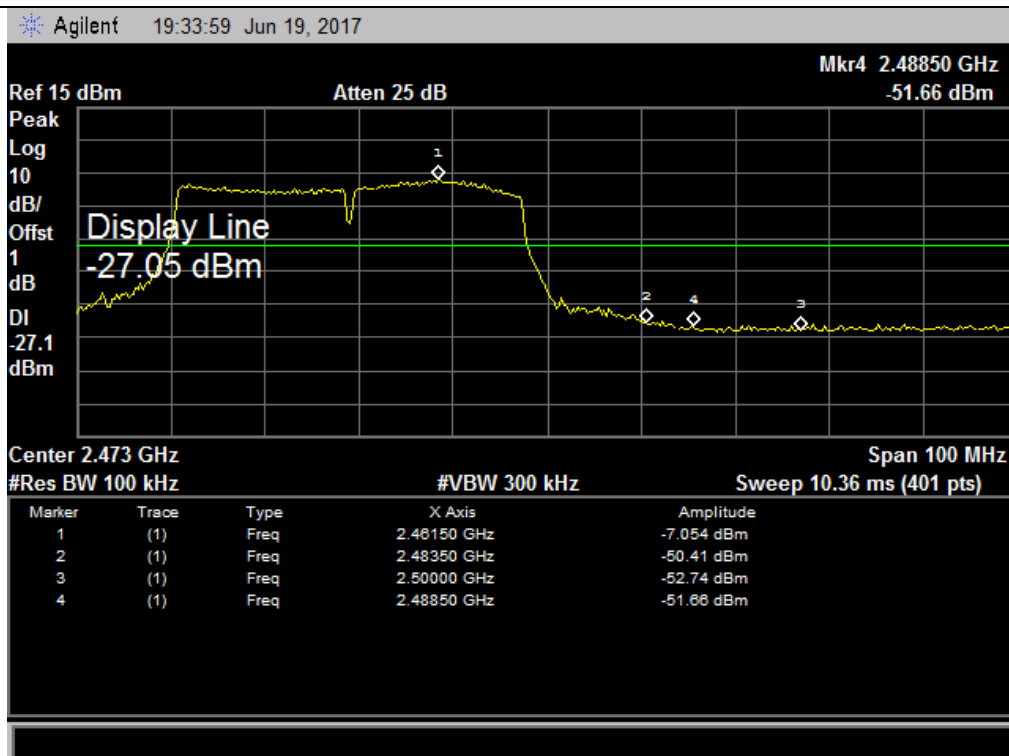

8. ANTENNA REQUIREMENT

8.1 REQUIREMENT

Antenna Requirement (15.203)	An intentional radiator shall be designed to ensure that no antenna other than that furnished by the responsible party shall be used with the device. The use of a permanently attached antenna or of an antenna that uses a unique coupling to the intentional radiator shall be considered sufficient to comply with the provisions of this Section. The manufacturer may design the unit so that a broken antenna can be replaced by the user, but the use of a standard antenna jack or electrical connector is prohibited.
Antenna Requirement (15.247)	If transmitting antennas of directional gain greater than 6 dBi are used, the power shall be reduced by the amount in dB that the directional gain of the antenna exceeds 6 dBi.

8.2 ANTENNA CONNECTOR CONSTRUCTION

The EUT antenna is a PIFA Antenna. And the maximum gain of this antenna is 0.85 dBi. It complies with the standard requirement.

-----END OF REPORT-----