

TEST REPORT

Product : Portable PC
Trade mark : CHUWI
Model/Type reference : CoreBook Pro
Serial Number : N/A
Report Number : EED32M00265301
FCC ID : 2AHLZ-COREBOOKPRO
Date of Issue: : Oct. 29, 2020
Test Standards : 47 CFR Part 15 Subpart C
Test result : PASS

Prepared for:

CHUWI TECHNOLOGY (ShenZhen) CO., LIMITED
2 Floor Building 3 LiJinCheng Industrial park
the east of Gongye road LongHua, Shenzhen, China

Prepared by:

Centre Testing International Group Co., Ltd.
Hongwei Industrial Zone, Bao'an 70 District,
Shenzhen, Guangdong, China
TEL: +86-755-3368 3668
FAX: +86-755-3368 3385

Compiled by:

Sunlight Sun

Sunlight Sun

Reviewed by:

Jok Yang

Jok Yang

Approved by:

Sam Chuang

Sam Chuang

Date:

Oct. 29, 2020

Check No: 4762123665



2 Version

Version No.	Date	Description
00	Oct. 29, 2020	Original

3 Test Summary

Test Item	Test Requirement	Test method	Result
Antenna Requirement	47 CFR Part 15, Subpart C Section 15.203/15.247 (c)	ANSI C63.10-2013	PASS
AC Power Line Conducted Emission	47 CFR Part 15, Subpart C Section 15.207	ANSI C63.10-2013	PASS
Conducted Peak Output Power	47 CFR Part 15, Subpart C Section 15.247 (b)(1)	ANSI C63.10-2013	PASS
20dB Occupied Bandwidth	47 CFR Part 15, Subpart C Section 15.247 (a)(1)	ANSI C63.10-2013	PASS
Carrier Frequencies Separation	47 CFR Part 15, Subpart C Section 15.247 (a)(1)	ANSI C63.10-2013	PASS
Hopping Channel Number	47 CFR Part 15, Subpart C Section 15.247 (b)	ANSI C63.10-2013	PASS
Dwell Time	47 CFR Part 15, Subpart C Section 15.247 (a)(1)	ANSI C63.10-2013	PASS
Pseudorandom Frequency Hopping Sequence	47 CFR Part 15, Subpart C Section 15.247(b)(4)&TCB Exclusion List (7 July 2002)	ANSI C63.10-2013	PASS
RF Conducted Spurious Emissions	47 CFR Part 15, Subpart C Section 15.247(d)	ANSI C63.10-2013	PASS
Radiated Spurious emissions	47 CFR Part 15, Subpart C Section 15.205/15.209	ANSI C63.10-2013	PASS
Restricted bands around fundamental frequency (Radiated Emission)	47 CFR Part 15 Subpart C Section 15.205/15.209	ANSI C63.10-2013	PASS

Remark:

Test according to ANSI C63.4-2014 & ANSI C63.10-2013.

Company Name and Address shown on Report, the sample(s) and sample Information was/ were provided by the applicant who should be responsible for the authenticity which CTI hasn't verified.

4 Content

1 COVER PAGE	1
2 VERSION	2
3 TEST SUMMARY	3
4 CONTENT	4
5 TEST REQUIREMENT	5
5.1 TEST SETUP.....	5
5.1.1 For Conducted test setup.....	5
5.1.2 For Radiated Emissions test setup.....	5
5.1.3 For Conducted Emissions test setup.....	6
5.2 TEST ENVIRONMENT.....	6
5.3 TEST CONDITION.....	6
6 GENERAL INFORMATION	7
6.1 CLIENT INFORMATION.....	7
6.2 GENERAL DESCRIPTION OF EUT.....	7
6.3 PRODUCT SPECIFICATION SUBJECTIVE TO THIS STANDARD.....	7
6.4 DESCRIPTION OF SUPPORT UNITS.....	9
6.5 TEST LOCATION.....	9
6.6 DEVIATION FROM STANDARDS.....	9
6.7 ABNORMALITIES FROM STANDARD CONDITIONS.....	9
6.8 OTHER INFORMATION REQUESTED BY THE CUSTOMER.....	9
6.9 MEASUREMENT UNCERTAINTY(95% CONFIDENCE LEVELS, K=2).....	9
7 EQUIPMENT LIST	10
8 RADIO TECHNICAL REQUIREMENTS SPECIFICATION	13
Appendix A): 20dB Occupied Bandwidth.....	18
Appendix B): Carrier Frequency Separation.....	23
Appendix C): Dwell Time.....	28
Appendix D): Hopping Channel Number.....	33
Appendix E): Conducted Peak Output Power.....	36
Appendix F): Band-edge for RF Conducted Emissions.....	41
Appendix G): RF Conducted Spurious Emissions.....	47
Appendix H) Pseudorandom Frequency Hopping Sequence.....	58
Appendix I) Antenna Requirement.....	59
Appendix J) AC Power Line Conducted Emission.....	60
Appendix K) Restricted bands around fundamental frequency (Radiated).....	63
Appendix L) Radiated Spurious Emissions.....	80
PHOTOGRAPHS OF TEST SETUP	85
PHOTOGRAPHS OF EUT CONSTRUCTIONAL DETAILS	88

5 Test Requirement

5.1 Test setup

5.1.1 For Conducted test setup

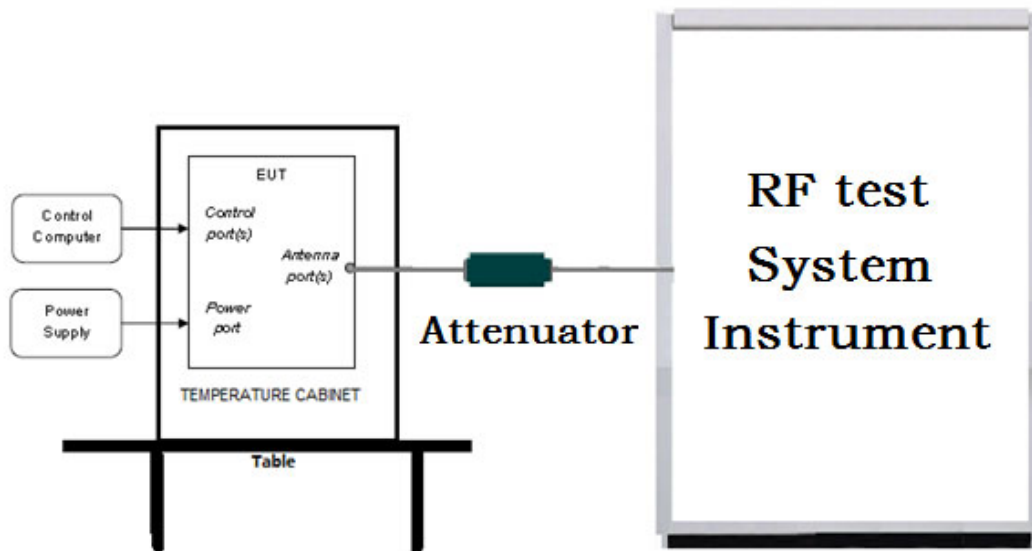

5.1.2 For Radiated Emissions test setup

Radiated Emissions setup:

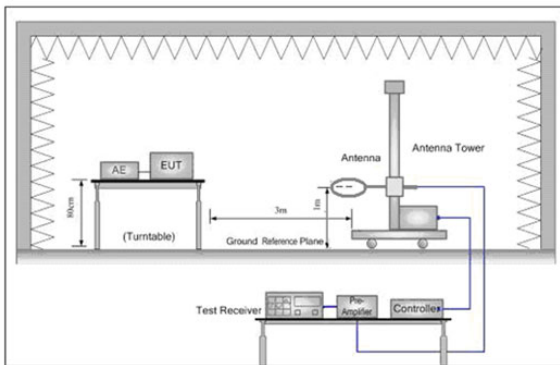

Figure 1. Below 30MHz

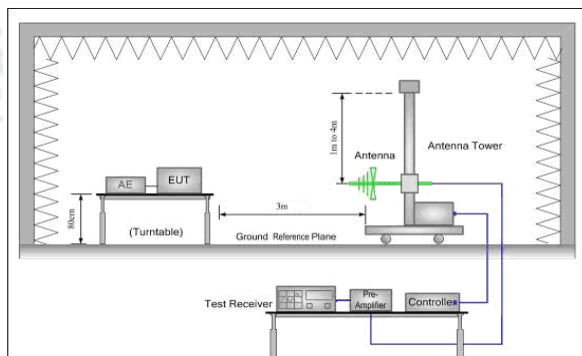

Figure 2. 30MHz to 1GHz

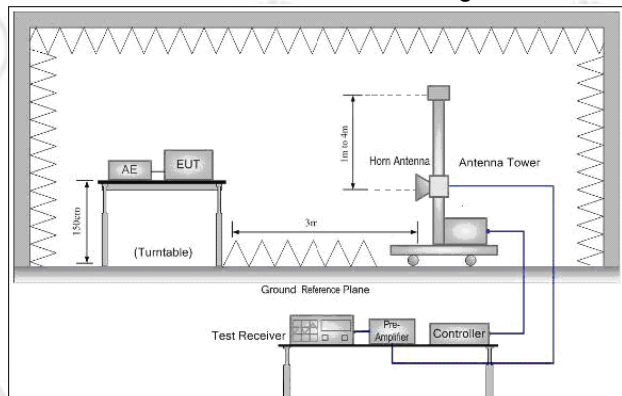
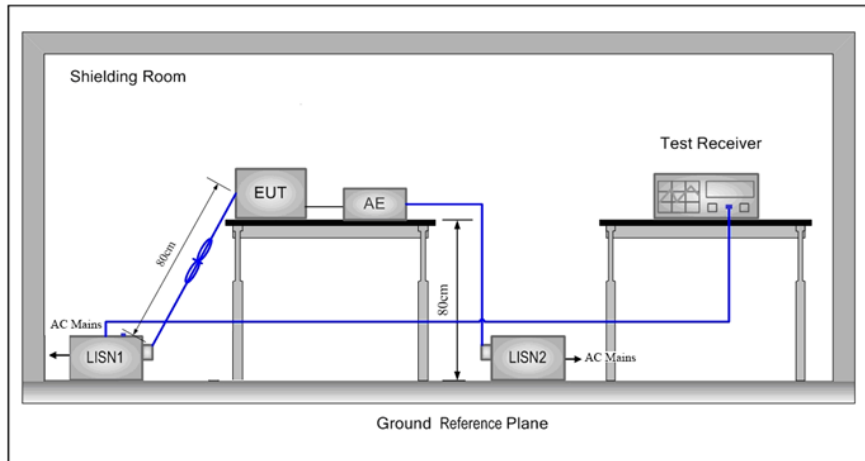

Figure 3. Above 1GHz

5.1.3 For Conducted Emissions test setup
Conducted Emissions setup



5.2 Test Environment

Operating Environment:	
Temperature:	24.0 °C
Humidity:	54 % RH
Atmospheric Pressure:	1010mbar

5.3 Test Condition

Test Mode	Tx/Rx	RF Channel		
		Low(L)	Middle(M)	High(H)
GFSK/π/4DQPSK/ 8DPSK(DH1,DH3,DH5)	2402MHz ~2480 MHz	Channel 0	Channel 39	Channel78
		2402MHz	2441MHz	2480MHz

6 General Information

6.1 Client Information

Applicant:	CHUWI TECHNOLOGY (ShenZhen) CO., LIMITED
Address of Applicant:	2 Floor Building 3 LiJinCheng Industrial park the east of Gongye road LongHua, Shenzhen, China
Manufacturer:	CHUWI TECHNOLOGY (ShenZhen) CO., LIMITED
Address of Manufacturer:	2 Floor Building 3 LiJinCheng Industrial park the east of Gongye road LongHua, Shenzhen, China
Factory:	JIANGSU LUCKYSTAR INTELLIGENT & TECHNOLOGY CO., LTD
Address of Factory:	Intelligent Terminal Pioneer Park (D) ,Yanlong Street Office, Yandu District, Yancheng City, Jiangsu Province

6.2 General Description of EUT

Product Name:	Portable PC	
Model No.(EUT):	CoreBook Pro	
Tark mark:	CHUWI	
Frequency Range of Operation	2400MHz to 2483.5MHz	
Power Supply:	Adapter	Model:A653-1903420D Input:100-240V~ 50/60Hz 1.5A Output:19.0V---3.42A 65.0W
	Battery	Model Name:505979-3S1P 3ICP5/59/79 Rating:11.55V---4000mAh 46.2 Wh
Sample Received Date:	Aug. 28, 2020	
Sample tested Date:	Aug. 28, 2020 to Oct.15, 2020	

6.3 Product Specification subjective to this standard

Operation Frequency:	2402MHz~2480MHz
Bluetooth Version:	BT Classic
Modulation Technique:	Frequency Hopping Spread Spectrum(FHSS)
Modulation Type:	GFSK, $\pi/4$ DQPSK, 8DPSK
Number of Channel:	79
Hopping Channel Type:	Adaptive Frequency Hopping systems
Test Power Grade:	Default
Test Software of EUT:	DRTU
Antenna Type:	FPC antenna
Antenna Gain:	1.70 dBi
Test Voltage:	Battery 11.55V

Operation Frequency each of channel							
Channel	Frequency	Channel	Frequency	Channel	Frequency	Channel	Frequency
0	2402MHz	20	2422MHz	40	2442MHz	60	2462MHz
1	2403MHz	21	2423MHz	41	2443MHz	61	2463MHz
2	2404MHz	22	2424MHz	42	2444MHz	62	2464MHz
3	2405MHz	23	2425MHz	43	2445MHz	63	2465MHz
4	2406MHz	24	2426MHz	44	2446MHz	64	2466MHz
5	2407MHz	25	2427MHz	45	2447MHz	65	2467MHz
6	2408MHz	26	2428MHz	46	2448MHz	66	2468MHz
7	2409MHz	27	2429MHz	47	2449MHz	67	2469MHz
8	2410MHz	28	2430MHz	48	2450MHz	68	2470MHz
9	2411MHz	29	2431MHz	49	2451MHz	69	2471MHz
10	2412MHz	30	2432MHz	50	2452MHz	70	2472MHz
11	2413MHz	31	2433MHz	51	2453MHz	71	2473MHz
12	2414MHz	32	2434MHz	52	2454MHz	72	2474MHz
13	2415MHz	33	2435MHz	53	2455MHz	73	2475MHz
14	2416MHz	34	2436MHz	54	2456MHz	74	2476MHz
15	2417MHz	35	2437MHz	55	2457MHz	75	2477MHz
16	2418MHz	36	2438MHz	56	2458MHz	76	2478MHz
17	2419MHz	37	2439MHz	57	2459MHz	77	2479MHz
18	2420MHz	38	2440MHz	58	2460MHz	78	2480MHz
19	2421MHz	39	2441MHz	59	2461MHz		

6.4 Description of Support Units

The EUT has been tested independently

6.5 Test Location

All tests were performed at:

Centre Testing International Group Co., Ltd.

Building C, Hongwei Industrial Park Block 70, Bao'an District, Shenzhen, China

Telephone: +86 (0) 755 33683668 Fax: +86 (0) 755 33683385

No tests were sub-contracted.

FCC Designation No.: CN1164

6.6 Deviation from Standards

None.

6.7 Abnormalities from Standard Conditions

None.

6.8 Other Information Requested by the Customer

None.

6.9 Measurement Uncertainty(95% confidence levels, k=2)

No.	Item	Measurement Uncertainty
1	Radio Frequency	7.9 x 10 ⁻⁸
2	RF power, conducted	0.46dB (30MHz-1GHz)
		0.55dB (1GHz-18GHz)
3	Radiated Spurious emission test	4.3dB (30MHz-1GHz)
		4.5dB (1GHz-12.75GHz)
4	Conduction emission	3.5dB (9kHz to 150kHz)
		3.1dB (150kHz to 30MHz)
5	Temperature test	0.64°C
6	Humidity test	3.8%
7	DC power voltages	0.026%

7 Equipment List

RF test system					
Equipment	Manufacturer	Model No.	Serial Number	Cal. Date (mm-dd-yyyy)	Cal. Due date (mm-dd-yyyy)
Spectrum Analyzer	Keysight	N9010A	MY54510339	02-17-2020	02-16-2021
Signal Generator	Keysight	N5182B	MY53051549	02-17-2020	02-16-2021
Temperature/ Humidity Indicator	biaozhi	HM10	1804186	06-29-2020	06-28-2021
High-pass filter	Sinoscite	FL3CX03WG18N M12-0398-002	---	---	---
High-pass filter	MICRO-TRONICS	SPA-F-63029-4	---	---	---
DC Power	Keysight	E3642A	MY56376072	02-17-2020	02-16-2021
PC-1	Lenovo	R4960d	---	---	---
BT&WI-FI Automatic control	R&S	OSP120	101374	02-17-2020	02-16-2021
RF control unit	JS Tonscend	JS0806-2	158060006	02-17-2020	02-16-2021
BT&WI-FI Automatic test software	JS Tonscend	JS1120-3	---	---	---

Conducted disturbance Test					
Equipment	Manufacturer	Model No.	Serial Number	Cal. date (mm-dd-yyyy)	Cal. Due date (mm-dd-yyyy)
Receiver	R&S	ESCI	100435	04-28-2020	04-27-2021
Temperature/ Humidity Indicator	Defu	TH128	/	---	---
LISN	R&S	ENV216	100098	03-05-2020	03-04-2021
Barometer	changchun	DYM3	1188	---	---

3M Semi/full-anechoic Chamber					
Equipment	Manufacturer	Model No.	Serial Number	Cal. date (mm-dd-yyyy)	Cal. Due date (mm-dd-yyyy)
3M Chamber & Accessory Equipment	TDK	SAC-3	---	05-24-2019	05-23-2022
TRILOG Broadband Antenna	Schwarzbeck	VULB9163	9163-618	05-16-2020	05-15-2021
Loop Antenna	Schwarzbeck	FMZB 1519B	1519B-076	04-25-2018	04-24-2021
Receiver	R&S	ESCI7	100938-003	10-21-2019	10-20-2020
Multi device Controller	matturo	NCD/070/1071112	---	---	---
Temperature/Humidity Indicator	Shanghai qixiang	HM10	1804298	06-29-2020	06-28-2021
Cable line	Fulai(7M)	SF106	5219/6A	---	---
Cable line	Fulai(6M)	SF106	5220/6A	---	---
Cable line	Fulai(3M)	SF106	5216/6A	---	---
Cable line	Fulai(3M)	SF106	5217/6A	---	---

3M full-anechoic Chamber					
Equipment	Manufacturer	Model No.	Serial Number	Cal. date (mm-dd-yyyy)	Cal. Due date (mm-dd-yyyy)
RSE Automatic test software	JS Tonscend	JS36-RSE	10166	---	---
Receiver	Keysight	N9038A	MY57290136	03-05-2020	03-04-2021
Spectrum Analyzer	Keysight	N9020B	MY57111112	03-05-2020	03-04-2021
Spectrum Analyzer	Keysight	N9030B	MY57140871	03-05-2020	03-04-2021
TRILOG Broadband Antenna	Schwarzbeck	VULB 9163	9163-1148	04-25-2018	04-24-2021
Horn Antenna	Schwarzbeck	BBHA 9170	9170-832	04-25-2018	04-24-2021
Horn Antenna	ETS-LINDGREN	3117	00057407	07-10-2018	07-09-2021
Preamplifier	EMCI	EMC184055SE	980596	05-20-2020	05-19-2021
Preamplifier	EMCI	EMC001330	980563	04-22-2020	04-21-2021
Preamplifier	JS Tonscend	980380	EMC051845 SE	01-09-2020	01-08-2021
Temperature/ Humidity Indicator	biaozhi	GM1360	EE1186631	04-27-2020	04-26-2021
Fully Anechoic Chamber	TDK	FAC-3	---	01-17-2018	01-16-2021
Filter bank	JS Tonscend	JS0806-F	188060094	04-10-2018	04-09-2021
Cable line	Times	SFT205-NMSM-2.50M	394812-0001	---	---
Cable line	Times	SFT205-NMSM-2.50M	394812-0002	---	---
Cable line	Times	SFT205-NMSM-2.50M	394812-0003	---	---
Cable line	Times	SFT205-NMSM-2.50M	393495-0001	---	---
Cable line	Times	EMC104-NMNM-1000	SN160710	---	---
Cable line	Times	SFT205-NMSM-3.00M	394813-0001	---	---
Cable line	Times	SFT205-NMNM-1.50M	381964-0001	---	---
Cable line	Times	SFT205-NMSM-7.00M	394815-0001	---	---
Cable line	Times	HF160-KMKM-3.00M	393493-0001	---	---

8 Radio Technical Requirements Specification

Reference documents for testing:

No.	Identity	Document Title
1	FCC Part15C	Subpart C-Intentional Radiators
2	ANSI C63.10-2013	American National Standard for Testing Unlicensed Wireless Devices

Test Results List:

Test requirement	Test method	Test item	Verdict	Note
Part15C Section 15.247 (a)(1)	ANSI 63.10	20dB Occupied Bandwidth	PASS	Appendix A)
Part15C Section 15.247 (a)(1)	ANSI 63.10	Carrier Frequencies Separation	PASS	Appendix B)
Part15C Section 15.247 (a)(1)	ANSI 63.10	Dwell Time	PASS	Appendix C)
Part15C Section 15.247 (b)	ANSI 63.10	Hopping Channel Number	PASS	Appendix D)
Part15C Section 15.247 (b)(1)	ANSI 63.10	Conducted Peak Output Power	PASS	Appendix E)
Part15C Section 15.247(d)	ANSI 63.10	Band-edge for RF Conducted Emissions	PASS	Appendix F)
Part15C Section 15.247(d)	ANSI 63.10	RF Conducted Spurious Emissions	PASS	Appendix G)
Part15C Section 15.247 (a)(1)	ANSI 63.10	Pseudorandom Frequency Hopping Sequence	PASS	Appendix H)
Part15C Section 15.203/15.247 (c)	ANSI 63.10	Antenna Requirement	PASS	Appendix I)
Part15C Section 15.207	ANSI 63.10	AC Power Line Conducted Emission	PASS	Appendix J)
Part15C Section 15.205/15.209	ANSI 63.10	Restricted bands around fundamental frequency (Radiated) Emission)	PASS	Appendix K)
Part15C Section 15.205/15.209	ANSI 63.10	Radiated Spurious Emissions	PASS	Appendix L)

**Duty Cycle
Result Table**

Test Mode	Channel	Duty Cycle [%]	Limit	Verdict
GFSK	LCH	76.76	---	PASS
	MCH	76.77	---	PASS
	HCH	76.76	---	PASS
$\pi/4$ DQPSK	LCH	76.89	---	PASS
	MCH	76.89	---	PASS
	HCH	76.89	---	PASS
8DPSK	LCH	76.96	---	PASS
	MCH	76.96	---	PASS
	HCH	76.96	---	PASS

Test Graph

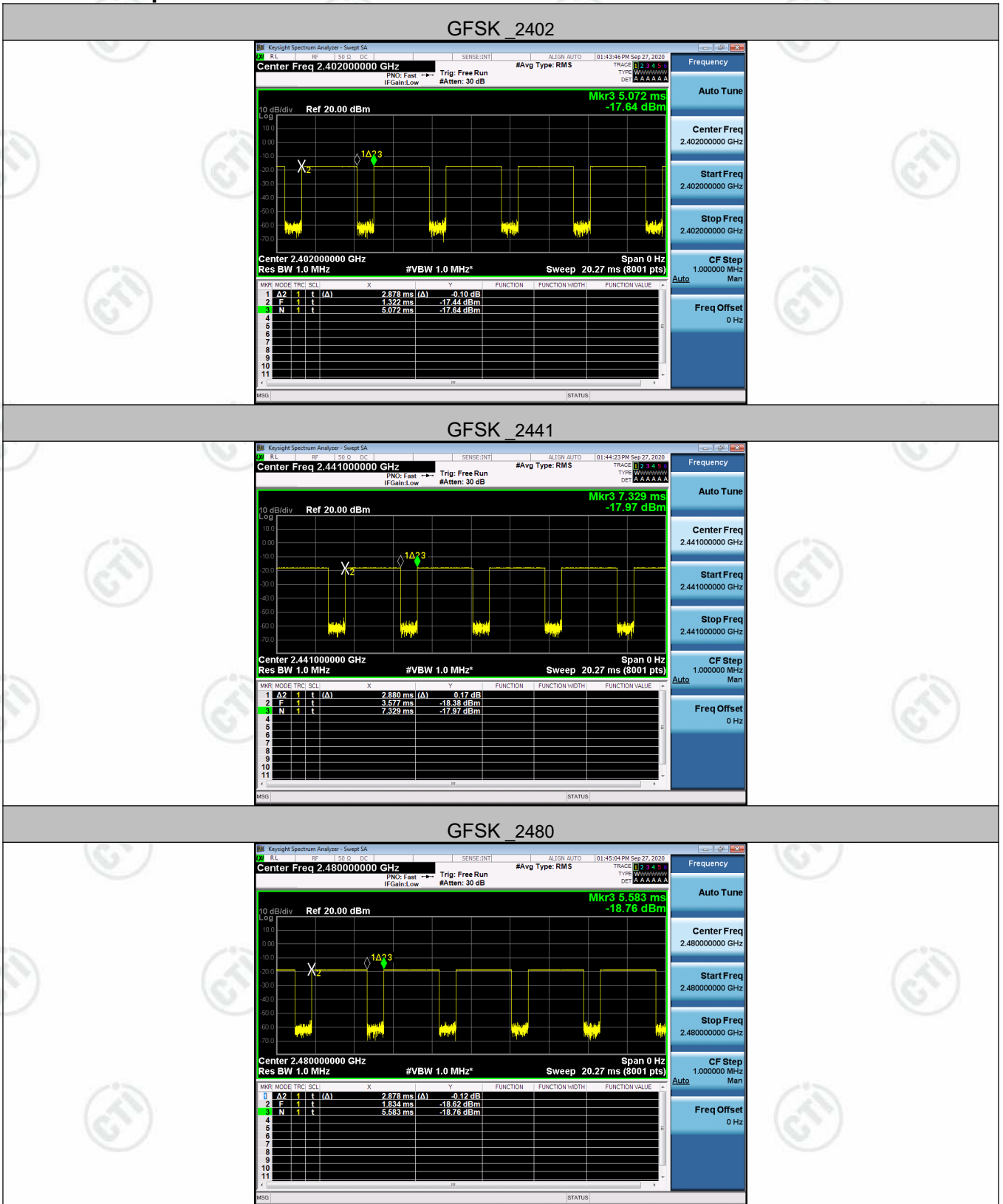

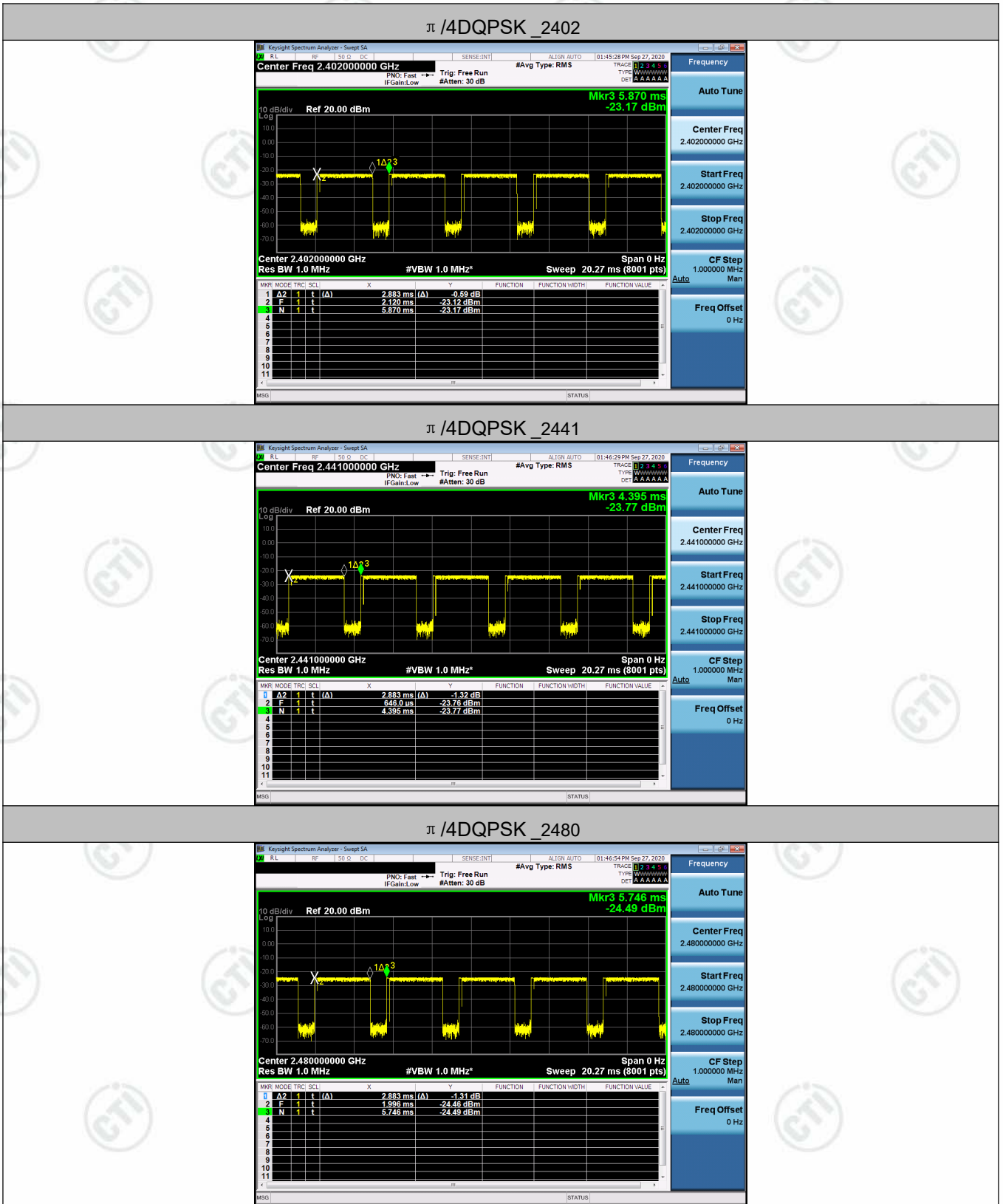

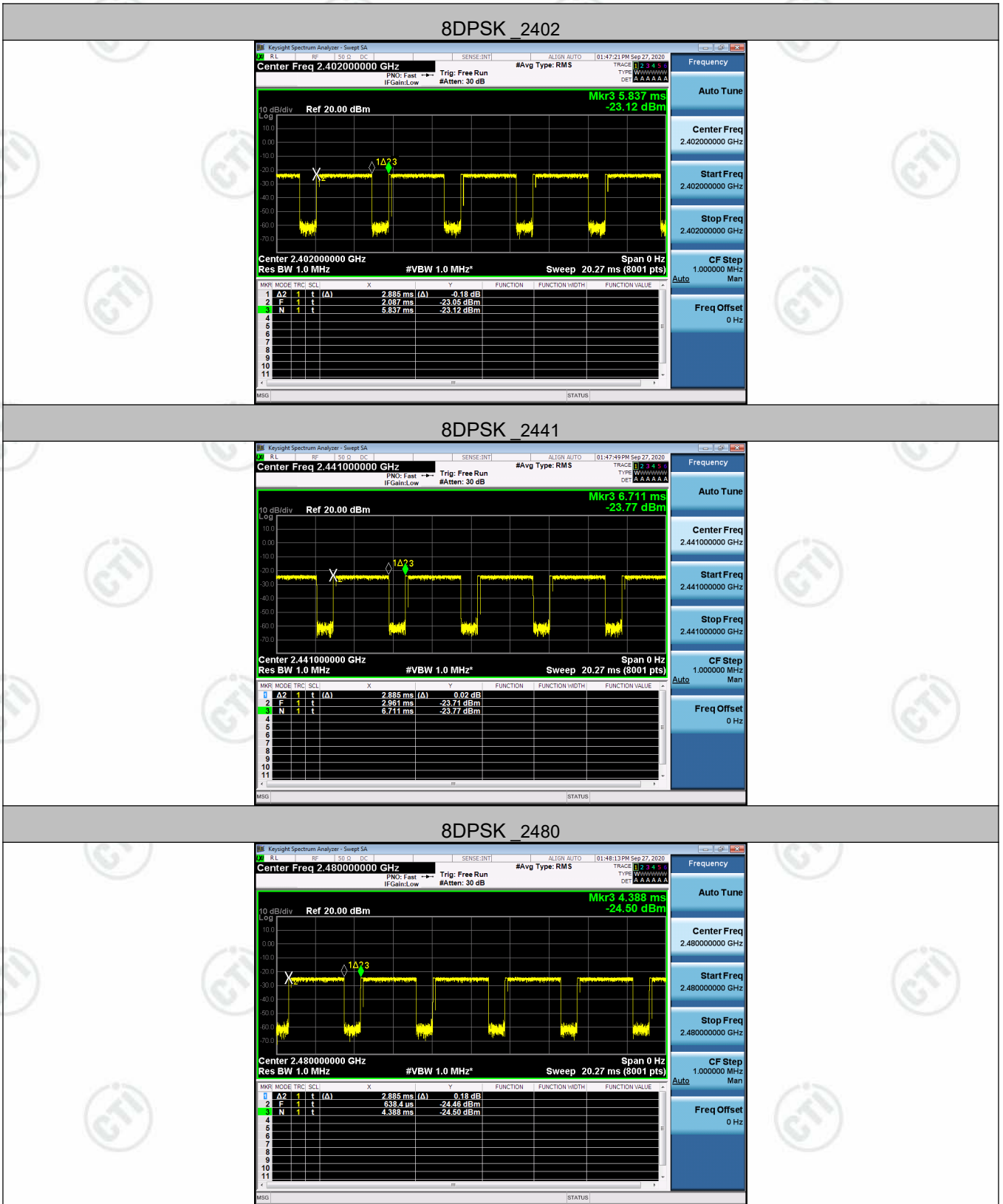

Appendix A): 20dB Occupied Bandwidth

Test Limit

According to §15.247(a) (1),

20 dB Bandwidth : For reporting purposes only.

Occupied Bandwidth(99%) : For reporting purposes only.

Test Procedure

Test method Refer as Section 8.1 and ANSI C63.10: 2013 clause 7.8.7,

1. The EUT RF output connected to the spectrum analyzer by RF cable.
2. Setting maximum power transmit of EUT
3. SA set RBW =30kHz, VBW = 100kHz and Detector = Peak, to measurement 20dB Bandwidth.
4. SA set RBW = 1% ~ 5% OBW, VBW = three times the RBW and Detector = Peak, to measurement 99% Bandwidth.
5. Measure and record the result of 20 dB Bandwidth and 99% Bandwidth. in the test report.
- 6.

Test Setup

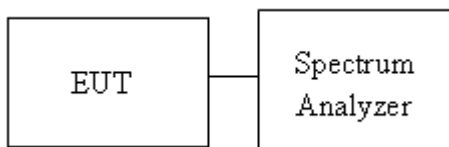

Test Result

Mode	Channel.	20dB Bandwidth [MHz]	99% OBW [MHz]	Verdict
GFSK	LCH	0.9588	0.86933	PASS
GFSK	MCH	0.9611	0.86810	PASS
GFSK	HCH	0.9636	0.86954	PASS
π /4DQPSK	LCH	1.490	1.3598	PASS
π /4DQPSK	MCH	1.516	1.3507	PASS
π /4DQPSK	HCH	1.515	1.3506	PASS
8DPSK	LCH	1.494	1.3546	PASS
8DPSK	MCH	1.492	1.3541	PASS
8DPSK	HCH	1.498	1.3577	PASS

Test Graph

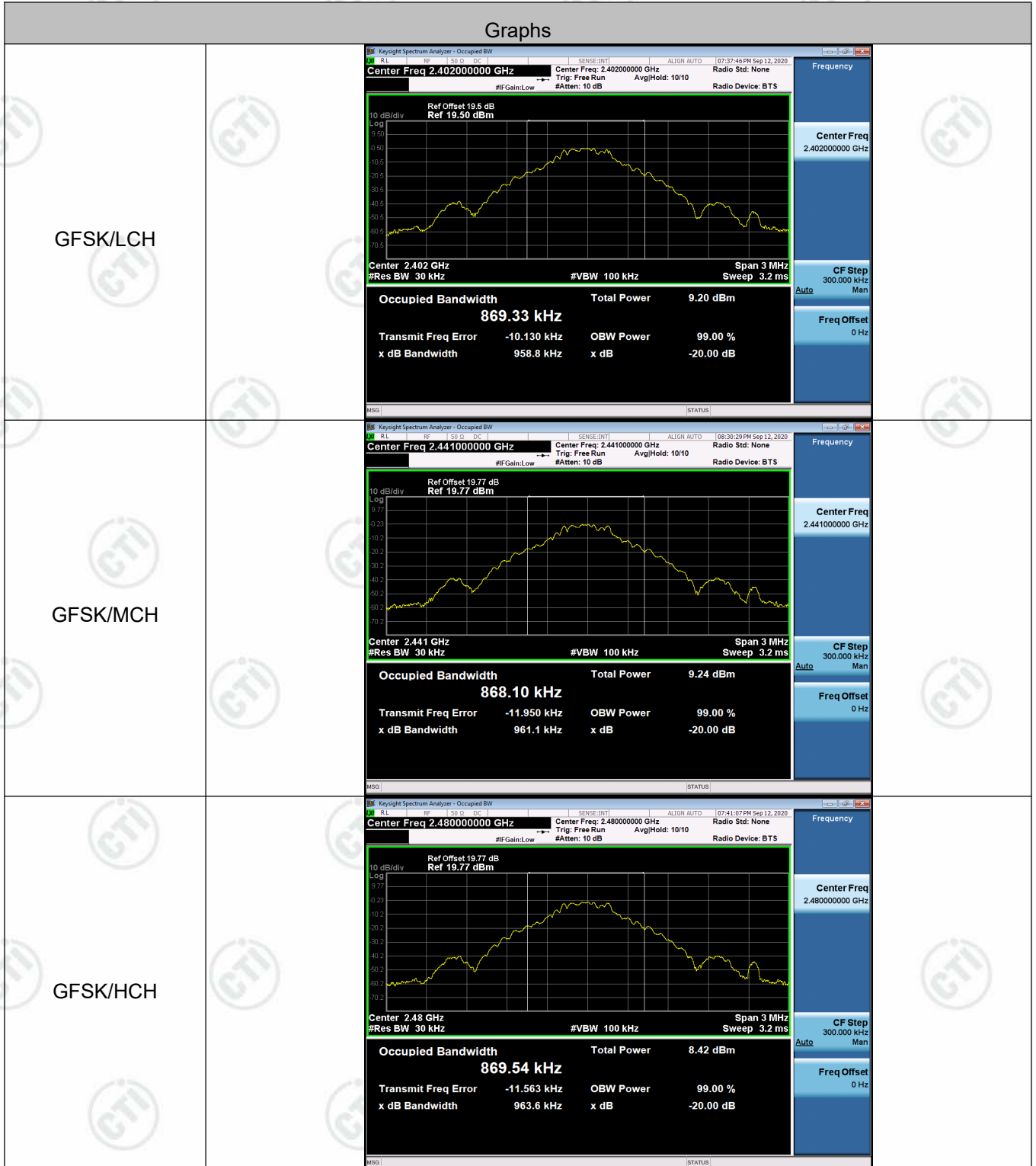

<p>$\pi/4$DQPSK/LCH</p>	
<p>$\pi/4$DQPSK/MCH</p>	
<p>$\pi/4$DQPSK/HCH</p>	

<p>8DPSK/LCH</p>	 <p>Center Freq 2.40200000 GHz</p> <p>Ref Offset 19.5 dB Ref 19.50 dBm</p> <p>Center: 2.402 GHz #Res BW 30 kHz #VBW 100 kHz Span 3 MHz Sweep 3.2 ms</p> <p>Occupied Bandwidth 1.3546 MHz Total Power 4.15 dBm</p> <p>Transmit Freq Error -14.658 kHz OBW Power 99.00 %</p> <p>x dB Bandwidth 1.494 MHz x dB -20.00 dB</p>
<p>8DPSK/MCH</p>	 <p>Center Freq 2.441000000 GHz</p> <p>Ref Offset 19.77 dB Ref 19.77 dBm</p> <p>Center: 2.441 GHz #Res BW 30 kHz #VBW 100 kHz Span 3 MHz Sweep 3.2 ms</p> <p>Occupied Bandwidth 1.3541 MHz Total Power 4.18 dBm</p> <p>Transmit Freq Error -13.546 kHz OBW Power 99.00 %</p> <p>x dB Bandwidth 1.492 MHz x dB -20.00 dB</p>
<p>8DPSK/HCH</p>	 <p>Center Freq 2.480000000 GHz</p> <p>Ref Offset 19.77 dB Ref 19.77 dBm</p> <p>Center: 2.48 GHz #Res BW 30 kHz #VBW 100 kHz Span 3 MHz Sweep 3.2 ms</p> <p>Occupied Bandwidth 1.3577 MHz Total Power 3.13 dBm</p> <p>Transmit Freq Error -14.363 kHz OBW Power 99.00 %</p> <p>x dB Bandwidth 1.498 MHz x dB -20.00 dB</p>

Appendix B): Carrier Frequency Separation

Test Limit

According to §15.247(a)(1),

Alternatively, frequency hopping systems operating in the 2400-2483.5 MHz band may have hopping channel carrier frequencies that are separated by 25 kHz or two-thirds of the 20 dB bandwidth of the hopping channel, whichever is greater, provided the systems operate with an output power no greater than 125 mW.

Limit	> two-thirds of the 20 dB bandwidth
-------	-------------------------------------

Test Procedure

1. Place the EUT on the table and set it in transmitting mode.
2. EUT RF output port connected to the SA by RF cable.
3. Set the spectrum analyzer as RBW = 30kHz, VBW = 100kHz, Sweep = auto.
Max hold, mark 3 peaks of hopping channel and record the 3 peaks frequency

Test Setup

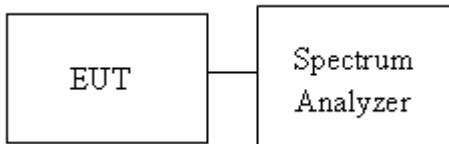

Result Table

Mode	Channel.	Carrier Frequency Separation [MHz]	Verdict
GFSK	LCH	0.968	PASS
GFSK	MCH	0.836	PASS
GFSK	HCH	1.034	PASS
$\pi/4$ DQPSK	LCH	1.158	PASS
$\pi/4$ DQPSK	MCH	1.104	PASS
$\pi/4$ DQPSK	HCH	1.156	PASS
8DPSK	LCH	1.006	PASS
8DPSK	MCH	1.004	PASS
8DPSK	HCH	1.008	PASS

Test Graph



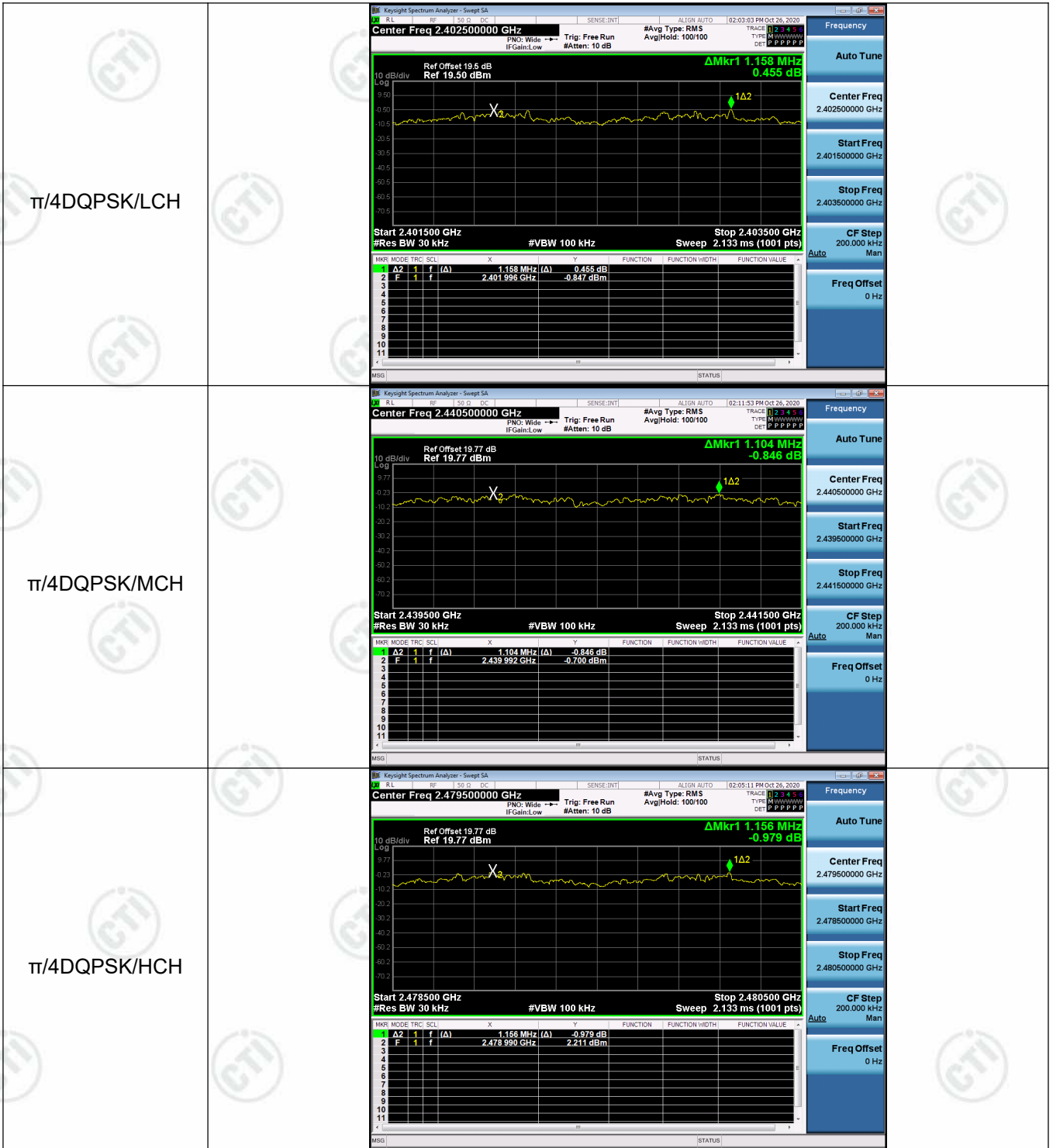

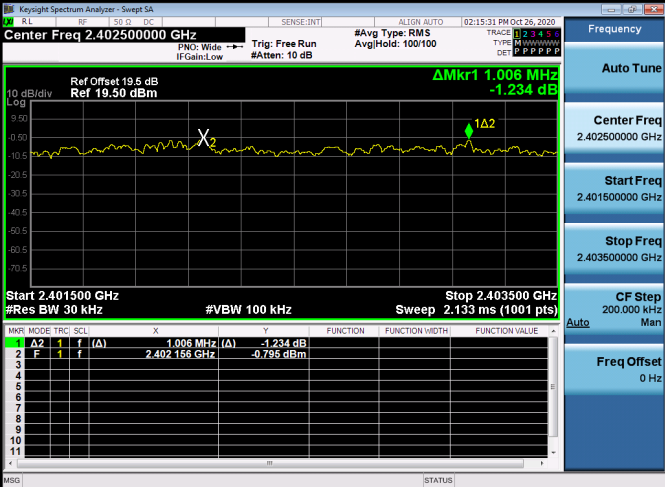
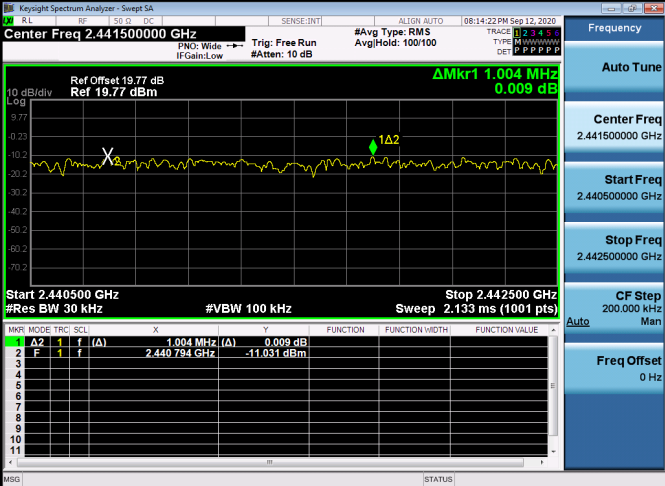
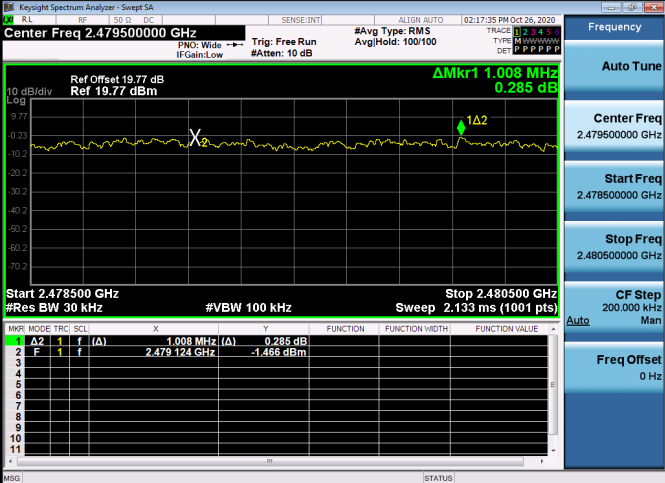
<p>8DPSK/LCH</p>	
<p>8DPSK/MCH</p>	
<p>8DPSK/HCH</p>	

Appendix C): Dwell Time

Test Limit

According to §15.247(a)(1)(iii),

The average time of occupancy on any channel shall not be greater than 0.4 seconds within a period of 0.4 seconds multiplied by the number of hopping channels employed.

Test Procedure

1. EUT RF output port connected to the SA by RF cable.
2. Set center frequency of spectrum analyzer = operating frequency.
3. Set the spectrum analyzer as RBW=1MHz, VBW=3MHz, Sweep = auto

Test Setup

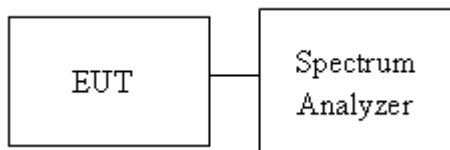

Result Table

Mode	Packet	Channel	Burst Width [ms/hop/ch]	Total Hops[hop*ch]	Dwell Time[s]	Duty Cycle [%]	Verdict
GFSK	DH1	LCH	0.378733	320	0.121	0.30	PASS
GFSK	DH1	MCH	0.37747	320	0.121	0.30	PASS
GFSK	DH1	HCH	0.3774667	320	0.121	0.30	PASS
GFSK	DH3	LCH	1.634003	160	0.261	0.65	PASS
GFSK	DH3	MCH	1.634003	160	0.261	0.65	PASS
GFSK	DH3	HCH	1.634	160	0.261	0.65	PASS
GFSK	DH5	LCH	2.8704	106.7	0.306	0.76	PASS
GFSK	DH5	MCH	2.8612	106.7	0.305	0.76	PASS
GFSK	DH5	HCH	2.8704	106.7	0.306	0.76	PASS

Test Graph

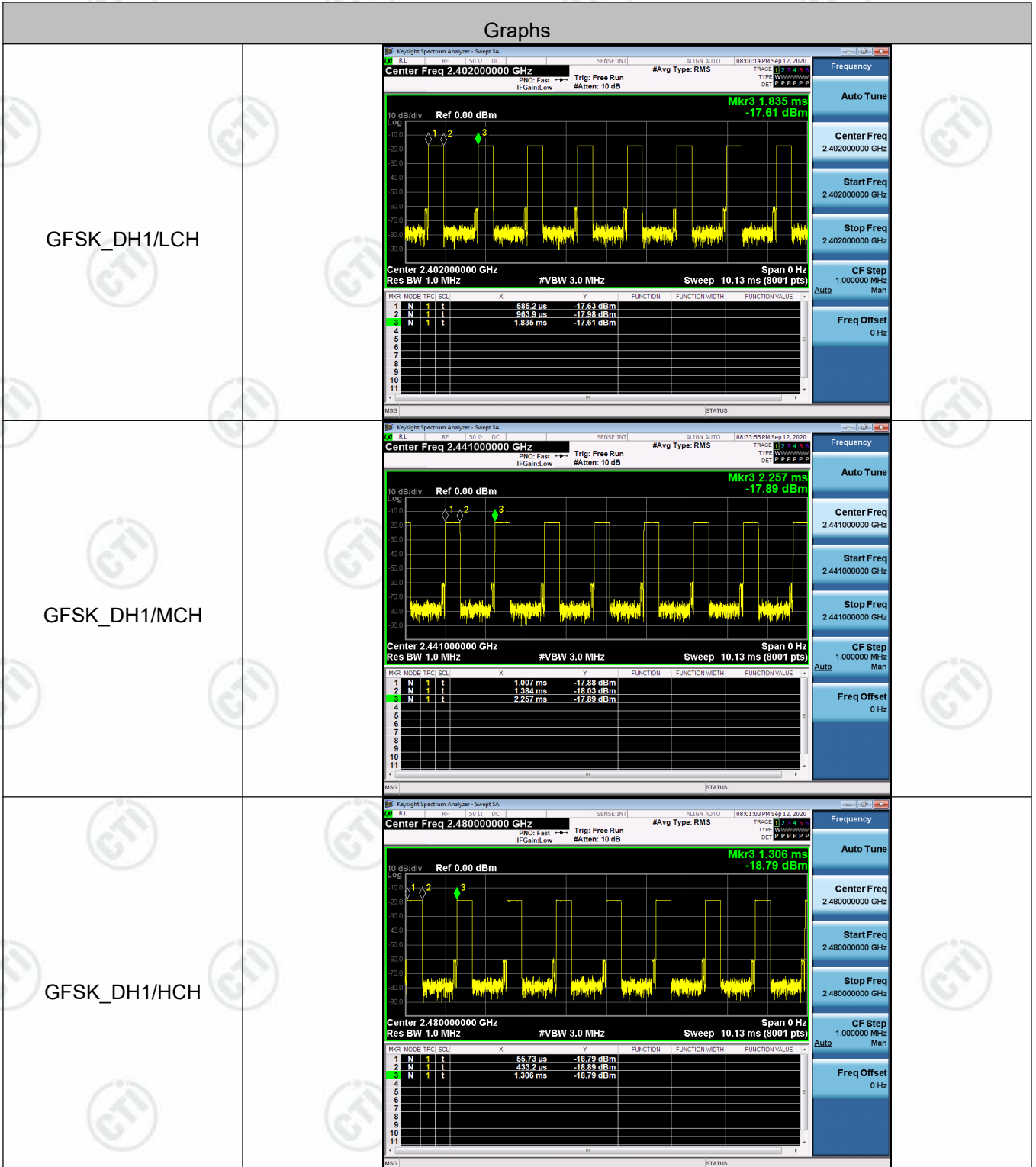

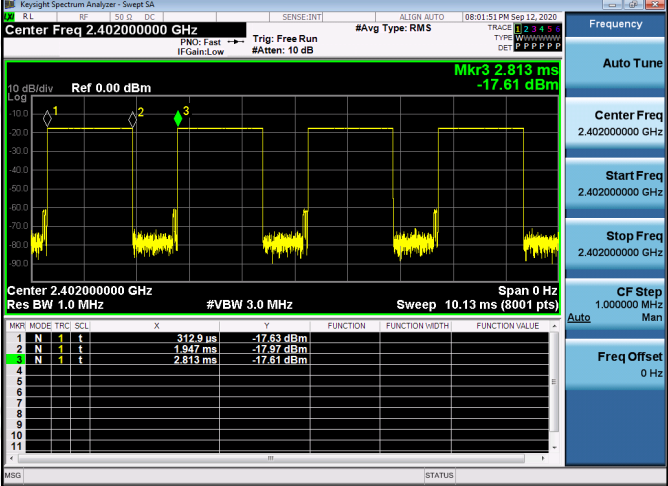
<p>GFSK_DH3/LCH</p>	 <table border="1"> <thead> <tr> <th>MKR</th> <th>MODE</th> <th>TRIG</th> <th>SCL</th> <th>X</th> <th>Y</th> <th>FUNCTION</th> <th>FUNCTION WIDTH</th> <th>FUNCTION VALUE</th> </tr> </thead> <tbody> <tr> <td>1</td> <td>N</td> <td>1</td> <td>t</td> <td>312.9 ms</td> <td>-17.63 dBm</td> <td></td> <td></td> <td></td> </tr> <tr> <td>2</td> <td>N</td> <td>1</td> <td>t</td> <td>1.947 ms</td> <td>-17.97 dBm</td> <td></td> <td></td> <td></td> </tr> <tr> <td>3</td> <td>N</td> <td>1</td> <td>t</td> <td>2.813 ms</td> <td>-17.61 dBm</td> <td></td> <td></td> <td></td> </tr> </tbody> </table>	MKR	MODE	TRIG	SCL	X	Y	FUNCTION	FUNCTION WIDTH	FUNCTION VALUE	1	N	1	t	312.9 ms	-17.63 dBm				2	N	1	t	1.947 ms	-17.97 dBm				3	N	1	t	2.813 ms	-17.61 dBm				<p>Frequency</p> <p>Auto Tune</p> <p>Center Freq 2.402000000 GHz</p> <p>Start Freq 2.402000000 GHz</p> <p>Stop Freq 2.402000000 GHz</p> <p>CF Step 1.000000 MHz Man</p> <p>Freq Offset 0 Hz</p>
MKR	MODE	TRIG	SCL	X	Y	FUNCTION	FUNCTION WIDTH	FUNCTION VALUE																														
1	N	1	t	312.9 ms	-17.63 dBm																																	
2	N	1	t	1.947 ms	-17.97 dBm																																	
3	N	1	t	2.813 ms	-17.61 dBm																																	
<p>GFSK_DH3/MCH</p>	 <table border="1"> <thead> <tr> <th>MKR</th> <th>MODE</th> <th>TRIG</th> <th>SCL</th> <th>X</th> <th>Y</th> <th>FUNCTION</th> <th>FUNCTION WIDTH</th> <th>FUNCTION VALUE</th> </tr> </thead> <tbody> <tr> <td>1</td> <td>N</td> <td>1</td> <td>t</td> <td>317.1 ms</td> <td>-17.88 dBm</td> <td></td> <td></td> <td></td> </tr> <tr> <td>2</td> <td>N</td> <td>1</td> <td>t</td> <td>2.551 ms</td> <td>-18.31 dBm</td> <td></td> <td></td> <td></td> </tr> <tr> <td>3</td> <td>N</td> <td>1</td> <td>t</td> <td>3.417 ms</td> <td>-17.91 dBm</td> <td></td> <td></td> <td></td> </tr> </tbody> </table>	MKR	MODE	TRIG	SCL	X	Y	FUNCTION	FUNCTION WIDTH	FUNCTION VALUE	1	N	1	t	317.1 ms	-17.88 dBm				2	N	1	t	2.551 ms	-18.31 dBm				3	N	1	t	3.417 ms	-17.91 dBm				<p>Frequency</p> <p>Auto Tune</p> <p>Center Freq 2.441000000 GHz</p> <p>Start Freq 2.441000000 GHz</p> <p>Stop Freq 2.441000000 GHz</p> <p>CF Step 1.000000 MHz Man</p> <p>Freq Offset 0 Hz</p>
MKR	MODE	TRIG	SCL	X	Y	FUNCTION	FUNCTION WIDTH	FUNCTION VALUE																														
1	N	1	t	317.1 ms	-17.88 dBm																																	
2	N	1	t	2.551 ms	-18.31 dBm																																	
3	N	1	t	3.417 ms	-17.91 dBm																																	
<p>GFSK_DH3/HCH</p>	 <table border="1"> <thead> <tr> <th>MKR</th> <th>MODE</th> <th>TRIG</th> <th>SCL</th> <th>X</th> <th>Y</th> <th>FUNCTION</th> <th>FUNCTION WIDTH</th> <th>FUNCTION VALUE</th> </tr> </thead> <tbody> <tr> <td>1</td> <td>N</td> <td>1</td> <td>t</td> <td>418.0 ms</td> <td>-18.82 dBm</td> <td></td> <td></td> <td></td> </tr> <tr> <td>2</td> <td>N</td> <td>1</td> <td>t</td> <td>2.052 ms</td> <td>-19.19 dBm</td> <td></td> <td></td> <td></td> </tr> <tr> <td>3</td> <td>N</td> <td>1</td> <td>t</td> <td>2.918 ms</td> <td>-18.82 dBm</td> <td></td> <td></td> <td></td> </tr> </tbody> </table>	MKR	MODE	TRIG	SCL	X	Y	FUNCTION	FUNCTION WIDTH	FUNCTION VALUE	1	N	1	t	418.0 ms	-18.82 dBm				2	N	1	t	2.052 ms	-19.19 dBm				3	N	1	t	2.918 ms	-18.82 dBm				<p>Frequency</p> <p>Auto Tune</p> <p>Center Freq 2.480000000 GHz</p> <p>Start Freq 2.480000000 GHz</p> <p>Stop Freq 2.480000000 GHz</p> <p>CF Step 1.000000 MHz Man</p> <p>Freq Offset 0 Hz</p>
MKR	MODE	TRIG	SCL	X	Y	FUNCTION	FUNCTION WIDTH	FUNCTION VALUE																														
1	N	1	t	418.0 ms	-18.82 dBm																																	
2	N	1	t	2.052 ms	-19.19 dBm																																	
3	N	1	t	2.918 ms	-18.82 dBm																																	

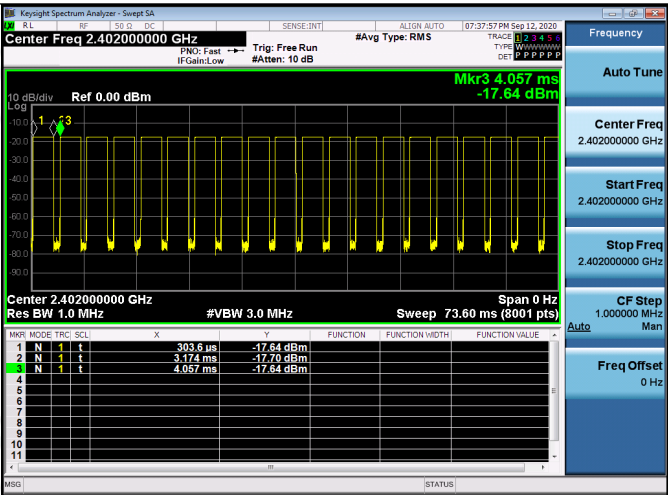
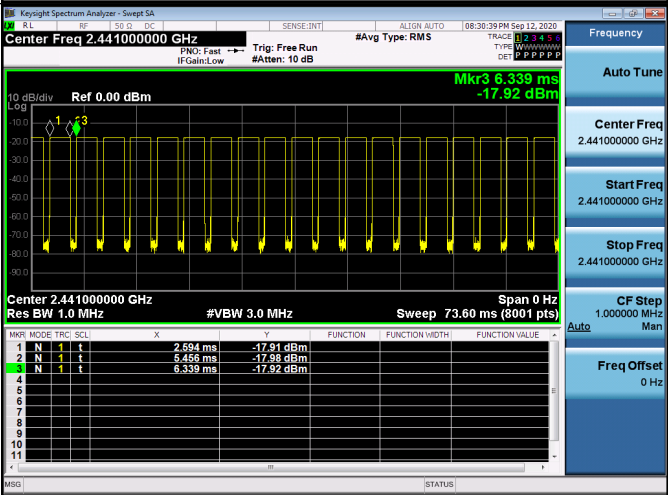
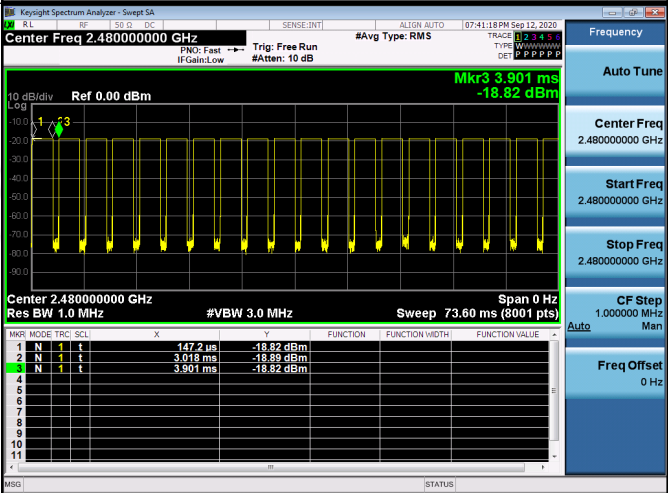
<p>GFSK_DH5/LCH</p>	 <table border="1"> <thead> <tr> <th>MKR</th> <th>MODE</th> <th>TRIG</th> <th>SCL</th> <th>X</th> <th>Y</th> <th>FUNCTION</th> <th>FUNCTION WIDTH</th> <th>FUNCTION VALUE</th> </tr> </thead> <tbody> <tr> <td>1</td> <td>N</td> <td>1</td> <td>t</td> <td>303.6 ms</td> <td>-17.64 dBm</td> <td></td> <td></td> <td></td> </tr> <tr> <td>2</td> <td>N</td> <td>1</td> <td>t</td> <td>3.173 ms</td> <td>-17.70 dBm</td> <td></td> <td></td> <td></td> </tr> <tr> <td>3</td> <td>N</td> <td>1</td> <td>t</td> <td>4.057 ms</td> <td>-17.64 dBm</td> <td></td> <td></td> <td></td> </tr> </tbody> </table>	MKR	MODE	TRIG	SCL	X	Y	FUNCTION	FUNCTION WIDTH	FUNCTION VALUE	1	N	1	t	303.6 ms	-17.64 dBm				2	N	1	t	3.173 ms	-17.70 dBm				3	N	1	t	4.057 ms	-17.64 dBm				<p>Frequency</p> <p>Auto Tune</p> <p>Center Freq 2.40200000 GHz</p> <p>Start Freq 2.40200000 GHz</p> <p>Stop Freq 2.40200000 GHz</p> <p>CF Step 1.000000 MHz</p> <p>Freq Offset 0 Hz</p>
MKR	MODE	TRIG	SCL	X	Y	FUNCTION	FUNCTION WIDTH	FUNCTION VALUE																														
1	N	1	t	303.6 ms	-17.64 dBm																																	
2	N	1	t	3.173 ms	-17.70 dBm																																	
3	N	1	t	4.057 ms	-17.64 dBm																																	
<p>GFSK_DH5/MCH</p>	 <table border="1"> <thead> <tr> <th>MKR</th> <th>MODE</th> <th>TRIG</th> <th>SCL</th> <th>X</th> <th>Y</th> <th>FUNCTION</th> <th>FUNCTION WIDTH</th> <th>FUNCTION VALUE</th> </tr> </thead> <tbody> <tr> <td>1</td> <td>N</td> <td>1</td> <td>t</td> <td>2.694 ms</td> <td>-17.81 dBm</td> <td></td> <td></td> <td></td> </tr> <tr> <td>2</td> <td>N</td> <td>1</td> <td>t</td> <td>5.455 ms</td> <td>-17.59 dBm</td> <td></td> <td></td> <td></td> </tr> <tr> <td>3</td> <td>N</td> <td>1</td> <td>t</td> <td>6.339 ms</td> <td>-17.92 dBm</td> <td></td> <td></td> <td></td> </tr> </tbody> </table>	MKR	MODE	TRIG	SCL	X	Y	FUNCTION	FUNCTION WIDTH	FUNCTION VALUE	1	N	1	t	2.694 ms	-17.81 dBm				2	N	1	t	5.455 ms	-17.59 dBm				3	N	1	t	6.339 ms	-17.92 dBm				<p>Frequency</p> <p>Auto Tune</p> <p>Center Freq 2.44100000 GHz</p> <p>Start Freq 2.44100000 GHz</p> <p>Stop Freq 2.44100000 GHz</p> <p>CF Step 1.000000 MHz</p> <p>Freq Offset 0 Hz</p>
MKR	MODE	TRIG	SCL	X	Y	FUNCTION	FUNCTION WIDTH	FUNCTION VALUE																														
1	N	1	t	2.694 ms	-17.81 dBm																																	
2	N	1	t	5.455 ms	-17.59 dBm																																	
3	N	1	t	6.339 ms	-17.92 dBm																																	
<p>GFSK_DH5/HCH</p>	 <table border="1"> <thead> <tr> <th>MKR</th> <th>MODE</th> <th>TRIG</th> <th>SCL</th> <th>X</th> <th>Y</th> <th>FUNCTION</th> <th>FUNCTION WIDTH</th> <th>FUNCTION VALUE</th> </tr> </thead> <tbody> <tr> <td>1</td> <td>N</td> <td>1</td> <td>t</td> <td>147.2 ms</td> <td>-18.82 dBm</td> <td></td> <td></td> <td></td> </tr> <tr> <td>2</td> <td>N</td> <td>1</td> <td>t</td> <td>3.018 ms</td> <td>-18.89 dBm</td> <td></td> <td></td> <td></td> </tr> <tr> <td>3</td> <td>N</td> <td>1</td> <td>t</td> <td>3.901 ms</td> <td>-18.82 dBm</td> <td></td> <td></td> <td></td> </tr> </tbody> </table>	MKR	MODE	TRIG	SCL	X	Y	FUNCTION	FUNCTION WIDTH	FUNCTION VALUE	1	N	1	t	147.2 ms	-18.82 dBm				2	N	1	t	3.018 ms	-18.89 dBm				3	N	1	t	3.901 ms	-18.82 dBm				<p>Frequency</p> <p>Auto Tune</p> <p>Center Freq 2.48000000 GHz</p> <p>Start Freq 2.48000000 GHz</p> <p>Stop Freq 2.48000000 GHz</p> <p>CF Step 1.000000 MHz</p> <p>Freq Offset 0 Hz</p>
MKR	MODE	TRIG	SCL	X	Y	FUNCTION	FUNCTION WIDTH	FUNCTION VALUE																														
1	N	1	t	147.2 ms	-18.82 dBm																																	
2	N	1	t	3.018 ms	-18.89 dBm																																	
3	N	1	t	3.901 ms	-18.82 dBm																																	

Appendix D): Hopping Channel Number Test Limit

According to §15.247(a)(1)(iii)

Frequency hopping systems in the 2400-2483.5 MHz band shall use at least 15 channels.

Test Procedure

Test method Refer as ANSI C63.10: 2013 clause 7.8.3

1. Place the EUT on the table and set it in transmitting mode.
2. EUT RF output port connected to the SA by RF cable.
3. Set spectrum analyzer Start Freq. = 2400 MHz, Stop Freq. = 2483.5 MHz, RBW =100KHz, VBW = 300KHz.
4. Max hold, view and count how many channel in the band.

Test Setup

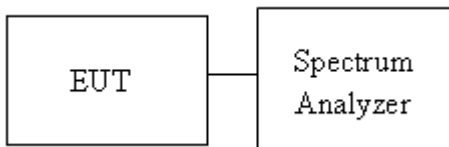

Result Table

Mode	Channel.	Number of Hopping Channel	Verdict
GFSK	Hop	79	PASS
$\pi/4$ DQPSK	Hop	79	PASS
8DPSK	Hop	79	PASS

Test Graph

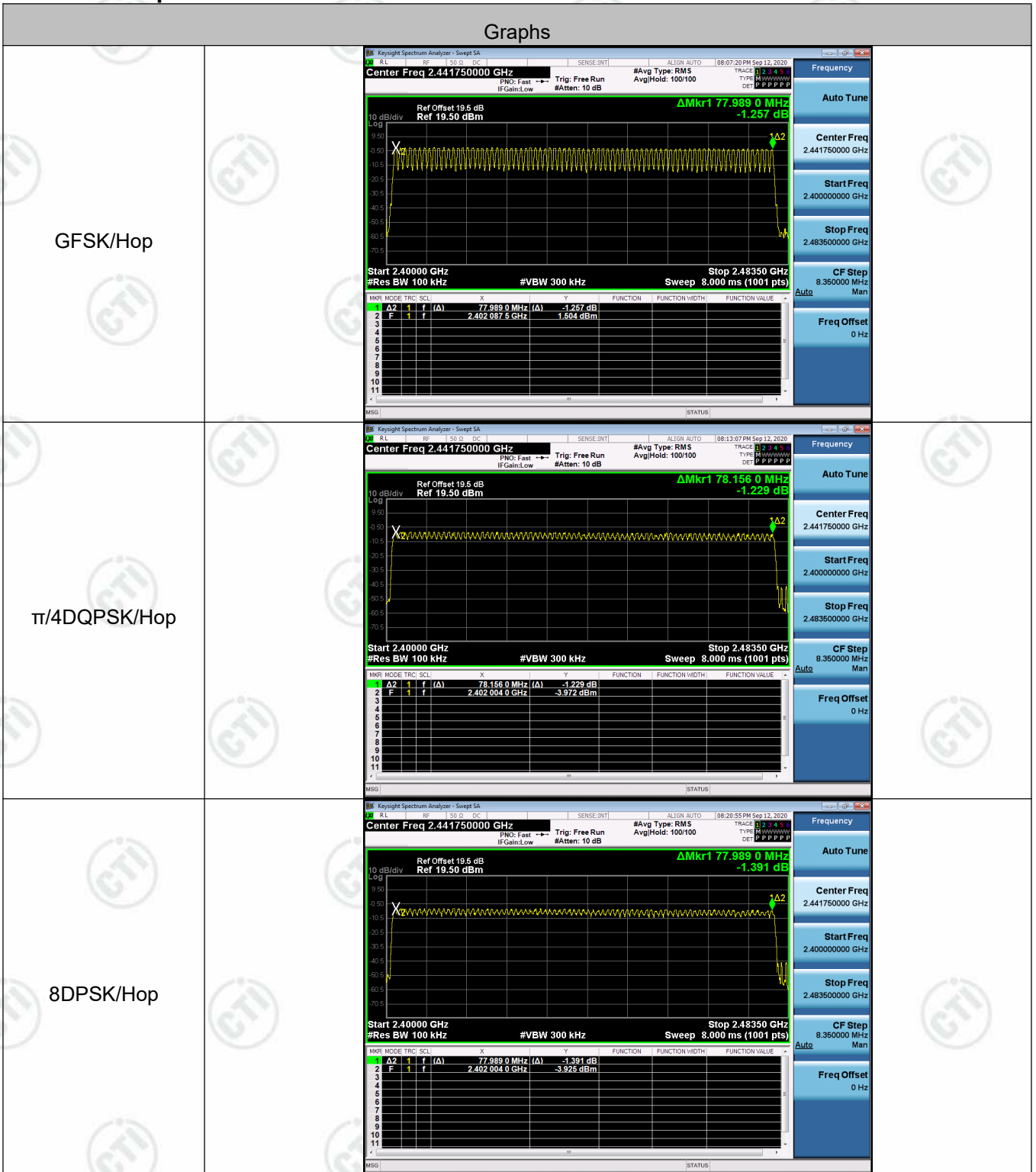

Appendix E): Conducted Peak Output Power Test Limit

According to §15.247(b)(1).

Peak output power :

FCC

Alternatively, frequency hopping systems operating in the 2400-2483.5 MHz band may have hopping channel carrier frequencies that are separated by 25 kHz or two-thirds of the 20 dB bandwidth of the hopping channel, whichever is greater, provided the systems operate with an output power no greater than 125 mW.

Limit	<input checked="" type="checkbox"/> Antenna not exceed 6 dBi : 21dBm <input type="checkbox"/> Antenna with DG greater than 6 dBi : 21dBm [Limit = 30 – (DG – 6)]
-------	--

Average output power : For reporting purposes only.

Test Procedure

1. The EUT RF output connected to the spectrum analyzer by RF cable.
2. Setting maximum power transmit of EUT.
3. Spectrum analyzer settings are as follows :
 - a) Span: Approximately five times the 20 dB bandwidth, centered on a hopping channel.
 - b) RBW > 20 dB bandwidth of the emission being measured.
 - c) VBW ≥ RBW.
 - d) Sweep: Auto.
 - e) Detector function: Peak.
 - f) Trace: Max hold.
 - g) Allow trace to stabilize.
 - h) Use the marker-to-peak function to set the marker to the peak of the emission
4. Measure and record the result in the test report.

Test Setup

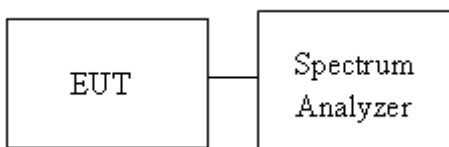

Result Table

Mode	Channel.	Maximum Peak Output Power [dBm]	Verdict
GFSK	LCH	1.893	PASS
GFSK	MCH	1.881	PASS
GFSK	HCH	0.990	PASS
$\pi/4$ DQPSK	LCH	-1.526	PASS
$\pi/4$ DQPSK	MCH	-1.583	PASS
$\pi/4$ DQPSK	HCH	-2.565	PASS
8DPSK	LCH	-1.255	PASS
8DPSK	MCH	-1.336	PASS
8DPSK	HCH	-2.340	PASS

Test Graph

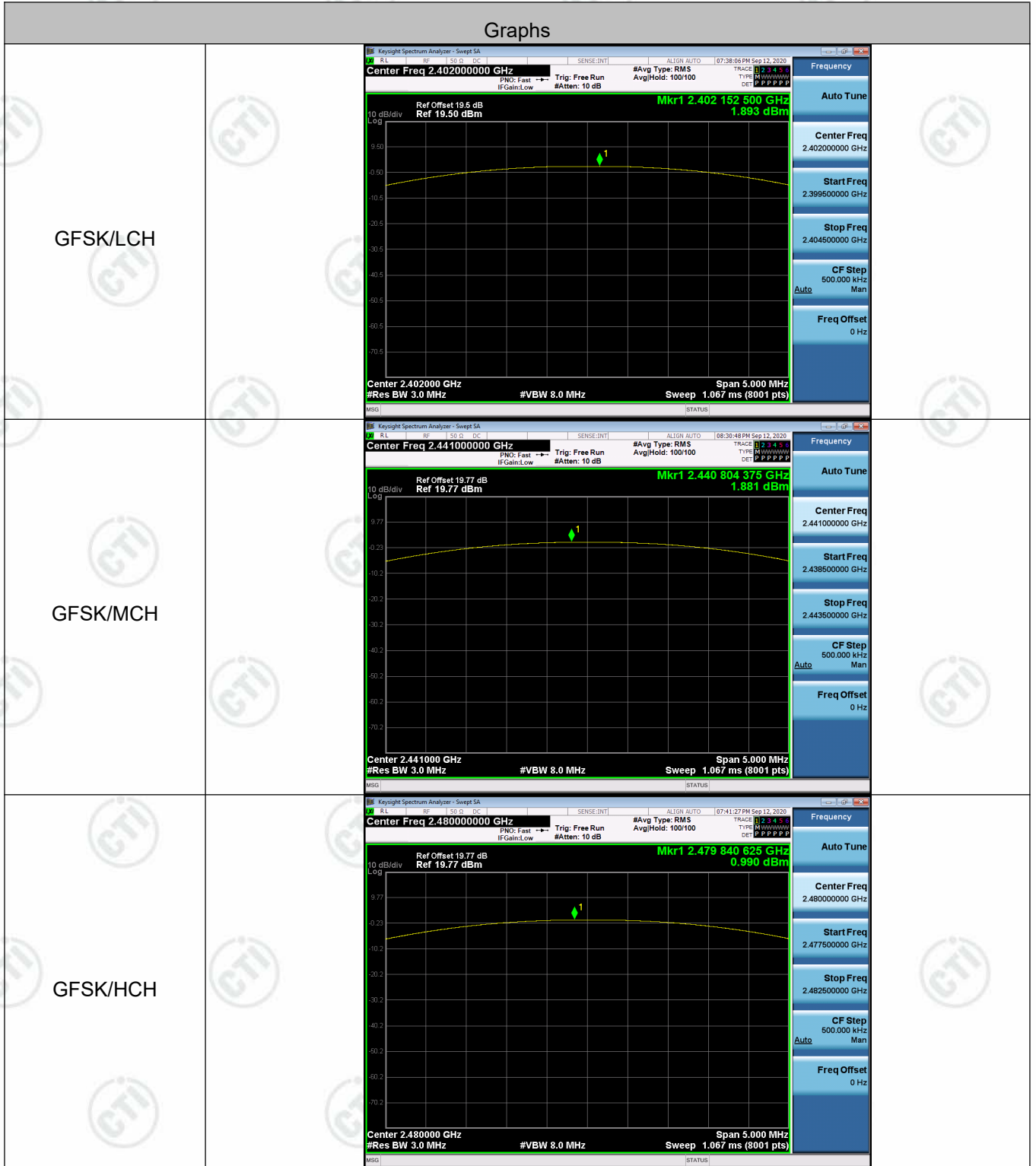

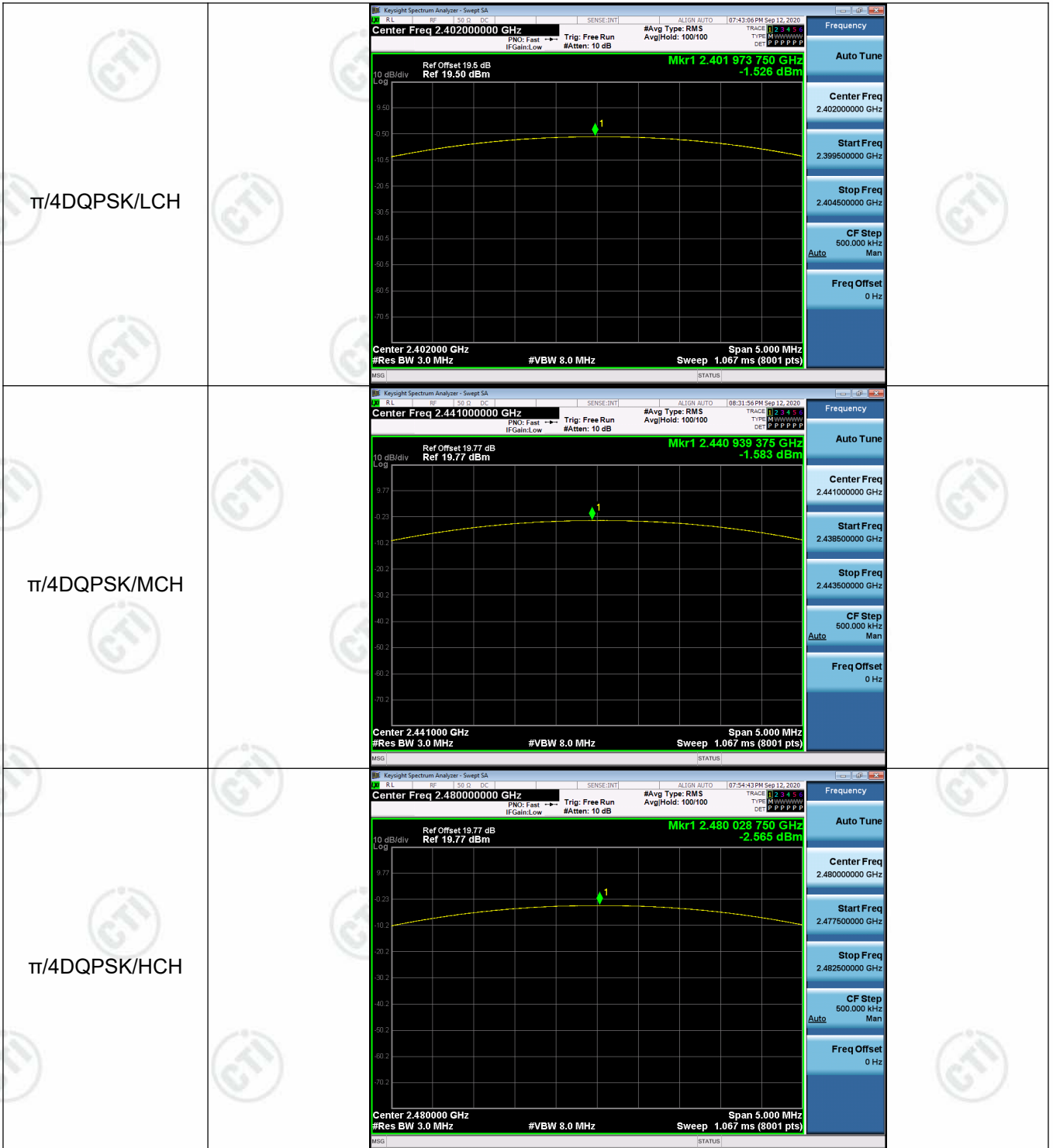

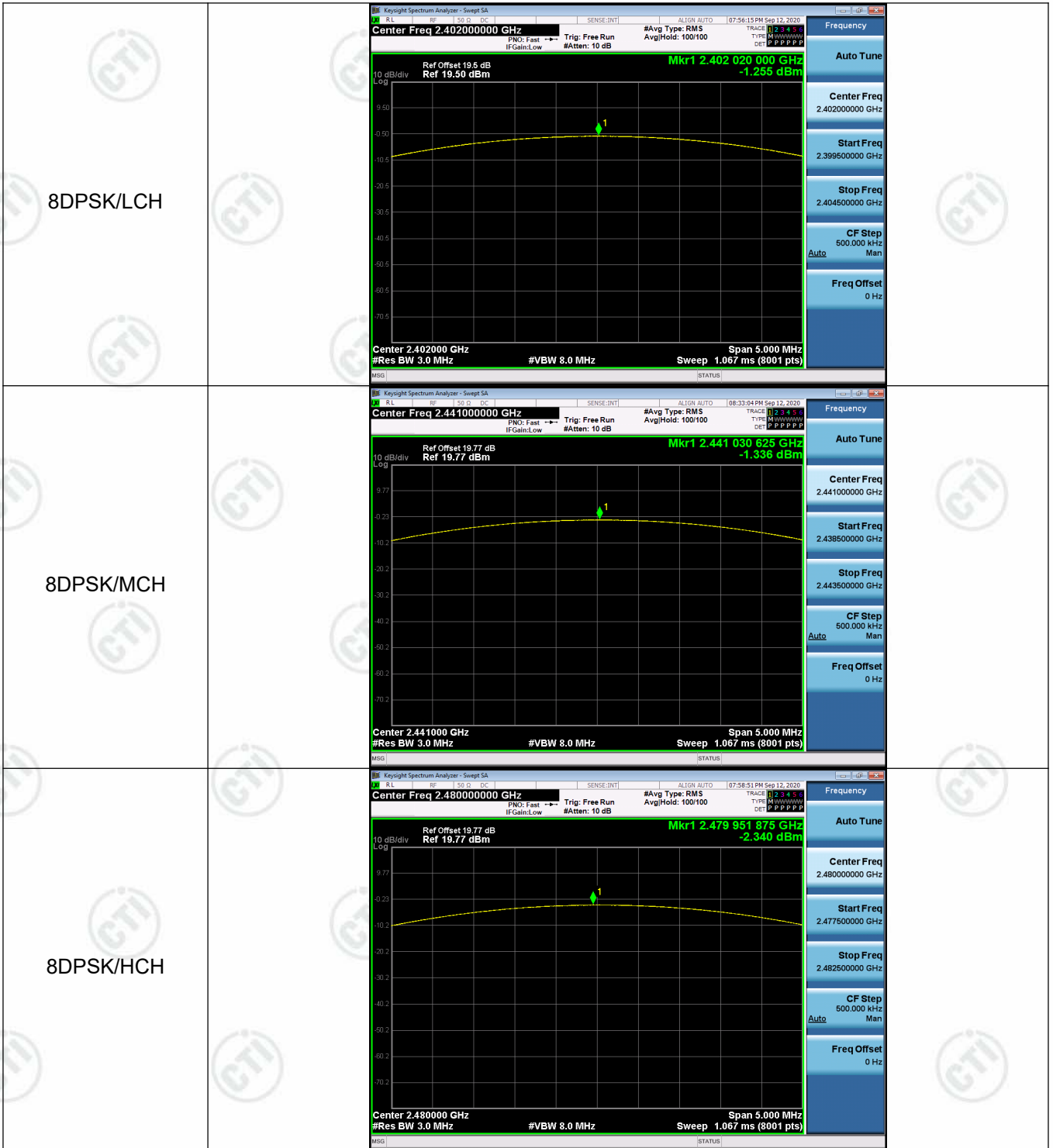

Appendix F): Band-edge for RF Conducted Emissions

Test Limit

According to §15.247(d),

Limit	-20 dBc
-------	---------

Test Procedure

1. EUT RF output port connected to the SA by RF cable, and the path loss was compensated to result.
2. SA setting, RBW=100kHz, VBW=300kHz, Detector=Peak, Trace mode = max hold, SWT = Auto.
3. The Band Edge at 2.4GHz and 2.4835GHz are investigated with normal hopping mode.

Test Setup

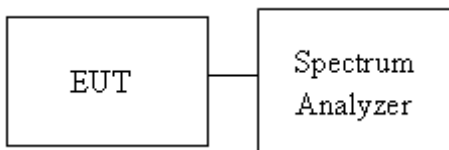

Result Table

Mode	Channel	Carrier Frequency [MHz]	Carrier Power [dBm]	Frequency Hopping	Max Spurious Level [dBm]	Limit [dBm]	Verdict
GFSK	LCH	2402	1.740	Off	-60.243	-18.26	PASS
			1.694	On	-57.643	-18.31	PASS
GFSK	HCH	2480	0.952	Off	-41.079	-19.05	PASS
			0.898	On	-44.733	-19.1	PASS
π/4DQPSK	LCH	2402	-3.967	Off	-60.627	-23.97	PASS
			-3.845	On	-59.251	-23.85	PASS
π/4DQPSK	HCH	2480	-4.947	Off	-41.223	-24.95	PASS
			-4.844	On	-56.947	-24.84	PASS
8DPSK	LCH	2402	-3.862	Off	-59.733	-23.86	PASS
			-3.900	On	-59.941	-23.9	PASS
8DPSK	HCH	2480	-5.060	Off	-41.476	-25.06	PASS
			-4.561	On	-42.207	-24.56	PASS

Test Graph

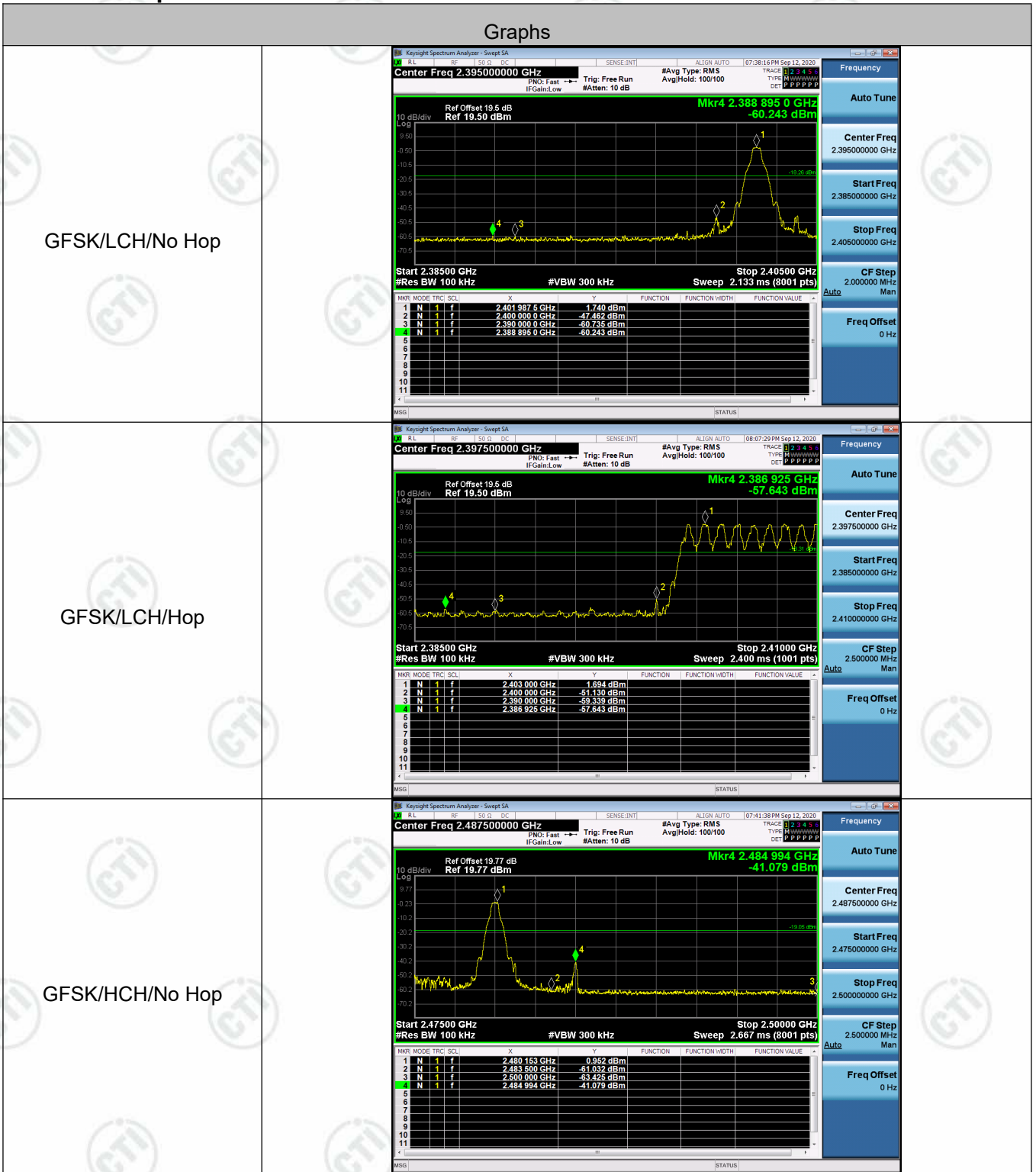

<p>GFSK/HCH/Hop</p>	<p>KeySight Spectrum Analyzer - Swept SA</p> <p>Center Freq 2.48500000 GHz</p> <p>Ref Offset: 19.77 dB Ref 19.77 dBm</p> <p>Mkr4 2.483 95 GHz -44.733 dBm</p> <p>Start 2.47000 GHz #Res BW 100 kHz</p> <p>#VBW 300 kHz Sweep 2.933 ms (1001 pts)</p> <table border="1"> <thead> <tr> <th>MKR</th> <th>MODE</th> <th>TRC</th> <th>SCL</th> <th>X</th> <th>Y</th> <th>FUNCTION</th> <th>FUNCTION WIDTH</th> <th>FUNCTION VALUE</th> </tr> </thead> <tbody> <tr> <td>1</td> <td>N</td> <td>1</td> <td>f</td> <td>2.472 97 GHz</td> <td>0.898 dBm</td> <td></td> <td></td> <td></td> </tr> <tr> <td>2</td> <td>N</td> <td>1</td> <td>f</td> <td>2.483 50 GHz</td> <td>-51.048 dBm</td> <td></td> <td></td> <td></td> </tr> <tr> <td>3</td> <td>N</td> <td>1</td> <td>f</td> <td>2.500 00 GHz</td> <td>-57.022 dBm</td> <td></td> <td></td> <td></td> </tr> <tr> <td>4</td> <td>N</td> <td>1</td> <td>f</td> <td>2.483 95 GHz</td> <td>-44.733 dBm</td> <td></td> <td></td> <td></td> </tr> </tbody> </table>	MKR	MODE	TRC	SCL	X	Y	FUNCTION	FUNCTION WIDTH	FUNCTION VALUE	1	N	1	f	2.472 97 GHz	0.898 dBm				2	N	1	f	2.483 50 GHz	-51.048 dBm				3	N	1	f	2.500 00 GHz	-57.022 dBm				4	N	1	f	2.483 95 GHz	-44.733 dBm			
MKR	MODE	TRC	SCL	X	Y	FUNCTION	FUNCTION WIDTH	FUNCTION VALUE																																						
1	N	1	f	2.472 97 GHz	0.898 dBm																																									
2	N	1	f	2.483 50 GHz	-51.048 dBm																																									
3	N	1	f	2.500 00 GHz	-57.022 dBm																																									
4	N	1	f	2.483 95 GHz	-44.733 dBm																																									
<p>$\pi/4$DQPSK/LCH/No Hop</p>	<p>KeySight Spectrum Analyzer - Swept SA</p> <p>Center Freq 2.39500000 GHz</p> <p>Ref Offset: 19.5 dB Ref 19.50 dBm</p> <p>Mkr4 2.389 317 5 GHz -60.627 dBm</p> <p>Start 2.38500 GHz #Res BW 100 kHz</p> <p>#VBW 300 kHz Sweep 2.133 ms (8001 pts)</p> <table border="1"> <thead> <tr> <th>MKR</th> <th>MODE</th> <th>TRC</th> <th>SCL</th> <th>X</th> <th>Y</th> <th>FUNCTION</th> <th>FUNCTION WIDTH</th> <th>FUNCTION VALUE</th> </tr> </thead> <tbody> <tr> <td>1</td> <td>N</td> <td>1</td> <td>f</td> <td>2.401 987 5 GHz</td> <td>-3.897 dBm</td> <td></td> <td></td> <td></td> </tr> <tr> <td>2</td> <td>N</td> <td>1</td> <td>f</td> <td>2.400 000 0 GHz</td> <td>-53.188 dBm</td> <td></td> <td></td> <td></td> </tr> <tr> <td>3</td> <td>N</td> <td>1</td> <td>f</td> <td>2.390 000 0 GHz</td> <td>-62.948 dBm</td> <td></td> <td></td> <td></td> </tr> <tr> <td>4</td> <td>N</td> <td>1</td> <td>f</td> <td>2.389 317 5 GHz</td> <td>-60.627 dBm</td> <td></td> <td></td> <td></td> </tr> </tbody> </table>	MKR	MODE	TRC	SCL	X	Y	FUNCTION	FUNCTION WIDTH	FUNCTION VALUE	1	N	1	f	2.401 987 5 GHz	-3.897 dBm				2	N	1	f	2.400 000 0 GHz	-53.188 dBm				3	N	1	f	2.390 000 0 GHz	-62.948 dBm				4	N	1	f	2.389 317 5 GHz	-60.627 dBm			
MKR	MODE	TRC	SCL	X	Y	FUNCTION	FUNCTION WIDTH	FUNCTION VALUE																																						
1	N	1	f	2.401 987 5 GHz	-3.897 dBm																																									
2	N	1	f	2.400 000 0 GHz	-53.188 dBm																																									
3	N	1	f	2.390 000 0 GHz	-62.948 dBm																																									
4	N	1	f	2.389 317 5 GHz	-60.627 dBm																																									
<p>$\pi/4$DQPSK/LCH/Hop</p>	<p>KeySight Spectrum Analyzer - Swept SA</p> <p>Center Freq 2.39750000 GHz</p> <p>Ref Offset: 19.5 dB Ref 19.50 dBm</p> <p>Mkr4 2.388 025 GHz -59.251 dBm</p> <p>Start 2.38500 GHz #Res BW 100 kHz</p> <p>#VBW 300 kHz Sweep 2.400 ms (1001 pts)</p> <table border="1"> <thead> <tr> <th>MKR</th> <th>MODE</th> <th>TRC</th> <th>SCL</th> <th>X</th> <th>Y</th> <th>FUNCTION</th> <th>FUNCTION WIDTH</th> <th>FUNCTION VALUE</th> </tr> </thead> <tbody> <tr> <td>1</td> <td>N</td> <td>1</td> <td>f</td> <td>2.403 975 GHz</td> <td>-3.845 dBm</td> <td></td> <td></td> <td></td> </tr> <tr> <td>2</td> <td>N</td> <td>1</td> <td>f</td> <td>2.400 000 GHz</td> <td>-52.972 dBm</td> <td></td> <td></td> <td></td> </tr> <tr> <td>3</td> <td>N</td> <td>1</td> <td>f</td> <td>2.390 000 GHz</td> <td>-60.658 dBm</td> <td></td> <td></td> <td></td> </tr> <tr> <td>4</td> <td>N</td> <td>1</td> <td>f</td> <td>2.388 025 GHz</td> <td>-59.251 dBm</td> <td></td> <td></td> <td></td> </tr> </tbody> </table>	MKR	MODE	TRC	SCL	X	Y	FUNCTION	FUNCTION WIDTH	FUNCTION VALUE	1	N	1	f	2.403 975 GHz	-3.845 dBm				2	N	1	f	2.400 000 GHz	-52.972 dBm				3	N	1	f	2.390 000 GHz	-60.658 dBm				4	N	1	f	2.388 025 GHz	-59.251 dBm			
MKR	MODE	TRC	SCL	X	Y	FUNCTION	FUNCTION WIDTH	FUNCTION VALUE																																						
1	N	1	f	2.403 975 GHz	-3.845 dBm																																									
2	N	1	f	2.400 000 GHz	-52.972 dBm																																									
3	N	1	f	2.390 000 GHz	-60.658 dBm																																									
4	N	1	f	2.388 025 GHz	-59.251 dBm																																									

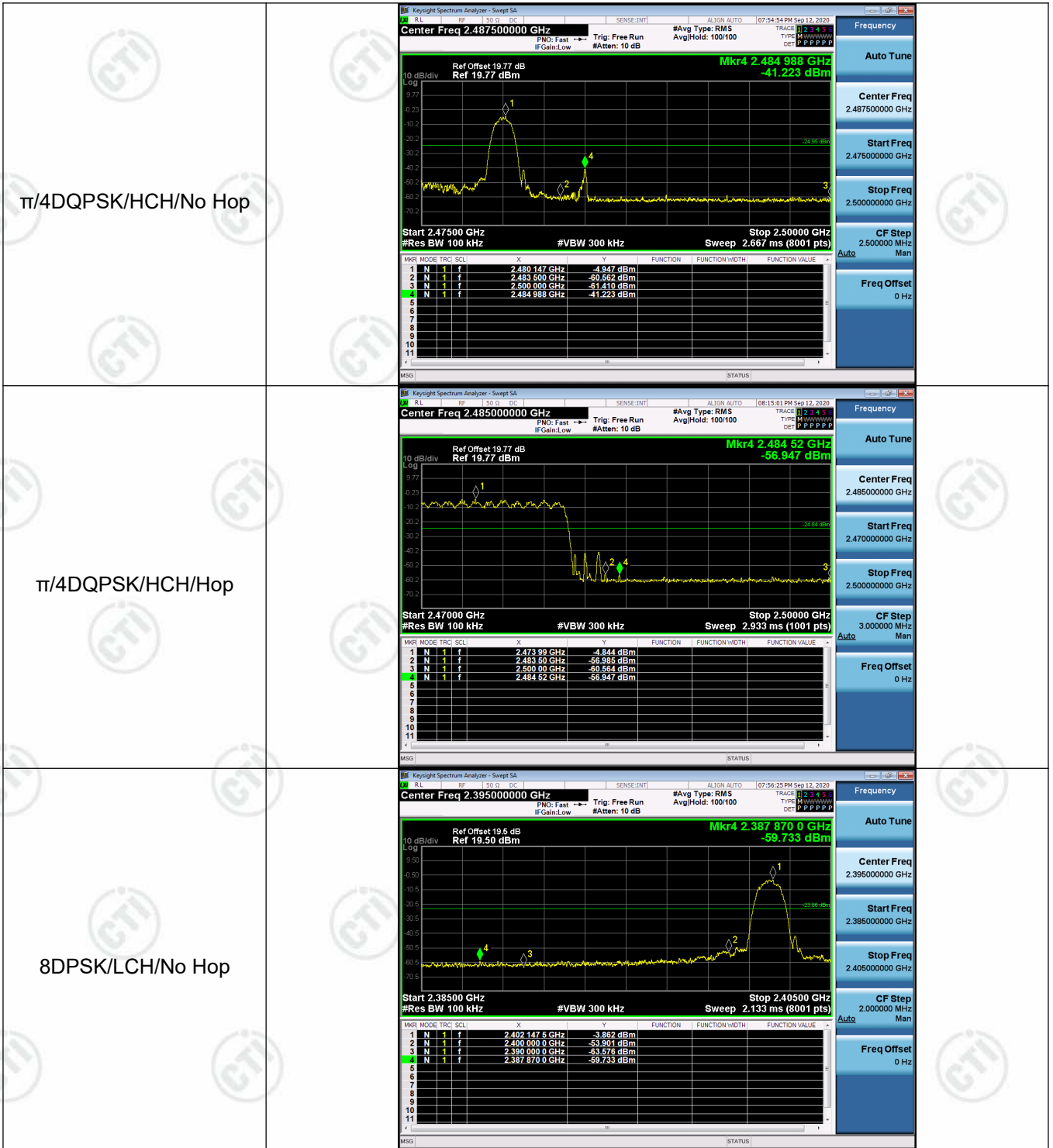

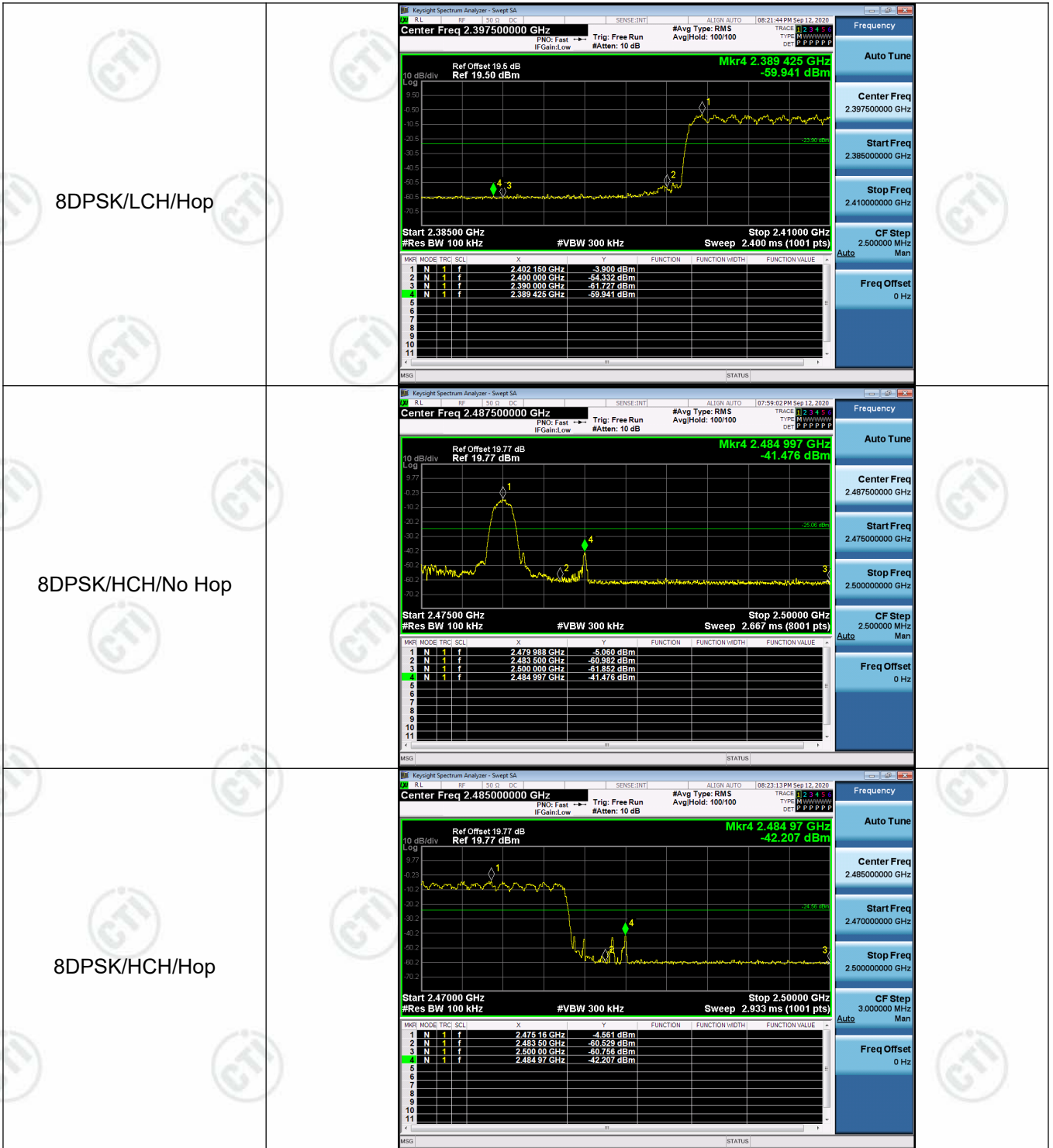

Appendix G): RF Conducted Spurious Emissions

Test Limit

According to §15.247(d),

Limit	-20 dBc
-------	---------

Test Procedure

1. EUT RF output port connected to the SA by RF cable, and the path loss was compensated to result.
2. SA setting, RBW=100kHz, VBW=300kHz, Detector=Peak, Trace mode = max hold, SWT = Auto.

Test Setup

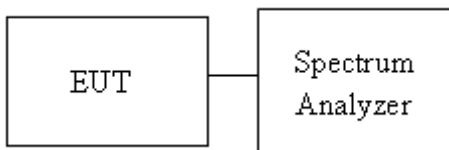

Result Table

Mode	Channel	Pref [dBm]	Puw[dBm]	Verdict
GFSK	LCH	1.831	<Limit	PASS
GFSK	MCH	1.588	<Limit	PASS
GFSK	HCH	0.933	<Limit	PASS
$\pi/4$ DQPSK	LCH	-3.959	<Limit	PASS
$\pi/4$ DQPSK	MCH	-4.016	<Limit	PASS
$\pi/4$ DQPSK	HCH	-5.003	<Limit	PASS
8DPSK	LCH	-3.941	<Limit	PASS
8DPSK	MCH	-4.033	<Limit	PASS
8DPSK	HCH	-4.998	<Limit	PASS

Test Graph





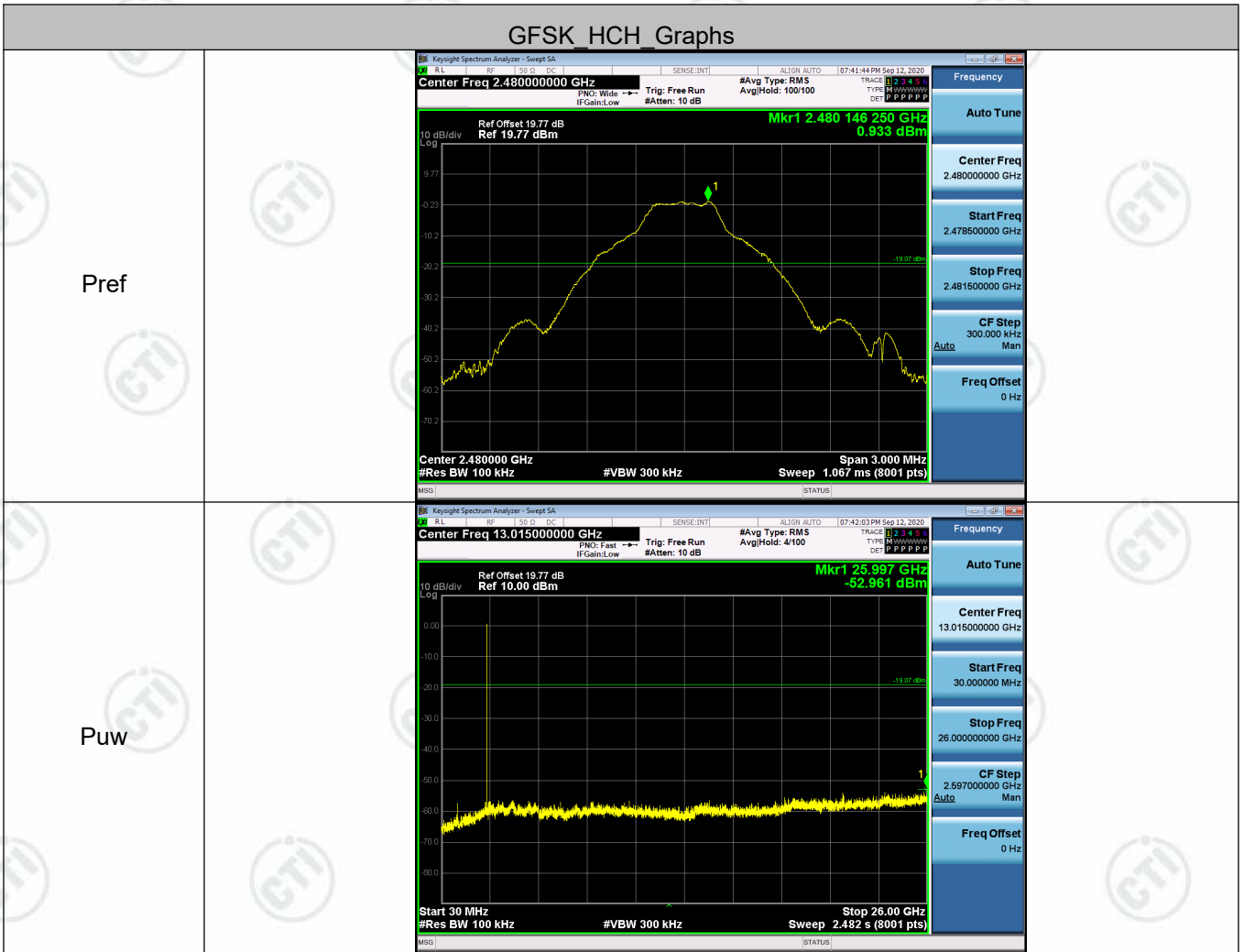







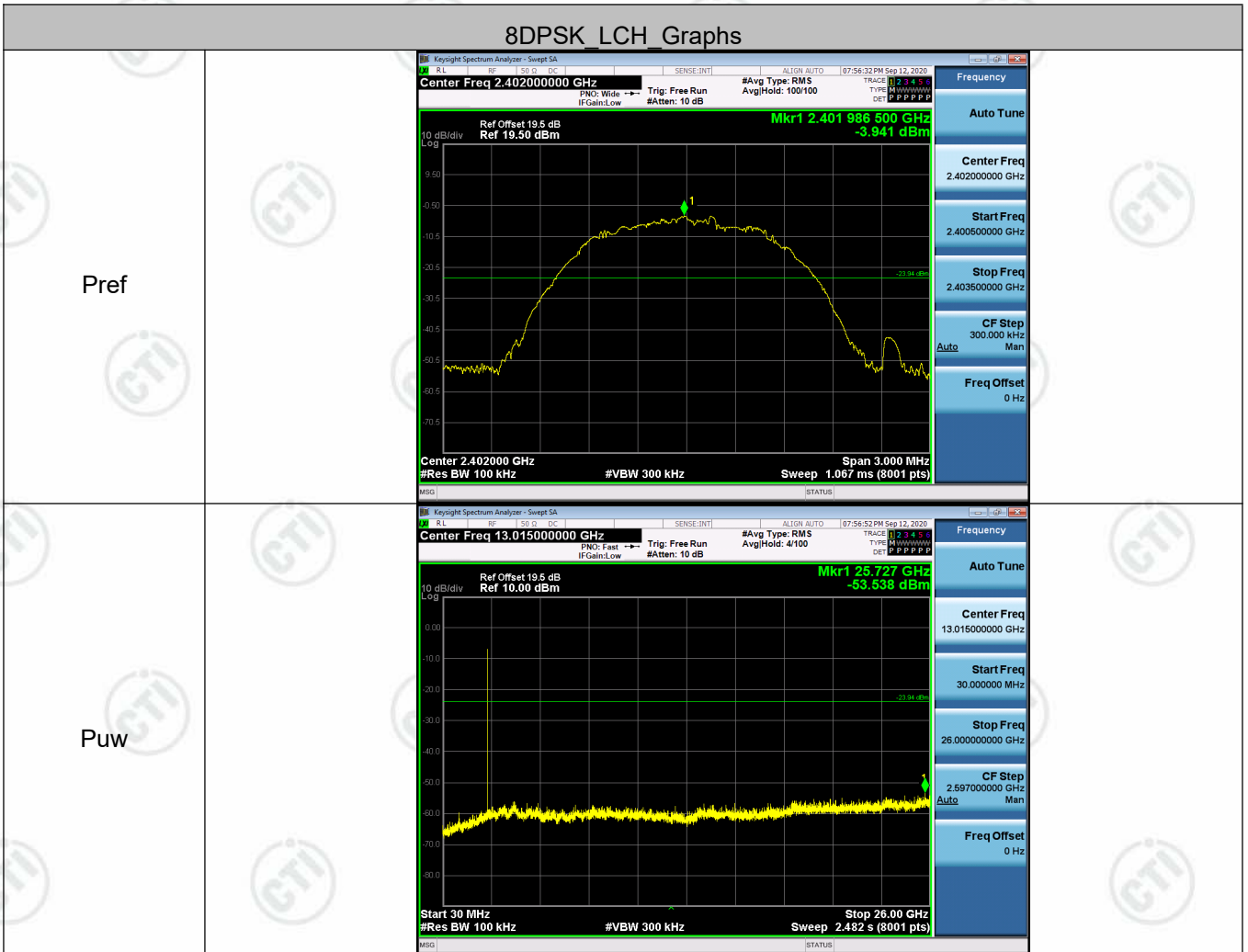



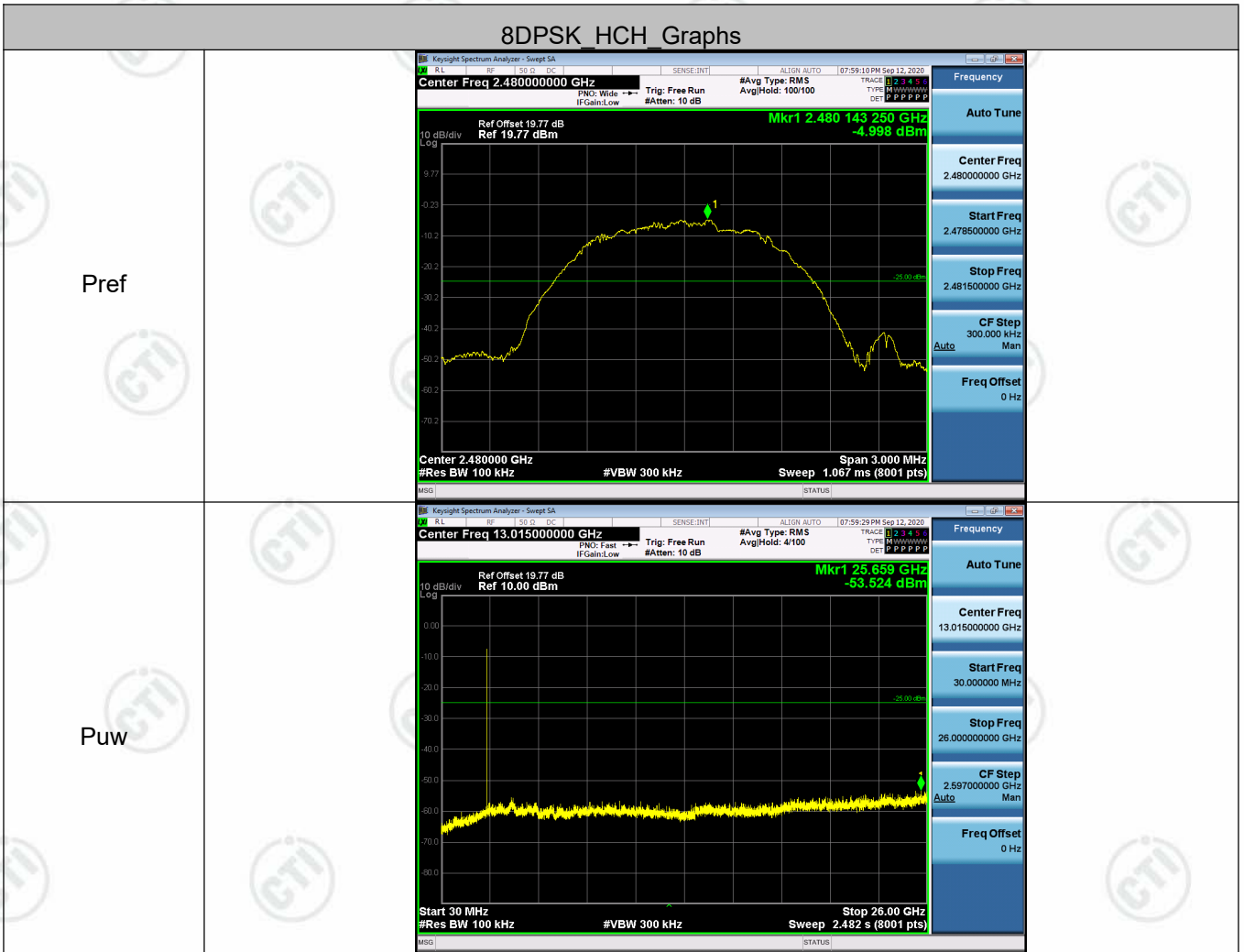

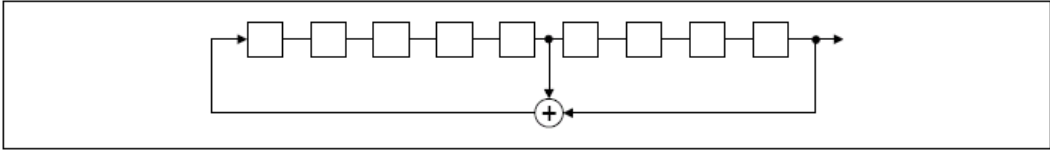

Appendix H) Pseudorandom Frequency Hopping Sequence

Test Requirement:	47 CFR Part 15C Section 15.247 (a)(1) requirement:
<p>Frequency hopping systems shall have hopping channel carrier frequencies separated by a minimum of 25 kHz or the 20 dB bandwidth of the hopping channel, whichever is greater.</p> <p>Alternatively. Frequency hopping systems operating in the 2400-2483.5 MHz band may have hopping channel carrier frequencies that are separated by 25 kHz or two-thirds of the 20 dB bandwidth of the hopping channel, whichever is greater, provided the systems operate with an output power no greater than 125 mW. The system shall hop to channel frequencies that are selected at the system hopping rate from a Pseudorandom ordered list of hopping frequencies. Each frequency must be used equally on the average by each transmitter. The system receivers shall have input bandwidths that match the hopping channel bandwidths of their corresponding transmitters and shall shift frequencies in synchronization with the transmitted signals.</p>	
EUT Pseudorandom Frequency Hopping Sequence	
<p>The pseudorandom sequence may be generated in a nine-stage shift register whose 5th and 9th stage outputs are added in a modulo-two addition stage. And the result is fed back to the input of the first stage. The sequence begins with the first ONE of 9 consecutive ONES; i.e. the shift register is initialized with nine ones.</p> <ul style="list-style-type: none"> • Number of shift register stages: 9 • Length of pseudo-random sequence: $2^9 - 1 = 511$ bits • Longest sequence of zeros: 8 (non-inverted signal) 	
	
<p><i>Linear Feedback Shift Register for Generation of the PRBS sequence</i></p>	
<p>An example of Pseudorandom Frequency Hopping Sequence as follow:</p>	
	
<p>Each frequency used equally on the average by each transmitter.</p> <p>The system receivers have input bandwidths that match the hopping channel bandwidths of their Corresponding transmitters and shift frequencies in synchronization with the transmitted signals.</p>	
<p>The device does not have the ability to be coordinated with other FHSS systems in an effort to avoid the simultaneous occupancy of individual hopping frequencies by multiple transmitters.</p>	

Appendix I) Antenna Requirement

15.203 requirement:

An intentional radiator shall be designed to ensure that no antenna other than that furnished by the responsible party shall be used with the device. The use of a permanently attached antenna or of an antenna that uses a unique coupling to the intentional radiator, the manufacturer may design the unit so that a broken antenna can be replaced by the user, but the use of a standard antenna jack or electrical connector is prohibited.

15.247(b) (4) requirement:

The conducted output power limit specified in paragraph (b) of this section is based on the use of antennas with directional gains that do not exceed 6 dBi. Except as shown in paragraph (c) of this section, if transmitting antennas of directional gain greater than 6 dBi are used, the conducted output power from the intentional radiator shall be reduced below the stated values in paragraphs (b)(1), (b)(2), and (b)(3) of this section, as appropriate, by the amount in dB that the directional gain of the antenna exceeds 6 dBi.

EUT Antenna:



The antenna is FPC antenna. The best case gain of the antenna is 1.7dBi.

Appendix J) AC Power Line Conducted Emission

<p>Test Procedure:</p>	<p>Test frequency range :150KHz-30MHz</p> <ol style="list-style-type: none"> 1) The mains terminal disturbance voltage test was conducted in a shielded room. 2) The EUT was connected to AC power source through a LISN 1 (Line Impedance Stabilization Network) which provides a $50\Omega/50\mu\text{H} + 5\Omega$ linear impedance. The power cables of all other units of the EUT were connected to a second LISN 2, which was bonded to the ground reference plane in the same way as the LISN 1 for the unit being measured. A multiple socket outlet strip was used to connect multiple power cables to a single LISN provided the rating of the LISN was not exceeded. 3) The tabletop EUT was placed upon a non-metallic table 0.8m above the ground reference plane. And for floor-standing arrangement, the EUT was placed on the horizontal ground reference plane, 4) The test was performed with a vertical ground reference plane. The rear of the EUT shall be 0.4 m from the vertical ground reference plane. The vertical ground reference plane was bonded to the horizontal ground reference plane. The LISN 1 was placed 0.8 m from the boundary of the unit under test and bonded to a ground reference plane for LISNs mounted on top of the ground reference plane. This distance was between the closest points of the LISN 1 and the EUT. All other units of the EUT and associated equipment was at least 0.8 m from the LISN 2. 5) In order to find the maximum emission, the relative positions of equipment and all of the interface cables must be changed according to ANSI C63.10 on conducted measurement. 																
<p>Limit:</p>	<table border="1" data-bbox="497 1205 1369 1424"> <thead> <tr> <th rowspan="2">Frequency range (MHz)</th> <th colspan="2">Limit (dBuV)</th> </tr> <tr> <th>Quasi-peak</th> <th>Average</th> </tr> </thead> <tbody> <tr> <td>0.15-0.5</td> <td>66 to 56*</td> <td>56 to 46*</td> </tr> <tr> <td>0.5-5</td> <td>56</td> <td>46</td> </tr> <tr> <td>5-30</td> <td>60</td> <td>50</td> </tr> </tbody> </table> <p>* The limit decreases linearly with the logarithm of the frequency in the range 0.15 MHz to 0.50 MHz.</p> <p>NOTE : The lower limit is applicable at the transition frequency</p>			Frequency range (MHz)	Limit (dBuV)		Quasi-peak	Average	0.15-0.5	66 to 56*	56 to 46*	0.5-5	56	46	5-30	60	50
Frequency range (MHz)	Limit (dBuV)																
	Quasi-peak	Average															
0.15-0.5	66 to 56*	56 to 46*															
0.5-5	56	46															
5-30	60	50															

Measurement Data

An initial pre-scan was performed on the live and neutral lines with peak detector.

Quasi-Peak and Average measurement were performed at the frequencies with maximized peak emission were detected.

Live line:

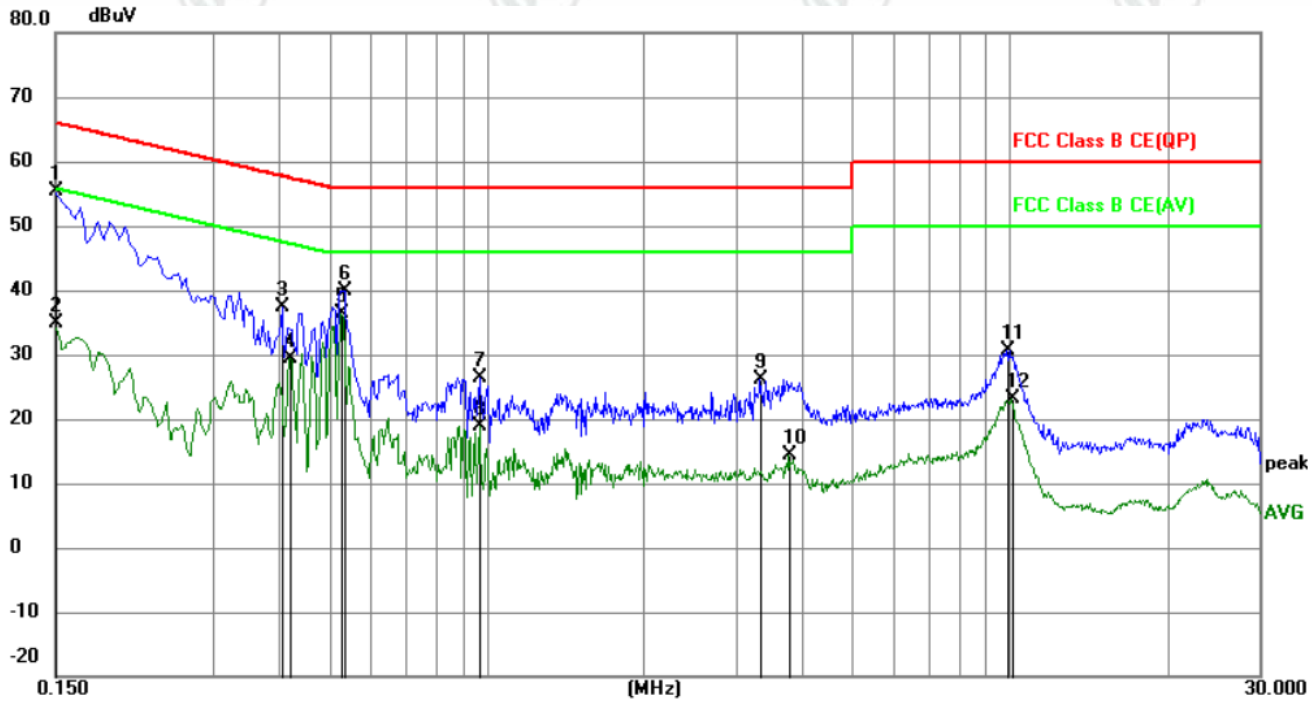

No.	Mk.	Freq. MHz	Reading Level dBuV	Correct Factor dB	Measure- ment dBuV	Limit dBuV	Margin dB	Detector	Comment
1		0.1500	45.44	9.87	55.31	66.00	-10.69	QP	
2		0.1500	24.94	9.87	34.81	56.00	-21.19	AVG	
3		0.4065	27.34	9.97	37.31	57.72	-20.41	QP	
4		0.4200	19.33	9.97	29.30	47.45	-18.15	AVG	
5	*	0.5280	26.32	9.98	36.30	46.00	-9.70	AVG	
6		0.5325	30.01	9.99	40.00	56.00	-16.00	QP	
7		0.9735	16.61	9.84	26.45	56.00	-29.55	QP	
8		0.9735	9.16	9.84	19.00	46.00	-27.00	AVG	
9		3.3315	16.41	9.79	26.20	56.00	-29.80	QP	
10		3.7860	4.57	9.78	14.35	46.00	-31.65	AVG	
11		9.8925	20.82	9.78	30.60	60.00	-29.40	QP	
12		10.0770	13.30	9.78	23.08	50.00	-26.92	AVG	

Neutral line:

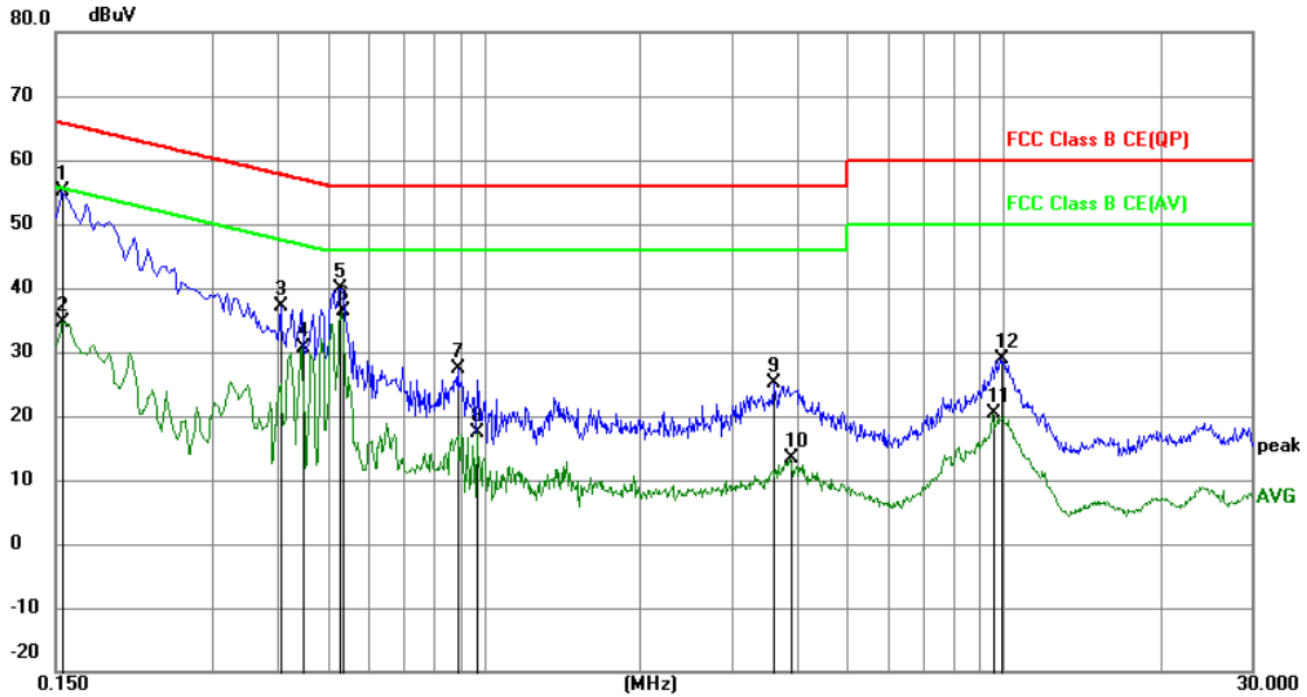

No. Mk.	Freq. MHz	Reading Level dBuV	Correct Factor dB	Measurement dBuV	Limit dBuV	Margin dB	Detector	Comment
1	0.1545	45.33	9.87	55.20	65.75	-10.55	QP	
2	0.1545	24.76	9.87	34.63	55.75	-21.12	AVG	
3	0.4065	27.10	9.97	37.07	57.72	-20.65	QP	
4	0.4470	20.60	9.96	30.56	46.93	-16.37	AVG	
5	0.5280	29.86	9.98	39.84	56.00	-16.16	QP	
6 *	0.5325	26.39	9.99	36.38	46.00	-9.62	AVG	
7	0.8925	17.42	9.85	27.27	56.00	-28.73	QP	
8	0.9735	7.57	9.84	17.41	46.00	-28.59	AVG	
9	3.6105	15.44	9.78	25.22	56.00	-30.78	QP	
10	3.8895	3.67	9.78	13.45	46.00	-32.55	AVG	
11	9.5100	10.70	9.78	20.48	50.00	-29.52	AVG	
12	9.8969	19.01	9.78	28.79	60.00	-31.21	QP	

Notes:

1. The following Quasi-Peak and Average measurements were performed on the EUT:
2. Final Test Level =Receiver Reading + LISN Factor + Cable Loss.

Appendix K) Restricted bands around fundamental frequency (Radiated)

Receiver Setup:	Frequency	Detector	RBW	VBW	Remark
	30MHz-1GHz	Quasi-peak	120 kHz	300kHz	Quasi-peak
	Above 1GHz	Peak	1MHz	3MHz	Peak
		Peak	1MHz	10Hz	Average
Test Procedure:	<p>Below 1GHz test procedure as below:</p> <ol style="list-style-type: none"> The EUT was placed on the top of a rotating table 0.8 meters above the ground at a 3 meter semi-anechoic chamber. The table was rotated 360 degrees to determine the position of the highest radiation. The EUT was set 3 meters away from the interference-receiving antenna, which was mounted on the top of a variable-height antenna tower. The antenna height is varied from one meter to four meters above the ground to determine the maximum value of the field strength. Both horizontal and vertical polarizations of the antenna are set to make the measurement. For each suspected emission, the EUT was arranged to its worst case and then the antenna was tuned to heights from 1 meter to 4 meters and the rotatable table was turned from 0 degrees to 360 degrees to find the maximum reading. The test-receiver system was set to Peak Detect Function and Specified Bandwidth with Maximum Hold Mode. Place a marker at the end of the restricted band closest to the transmit frequency to show compliance. Also measure any emissions in the restricted bands. Save the spectrum analyzer plot. Repeat for each power and modulation for lowest and highest channel <p>Above 1GHz test procedure as below:</p> <ol style="list-style-type: none"> Different between above is the test site, change from Semi- Anechoic Chamber to fully Anechoic Chamber and change form table 0.8 metre to 1.5 metre(Above 18GHz the distance is 1 meter and table is 1.5 metre). b. Test the EUT in the lowest channel , the Highest channel The radiation measurements are performed in X, Y, Z axis positioning for Transmitting mode, and found the X axis positioning which it is worse case. Repeat above procedures until all frequencies measured was complete. 				
Limit:	Frequency	Limit (dBuV/m @3m)	Remark		
	30MHz-88MHz	40.0	Quasi-peak Value		
	88MHz-216MHz	43.5	Quasi-peak Value		
	216MHz-960MHz	46.0	Quasi-peak Value		
	960MHz-1GHz	54.0	Quasi-peak Value		
	Above 1GHz	54.0	Average Value		
		74.0	Peak Value		

Test plot as follows:

Mode:	GFSK Transmitting	Channel:	2402
Remark:	PK		

Test Graph

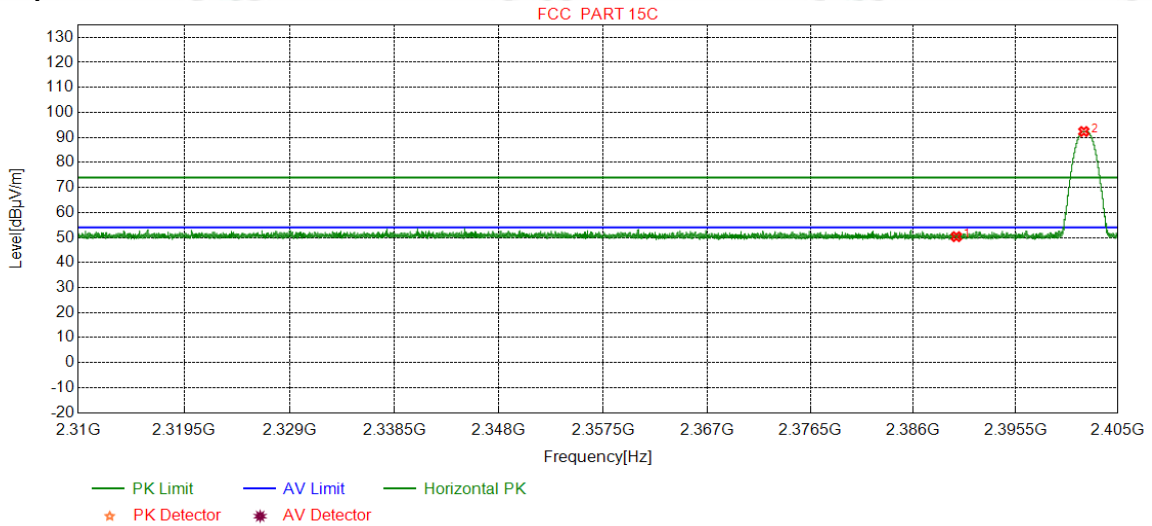

NO	Freq. [MHz]	Ant Factor [dB]	Cable loss [dB]	Pream gain [dB]	Reading [dBµV]	Level [dBµV/m]	Limit [dBµV/m]	Margin [dB]	Result	Polarity
1	2390.0000	32.25	13.37	-43.12	47.83	50.33	74.00	23.67	Pass	Horizontal
2	2401.8395	32.26	13.31	-43.12	89.92	92.37	74.00	-18.37	Pass	Horizontal

Mode:	GFSK Transmitting	Channel:	2402
Remark:	PK		

Test Graph

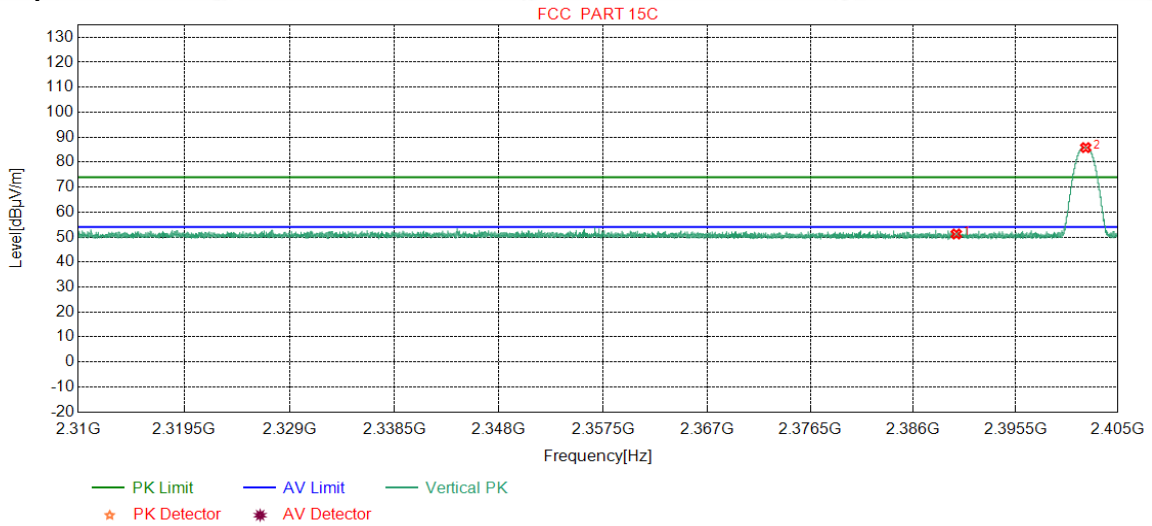

NO	Freq. [MHz]	Ant Factor [dB]	Cable loss [dB]	Pream gain [dB]	Reading [dBµV]	Level [dBµV/m]	Limit [dBµV/m]	Margin [dB]	Result	Polarity
1	2390.0000	32.25	13.37	-43.12	48.73	51.23	74.00	22.77	Pass	Vertical
2	2402.0168	32.26	13.31	-43.12	83.37	85.82	74.00	-11.82	Pass	Vertical

Mode:	GFSK Transmitting	Channel:	2402
Remark:	AV		

Test Graph

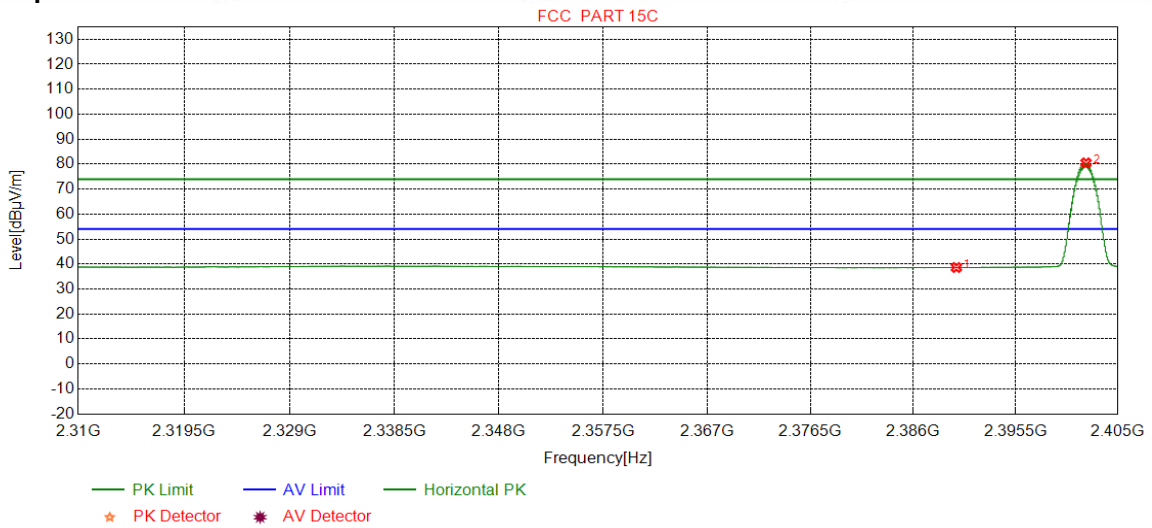

NO	Freq. [MHz]	Ant Factor [dB]	Cable loss [dB]	Pream gain [dB]	Reading [dBµV]	Level [dBµV/m]	Limit [dBµV/m]	Margin [dB]	Result	Polarity
1	2390.0000	32.25	13.37	-43.12	36.12	38.62	54.00	15.38	Pass	Horizontal
2	2402.0421	32.26	13.31	-43.12	78.05	80.50	54.00	-26.50	Pass	Horizontal

Mode:	GFSK Transmitting	Channel:	2402
Remark:	AV		

Test Graph

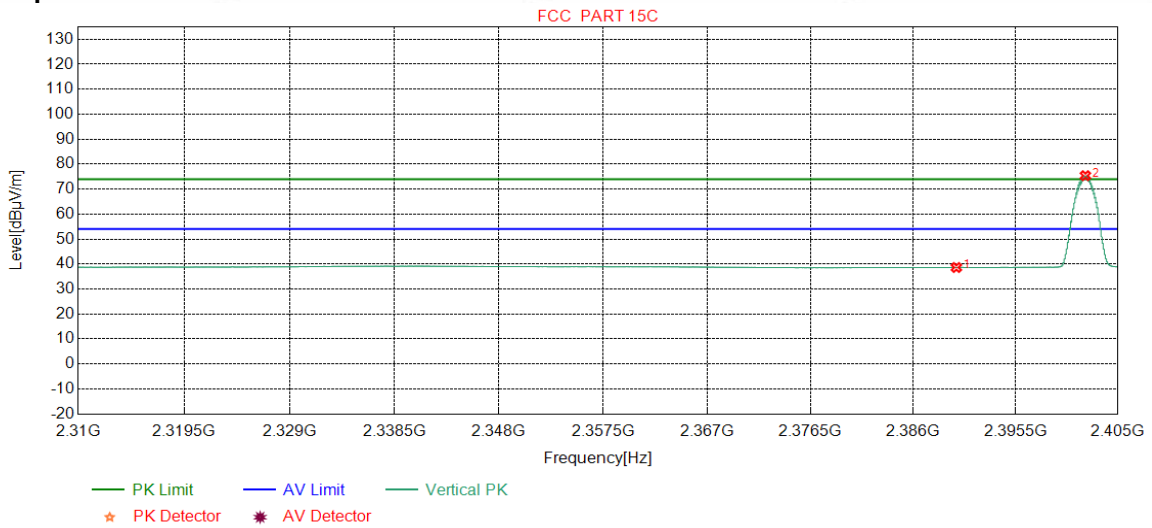

NO	Freq. [MHz]	Ant Factor [dB]	Cable loss [dB]	Pream gain [dB]	Reading [dBµV]	Level [dBµV/m]	Limit [dBµV/m]	Margin [dB]	Result	Polarity
1	2390.0000	32.25	13.37	-43.12	36.11	38.61	54.00	15.39	Pass	Vertical
2	2401.9851	32.26	13.31	-43.12	72.93	75.38	54.00	-21.38	Pass	Vertical

Mode:	GFSK Transmitting	Channel:	2480
Remark:	PK		

Test Graph

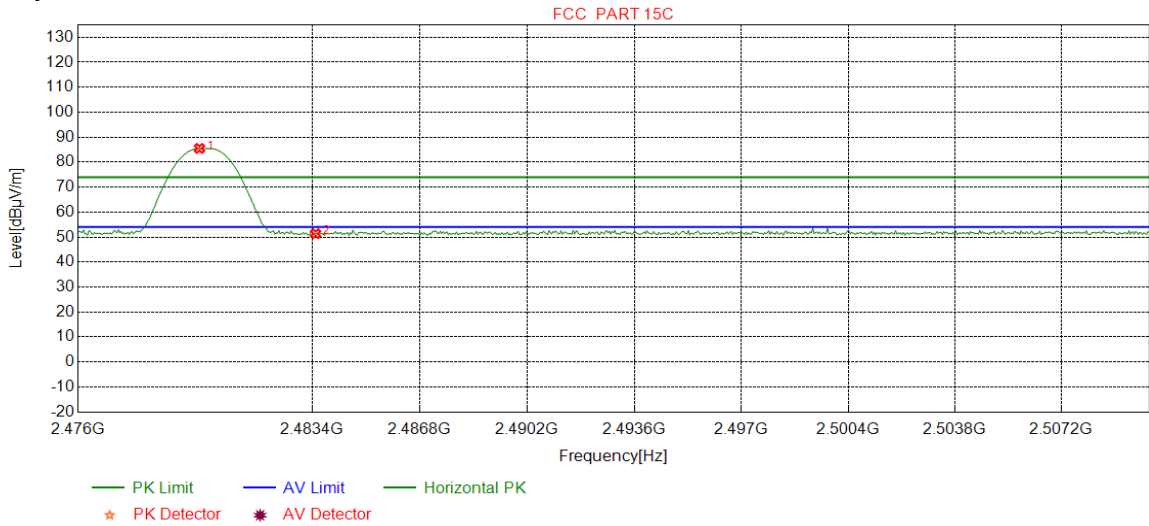

NO	Freq. [MHz]	Ant Factor [dB]	Cable loss [dB]	Pream gain [dB]	Reading [dBµV]	Level [dBµV/m]	Limit [dBµV/m]	Margin [dB]	Result	Polarity
1	2479.8298	32.37	13.39	-43.10	82.83	85.49	74.00	-11.49	Pass	Horizontal
2	2483.5000	32.38	13.38	-43.11	48.73	51.38	74.00	22.62	Pass	Horizontal

Mode:	GFSK Transmitting	Channel:	2480
Remark:	PK		

Test Graph

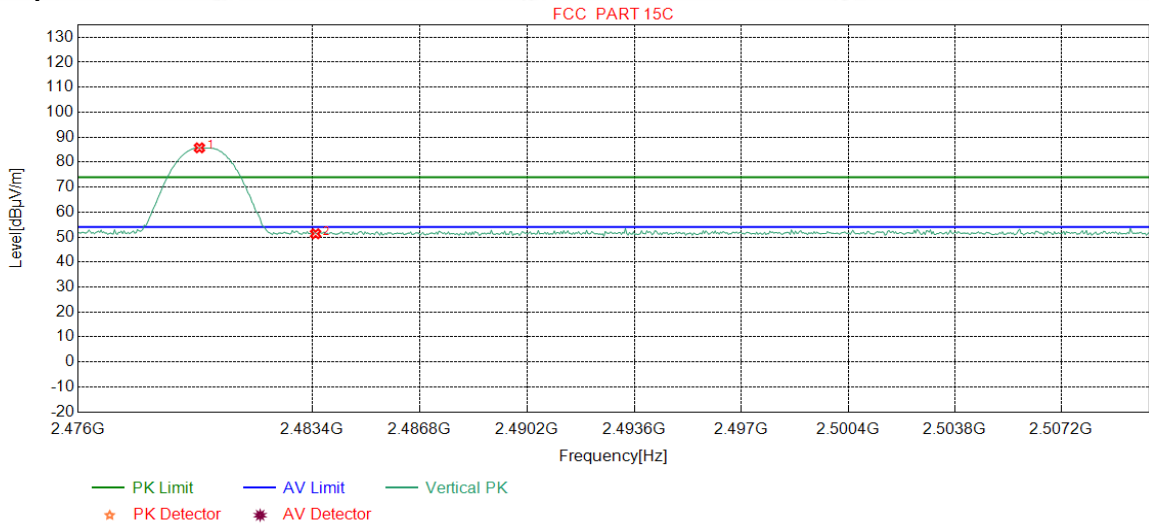

NO	Freq. [MHz]	Ant Factor [dB]	Cable loss [dB]	Pream gain [dB]	Reading [dBµV]	Level [dBµV/m]	Limit [dBµV/m]	Margin [dB]	Result	Polarity
1	2479.8298	32.37	13.39	-43.10	83.07	85.73	74.00	-11.73	Pass	Vertical
2	2483.5000	32.38	13.38	-43.11	48.66	51.31	74.00	22.69	Pass	Vertical

Mode:	GFSK Transmitting	Channel:	2480
Remark:	AV		

Test Graph

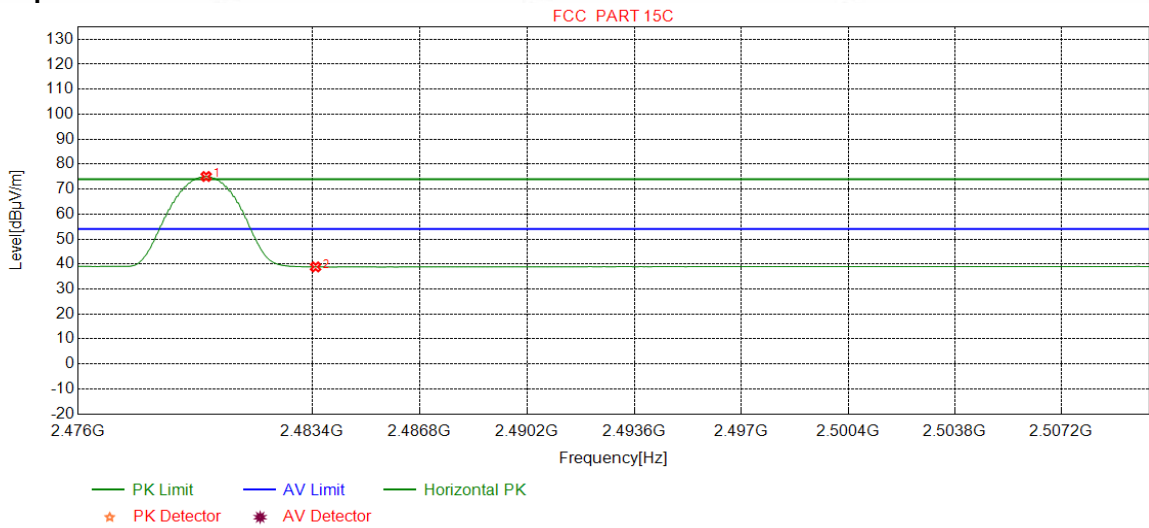

NO	Freq. [MHz]	Ant Factor [dB]	Cable loss [dB]	Pream gain [dB]	Reading [dBµV]	Level [dBµV/m]	Limit [dBµV/m]	Margin [dB]	Result	Polarity
1	2480.0426	32.37	13.39	-43.10	72.40	75.06	54.00	-21.06	Pass	Horizontal
2	2483.5000	32.38	13.38	-43.11	36.20	38.85	54.00	15.15	Pass	Horizontal

Mode:	GFSK Transmitting	Channel:	2480
Remark:	AV		

Test Graph

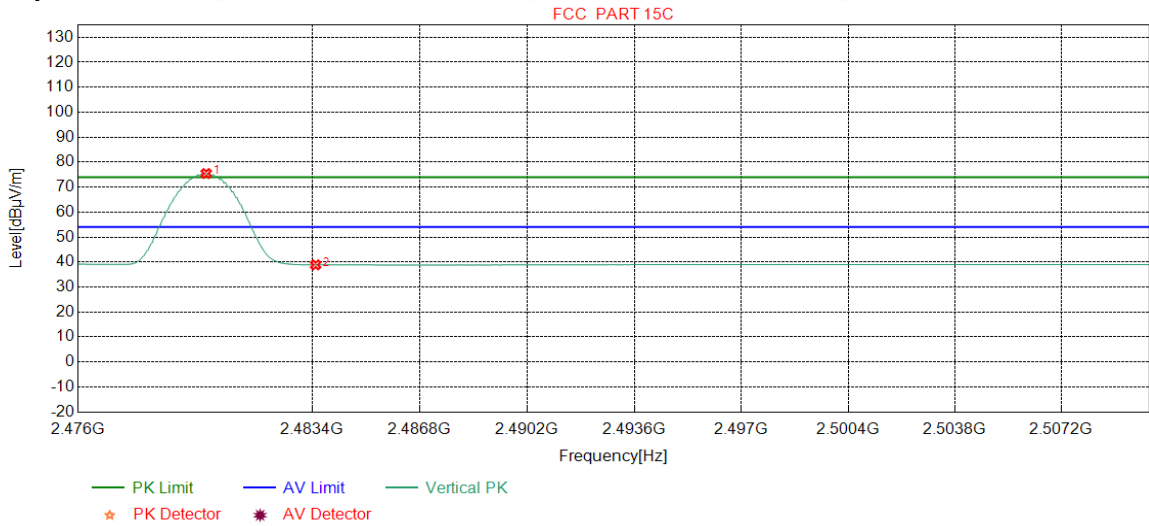

NO	Freq. [MHz]	Ant Factor [dB]	Cable loss [dB]	Pream gain [dB]	Reading [dBµV]	Level [dBµV/m]	Limit [dBµV/m]	Margin [dB]	Result	Polarity
1	2480.0426	32.37	13.39	-43.10	72.79	75.45	54.00	-21.45	Pass	Vertical
2	2483.5000	32.38	13.38	-43.11	36.22	38.87	54.00	15.13	Pass	Vertical

Mode:	8DPSK Transmitting	Channel:	2402
Remark:	PK		

Test Graph

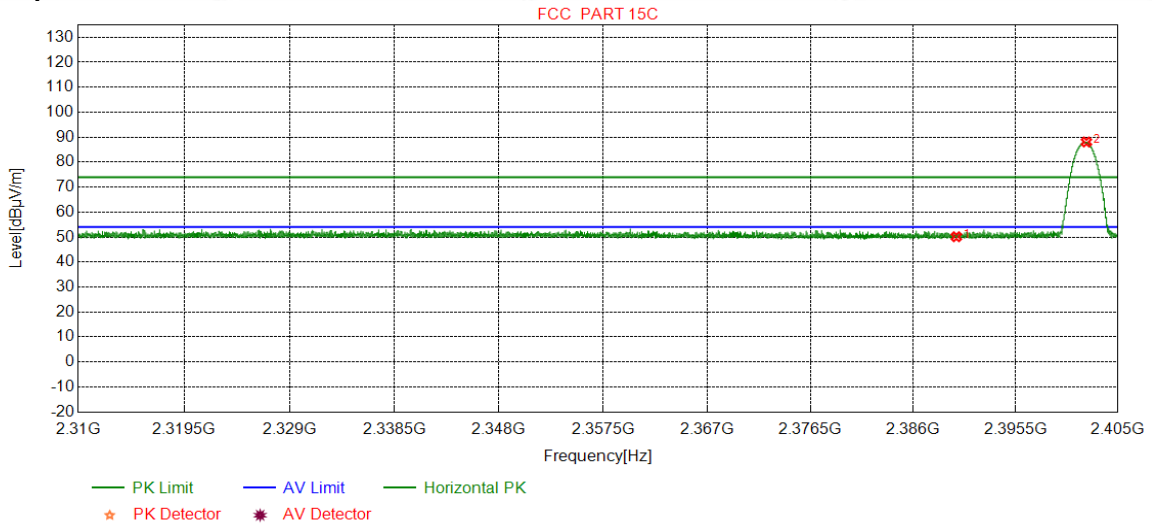

NO	Freq. [MHz]	Ant Factor [dB]	Cable loss [dB]	Pream gain [dB]	Reading [dBµV]	Level [dBµV/m]	Limit [dBµV/m]	Margin [dB]	Result	Polarity
1	2390.0000	32.25	13.37	-43.12	47.63	50.13	74.00	23.87	Pass	Horizontal
2	2402.0801	32.26	13.31	-43.12	85.63	88.08	74.00	-14.08	Pass	Horizontal

Mode:	8DPSK Transmitting	Channel:	2402
Remark:	PK		

Test Graph

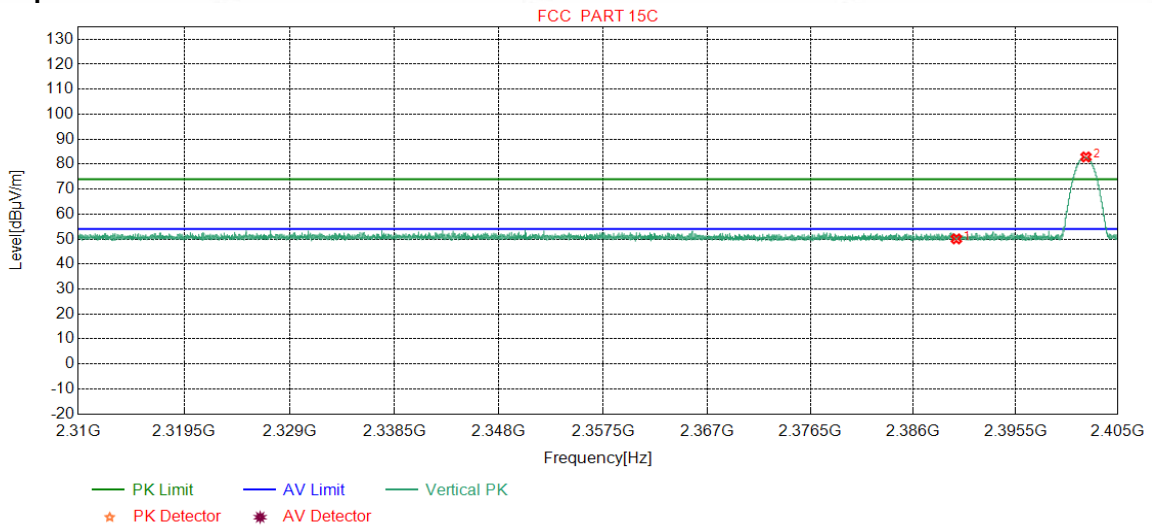

NO	Freq. [MHz]	Ant Factor [dB]	Cable loss [dB]	Pream gain [dB]	Reading [dBµV]	Level [dBµV/m]	Limit [dBµV/m]	Margin [dB]	Result	Polarity
1	2390.0000	32.25	13.37	-43.12	47.57	50.07	74.00	23.93	Pass	Vertical
2	2402.0421	32.26	13.31	-43.12	80.43	82.88	74.00	-8.88	Pass	Vertical

Mode:	8DPSK Transmitting	Channel:	2402
Remark:	AV		

Test Graph

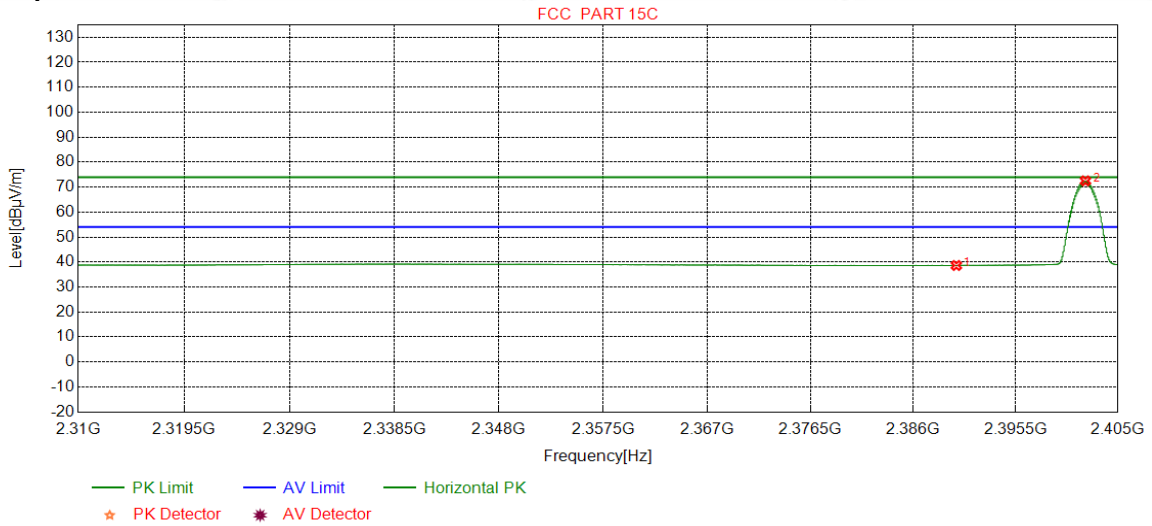

NO	Freq. [MHz]	Ant Factor [dB]	Cable loss [dB]	Pream gain [dB]	Reading [dBµV]	Level [dBµV/m]	Limit [dBµV/m]	Margin [dB]	Result	Polarity
1	2390.0000	32.25	13.37	-43.12	36.13	38.63	54.00	15.37	Pass	Horizontal
2	2401.9915	32.26	13.31	-43.12	70.06	72.51	54.00	-18.51	Pass	Horizontal

Mode:	8DPSK Transmitting	Channel:	2402
Remark:	AV		

Test Graph

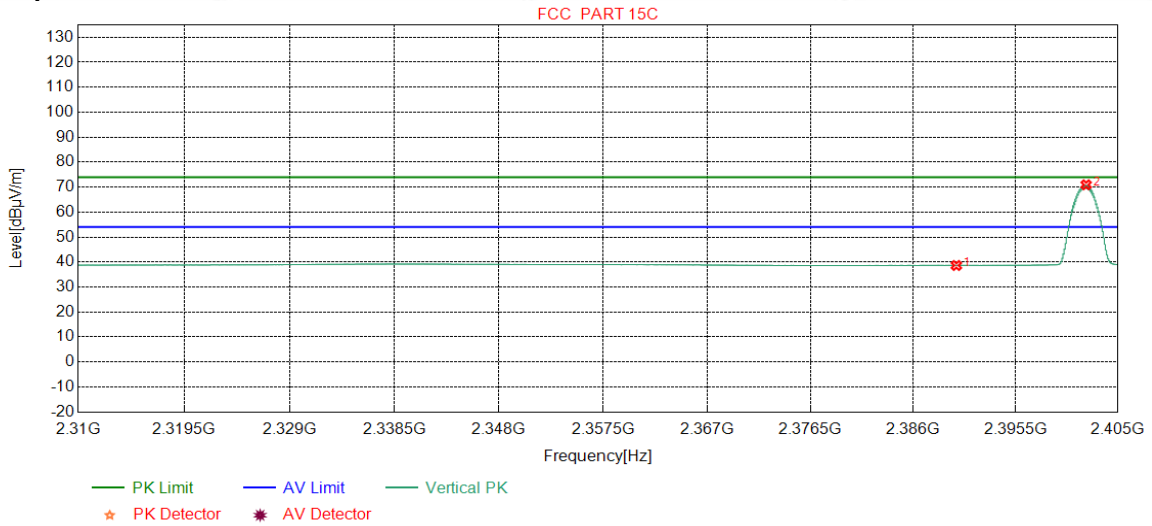

NO	Freq. [MHz]	Ant Factor [dB]	Cable loss [dB]	Pream gain [dB]	Reading [dBµV]	Level [dBµV/m]	Limit [dBµV/m]	Margin [dB]	Result	Polarity
1	2390.0000	32.25	13.37	-43.12	36.13	38.63	54.00	15.37	Pass	Vertical
2	2402.0548	32.26	13.31	-43.12	68.48	70.93	54.00	-16.93	Pass	Vertical

Mode:	8DPSK Transmitting	Channel:	2480
Remark:	PK		

Test Graph

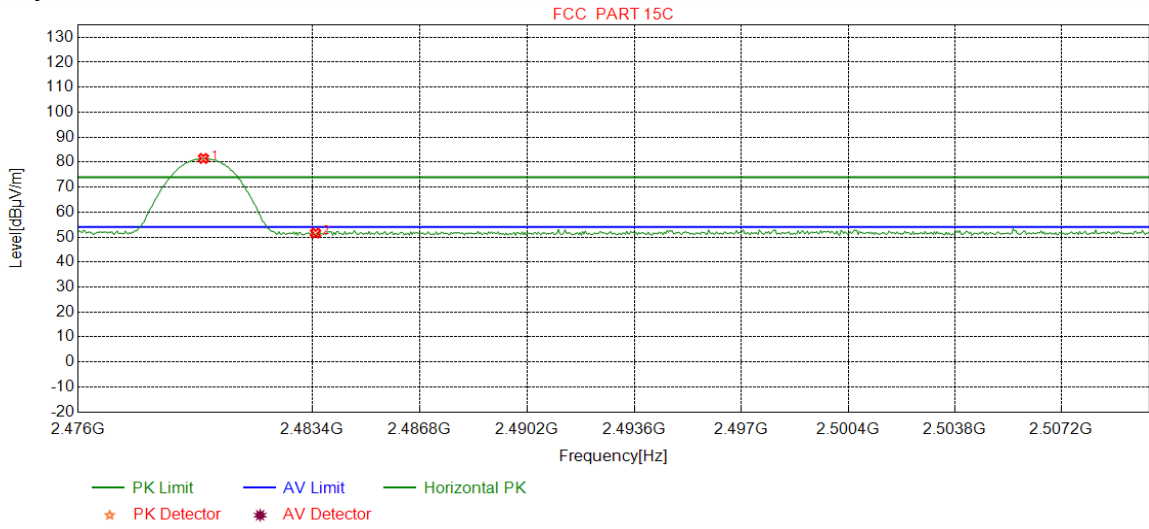

NO	Freq. [MHz]	Ant Factor [dB]	Cable loss [dB]	Pream gain [dB]	Reading [dBµV]	Level [dBµV/m]	Limit [dBµV/m]	Margin [dB]	Result	Polarity
1	2479.9574	32.37	13.39	-43.10	78.83	81.49	74.00	-7.49	Pass	Horizontal
2	2483.5000	32.38	13.38	-43.11	48.95	51.60	74.00	22.40	Pass	Horizontal

Mode:	8DPSK Transmitting	Channel:	2480
Remark:	PK		

Test Graph

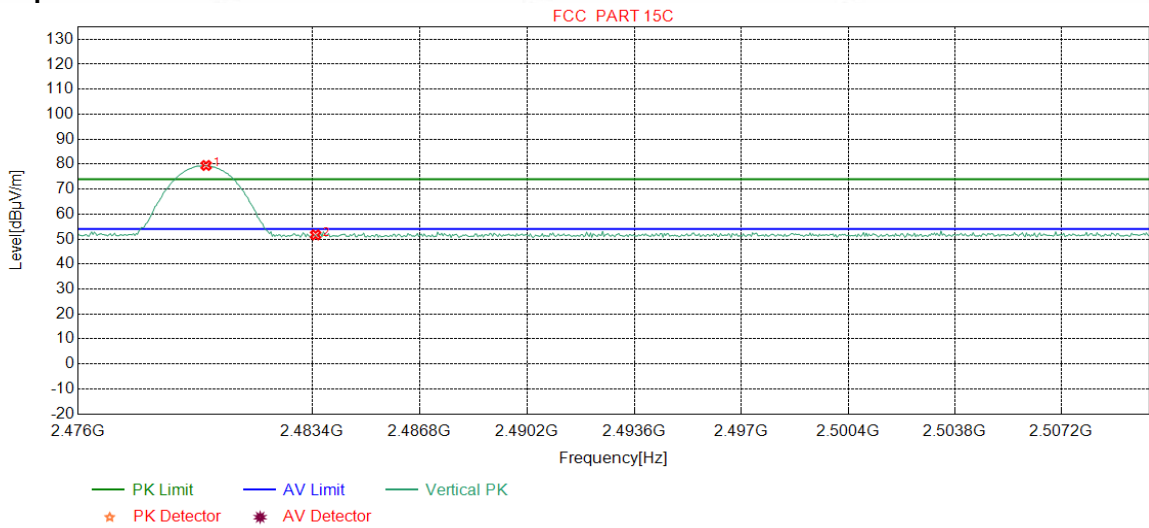

NO	Freq. [MHz]	Ant Factor [dB]	Cable loss [dB]	Pream gain [dB]	Reading [dBµV]	Level [dBµV/m]	Limit [dBµV/m]	Margin [dB]	Result	Polarity
1	2480.0426	32.37	13.39	-43.10	76.81	79.47	74.00	-5.47	Pass	Vertical
2	2483.5000	32.38	13.38	-43.11	49.03	51.68	74.00	22.32	Pass	Vertical

Mode:	8DPSK Transmitting	Channel:	2480
Remark:	AV		

Test Graph

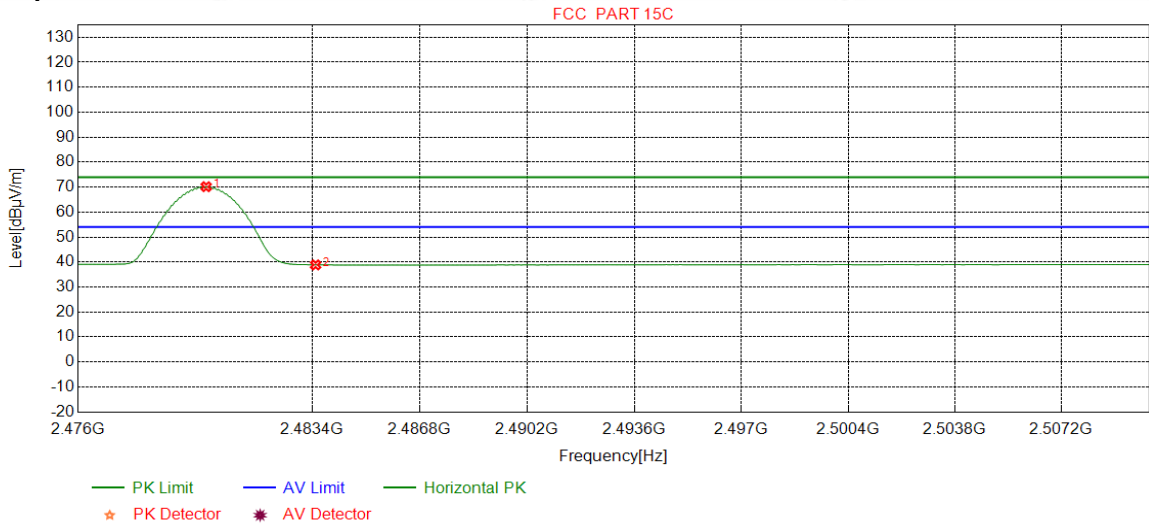

NO	Freq. [MHz]	Ant Factor [dB]	Cable loss [dB]	Pream gain [dB]	Reading [dBµV]	Level [dBµV/m]	Limit [dBµV/m]	Margin [dB]	Result	Polarity
1	2480.0426	32.37	13.39	-43.10	67.51	70.17	54.00	-16.17	Pass	Horizontal
2	2483.5000	32.38	13.38	-43.11	36.20	38.85	54.00	15.15	Pass	Horizontal

Mode:	8DPSK Transmitting	Channel:	2480
Remark:	AV		

Test Graph

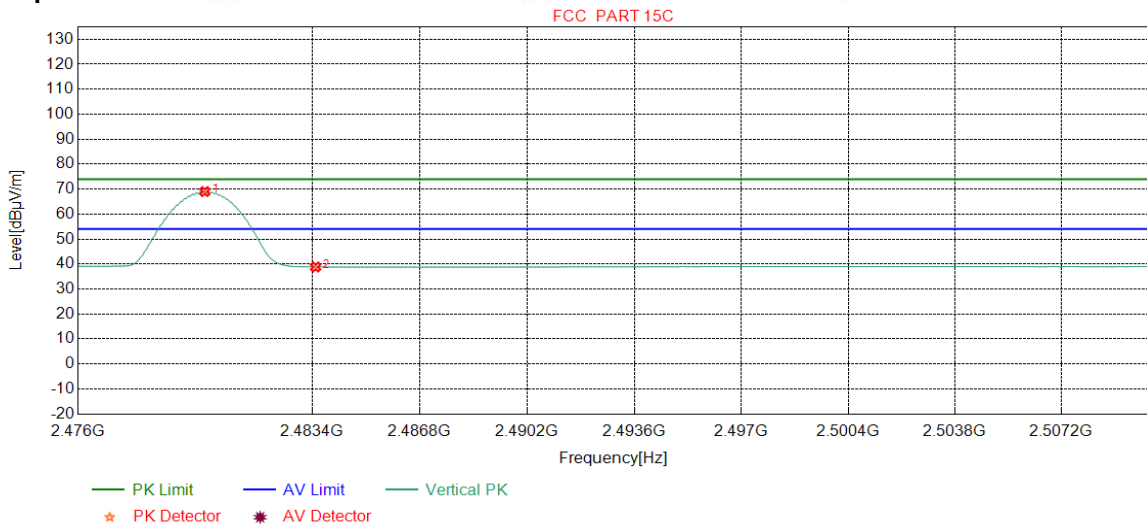

NO	Freq. [MHz]	Ant Factor [dB]	Cable loss [dB]	Pream gain [dB]	Reading [dBµV]	Level [dBµV/m]	Limit [dBµV/m]	Margin [dB]	Result	Polarity
1	2480.0000	32.37	13.39	-43.10	66.35	69.01	54.00	-15.01	Pass	Vertical
2	2483.5000	32.38	13.38	-43.11	36.17	38.82	54.00	15.18	Pass	Vertical

Note:

1) Through Pre-scan Non-hopping transmitting mode and charge+transmitter mode with all kind of modulation and all kind of data type, find the DH5 of data type is the worse case of GFSK modulation type in charge + transmitter mode.

2) The field strength is calculated by adding the Antenna Factor, Cable Factor & Preamplifier. The basic equation with a sample calculation is as follows:

Final Test Level = Receiver Reading - Correct Factor

Correct Factor = Preamplifier Factor - Antenna Factor - Cable Factor

Appendix L) Radiated Spurious Emissions

Receiver Setup:	Frequency	Detector	RBW	VBW	Remark
	0.009MHz-0.090MHz	Peak	10kHz	30kHz	Peak
	0.009MHz-0.090MHz	Average	10kHz	30kHz	Average
	0.090MHz-0.110MHz	Quasi-peak	10kHz	30kHz	Quasi-peak
	0.110MHz-0.490MHz	Peak	10kHz	30kHz	Peak
	0.110MHz-0.490MHz	Average	10kHz	30kHz	Average
	0.490MHz -30MHz	Quasi-peak	10kHz	30kHz	Quasi-peak
	30MHz-1GHz	Quasi-peak	120 kHz	300kHz	Quasi-peak
	Above 1GHz	Peak	1MHz	3MHz	Peak
	Peak	1MHz	10Hz	Average	
Test Procedure:					
Below 1GHz test procedure as below:					
<p>a. The EUT was placed on the top of a rotating table 0.8 meters above the ground at a 3 meter semi-anechoic chamber. The table was rotated 360 degrees to determine the position of the highest radiation.</p> <p>b. The EUT was set 3 meters away from the interference-receiving antenna, which was mounted on the top of a variable-height antenna tower.</p> <p>c. The antenna height is varied from one meter to four meters above the ground to determine the maximum value of the field strength. Both horizontal and vertical polarizations of the antenna are set to make the measurement.</p> <p>d. For each suspected emission, the EUT was arranged to its worst case and then the antenna was tuned to heights from 1 meter to 4 meters (for the test frequency of below 30MHz, the antenna was tuned to heights 1 meter) and the rotatable table was turned from 0 degrees to 360 degrees to find the maximum reading.</p> <p>e. The test-receiver system was set to Peak Detect Function and Specified Bandwidth with Maximum Hold Mode.</p> <p>f. If the emission level of the EUT in peak mode was 10dB lower than the limit specified, then testing could be stopped and the peak values of the EUT would be reported. Otherwise the emissions that did not have 10dB margin would be re-tested one by one using peak, quasi-peak or average method as specified and then reported in a data sheet.</p>					
Above 1GHz test procedure as below:					
<p>g. Different between above is the test site, change from Semi- Anechoic Chamber to fully Anechoic Chamber and change form table 0.8 metre to 1.5 metre(Above 18GHz the distance is 1 meter and table is 1.5 metre).</p> <p>h. Test the EUT in the lowest channel ,the middle channel ,the Highest channel</p> <p>i. The radiation measurements are performed in X, Y, Z axis positioning for Transmitting mode, and found the X axis positioning which it is worse case.</p> <p>j. Repeat above procedures until all frequencies measured was complete.</p>					
Limit:	Frequency	Field strength (microvolt/meter)	Limit (dBuV/m)	Remark	Measurement distance (m)
	0.009MHz-0.490MHz	2400/F(kHz)	-	-	300
	0.490MHz-1.705MHz	24000/F(kHz)	-	-	30
	1.705MHz-30MHz	30	-	-	30
	30MHz-88MHz	100	40.0	Quasi-peak	3
	88MHz-216MHz	150	43.5	Quasi-peak	3
	216MHz-960MHz	200	46.0	Quasi-peak	3
	960MHz-1GHz	500	54.0	Quasi-peak	3
	Above 1GHz	500	54.0	Average	3
<p>Note: 15.35(b), Unless otherwise specified, the limit on peak radio frequency emissions is 20dB above the maximum permitted average emission limit applicable to the equipment under test. This peak limit applies to the total peak emission level radiated by the device.</p>					

Radiated Spurious Emissions test Data:

During the test, the Radiated Spurious Emissions from 30MHz to 1GHz was performed in all modes with all channels, GFSK, Channel 2441MHz was selected as the worst condition. The test data of the worst-case condition was recorded in this report.

Radiated Emission below 1GHz

Mode:			GFSK Transmitting					Channel:		2441	
NO	Freq. [MHz]	Ant Factor [dB]	Cable loss [dB]	Pream gain [dB]	Reading [dB μ V]	Level [dB μ V/m]	Limit [dB μ V/m]	Margin [dB]	Result	Polarity	Remark
1	30.8731	10.53	0.63	-31.52	54.95	34.59	40.00	5.41	Pass	H	PK
2	36.5967	11.21	0.67	-31.38	55.00	35.50	40.00	4.50	Pass	H	PK
3	46.2976	13.20	0.76	-31.81	51.09	33.24	40.00	6.76	Pass	H	PK
4	60.5581	11.45	0.90	-31.81	52.12	32.66	40.00	7.34	Pass	H	PK
5	240.0260	11.94	1.84	-31.90	49.81	31.69	46.00	14.31	Pass	H	PK
6	600.0290	19.00	2.96	-31.50	42.85	33.31	46.00	12.69	Pass	H	PK
7	31.0671	10.54	0.63	-31.52	55.88	35.53	40.00	4.47	Pass	V	PK
8	35.6266	10.90	0.66	-31.41	55.12	35.27	40.00	4.73	Pass	V	PK
9	120.0250	9.20	1.30	-32.07	54.67	33.10	43.50	10.40	Pass	V	PK
10	240.0260	11.94	1.84	-31.90	51.20	33.08	46.00	12.92	Pass	V	PK
11	304.0524	13.29	2.07	-31.60	48.79	32.55	46.00	13.45	Pass	V	PK
12	600.0290	19.00	2.96	-31.50	45.78	36.24	46.00	9.76	Pass	V	PK

Transmitter Emission above 1GHz

Mode:			GFSK Transmitting					Channel:		2402	
NO	Freq. [MHz]	Ant Factor [dB]	Cable loss [dB]	Pream gain [dB]	Reading [dB μ V]	Level [dB μ V/m]	Limit [dB μ V/m]	Margin [dB]	Result	Polarity	Remark
1	1859.4859	30.77	3.39	-42.86	51.28	42.58	74.00	31.42	Pass	H	PK
2	3348.0232	33.34	4.52	-43.10	50.68	45.44	74.00	28.56	Pass	H	PK
3	4804.0000	34.50	4.55	-42.80	47.03	43.28	74.00	30.72	Pass	H	PK
4	7206.0000	36.31	5.81	-42.16	47.22	47.18	74.00	26.82	Pass	H	PK
5	9608.0000	37.64	6.63	-42.10	46.53	48.70	74.00	25.30	Pass	H	PK
6	12010.000	39.31	7.60	-41.90	45.81	50.82	74.00	23.18	Pass	H	PK
7	2029.7030	31.74	3.52	-43.19	50.71	42.78	74.00	31.22	Pass	V	PK
8	3018.0012	33.21	4.89	-43.10	50.12	45.12	74.00	28.88	Pass	V	PK
9	4804.0000	34.50	4.55	-42.80	47.91	44.16	74.00	29.84	Pass	V	PK
10	7206.0000	36.31	5.81	-42.16	46.09	46.05	74.00	27.95	Pass	V	PK
11	9608.0000	37.64	6.63	-42.10	45.93	48.10	74.00	25.90	Pass	V	PK
12	12010.000	39.31	7.60	-41.90	46.72	51.73	74.00	22.27	Pass	V	PK

Mode:			GFSK Transmitting					Channel:		2441	
NO	Freq. [MHz]	Ant Factor [dB]	Cable loss [dB]	Pream gain [dB]	Reading [dB μ V]	Level [dB μ V/m]	Limit [dB μ V/m]	Margin [dB]	Result	Polarity	Remark
1	2034.3034	31.75	3.53	-43.19	50.66	42.75	74.00	31.25	Pass	H	PK
2	3036.0024	33.21	4.86	-43.10	50.26	45.23	74.00	28.77	Pass	H	PK
3	4432.0955	34.40	4.73	-42.82	49.70	46.01	74.00	27.99	Pass	H	PK
4	7323.0000	36.42	5.85	-42.13	47.33	47.47	74.00	26.53	Pass	H	PK
5	9764.0000	37.71	6.71	-42.10	46.79	49.11	74.00	24.89	Pass	H	PK
6	12205.000	39.42	7.67	-41.89	45.56	50.76	74.00	23.24	Pass	H	PK
7	2075.7076	31.81	3.57	-43.19	51.54	43.73	74.00	30.27	Pass	V	PK
8	3334.0223	33.33	4.54	-43.10	50.35	45.12	74.00	28.88	Pass	V	PK
9	4882.0000	34.50	4.81	-42.80	47.50	44.01	74.00	29.99	Pass	V	PK
10	7323.0000	36.42	5.85	-42.13	46.87	47.01	74.00	26.99	Pass	V	PK
11	9764.0000	37.71	6.71	-42.10	48.51	50.83	74.00	23.17	Pass	V	PK
12	12205.000	39.42	7.67	-41.89	45.68	50.88	74.00	23.12	Pass	V	PK

Mode:			GFSK Transmitting					Channel:		2480	
NO	Freq. [MHz]	Ant Factor [dB]	Cable loss [dB]	Pream gain [dB]	Reading [dBμV]	Level [dBμV/m]	Limit [dBμV/m]	Margin [dB]	Result	Polarity	Remark
1	2302.9303	32.12	3.80	-43.13	52.00	44.79	74.00	29.21	Pass	H	PK
2	3283.0189	33.31	4.54	-43.10	49.92	44.67	74.00	29.33	Pass	H	PK
3	4960.0000	34.50	4.82	-42.80	47.22	43.74	74.00	30.26	Pass	H	PK
4	7440.0000	36.54	5.85	-42.11	47.23	47.51	74.00	26.49	Pass	H	PK
5	9920.0000	37.77	6.79	-42.10	47.33	49.79	74.00	24.21	Pass	H	PK
6	12400.000	39.54	7.86	-41.90	46.51	52.01	74.00	21.99	Pass	H	PK
7	1837.2837	30.63	3.36	-42.80	51.19	42.38	74.00	31.62	Pass	V	PK
8	3844.0563	33.68	4.36	-43.03	50.68	45.69	74.00	28.31	Pass	V	PK
9	4960.0000	34.50	4.82	-42.80	48.08	44.60	74.00	29.40	Pass	V	PK
10	7440.0000	36.54	5.85	-42.11	46.29	46.57	74.00	27.43	Pass	V	PK
11	9920.0000	37.77	6.79	-42.10	46.80	49.26	74.00	24.74	Pass	V	PK
12	12400.000	39.54	7.86	-41.90	47.56	53.06	74.00	20.94	Pass	V	PK

Mode:			8DPSK Transmitting					Channel:		2402	
NO	Freq. [MHz]	Ant Factor [dB]	Cable loss [dB]	Pream gain [dB]	Reading [dBμV]	Level [dBμV/m]	Limit [dBμV/m]	Margin [dB]	Result	Polarity	Remark
1	1939.2939	31.30	3.42	-43.05	50.54	42.21	74.00	31.79	Pass	H	PK
2	3068.0045	33.23	4.79	-43.10	49.96	44.88	74.00	29.12	Pass	H	PK
3	4804.0000	34.50	4.55	-42.80	47.52	43.77	74.00	30.23	Pass	H	PK
4	7206.0000	36.31	5.81	-42.16	46.33	46.29	74.00	27.71	Pass	H	PK
5	9608.0000	37.64	6.63	-42.10	46.36	48.53	74.00	25.47	Pass	H	PK
6	12010.000	39.31	7.60	-41.90	46.15	51.16	74.00	22.84	Pass	H	PK
7	3198.0132	33.28	4.65	-43.10	50.78	45.61	74.00	28.39	Pass	V	PK
8	4246.0831	34.14	4.51	-42.90	52.03	47.78	74.00	26.22	Pass	V	PK
9	4804.0000	34.50	4.55	-42.80	46.67	42.92	74.00	31.08	Pass	V	PK
10	7206.0000	36.31	5.81	-42.16	45.89	45.85	74.00	28.15	Pass	V	PK
11	9608.0000	37.64	6.63	-42.10	46.27	48.44	74.00	25.56	Pass	V	PK
12	12010.000	39.31	7.60	-41.90	46.78	51.79	74.00	22.21	Pass	V	PK

Mode:			8DPSK Transmitting					Channel:		2441	
NO	Freq. [MHz]	Ant Factor [dB]	Cable loss [dB]	Pream gain [dB]	Reading [dB μ V]	Level [dB μ V/m]	Limit [dB μ V/m]	Margin [dB]	Result	Polarity	Remark
1	1935.4935	31.27	3.42	-43.04	50.97	42.62	74.00	31.38	Pass	H	PK
2	2923.5924	33.08	4.39	-43.10	50.76	45.13	74.00	28.87	Pass	H	PK
3	4882.0000	34.50	4.81	-42.80	47.02	43.53	74.00	30.47	Pass	H	PK
4	7323.0000	36.42	5.85	-42.13	47.00	47.14	74.00	26.86	Pass	H	PK
5	9764.0000	37.71	6.71	-42.10	47.04	49.36	74.00	24.64	Pass	H	PK
6	12205.000	39.42	7.67	-41.89	45.96	51.16	74.00	22.84	Pass	H	PK
7	2160.1160	31.92	3.65	-43.16	51.06	43.47	74.00	30.53	Pass	H	AV
8	3820.0547	33.66	4.37	-43.04	49.79	44.78	74.00	29.22	Pass	V	PK
9	4882.0000	34.50	4.81	-42.80	48.81	45.32	74.00	28.68	Pass	V	PK
10	7323.0000	36.42	5.85	-42.13	46.60	46.74	74.00	27.26	Pass	V	PK
11	9764.0000	37.71	6.71	-42.10	46.34	48.66	74.00	25.34	Pass	V	PK
12	12205.000	39.42	7.67	-41.89	46.10	51.30	74.00	22.70	Pass	V	PK

Mode:			8DPSK Transmitting					Channel:		2480	
N O	Freq. [MHz]	Ant Factor [dB]	Cable loss [dB]	Pream gain [dB]	Reading [dB μ V]	Level [dB μ V/m]	Limit [dB μ V/m]	Margin [dB]	Result	Polarity	Remark
1	1670.8671	29.53	3.17	-42.74	52.67	42.63	74.00	31.37	Pass	H	PK
2	2955.7956	33.13	4.42	-43.10	50.78	45.23	74.00	28.77	Pass	H	PK
3	4960.0000	34.50	4.82	-42.80	49.05	45.57	74.00	28.43	Pass	H	PK
4	7440.0000	36.54	5.85	-42.11	47.48	47.76	74.00	26.24	Pass	H	PK
5	9920.0000	37.77	6.79	-42.10	46.18	48.64	74.00	25.36	Pass	H	PK
6	12400.0000	39.54	7.86	-41.90	48.43	53.93	74.00	20.07	Pass	H	PK
7	1386.4386	28.29	2.88	-42.70	51.04	39.51	74.00	34.49	Pass	V	PK
8	3033.0022	33.21	4.86	-43.09	51.17	46.15	74.00	27.85	Pass	V	PK
9	4960.0000	34.50	4.82	-42.80	47.91	44.43	74.00	29.57	Pass	V	PK
10	7440.0000	36.54	5.85	-42.11	47.60	47.88	74.00	26.12	Pass	V	PK
11	9920.0000	37.77	6.79	-42.10	46.92	49.38	74.00	24.62	Pass	V	PK
12	12400.0000	39.54	7.86	-41.90	45.83	51.33	74.00	22.67	Pass	V	PK

Note:

1) Through Pre-scan Non-hopping transmitting mode and charge+transmitter mode with all kind of modulation and all kind of data type, find the DH5 of data type is the worse case of GFSK modulation type in charge + transmitter mode.

2) The field strength is calculated by adding the Antenna Factor, Cable Factor & Preamplifier. The basic equation with a sample calculation is as follows:

Final Test Level = Receiver Reading - Correct Factor

Correct Factor = Preamplifier Factor - Antenna Factor - Cable Factor

3) Scan from 9kHz to 25GHz, the disturbance above 13GHz and below 30MHz was very low, and the above harmonics were the highest point could be found when testing, so only the above harmonics had been displayed. The amplitude of spurious emissions from the radiator which are attenuated more than 20dB below the limit need not be reported.

PHOTOGRAPHS OF TEST SETUP On Page 85-87

PHOTOGRAPHS OF EUT Constructional Details On Page 88-98