

CAUTIONS:

1. Please format the card before power on, otherwise video errors and freezes will occur during video playback. Please use a high-speed TF card. If a low-speed card is used, problems are likely to occur.
2. You can view the video through the mirror. Or you can connect to the mobile APP to view through the mobile phone.
3. WiFi account: YV09-XXXXXX, Password: 12345678
4. About touch buttons: When two touch areas are touched at the same time, the touch buttons will malfunction temporarily. Function resumes after 15 seconds.

Note: For the best performance and durability of video recording, we recommend to use C10 U1 level TF card or better.

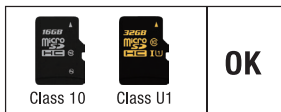

*** This manual is only for your reference, please check the actual product as the standard!**

Serial No.: 2020YV0960603

FCC STATEMENT

Changes or modifications not expressly approved by the party responsible for compliance could void the user's authority to operate the equipment.

This equipment has been tested and found to comply with the limits for a Class B digital device, pursuant to Part 15 of the FCC Rules. These limits are designed to provide reasonable protection against harmful interference in a residential installation. This equipment generates uses and can radiate radio frequency energy and, if not installed and used in accordance with the instructions, may cause harmful interference to radio communications. However, there is no guarantee that interference will not occur in a particular installation. If this equipment does cause harmful interference to radio or television reception, which can be determined by turning the equipment off and on, the user is encouraged to try to correct the interference by one or more of the following measures:

- Reorient or relocate the receiving antenna.
- Increase the separation between the equipment and receiver.
- Connect the equipment into an outlet on a circuit different from that to which the receiver is connected.
- Consult the dealer or an experienced radio/TV technician for help

This device complies with part 15 of the FCC rules. Operation is subject to the following two conditions (1) this device may not cause harmful interference, and (2) this device must accept any interference received, including interference that may cause undesired operation.

This equipment complies with FCC radiation exposure limits set forth for an uncontrolled environment. This equipment should be installed and operated with minimum distance 20cm between the radiator & your body.

9.66 Inch 1080P Streaming Media Mirror Monitor With Built-in Dash Cam

USER MANUAL 2AHL8TE-LVM9



PACKAGE

The package contains the following:



1 Rear view mirror



2 Wire harness



3 Rear camera

9.66" 1080P Streaming Media Mirror Monitor
With Built-in Dash Cam

USER MANUAL



4 User manual

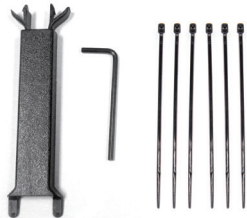

5 Accessories

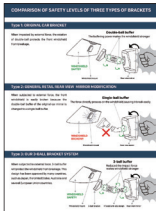

6 User manual for bracket

For the items listed above, please check your packing contents. If any damage, please contact the distributor or the agent as soon as possible.

FEATURES

- Front recording 1080P
- Rear recording 1080P
- 9.66 inch full display screen
- Touch screen button
- Wi-Fi connection
- Parking mode
- Time lapses video
- Night mode
- LCD power save
- G-sensor
- Super Capacitor
- Real-time view on app
- Waterproof rear camera
- Back up camera display

SPECIFICATIONS

Solution	MSC8339D
Flash	DDR3 1GB
Video Resolution	Front 1080P / rear 1080P
Recording Angle	Front 140°/ rear 120°
Video Format	H.264, MOV
Display Screen	9.66 inch MIPI IPS, 1280*320
Memory	SD card (MAX 64GB)

Wi-Fi	0-10m
Super Capacitor	Support
Supporting platform	RTK
Operation Temperature	-20°C-70°C
Storage Temperature	-20°C-70°C
Working Voltage	10-16V
Language	English, Traditional Chinese, ..

BASIC OPERATING INSTRUCTIONS

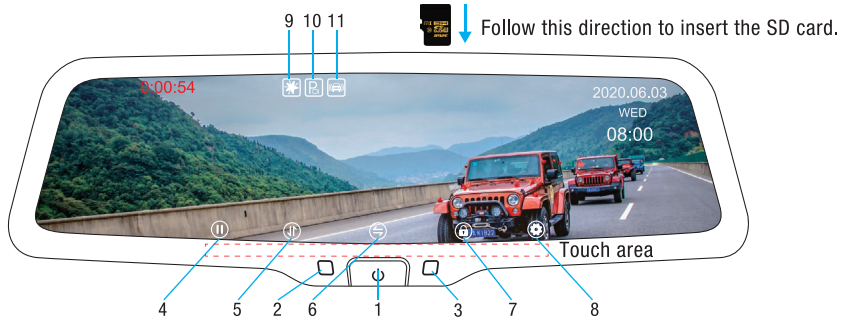

NOTED: The touch area of the keys is not on the glass screen, but on the plastic frame below the key icon.

1: short press to turn on/ off the screen; Long press to turn off the mirror, then short press to restart

2: Light sensor 3: Indicator 4: stop recording; start recording;

5: Short press to adjust the screen display range; Long press to take photo

6: Video switch button (available to use after connecting rear camera)

7: Lock the current video when recording; Enter the "playback" interface when stop recording;

8: Short press to enter the "menu setting" interface when stop recording

9: Night mode icon; 10: Parking monitoring icon; 11: G-sensor icon;

HOW TO WIRE

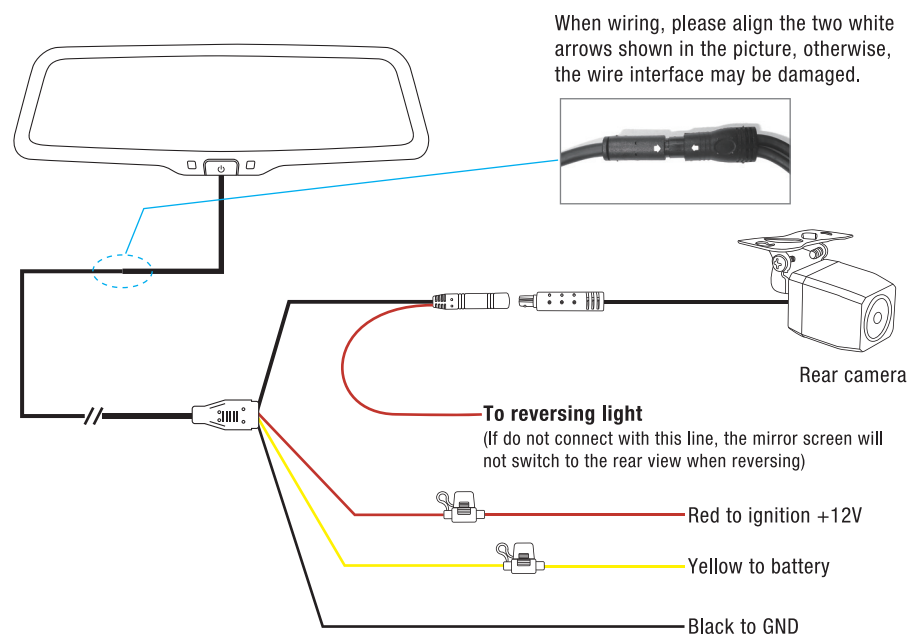

HOW TO INSTALL MIRROR MONITOR

Remove the original mirror

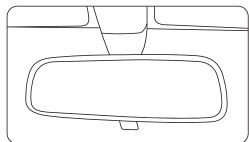

Car factory original mirror

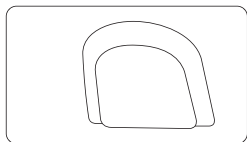

The plate on the windshield

Different cars have different brackets. It depends on your vehicle maker and manufacturer. There are many methods to remove the original rear view mirror, however, please don't force the mirror off the bracket.

The manufacturer will not be responsible for damage caused to your car by wrong installation of the mirror.

Install mirror monitor on the plate

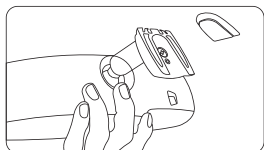

Take down your original mirror, and make the mirror monitor ready

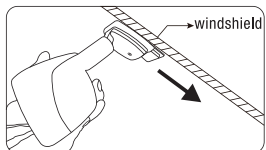

Install rear view mirror along this direction

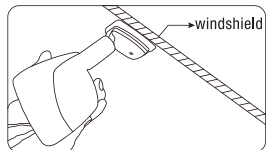

Please make sure to install the mirror to the end of the bottom without any loose

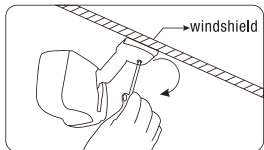

Contrarotate the fixed rear view mirror
Torque is about 0.8-1.3 N.m

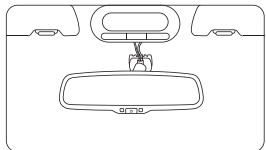

NOTE: Always use caution, DO NOT force the mount. We will not be responsible for broken windshields. If you are not sure how to remove or re-install the mirror seek trained, qualified help.

CAUTION!

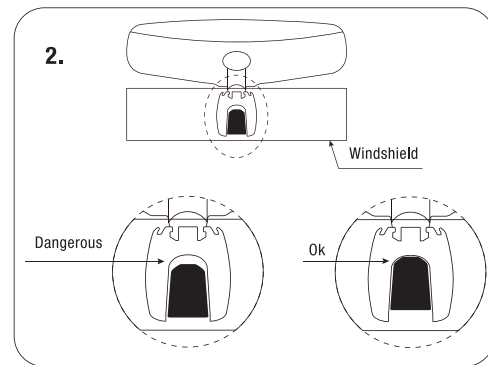
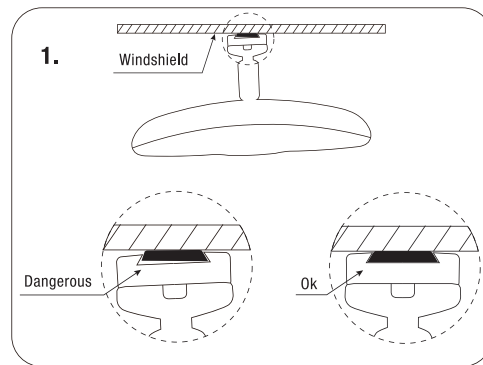

MENU SETTINGS

Stop recording, tap the icon “

Movie Mode: Can set “FHD30 / HD30”. This setting is only for the front camera, not useful for the rear camera.

Movie Clip Time: Can set “1min / 3min/ 5min”.Default 3 minutes.

Night Mode: Can set “on / off”. When the light is dark at night, turn on this function to increase the sensitivity of the lens and take brighter and higher-quality videos.

Sound Record: Can set“on / off”. Default On.

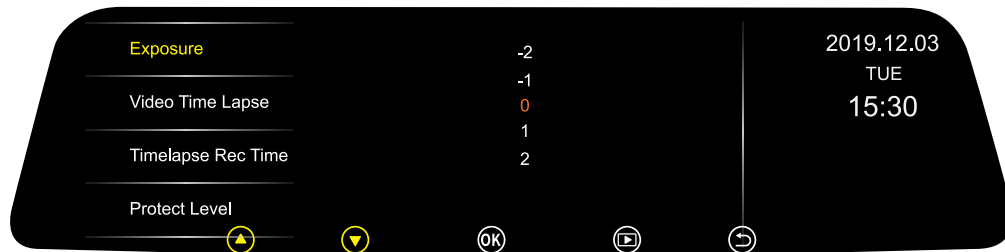

Exposure: Can set “-2 / -1/ 0 / 1 /2”. The default is 0. This setting is only for the front camera, not useful for the rear camera.

Video Time Lapse: Can set “Off / 1FPS / 4FPS”.

Timelapse Rec Time: Can set “2 hours /8 hours /12 hours /24 hours”. Default 2 hours.In “Video Time Lapse option”, select “1FPS” or “4FPS”. When the car is turned off and the machine is in the ACC disconnected state, the machine will prompt to enter the “Timelapse Rec Time”video. When the voltage reaches 11.3±0.15V setting, the machine will stop recording automatically to avoid car engine can’t start properly because of low voltage. When playing a video, it turns a long video of slow motion into a short video of fast motion, similar to fast forward playback in movies. For example, when recording for 1 minute, the video is compressed to 1 second, and the recording for 1 hour is changed to 1 minute to play.

Protect Level (G-sensor): Can set “Off / High / Middle / Low”.

With G-sensor function, dash camera can automatically save the video as event file when it detects acceleration of gravity changes greatly. For example, when car crash happens. The event file will be locked and cannot be overwritten in record cycle mode. It can only be manually deleted one by one or formatted.

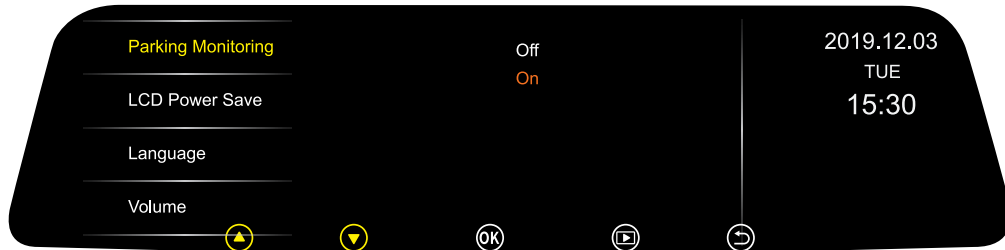

Parking Monitoring: Can set “Off /On”.

When this function is turned on, when the recorder is shaken when it is turned off, it will start the machine to record for 30 seconds and then turn it off.

LCD Power Save: Can set “off / 1min / 3mins”.

After exiting the menu, the mirror will start to count the time once there are no operations. The screen will auto turn off when it reaches the time you set.

Language: “English / Simplified Chinese / Traditional Chinese”etc. There are 8 languages.

Volume: Can set “Off / High / Middle / Low”, default Middle.

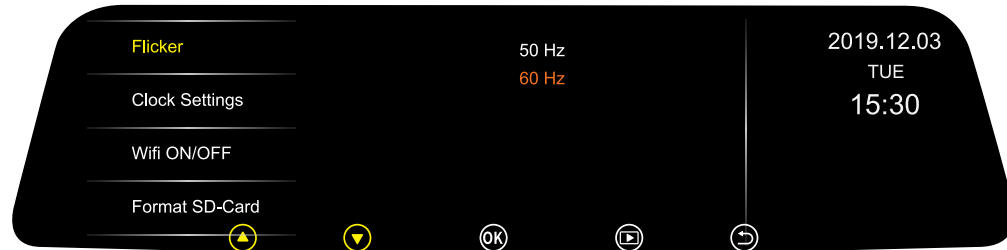

Flicker: Can set “50Hz / 60Hz”.

Each country has different supply frequency due to geographical reason. Standard frequency of dash camera lens is constant 50Hz. When the supply frequency inconsistent with frequency standard the image on the device will appear joggling phenomenon. At this point users should adjust Frequency to consistent with supply frequency.

Clock Settings: Users can adjust the time and date by themselves, or connect the mirror to the phone via WIFI, the time will be updated automatically.

Wifi ON/OFF: Can set “On / Off”.

Format SD-Card: If it's not necessary to save the videos in card, user can delate all videos (both normal video and event files) by formatting.

Reset Setup: After making a lot of custom settings,users can reset the device to the original factory settings.

PLAYBACK

Stop recording, tap the icon “” in the main interface to proceed to the playback interface. There are 6 sub-menus. They are: 1. Front-view normal video; 2. Rear-view normal video; 3. Front-view locked video; 4. Rear-view locked video; 5. Front-view picture; 6. Rear-view picture.

Press “” to switch to “Rear View Normal Video”, as shown in the figure below:

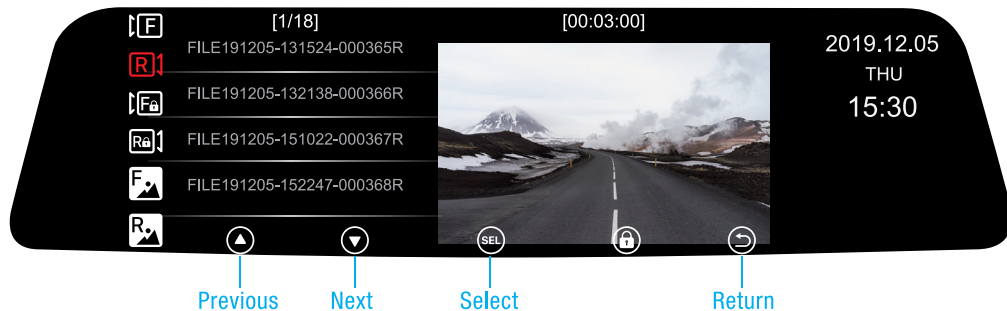

Press “” to select, as shown in the figure below:

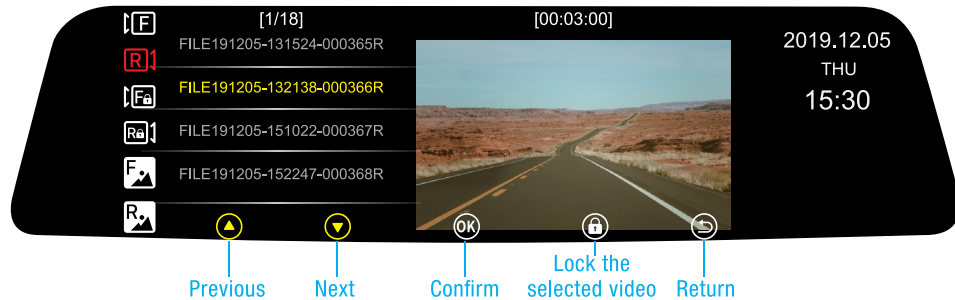

PS: Press and hold “” to delete the current video.



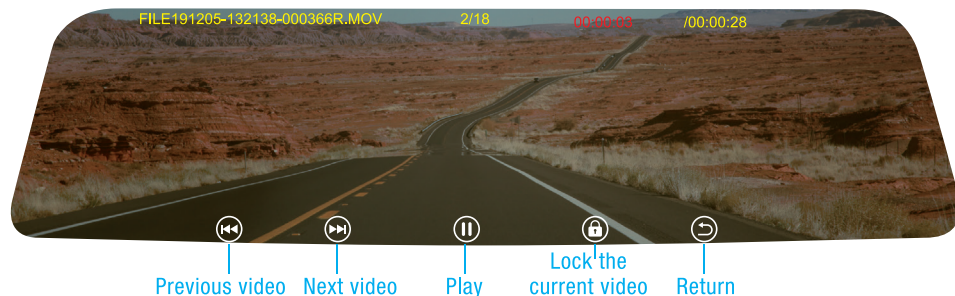

Press “” to select and enter the playback interface, as shown below:



MOBILE PHONE APP CONNECTION and OPERATION

Built- in WiFi module system allows to connect mobile phone through Android or IOS APP, please check below for its setup.

1. Download “ RoadCam” APP.

2. Turn on the rearview mirror, stop recording, tap the icon “” in the main interface to proceed to the menu settings. Find “Wifi ON/OFF” by “” and “” buttons. Press “” to choose “ON”. as shown in Figure 1.

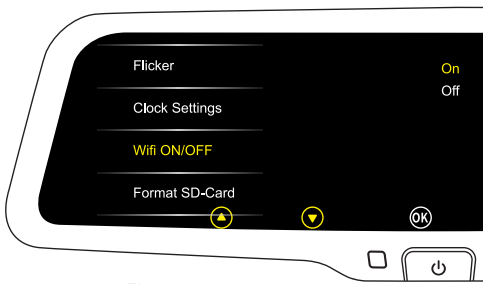

Figure 1

3. The WiFi account and password are displayed in the lower right corner of the screen, as shown in Figure 2.

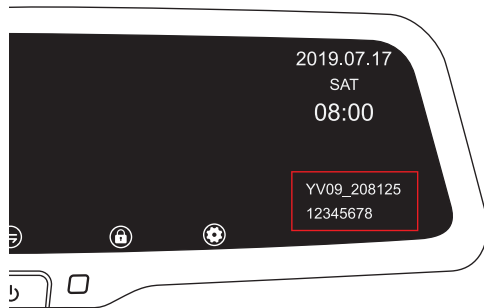

Figure 2

3. Enter mobile phone interface, turn on Wi-Fi and connect Wi-Fi ID, enter initial password: 12345678, then connect. Please see figure 3

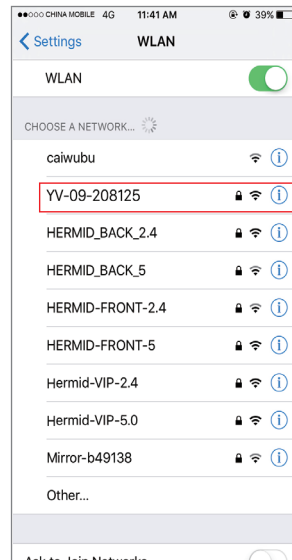

Figure 2

5. In Figure 4, click the “” icon, the phone and rearview mirror are successfully connected, as shown in Figure 5.

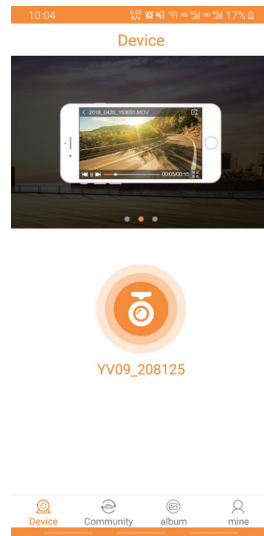

Figure 4

6. Once connected, user can check the recording video and operate accordingly.

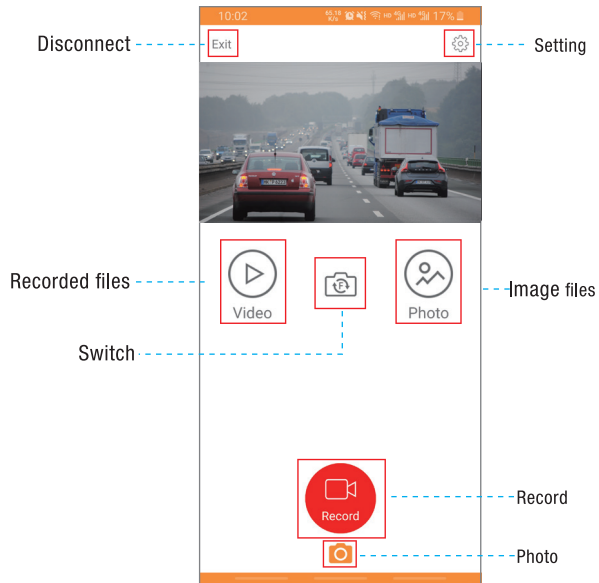

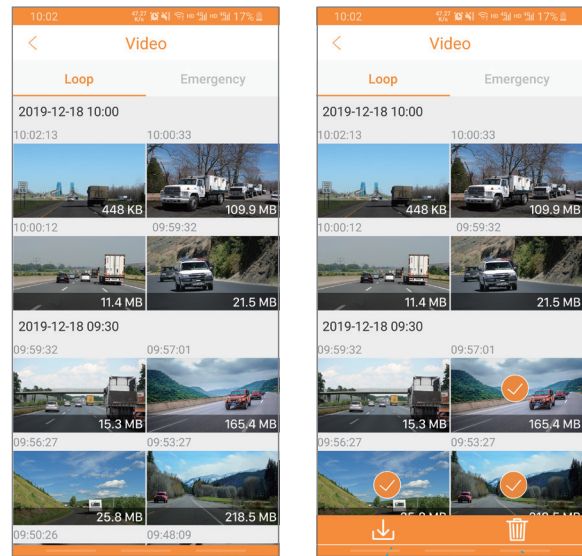

Figure 5

Click “” to enter the list of recorded videos, Press and hold the file thumbnail to select the file, download the video to the local, delete videos in batches, etc. See the figure below.



Download to local album

Delete