

FCC Test Report

Report No.: RF170613E01A-1

FCC ID: 2AHKM-HTEMN3

Test Model: HT-EMN3

Received Date: June 13, 2017

Test Date: July 19 to Aug. 24, 2017

Issued Date: Aug. 30, 2017

Applicant: Hitron Technologies Inc.

Address: No.1-8, Li-Hsin 1st Rd. Hsinchu Science Park, Hsinchu 30078, Taiwan

Issued By: Bureau Veritas Consumer Products Services (H.K.) Ltd., Taoyuan Branch
Hsin Chu Laboratory

Lab Address: E-2, No.1, Li Hsin 1st Road, Hsinchu Science Park, Hsinchu City 300,
Taiwan R.O.C.

Test Location (1): E-2, No.1, Li Hsin 1st Road, Hsinchu Science Park, Hsinchu City 300,
Taiwan R.O.C.

Test Location (2): No. 49, Ln. 206, Wende Rd., Shangshan Tsuen, Chiung Lin Hsiang, Hsin
Chu Hsien 307, Taiwan R.O.C.



This report is for your exclusive use. Any copying or replication of this report to or for any other person or entity, or use of our name or trademark, is permitted only with our prior written permission. This report sets forth our findings solely with respect to the test samples identified herein. The results set forth in this report are not indicative or representative of the quality or characteristics of the lot from which a test sample was taken or any similar or identical product unless specifically and expressly noted. Our report includes all of the tests requested by you and the results thereof based upon the information that you provided to us. You have 60 days from date of issuance of this report to notify us of any material error or omission caused by our negligence, provided, however, that such notice shall be in writing and shall specifically address the issue you wish to raise. A failure to raise such issue within the prescribed time shall constitute your unqualified acceptance of the completeness of this report, the tests conducted and the correctness of the report contents. Unless specific mention, the uncertainty of measurement has been explicitly taken into account to declare the compliance or non-compliance to the specification. The report must not be used by the client to claim product certification, approval, or endorsement by TAF or any government agencies.

Table of Contents

Release Control Record	4
1 Certificate of Conformity	5
2 Summary of Test Results	6
2.1 Measurement Uncertainty	6
2.2 Modification Record	6
3 General Information	7
3.1 General Description of EUT	7
3.2 Description of Test Modes	10
3.2.1 Test Mode Applicability and Tested Channel Detail	11
3.3 Duty Cycle of Test Signal	13
3.4 Description of Support Units	14
3.4.1 Configuration of System under Test	15
3.5 General Description of Applied Standard	16
4 Test Types and Results	17
4.1 Radiated Emission and Bandedge Measurement	17
4.1.1 Limits of Radiated Emission and Bandedge Measurement	17
4.1.2 Test Instruments	18
4.1.3 Test Procedure	20
4.1.4 Deviation from Test Standard	20
4.1.5 Test Setup	21
4.1.6 EUT Operating Condition	22
4.1.7 Test Results	23
4.2 Conducted Emission Measurement	42
4.2.1 Limits of Conducted Emission Measurement	42
4.2.2 Test Instruments	42
4.2.3 Test Procedure	43
4.2.4 Deviation from Test Standard	43
4.2.5 Test Setup	43
4.2.6 EUT Operating Condition	43
4.2.7 Test Results	44
4.3 Transmit Power Measurement	46
4.3.1 Limits of Transmit Power Measurement	46
4.3.2 Test Setup	47
4.3.3 Test Instruments	47
4.3.4 Test Procedure	47
4.3.5 Deviation from Test Standard	47
4.3.6 EUT Operating Condition	47
4.3.7 Test Result	48
4.4 Occupied Bandwidth Measurement	54
4.4.1 Test Setup	54
4.4.2 Test Instruments	54
4.4.3 Test Procedure	54
4.4.4 Test Results	55
4.5 Peak Power Spectral Density Measurement	65
4.5.1 Limits of Peak Power Spectral Density Measurement	65
4.5.2 Test Setup	65
4.5.3 Test Instruments	65
4.5.4 Test Procedure	66
4.5.5 Deviation from Test Standard	66
4.5.6 EUT Operating Condition	66
4.5.7 Test Results	67
4.6 Frequency Stability Measurement	76
4.6.1 Limits of Frequency Stability Measurement	76

4.6.2	Test Setup.....	76
4.6.3	Test Instruments	76
4.6.4	Test Procedure	76
4.6.5	Deviation from Test Standard	76
4.6.6	EUT Operating Condition	76
4.6.7	Test Results	77
4.7	6dB Bandwidth Measurement	78
4.7.1	Limits of 6dB Bandwidth Measurement.....	78
4.7.2	Test Setup.....	78
4.7.3	Test Instruments	78
4.7.4	Test Procedure	78
4.7.5	Deviation from Test Standard	78
4.7.6	EUT Operating Condition	78
4.7.7	Test Results	79
5	Pictures of Test Arrangements.....	81
	Annex A- Radiated Out of Band Emission (OOBE) Measurement (For U-NII-3 band)	82
	Appendix – Information on the Testing Laboratories	86

Release Control Record

Issue No.	Description	Date Issued
RF170613E01A-1	Original release.	Aug. 30, 2017

1 Certificate of Conformity

Product: 4x4 5G Wireless MoCA 2.0 Network Extender

Brand: hitron

Test Model: HT-EMN3

Sample Status: ENGINEERING SAMPLE

Applicant: Hitron Technologies Inc.

Test Date: July 19 to Aug. 24, 2017

Standard: 47 CFR FCC Part 15, Subpart E (Section 15.407)
ANSI C63.10: 2013

The above equipment has been tested by **Bureau Veritas Consumer Products Services (H.K.) Ltd., Taoyuan Branch**, and found compliance with the requirement of the above standards. The test record, data evaluation & Equipment Under Test (EUT) configurations represented herein are true and accurate accounts of the measurements of the sample's EMC characteristics under the conditions specified in this report.

Prepared by :  _____, **Date:** _____
Wendy Wu / Specialist Aug. 30, 2017

Approved by :  _____, **Date:** _____
May Chen / Manager Aug. 30, 2017

2 Summary of Test Results

47 CFR FCC Part 15, Subpart E (Section 15.407)			
FCC Clause	Test Item	Result	Remarks
15.407(b)(6)	AC Power Conducted Emissions	Pass	Meet the requirement of limit. Minimum passing margin is -11.66dB at 0.46641MHz.
15.407(b) (1/2/3/4(i/ii)/6)	Radiated Emissions & Band Edge Measurement*	Pass	Meet the requirement of limit. Minimum passing margin is -0.1dB at 5150MHz, 5646.75MHz.
15.407(a)(1/2/3)	Max Average Transmit Power	Pass	Meet the requirement of limit.
---	Occupied Bandwidth Measurement	-	Reference only.
15.407(a)(1/2/3)	Peak Power Spectral Density	Pass	Meet the requirement of limit.
15.407(e)	6dB bandwidth	Pass	Meet the requirement of limit. (U-NII-3 Band only)
15.407(g)	Frequency Stability	Pass	Meet the requirement of limit.
15.203	Antenna Requirement	Pass	Antenna connector is IPEX not a standard connector.

*For U-NII-3 band compliance with rule part 15.407(b)(4)(i), the OOB test plots were recorded in Annex A.

2.1 Measurement Uncertainty

Where relevant, the following measurement uncertainty levels have been estimated for tests performed on the EUT as specified in CISPR 16-4-2:

Measurement	Frequency	Expanded Uncertainty (k=2) (±)
Conducted Emissions at mains ports	150kHz ~ 30MHz	1.84 dB
Radiated Emissions up to 1 GHz	30MHz ~ 1GHz	5.30 dB
Radiated Emissions above 1 GHz	1GHz ~ 6GHz	5.16 dB
	6GHz ~ 18GHz	4.91 dB
	18GHz ~ 40GHz	5.30 dB

2.2 Modification Record

There were no modifications required for compliance.

3 General Information

3.1 General Description of EUT

Product	4x4 5G Wireless MoCA 2.0 Network Extender
Brand	hitron
Test Model	HT-EMN3
Status of EUT	ENGINEERING SAMPLE
Power Supply Rating	DC 12V from power adapter
Modulation Type	CCK, DQPSK, DBPSK for DSSS 64QAM, 16QAM, QPSK, BPSK for OFDM 256QAM for OFDM in 11ac mode and VHT20/40 mode in 2.4GHz band
Modulation Technology	DSSS, OFDM
Transfer Rate	802.11b: up to 11Mbps 802.11a/g: up to 54Mbps 802.11n: up to 600Mbps 802.11ac: up to 1733.3Mbps
Operating Frequency	2.4GHz: 2.412 ~ 2.462GHz 5GHz: 5.18 ~ 5.24GHz, 5.745 ~ 5.825GHz
Number of Channel	2.4GHz: 802.11b/g, 802.11n (HT20), VHT20 : 11 802.11n (HT40), VHT40: 7 5GHz: 802.11a, 802.11n (HT20), 802.11ac (VHT20): 9 802.11n (HT40), 802.11ac (VHT40): 4 802.11ac (VHT80): 2
Output Power	2.4GHz: 684.125mW 5.18 ~ 5.24GHz: Master: 463.333mW Client: 168.208mW 5.745 ~ 5.825GHz: 793.302mW
Antenna Type	Refer to Note
Antenna Connector	Refer to Note
Accessory Device	Adapter x 1
Data Cable Supplied	NA

Note:

1. Simultaneously transmission condition.

Condition	Technology	
1	WLAN 2.4GHz	WLAN 5GHz

Note: The emission of the simultaneous operation has been evaluated and no non-compliance was found.

2. The EUT must be supplied with a power adapter as following table:

Brand	Model No.	Spec.
AOEM	ADS0248T-W120200	AC Input: 100-240V, 0.6A, 50/60Hz DC Output: 12V, 2.0A DC Output cable: 1.5m, Unshielded

3. The antennas provided to the EUT, please refer to the following table:

Chain No.	Brand	Model	Antenna Gain (dBi)	Frequency range (MHz)	Antenna Type	Connector Type	Cable Length
2G1	Walsin	393000015827	3.56	2400-2500	PCB	IPEX	185mm
2G2		393000015927	4.15	2400-2500	PCB	IPEX	100mm
5G1		393000016027	5.27	5150~5850	PCB	IPEX	135mm
5G2		393000016127	6.17	5150~5850	PCB	IPEX	185mm
5G3		393000016227	5.05	5150~5850	PCB	IPEX	110mm
5G4		393000016327	5.64	5150~5850	PCB	IPEX	60mm

4. The EUT incorporates a MIMO function.

2.4GHz Band			
MODULATION MODE	DATA RATE (MCS)	TX & RX CONFIGURATION	
802.11b	1 ~ 11Mbps	2TX	2RX
802.11g	6 ~ 54Mbps	2TX	2RX
802.11n (HT20)	MCS 0~7	2TX	2RX
	MCS 8~15	2TX	2RX
802.11n (HT40)	MCS 0~7	2TX	2RX
	MCS 8~15	2TX	2RX
802.11ac (VHT20)	MCS0~8 Nss=1	2TX	2RX
	MCS0~8 Nss=2	2TX	2RX
802.11ac (VHT40)	MCS0~9 Nss=1	2TX	2RX
	MCS0~9 Nss=2	2TX	2RX
5GHz Band			
MODULATION MODE	DATA RATE (MCS)	TX & RX CONFIGURATION	
802.11a	6 ~ 54Mbps	4TX	4RX
802.11n (HT20)	MCS 0~7	4TX	4RX
	MCS 8~15	4TX	4RX
	MCS 16~23	4TX	4RX
	MCS 24~31	4TX	4RX
802.11n (HT40)	MCS 0~7	4TX	4RX
	MCS 8~15	4TX	4RX
	MCS 16~23	4TX	4RX
	MCS 24~31	4TX	4RX
802.11ac (VHT20)	MCS0~8 Nss=1	4TX	4RX
	MCS0~8 Nss=2	4TX	4RX
	MCS0~9 Nss=3	4TX	4RX
	MCS0~8 Nss=4	4TX	4RX
802.11ac (VHT40)	MCS0~9 Nss=1	4TX	4RX
	MCS0~9 Nss=2	4TX	4RX
	MCS0~9 Nss=3	4TX	4RX
	MCS0~9 Nss=4	4TX	4RX
802.11ac (VHT80)	MCS0~9 Nss=1	4TX	4RX
	MCS0~9 Nss=2	4TX	4RX
	MCS0~9 Nss=3	4TX	4RX
	MCS0~9 Nss=4	4TX	4RX

Note: The modulation and bandwidth are similar for 802.11n mode for 20MHz (40MHz) and 802.11ac mode for 20MHz (40MHz), therefore investigated worst case to representative mode in test report.

5. This device can support different category application which switched by access point mode and client mode by software.

6. The above EUT information is declared by manufacturer and for more detailed features description, please refer to the manufacturer's specifications or user's manual.

3.2 Description of Test Modes

FOR 5180 ~ 5240MHz

4 channels are provided for 802.11a, 802.11n (HT20), 802.11ac (VHT20):

Channel	Frequency	Channel	Frequency
36	5180 MHz	44	5220 MHz
40	5200 MHz	48	5240 MHz

2 channels are provided for 802.11n (HT40), 802.11ac (VHT40):

Channel	Frequency	Channel	Frequency
38	5190 MHz	46	5230 MHz

1 channel is provided for 802.11ac (VHT80):

Channel	Frequency
42	5210 MHz

FOR 5745 ~ 5825MHz:

5 channels are provided for 802.11a, 802.11n (HT20), 802.11ac (VHT20):

Channel	Frequency	Channel	Frequency
149	5745 MHz	161	5805 MHz
153	5765 MHz	165	5825 MHz
157	5785 MHz		

2 channels are provided for 802.11n (HT40), 802.11ac (VHT40):

Channel	Frequency	Channel	Frequency
151	5755 MHz	159	5795 MHz

1 channel is provided for 802.11ac (VHT80):

Channel	Frequency
155	5775 MHz

3.2.1 Test Mode Applicability and Tested Channel Detail

EUT Configure Mode	Applicable To				Description
	RE≥1G	RE<1G	PLC	APCM	
-	√	√	√	√	-

Where **RE≥1G**: Radiated Emission above 1GHz **RE<1G**: Radiated Emission below 1GHz
PLC: Power Line Conducted Emission **APCM**: Antenna Port Conducted Measurement

Radiated Emission Test (Above 1GHz):

- Pre-Scan has been conducted to determine the worst-case mode from all possible combinations between available modulations, data rates and antenna ports (if EUT with antenna diversity architecture).
- Following channel(s) was (were) selected for the final test as listed below.

Mode	FREQ. Band (MHz)	Available Channel	Tested Channel	Modulation Technology	Modulation Type	Data Rate (Mbps)
802.11a	5180-5240	36 to 48	36, 40, 48	OFDM	BPSK	6
802.11ac (VHT20)		36 to 48	36, 40, 48	OFDM	BPSK	6.5
802.11ac (VHT40)		38 to 46	38, 46	OFDM	BPSK	13.5
802.11ac (VHT80)		42	42	OFDM	BPSK	29.3
802.11a	5745-5825	149 to 165	149, 157, 165	OFDM	BPSK	6
802.11ac (VHT20)		149 to 165	149, 157, 165	OFDM	BPSK	6.5
802.11ac (VHT40)		151 to 159	151, 159	OFDM	BPSK	13.5
802.11ac (VHT80)		155	155	OFDM	BPSK	29.3

Radiated Emission Test (Below 1GHz):

- Pre-Scan has been conducted to determine the worst-case mode from all possible combinations between available modulations, data rates and antenna ports (if EUT with antenna diversity architecture).
- Following channel(s) was (were) selected for the final test as listed below.

Mode	FREQ. Band (MHz)	Available Channel	Tested Channel	Modulation Technology	Modulation Type	Data Rate (Mbps)
802.11ac (VHT20)	5180-5240 5745-5825	36 to 48 149 to 165	149	OFDM	BPSK	6.5

Power Line Conducted Emission Test:

- Pre-Scan has been conducted to determine the worst-case mode from all possible combinations between available modulations, data rates and antenna ports (if EUT with antenna diversity architecture).
- Following channel(s) was (were) selected for the final test as listed below.

Mode	FREQ. Band (MHz)	Available Channel	Tested Channel	Modulation Technology	Modulation Type	Data Rate (Mbps)
802.11ac (VHT20)	5180-5240 5745-5825	36 to 48 149 to 165	149	OFDM	BPSK	6.5

Antenna Port Conducted Measurement:

- This item includes all test value of each mode, but only includes spectrum plot of worst value of each mode.
- Pre-Scan has been conducted to determine the worst-case mode from all possible combinations between available modulations, data rates and antenna ports (if EUT with antenna diversity architecture).
- Following channel(s) was (were) selected for the final test as listed below.

Mode	FREQ. Band (MHz)	Available Channel	Tested Channel	Modulation Technology	Modulation Type	Data Rate (Mbps)
802.11a	5180-5240	36 to 48	36, 40, 48	OFDM	BPSK	6
802.11ac (VHT20)		36 to 48	36, 40, 48	OFDM	BPSK	6.5
802.11ac (VHT40)		38 to 46	38, 46	OFDM	BPSK	13.5
802.11ac (VHT80)		42	42	OFDM	BPSK	29.3
802.11a	5745-5825	149 to 165	149, 157, 165	OFDM	BPSK	6
802.11ac (VHT20)		149 to 165	149, 157, 165	OFDM	BPSK	6.5
802.11ac (VHT40)		151 to 159	151, 159	OFDM	BPSK	13.5
802.11ac (VHT80)		155	155	OFDM	BPSK	29.3

Test Condition:

Applicable To	Environmental Conditions	Input Power	Tested By
RE \geq 1G	21deg. C, 64%RH	120Vac, 60Hz	Rey Chen
RE $<$ 1G	24deg. C, 70%RH	120Vac, 60Hz	Andy Ho
PLC	24deg. C, 66%RH	120Vac, 60Hz	Jyunchun Lin
APCM	25deg. C, 60%RH	120Vac, 60Hz	Robert Cheng

3.3 Duty Cycle of Test Signal

Duty cycle of test signal is 100 %, duty factor is not required.

802.11a

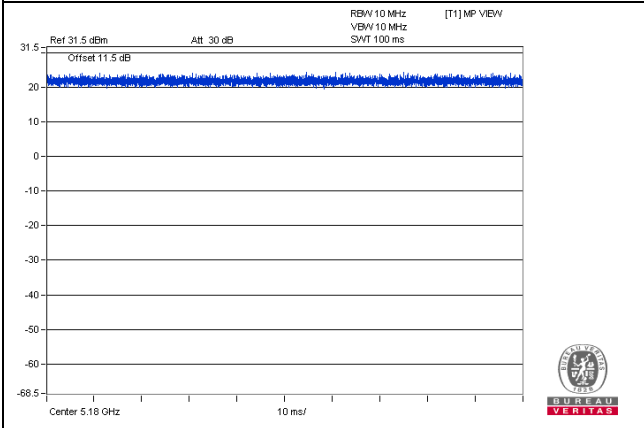

802.11ac (VHT20)

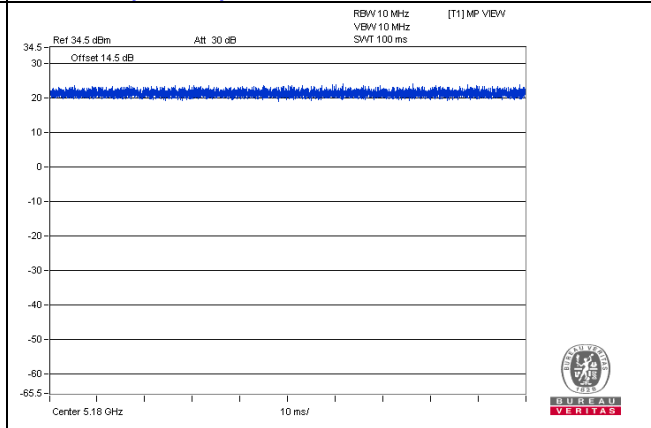

802.11ac (VHT40)

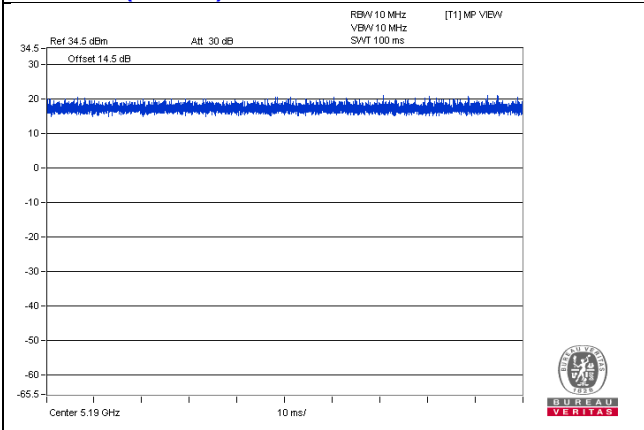

802.11ac (VHT80)

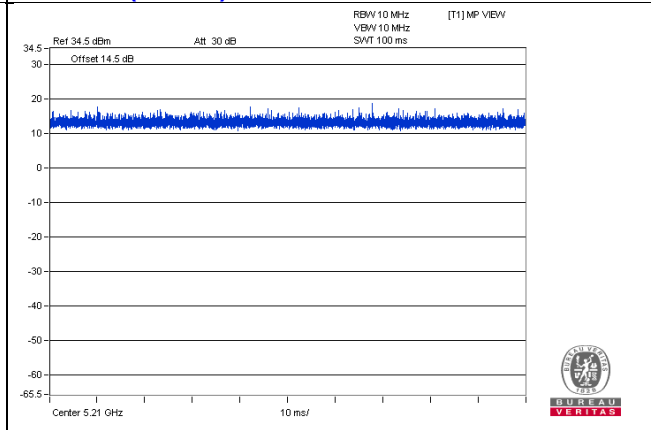

3.4 Description of Support Units

The EUT has been tested as an independent unit together with other necessary accessories or support units. The following support units or accessories were used to form a representative test configuration during the tests.

ID	Product	Brand	Model No.	Serial No.	FCC ID	Remarks
A.	Laptop	DELL	E5430	HYV4VY1	FCC DoC	Provided by Lab

Note:

1. All power cords of the above support units are non-shielded (1.8m).

ID	Descriptions	Qty.	Length (m)	Shielding (Yes/No)	Cores (Qty.)	Remarks
1.	DC Cable	1	1.5	No	0	Supplied by client
2.	RJ-45 Cable	1	10	No	0	Provided by Lab
3.	Coaxial Cable	1	10	Yes	0	Provided by Lab
4.	Coaxial Cable	1	10	Yes	0	Provided by Lab

3.4.1 Configuration of System under Test

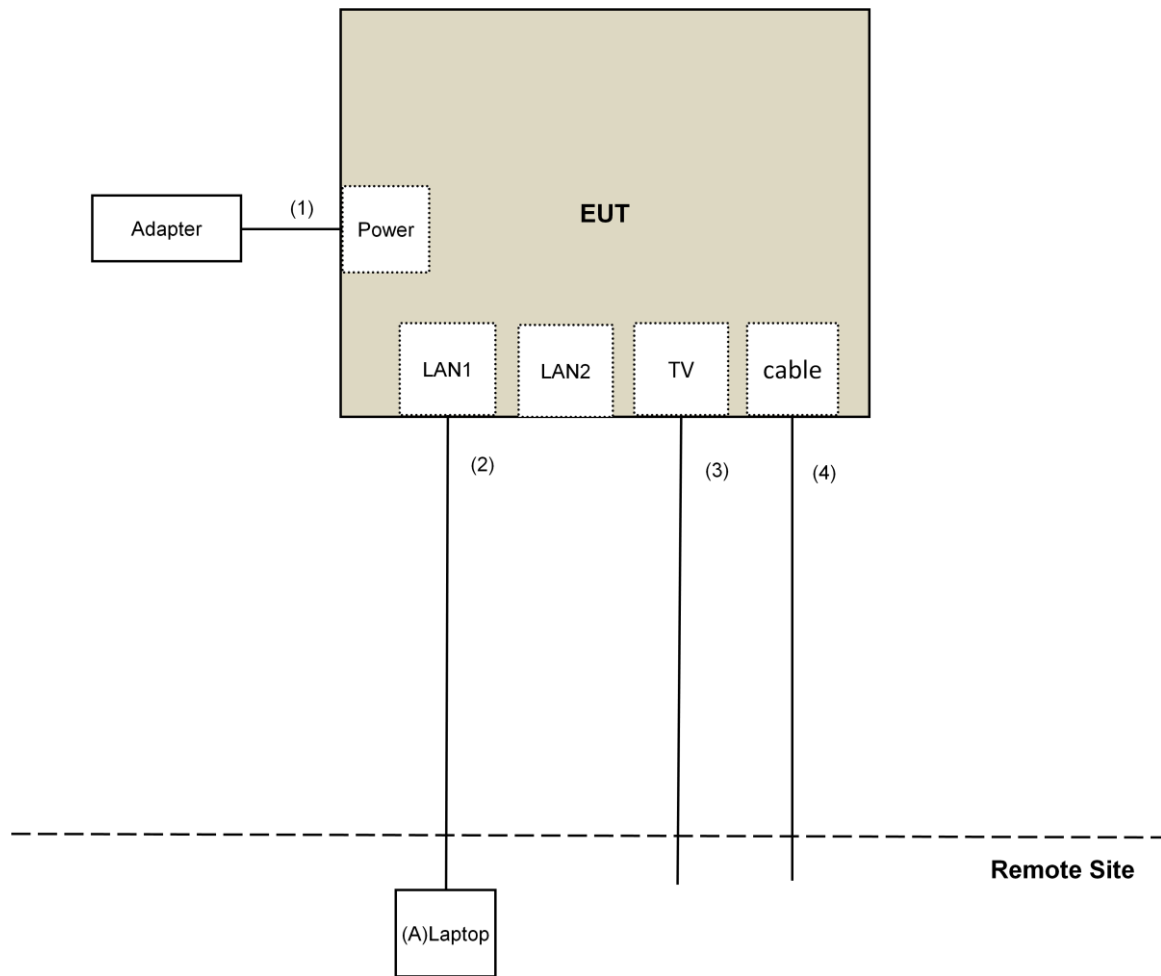

3.5 General Description of Applied Standard

The EUT is a RF Product. According to the specifications of the manufacturer, it must comply with the requirements of the following standards:

FCC Part 15, Subpart E (15.407)
KDB 789033 D02 General UNII Test Procedure New Rules v01r04
KDB 662911 D01 Multiple Transmitter Output v02r01
ANSI C63.10-2013

All test items have been performed and recorded as per the above standards.

NOTE: The EUT has been verified to comply with the requirements of FCC Part 15, Subpart B, Class B (DoC). The test report has been issued separately.

4 Test Types and Results

4.1 Radiated Emission and Bandedge Measurement

4.1.1 Limits of Radiated Emission and Bandedge Measurement

Radiated emissions which fall in the restricted bands must comply with the radiated emission limits specified as below table.

Frequencies (MHz)	Field Strength (microvolts/meter)	Measurement Distance (meters)
0.009 ~ 0.490	2400/F(kHz)	300
0.490 ~ 1.705	24000/F(kHz)	30
1.705 ~ 30.0	30	30
30 ~ 88	100	3
88 ~ 216	150	3
216 ~ 960	200	3
Above 960	500	3

NOTE:

1. The lower limit shall apply at the transition frequencies.
2. Emission level (dBuV/m) = 20 log Emission level (uV/m).
3. For frequencies above 1000MHz, the field strength limits are based on average detector, however, the peak field strength of any emission shall not exceed the maximum permitted average limits, specified above by more than 20dB under any condition of modulation.

Limits of unwanted emission out of the restricted bands

Applicable To		Limit	
789033 D02 General UNII Test Procedure New Rules v01r04		Field Strength at 3m	
		PK:74 (dBuV/m)	AV:54 (dBuV/m)
Frequency Band	Applicable To	EIRP Limit	Equivalent Field Strength at 3m
5150~5250 MHz	15.407(b)(1)	PK:-27 (dBm/MHz)	PK:68.2(dBuV/m)
5250~5350 MHz	15.407(b)(2)		
5470~5725 MHz	15.407(b)(3)		
5725~5850 MHz	<input checked="" type="checkbox"/> 15.407(b)(4)(i)	PK:-27 (dBm/MHz) ^{*1} PK:10 (dBm/MHz) ^{*2} PK:15.6 (dBm/MHz) ^{*3} PK:27 (dBm/MHz) ^{*4}	PK: 68.2(dBuV/m) ^{*1} PK:105.2 (dBuV/m) ^{*2} PK: 110.8(dBuV/m) ^{*3} PK:122.2 (dBuV/m) ^{*4}
	<input type="checkbox"/> 15.407(b)(4)(ii)	Emission limits in section 15.247(d)	
^{*1} beyond 75 MHz or more above of the band edge.		^{*2} below the band edge increasing linearly to 10 dBm/MHz at 25 MHz above.	
^{*3} below the band edge increasing linearly to a level of 15.6 dBm/MHz at 5 MHz above.		^{*4} from 5 MHz above or below the band edge increasing linearly to a level of 27 dBm/MHz at the band edge.	

Note:

The following formula is used to convert the equipment isotropic radiated power (eirp) to field strength:

$$E = \frac{1000000\sqrt{30P}}{3} \mu\text{V/m, where P is the eirp (Watts).}$$

4.1.2 Test Instruments

DESCRIPTION & MANUFACTURER	MODEL NO.	SERIAL NO.	CALIBRATED DATE	CALIBRATED UNTIL
Test Receiver Keysight	N9038A	MY54450088	July 08, 2017	July 07, 2018
Pre-Amplifier ^(*) EMCI	EMC001340	980142	Jan. 20, 2016	Jan. 19, 2018
Loop Antenna ^(*) Electro-Metrics	EM-6879	264	Dec. 16, 2016	Dec. 15, 2018
RF Cable	NA	LOOPCAB-001 LOOPCAB-002	Jan. 17, 2017	Jan. 16, 2018
Pre-Amplifier Mini-Circuits	ZFL-1000VH2B	AMP-ZFL-01	Nov. 10, 2016	Nov. 09, 2017
Trilog Broadband Antenna SCHWARZBECK	VULB 9168	9168-406	Dec. 13, 2016	Dec. 12, 2017
RF Cable	8D	966-4-1 966-4-2 966-4-3	Apr. 01, 2017	Mar. 31, 2018
Fixed attenuator Mini-Circuits	UNAT-5+	PAD-3m-4-01	Oct. 05, 2016	Oct. 04, 2017
Horn_Antenna SCHWARZBECK	BBHA 9120D	9120D-783	Dec. 27, 2016	Dec. 26, 2017
Pre-Amplifier EMCI	EMC12630SE	980385	Feb. 02, 2017	Feb. 01, 2018
RF Cable	EMC104-SM-SM-1 200 EMC104-SM-SM-2 000 EMC104-SM-SM-5 000	160923 150318 150321	Feb. 02, 2017 Mar. 29, 2017 Mar. 29, 2017	Feb. 01, 2018 Mar. 28, 2018 Mar. 28, 2018
Pre-Amplifier EMCI	EMC184045SE	980387	Feb. 02, 2017	Feb. 01, 2018
Horn_Antenna SCHWARZBECK	BBHA 9170	BBHA9170608	Dec. 15, 2016	Dec. 14, 2017
RF Cable	SUCOFLEX 102	36432/2 36433/2	Jan. 15, 2017	Jan. 14, 2018
Software	ADT_Radiated_V8. 7.08	NA	NA	NA
Antenna Tower & Turn Table Max-Full	MF-7802	MF780208410	NA	NA
Boresight Antenna Fixture	FBA-01	FBA-SIP02	NA	NA
Spectrum Analyzer R&S	FSP40	100964	July 1, 2017	June 30, 2018
Power meter Anritsu	ML2495A	MY48250253	Dec. 21, 2016	Dec. 20, 2017
Power sensor Anritsu	MA2411B	1014008	May 11, 2017	May 10, 2018
AC Power Source Extech Electronics	6205	1440452	NA	NA
Temperature & Humidity Chamber Giant Force	GTH-150-40-SP-A R	MAA0812-008	Jan. 11, 2017	Jan. 10, 2018
Digital Multimeter FLUKE	87III	73680266	Nov. 10, 2016	Nov. 09, 2017

NOTE:

1. The calibration interval of the above test instruments is 12 months and the calibrations are traceable to NML/ROC and NIST/USA.
2. *The calibration interval of the above test instruments is 24 months and the calibrations are traceable to NML/ROC and NIST/USA.
3. The test was performed in 966 Chamber No. 4.
4. The CANADA Site Registration No. is 20331-2
5. Loop antenna was used for all emissions below 30 MHz.
6. Tested Date: July 19 to Aug. 24, 2017.

4.1.3 Test Procedure

For Radiated emission below 30MHz

- a. The EUT was placed on the top of a rotating table 0.8 meters above the ground at a 3 meter chamber room. The table was rotated 360 degrees to determine the position of the highest radiation.
- b. The EUT was set 3 meters away from the interference-receiving antenna, which was mounted on the top of a variable-height antenna tower.
- c. Both X and Y axes of the antenna are set to make the measurement.
- d. For each suspected emission, the EUT was arranged to its worst case and the rotatable table was turned from 0 degrees to 360 degrees to find the maximum reading.
- e. The test-receiver system was set to Quasi-Peak Detect Function and Specified Bandwidth with Maximum Hold Mode.

NOTE:

1. The resolution bandwidth and video bandwidth of test receiver/spectrum analyzer is 9kHz at frequency below 30MHz.

For Radiated emission above 30MHz

- a. The EUT was placed on the top of a rotating table 0.8 meters (for 30MHz ~ 1GHz) / 1.5 meters (for above 1GHz) above the ground at 3 meter chamber room for test. The table was rotated 360 degrees to determine the position of the highest radiation.
- b. The EUT was set 3 meters away from the interference-receiving antenna, which was mounted on the top of a variable-height antenna tower.
- c. The height of antenna is varied from one meter to four meters above the ground to determine the maximum value of the field strength. Both horizontal and vertical polarizations of the antenna are set to make the measurement.
- d. For each suspected emission, the EUT was arranged to its worst case and then the antenna was tuned to heights from 1 meter to 4 meters and the rotatable table was turned from 0 degrees to 360 degrees to find the maximum reading.
- e. The test-receiver system was set to quasi-peak detect function and specified bandwidth with maximum hold mode when the test frequency is below 1 GHz.
- f. The test-receiver system was set to peak and average detect function and specified bandwidth with maximum hold mode when the test frequency is above 1 GHz. If the peak reading value also meets average limit, measurement with the average detector is unnecessary.

Note:

1. The resolution bandwidth and video bandwidth of test receiver/spectrum analyzer is 120kHz for Quasi-peak detection (QP) at frequency below 1GHz.
2. The resolution bandwidth of test receiver/spectrum analyzer is 1 MHz and the video bandwidth is 3 MHz for Peak detection (PK) at frequency above 1GHz.
3. The resolution bandwidth of test receiver/spectrum analyzer is 1MHz and the video bandwidth is $\geq 1/T$ (Duty cycle < 98%) or 10Hz (Duty cycle $\geq 98\%$) for Average detection (AV) at frequency above 1GHz.
4. All modes of operation were investigated and the worst-case emissions are reported.

4.1.4 Deviation from Test Standard

No deviation.

4.1.5 Test Setup

For Radiated emission below 30MHz

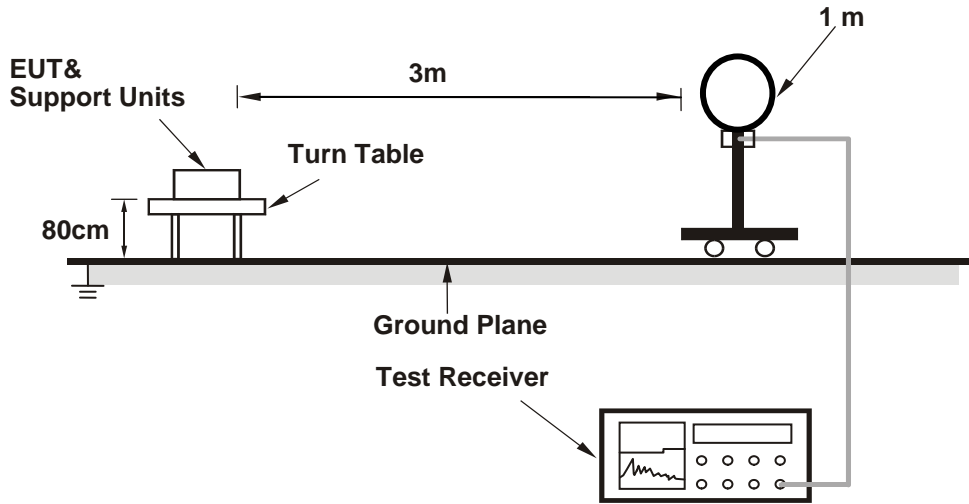

For Radiated emission 30MHz to 1GHz

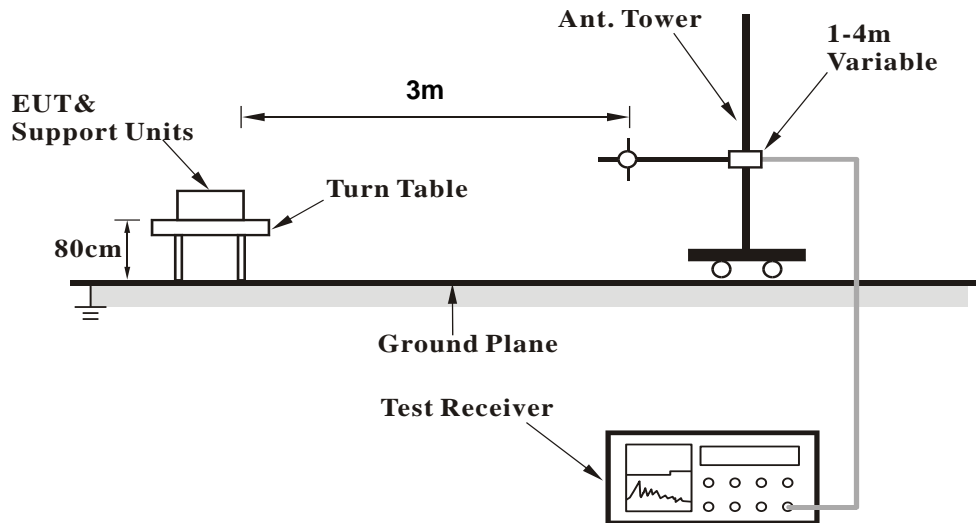

For Radiated emission above 1GHz

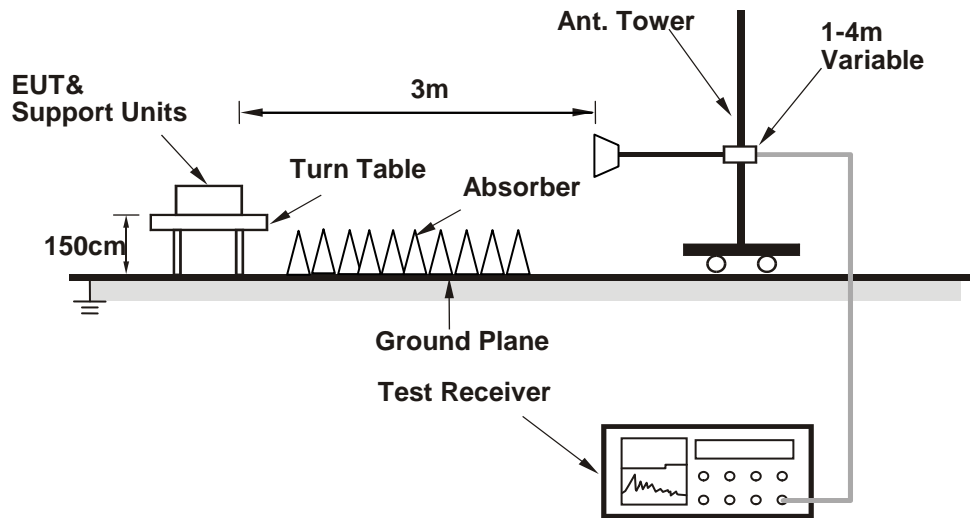

For the actual test configuration, please refer to the attached file (Test Setup Photo).

4.1.6 EUT Operating Condition

- a. Connected the EUT with the Laptop which is placed on remote site.
- b. Controlling software (QATool_Dbg.exe[Ver 0.0.1.71]) has been activated to set the EUT on specific status.

4.1.7 Test Results

Above 1GHz Data:

802.11a

CHANNEL	TX Channel 36	DETECTOR FUNCTION	Peak (PK)
FREQUENCY RANGE	1GHz ~ 40GHz		Average (AV)

ANTENNA POLARITY & TEST DISTANCE: HORIZONTAL AT 3 M

NO.	FREQ. (MHz)	EMISSION LEVEL (dBuV/m)	LIMIT (dBuV/m)	MARGIN (dB)	ANTENNA HEIGHT (m)	TABLE ANGLE (Degree)	RAW VALUE (dBuV)	CORRECTION FACTOR (dB/m)
1	5150.00	70.8 PK	74.0	-3.2	1.00 H	158	66.8	4.0
2	5150.00	51.8 AV	54.0	-2.2	1.00 H	158	47.8	4.0
3	*5180.00	115.3 PK			1.00 H	158	111.3	4.0
4	*5180.00	105.5 AV			1.00 H	158	101.5	4.0
5	#10360.00	47.7 PK	74.0	-26.3	1.20 H	207	34.1	13.6
6	#10360.00	34.9 AV	54.0	-19.1	1.20 H	207	21.3	13.6
7	15540.00	53.5 PK	74.0	-20.5	2.10 H	236	40.3	13.2
8	15540.00	40.8 AV	54.0	-13.2	2.10 H	236	27.6	13.2

ANTENNA POLARITY & TEST DISTANCE: VERTICAL AT 3 M

NO.	FREQ. (MHz)	EMISSION LEVEL (dBuV/m)	LIMIT (dBuV/m)	MARGIN (dB)	ANTENNA HEIGHT (m)	TABLE ANGLE (Degree)	RAW VALUE (dBuV)	CORRECTION FACTOR (dB/m)
1	5150.00	73.1 PK	74.0	-0.9	1.16 V	188	69.1	4.0
2	5150.00	53.9 AV	54.0	-0.1	1.16 V	188	49.9	4.0
3	*5180.00	115.9 PK			1.16 V	188	111.9	4.0
4	*5180.00	106.3 AV			1.16 V	188	102.3	4.0
5	#10360.00	52.1 PK	74.0	-21.9	1.23 V	48	38.5	13.6
6	#10360.00	39.2 AV	54.0	-14.8	1.23 V	48	25.6	13.6
7	15540.00	56.7 PK	74.0	-17.3	2.02 V	187	43.5	13.2
8	15540.00	43.0 AV	54.0	-11.0	2.02 V	187	29.8	13.2

REMARKS:

- Emission Level(dBuV/m) = Raw Value(dBuV) + Correction Factor(dB/m)
- Correction Factor(dB/m) = Antenna Factor(dB/m) + Cable Factor(dB) – Pre-Amplifier Factor(dB)
- The other emission levels were very low against the limit.
- Margin value = Emission Level – Limit value
- " * ": Fundamental frequency.
- " # ": The radiated frequency is out of the restricted band.

CHANNEL	TX Channel 40	DETECTOR FUNCTION	Peak (PK)
FREQUENCY RANGE	1GHz ~ 40GHz		Average (AV)

ANTENNA POLARITY & TEST DISTANCE: HORIZONTAL AT 3 M

NO.	FREQ. (MHz)	EMISSION LEVEL (dBuV/m)	LIMIT (dBuV/m)	MARGIN (dB)	ANTENNA HEIGHT (m)	TABLE ANGLE (Degree)	RAW VALUE (dBuV)	CORRECTION FACTOR (dB/m)
1	5150.00	67.5 PK	74.0	-6.5	1.00 H	157	63.5	4.0
2	5150.00	53.2 AV	54.0	-0.8	1.00 H	157	49.2	4.0
3	*5200.00	118.2 PK			1.00 H	157	114.2	4.0
4	*5200.00	108.6 AV			1.00 H	157	104.6	4.0
5	5350.00	53.9 PK	74.0	-20.1	1.00 H	157	49.5	4.4
6	5350.00	42.1 AV	54.0	-11.9	1.00 H	157	37.7	4.4
7	#10400.00	48.2 PK	74.0	-25.8	1.14 H	198	34.6	13.6
8	#10400.00	35.1 AV	54.0	-18.9	1.14 H	198	21.5	13.6
9	15600.00	53.5 PK	74.0	-20.5	2.08 H	224	40.1	13.4
10	15600.00	40.7 AV	54.0	-13.3	2.08 H	224	27.3	13.4

ANTENNA POLARITY & TEST DISTANCE: VERTICAL AT 3 M

NO.	FREQ. (MHz)	EMISSION LEVEL (dBuV/m)	LIMIT (dBuV/m)	MARGIN (dB)	ANTENNA HEIGHT (m)	TABLE ANGLE (Degree)	RAW VALUE (dBuV)	CORRECTION FACTOR (dB/m)
1	5150.00	68.1 PK	74.0	-5.9	1.00 V	162	64.1	4.0
2	5150.00	53.9 AV	54.0	-0.1	1.00 V	162	49.9	4.0
3	*5200.00	119.7 PK			1.00 V	162	115.7	4.0
4	*5200.00	109.5 AV			1.00 V	162	105.5	4.0
5	5350.00	54.7 PK	74.0	-19.3	1.00 V	162	50.3	4.4
6	5350.00	42.8 AV	54.0	-11.2	1.00 V	162	38.4	4.4
7	#10400.00	52.7 PK	74.0	-21.3	1.18 V	55	39.1	13.6
8	#10400.00	39.6 AV	54.0	-14.4	1.18 V	55	26.0	13.6
9	15600.00	56.6 PK	74.0	-17.4	2.07 V	191	43.2	13.4
10	15600.00	43.1 AV	54.0	-10.9	2.07 V	191	29.7	13.4

REMARKS:

- Emission Level(dBuV/m) = Raw Value(dBuV) + Correction Factor(dB/m)
- Correction Factor(dB/m) = Antenna Factor(dB/m) + Cable Factor(dB) – Pre-Amplifier Factor(dB)
- The other emission levels were very low against the limit.
- Margin value = Emission Level – Limit value
- " * ": Fundamental frequency.
- " # ": The radiated frequency is out of the restricted band.

CHANNEL	TX Channel 48	DETECTOR FUNCTION	Peak (PK)
FREQUENCY RANGE	1GHz ~ 40GHz		Average (AV)

ANTENNA POLARITY & TEST DISTANCE: HORIZONTAL AT 3 M

NO.	FREQ. (MHz)	EMISSION LEVEL (dBuV/m)	LIMIT (dBuV/m)	MARGIN (dB)	ANTENNA HEIGHT (m)	TABLE ANGLE (Degree)	RAW VALUE (dBuV)	CORRECTION FACTOR (dB/m)
1	5150.00	62.9 PK	74.0	-11.1	1.00 H	156	58.9	4.0
2	5150.00	48.5 AV	54.0	-5.5	1.00 H	156	44.5	4.0
3	*5240.00	121.2 PK			1.00 H	156	117.0	4.2
4	*5240.00	111.2 AV			1.00 H	156	107.0	4.2
5	5350.00	56.6 PK	74.0	-17.4	1.00 H	156	52.2	4.4
6	5350.00	44.6 AV	54.0	-9.4	1.00 H	156	40.2	4.4
7	#10480.00	51.1 PK	74.0	-22.9	1.00 H	198	37.4	13.7
8	#10480.00	39.1 AV	54.0	-14.9	1.00 H	198	25.4	13.7
9	15720.00	54.6 PK	74.0	-19.4	2.08 H	226	40.6	14.0
10	15720.00	43.4 AV	54.0	-10.6	2.08 H	226	29.4	14.0

ANTENNA POLARITY & TEST DISTANCE: VERTICAL AT 3 M

NO.	FREQ. (MHz)	EMISSION LEVEL (dBuV/m)	LIMIT (dBuV/m)	MARGIN (dB)	ANTENNA HEIGHT (m)	TABLE ANGLE (Degree)	RAW VALUE (dBuV)	CORRECTION FACTOR (dB/m)
1	5150.00	63.8 PK	74.0	-10.2	1.00 V	189	59.8	4.0
2	5150.00	49.6 AV	54.0	-4.4	1.00 V	189	45.6	4.0
3	*5240.00	122.6 PK			1.00 V	189	118.4	4.2
4	*5240.00	112.8 AV			1.00 V	189	108.6	4.2
5	5350.00	58.0 PK	74.0	-16.0	1.00 V	189	53.6	4.4
6	5350.00	46.3 AV	54.0	-7.7	1.00 V	189	41.9	4.4
7	#10480.00	55.5 PK	74.0	-18.5	1.10 V	53	41.8	13.7
8	#10480.00	43.1 AV	54.0	-10.9	1.10 V	53	29.4	13.7
9	15720.00	58.2 PK	74.0	-15.8	2.00 V	133	44.2	14.0
10	15720.00	46.6 AV	54.0	-7.4	2.00 V	133	32.6	14.0

REMARKS:

- Emission Level(dBuV/m) = Raw Value(dBuV) + Correction Factor(dB/m)
- Correction Factor(dB/m) = Antenna Factor(dB/m) + Cable Factor(dB) – Pre-Amplifier Factor(dB)
- The other emission levels were very low against the limit.
- Margin value = Emission Level – Limit value
- " * ": Fundamental frequency.
- " # ": The radiated frequency is out of the restricted band.

CHANNEL	TX Channel 149	DETECTOR FUNCTION	Peak (PK)
FREQUENCY RANGE	1GHz ~ 40GHz		Average (AV)

ANTENNA POLARITY & TEST DISTANCE: HORIZONTAL AT 3 M

NO.	FREQ. (MHz)	EMISSION LEVEL (dBuV/m)	LIMIT (dBuV/m)	MARGIN (dB)	ANTENNA HEIGHT (m)	TABLE ANGLE (Degree)	RAW VALUE (dBuV)	CORRECTION FACTOR (dB/m)
1	#5647.58	64.1 PK	68.2	-4.1	1.00 H	173	59.3	4.8
2	*5745.00	122.0 PK			1.00 H	173	117.0	5.0
3	*5745.00	112.6 AV			1.00 H	173	107.6	5.0
4	#5930.53	57.9 PK	68.2	-10.3	1.00 H	173	52.5	5.4
5	11490.00	52.9 PK	74.0	-21.1	1.32 H	250	38.8	14.1
6	11490.00	41.0 AV	54.0	-13.0	1.32 H	250	26.9	14.1
7	#17235.00	50.5 PK	74.0	-23.5	1.53 H	185	32.2	18.3
8	#17235.00	37.8 AV	54.0	-16.2	1.53 H	185	19.5	18.3

ANTENNA POLARITY & TEST DISTANCE: VERTICAL AT 3 M

NO.	FREQ. (MHz)	EMISSION LEVEL (dBuV/m)	LIMIT (dBuV/m)	MARGIN (dB)	ANTENNA HEIGHT (m)	TABLE ANGLE (Degree)	RAW VALUE (dBuV)	CORRECTION FACTOR (dB/m)
1	#5649.98	63.4 PK	68.2	-4.8	1.28 V	187	58.6	4.8
2	*5745.00	122.8 PK			1.28 V	187	117.8	5.0
3	*5745.00	113.0 AV			1.28 V	187	108.0	5.0
4	#5932.71	58.2 PK	68.2	-10.0	1.28 V	187	52.8	5.4
5	11490.00	61.2 PK	74.0	-12.8	1.20 V	257	47.1	14.1
6	11490.00	47.9 AV	54.0	-6.1	1.20 V	257	33.8	14.1
7	#17235.00	56.5 PK	74.0	-17.5	1.98 V	151	38.2	18.3
8	#17235.00	44.7 AV	54.0	-9.3	1.98 V	151	26.4	18.3

REMARKS:

1. Emission Level(dBuV/m) = Raw Value(dBuV) + Correction Factor(dB/m)
2. Correction Factor(dB/m) = Antenna Factor(dB/m) + Cable Factor(dB) – Pre-Amplifier Factor(dB)
3. The other emission levels were very low against the limit.
4. Margin value = Emission Level – Limit value
5. " * ": Fundamental frequency.
6. " # ": The radiated frequency is out of the restricted band.

CHANNEL	TX Channel 157	DETECTOR FUNCTION	Peak (PK)
FREQUENCY RANGE	1GHz ~ 40GHz		Average (AV)

ANTENNA POLARITY & TEST DISTANCE: HORIZONTAL AT 3 M

NO.	FREQ. (MHz)	EMISSION LEVEL (dBuV/m)	LIMIT (dBuV/m)	MARGIN (dB)	ANTENNA HEIGHT (m)	TABLE ANGLE (Degree)	RAW VALUE (dBuV)	CORRECTION FACTOR (dB/m)
1	#5607.63	60.1 PK	68.2	-8.1	1.00 H	170	55.4	4.7
2	*5785.00	121.7 PK			1.00 H	170	116.7	5.0
3	*5785.00	112.1 AV			1.00 H	170	107.1	5.0
4	#5958.01	58.1 PK	68.2	-10.1	1.00 H	170	52.6	5.5
5	11570.00	53.1 PK	74.0	-20.9	1.29 H	259	39.1	14.0
6	11570.00	41.1 AV	54.0	-12.9	1.29 H	259	27.1	14.0
7	#17355.00	50.7 PK	74.0	-23.3	1.49 H	172	31.8	18.9
8	#17355.00	38.2 AV	54.0	-15.8	1.49 H	172	19.3	18.9

ANTENNA POLARITY & TEST DISTANCE: VERTICAL AT 3 M

NO.	FREQ. (MHz)	EMISSION LEVEL (dBuV/m)	LIMIT (dBuV/m)	MARGIN (dB)	ANTENNA HEIGHT (m)	TABLE ANGLE (Degree)	RAW VALUE (dBuV)	CORRECTION FACTOR (dB/m)
1	#5630.27	59.7 PK	68.2	-8.5	1.28 V	190	54.9	4.8
2	*5785.00	122.3 PK			1.28 V	190	117.3	5.0
3	*5785.00	112.5 AV			1.28 V	190	107.5	5.0
4	#5952.94	58.0 PK	68.2	-10.2	1.28 V	190	52.6	5.4
5	11570.00	60.9 PK	74.0	-13.1	1.18 V	270	46.9	14.0
6	11570.00	47.8 AV	54.0	-6.2	1.18 V	270	33.8	14.0
7	#17355.00	56.8 PK	74.0	-17.2	2.01 V	149	37.9	18.9
8	#17355.00	44.9 AV	54.0	-9.1	2.01 V	149	26.0	18.9

REMARKS:

1. Emission Level(dBuV/m) = Raw Value(dBuV) + Correction Factor(dB/m)
2. Correction Factor(dB/m) = Antenna Factor(dB/m) + Cable Factor(dB) – Pre-Amplifier Factor(dB)
3. The other emission levels were very low against the limit.
4. Margin value = Emission Level – Limit value
5. " * ": Fundamental frequency.
6. " # ": The radiated frequency is out of the restricted band.

CHANNEL	TX Channel 165	DETECTOR FUNCTION	Peak (PK)
FREQUENCY RANGE	1GHz ~ 40GHz		Average (AV)

ANTENNA POLARITY & TEST DISTANCE: HORIZONTAL AT 3 M

NO.	FREQ. (MHz)	EMISSION LEVEL (dBuV/m)	LIMIT (dBuV/m)	MARGIN (dB)	ANTENNA HEIGHT (m)	TABLE ANGLE (Degree)	RAW VALUE (dBuV)	CORRECTION FACTOR (dB/m)
1	#5611.11	58.2 PK	68.2	-10.0	1.00 H	167	53.5	4.7
2	*5825.00	121.8 PK			1.00 H	167	116.6	5.2
3	*5825.00	112.3 AV			1.00 H	167	107.1	5.2
4	#5924.63	61.7 PK	68.5	-6.8	1.00 H	170	56.3	5.4
5	11650.00	53.3 PK	74.0	-20.7	1.27 H	258	39.2	14.1
6	11650.00	41.5 AV	54.0	-12.5	1.27 H	258	27.4	14.1
7	#17475.00	50.8 PK	74.0	-23.2	1.51 H	177	31.1	19.7
8	#17475.00	38.0 AV	54.0	-16.0	1.51 H	177	18.3	19.7

ANTENNA POLARITY & TEST DISTANCE: VERTICAL AT 3 M

NO.	FREQ. (MHz)	EMISSION LEVEL (dBuV/m)	LIMIT (dBuV/m)	MARGIN (dB)	ANTENNA HEIGHT (m)	TABLE ANGLE (Degree)	RAW VALUE (dBuV)	CORRECTION FACTOR (dB/m)
1	#5604.66	59.2 PK	68.2	-9.0	1.00 V	188	54.6	4.6
2	*5825.00	122.4 PK			1.00 V	188	117.2	5.2
3	*5825.00	112.6 AV			1.00 V	188	107.4	5.2
4	#5950.37	58.7 PK	68.2	-9.5	1.00 V	188	53.3	5.4
5	11650.00	61.2 PK	74.0	-12.8	1.21 V	270	47.1	14.1
6	11650.00	47.7 AV	54.0	-6.3	1.21 V	270	33.6	14.1
7	#17475.00	57.2 PK	74.0	-16.8	1.95 V	151	37.5	19.7
8	#17475.00	45.1 AV	54.0	-8.9	1.95 V	151	25.4	19.7

REMARKS:

1. Emission Level(dBuV/m) = Raw Value(dBuV) + Correction Factor(dB/m)
2. Correction Factor(dB/m) = Antenna Factor(dB/m) + Cable Factor(dB) – Pre-Amplifier Factor(dB)
3. The other emission levels were very low against the limit.
4. Margin value = Emission Level – Limit value
5. " * ": Fundamental frequency.
6. " # ": The radiated frequency is out of the restricted band.

802.11ac (VHT20)

CHANNEL	TX Channel 36	DETECTOR FUNCTION	Peak (PK)
FREQUENCY RANGE	1GHz ~ 40GHz		Average (AV)

ANTENNA POLARITY & TEST DISTANCE: HORIZONTAL AT 3 M

NO.	FREQ. (MHz)	EMISSION LEVEL (dBuV/m)	LIMIT (dBuV/m)	MARGIN (dB)	ANTENNA HEIGHT (m)	TABLE ANGLE (Degree)	RAW VALUE (dBuV)	CORRECTION FACTOR (dB/m)
1	5150.00	72.1 PK	74.0	-1.9	1.00 H	157	68.1	4.0
2	5150.00	53.4 AV	54.0	-0.6	1.00 H	157	49.4	4.0
3	*5180.00	114.9 PK			1.00 H	157	110.9	4.0
4	*5180.00	104.7 AV			1.00 H	157	100.7	4.0
5	#10360.00	47.7 PK	74.0	-26.3	1.21 H	221	34.1	13.6
6	#10360.00	34.6 AV	54.0	-19.4	1.21 H	221	21.0	13.6
7	15540.00	52.7 PK	74.0	-21.3	2.07 H	246	39.5	13.2
8	15540.00	39.9 AV	54.0	-14.1	2.07 H	246	26.7	13.2

ANTENNA POLARITY & TEST DISTANCE: VERTICAL AT 3 M

NO.	FREQ. (MHz)	EMISSION LEVEL (dBuV/m)	LIMIT (dBuV/m)	MARGIN (dB)	ANTENNA HEIGHT (m)	TABLE ANGLE (Degree)	RAW VALUE (dBuV)	CORRECTION FACTOR (dB/m)
1	5150.00	73.9 PK	74.0	-0.1	1.28 V	189	69.9	4.0
2	5150.00	53.9 AV	54.0	-0.1	1.28 V	189	49.9	4.0
3	*5180.00	115.8 PK			1.28 V	189	111.8	4.0
4	*5180.00	105.7 AV			1.28 V	189	101.7	4.0
5	#10360.00	52.7 PK	74.0	-21.3	1.24 V	0	39.1	13.6
6	#10360.00	39.8 AV	54.0	-14.2	1.24 V	0	26.2	13.6
7	15540.00	56.6 PK	74.0	-17.4	2.09 V	0	43.4	13.2
8	15540.00	43.5 AV	54.0	-10.5	2.09 V	0	30.3	13.2

REMARKS:

- Emission Level(dBuV/m) = Raw Value(dBuV) + Correction Factor(dB/m)
- Correction Factor(dB/m) = Antenna Factor(dB/m) + Cable Factor(dB) – Pre-Amplifier Factor(dB)
- The other emission levels were very low against the limit.
- Margin value = Emission Level – Limit value
- " * ": Fundamental frequency.
- " # ": The radiated frequency is out of the restricted band.

CHANNEL	TX Channel 40	DETECTOR FUNCTION	Peak (PK)
FREQUENCY RANGE	1GHz ~ 40GHz		Average (AV)

ANTENNA POLARITY & TEST DISTANCE: HORIZONTAL AT 3 M

NO.	FREQ. (MHz)	EMISSION LEVEL (dBuV/m)	LIMIT (dBuV/m)	MARGIN (dB)	ANTENNA HEIGHT (m)	TABLE ANGLE (Degree)	RAW VALUE (dBuV)	CORRECTION FACTOR (dB/m)
1	5150.00	70.2 PK	74.0	-3.8	1.00 H	156	66.2	4.0
2	5150.00	53.4 AV	54.0	-0.6	1.00 H	156	49.4	4.0
3	*5200.00	117.7 PK			1.00 H	156	113.7	4.0
4	*5200.00	107.0 AV			1.00 H	156	103.0	4.0
5	5350.00	54.5 PK	74.0	-19.5	1.00 H	156	50.1	4.4
6	5350.00	42.2 AV	54.0	-11.8	1.00 H	156	37.8	4.4
7	#10400.00	48.1 PK	74.0	-25.9	1.17 H	210	34.5	13.6
8	#10400.00	35.1 AV	54.0	-18.9	1.17 H	210	21.5	13.6
9	15600.00	53.1 PK	74.0	-20.9	2.12 H	238	39.7	13.4
10	15600.00	40.3 AV	54.0	-13.7	2.12 H	238	26.9	13.4

ANTENNA POLARITY & TEST DISTANCE: VERTICAL AT 3 M

NO.	FREQ. (MHz)	EMISSION LEVEL (dBuV/m)	LIMIT (dBuV/m)	MARGIN (dB)	ANTENNA HEIGHT (m)	TABLE ANGLE (Degree)	RAW VALUE (dBuV)	CORRECTION FACTOR (dB/m)
1	5150.00	70.9 PK	74.0	-3.1	1.28 V	189	66.9	4.0
2	5150.00	53.9 AV	54.0	-0.1	1.28 V	189	49.9	4.0
3	*5200.00	118.2 PK			1.28 V	189	114.2	4.0
4	*5200.00	108.5 AV			1.28 V	189	104.5	4.0
5	5350.00	55.4 PK	74.0	-18.6	1.28 V	189	51.0	4.4
6	5350.00	43.7 AV	54.0	-10.3	1.28 V	189	39.3	4.4
7	#10400.00	52.4 PK	74.0	-21.6	1.22 V	59	38.8	13.6
8	#10400.00	39.3 AV	54.0	-14.7	1.22 V	59	25.7	13.6
9	15600.00	56.7 PK	74.0	-17.3	2.09 V	179	43.3	13.4
10	15600.00	43.4 AV	54.0	-10.6	2.09 V	179	30.0	13.4

REMARKS:

- Emission Level(dBuV/m) = Raw Value(dBuV) + Correction Factor(dB/m)
- Correction Factor(dB/m) = Antenna Factor(dB/m) + Cable Factor(dB) – Pre-Amplifier Factor(dB)
- The other emission levels were very low against the limit.
- Margin value = Emission Level – Limit value
- " * ": Fundamental frequency.
- " # ": The radiated frequency is out of the restricted band.

CHANNEL	TX Channel 48	DETECTOR FUNCTION	Peak (PK)
FREQUENCY RANGE	1GHz ~ 40GHz		Average (AV)

ANTENNA POLARITY & TEST DISTANCE: HORIZONTAL AT 3 M

NO.	FREQ. (MHz)	EMISSION LEVEL (dBuV/m)	LIMIT (dBuV/m)	MARGIN (dB)	ANTENNA HEIGHT (m)	TABLE ANGLE (Degree)	RAW VALUE (dBuV)	CORRECTION FACTOR (dB/m)
1	5150.00	59.7 PK	74.0	-14.3	1.00 H	156	55.7	4.0
2	5150.00	47.9 AV	54.0	-6.1	1.00 H	156	43.9	4.0
3	*5240.00	118.2 PK			1.00 H	156	114.0	4.2
4	*5240.00	109.1 AV			1.00 H	156	104.9	4.2
5	5350.00	56.5 PK	74.0	-17.5	1.00 H	156	52.1	4.4
6	5350.00	44.5 AV	54.0	-9.5	1.00 H	156	40.1	4.4
7	#10480.00	51.5 PK	74.0	-22.5	1.01 H	199	37.8	13.7
8	#10480.00	39.5 AV	54.0	-14.5	1.01 H	199	25.8	13.7
9	15720.00	54.6 PK	74.0	-19.4	2.14 H	227	40.6	14.0
10	15720.00	43.6 AV	54.0	-10.4	2.14 H	227	29.6	14.0

ANTENNA POLARITY & TEST DISTANCE: VERTICAL AT 3 M

NO.	FREQ. (MHz)	EMISSION LEVEL (dBuV/m)	LIMIT (dBuV/m)	MARGIN (dB)	ANTENNA HEIGHT (m)	TABLE ANGLE (Degree)	RAW VALUE (dBuV)	CORRECTION FACTOR (dB/m)
1	5150.00	61.4 PK	74.0	-12.6	1.28 V	189	57.4	4.0
2	5150.00	49.0 AV	54.0	-5.0	1.28 V	189	45.0	4.0
3	*5240.00	120.3 PK			1.28 V	189	116.1	4.2
4	*5240.00	111.2 AV			1.28 V	189	107.0	4.2
5	5350.00	58.3 PK	74.0	-15.7	1.28 V	189	53.9	4.4
6	5350.00	46.0 AV	54.0	-8.0	1.28 V	189	41.6	4.4
7	#10480.00	55.3 PK	74.0	-18.7	1.16 V	57	41.6	13.7
8	#10480.00	43.1 AV	54.0	-10.9	1.16 V	57	29.4	13.7
9	15720.00	58.6 PK	74.0	-15.4	2.01 V	145	44.6	14.0
10	15720.00	46.9 AV	54.0	-7.1	2.01 V	145	32.9	14.0

REMARKS:

- Emission Level(dBuV/m) = Raw Value(dBuV) + Correction Factor(dB/m)
- Correction Factor(dB/m) = Antenna Factor(dB/m) + Cable Factor(dB) – Pre-Amplifier Factor(dB)
- The other emission levels were very low against the limit.
- Margin value = Emission Level – Limit value
- " * ": Fundamental frequency.
- " # ": The radiated frequency is out of the restricted band.

CHANNEL	TX Channel 149	DETECTOR FUNCTION	Peak (PK)
FREQUENCY RANGE	1GHz ~ 40GHz		Average (AV)

ANTENNA POLARITY & TEST DISTANCE: HORIZONTAL AT 3 M

NO.	FREQ. (MHz)	EMISSION LEVEL (dBuV/m)	LIMIT (dBuV/m)	MARGIN (dB)	ANTENNA HEIGHT (m)	TABLE ANGLE (Degree)	RAW VALUE (dBuV)	CORRECTION FACTOR (dB/m)
1	#5654.13	66.7 PK	71.3	-4.6	1.00 H	169	62.0	4.7
2	*5745.00	121.0 PK			1.00 H	169	116.0	5.0
3	*5745.00	111.8 AV			1.00 H	169	106.8	5.0
4	#5933.56	58.6 PK	68.2	-9.6	1.00 H	169	53.2	5.4
5	11490.00	53.2 PK	74.0	-20.8	1.31 H	245	39.1	14.1
6	11490.00	41.4 AV	54.0	-12.6	1.31 H	245	27.3	14.1
7	#17235.00	50.1 PK	74.0	-23.9	1.57 H	173	31.8	18.3
8	#17235.00	37.4 AV	54.0	-16.6	1.57 H	173	19.1	18.3

ANTENNA POLARITY & TEST DISTANCE: VERTICAL AT 3 M

NO.	FREQ. (MHz)	EMISSION LEVEL (dBuV/m)	LIMIT (dBuV/m)	MARGIN (dB)	ANTENNA HEIGHT (m)	TABLE ANGLE (Degree)	RAW VALUE (dBuV)	CORRECTION FACTOR (dB/m)
1	#5650.76	65.8 PK	68.8	-3.0	1.00 V	183	61.1	4.7
2	*5745.00	121.6 PK			1.00 V	183	116.6	5.0
3	*5745.00	112.1 AV			1.00 V	183	107.1	5.0
4	#5957.09	58.2 PK	68.2	-10.0	1.00 V	183	52.7	5.5
5	11490.00	61.2 PK	74.0	-12.8	1.25 V	262	47.1	14.1
6	11490.00	47.6 AV	54.0	-6.4	1.25 V	262	33.5	14.1
7	#17235.00	56.2 PK	74.0	-17.8	1.98 V	144	37.9	18.3
8	#17235.00	44.2 AV	54.0	-9.8	1.98 V	144	25.9	18.3

REMARKS:

1. Emission Level(dBuV/m) = Raw Value(dBuV) + Correction Factor(dB/m)
2. Correction Factor(dB/m) = Antenna Factor(dB/m) + Cable Factor(dB) – Pre-Amplifier Factor(dB)
3. The other emission levels were very low against the limit.
4. Margin value = Emission Level – Limit value
5. " * ": Fundamental frequency.
6. " # ": The radiated frequency is out of the restricted band.

CHANNEL	TX Channel 157	DETECTOR FUNCTION	Peak (PK)
FREQUENCY RANGE	1GHz ~ 40GHz		Average (AV)

ANTENNA POLARITY & TEST DISTANCE: HORIZONTAL AT 3 M

NO.	FREQ. (MHz)	EMISSION LEVEL (dBuV/m)	LIMIT (dBuV/m)	MARGIN (dB)	ANTENNA HEIGHT (m)	TABLE ANGLE (Degree)	RAW VALUE (dBuV)	CORRECTION FACTOR (dB/m)
1	#5632.12	59.4 PK	68.2	-8.8	1.00 H	171	54.6	4.8
2	*5785.00	120.7 PK			1.00 H	171	115.7	5.0
3	*5785.00	111.8 AV			1.00 H	171	106.8	5.0
4	#5960.77	58.2 PK	68.2	-10.0	1.00 H	171	52.7	5.5
5	11570.00	52.8 PK	74.0	-21.2	1.37 H	258	38.8	14.0
6	11570.00	40.9 AV	54.0	-13.1	1.37 H	258	26.9	14.0
7	#17355.00	50.4 PK	74.0	-23.6	1.50 H	197	31.5	18.9
8	#17355.00	37.6 AV	54.0	-16.4	1.50 H	197	18.7	18.9

ANTENNA POLARITY & TEST DISTANCE: VERTICAL AT 3 M

NO.	FREQ. (MHz)	EMISSION LEVEL (dBuV/m)	LIMIT (dBuV/m)	MARGIN (dB)	ANTENNA HEIGHT (m)	TABLE ANGLE (Degree)	RAW VALUE (dBuV)	CORRECTION FACTOR (dB/m)
1	#5611.44	59.6 PK	68.2	-8.6	1.00 V	183	54.9	4.7
2	*5785.00	121.5 PK			1.00 V	183	116.5	5.0
3	*5785.00	112.0 AV			1.00 V	183	107.0	5.0
4	#5979.51	58.6 PK	68.2	-9.6	1.00 V	183	53.1	5.5
5	11570.00	61.1 PK	74.0	-12.9	1.22 V	272	47.1	14.0
6	11570.00	47.4 AV	54.0	-6.6	1.22 V	272	33.4	14.0
7	#17355.00	55.9 PK	74.0	-18.1	2.02 V	151	37.0	18.9
8	#17355.00	43.8 AV	54.0	-10.2	2.02 V	151	24.9	18.9

REMARKS:

1. Emission Level(dBuV/m) = Raw Value(dBuV) + Correction Factor(dB/m)
2. Correction Factor(dB/m) = Antenna Factor(dB/m) + Cable Factor(dB) – Pre-Amplifier Factor(dB)
3. The other emission levels were very low against the limit.
4. Margin value = Emission Level – Limit value
5. " * ": Fundamental frequency.
6. " # ": The radiated frequency is out of the restricted band.

CHANNEL	TX Channel 165	DETECTOR FUNCTION	Peak (PK)
FREQUENCY RANGE	1GHz ~ 40GHz		Average (AV)

ANTENNA POLARITY & TEST DISTANCE: HORIZONTAL AT 3 M

NO.	FREQ. (MHz)	EMISSION LEVEL (dBuV/m)	LIMIT (dBuV/m)	MARGIN (dB)	ANTENNA HEIGHT (m)	TABLE ANGLE (Degree)	RAW VALUE (dBuV)	CORRECTION FACTOR (dB/m)
1	#5634.72	58.5 PK	68.2	-9.7	1.00 H	172	53.7	4.8
2	*5825.00	121.1 PK			1.00 H	172	115.9	5.2
3	*5825.00	111.6 AV			1.00 H	172	106.4	5.2
4	#5927.53	60.6 PK	68.2	-7.6	1.00 H	172	55.2	5.4
5	11650.00	53.6 PK	74.0	-20.4	1.30 H	261	39.5	14.1
6	11650.00	41.4 AV	54.0	-12.6	1.30 H	261	27.3	14.1
7	#17475.00	50.4 PK	74.0	-23.6	1.54 H	184	30.7	19.7
8	#17475.00	37.4 AV	54.0	-16.6	1.54 H	184	17.7	19.7

ANTENNA POLARITY & TEST DISTANCE: VERTICAL AT 3 M

NO.	FREQ. (MHz)	EMISSION LEVEL (dBuV/m)	LIMIT (dBuV/m)	MARGIN (dB)	ANTENNA HEIGHT (m)	TABLE ANGLE (Degree)	RAW VALUE (dBuV)	CORRECTION FACTOR (dB/m)
1	#5584.71	58.8 PK	68.2	-9.4	1.00 V	184	54.2	4.6
2	*5825.00	121.7 PK			1.00 V	184	116.5	5.2
3	*5825.00	112.1 AV			1.00 V	184	106.9	5.2
4	#5929.39	59.4 PK	68.2	-8.8	1.00 V	184	54.0	5.4
5	11650.00	60.9 PK	74.0	-13.1	1.24 V	259	46.8	14.1
6	11650.00	47.4 AV	54.0	-6.6	1.24 V	259	33.3	14.1
7	#17475.00	56.0 PK	74.0	-18.0	1.97 V	158	36.3	19.7
8	#17475.00	43.8 AV	54.0	-10.2	1.97 V	158	24.1	19.7

REMARKS:

1. Emission Level(dBuV/m) = Raw Value(dBuV) + Correction Factor(dB/m)
2. Correction Factor(dB/m) = Antenna Factor(dB/m) + Cable Factor(dB) – Pre-Amplifier Factor(dB)
3. The other emission levels were very low against the limit.
4. Margin value = Emission Level – Limit value
5. " * ": Fundamental frequency.
6. " # ": The radiated frequency is out of the restricted band.

802.11ac (VHT40)

CHANNEL	TX Channel 38	DETECTOR FUNCTION	Peak (PK)
FREQUENCY RANGE	1GHz ~ 40GHz		Average (AV)

ANTENNA POLARITY & TEST DISTANCE: HORIZONTAL AT 3 M

NO.	FREQ. (MHz)	EMISSION LEVEL (dBuV/m)	LIMIT (dBuV/m)	MARGIN (dB)	ANTENNA HEIGHT (m)	TABLE ANGLE (Degree)	RAW VALUE (dBuV)	CORRECTION FACTOR (dB/m)
1	5150.00	66.8 PK	74.0	-7.2	1.00 H	154	62.8	4.0
2	5150.00	52.5 AV	54.0	-1.5	1.00 H	154	48.5	4.0
3	*5190.00	110.0 PK			1.00 H	154	106.0	4.0
4	*5190.00	99.7 AV			1.00 H	154	95.7	4.0
5	5350.00	54.0 PK	74.0	-20.0	1.00 H	154	49.6	4.4
6	5350.00	42.5 AV	54.0	-11.5	1.00 H	154	38.1	4.4
7	#10380.00	44.8 PK	74.0	-29.2	1.18 H	208	31.2	13.6
8	#10380.00	31.6 AV	54.0	-22.4	1.18 H	208	18.0	13.6
9	15570.00	50.7 PK	74.0	-23.3	2.07 H	256	37.4	13.3
10	15570.00	37.7 AV	54.0	-16.3	2.07 H	256	24.4	13.3

ANTENNA POLARITY & TEST DISTANCE: VERTICAL AT 3 M

NO.	FREQ. (MHz)	EMISSION LEVEL (dBuV/m)	LIMIT (dBuV/m)	MARGIN (dB)	ANTENNA HEIGHT (m)	TABLE ANGLE (Degree)	RAW VALUE (dBuV)	CORRECTION FACTOR (dB/m)
1	5150.00	68.1 PK	74.0	-5.9	1.28 V	189	64.1	4.0
2	5150.00	53.9 AV	54.0	-0.1	1.28 V	189	49.9	4.0
3	*5190.00	110.8 PK			1.28 V	189	106.8	4.0
4	*5190.00	100.8 AV			1.28 V	189	96.8	4.0
5	5350.00	55.2 PK	74.0	-18.8	1.28 V	189	50.8	4.4
6	5350.00	44.0 AV	54.0	-10.0	1.28 V	189	39.6	4.4
7	#10380.00	49.6 PK	74.0	-24.4	1.32 V	79	36.0	13.6
8	#10380.00	36.5 AV	54.0	-17.5	1.32 V	79	22.9	13.6
9	15570.00	54.2 PK	74.0	-19.8	2.03 V	180	40.9	13.3
10	15570.00	41.1 AV	54.0	-12.9	2.03 V	180	27.8	13.3

REMARKS:

- Emission Level(dBuV/m) = Raw Value(dBuV) + Correction Factor(dB/m)
- Correction Factor(dB/m) = Antenna Factor(dB/m) + Cable Factor(dB) – Pre-Amplifier Factor(dB)
- The other emission levels were very low against the limit.
- Margin value = Emission Level – Limit value
- " * ": Fundamental frequency.
- " # ": The radiated frequency is out of the restricted band.

CHANNEL	TX Channel 46	DETECTOR FUNCTION	Peak (PK)
FREQUENCY RANGE	1GHz ~ 40GHz		Average (AV)

ANTENNA POLARITY & TEST DISTANCE: HORIZONTAL AT 3 M

NO.	FREQ. (MHz)	EMISSION LEVEL (dBuV/m)	LIMIT (dBuV/m)	MARGIN (dB)	ANTENNA HEIGHT (m)	TABLE ANGLE (Degree)	RAW VALUE (dBuV)	CORRECTION FACTOR (dB/m)
1	5150.00	67.3 PK	74.0	-6.7	1.00 H	154	63.3	4.0
2	5150.00	52.9 AV	54.0	-1.1	1.00 H	154	48.9	4.0
3	*5230.00	114.0 PK			1.00 H	154	109.8	4.2
4	*5230.00	103.5 AV			1.00 H	154	99.3	4.2
5	5350.00	58.8 PK	74.0	-15.2	1.00 H	154	54.4	4.4
6	5350.00	45.5 AV	54.0	-8.5	1.00 H	154	41.1	4.4
7	#10460.00	45.2 PK	74.0	-28.8	1.18 H	199	31.5	13.7
8	#10460.00	32.1 AV	54.0	-21.9	1.18 H	199	18.4	13.7
9	15690.00	50.5 PK	74.0	-23.5	2.09 H	253	36.5	14.0
10	15690.00	37.7 AV	54.0	-16.3	2.09 H	253	23.7	14.0

ANTENNA POLARITY & TEST DISTANCE: VERTICAL AT 3 M

NO.	FREQ. (MHz)	EMISSION LEVEL (dBuV/m)	LIMIT (dBuV/m)	MARGIN (dB)	ANTENNA HEIGHT (m)	TABLE ANGLE (Degree)	RAW VALUE (dBuV)	CORRECTION FACTOR (dB/m)
1	5150.00	68.6 PK	74.0	-5.4	1.28 V	189	64.6	4.0
2	5150.00	53.9 AV	54.0	-0.1	1.28 V	189	49.9	4.0
3	*5230.00	115.1 PK			1.28 V	189	110.9	4.2
4	*5230.00	105.0 AV			1.28 V	189	100.8	4.2
5	5350.00	62.5 PK	74.0	-11.5	1.28 V	189	58.1	4.4
6	5350.00	48.0 AV	54.0	-6.0	1.28 V	189	43.6	4.4
7	#10460.00	49.6 PK	74.0	-24.4	1.27 V	63	35.9	13.7
8	#10460.00	36.4 AV	54.0	-17.6	1.27 V	63	22.7	13.7
9	15690.00	54.0 PK	74.0	-20.0	2.03 V	180	40.0	14.0
10	15690.00	40.8 AV	54.0	-13.2	2.03 V	180	26.8	14.0

REMARKS:

- Emission Level(dBuV/m) = Raw Value(dBuV) + Correction Factor(dB/m)
- Correction Factor(dB/m) = Antenna Factor(dB/m) + Cable Factor(dB) – Pre-Amplifier Factor(dB)
- The other emission levels were very low against the limit.
- Margin value = Emission Level – Limit value
- " * ": Fundamental frequency.
- " # ": The radiated frequency is out of the restricted band.

CHANNEL	TX Channel 151	DETECTOR FUNCTION	Peak (PK)
FREQUENCY RANGE	1GHz ~ 40GHz		Average (AV)

ANTENNA POLARITY & TEST DISTANCE: HORIZONTAL AT 3 M

NO.	FREQ. (MHz)	EMISSION LEVEL (dBuV/m)	LIMIT (dBuV/m)	MARGIN (dB)	ANTENNA HEIGHT (m)	TABLE ANGLE (Degree)	RAW VALUE (dBuV)	CORRECTION FACTOR (dB/m)
1	#5649.13	67.2 PK	68.2	-1.0	1.00 H	172	62.4	4.8
2	*5755.00	115.8 PK			1.00 H	172	110.8	5.0
3	*5755.00	106.1 AV			1.00 H	172	101.1	5.0
4	#5928.59	58.1 PK	68.2	-10.1	1.00 H	172	52.7	5.4
5	11510.00	51.1 PK	74.0	-22.9	1.22 H	265	37.1	14.0
6	11510.00	38.8 AV	54.0	-15.2	1.22 H	265	24.8	14.0
7	#17265.00	47.4 PK	74.0	-26.6	1.48 H	169	28.9	18.5
8	#17265.00	34.2 AV	54.0	-19.8	1.48 H	169	15.7	18.5

ANTENNA POLARITY & TEST DISTANCE: VERTICAL AT 3 M

NO.	FREQ. (MHz)	EMISSION LEVEL (dBuV/m)	LIMIT (dBuV/m)	MARGIN (dB)	ANTENNA HEIGHT (m)	TABLE ANGLE (Degree)	RAW VALUE (dBuV)	CORRECTION FACTOR (dB/m)
1	#5651.92	69.2 PK	69.6	-0.4	1.00 V	176	64.5	4.7
2	*5755.00	116.7 PK			1.00 V	176	111.7	5.0
3	*5755.00	106.9 AV			1.00 V	176	101.9	5.0
4	#5937.39	58.7 PK	68.2	-9.5	1.00 V	176	53.3	5.4
5	11510.00	57.5 PK	74.0	-16.5	1.23 V	283	43.5	14.0
6	11510.00	44.5 AV	54.0	-9.5	1.23 V	283	30.5	14.0
7	#17265.00	53.2 PK	74.0	-20.8	1.88 V	158	34.7	18.5
8	#17265.00	40.6 AV	54.0	-13.4	1.88 V	158	22.1	18.5

REMARKS:

1. Emission Level(dBuV/m) = Raw Value(dBuV) + Correction Factor(dB/m)
2. Correction Factor(dB/m) = Antenna Factor(dB/m) + Cable Factor(dB) – Pre-Amplifier Factor(dB)
3. The other emission levels were very low against the limit.
4. Margin value = Emission Level – Limit value
5. " * ": Fundamental frequency.
6. " # ": The radiated frequency is out of the restricted band.

CHANNEL	TX Channel 159	DETECTOR FUNCTION	Peak (PK)
FREQUENCY RANGE	1GHz ~ 40GHz		Average (AV)

ANTENNA POLARITY & TEST DISTANCE: HORIZONTAL AT 3 M

NO.	FREQ. (MHz)	EMISSION LEVEL (dBuV/m)	LIMIT (dBuV/m)	MARGIN (dB)	ANTENNA HEIGHT (m)	TABLE ANGLE (Degree)	RAW VALUE (dBuV)	CORRECTION FACTOR (dB/m)
1	#5646.01	66.2 PK	68.2	-2.0	1.00 H	171	61.4	4.8
2	*5795.00	118.5 PK			1.00 H	171	113.4	5.1
3	*5795.00	109.1 AV			1.00 H	171	104.0	5.1
4	#5930.70	67.3 PK	68.2	-0.9	1.00 H	171	61.9	5.4
5	11590.00	51.1 PK	74.0	-22.9	1.25 H	268	37.1	14.0
6	11590.00	38.9 AV	54.0	-15.1	1.25 H	268	24.9	14.0
7	#17385.00	47.2 PK	74.0	-26.8	1.50 H	173	28.1	19.1
8	#17385.00	34.3 AV	54.0	-19.7	1.50 H	173	15.2	19.1

ANTENNA POLARITY & TEST DISTANCE: VERTICAL AT 3 M

NO.	FREQ. (MHz)	EMISSION LEVEL (dBuV/m)	LIMIT (dBuV/m)	MARGIN (dB)	ANTENNA HEIGHT (m)	TABLE ANGLE (Degree)	RAW VALUE (dBuV)	CORRECTION FACTOR (dB/m)
1	#5643.54	67.7 PK	68.2	-0.5	1.00 V	176	62.9	4.8
2	*5795.00	119.3 PK			1.00 V	176	114.2	5.1
3	*5795.00	109.7 AV			1.00 V	176	104.6	5.1
4	#5930.96	66.2 PK	68.2	-2.0	1.00 V	176	60.8	5.4
5	11590.00	57.7 PK	74.0	-16.3	1.25 V	271	43.7	14.0
6	11590.00	44.4 AV	54.0	-9.6	1.25 V	271	30.4	14.0
7	#17385.00	53.0 PK	74.0	-21.0	1.94 V	157	33.9	19.1
8	#17385.00	40.5 AV	54.0	-13.5	1.94 V	157	21.4	19.1

REMARKS:

1. Emission Level(dBuV/m) = Raw Value(dBuV) + Correction Factor(dB/m)
2. Correction Factor(dB/m) = Antenna Factor(dB/m) + Cable Factor(dB) – Pre-Amplifier Factor(dB)
3. The other emission levels were very low against the limit.
4. Margin value = Emission Level – Limit value
5. " * ": Fundamental frequency.
6. " # ": The radiated frequency is out of the restricted band.

802.11ac (VHT80)

CHANNEL	TX Channel 42	DETECTOR FUNCTION	Peak (PK)
FREQUENCY RANGE	1GHz ~ 40GHz		Average (AV)

ANTENNA POLARITY & TEST DISTANCE: HORIZONTAL AT 3 M

NO.	FREQ. (MHz)	EMISSION LEVEL (dBuV/m)	LIMIT (dBuV/m)	MARGIN (dB)	ANTENNA HEIGHT (m)	TABLE ANGLE (Degree)	RAW VALUE (dBuV)	CORRECTION FACTOR (dB/m)
1	5150.00	65.1 PK	74.0	-8.9	1.00 H	167	61.1	4.0
2	5150.00	51.2 AV	54.0	-2.8	1.00 H	167	47.2	4.0
3	*5210.00	103.8 PK			1.00 H	167	99.7	4.1
4	*5210.00	94.3 AV			1.00 H	167	90.2	4.1
5	5350.00	53.7 PK	74.0	-20.3	1.00 H	167	49.3	4.4
6	5350.00	42.7 AV	54.0	-11.3	1.00 H	167	38.3	4.4
7	#10420.00	44.9 PK	74.0	-29.1	1.17 H	199	31.3	13.6
8	#10420.00	31.9 AV	54.0	-22.1	1.17 H	199	18.3	13.6
9	15630.00	51.0 PK	74.0	-23.0	2.07 H	247	37.4	13.6
10	15630.00	37.7 AV	54.0	-16.3	2.07 H	247	24.1	13.6

ANTENNA POLARITY & TEST DISTANCE: VERTICAL AT 3 M

NO.	FREQ. (MHz)	EMISSION LEVEL (dBuV/m)	LIMIT (dBuV/m)	MARGIN (dB)	ANTENNA HEIGHT (m)	TABLE ANGLE (Degree)	RAW VALUE (dBuV)	CORRECTION FACTOR (dB/m)
1	5150.00	66.5 PK	74.0	-7.5	1.28 V	189	62.5	4.0
2	5150.00	53.9 AV	54.0	-0.1	1.28 V	189	49.9	4.0
3	*5210.00	105.1 PK			1.28 V	189	101.0	4.1
4	*5210.00	96.0 AV			1.28 V	189	91.9	4.1
5	5350.00	55.5 PK	74.0	-18.5	1.28 V	189	51.1	4.4
6	5350.00	44.5 AV	54.0	-9.5	1.28 V	189	40.1	4.4
7	#10420.00	49.3 PK	74.0	-24.7	1.37 V	84	35.7	13.6
8	#10420.00	36.3 AV	54.0	-17.7	1.37 V	84	22.7	13.6
9	15630.00	54.7 PK	74.0	-19.3	1.98 V	196	41.1	13.6
10	15630.00	41.5 AV	54.0	-12.5	1.98 V	196	27.9	13.6

REMARKS:

- Emission Level(dBuV/m) = Raw Value(dBuV) + Correction Factor(dB/m)
- Correction Factor(dB/m) = Antenna Factor(dB/m) + Cable Factor(dB) – Pre-Amplifier Factor(dB)
- The other emission levels were very low against the limit.
- Margin value = Emission Level – Limit value
- " * ": Fundamental frequency.
- " # ": The radiated frequency is out of the restricted band.

CHANNEL	TX Channel 155	DETECTOR FUNCTION	Peak (PK)
FREQUENCY RANGE	1GHz ~ 40GHz		Average (AV)

ANTENNA POLARITY & TEST DISTANCE: HORIZONTAL AT 3 M

NO.	FREQ. (MHz)	EMISSION LEVEL (dBuV/m)	LIMIT (dBuV/m)	MARGIN (dB)	ANTENNA HEIGHT (m)	TABLE ANGLE (Degree)	RAW VALUE (dBuV)	CORRECTION FACTOR (dB/m)
1	#5649.32	66.3 PK	68.2	-1.9	1.00 H	174	61.5	4.8
2	*5775.00	108.8 PK			1.00 H	174	103.8	5.0
3	*5775.00	100.6 AV			1.00 H	174	95.6	5.0
4	#5938.57	59.3 PK	68.2	-8.9	1.00 H	174	53.9	5.4
5	11550.00	48.3 PK	74.0	-25.7	1.24 H	268	34.3	14.0
6	11550.00	36.1 AV	54.0	-17.9	1.24 H	268	22.1	14.0
7	#17325.00	47.1 PK	74.0	-26.9	1.50 H	175	28.5	18.6
8	#17325.00	34.0 AV	54.0	-20.0	1.50 H	175	15.4	18.6

ANTENNA POLARITY & TEST DISTANCE: VERTICAL AT 3 M

NO.	FREQ. (MHz)	EMISSION LEVEL (dBuV/m)	LIMIT (dBuV/m)	MARGIN (dB)	ANTENNA HEIGHT (m)	TABLE ANGLE (Degree)	RAW VALUE (dBuV)	CORRECTION FACTOR (dB/m)
1	#5646.75	68.1 PK	68.2	-0.1	1.18 V	187	63.3	4.8
2	*5775.00	109.8 PK			1.18 V	187	104.8	5.0
3	*5775.00	101.9 AV			1.18 V	187	96.9	5.0
4	#5929.47	58.7 PK	68.2	-9.5	1.18 V	187	53.3	5.4
5	11550.00	53.4 PK	74.0	-20.6	1.18 V	279	39.4	14.0
6	11550.00	40.5 AV	54.0	-13.5	1.18 V	279	26.5	14.0
7	#17325.00	47.6 PK	74.0	-26.4	1.91 V	155	29.0	18.6
8	#17325.00	36.1 AV	54.0	-17.9	1.91 V	155	17.5	18.6

REMARKS:

1. Emission Level(dBuV/m) = Raw Value(dBuV) + Correction Factor(dB/m)
2. Correction Factor(dB/m) = Antenna Factor(dB/m) + Cable Factor(dB) – Pre-Amplifier Factor(dB)
3. The other emission levels were very low against the limit.
4. Margin value = Emission Level – Limit value
5. " * ": Fundamental frequency.
6. " # ": The radiated frequency is out of the restricted band.

Below 1GHz Data:

802.11ac (VHT20)

CHANNEL	TX Channel 149	DETECTOR FUNCTION	Quasi-Peak (QP)
FREQUENCY RANGE	9kHz ~ 1GHz		

ANTENNA POLARITY & TEST DISTANCE: HORIZONTAL AT 3 M

NO.	FREQ. (MHz)	EMISSION LEVEL (dBuV/m)	LIMIT (dBuV/m)	MARGIN (dB)	ANTENNA HEIGHT (m)	TABLE ANGLE (Degree)	RAW VALUE (dBuV)	CORRECTION FACTOR (dB/m)
1	39.68	29.8 QP	40.0	-10.2	1.94 H	243	38.4	-8.6
2	61.05	29.6 QP	40.0	-10.4	1.46 H	225	38.4	-8.8
3	99.84	34.4 QP	43.5	-9.1	1.00 H	225	47.2	-12.8
4	125.05	34.4 QP	43.5	-9.1	1.50 H	236	44.0	-9.6
5	400.54	29.7 QP	46.0	-16.3	1.00 H	223	34.9	-5.2
6	625.58	29.3 QP	46.0	-16.7	1.50 H	206	29.4	-0.1

ANTENNA POLARITY & TEST DISTANCE: VERTICAL AT 3 M

NO.	FREQ. (MHz)	EMISSION LEVEL (dBuV/m)	LIMIT (dBuV/m)	MARGIN (dB)	ANTENNA HEIGHT (m)	TABLE ANGLE (Degree)	RAW VALUE (dBuV)	CORRECTION FACTOR (dB/m)
1	38.24	37.2 QP	40.0	-2.8	1.00 V	243	45.5	-8.3
2	98.87	33.3 QP	43.5	-10.2	1.18 V	231	46.2	-12.9
3	137.67	32.4 QP	43.5	-11.1	1.50 V	228	40.7	-8.3
4	399.57	30.2 QP	46.0	-15.8	1.43 V	205	35.4	-5.2
5	749.74	28.4 QP	46.0	-17.6	1.51 V	87	26.2	2.2
6	935.98	31.2 QP	46.0	-14.8	1.00 V	116	26.7	4.5

REMARKS:

1. Emission Level(dBuV/m) = Raw Value(dBuV) + Correction Factor(dB/m)
2. Correction Factor(dB/m) = Antenna Factor(dB/m) + Cable Factor(dB) – Pre-Amplifier Factor(dB)
3. The other emission levels were very low against the limit.
4. Margin value = Emission Level – Limit value

4.2 Conducted Emission Measurement

4.2.1 Limits of Conducted Emission Measurement

Frequency (MHz)	Conducted Limit (dBuV)	
	Quasi-peak	Average
0.15 - 0.5	66 - 56	56 - 46
0.50 - 5.0	56	46
5.0 - 30.0	60	50

Note: 1. The lower limit shall apply at the transition frequencies.

2. The limit decreases in line with the logarithm of the frequency in the range of 0.15 to 0.50MHz.

4.2.2 Test Instruments

DESCRIPTION & MANUFACTURER	MODEL NO.	SERIAL NO.	CALIBRATED DATE	CALIBRATED UNTIL
Test Receiver R&S	ESCS 30	847124/029	Oct. 24, 2016	Oct. 23, 2017
Line-Impedance Stabilization Network (for EUT) R&S	ESH3-Z5	848773/004	Oct. 26, 2016	Oct. 25, 2017
Line-Impedance Stabilization Network (for Peripheral) R&S	ENV216	100072	June 03, 2017	June 02, 2018
50 ohms Terminator	N/A	EMC-02	Sep. 29, 2016	Sep. 28, 2017
RF Cable	5D-FB	COCCAB-001	Sep. 30, 2016	Sep. 29, 2017
10 dB PAD Mini-Circuits	HAT-10+	CONATT-004	June 18, 2017	June 17, 2018
Software BVADT	BVADT_Cond_V7.3.7.4	NA	NA	NA

Note:

1. The calibration interval of the above test instruments are 12 months and the calibrations are traceable to NML/ROC and NIST/USA.
2. The test was performed in Shielded Room No. 1.
3. Tested Date: July 31, 2017.

4.2.3 Test Procedure

- The EUT was placed 0.4 meters from the conducting wall of the shielded room with EUT being connected to the power mains through a line impedance stabilization network (LISN). Other support units were connected to the power mains through another LISN. The two LISNs provide 50 ohm/ 50uH of coupling impedance for the measuring instrument.
- Both lines of the power mains connected to the EUT were checked for maximum conducted interference.
- The frequency range from 150kHz to 30MHz was searched. Emission levels under (Limit - 20dB) was not recorded.

NOTE: All modes of operation were investigated and the worst-case emissions are reported.

4.2.4 Deviation from Test Standard

No deviation.

4.2.5 Test Setup

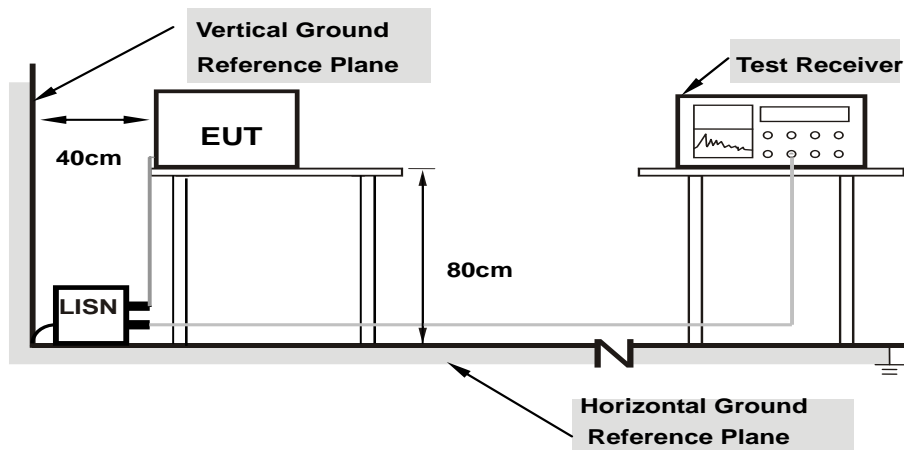

Note: 1.Support units were connected to second LISN.

For the actual test configuration, please refer to the attached file (Test Setup Photo).

4.2.6 EUT Operating Condition

Same as 4.1.6.

4.2.7 Test Results

Phase	Line (L)	Detector Function	Quasi-Peak (QP) / Average (AV)
-------	----------	-------------------	--------------------------------

No	Freq. [MHz]	Corr. Factor	Reading Value [dB (uV)]		Emission Level [dB (uV)]		Limit [dB (uV)]		Margin (dB)	
		(dB)	Q.P.	AV.	Q.P.	AV.	Q.P.	AV.	Q.P.	AV.
	1	0.15000	10.07	38.28	26.77	48.35	36.84	66.00	56.00	-17.65
2	0.21250	10.06	27.90	17.07	37.96	27.13	63.11	53.11	-25.15	-25.98
3	0.45469	10.11	24.84	21.15	34.95	31.26	56.79	46.79	-21.84	-15.53
4	1.96094	10.14	10.37	5.41	20.51	15.55	56.00	46.00	-35.49	-30.45
5	8.39063	10.53	19.75	15.18	30.28	25.71	60.00	50.00	-29.72	-24.29
6	30.00000	11.38	18.51	14.29	29.89	25.67	60.00	50.00	-30.11	-24.33

REMARKS:

1. Q.P. and AV. are abbreviations of quasi-peak and average individually.
2. The emission levels of other frequencies were very low against the limit.
3. Margin value = Emission level - Limit value
4. Correction factor = Insertion loss + Cable loss
5. Emission Level = Correction Factor + Reading Value.

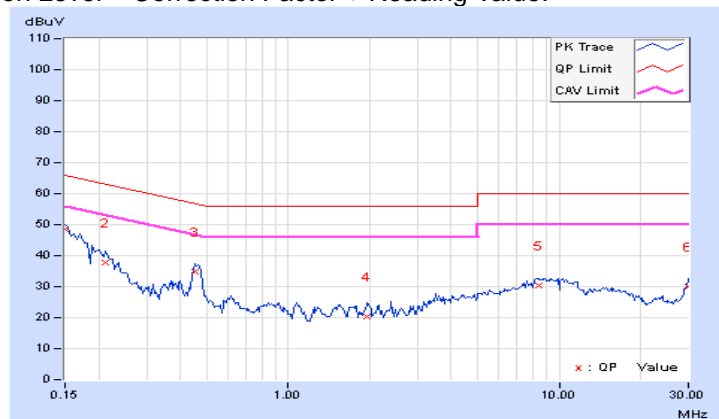

Phase	Neutral (N)	Detector Function	Quasi-Peak (QP) / Average (AV)
-------	-------------	-------------------	--------------------------------

No	Freq. [MHz]	Corr.	Reading Value		Emission Level		Limit		Margin	
		Factor	[dB (uV)]		[dB (uV)]		[dB (uV)]		(dB)	
	(dB)	Q.P.	AV.	Q.P.	AV.	Q.P.	AV.	Q.P.	AV.	
1	0.15000	10.06	39.18	28.25	49.24	38.31	66.00	56.00	-16.76	-17.69
2	0.22031	10.04	27.62	16.95	37.66	26.99	62.81	52.81	-25.15	-25.82
3	0.46641	10.10	29.39	24.82	39.49	34.92	56.58	46.58	-17.09	-11.66
4	0.96641	10.11	10.50	7.15	20.61	17.26	56.00	46.00	-35.39	-28.74
5	10.65234	10.58	18.52	14.42	29.10	25.00	60.00	50.00	-30.90	-25.00
6	29.85156	10.96	17.19	13.17	28.15	24.13	60.00	50.00	-31.85	-25.87

REMARKS:

1. Q.P. and AV. are abbreviations of quasi-peak and average individually.
2. The emission levels of other frequencies were very low against the limit.
3. Margin value = Emission level - Limit value
4. Correction factor = Insertion loss + Cable loss
5. Emission Level = Correction Factor + Reading Value.

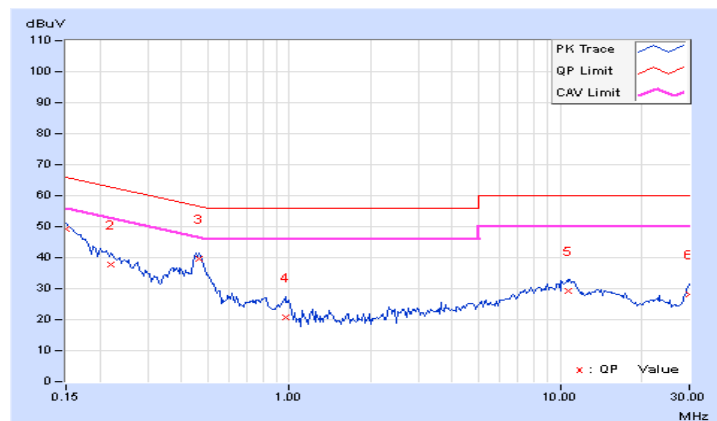

4.3 Transmit Power Measurement

4.3.1 Limits of Transmit Power Measurement

Operation Band	EUT Category		Limit
U-NII-1		Outdoor Access Point	1 Watt (30 dBm) (Max. e.i.r.p \leq 125mW(21 dBm) at any elevation angle above 30 degrees as measured from the horizon)
		Fixed point-to-point Access Point	1 Watt (30 dBm)
	√	Indoor Access Point	1 Watt (30 dBm)
	√	Mobile and Portable client device	250mW (24 dBm)
U-NII-2A			250mW (24 dBm) or 11 dBm+10 log B*
U-NII-2C			250mW (24 dBm) or 11 dBm+10 log B*
U-NII-3		√	1 Watt (30 dBm)

*B is the 26 dB emission bandwidth in megahertz

Note: This device can support different category application which switched by access point mode and client mode by software.

Per KDB 662911 Method of conducted output power measurement on IEEE 802.11 devices,

Array Gain = 0 dB (i.e., no array gain) for $N_{ANT} \leq 4$;

Array Gain = 0 dB (i.e., no array gain) for channel widths ≥ 40 MHz for any N_{ANT} ;

Array Gain = $5 \log(N_{ANT}/N_{SS})$ dB or 3 dB, whichever is less for 20-MHz channel widths with $N_{ANT} \geq 5$.

For power measurements on all other devices: Array Gain = $10 \log(N_{ANT}/N_{SS})$ dB.

4.3.2 Test Setup

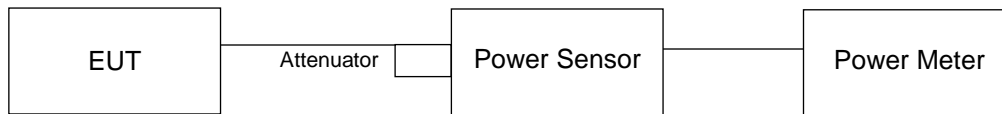

4.3.3 Test Instruments

Refer to section 4.1.2 to get information of above instrument.

4.3.4 Test Procedure

Method PM is used to perform output power measurement, trigger and gating function of wide band power meter is enabled to measure max output power of TX on burst. Duty factor is not added to measured value.

4.3.5 Deviation from Test Standard

No deviation.

4.3.6 EUT Operating Condition

The software provided by client to enable the EUT under transmission condition continuously at lowest, middle and highest channel frequencies individually.

4.3.7 Test Result

For U-NII-1:

Master

802.11a

Chan.	Chan. Freq. (MHz)	Average Power (dBm)				Total Power (mW)	Total Power (dBm)	Limit (dBm)	Pass / Fail
		Chain 0	Chain 1	Chain 2	Chain 3				
36	5180	18.04	19.53	18.07	18.62	290.322	24.63	29.83	Pass
40	5200	18.28	19.37	18.22	18.51	291.127	24.64	29.83	Pass
48	5240	18.05	19.05	18.57	18.66	289.575	24.62	29.83	Pass

Note: Max.gain = 6.17dBi > 6dBi , so the power limit shall be reduced to $30-(6.17-6) = 29.83\text{dBm}$.

802.11ac (VHT20)

Chan.	Chan. Freq. (MHz)	Average Power (dBm)				Total Power (mW)	Total Power (dBm)	Limit (dBm)	Pass / Fail
		Chain 0	Chain 1	Chain 2	Chain 3				
36	5180	18.21	19.57	17.96	18.96	298.017	24.74	29.83	Pass
40	5200	18.27	19.32	18.17	18.69	292.226	24.66	29.83	Pass
48	5240	18.55	19.33	18.37	18.30	293.633	24.68	29.83	Pass

Note: Max.gain = 6.17dBi > 6dBi , so the power limit shall be reduced to $30-(6.17-6) = 29.83\text{dBm}$.

802.11ac (VHT40)

Chan.	Chan. Freq. (MHz)	Average Power (dBm)				Total Power (mW)	Total Power (dBm)	Limit (dBm)	Pass / Fail
		Chain 0	Chain 1	Chain 2	Chain 3				
38	5190	16.43	17.37	15.86	17.26	190.289	22.79	29.83	Pass
46	5230	20.84	20.57	19.87	21.17	463.333	26.66	29.83	Pass

Note: Max.gain = 6.17dBi > 6dBi , so the power limit shall be reduced to $30-(6.17-6) = 29.83\text{dBm}$.

802.11ac (VHT80)

Chan.	Chan. Freq. (MHz)	Average Power (dBm)				Total Power (mW)	Total Power (dBm)	Limit (dBm)	Pass / Fail
		Chain 0	Chain 1	Chain 2	Chain 3				
45	5210	14.47	13.97	13.52	14.76	105.35	20.23	29.83	Pass

Note: Max.gain = 6.17dBi > 6dBi , so the power limit shall be reduced to $30-(6.17-6) = 29.83\text{dBm}$.

Client
802.11a

Chan.	Chan. Freq. (MHz)	Average Power (dBm)				Total Power (mW)	Total Power (dBm)	Limit (dBm)	Pass / Fail
		Chain 0	Chain 1	Chain 2	Chain 3				
36	5180	12.01	13.47	12.01	12.57	72.075	18.58	23.83	Pass
40	5200	12.17	13.31	12.17	12.49	72.135	18.58	23.83	Pass
48	5240	12.99	13.00	12.46	12.58	75.593	18.78	23.83	Pass

Note: Max.gain = 6.17dBi > 6dBi , so the power limit shall be reduced to $24-(6.17-6) = 23.83\text{dBm}$.

802.11ac (VHT20)

Chan.	Chan. Freq. (MHz)	Average Power (dBm)				Total Power (mW)	Total Power (dBm)	Limit (dBm)	Pass / Fail
		Chain 0	Chain 1	Chain 2	Chain 3				
36	5180	12.11	13.52	11.94	12.91	73.92	18.69	23.83	Pass
40	5200	12.17	13.27	12.20	12.65	72.718	18.62	23.83	Pass
48	5240	12.57	13.34	12.42	12.37	74.365	18.71	23.83	Pass

Note: Max.gain = 6.17dBi > 6dBi , so the power limit shall be reduced to $24-(6.17-6) = 23.83\text{dBm}$.

802.11ac (VHT40)

Chan.	Chan. Freq. (MHz)	Average Power (dBm)				Total Power (mW)	Total Power (dBm)	Limit (dBm)	Pass / Fail
		Chain 0	Chain 1	Chain 2	Chain 3				
38	5190	15.93	16.81	15.31	16.73	168.208	22.26	23.83	Pass
46	5230	15.83	15.52	14.81	16.16	145.501	21.63	23.83	Pass

Note: Max.gain = 6.17dBi > 6dBi , so the power limit shall be reduced to $24-(6.17-6) = 23.83\text{dBm}$.

802.11ac (VHT80)

Chan.	Chan. Freq. (MHz)	Average Power (dBm)				Total Power (mW)	Total Power (dBm)	Limit (dBm)	Pass / Fail
		Chain 0	Chain 1	Chain 2	Chain 3				
45	5210	14.47	13.97	13.52	14.76	105.35	20.23	23.83	Pass

Note: Max.gain = 6.17dBi > 6dBi , so the power limit shall be reduced to $24-(6.17-6) = 23.83\text{dBm}$.

For U-NII-3:

Chan.	Chan. Freq. (MHz)	Average Power (dBm)				Total Power (mW)	Total Power (dBm)	Limit (dBm)	Pass / Fail
		Chain 0	Chain 1	Chain 2	Chain 3				
149	5745	22.75	23.53	22.89	22.23	775.434	28.90	29.83	Pass
157	5785	22.41	23.15	22.23	22.21	714.169	28.54	29.83	Pass
165	5825	22.31	22.76	22.10	22.13	684.501	28.35	29.83	Pass

Note: Max.gain = 6.17dBi > 6dBi , so the power limit shall be reduced to $30-(6.17-6) = 29.83\text{dBm}$.

802.11ac (VHT20)

Chan.	Chan. Freq. (MHz)	Average Power (dBm)				Total Power (mW)	Total Power (dBm)	Limit (dBm)	Pass / Fail
		Chain 0	Chain 1	Chain 2	Chain 3				
149	5745	22.91	23.61	23.01	22.26	793.302	28.99	29.83	Pass
157	5785	22.28	23.11	22.18	21.79	689.892	28.39	29.83	Pass
165	5825	22.06	22.75	21.71	21.86	650.773	28.13	29.83	Pass

Note: Max.gain = 6.17dBi > 6dBi , so the power limit shall be reduced to $30-(6.17-6) = 29.83\text{dBm}$.

802.11ac (VHT40)

Chan.	Chan. Freq. (MHz)	Average Power (dBm)				Total Power (mW)	Total Power (dBm)	Limit (dBm)	Pass / Fail
		Chain 0	Chain 1	Chain 2	Chain 3				
151	5755	22.72	22.23	20.74	22.36	644.941	28.10	29.83	Pass
159	5795	22.59	23.21	22.42	22.18	730.741	28.64	29.83	Pass

Note: Max.gain = 6.17dBi > 6dBi , so the power limit shall be reduced to $30-(6.17-6) = 29.83\text{dBm}$.

802.11ac (VHT80)

Chan.	Chan. Freq. (MHz)	Average Power (dBm)				Total Power (mW)	Total Power (dBm)	Limit (dBm)	Pass / Fail
		Chain 0	Chain 1	Chain 2	Chain 3				
55	5775	19.55	19.44	18.08	19.21	325.696	25.13	29.83	Pass

Note: Max.gain = 6.17dBi > 6dBi , so the power limit shall be reduced to $30-(6.17-6) = 29.83\text{dBm}$.

4.4 Occupied Bandwidth Measurement

4.4.1 Test Setup

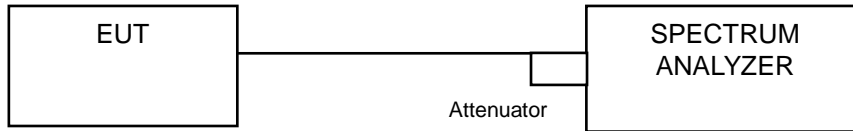

4.4.2 Test Instruments

Refer to section 4.1.2 to get information of above instrument.

4.4.3 Test Procedure

The transmitter output was connected to the spectrum analyzer through an attenuator. The bandwidth of the fundamental frequency was measured by spectrum analyzer with resolution bandwidth in the range of 1% to 5% of the anticipated emission bandwidth, and a video bandwidth at least 3x the resolution bandwidth and set the detector to SAMPLE. The width of a frequency band such that, below the lower and above the upper frequency limits, the mean powers emitted are each equal to a specified percentage 0.5 %of the total mean power of a given emission.

4.4.4 Test Results

For U-NII-1:

Master

802.11a

Channel	Channel Frequency (MHz)	Occupied Bandwidth (MHz)			
		CHAIN 0	CHAIN 1	CHAIN 2	CHAIN 3
36	5180	16.80	16.92	16.68	16.92
40	5200	16.68	16.80	16.80	16.80
48	5240	16.56	16.92	16.68	16.92

802.11ac (VHT20)

Channel	Channel Frequency (MHz)	Occupied Bandwidth (MHz)			
		CHAIN 0	CHAIN 1	CHAIN 2	CHAIN 3
36	5180	17.88	17.76	17.76	17.88
40	5200	17.88	17.88	17.76	17.88
48	5240	17.76	17.88	17.76	17.76

802.11ac (VHT40)

Channel	Channel Frequency (MHz)	Occupied Bandwidth (MHz)			
		CHAIN 0	CHAIN 1	CHAIN 2	CHAIN 3
38	5190	36.24	36.48	36.48	36.48
46	5230	37.44	36.96	36.96	37.92

802.11ac (VHT80)

Channel	Channel Frequency (MHz)	Occupied Bandwidth (MHz)			
		CHAIN 0	CHAIN 1	CHAIN 2	CHAIN 3
42	5210	75.36	75.36	75.36	75.36

Spectrum Plot of Worst Value

802.11a_Chain1 / CH36

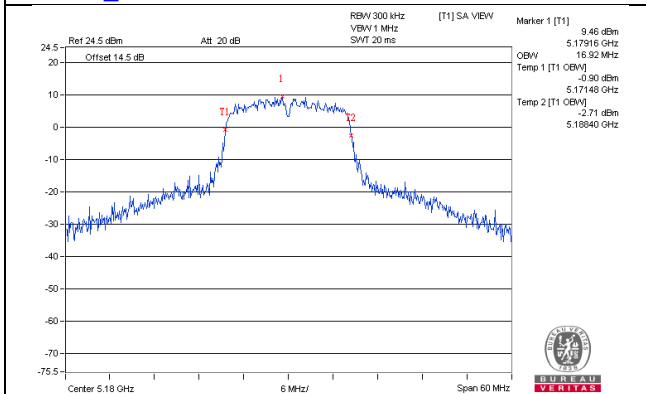

802.11ac (VHT20)_Chain0 / CH36

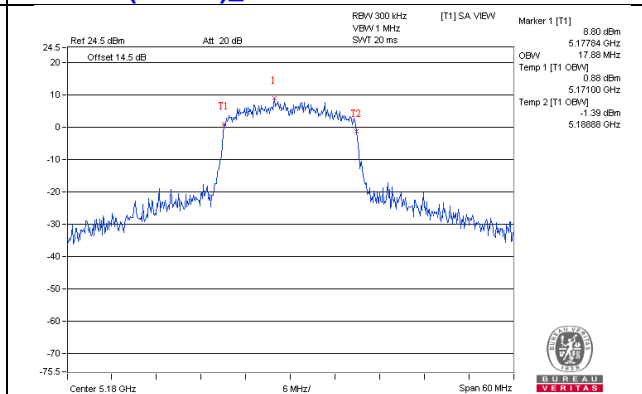

802.11ac (VHT40)_Chain3 / CH46

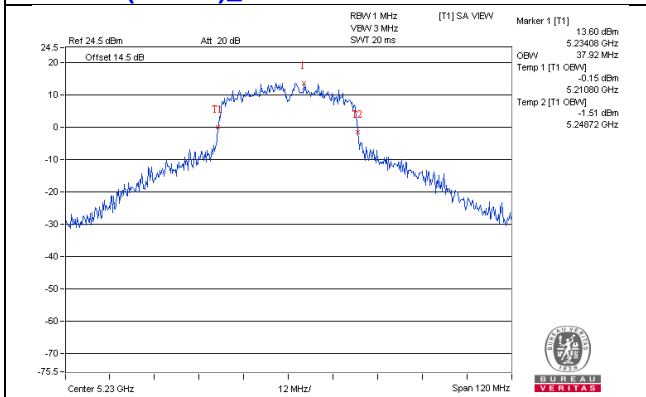

802.11ac (VHT80)_Chain0 / CH42

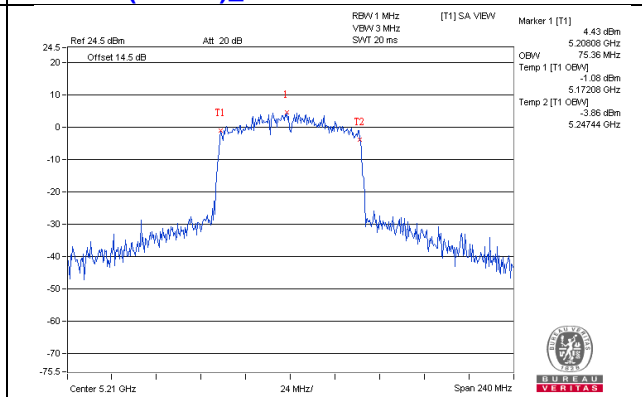

Client
802.11a

Channel	Channel Frequency (MHz)	Occupied Bandwidth (MHz)			
		CHAIN 0	CHAIN 1	CHAIN 2	CHAIN 3
36	5180	16.56	16.56	16.56	16.56
40	5200	16.56	16.56	16.68	16.56
48	5240	16.44	16.44	16.56	16.44

802.11ac (VHT20)

Channel	Channel Frequency (MHz)	Occupied Bandwidth (MHz)			
		CHAIN 0	CHAIN 1	CHAIN 2	CHAIN 3
36	5180	17.64	17.64	17.64	17.64
40	5200	17.64	17.64	17.64	17.64
48	5240	17.64	17.64	17.64	17.76

802.11ac (VHT40)

Channel	Channel Frequency (MHz)	Occupied Bandwidth (MHz)			
		CHAIN 0	CHAIN 1	CHAIN 2	CHAIN 3
38	5190	36.24	36.24	36.24	36.24
46	5230	36.24	36.24	36.48	36.24

802.11ac (VHT80)

Channel	Channel Frequency (MHz)	Occupied Bandwidth (MHz)			
		CHAIN 0	CHAIN 1	CHAIN 2	CHAIN 3
42	5210	75.36	75.36	75.36	75.36

Spectrum Plot of Worst Value

802.11a_Chain2 / CH40

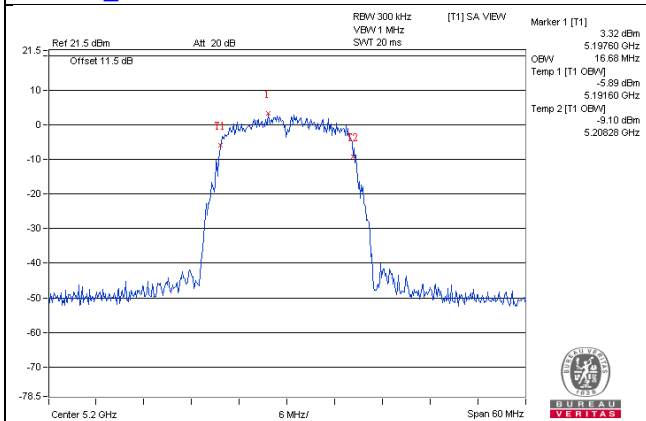

802.11ac (VHT20)_Chain3 / CH48

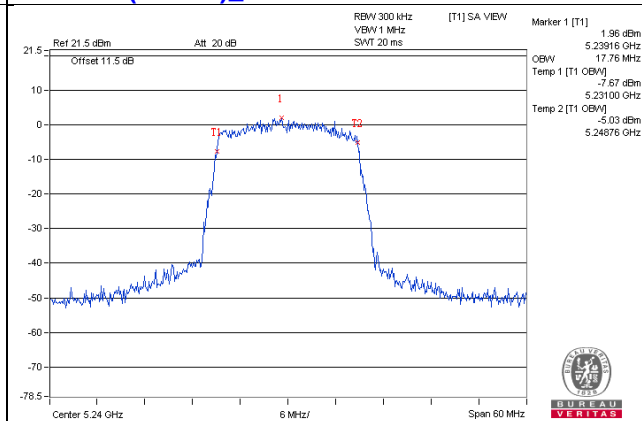

802.11ac (VHT40)_Chain2 / CH46

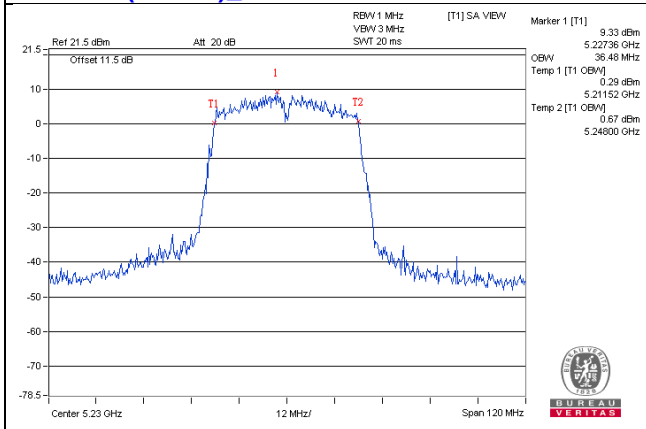

802.11ac (VHT80)_Chain3 / CH42

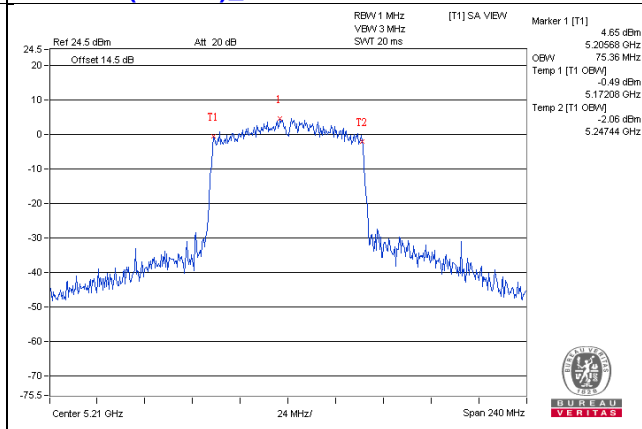

**For U-NII-3:
802.11a**

Channel	Channel Frequency (MHz)	Occupied Bandwidth (MHz)			
		CHAIN 0	CHAIN 1	CHAIN 2	CHAIN 3
149	5745	27.24	27.00	25.68	26.04
157	5785	24.60	26.64	25.08	24.48
165	5825	24.36	27.12	25.68	26.04

802.11ac (VHT20)

Channel	Channel Frequency (MHz)	Occupied Bandwidth (MHz)			
		CHAIN 0	CHAIN 1	CHAIN 2	CHAIN 3
149	5745	28.44	29.28	27.96	28.32
157	5785	25.32	27.60	26.04	26.28
165	5825	26.52	28.56	26.40	26.04

802.11ac (VHT40)

Channel	Channel Frequency (MHz)	Occupied Bandwidth (MHz)			
		CHAIN 0	CHAIN 1	CHAIN 2	CHAIN 3
151	5755	53.76	55.20	40.32	54.96
159	5795	45.60	52.08	48.72	47.76

802.11ac (VHT80)

Channel	Channel Frequency (MHz)	Occupied Bandwidth (MHz)			
		CHAIN 0	CHAIN 1	CHAIN 2	CHAIN 3
155	5775	77.28	75.84	75.84	77.28

Spectrum Plot of Worst Value

802.11a_Chain0 / CH149

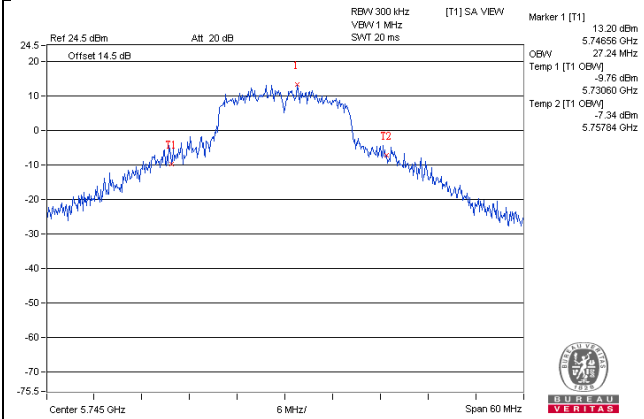

802.11ac (VHT20)_Chain1 / CH149

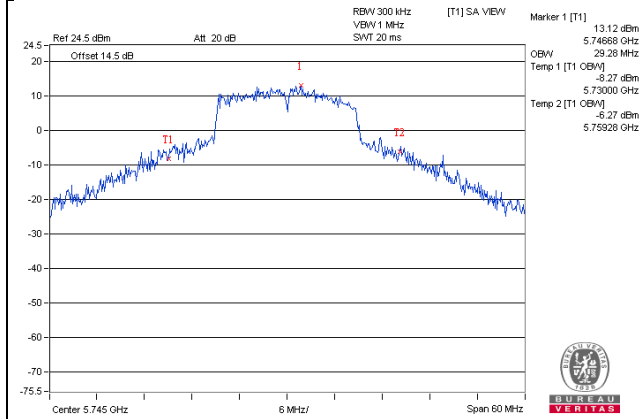

802.11ac (VHT40)_Chain1 / CH151

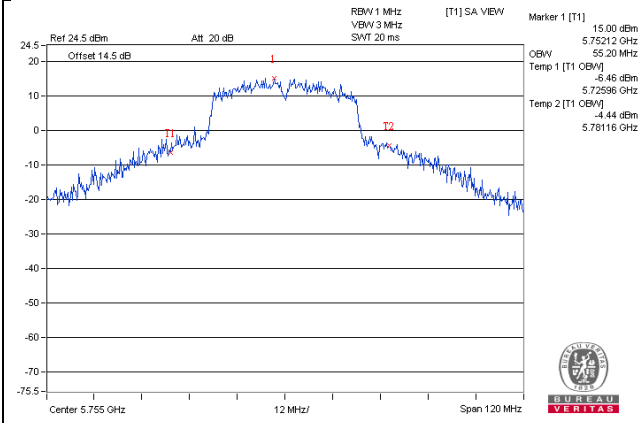

802.11ac (VHT80)_Chain0 / CH155

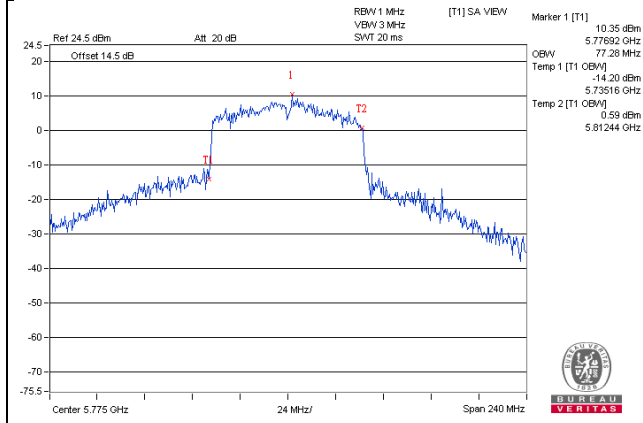

Spectrum Plot for near by DFS band (DFS is required, if 99% OCP straddle into U-NII-2A band)

802.11a_Chain0 / CH48

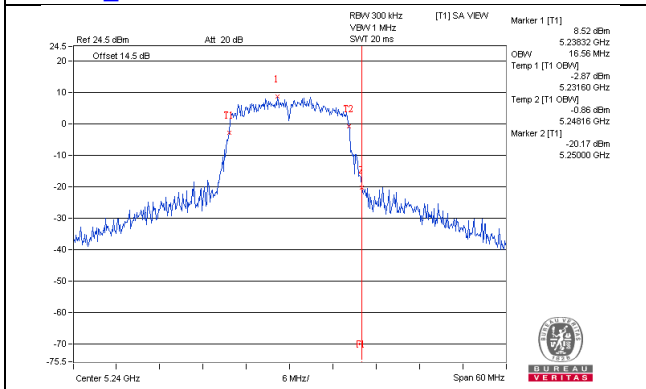

802.11a_Chain1 / CH48

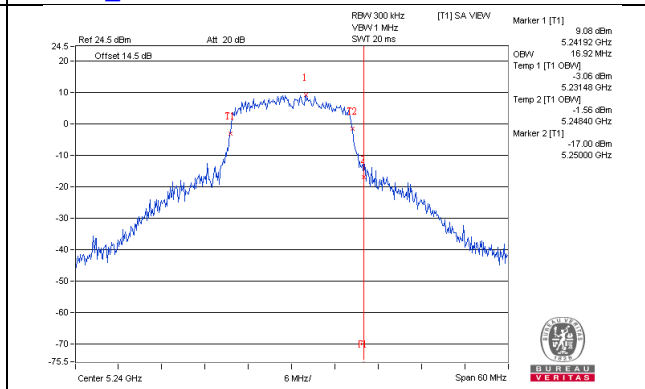

802.11a_Chain2 / CH48

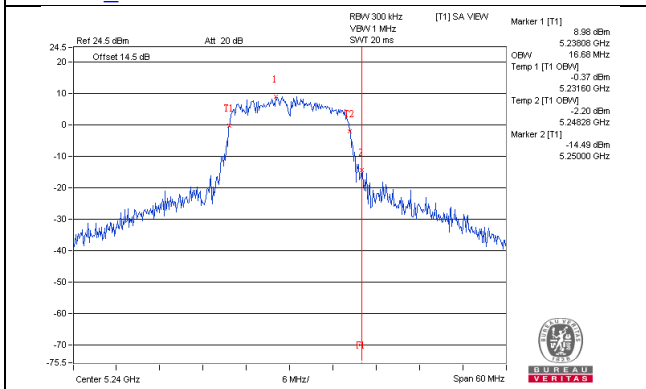

802.11a_Chain3 / CH48

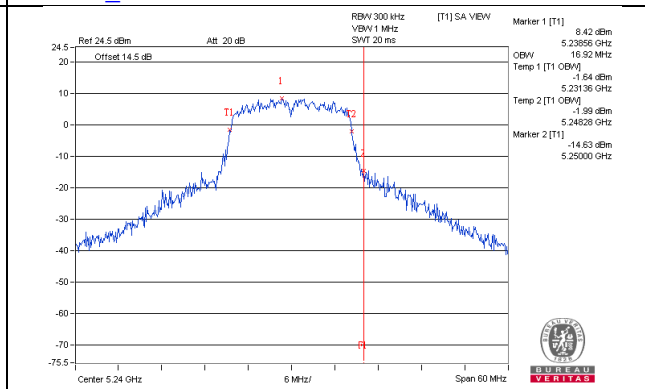

802.11ac(VHT20)_Chain0 / CH48

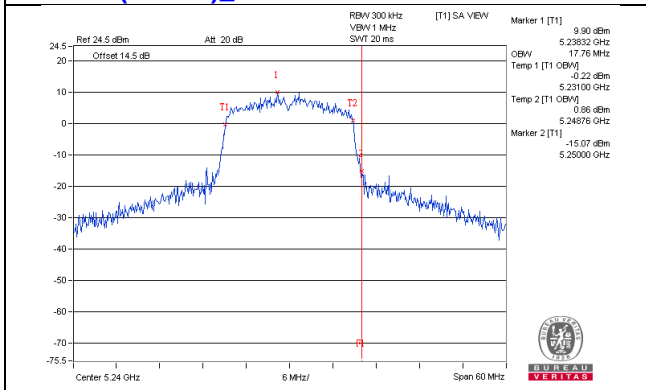

802.11ac(VHT20)_Chain1 / CH48

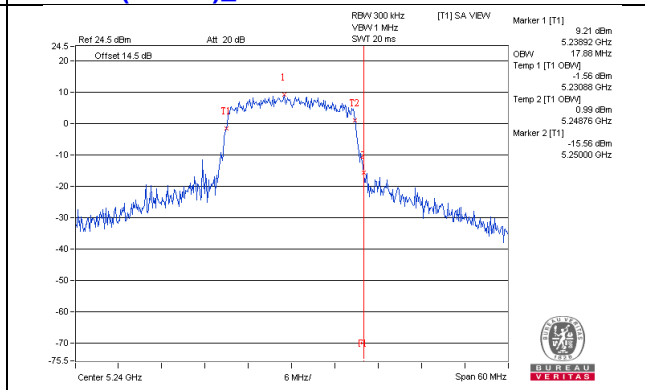

802.11ac(VHT20)_Chain2 / CH48

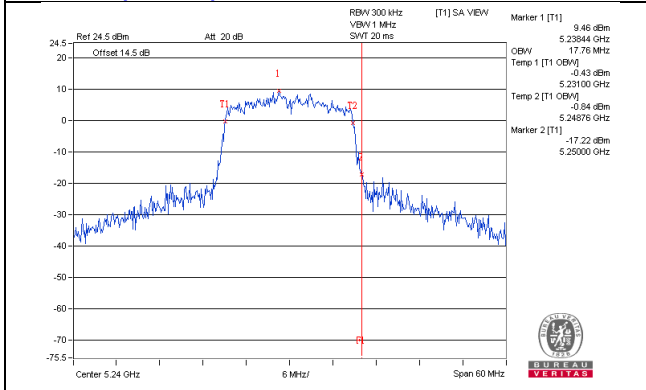

802.11ac(VHT20)_Chain3 / CH48

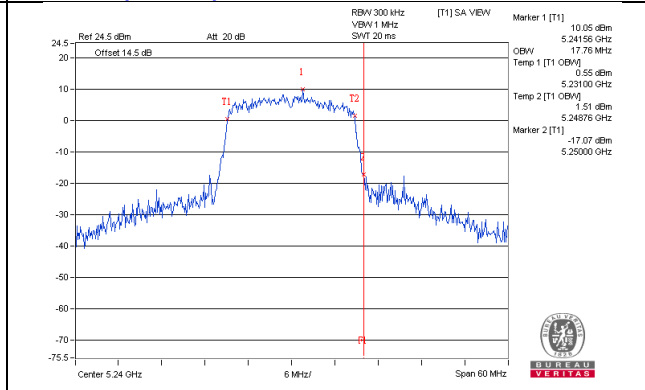

Spectrum Plot for near by DFS band (DFS is required, if 99% OCP straddle into U-NII-2A band)

802.11ac(VHT40)_Chain0 / CH46

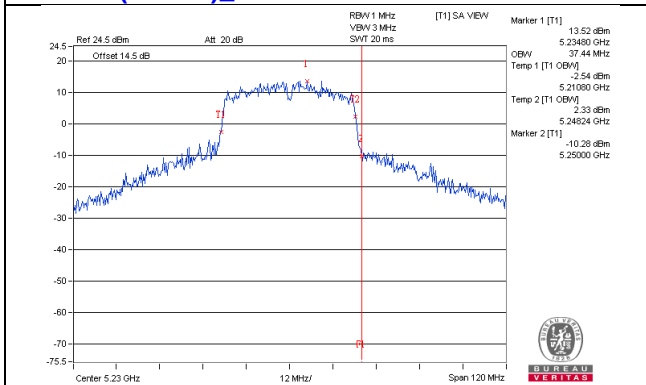

802.11ac(VHT40)_Chain1 / CH46

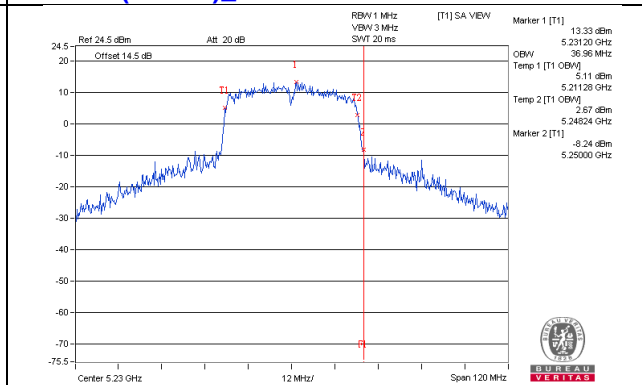

802.11ac(VHT40)_Chain2 / CH46

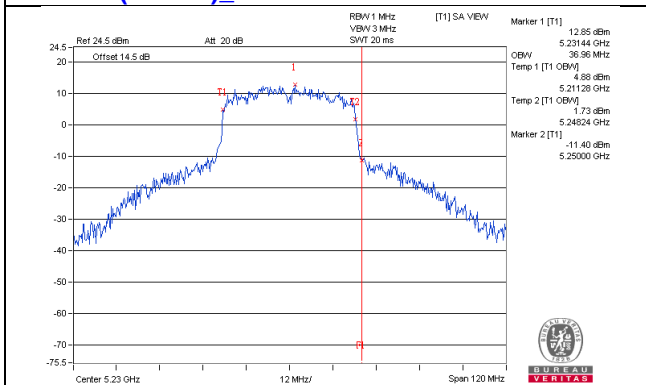

802.11ac(VHT40)_Chain3 / CH46

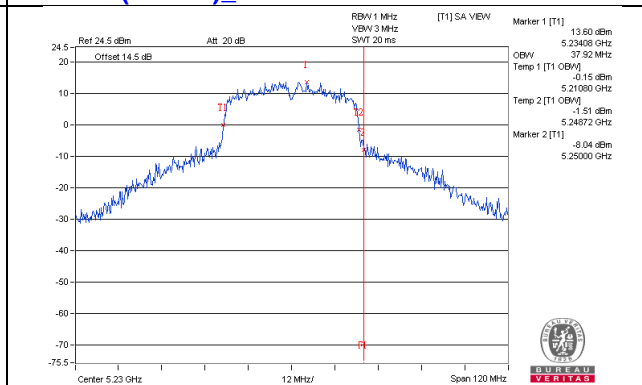

802.11ac(VHT80)_Chain0 / CH42

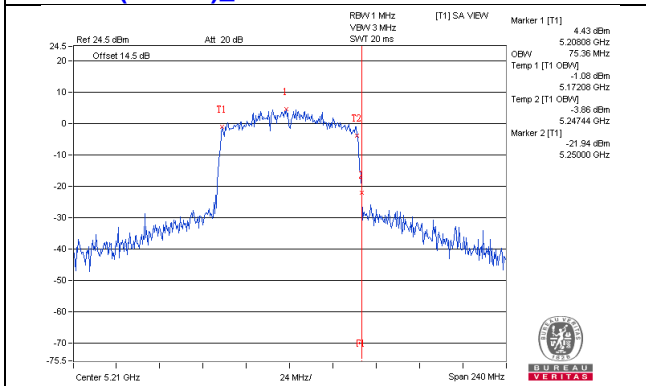

802.11ac(VHT80)_Chain1 / CH42

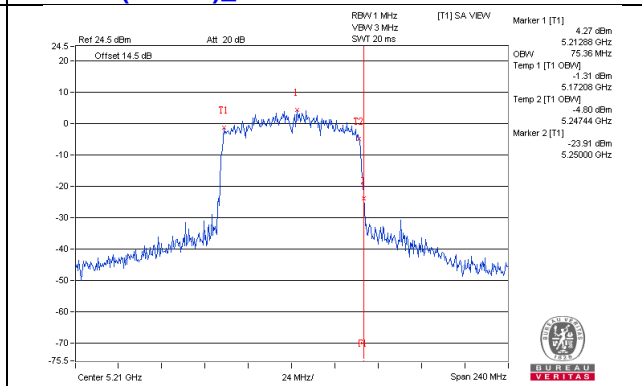

802.11ac(VHT80)_Chain2 / CH42

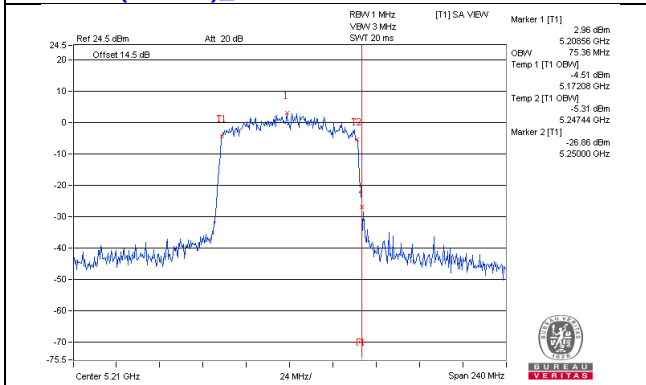

802.11ac(VHT80)_Chain3 / CH42

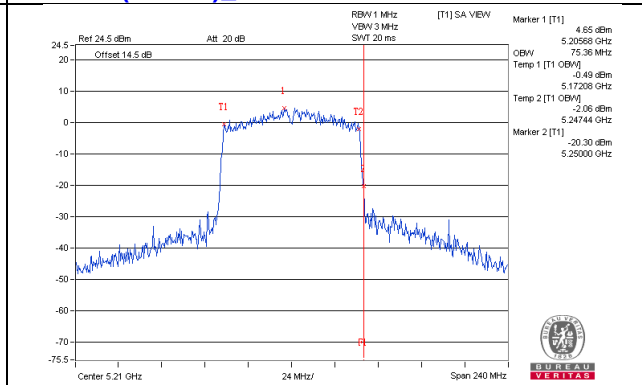

Spectrum Plot for near by DFS band (DFS is required, if 99% OCP straddle into U-NII-2C band)

802.11a_Chain0 / CH149

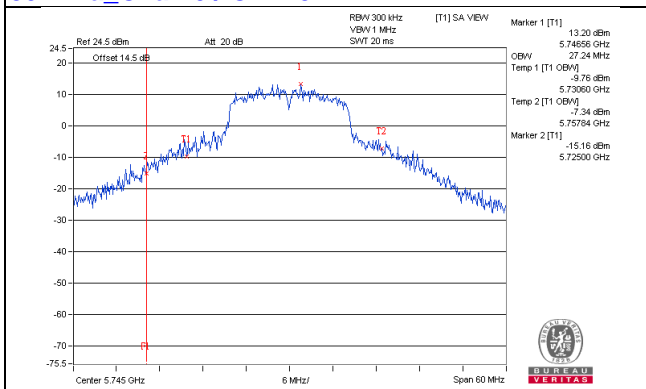

802.11a_Chain1 / CH149

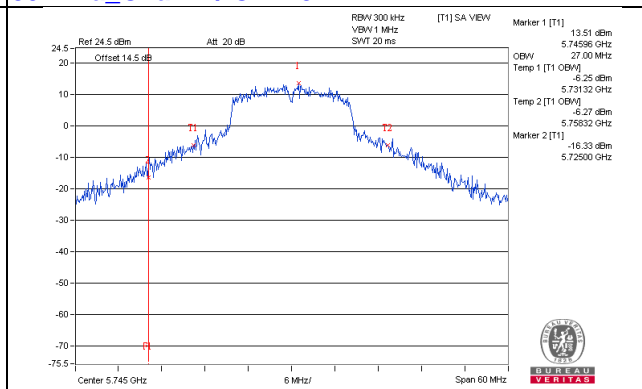

802.11a_Chain2 / CH149

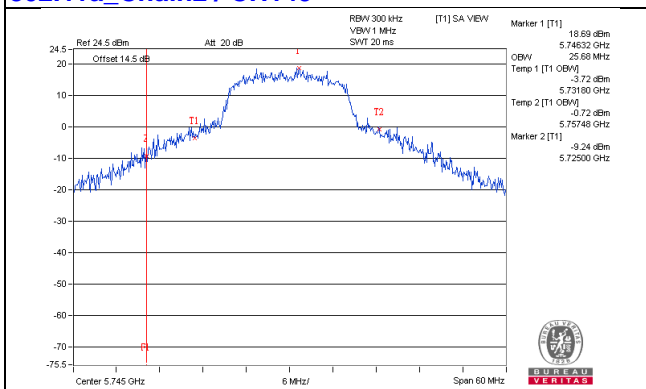

802.11a_Chain3 / CH149

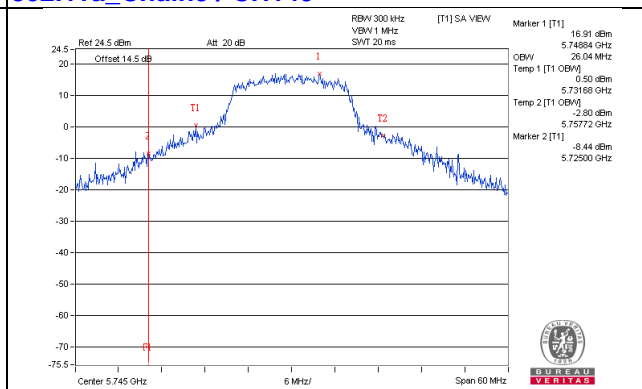

802.11ac(VHT20)_Chain0 / CH149

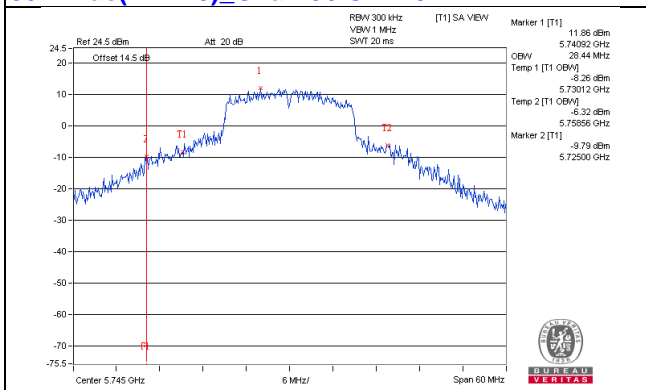

802.11ac(VHT20)_Chain1 / CH149

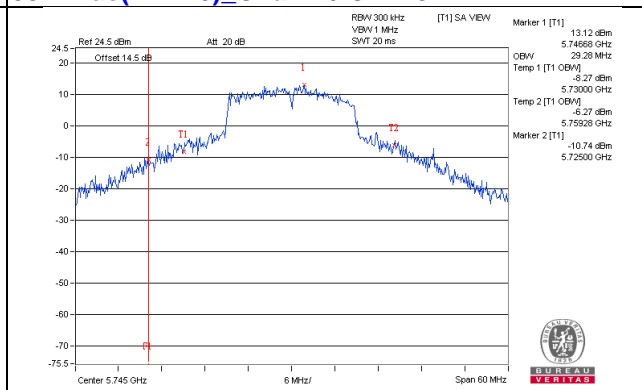

802.11ac(VHT20)_Chain2 / CH149

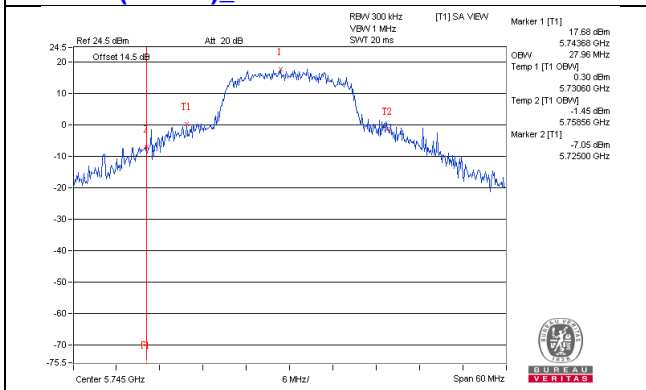

802.11ac(VHT20)_Chain3 / CH149

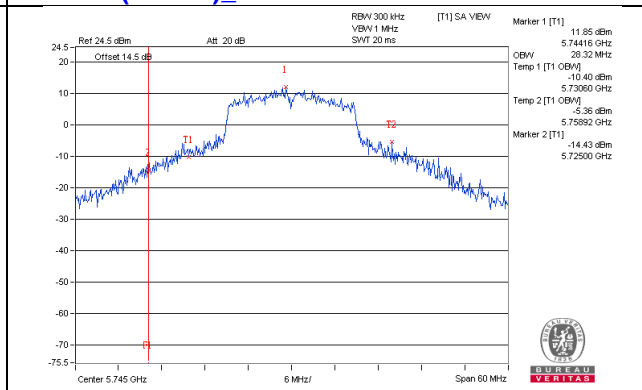

Spectrum Plot for near by DFS band (DFS is required, if 99% OCP straddle into U-NII-2C band)

802.11ac(VHT40)_Chain0 / CH151

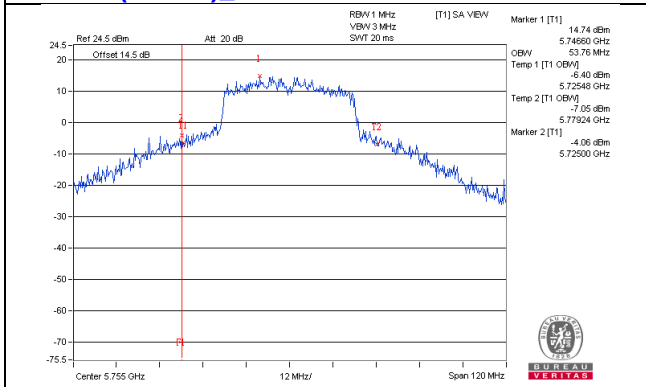

802.11ac(VHT40)_Chain1 / CH151

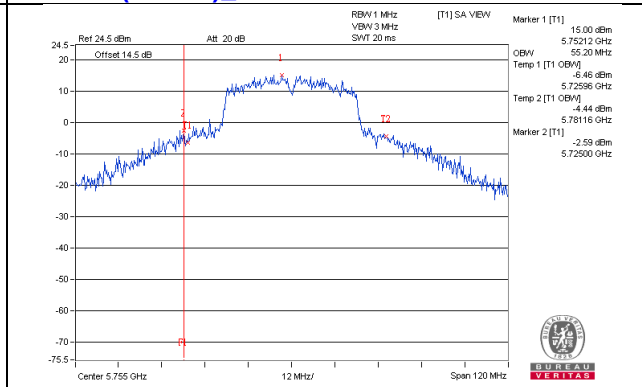

802.11ac(VHT40)_Chain2 / CH151

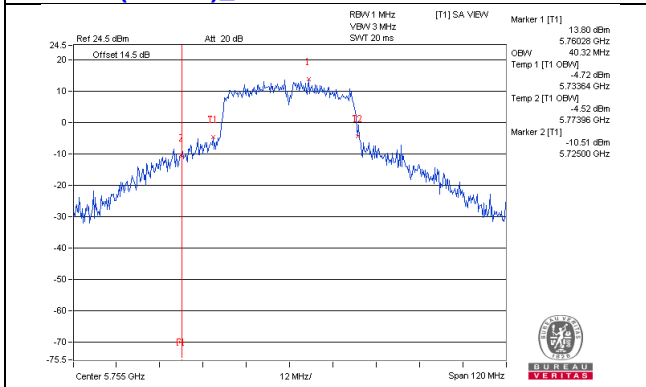

802.11ac(VHT40)_Chain3 / CH151

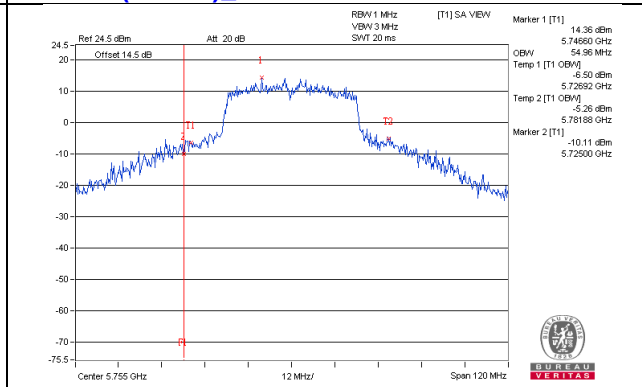

802.11ac(VHT80)_Chain0 / CH155

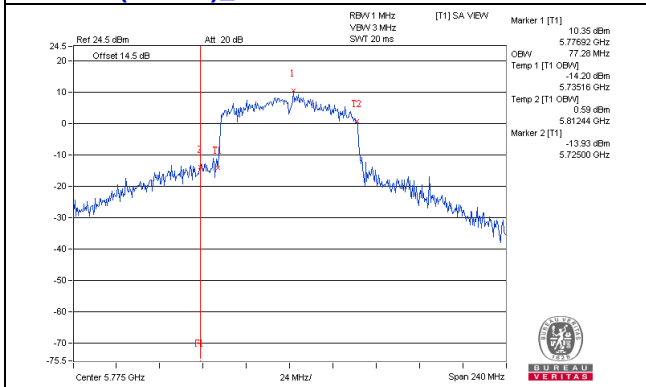

802.11ac(VHT80)_Chain1 / CH155

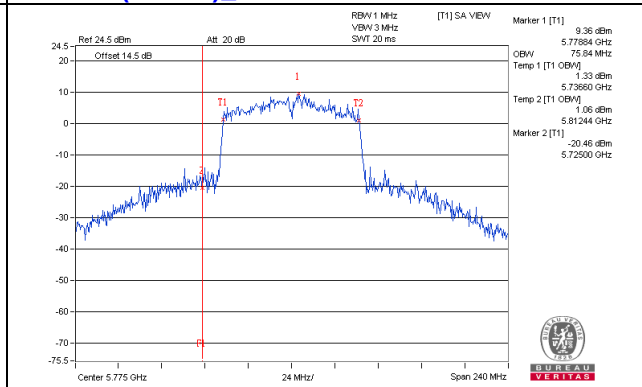

802.11ac(VHT80)_Chain2 / CH155

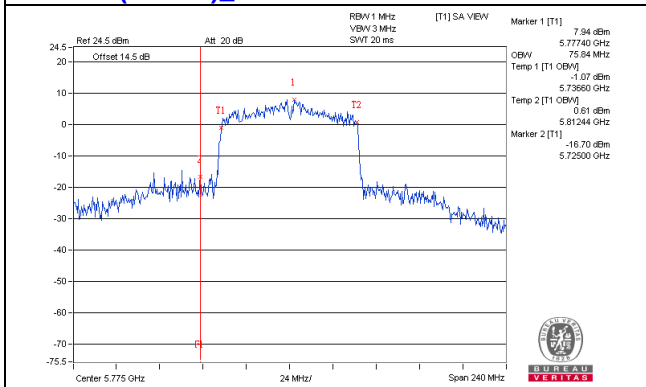

802.11ac(VHT80)_Chain3 / CH155

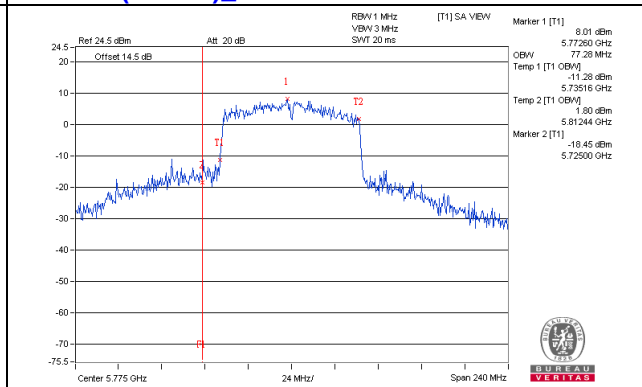

4.5 Peak Power Spectral Density Measurement

4.5.1 Limits of Peak Power Spectral Density Measurement

Operation Band	EUT Category		Limit
U-NII-1		Outdoor Access Point	17dBm/ MHz
		Fixed point-to-point Access Point	
	√	Indoor Access Point	11dBm/ MHz
	√	Mobile and Portable client device	
U-NII-2A			11dBm/ MHz
U-NII-2C			11dBm/ MHz
U-NII-3	√		30dBm/ 500kHz

Note: This device can support different category application which switched by access point mode and client mode by software.

4.5.2 Test Setup



4.5.3 Test Instruments

Refer to section 4.1.2 to get information of above instrument.

4.5.4 Test Procedure

For U-NII-1 band:

Using method SA-1

1. Set span to encompass the entire emission bandwidth (EBW) of the signal.
2. Set RBW = 1 MHz, Set VBW \geq 3 MHz, Detector = RMS
3. Sweep time = auto, trigger set to "free run".
4. Trace average at least 100 traces in power averaging mode.
5. Record the max value

For U-NII-3:

1. Set span to encompass the entire emission bandwidth (EBW) of the signal.
2. Set RBW = 300 kHz, Set VBW \geq 1 MHz, Detector = RMS
3. Use the peak marker function to determine the maximum power level in any 300 kHz band segment within the fundamental EBW.
4. Scale the observed power level to an equivalent value in 500 kHz by adjusting (reducing) the measured power by a bandwidth correction factor (BWCF) where $BWCF = 10\log(500 \text{ kHz}/300\text{kHz})$
5. Sweep time = auto, trigger set to "free run".
6. Trace average at least 100 traces in power averaging mode.
7. Record the max value

4.5.5 Deviation from Test Standard

No deviation.

4.5.6 EUT Operating Condition

Same as Item 4.3.6.

4.5.7 Test Results

For U-NII-1:

Master 802.11a

Chan.	Chan. Freq. (MHz)	PSD (dBm/MHz)				Total Power Density (dBm/MHz)	MAX. Limit (dBm/MHz)	Pass / Fail
		Chain 0	Chain 1	Chain 2	Chain 3			
36	5180	5.06	5.89	5.10	5.05	11.31	11.44	Pass
40	5200	4.89	6.10	5.05	5.15	11.34	11.44	Pass
48	5240	4.80	5.73	5.31	5.21	11.30	11.44	Pass

- Note:** 1. Method a) of power density measurement of KDB 662911 is using for calculating total power density. Total power density is summing entire spectra across corresponding frequency bins on the various outputs by computer.
2. Directional gain = $10 \log[(10^{G1/20} + 10^{G2/20} + 10^{G3/20} + 10^{G4/20})^2 / 4] = 11.56\text{dBi} > 6\text{dBi}$, so the power density limit shall be reduced to $17-(11.56-6) = 11.44$ dBm.

802.11ac (VHT20)

Chan.	Chan. Freq. (MHz)	PSD (dBm/MHz)				Total Power Density (dBm/MHz)	MAX. Limit (dBm/MHz)	Pass / Fail
		Chain 0	Chain 1	Chain 2	Chain 3			
36	5180	4.54	5.87	4.90	5.35	11.21	11.44	Pass
40	5200	4.72	5.83	4.70	5.20	11.16	11.44	Pass
48	5240	5.09	5.82	4.78	4.98	11.21	11.44	Pass

- Note:** 1. Method a) of power density measurement of KDB 662911 is using for calculating total power density. Total power density is summing entire spectra across corresponding frequency bins on the various outputs by computer.
2. Directional gain = $10 \log[(10^{G1/20} + 10^{G2/20} + 10^{G3/20} + 10^{G4/20})^2 / 4] = 11.56\text{dBi} > 6\text{dBi}$, so the power density limit shall be reduced to $17-(11.56-6) = 11.44$ dBm.

802.11ac (VHT40)

Chan.	Chan. Freq. (MHz)	PSD (dBm/MHz)				Total Power Density (dBm/MHz)	MAX. Limit (dBm/MHz)	Pass / Fail
		Chain 0	Chain 1	Chain 2	Chain 3			
38	5190	-0.07	-2.69	-0.49	1.06	5.67	11.44	Pass
46	5230	4.53	4.28	3.59	4.55	10.28	11.44	Pass

- Note:** 1. Method a) of power density measurement of KDB 662911 is using for calculating total power density. Total power density is summing entire spectra across corresponding frequency bins on the various outputs by computer.
2. Directional gain = $10 \log[(10^{G1/20} + 10^{G2/20} + 10^{G3/20} + 10^{G4/20})^2 / 4] = 11.56\text{dBi} > 6\text{dBi}$, so the power density limit shall be reduced to $17-(11.56-6) = 11.44$ dBm.

802.11ac (VHT80)

Chan.	Chan. Freq. (MHz)	PSD (dBm/MHz)				Total Power Density (dBm/MHz)	MAX. Limit (dBm/MHz)	Pass / Fail
		Chain 0	Chain 1	Chain 2	Chain 3			
38	5190	-4.09	-4.81	-5.71	-4.13	1.38	11.44	Pass

- Note:**
- Method a) of power density measurement of KDB 662911 is using for calculating total power density. Total power density is summing entire spectra across corresponding frequency bins on the various outputs by computer.
 - Directional gain = $10 \log[(10^{G1/20} + 10^{G2/20} + 10^{G3/20} + 10^{G4/20})^2 / 4] = 11.56\text{dBi} > 6\text{dBi}$, so the power density limit shall be reduced to $17-(11.56-6) = 11.44 \text{ dBm}$.

Spectrum Plot of Worst Value

802.11a_Chain 1 / CH40

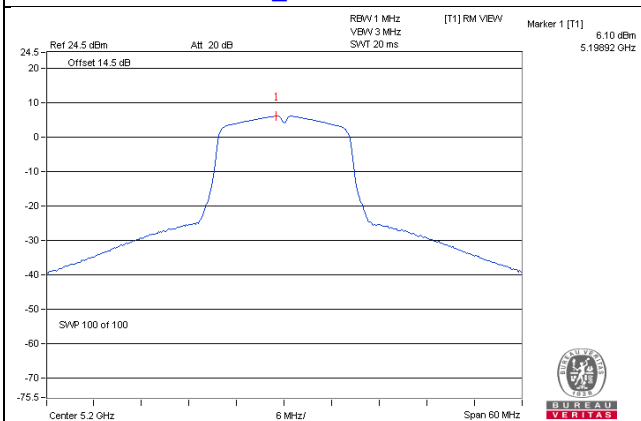

802.11ac (VHT20)_Chain 1 / CH40

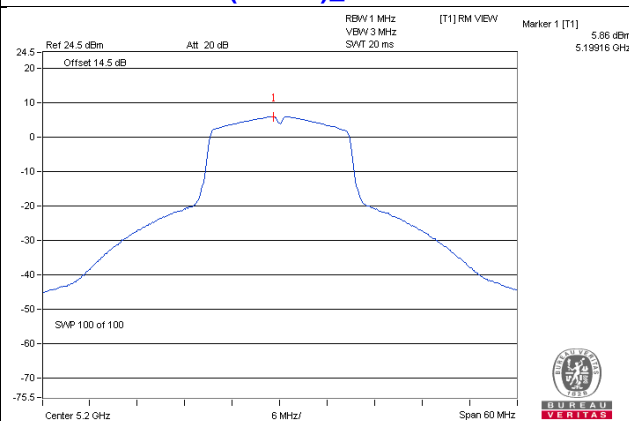

802.11ac (VHT40)_Chain 3 / CH46

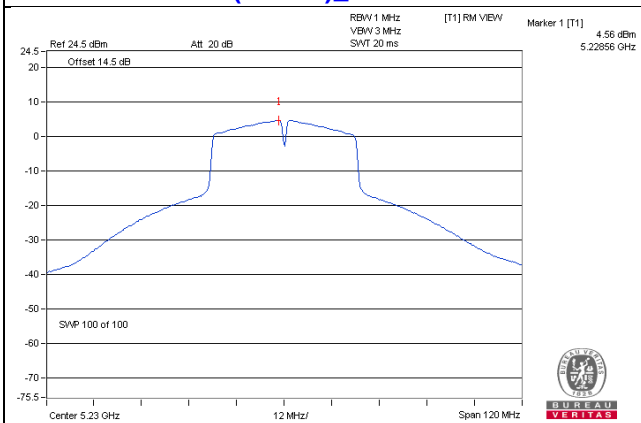

802.11ac (VHT80)_Chain 0 / CH42

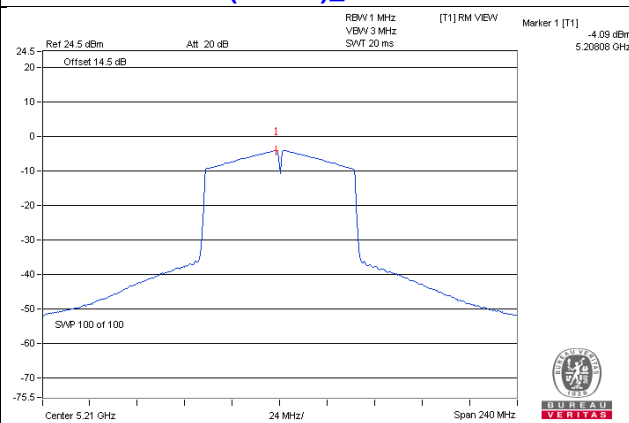

Client
802.11a

Chan.	Chan. Freq. (MHz)	PSD (dBm/MHz)				Total Power Density (dBm/MHz)	MAX. Limit (dBm/MHz)	Pass / Fail
		Chain 0	Chain 1	Chain 2	Chain 3			
36	5180	-0.90	0.00	-0.47	-1.41	5.36	5.44	Pass
40	5200	-0.76	-0.03	-0.63	-1.17	5.39	5.44	Pass
48	5240	-0.89	0.10	-0.57	-1.55	5.33	5.44	Pass

- Note:** 1. Method a) of power density measurement of KDB 662911 is using for calculating total power density. Total power density is summing entire spectra across corresponding frequency bins on the various outputs by computer.
 2. Directional gain = $10 \log[(10^{G1/20} + 10^{G2/20} + 10^{G3/20} + 10^{G4/20})^2 / 4]$ = 11.56dBi > 6dBi , so the power density limit shall be reduced to $11-(11.56-6) = 5.44$ dBm.

802.11ac (VHT20)

Chan.	Chan. Freq. (MHz)	PSD (dBm/MHz)				Total Power Density (dBm/MHz)	MAX. Limit (dBm/MHz)	Pass / Fail
		Chain 0	Chain 1	Chain 2	Chain 3			
36	5180	-0.91	-0.13	-1.22	-1.70	5.07	5.44	Pass
40	5200	-0.89	-0.46	-0.93	-1.35	5.12	5.44	Pass
48	5240	-0.70	-0.25	-0.64	-1.30	5.31	5.44	Pass

- Note:** 1. Method a) of power density measurement of KDB 662911 is using for calculating total power density. Total power density is summing entire spectra across corresponding frequency bins on the various outputs by computer.
 2. Directional gain = $10 \log[(10^{G1/20} + 10^{G2/20} + 10^{G3/20} + 10^{G4/20})^2 / 4]$ = 11.56dBi > 6dBi , so the power density limit shall be reduced to $11-(11.56-6) = 5.44$ dBm.

802.11ac (VHT40)

Chan.	Chan. Freq. (MHz)	PSD (dBm/MHz)				Total Power Density (dBm/MHz)	MAX. Limit (dBm/MHz)	Pass / Fail
		Chain 0	Chain 1	Chain 2	Chain 3			
38	5190	-0.65	-1.48	-0.90	-0.17	5.25	5.44	Pass
46	5230	-0.37	-1.12	-0.84	-0.12	5.43	5.44	Pass

- Note:** 1. Method a) of power density measurement of KDB 662911 is using for calculating total power density. Total power density is summing entire spectra across corresponding frequency bins on the various outputs by computer.
 2. Directional gain = $10 \log[(10^{G1/20} + 10^{G2/20} + 10^{G3/20} + 10^{G4/20})^2 / 4]$ = 11.56dBi > 6dBi , so the power density limit shall be reduced to $11-(11.56-6) = 5.44$ dBm.

802.11ac (VHT80)

Chan.	Chan. Freq. (MHz)	PSD (dBm/MHz)				Total Power Density (dBm/MHz)	MAX. Limit (dBm/MHz)	Pass / Fail
		Chain 0	Chain 1	Chain 2	Chain 3			
38	5190	-4.09	-4.81	-5.71	-4.13	1.38	5.44	Pass

- Note:**
- Method a) of power density measurement of KDB 662911 is using for calculating total power density. Total power density is summing entire spectra across corresponding frequency bins on the various outputs by computer.
 - Directional gain = $10 \log[(10^{G1/20} + 10^{G2/20} + 10^{G3/20} + 10^{G4/20})^2 / 4] = 11.56\text{dBi} > 6\text{dBi}$, so the power density limit shall be reduced to $11-(11.56-6) = 5.44 \text{ dBm}$.

Spectrum Plot of Worst Value

802.11a_Chain 1 / CH36

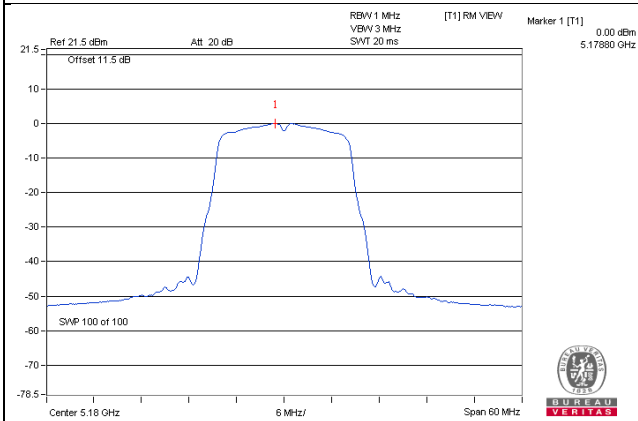

802.11ac (VHT20)_Chain 1 / CH36

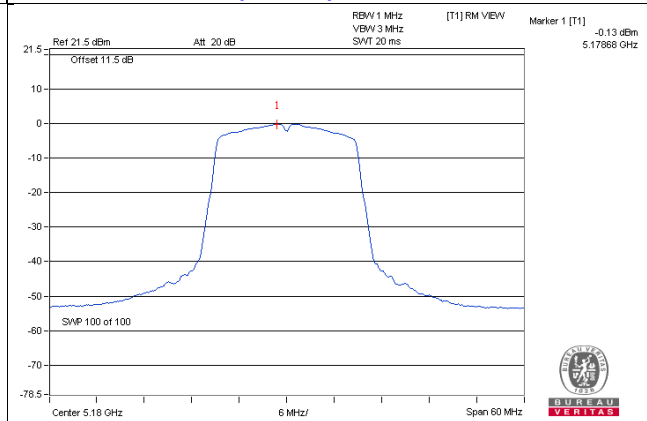

802.11ac (VHT40)_Chain 3 / CH46

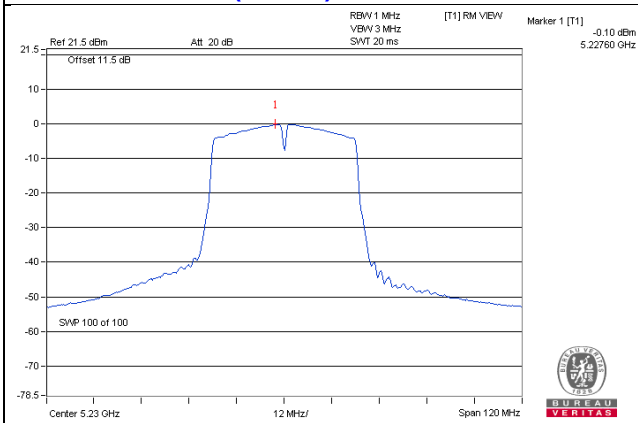

802.11ac (VHT80)_Chain 0 / CH42

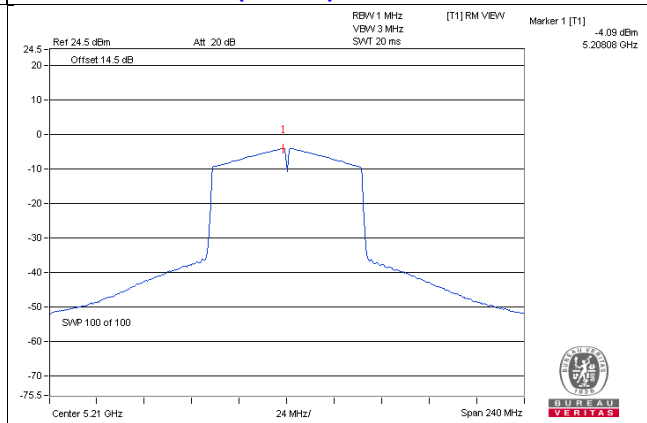

For U-NII-3:
802.11a

TX chain	Channel	Freq. (MHz)	PSD (dBm/300kHz)	PSD (dBm/500kHz)	10 log (N=4) dB	Total PSD (dBm/500kHz)	Limit (dBm/500kHz)	Pass /Fail
0	149	5745	0.86	3.08	6.02	9.10	24.44	Pass
	157	5785	0.31	2.53	6.02	8.55	24.44	Pass
	165	5825	0.16	2.38	6.02	8.40	24.44	Pass
1	149	5745	1.65	3.87	6.02	9.89	24.44	Pass
	157	5785	1.48	3.70	6.02	9.72	24.44	Pass
	165	5825	1.37	3.59	6.02	9.61	24.44	Pass
2	149	5745	1.61	3.83	6.02	9.85	24.44	Pass
	157	5785	0.69	2.91	6.02	8.93	24.44	Pass
	165	5825	0.40	2.62	6.02	8.64	24.44	Pass
3	149	5745	0.20	2.42	6.02	8.44	24.44	Pass
	157	5785	-0.27	1.95	6.02	7.97	24.44	Pass
	165	5825	-0.20	2.02	6.02	8.04	24.44	Pass

Note: Directional gain = $10 \log[(10^{G1/20} + 10^{G2/20} + 10^{G3/20} + 10^{G4/20})^2 / 4]$ = 11.56dBi > 6dBi , so the power density limit shall be reduced to $30-(11.56-6)$ =24.44 dBm.

802.11ac (VHT20)

TX chain	Channel	Freq. (MHz)	PSD (dBm/300kHz)	PSD (dBm/500kHz)	10 log (N=4) dB	Total PSD (dBm/500kHz)	Limit (dBm/500kHz)	Pass /Fail
0	149	5745	0.82	3.04	6.02	9.06	24.44	Pass
	157	5785	0.10	2.32	6.02	8.34	24.44	Pass
	165	5825	0.09	2.31	6.02	8.33	24.44	Pass
1	149	5745	1.49	3.71	6.02	9.73	24.44	Pass
	157	5785	1.32	3.54	6.02	9.56	24.44	Pass
	165	5825	0.92	3.14	6.02	9.16	24.44	Pass
2	149	5745	0.77	2.99	6.02	9.01	24.44	Pass
	157	5785	0.66	2.88	6.02	8.90	24.44	Pass
	165	5825	0.10	2.32	6.02	8.34	24.44	Pass
3	149	5745	0.29	2.51	6.02	8.53	24.44	Pass
	157	5785	-0.30	1.92	6.02	7.94	24.44	Pass
	165	5825	-0.29	1.93	6.02	7.95	24.44	Pass

Note: Directional gain = $10 \log[(10^{G1/20} + 10^{G2/20} + 10^{G3/20} + 10^{G4/20})^2 / 4]$ = 11.56dBi > 6dBi , so the power density limit shall be reduced to $30-(11.56-6)$ =24.44 dBm.

802.11ac (VHT40)

TX chain	Channel	Freq. (MHz)	PSD (dBm/300kHz)	PSD (dBm/500kHz)	10 log (N=4) dB	Total PSD (dBm/500kHz)	Limit (dBm/500kHz)	Pass /Fail
0	151	5755	-3.17	-0.95	6.02	5.07	24.44	Pass
	159	5795	-3.76	-1.54	6.02	4.48	24.44	Pass
1	151	5755	-2.08	0.14	6.02	6.16	24.44	Pass
	159	5795	-2.51	-0.29	6.02	5.73	24.44	Pass
2	151	5755	-3.95	-1.73	6.02	4.29	24.44	Pass
	159	5795	-3.14	-0.92	6.02	5.10	24.44	Pass
3	151	5755	-3.81	-1.59	6.02	4.43	24.44	Pass
	159	5795	-4.21	-1.99	6.02	4.03	24.44	Pass

Note: Directional gain = $10 \log[(10^{G1/20} + 10^{G2/20} + 10^{G3/20} + 10^{G4/20})^2 / 4]$ = 11.56dBi > 6dBi , so the power density limit shall be reduced to 30-(11.56-6) =24.44 dBm.

802.11ac (VHT80)

TX chain	Channel	Freq. (MHz)	PSD (dBm/300kHz)	PSD (dBm/500kHz)	10 log (N=4) dB	Total PSD (dBm/500kHz)	Limit (dBm/500kHz)	Pass /Fail
0	155	5755	-8.12	-5.90	6.02	0.12	24.44	Pass
1	155	5755	-8.28	-6.06	6.02	-0.04	24.44	Pass
2	155	5755	-9.52	-7.30	6.02	-1.28	24.44	Pass
3	155	5755	-8.86	-6.64	6.02	-0.62	24.44	Pass

Note: Directional gain = $10 \log[(10^{G1/20} + 10^{G2/20} + 10^{G3/20} + 10^{G4/20})^2 / 4]$ = 11.56dBi > 6dBi , so the power density limit shall be reduced to 30-(11.56-6) =24.44 dBm.

Spectrum Plot of Worst Value

802.11a – Chain 1: CH 149

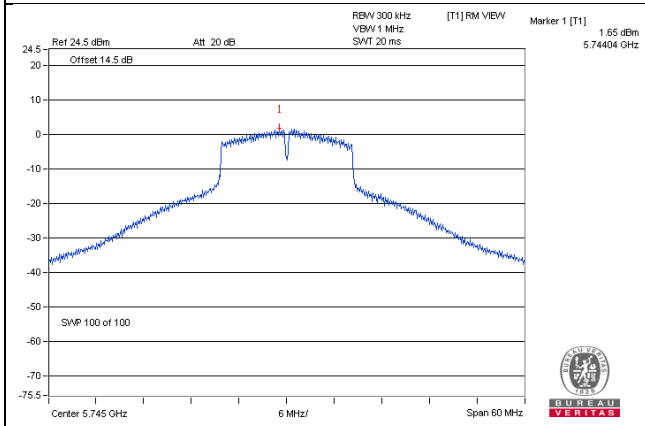

802.11ac (VHT20) – Chain 1: CH 149

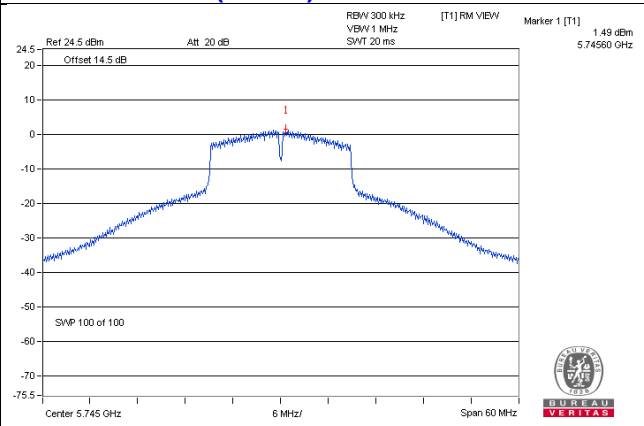

802.11ac (VHT40) – Chain 1: CH 151

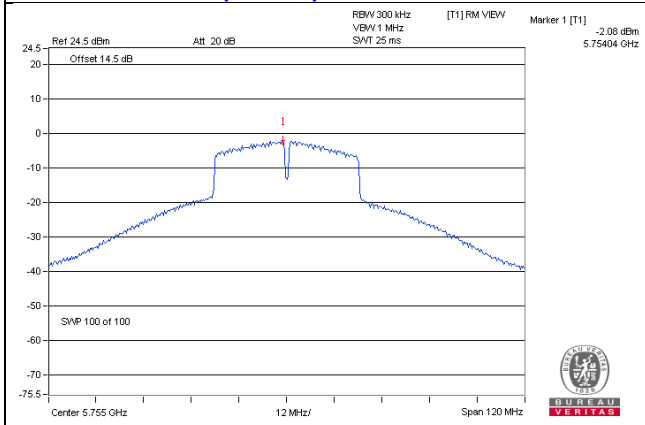

802.11ac (VHT80) – Chain 0: CH 155

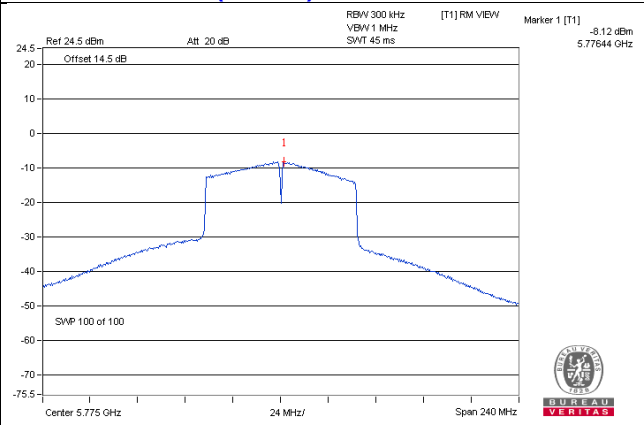

4.6 Frequency Stability Measurement

4.6.1 Limits of Frequency Stability Measurement

The frequency of the carrier signal shall be maintained within band of operation

4.6.2 Test Setup

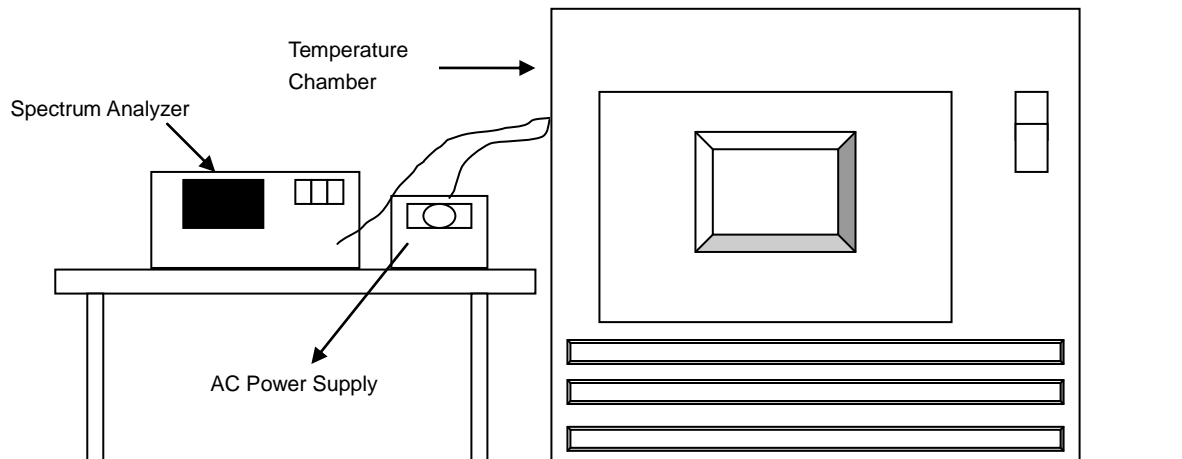

4.6.3 Test Instruments

Refer to section 4.1.2 to get information of above instrument.

4.6.4 Test Procedure

- The EUT was placed inside the environmental test chamber and powered by nominal AC voltage.
- Turn the EUT on and couple its output to a spectrum analyzer.
- Turn the EUT off and set the chamber to the highest temperature specified.
- Allow sufficient time (approximately 30 min) for the temperature of the chamber to stabilize, turn the EUT on and measure the operating frequency after 2, 5, and 10 Minutes.
- Repeat step 2 and 3 with the temperature chamber set to the lowest temperature.
- The test chamber was allowed to stabilize at +20 degree C for a minimum of 30 Minutes. The supply voltage was then adjusted on the EUT from 85% to 115% and the frequency record.

4.6.5 Deviation from Test Standard

No deviation.

4.6.6 EUT Operating Condition

Set the EUT transmit at un-modulation mode to test frequency stability.

4.6.7 Test Results

Frequency Stability Versus Temp.									
Operating Frequency: 5180 MHz									
TEMP. (°C)	Power Supply (Vac)	0 Minute		2 Minute		5 Minute		10 Minute	
		Measured Frequency (MHz)	Pass/Fail	Measured Frequency (MHz)	Pass/Fail	Measured Frequency (MHz)	Pass/Fail	Measured Frequency (MHz)	Pass/Fail
50	120	5180.0245	Pass	5180.022	Pass	5180.0223	Pass	5180.0258	Pass
40	120	5179.9778	Pass	5179.9782	Pass	5179.9773	Pass	5179.9791	Pass
30	120	5180.0136	Pass	5180.0124	Pass	5180.011	Pass	5180.0157	Pass
20	120	5179.9956	Pass	5179.9958	Pass	5179.996	Pass	5179.9948	Pass
10	120	5179.9893	Pass	5179.9902	Pass	5179.9933	Pass	5179.9904	Pass
0	120	5179.9876	Pass	5179.9875	Pass	5179.99	Pass	5179.991	Pass
-10	120	5180.0085	Pass	5180.0052	Pass	5180.0071	Pass	5180.0057	Pass
-20	120	5180.0133	Pass	5180.0172	Pass	5180.015	Pass	5180.0155	Pass
-30	120	5179.9968	Pass	5179.9939	Pass	5179.9928	Pass	5179.9927	Pass

Frequency Stability Versus Voltage									
Operating Frequency: 5180 MHz									
TEMP. (°C)	Power Supply (Vac)	0 Minute		2 Minute		5 Minute		10 Minute	
		Measured Frequency (MHz)	Pass/Fail	Measured Frequency (MHz)	Pass/Fail	Measured Frequency (MHz)	Pass/Fail	Measured Frequency (MHz)	Pass/Fail
20	138	5179.995	PASS	5179.9955	PASS	5179.9961	PASS	5179.9952	PASS
	120	5179.9956	PASS	5179.9958	PASS	5179.996	PASS	5179.9948	PASS
	102	5179.9953	PASS	5179.9962	PASS	5179.9956	PASS	5179.9946	PASS

4.7 6dB Bandwidth Measurement

4.7.1 Limits of 6dB Bandwidth Measurement

The minimum of 6dB Bandwidth Measurement is 0.5MHz.

4.7.2 Test Setup

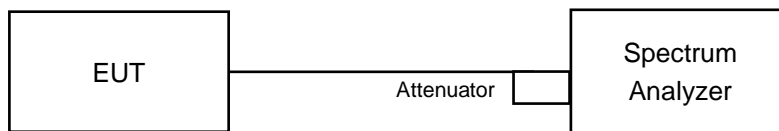

4.7.3 Test Instruments

Refer to section 4.1.2 to get information of above instrument.

4.7.4 Test Procedure

MEASUREMENT PROCEDURE REF

- a. Set resolution bandwidth (RBW) = 100kHz
- b. Set the video bandwidth (VBW) $\geq 3 \times$ RBW, Detector = Peak.
- c. Trace mode = max hold.
- d. Sweep = auto couple.
- e. Measure the maximum width of the emission that is constrained by the frequencies associated with the two amplitude points (upper and lower) that are attenuated by 6 dB relative to the maximum level measured in the fundamental emission

4.7.5 Deviation from Test Standard

No deviation.

4.7.6 EUT Operating Condition

The software provided by client to enable the EUT under transmission condition continuously at lowest, middle and highest channel frequencies individually.

4.7.7 Test Results

802.11a

Channel	Frequency (MHz)	6dB Bandwidth (MHz)				Minimum Limit (MHz)	Pass / Fail
		Chain 0	Chain 1	Chain 2	Chain 3		
149	5745	16.44	16.41	16.39	16.42	0.5	PASS
157	5785	16.38	16.43	16.42	16.40	0.5	PASS
165	5825	16.42	16.46	16.38	16.41	0.5	PASS

802.11ac (VHT20)

Channel	Frequency (MHz)	6dB Bandwidth (MHz)				Minimum Limit (MHz)	Pass / Fail
		Chain 0	Chain 1	Chain 2	Chain 3		
149	5745	17.69	17.65	17.66	17.65	0.5	PASS
157	5785	17.68	17.67	17.64	17.69	0.5	PASS
165	5825	17.71	17.65	17.63	17.69	0.5	PASS

802.11ac (VHT40)

Channel	Frequency (MHz)	6dB Bandwidth (MHz)				Minimum Limit (MHz)	Pass / Fail
		Chain 0	Chain 1	Chain 2	Chain 3		
151	5755	36.17	36.47	36.47	36.51	0.5	PASS
159	5795	36.42	36.46	36.18	36.39	0.5	PASS

802.11ac (VHT80)

Channel	Frequency (MHz)	6dB Bandwidth (MHz)				Minimum Limit (MHz)	Pass / Fail
		Chain 0	Chain 1	Chain 2	Chain 3		
155	5775	72.04	73.14	76.05	76.11	0.5	PASS

Spectrum Plot of Worst Value

802.11a_Chain 0 / CH157

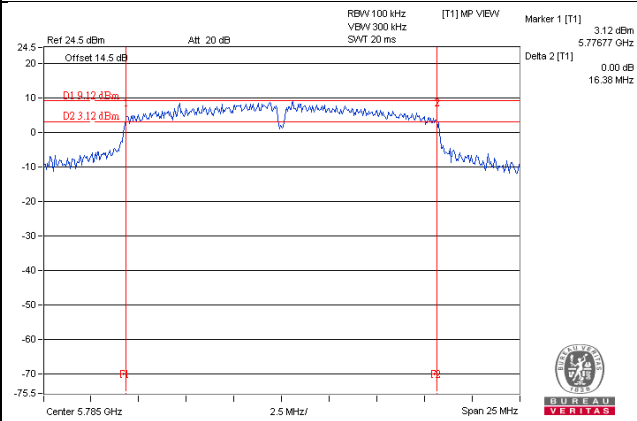

802.11ac (VHT20)_Chain 2 / CH165

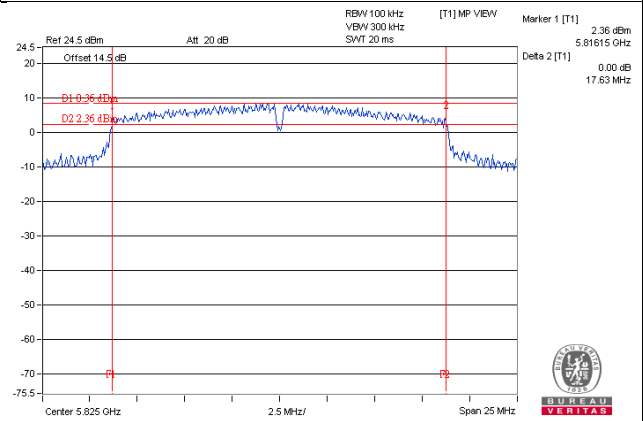

802.11ac (VHT40)_Chain 0 / CH151

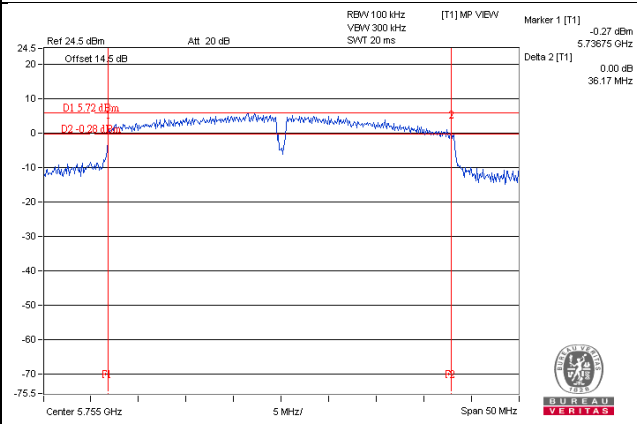

802.11ac (VHT80)_Chain 0 / CH155

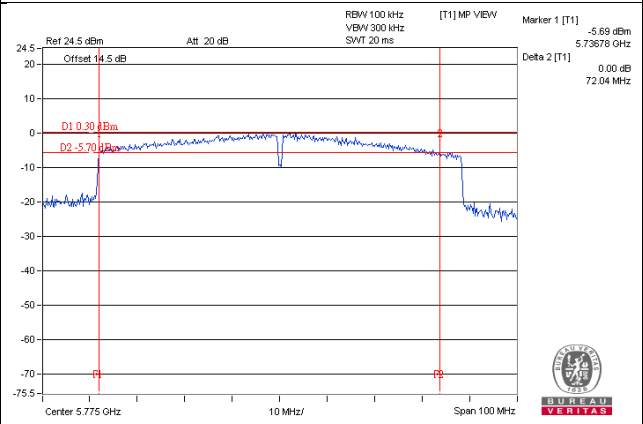

5 Pictures of Test Arrangements

Please refer to the attached file (Test Setup Photo).

Annex A- Radiated Out of Band Emission (OOBE) Measurement (For U-NII-3 band)

802.11a

CH 149 5745 MHz

Horizontal

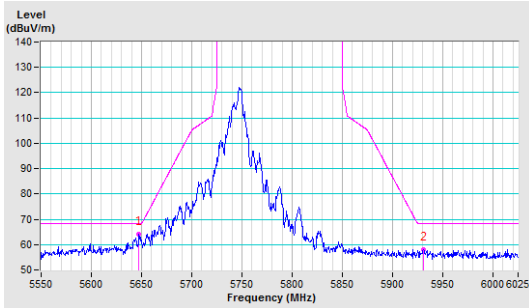

Vertical

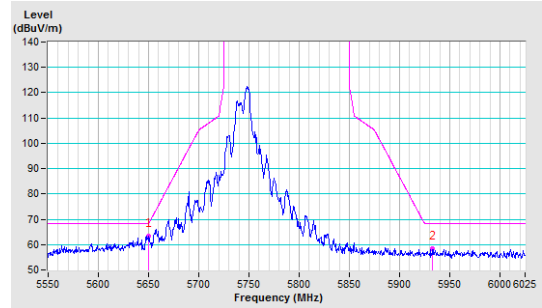

CH 157 5785 MHz

Horizontal

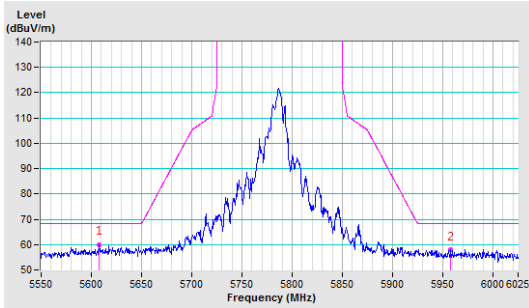

Vertical

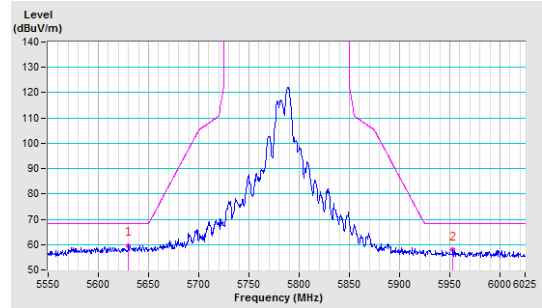

CH 165 5825 MHz

Horizontal

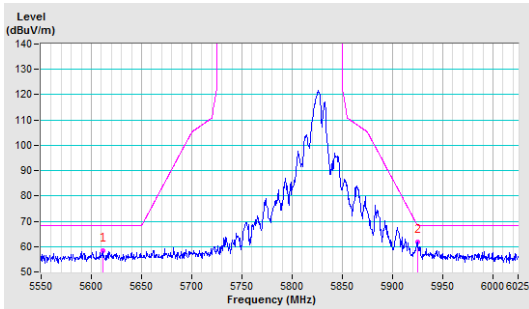

Vertical

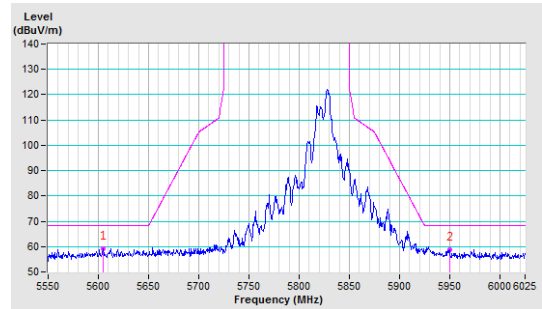

802.11ac (VHT20)

CH 149 5745 MHz

Horizontal

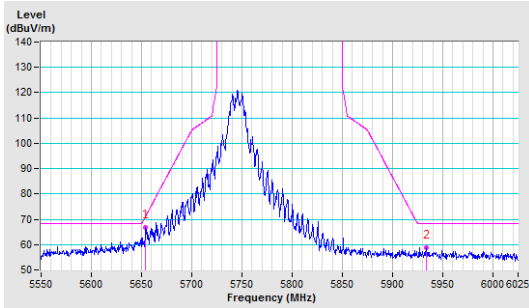

Vertical

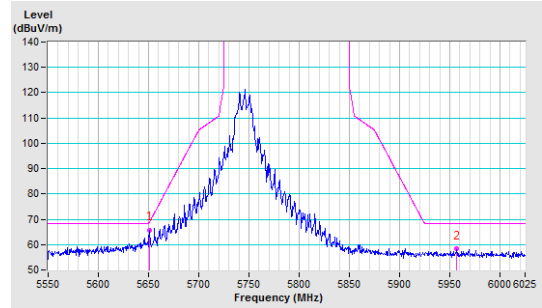

CH 157 5785 MHz

Horizontal

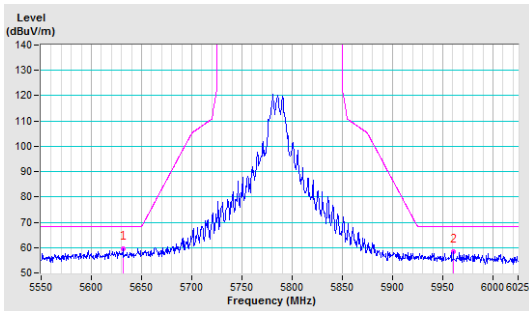

Vertical

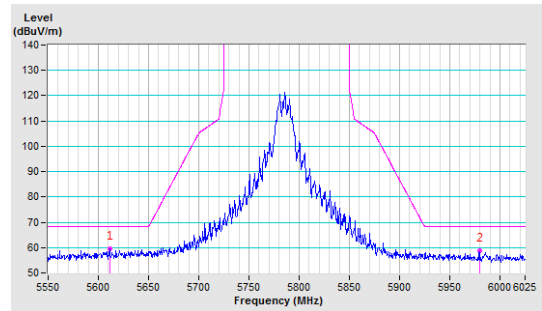

CH 165 5825 MHz

Horizontal

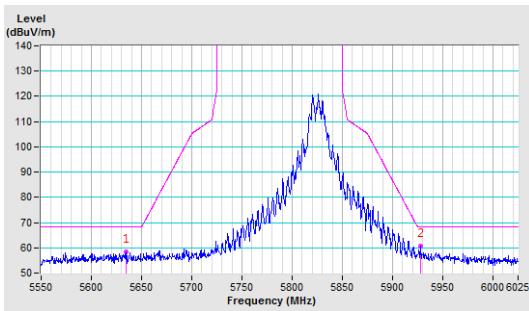

Vertical

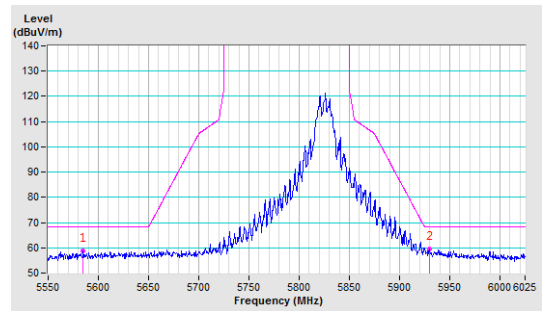

802.11ac (VHT40)

CH 151 5755 MHz

Horizontal

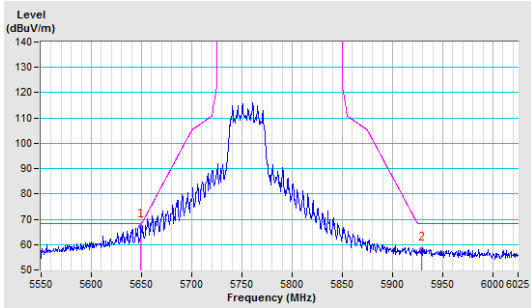

Vertical

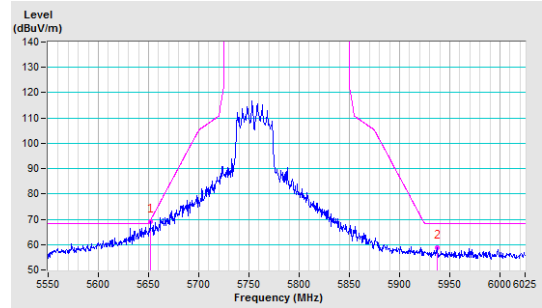

CH 159 5795 MHz

Horizontal

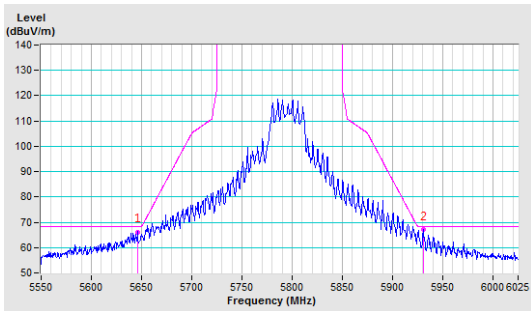

Vertical

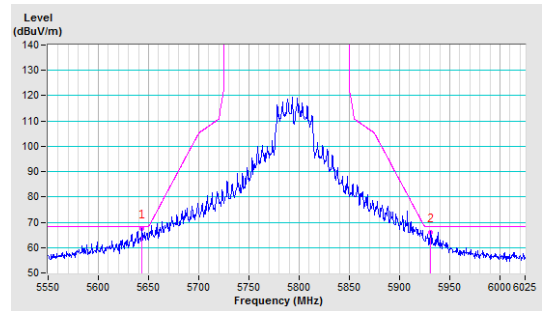

802.11ac (VHT80)

CH 155 5775 MHz

Horizontal

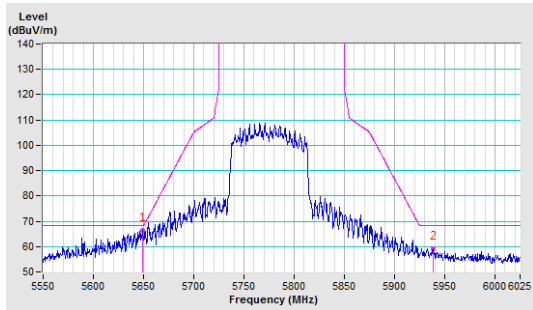

Vertical

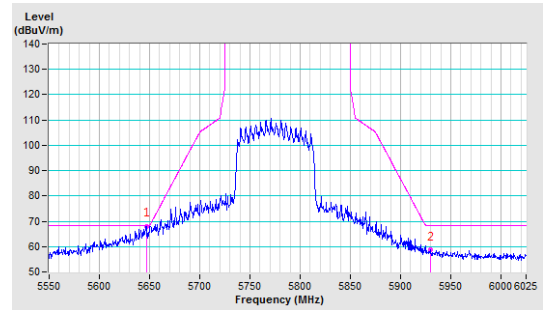

Appendix – Information on the Testing Laboratories

We, Bureau Veritas Consumer Products Services (H.K.) Ltd., Taoyuan Branch, were founded in 1988 to provide our best service in EMC, Radio, Telecom and Safety consultation. Our laboratories are FCC recognized accredited test firms and accredited according to ISO/IEC 17025.

If you have any comments, please feel free to contact us at the following:

Linko EMC/RF Lab

Tel: 886-2-26052180

Fax: 886-2-26051924

Hsin Chu EMC/RF/Telecom Lab

Tel: 886-3-6668565

Fax: 886-3-6668323

Hwa Ya EMC/RF/Safety Lab

Tel: 886-3-3183232

Fax: 886-3-3270892

Email: service.adt@tw.bureauveritas.com

Web Site: www.bureauveritas-adt.com

The address and road map of all our labs can be found in our web site also.

--- END ---