

Report No.: RFBAOZ-WTW-P20090121-1

FCC ID: 2AHKM-HIVE2210

Test Model: HIVE-2210

Received Date: Sep. 04, 2020

Test Date: Sep. 23 to Oct. 07, 2020

Issued Date: Oct. 22, 2020

Applicant: Hitron Technologies Inc.

Address: No. 1-8, Li-Hsin 1st Rd., Hsinchu Science Park, Hsinchu 30078, Taiwan,
R.O.C.

Issued By: Bureau Veritas Consumer Products Services (H.K.) Ltd., Taoyuan Branch
Hsin Chu Laboratory

Lab Address: E-2, No.1, Li Hsin 1st Road, Hsinchu Science Park, Hsinchu City 300,
Taiwa.

Test Location: E-2, No.1, Li Hsin 1st Road, Hsinchu Science Park, Hsinchu City 300,
Taiwan.

**FCC Registration /
Designation Number:** 723255 / TW2022



This report is for your exclusive use. Any copying or replication of this report to or for any other person or entity, or use of our name or trademark, is permitted only with our prior written permission. This report sets forth our findings solely with respect to the test samples identified herein. The results set forth in this report are not indicative or representative of the quality or characteristics of the lot from which a test sample was taken or any similar or identical product unless specifically and expressly noted. Our report includes all of the tests requested by you and the results thereof based upon the information that you provided to us. You have 60 days from date of issuance of this report to notify us of any material error or omission caused by our negligence, provided, however, that such notice shall be in writing and shall specifically address the issue you wish to raise. A failure to raise such issue within the prescribed time shall constitute your unqualified acceptance of the completeness of this report, the tests conducted and the correctness of the report contents. Unless specifically mentioned, the uncertainty of measurement has been explicitly taken into account to declare the compliance or non-compliance to the specification.

Table of Contents

Release Control Record	4
1 Certificate of Conformity	5
2 Summary of Test Results	6
2.1 Measurement Uncertainty	6
2.2 Modification Record	6
3 General Information	7
3.1 General Description of EUT	7
3.2 Description of Test Modes	10
3.2.1 Test Mode Applicability and Tested Channel Detail	11
3.3 Duty Cycle of Test Signal	14
3.4 Description of Support Units	15
3.4.1 Configuration of System under Test	16
3.5 General Description of Applied Standard and references	17
4 Test Types and Results	18
4.1 Radiated Emission and Bandedge Measurement	18
4.1.1 Limits of Radiated Emission and Bandedge Measurement	18
4.1.2 Test Instruments	19
4.1.3 Test Procedure	22
4.1.4 Deviation from Test Standard	23
4.1.5 Test Setup	23
4.1.6 EUT Operating Condition	24
4.1.7 Test Results	25
4.2 Conducted Emission Measurement	45
4.2.1 Limits of Conducted Emission Measurement	45
4.2.2 Test Instruments	45
4.2.3 Test Procedure	46
4.2.4 Deviation from Test Standard	46
4.2.5 Test Setup	46
4.2.6 EUT Operating Condition	46
4.2.7 Test Results	47
4.3 Transmit Power Measurement	49
4.3.1 Limits of Transmit Power Measurement	49
4.3.2 Test Setup	49
4.3.3 Test Instruments	49
4.3.4 Test Procedure	49
4.3.5 Deviation from Test Standard	49
4.3.6 EUT Operating Condition	49
4.3.7 Test Results	50
4.4 Occupied Bandwidth Measurement	58
4.4.1 Test Setup	58
4.4.2 Test Instruments	58
4.4.3 Test Procedure	58
4.4.4 Test Results	59
4.5 Peak Power Spectral Density Measurement	66
4.5.1 Limits of Peak Power Spectral Density Measurement	66
4.5.2 Test Setup	66
4.5.3 Test Instruments	66
4.5.4 Test Procedure	66
4.5.5 Deviation from Test Standard	67
4.5.6 EUT Operating Condition	67
4.5.7 Test Results	68
4.6 Frequency Stability Measurement	74
4.6.1 Limits of Frequency Stability Measurement	74

4.6.2 Test Setup.....	74
4.6.3 Test Instruments	74
4.6.4 Test Procedure	74
4.6.5 Deviation from Test Standard	74
4.6.6 EUT Operating Condition	74
4.6.7 Test Results	75
4.7 6dB Bandwidth Measurement	76
4.7.1 Limits of 6dB Bandwidth Measurement.....	76
4.7.2 Test Setup.....	76
4.7.3 Test Instruments	76
4.7.4 Test Procedure	76
4.7.5 Deviation from Test Standard	76
4.7.6 EUT Operating Condition	76
4.7.7 Test Results	77
5 Pictures of Test Arrangements.....	79
Annex A- Radiated Out of Band Emission (OOBE) Measurement (For U-NII-3 band)	80
Annex B- Band-edge measurement (For U-NII-1 band)	83
Appendix – Information of the Testing Laboratories	87



Release Control Record

Issue No.	Description	Date Issued
RFBAOZ-WTW-P20090121-1	Original release.	Oct. 22, 2020

1 Certificate of Conformity

Product: WiFi Extender

Brand: hitron

Test Model: HIVE-2210

Sample Status: ENGINEERING SAMPLE

Applicant: Hitron Technologies Inc.

Test Date: Sep. 23 to Oct. 07, 2020

Standard: 47 CFR FCC Part 15, Subpart E (Section 15.407)
ANSI C63.10: 2013

The above equipment has been tested by **Bureau Veritas Consumer Products Services (H.K.) Ltd., Taoyuan Branch**, and found compliance with the requirement of the above standards. The test record, data evaluation & Equipment Under Test (EUT) configurations represented herein are true and accurate accounts of the measurements of the sample's EMC characteristics under the conditions specified in this report.

Prepared by :



Joyce Kuo / Specialist

Date:

Oct. 22, 2020

Approved by :



Clark Lin / Technical Manager

Date:

Oct. 22, 2020

2 Summary of Test Results

47 CFR FCC Part 15, Subpart E (Section 15.407)			
FCC Clause	Test Item	Result	Remarks
15.407(b)(6)	AC Power Conducted Emissions	PASS	Meet the requirement of limit. Minimum passing margin is -4.45dB at 0.34141MHz.
15.407(b) (1/2/3/4(i/ii)/6)	Radiated Emissions & Band Edge Measurement*	PASS	Meet the requirement of limit. Minimum passing margin is -0.1dB at 5146.30MHz, 5148.20MHz.
15.407(a)(1/2/3)	Max Average Transmit Power	PASS	Meet the requirement of limit.
---	Occupied Bandwidth Measurement	-	Reference only.
15.407(a)(1/2/3)	Peak Power Spectral Density	PASS	Meet the requirement of limit.
15.407(e)	6dB bandwidth	PASS	Meet the requirement of limit. (U-NII-3 Band only)
15.407(g)	Frequency Stability	PASS	Meet the requirement of limit.
15.203	Antenna Requirement	PASS	Antenna connector is i-pex(MHF)not a standard connector.

Note:

1. For U-NII-3 band compliance with rule part 15.407(b)(4)(i), the OOB test plots were recorded in Annex A.
2. For U-NII-1 band compliance with rule 15.407(b) of the band-edge items, the test plots were recorded in Annex B. Test Procedures refer to report 4.1.3.
3. Determining compliance based on the results of the compliance measurement, not taking into account measurement instrumentation uncertainty.

2.1 Measurement Uncertainty

Where relevant, the following measurement uncertainty levels have been estimated for tests performed on the EUT as specified in CISPR 16-4-2:

Measurement	Frequency	Expanded Uncertainty (k=2) (±)
Conducted Emissions at mains ports	150kHz ~ 30MHz	1.9 dB
Radiated Emissions up to 1 GHz	9kHz ~ 30MHz	3.1 dB
	30MHz ~ 1GHz	5.4 dB
Radiated Emissions above 1 GHz	1GHz ~ 18GHz	5.0 dB
	18GHz ~ 40GHz	5.3 dB

2.2 Modification Record

There were no modifications required for compliance.

3 General Information

3.1 General Description of EUT

Product	WiFi Extender
Brand	hitron
Test Model	HIVE-2210
Status of EUT	ENGINEERING SAMPLE
Power Supply Rating	12Vdc from power adapter
Modulation Type	CCK, DQPSK, DBPSK for DSSS 64QAM, 16QAM, QPSK, BPSK for OFDM 256QAM for OFDM in 11ac mode and VHT20/40 in 2.4GHz 1024QAM for OFDMA in 11ax HE mode
Modulation Technology	DSSS, OFDM, OFDMA
Transfer Rate	802.11b: up to 11 Mbps 802.11a/g: up to 54 Mbps 802.11n: up to 300 Mbps 802.11ac: up to 866.7 Mbps 802.11ax: up to 1201.0 Mbps
Operating Frequency	2.4GHz: 2.412 ~ 2.462GHz 5GHz: 5.18~5.24GHz, 5.745 ~ 5.825GHz
Number of Channel	2.4GHz: 802.11b, 802.11g, 802.11n (HT20), VHT20, 80211ax (HE20): 11 802.11n (HT40), VHT40, 80211ax (HE40): 7 5GHz: 802.11a, 802.11n (HT20), 802.11ac (VHT20), 80211ax (HE20): 9 802.11n (HT40), 802.11ac (VHT40), 80211ax (HE40): 4 802.11ac (VHT80), 80211ax (HE80): 2
Output Power	CDD Mode: 2.412 ~ 2.462 GHz: 912.141 mW 5.18 ~ 5.24 GHz: Master: 735.268 mW Client: 235.285 mW 5.745 ~ 5.825 GHz: 664.858 mW Beamforming Mode: 2.412 ~ 2.462 GHz: 686.38 mW 5.18 ~ 5.24 GHz: Master: 651.514 mW Client: 208.804 mW 5.745 ~ 5.825 GHz: 659.305 mW
Antenna Type	Refer to Note
Antenna Connector	Refer to Note
Accessory Device	Adapter x1
Data Cable Supplied	NA

Note:

1. There are WLAN and Bluetooth technology used for the EUT. The EUT has three radios as following table:

Radio 1	Radio 2	Radio 3
WLAN 2.4GHz	WLAN 5GHz	Bluetooth

2. Simultaneously transmission condition.

Condition	Technology		
1	WLAN 2.4GHz	WLAN 5GHz	Bluetooth

Note: The emission of the simultaneous operation has been evaluated and no non-compliance was found.

3. The EUT must be supplied with a power adapter:

No.	Brand	Model No.	Spec.
1	UNIVERSAL MICROELECTRONICS CO., LTD.	UP0181M-12PA	Input: 100-240Vac, 0.4A, 50/60Hz Output: 12Vdc, 1.5A 18W DC Output cable: Unshielded, 1.2m

4. The antennas provided to the EUT, please refer to the following table:

Antenna NO.	Chain No.	Brand	Model	Antenna Net Gain(dBi)	Frequency range	Antenna Type	Connector Type	Cable Length (mm)
WiFi 2.4G	1	ALPHA	RFPCA252007IMAB301	3.5	2.4~2.4835GHz	PIFA	i-pex(MHF)	7
	2		RFPCA252023IMAB301	2.7	2.4~2.4835GHz			23.5
WiFi 5G	1		RFPCA251812IM5B302	4	5.15~5.85GHz			12
	2		RFPCA251817IM5B301	3.5	5.15~5.85GHz			18
BT	-		RFPCA252019IMAB302	2.8	2.4~2.4835GHz			19

5. The EUT incorporates a MIMO function:

2.4GHz Band		
MODULATION MODE	TX & RX CONFIGURATION	
802.11b	2TX	2RX
802.11g	2TX	2RX
802.11n (HT20)	2TX	2RX
802.11n (HT40)	2TX	2RX
VHT20	2TX	2RX
VHT40	2TX	2RX
802.11ax (HE20)	2TX	2RX
802.11ax (HE40)	2TX	2RX
5GHz Band		
MODULATION MODE	TX & RX CONFIGURATION	
802.11a	2TX	2RX
802.11n (HT20)	2TX	2RX
802.11n (HT40)	2TX	2RX
802.11ac (VHT20)	2TX	2RX
802.11ac (VHT40)	2TX	2RX
802.11ac (VHT80)	2TX	2RX
802.11ax (HE20)	2TX	2RX
802.11ax (HE40)	2TX	2RX
802.11ax (HE80)	2TX	2RX

Note:

1. All of modulation mode support beamforming function except 802.11a/b/g modulation mode.
2. The EUT support Beamforming and CDD mode, therefore both mode were investigated and the worst case scenario was identified. The worst case data were presented in test report.
3. The modulation and bandwidth are similar for 802.11n mode for 20MHz (40MHz), 802.11ac mode for 20MHz (40MHz, 80MHz) and 802.11ax mode for 20MHz (40MHz, 80MHz), therefore the manufacturer will control the power for 802.11n/ac mode is the same as the 802.11ax or more lower than it and investigated worst case to representative mode in test report. (Final test mode refer to section 3.2.1)

6. The above EUT information is declared by manufacturer and for more detailed features description, please refers to the manufacturer's specifications or user's manual.
7. The above Antenna information is declared by manufacturer and for more detailed features description, please refer to the manufacturer's specifications, the laboratory shall not be held responsible.

3.2 Description of Test Modes

FOR 5180 ~ 5240MHz

4 channels are provided for 802.11a, 802.11n (HT20), 802.11ac (VHT20), 802.11ax (HE20):

Channel	Frequency	Channel	Frequency
36	5180 MHz	44	5220 MHz
40	5200 MHz	48	5240 MHz

2 channels are provided for 802.11n (HT40), 802.11ac (VHT40), 802.11ax (HE40):

Channel	Frequency	Channel	Frequency
38	5190 MHz	46	5230 MHz

1 channel is provided for 802.11ac (VHT80), 802.11ax (HE80):

Channel	Frequency
42	5210 MHz

FOR 5745 ~ 5825MHz:

5 channels are provided for 802.11a, 802.11n (HT20), 802.11ac (VHT20), 802.11ax (HE20):

Channel	Frequency	Channel	Frequency
149	5745 MHz	161	5805 MHz
153	5765 MHz	165	5825 MHz
157	5785 MHz		

2 channels are provided for 802.11n (HT40), 802.11ac (VHT40), 802.11ax (HE40):

Channel	Frequency	Channel	Frequency
151	5755 MHz	159	5795 MHz

1 channel is provided for 802.11ac (VHT80), 802.11ax (HE80):

Channel	Frequency
155	5775 MHz

3.2.1 Test Mode Applicability and Tested Channel Detail

EUT Configure Mode	Applicable To				Description
	RE≥1G	RE<1G	PLC	APCM	
-	√	√	√	√	-

Where **RE≥1G**: Radiated Emission above 1GHz **RE<1G**: Radiated Emission below 1GHz
PLC: Power Line Conducted Emission **APCM**: Antenna Port Conducted Measurement

Note: The EUT had been pre-tested on the positioned of laying-flat and wall-mount. The worst case was found when positioned of on laying-flat.

Radiated Emission Test (Above 1GHz):

- Pre-Scan has been conducted to determine the worst-case mode from all possible combinations between available modulations, data rates and antenna ports (if EUT with antenna diversity architecture).
- Following channel(s) was (were) selected for the final test as listed below.

CDD Mode						
Mode	FREQ. Band (MHz)	Available Channel	Tested Channel	Modulation Technology	Modulation Type	Data Rate Parameter
802.11a	5180-5240	36 to 48	36, 40, 48	OFDM	BPSK	6Mb/s
802.11ax (HE20)		36 to 48	36, 40, 48	OFDMA	BPSK	MCS0
802.11ax (HE40)		38 to 46	38, 46	OFDMA	BPSK	MCS0
802.11ax (HE80)		42	42	OFDMA	BPSK	MCS0
11a	5745-5825	149 to 165	149, 157, 165	OFDM	BPSK	6Mb/s
802.11ax (HE20)		149 to 165	149, 157, 165	OFDMA	BPSK	MCS0
802.11ax (HE40)		151 to 159	151, 159	OFDMA	BPSK	MCS0
802.11ax (HE80)		155	155	OFDMA	BPSK	MCS0

Radiated Emission Test (Below 1GHz):

- Pre-Scan has been conducted to determine the worst-case mode from all possible combinations between available modulations, data rates and antenna ports (if EUT with antenna diversity architecture).
- Following channel(s) was (were) selected for the final test as listed below.

CDD Mode						
Mode	FREQ. Band (MHz)	Available Channel	Tested Channel	Modulation Technology	Modulation Type	Data Rate Parameter
802.11a	5180-5240 5745-5825	36 to 48 149 to 165	48	OFDM	BPSK	6Mb/s

Power Line Conducted Emission Test:

- Pre-Scan has been conducted to determine the worst-case mode from all possible combinations between available modulations, data rates and antenna ports (if EUT with antenna diversity architecture).
- Following channel(s) was (were) selected for the final test as listed below.

CDD Mode						
Mode	FREQ. Band (MHz)	Available Channel	Tested Channel	Modulation Technology	Modulation Type	Data Rate Parameter
802.11a	5180-5240 5745-5825	36 to 48 149 to 165	48	OFDM	BPSK	6Mb/s

Antenna Port Conducted Measurement:

- This item includes all test value of each mode, but only includes spectrum plot of worst value of each mode.
- Pre-Scan has been conducted to determine the worst-case mode from all possible combinations between available modulations, data rates and antenna ports (if EUT with antenna diversity architecture).
- Following channel(s) was (were) selected for the final test as listed below.

CDD Mode						
Mode	FREQ. Band (MHz)	Available Channel	Tested Channel	Modulation Technology	Modulation Type	Data Rate Parameter
802.11a	5180-5240	36 to 48	36, 40, 48	OFDM	BPSK	6Mb/s
802.11ac (VHT20) (output power only)		36 to 48	36, 40, 48	OFDM	BPSK	MCS0
802.11ac (VHT20) (output power only)		38 to 46	38, 46	OFDM	BPSK	MCS0
802.11ac (VHT80) (output power only)		42	42	OFDM	BPSK	MCS0
802.11ax (HE20)		36 to 48	36, 40, 48	OFDMA	BPSK	MCS0
802.11ax (HE40)		38 to 46	38, 46	OFDMA	BPSK	MCS0
802.11ax (HE80)		42	42	OFDMA	BPSK	MCS0
802.11a		5745-5825	149 to 165	149, 157, 165	OFDM	BPSK
802.11ac (VHT20) (output power only)	149 to 165		149, 157, 165	OFDM	BPSK	MCS0
802.11ac (VHT40) (output power only)	151 to 159		151, 159	OFDM	BPSK	MCS0
802.11ac (VHT80) (output power only)	155		155	OFDM	BPSK	MCS0
802.11ax (HE20)	149 to 165		149, 157, 165	OFDMA	BPSK	MCS0
802.11ax (HE40)	151 to 159		151, 159	OFDMA	BPSK	MCS0
802.11ax (HE80)	155		155	OFDMA	BPSK	MCS0

Beamforming Mode (output power only)

MODE	AVAILABLE CHANNEL	TESTED CHANNEL	MODULATION TECHNOLOGY	MODULATION TYPE	Data Rate Parameter	
802.11ac (VHT20)	5180-5240	36 to 48	36, 40, 48	OFDM	BPSK	MCS0
802.11ac (VHT40)		38 to 46	38, 46	OFDM	BPSK	MCS0
802.11ac (VHT80)		42	42	OFDM	BPSK	MCS0
802.11ax (HE20)		36 to 48	36, 40, 48	OFDMA	BPSK	MCS0
802.11ax (HE40)		38 to 46	38, 46	OFDMA	BPSK	MCS0
802.11ax (HE80)		42	42	OFDMA	BPSK	MCS0
802.11ac (VHT20)	5745-5825	149 to 165	149, 157, 165	OFDM	BPSK	MCS0
802.11ac (VHT40)		151 to 159	151, 159	OFDM	BPSK	MCS0
802.11ac (VHT80)		155	155	OFDM	BPSK	MCS0
802.11ax (HE20)		149 to 165	149, 157, 165	OFDMA	BPSK	MCS0
802.11ax (HE40)		151 to 159	151, 159	OFDMA	BPSK	MCS0
802.11ax (HE80)		155	155	OFDMA	BPSK	MCS0

Test Condition:

Applicable To	Environmental Conditions	Input Power	Tested By
RE \geq 1G	25deg. C, 68%RH	120Vac, 60Hz	Ryan Du
RE $<$ 1G	25deg. C, 67%RH	120Vac, 60Hz	Tom Yang
PLC	25deg. C, 64%RH	120Vac, 60Hz	Sampson Chen
APCM	25deg. C, 60%RH	120Vac, 60Hz	Kevin Ko

3.3 Duty Cycle of Test Signal

Duty cycle of test signal is < 98 %, duty factor shall be considered.

802.11a: Duty cycle = 1.97 ms/2.139 ms = 0.921, Duty factor = 10 * log (1/Duty cycle) = 0.36 dB

802.11ax (HE20): Duty cycle = 5.426 ms/5.713 ms = 0.95, Duty factor = 10 * log (1/Duty cycle) = 0.22 dB

802.11ax (HE40): Duty cycle = 5.438 ms/5.733 ms = 0.949, Duty factor = 10 * log (1/Duty cycle) = 0.23 dB

802.11ax (HE80): Duty cycle = 5.432 ms/5.717 ms = 0.95, Duty factor = 10 * log (1/Duty cycle) = 0.22 dB

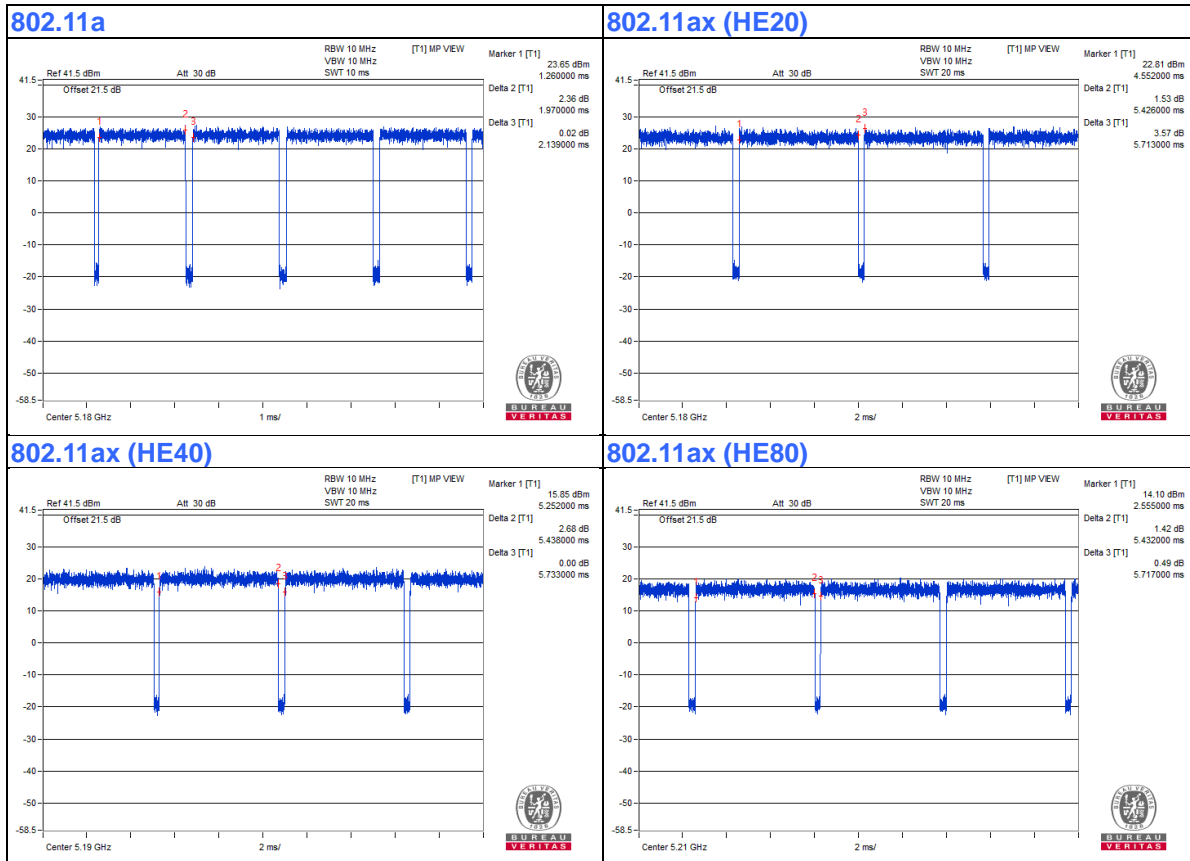

3.4 Description of Support Units

The EUT has been tested as an independent unit together with other necessary accessories or support units. The following support units or accessories were used to form a representative test configuration during the tests.

ID	Product	Brand	Model No.	Serial No.	FCC ID	Remarks
A.	Laptop	Dell	E5430	HYV4VY1	FCC DoC	Provided by Lab
B.	Laptop	Dell	E6420	B92T3R1	FCC DoC	Provided by Lab

Note:

- All power cords of the above support units are non-shielded (1.8m).

ID	Descriptions	Qty.	Length (m)	Shielding (Yes/No)	Cores (Qty.)	Remarks
1.	RJ-45 Cable	1	10	No	0	Provided by Lab
2.	RJ-45 Cable	1	10	No	0	Provided by Lab
3.	DC Cable	1	1.2	No	0	Supplied by client

3.4.1 Configuration of System under Test

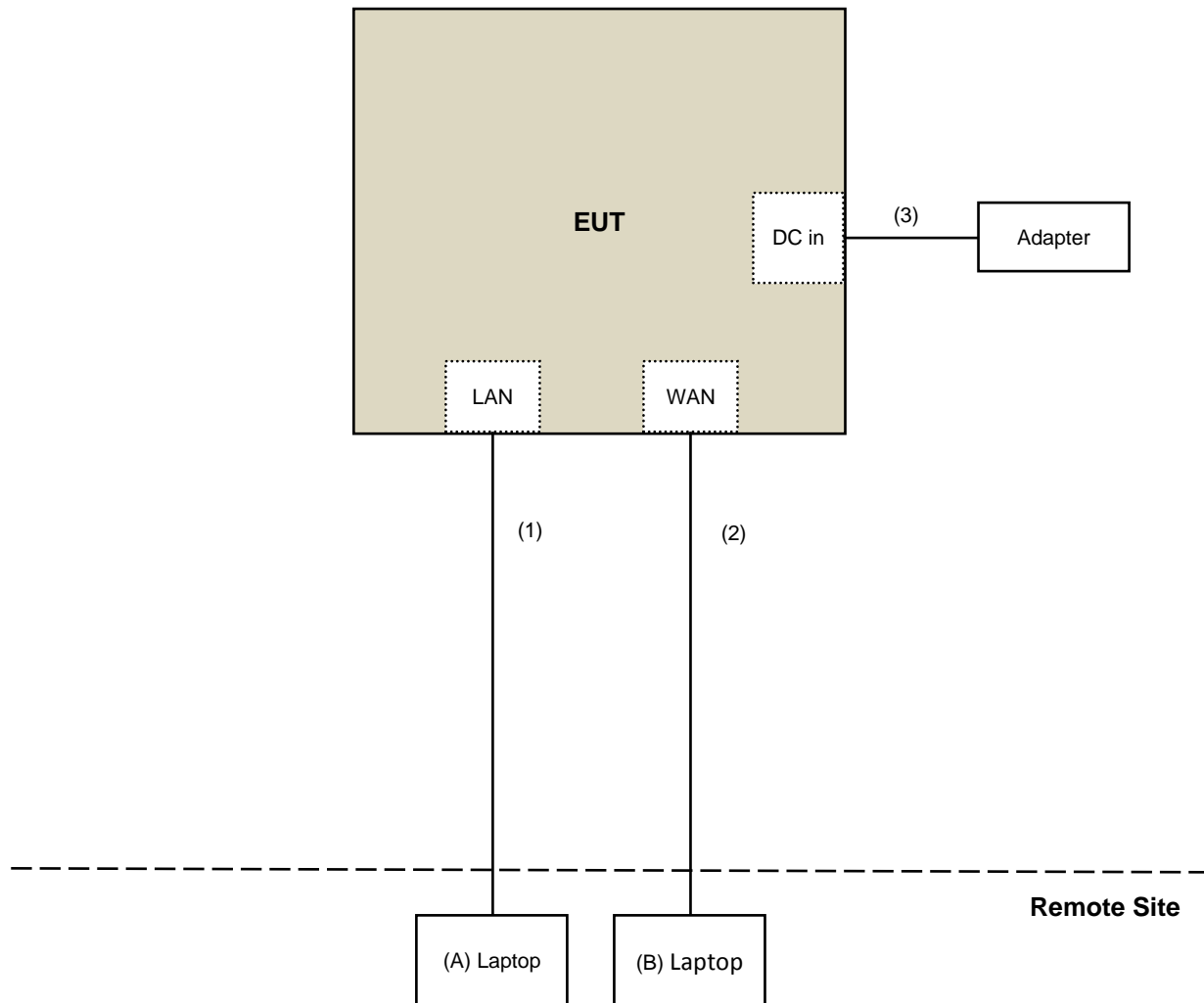

3.5 General Description of Applied Standard and references

The EUT is a RF Product. According to the specifications of the manufacturer, it must comply with the requirements of the following standards and references:

Test Standard:

FCC Part 15, Subpart E (15.407)
ANSI C63.10-2013

All test items have been performed and recorded as per the above standards.

References Test Guidance:

KDB 789033 D02 General UNII Test Procedure New Rules v02r01
KDB 662911 D01 Multiple Transmitter Output v02r01

All test items have been performed as a reference to the above KDB test guidance.

4 Test Types and Results

4.1 Radiated Emission and Bandedge Measurement

4.1.1 Limits of Radiated Emission and Bandedge Measurement

Radiated emissions which fall in the restricted bands must comply with the radiated emission limits specified as below table.

Frequencies (MHz)	Field Strength (microvolts/meter)	Measurement Distance (meters)
0.009 ~ 0.490	2400/F(kHz)	300
0.490 ~ 1.705	24000/F(kHz)	30
1.705 ~ 30.0	30	30
30 ~ 88	100	3
88 ~ 216	150	3
216 ~ 960	200	3
Above 960	500	3

NOTE:

1. The lower limit shall apply at the transition frequencies.
2. Emission level (dBuV/m) = 20 log Emission level (uV/m).
3. For frequencies above 1000MHz, the field strength limits are based on average detector, however, the peak field strength of any emission shall not exceed the maximum permitted average limits, specified above by more than 20dB under any condition of modulation.

Limits of unwanted emission out of the restricted bands

Applicable To		Limit	
789033 D02 General UNII Test Procedure New Rules v02r01		Field Strength at 3m	
		PK:74 (dBuV/m)	AV:54 (dBuV/m)
Frequency Band	Applicable To	EIRP Limit	Equivalent Field Strength at 3m
5150~5250 MHz	15.407(b)(1)	PK:-27 (dBm/MHz)	PK:68.2(dBuV/m)
5250~5350 MHz	15.407(b)(2)		
5470~5725 MHz	15.407(b)(3)		
5725~5850 MHz	15.407(b)(4)(i)	PK:-27 (dBm/MHz) ^{*1} PK:10 (dBm/MHz) ^{*2} PK:15.6 (dBm/MHz) ^{*3} PK:27 (dBm/MHz) ^{*4}	PK: 68.2(dBuV/m) ^{*1} PK:105.2 (dBuV/m) ^{*2} PK: 110.8(dBuV/m) ^{*3} PK:122.2 (dBuV/m) ^{*4}
^{*1} beyond 75 MHz or more above of the band edge.		^{*2} below the band edge increasing linearly to 10 dBm/MHz at 25 MHz above.	
^{*3} below the band edge increasing linearly to a level of 15.6 dBm/MHz at 5 MHz above.		^{*4} from 5 MHz above or below the band edge increasing linearly to a level of 27 dBm/MHz at the band edge.	

Note:

The following formula is used to convert the equipment isotropic radiated power (eirp) to field strength:

$$E = \frac{1000000\sqrt{30P}}{3} \mu\text{V/m, where P is the eirp (Watts).}$$

4.1.2 Test Instruments
 For Radiated emission test

DESCRIPTION & MANUFACTURER	MODEL NO.	SERIAL NO.	CALIBRATED DATE	CALIBRATED UNTIL
Test Receiver Keysight	N9038A	MY54450088	July 06, 2020	July 05, 2021
Pre-Amplifier EMCI	EMC001340	980142	May 25, 2020	May 24, 2021
Loop Antenna Electro-Metrics	EM-6879	264	Feb. 18, 2020	Feb. 17, 2021
RF Cable	NA	LOOPCAB-001	Jan. 08, 2020	Jan. 07, 2021
RF Cable	NA	LOOPCAB-002	Jan. 08, 2020	Jan. 07, 2021
Pre-Amplifier Mini-Circuits	ZFL-1000VH2B	AMP-ZFL-05	Apr. 28, 2020	Apr. 27, 2021
Trilog Broadband Antenna SCHWARZBECK	VULB 9168	9168-361	Nov. 11, 2019	Nov. 10, 2020
RF Cable	8D	966-3-1	Mar. 17, 2020	Mar. 16, 2021
RF Cable	8D	966-3-2	Mar. 17, 2020	Mar. 16, 2021
RF Cable	8D	966-3-3	Mar. 17, 2020	Mar. 16, 2021
Fixed attenuator Mini-Circuits	UNAT-5+	PAD-3m-3-01	Sep. 24, 2020	Sep. 23, 2021
Horn_Antenna SCHWARZBECK	BBHA9120-D	9120D-406	Nov. 24, 2019	Nov. 23, 2020
Pre-Amplifier EMCI	EMC12630SE	980384	Jan. 15, 2020	Jan. 14, 2021
RF Cable	EMC104-SM-SM-1500	180504	Apr. 29, 2020	Apr. 28, 2021
RF Cable	EMC104-SM-SM-2000	180601	June 09, 2020	June 08, 2021
RF Cable	EMC104-SM-SM-6000	180602	June 09, 2020	June 08, 2021
Spectrum Analyzer Keysight	N9030A	MY54490679	July 13, 2020	July 12, 2021
Pre-Amplifier EMCI	EMC184045SE	980387	Jan. 15, 2020	Jan. 14, 2021
Horn_Antenna SCHWARZBECK	BBHA 9170	BBHA9170519	Nov. 24, 2019	Nov. 23, 2020
RF Cable	EMC102-KM-KM-1200	160924	Jan. 15, 2020	Jan. 14, 2021
RF Cable	EMC-KM-KM-4000	200214	Mar. 11, 2020	Mar. 10, 2021
Software	ADT_Radiated_V8.7.08	NA	NA	NA
Antenna Tower & Turn Table Max-Full	MF-7802	MF780208406	NA	NA
Boresight Antenna Fixture	FBA-01	FBA-SIP01	NA	NA

Note:

1. The calibration interval of the above test instruments is 12 months and the calibrations are traceable to NML/ROC and NIST/USA.
2. The test was performed in 966 Chamber No. 3.
3. Tested Date: Oct. 07, 2020

For Bandedge test

DESCRIPTION & MANUFACTURER	MODEL NO.	SERIAL NO.	CALIBRATED DATE	CALIBRATED UNTIL
Test Receiver Keysight	N9038A	MY54450088	July 06, 2020	July 05, 2021
Horn_Antenna SCHWARZBECK	BBHA9120-D	9120D-406	Nov. 24, 2019	Nov. 23, 2020
Pre-Amplifier EMCI	EMC12630SE	980384	Jan. 15, 2020	Jan. 14, 2021
RF Cable	EMC104-SM-SM-1500	180504	Apr. 29, 2020	Apr. 28, 2021
RF Cable	EMC104-SM-SM-2000	180601	June 09, 2020	June 08, 2021
RF Cable	EMC104-SM-SM-6000	180602	June 09, 2020	June 08, 2021
Spectrum Analyzer Keysight	N9030A	MY54490679	July 13, 2020	July 12, 2021
Pre-Amplifier EMCI	EMC184045SE	980387	Jan. 15, 2020	Jan. 14, 2021
Horn_Antenna SCHWARZBECK	BBHA 9170	BBHA9170519	Nov. 24, 2019	Nov. 23, 2020
RF Cable	EMC102-KM-KM-1200	160924	Jan. 15, 2020	Jan. 14, 2021
RF Cable	EMC-KM-KM-4000	200214	Mar. 11, 2020	Mar. 10, 2021
Software	ADT_Radiated_V8.7.08	NA	NA	NA
Antenna Tower & Turn Table Max-Full	MF-7802	MF780208406	NA	NA
Boresight Antenna Fixture	FBA-01	FBA-SIP01	NA	NA

Note:

1. The calibration interval of the above test instruments is 12 months and the calibrations are traceable to NML/ROC and NIST/USA.
2. The test was performed in 966 Chamber No. 3.
3. Tested Date: Sep. 23 to 26, 2020

For other test

DESCRIPTION & MANUFACTURER	MODEL NO.	SERIAL NO.	CALIBRATED DATE	CALIBRATED UNTIL
Spectrum Analyzer R&S	FSV40	100964	May 29, 2020	May 28, 2021
Power meter Anritsu	ML2495A	1529002	July 22, 2020	July 21, 2021
Power sensor Anritsu	MA2411B	1339443	July 22, 2020	July 21, 2021
Fixed Attenuator Mini-Circuits	MDCS18N-10	MDCS18N-10-01	Apr. 14, 2020	Apr. 13, 2021
AC Power Source Extech Electronics	6205	1440452	NA	NA
Temperature & Humidity Chamber Giant Force	GTH-150-40-SP-AR	MAA0812-008	Jan. 16, 2020	Jan. 15, 2021
True RMS Clamp Meter FLUKE	325	31130711WS	June 06, 2020	June 05, 2021
Software	ADT_RF Test Software V6.6.5.4	NA	NA	NA

- NOTE:**
1. The test was performed in Oven room 2.
 2. The calibration interval of the above test instruments is 12 months and the calibrations are traceable to NML/ROC and NIST/USA.
 3. Tested Date: Oct. 07, 2020

4.1.3 Test Procedure

For Radiated emission below 30MHz

- a. The EUT was placed on the top of a rotating table 0.8 meters above the ground at a 3 meter chamber room. The table was rotated 360 degrees to determine the position of the highest radiation.
- b. The EUT was set 3 meters away from the interference-receiving antenna, which was mounted on the top of a variable-height antenna tower.
- c. Parallel, perpendicular, and ground-parallel orientations of the antenna are set to make the measurement.
- d. For each suspected emission, the EUT was arranged to its worst case and the rotatable table was turned from 0 degrees to 360 degrees to find the maximum reading.
- e. The test-receiver system was set to Quasi-Peak Detect Function and Specified Bandwidth with Maximum Hold Mode.

Note:

1. The resolution bandwidth and video bandwidth of test receiver/spectrum analyzer is 9kHz at frequency below 30MHz.

For Radiated emission above 30MHz

- a. The EUT was placed on the top of a rotating table 0.8 meters (for 30MHz ~ 1GHz) / 1.5 meters (for above 1GHz) above the ground at 3 meter chamber room for test. The table was rotated 360 degrees to determine the position of the highest radiation.
- b. The EUT was set 3 meters away from the interference-receiving antenna, which was mounted on the top of a variable-height antenna tower.
- c. The height of antenna is varied from one meter to four meters above the ground to determine the maximum value of the field strength. Both horizontal and vertical polarizations of the antenna are set to make the measurement.
- d. For each suspected emission, the EUT was arranged to its worst case and then the antenna was tuned to heights from 1 meter to 4 meters and the rotatable table was turned from 0 degrees to 360 degrees to find the maximum reading.
- e. The test-receiver system was set to quasi-peak detect function and specified bandwidth with maximum hold mode when the test frequency is below 1 GHz.
- f. The test-receiver system was set to peak and average detects function and specified bandwidth with maximum hold mode when the test frequency is above 1 GHz. If the peak reading value also meets average limit, measurement with the average detector is unnecessary.

Note:

1. The resolution bandwidth and video bandwidth of test receiver/spectrum analyzer is 120kHz for Quasi-peak detection (QP) at frequency below 1GHz.
2. The resolution bandwidth of test receiver/spectrum analyzer is 1 MHz and the video bandwidth is 3 MHz for Peak detection (PK) at frequency above 1GHz.
3. The resolution bandwidth of test receiver/spectrum analyzer is 1MHz and the video bandwidth is $\geq 1/T$ (Duty cycle < 98%) or 10Hz (Duty cycle $\geq 98\%$) for Average detection (AV) at frequency above 1GHz.
4. All modes of operation were investigated and the worst-case emissions are reported.

4.1.4 Deviation from Test Standard

No deviation.

4.1.5 Test Setup

For Radiated emission below 30MHz

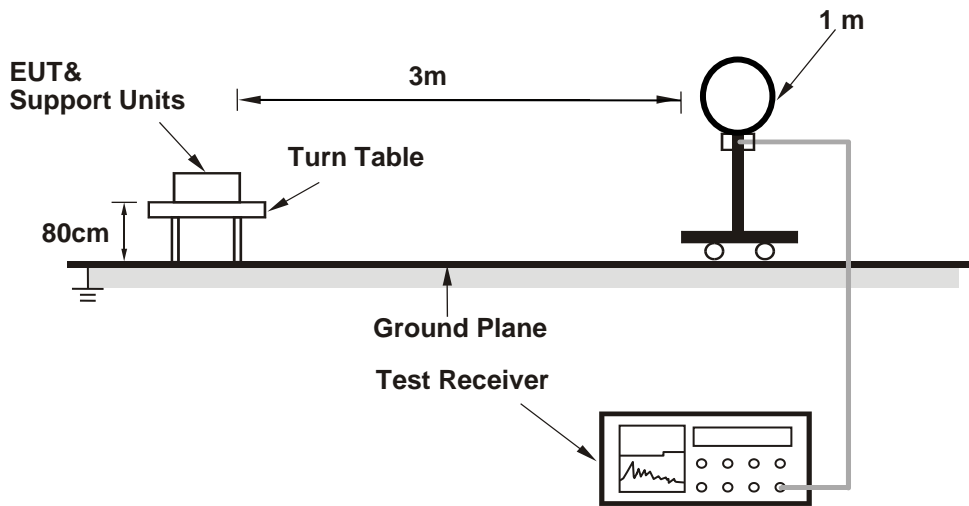

For Radiated emission 30MHz to 1GHz

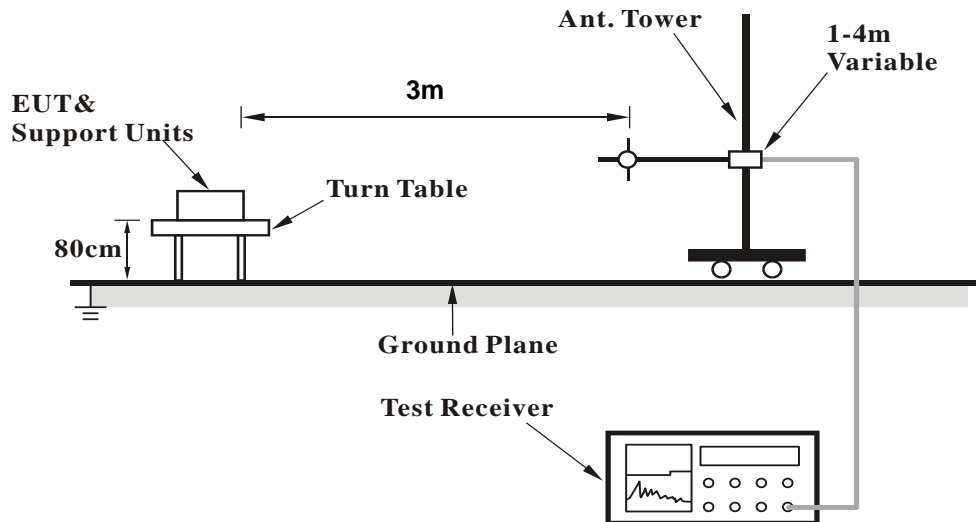

For Radiated emission above 1GHz

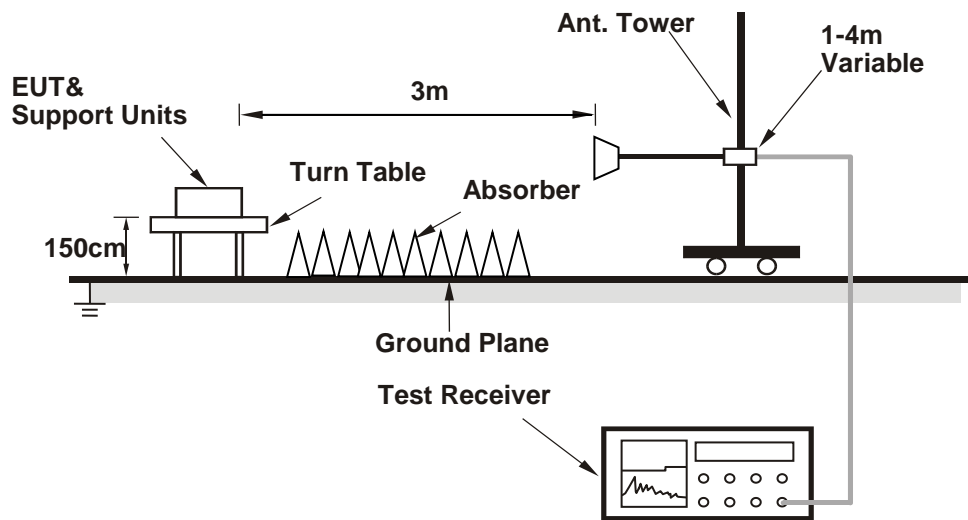

For the actual test configuration, please refer to the attached file (Test Setup Photo).

4.1.6 EUT Operating Condition

- a. Connected the EUT with the Laptop Computer which is placed on remote site.
- b. Controlling software (AX14_Tx_Rx_CONTROL_V1.2.exe) has been activated to set the EUT under transmission condition continuously at specific channel frequency.

4.1.7 Test Results

Above 1GHz Data:

802.11a

Channel	TX Channel 36	Detector Function	Peak (PK)
Frequency Range	1GHz ~ 40GHz		Average (AV)

Antenna Polarity & Test Distance : Horizontal at 3 m								
No	Frequency (MHz)	Emission Level (dBuV/m)	Limit (dBuV/m)	Margin (dB)	Antenna Height (m)	Table Angle (Degree)	Raw Value (dBuV)	Correction Factor (dB/m)
1	5148.20	60.0 PK	74.0	-14.0	3.82 H	293	55.8	4.2
2	5148.20	49.5 AV	54.0	-4.5	3.82 H	293	45.3	4.2
3	*5180.00	111.6 PK			3.82 H	293	107.5	4.1
4	*5180.00	101.1 AV			3.82 H	293	97.0	4.1
5	#10360.00	47.6 PK	68.2	-20.6	1.70 H	251	34.4	13.2
6	15540.00	46.3 PK	74.0	-27.7	2.34 H	181	32.6	13.7
7	15540.00	34.4 AV	54.0	-19.6	2.34 H	181	20.7	13.7

Antenna Polarity & Test Distance : Vertical at 3 m								
No	Frequency (MHz)	Emission Level (dBuV/m)	Limit (dBuV/m)	Margin (dB)	Antenna Height (m)	Table Angle (Degree)	Raw Value (dBuV)	Correction Factor (dB/m)
1	5148.20	61.7 PK	74.0	-12.3	1.00 V	72	57.5	4.2
2	5148.20	53.9 AV	54.0	-0.1	1.00 V	72	49.7	4.2
3	*5180.00	116.5 PK			1.00 V	72	112.4	4.1
4	*5180.00	108.5 AV			1.00 V	72	104.4	4.1
5	#10360.00	46.5 PK	68.2	-21.7	1.63 V	289	33.3	13.2
6	15540.00	46.0 PK	74.0	-28.0	1.43 V	83	32.3	13.7
7	15540.00	35.2 AV	54.0	-18.8	1.43 V	83	21.5	13.7

Remarks:

1. Emission Level(dBuV/m) = Raw Value(dBuV) + Correction Factor(dB/m)
2. Correction Factor(dB/m) = Antenna Factor(dB/m) + Cable Factor(dB) – Pre-Amplifier Factor(dB)
3. Margin value = Emission Level – Limit value
4. The other emission levels were very low against the limit.
5. " * ": Fundamental frequency.
6. " # ": The radiated frequency is out of the restricted band.

Channel	TX Channel 40	Detector Function	Peak (PK)
Frequency Range	1GHz ~ 40GHz		Average (AV)

Antenna Polarity & Test Distance : Horizontal at 3 m

No	Frequency (MHz)	Emission Level (dBuV/m)	Limit (dBuV/m)	Margin (dB)	Antenna Height (m)	Table Angle (Degree)	Raw Value (dBuV)	Correction Factor (dB/m)
1	*5200.00	113.3 PK			3.79 H	282	109.4	3.9
2	*5200.00	105.3 AV			3.79 H	282	101.4	3.9
3	#10400.00	47.5 PK	68.2	-20.7	1.68 H	239	34.3	13.2
4	15600.00	46.5 PK	74.0	-27.5	2.40 H	168	32.5	14.0
5	15600.00	34.3 AV	54.0	-19.7	2.40 H	168	20.3	14.0

Antenna Polarity & Test Distance : Vertical at 3 m

No	Frequency (MHz)	Emission Level (dBuV/m)	Limit (dBuV/m)	Margin (dB)	Antenna Height (m)	Table Angle (Degree)	Raw Value (dBuV)	Correction Factor (dB/m)
1	*5200.00	119.4 PK			1.01 V	66	115.5	3.9
2	*5200.00	110.8 AV			1.01 V	66	106.9	3.9
3	#10400.00	46.6 PK	68.2	-21.6	1.57 V	294	33.4	13.2
4	15600.00	45.9 PK	74.0	-28.1	1.44 V	84	31.9	14.0
5	15600.00	35.1 AV	54.0	-18.9	1.44 V	84	21.1	14.0

Remarks:

1. Emission Level(dBuV/m) = Raw Value(dBuV) + Correction Factor(dB/m)
2. Correction Factor(dB/m) = Antenna Factor(dB/m) + Cable Factor(dB) – Pre-Amplifier Factor(dB)
3. Margin value = Emission Level – Limit value
4. The other emission levels were very low against the limit.
5. " * ": Fundamental frequency.
6. " # ": The radiated frequency is out of the restricted band.

Channel	TX Channel 48	Detector Function	Peak (PK)
Frequency Range	1GHz ~ 40GHz		Average (AV)

Antenna Polarity & Test Distance : Horizontal at 3 m

No	Frequency (MHz)	Emission Level (dBuV/m)	Limit (dBuV/m)	Margin (dB)	Antenna Height (m)	Table Angle (Degree)	Raw Value (dBuV)	Correction Factor (dB/m)
1	*5240.00	113.5 PK			3.18 H	282	109.6	3.9
2	*5240.00	105.3 AV			3.18 H	282	101.4	3.9
3	5350.00	49.2 PK	74.0	-24.8	3.18 H	282	45.5	3.7
4	5350.00	39.0 AV	54.0	-15.0	3.18 H	282	35.3	3.7
5	#10480.00	47.3 PK	68.2	-20.9	1.66 H	247	33.8	13.5
6	15720.00	46.2 PK	74.0	-27.8	2.34 H	180	31.7	14.5
7	15720.00	34.1 AV	54.0	-19.9	2.34 H	180	19.6	14.5

Antenna Polarity & Test Distance : Vertical at 3 m

No	Frequency (MHz)	Emission Level (dBuV/m)	Limit (dBuV/m)	Margin (dB)	Antenna Height (m)	Table Angle (Degree)	Raw Value (dBuV)	Correction Factor (dB/m)
1	*5240.00	118.9 PK			1.04 V	66	115.0	3.9
2	*5240.00	110.5 AV			1.04 V	66	106.6	3.9
3	5350.00	52.8 PK	74.0	-21.2	1.04 V	66	49.1	3.7
4	5350.00	43.1 AV	54.0	-10.9	1.04 V	66	39.4	3.7
5	#10480.00	46.6 PK	68.2	-21.6	1.60 V	308	33.1	13.5
6	15720.00	46.6 PK	74.0	-27.4	1.47 V	73	32.1	14.5
7	15720.00	35.7 AV	54.0	-18.3	1.47 V	73	21.2	14.5

Remarks:

1. Emission Level(dBuV/m) = Raw Value(dBuV) + Correction Factor(dB/m)
2. Correction Factor(dB/m) = Antenna Factor(dB/m) + Cable Factor(dB) – Pre-Amplifier Factor(dB)
3. Margin value = Emission Level – Limit value
4. The other emission levels were very low against the limit.
5. " * ": Fundamental frequency.
6. " # ": The radiated frequency is out of the restricted band.

Channel	TX Channel 149	Detector Function	Peak (PK)
Frequency Range	1GHz ~ 40GHz		Average (AV)

Antenna Polarity & Test Distance : Horizontal at 3 m

No	Frequency (MHz)	Emission Level (dBuV/m)	Limit (dBuV/m)	Margin (dB)	Antenna Height (m)	Table Angle (Degree)	Raw Value (dBuV)	Correction Factor (dB/m)
1	#5618.19	51.6 PK	68.2	-16.6	1.30 H	340	47.3	4.3
2	*5745.00	111.2 PK			1.30 H	340	106.8	4.4
3	*5745.00	103.0 AV			1.30 H	340	98.6	4.4
4	#5933.52	52.4 PK	68.2	-15.8	1.30 H	340	47.5	4.9
5	11490.00	47.4 PK	74.0	-26.6	1.58 H	70	33.5	13.9
6	11490.00	35.6 AV	54.0	-18.4	1.58 H	70	21.7	13.9
7	#17235.00	50.9 PK	68.2	-17.3	1.68 H	234	32.6	18.3

Antenna Polarity & Test Distance : Vertical at 3 m

No	Frequency (MHz)	Emission Level (dBuV/m)	Limit (dBuV/m)	Margin (dB)	Antenna Height (m)	Table Angle (Degree)	Raw Value (dBuV)	Correction Factor (dB/m)
1	#5599.97	55.6 PK	68.2	-12.6	1.50 V	307	51.3	4.3
2	*5745.00	117.4 PK			1.50 V	307	113.0	4.4
3	*5745.00	109.2 AV			1.50 V	307	104.8	4.4
4	#5990.31	52.9 PK	68.2	-15.3	1.50 V	307	47.8	5.1
5	11490.00	47.6 PK	74.0	-26.4	1.71 V	253	33.7	13.9
6	11490.00	36.8 AV	54.0	-17.2	1.71 V	253	22.9	13.9
7	#17235.00	49.8 PK	68.2	-18.4	1.34 V	198	31.5	18.3

Remarks:

1. Emission Level(dBuV/m) = Raw Value(dBuV) + Correction Factor(dB/m)
2. Correction Factor(dB/m) = Antenna Factor(dB/m) + Cable Factor(dB) – Pre-Amplifier Factor(dB)
3. Margin value = Emission Level – Limit value
4. The other emission levels were very low against the limit.
5. " * ": Fundamental frequency.
6. " # ": The radiated frequency is out of the restricted band.

Channel	TX Channel 157	Detector Function	Peak (PK)
Frequency Range	1GHz ~ 40GHz		Average (AV)

Antenna Polarity & Test Distance : Horizontal at 3 m

No	Frequency (MHz)	Emission Level (dBuV/m)	Limit (dBuV/m)	Margin (dB)	Antenna Height (m)	Table Angle (Degree)	Raw Value (dBuV)	Correction Factor (dB/m)
1	#5635.62	51.5 PK	68.2	-16.7	1.36 H	339	47.2	4.3
2	*5785.00	111.2 PK			1.36 H	339	106.7	4.5
3	*5785.00	103.5 AV			1.36 H	339	99.0	4.5
4	#5925.04	52.0 PK	68.2	-16.2	1.36 H	339	47.1	4.9
5	11570.00	48.0 PK	74.0	-26.0	1.57 H	75	34.1	13.9
6	11570.00	36.0 AV	54.0	-18.0	1.57 H	75	22.1	13.9
7	#17355.00	50.9 PK	68.2	-17.3	1.72 H	233	32.7	18.2

Antenna Polarity & Test Distance : Vertical at 3 m

No	Frequency (MHz)	Emission Level (dBuV/m)	Limit (dBuV/m)	Margin (dB)	Antenna Height (m)	Table Angle (Degree)	Raw Value (dBuV)	Correction Factor (dB/m)
1	#5557.07	52.2 PK	68.2	-16.0	1.53 V	316	48.0	4.2
2	*5785.00	116.5 PK			1.53 V	316	112.0	4.5
3	*5785.00	108.8 AV			1.53 V	316	104.3	4.5
4	#6014.38	52.4 PK	68.2	-15.8	1.53 V	316	47.3	5.1
5	11570.00	47.6 PK	74.0	-26.4	1.69 V	241	33.7	13.9
6	11570.00	36.7 AV	54.0	-17.3	1.69 V	241	22.8	13.9
7	#17355.00	50.1 PK	68.2	-18.1	1.31 V	206	31.9	18.2

Remarks:

1. Emission Level(dBuV/m) = Raw Value(dBuV) + Correction Factor(dB/m)
2. Correction Factor(dB/m) = Antenna Factor(dB/m) + Cable Factor(dB) – Pre-Amplifier Factor(dB)
3. Margin value = Emission Level – Limit value
4. The other emission levels were very low against the limit.
5. " * ": Fundamental frequency.
6. " # ": The radiated frequency is out of the restricted band.

Channel	TX Channel 165	Detector Function	Peak (PK)
Frequency Range	1GHz ~ 40GHz		Average (AV)

Antenna Polarity & Test Distance : Horizontal at 3 m

No	Frequency (MHz)	Emission Level (dBuV/m)	Limit (dBuV/m)	Margin (dB)	Antenna Height (m)	Table Angle (Degree)	Raw Value (dBuV)	Correction Factor (dB/m)
1	#5590.20	51.3 PK	68.2	-16.9	1.32 H	328	47.0	4.3
2	*5825.00	111.1 PK			1.32 H	328	106.4	4.7
3	*5825.00	103.3 AV			1.32 H	328	98.6	4.7
4	#6024.56	50.5 PK	68.2	-17.7	1.32 H	328	45.4	5.1
5	11650.00	46.9 PK	74.0	-27.1	1.63 H	85	32.9	14.0
6	11650.00	35.9 AV	54.0	-18.1	1.63 H	85	21.9	14.0
7	#17475.00	51.0 PK	68.2	-17.2	1.68 H	243	32.2	18.8

Antenna Polarity & Test Distance : Vertical at 3 m

No	Frequency (MHz)	Emission Level (dBuV/m)	Limit (dBuV/m)	Margin (dB)	Antenna Height (m)	Table Angle (Degree)	Raw Value (dBuV)	Correction Factor (dB/m)
1	#5626.70	52.4 PK	68.2	-15.8	1.50 V	310	48.1	4.3
2	*5825.00	117.6 PK			1.50 V	310	112.9	4.7
3	*5825.00	109.3 AV			1.50 V	310	104.6	4.7
4	#5937.83	53.9 PK	68.2	-14.3	1.50 V	310	48.9	5.0
5	11650.00	48.2 PK	74.0	-25.8	1.70 V	251	34.2	14.0
6	11650.00	37.1 AV	54.0	-16.9	1.70 V	251	23.1	14.0
7	#17475.00	49.4 PK	68.2	-18.8	1.36 V	201	30.6	18.8

Remarks:

1. Emission Level(dBuV/m) = Raw Value(dBuV) + Correction Factor(dB/m)
2. Correction Factor(dB/m) = Antenna Factor(dB/m) + Cable Factor(dB) – Pre-Amplifier Factor(dB)
3. Margin value = Emission Level – Limit value
4. The other emission levels were very low against the limit.
5. " * ": Fundamental frequency.
6. " # ": The radiated frequency is out of the restricted band.

802.11ax (HE20)

Channel	TX Channel 36	Detector Function	Peak (PK)
Frequency Range	1GHz ~ 40GHz		Average (AV)

Antenna Polarity & Test Distance : Horizontal at 3 m								
No	Frequency (MHz)	Emission Level (dBuV/m)	Limit (dBuV/m)	Margin (dB)	Antenna Height (m)	Table Angle (Degree)	Raw Value (dBuV)	Correction Factor (dB/m)
1	5150.00	55.2 PK	74.0	-18.8	3.84 H	288	51.0	4.2
2	5150.00	48.2 AV	54.0	-5.8	3.84 H	288	44.0	4.2
3	*5180.00	111.1 PK			3.84 H	288	107.0	4.1
4	*5180.00	100.5 AV			3.84 H	288	96.4	4.1
5	#10360.00	47.4 PK	68.2	-20.8	1.61 H	240	34.2	13.2
6	15540.00	46.7 PK	74.0	-27.3	2.35 H	188	33.0	13.7
7	15540.00	34.5 AV	54.0	-19.5	2.35 H	188	20.8	13.7

Antenna Polarity & Test Distance : Vertical at 3 m								
No	Frequency (MHz)	Emission Level (dBuV/m)	Limit (dBuV/m)	Margin (dB)	Antenna Height (m)	Table Angle (Degree)	Raw Value (dBuV)	Correction Factor (dB/m)
1	5146.40	59.9 PK	74.0	-14.1	1.04 V	67	55.7	4.2
2	5146.40	53.6 AV	54.0	-0.4	1.04 V	67	49.4	4.2
3	*5180.00	117.2 PK			1.04 V	67	113.1	4.1
4	*5180.00	106.8 AV			1.04 V	67	102.7	4.1
5	#10360.00	47.8 PK	68.2	-20.4	1.81 V	256	34.6	13.2
6	15540.00	47.4 PK	74.0	-26.6	1.39 V	98	33.7	13.7
7	15540.00	34.9 AV	54.0	-19.1	1.39 V	98	21.2	13.7

Remarks:

1. Emission Level(dBuV/m) = Raw Value(dBuV) + Correction Factor(dB/m)
2. Correction Factor(dB/m) = Antenna Factor(dB/m) + Cable Factor(dB) – Pre-Amplifier Factor(dB)
3. Margin value = Emission Level – Limit value
4. The other emission levels were very low against the limit.
5. " * ": Fundamental frequency.
6. " # ": The radiated frequency is out of the restricted band.

Channel	TX Channel 40	Detector Function	Peak (PK)
Frequency Range	1GHz ~ 40GHz		Average (AV)

Antenna Polarity & Test Distance : Horizontal at 3 m								
No	Frequency (MHz)	Emission Level (dBuV/m)	Limit (dBuV/m)	Margin (dB)	Antenna Height (m)	Table Angle (Degree)	Raw Value (dBuV)	Correction Factor (dB/m)
1	*5200.00	113.4 PK			3.80 H	287	109.5	3.9
2	*5200.00	104.0 AV			3.80 H	287	100.1	3.9
3	#10400.00	46.7 PK	68.2	-21.5	1.69 H	237	33.5	13.2
4	15600.00	46.7 PK	74.0	-27.3	2.33 H	185	32.7	14.0
5	15600.00	34.3 AV	54.0	-19.7	2.33 H	185	20.3	14.0

Antenna Polarity & Test Distance : Vertical at 3 m								
No	Frequency (MHz)	Emission Level (dBuV/m)	Limit (dBuV/m)	Margin (dB)	Antenna Height (m)	Table Angle (Degree)	Raw Value (dBuV)	Correction Factor (dB/m)
1	*5200.00	120.4 PK			1.05 V	82	116.5	3.9
2	*5200.00	110.1 AV			1.05 V	82	106.2	3.9
3	#10400.00	47.9 PK	68.2	-20.3	1.76 V	250	34.7	13.2
4	15600.00	47.1 PK	74.0	-26.9	1.33 V	114	33.1	14.0
5	15600.00	34.5 AV	54.0	-19.5	1.33 V	114	20.5	14.0

Remarks:

1. Emission Level(dBuV/m) = Raw Value(dBuV) + Correction Factor(dB/m)
2. Correction Factor(dB/m) = Antenna Factor(dB/m) + Cable Factor(dB) – Pre-Amplifier Factor(dB)
3. Margin value = Emission Level – Limit value
4. The other emission levels were very low against the limit.
5. " * ": Fundamental frequency.
6. " # ": The radiated frequency is out of the restricted band.

Channel	TX Channel 48	Detector Function	Peak (PK)
Frequency Range	1GHz ~ 40GHz		Average (AV)

Antenna Polarity & Test Distance : Horizontal at 3 m

No	Frequency (MHz)	Emission Level (dBuV/m)	Limit (dBuV/m)	Margin (dB)	Antenna Height (m)	Table Angle (Degree)	Raw Value (dBuV)	Correction Factor (dB/m)
1	*5240.00	113.6 PK			3.52 H	278	109.7	3.9
2	*5240.00	104.3 AV			3.52 H	278	100.4	3.9
3	5350.00	50.5 PK	74.0	-23.5	3.52 H	278	46.8	3.7
4	5350.00	41.2 AV	54.0	-12.8	3.52 H	278	37.5	3.7
5	#10480.00	47.7 PK	68.2	-20.5	1.62 H	253	34.2	13.5
6	15720.00	46.0 PK	74.0	-28.0	2.35 H	170	31.5	14.5
7	15720.00	33.9 AV	54.0	-20.1	2.35 H	170	19.4	14.5

Antenna Polarity & Test Distance : Vertical at 3 m

No	Frequency (MHz)	Emission Level (dBuV/m)	Limit (dBuV/m)	Margin (dB)	Antenna Height (m)	Table Angle (Degree)	Raw Value (dBuV)	Correction Factor (dB/m)
1	*5240.00	120.3 PK			1.05 V	66	116.4	3.9
2	*5240.00	110.3 AV			1.05 V	66	106.4	3.9
3	5350.00	53.5 PK	74.0	-20.5	1.05 V	66	49.8	3.7
4	5350.00	42.5 AV	54.0	-11.5	1.05 V	66	38.8	3.7
5	#10480.00	48.0 PK	68.2	-20.2	1.79 V	264	34.5	13.5
6	15720.00	47.3 PK	74.0	-26.7	1.33 V	101	32.8	14.5
7	15720.00	34.6 AV	54.0	-19.4	1.33 V	101	20.1	14.5

Remarks:

1. Emission Level(dBuV/m) = Raw Value(dBuV) + Correction Factor(dB/m)
2. Correction Factor(dB/m) = Antenna Factor(dB/m) + Cable Factor(dB) – Pre-Amplifier Factor(dB)
3. Margin value = Emission Level – Limit value
4. The other emission levels were very low against the limit.
5. " * ": Fundamental frequency.
6. " # ": The radiated frequency is out of the restricted band.

Channel	TX Channel 149	Detector Function	Peak (PK)
Frequency Range	1GHz ~ 40GHz		Average (AV)

Antenna Polarity & Test Distance : Horizontal at 3 m

No	Frequency (MHz)	Emission Level (dBuV/m)	Limit (dBuV/m)	Margin (dB)	Antenna Height (m)	Table Angle (Degree)	Raw Value (dBuV)	Correction Factor (dB/m)
1	#5636.28	51.8 PK	68.2	-16.4	1.42 H	323	47.5	4.3
2	*5745.00	113.7 PK			1.42 H	323	109.3	4.4
3	*5745.00	102.5 AV			1.42 H	323	98.1	4.4
4	#5987.85	51.7 PK	68.2	-16.5	1.42 H	323	46.6	5.1
5	11490.00	47.1 PK	74.0	-26.9	2.07 H	311	33.2	13.9
6	11490.00	35.0 AV	54.0	-19.0	2.07 H	311	21.1	13.9
7	#17235.00	50.2 PK	68.2	-18.0	1.58 H	303	31.9	18.3

Antenna Polarity & Test Distance : Vertical at 3 m

No	Frequency (MHz)	Emission Level (dBuV/m)	Limit (dBuV/m)	Margin (dB)	Antenna Height (m)	Table Angle (Degree)	Raw Value (dBuV)	Correction Factor (dB/m)
1	#5589.98	52.9 PK	68.2	-15.3	1.55 V	306	48.6	4.3
2	*5745.00	118.1 PK			1.55 V	306	113.7	4.4
3	*5745.00	107.8 AV			1.55 V	306	103.4	4.4
4	#5961.81	53.0 PK	68.2	-15.2	1.55 V	306	48.0	5.0
5	11490.00	47.8 PK	74.0	-26.2	1.10 V	98	33.9	13.9
6	11490.00	36.9 AV	54.0	-17.1	1.10 V	98	23.0	13.9
7	#17235.00	50.8 PK	68.2	-17.4	1.52 V	304	32.5	18.3

Remarks:

1. Emission Level(dBuV/m) = Raw Value(dBuV) + Correction Factor(dB/m)
2. Correction Factor(dB/m) = Antenna Factor(dB/m) + Cable Factor(dB) – Pre-Amplifier Factor(dB)
3. Margin value = Emission Level – Limit value
4. The other emission levels were very low against the limit.
5. " * ": Fundamental frequency.
6. " # ": The radiated frequency is out of the restricted band.

Channel	TX Channel 157	Detector Function	Peak (PK)
Frequency Range	1GHz ~ 40GHz		Average (AV)

Antenna Polarity & Test Distance : Horizontal at 3 m

No	Frequency (MHz)	Emission Level (dBuV/m)	Limit (dBuV/m)	Margin (dB)	Antenna Height (m)	Table Angle (Degree)	Raw Value (dBuV)	Correction Factor (dB/m)
1	#5571.03	52.1 PK	68.2	-16.1	1.30 H	293	47.8	4.3
2	*5785.00	113.4 PK			1.30 H	293	108.9	4.5
3	*5785.00	103.4 AV			1.30 H	293	98.9	4.5
4	#5996.52	51.3 PK	68.2	-16.9	1.30 H	293	46.2	5.1
5	11570.00	47.5 PK	74.0	-26.5	2.05 H	297	33.6	13.9
6	11570.00	35.2 AV	54.0	-18.8	2.05 H	297	21.3	13.9
7	#17355.00	50.0 PK	68.2	-18.2	1.55 H	290	31.8	18.2

Antenna Polarity & Test Distance : Vertical at 3 m

No	Frequency (MHz)	Emission Level (dBuV/m)	Limit (dBuV/m)	Margin (dB)	Antenna Height (m)	Table Angle (Degree)	Raw Value (dBuV)	Correction Factor (dB/m)
1	#5587.13	51.7 PK	68.2	-16.5	1.48 V	316	47.4	4.3
2	*5785.00	117.7 PK			1.48 V	316	113.2	4.5
3	*5785.00	107.8 AV			1.48 V	316	103.3	4.5
4	#5944.69	53.9 PK	68.2	-14.3	1.48 V	316	49.0	4.9
5	11570.00	47.5 PK	74.0	-26.5	1.14 V	96	33.6	13.9
6	11570.00	36.4 AV	54.0	-17.6	1.14 V	96	22.5	13.9
7	#17355.00	51.2 PK	68.2	-17.0	1.48 V	317	33.0	18.2

Remarks:

1. Emission Level(dBuV/m) = Raw Value(dBuV) + Correction Factor(dB/m)
2. Correction Factor(dB/m) = Antenna Factor(dB/m) + Cable Factor(dB) – Pre-Amplifier Factor(dB)
3. Margin value = Emission Level – Limit value
4. The other emission levels were very low against the limit.
5. " * ": Fundamental frequency.
6. " # ": The radiated frequency is out of the restricted band.

Channel	TX Channel 165	Detector Function	Peak (PK)
Frequency Range	1GHz ~ 40GHz		Average (AV)

Antenna Polarity & Test Distance : Horizontal at 3 m

No	Frequency (MHz)	Emission Level (dBuV/m)	Limit (dBuV/m)	Margin (dB)	Antenna Height (m)	Table Angle (Degree)	Raw Value (dBuV)	Correction Factor (dB/m)
1	#5641.43	51.2 PK	68.2	-17.0	1.22 H	289	46.9	4.3
2	*5825.00	113.9 PK			1.22 H	289	109.2	4.7
3	*5825.00	102.5 AV			1.22 H	289	97.8	4.7
4	#5965.22	52.6 PK	68.2	-15.6	1.22 H	289	47.6	5.0
5	11650.00	47.2 PK	74.0	-26.8	2.09 H	303	33.2	14.0
6	11650.00	34.8 AV	54.0	-19.2	2.09 H	303	20.8	14.0
7	#17475.00	49.8 PK	68.2	-18.4	1.59 H	286	31.0	18.8

Antenna Polarity & Test Distance : Vertical at 3 m

No	Frequency (MHz)	Emission Level (dBuV/m)	Limit (dBuV/m)	Margin (dB)	Antenna Height (m)	Table Angle (Degree)	Raw Value (dBuV)	Correction Factor (dB/m)
1	#5634.80	53.7 PK	68.2	-14.5	1.51 V	314	49.4	4.3
2	*5825.00	118.0 PK			1.51 V	314	113.3	4.7
3	*5825.00	108.0 AV			1.51 V	314	103.3	4.7
4	#6003.36	53.8 PK	68.2	-14.4	1.51 V	314	48.7	5.1
5	11650.00	47.3 PK	74.0	-26.7	1.08 V	111	33.3	14.0
6	11650.00	36.5 AV	54.0	-17.5	1.08 V	111	22.5	14.0
7	#17475.00	50.6 PK	68.2	-17.6	1.52 V	314	31.8	18.8

Remarks:

1. Emission Level(dBuV/m) = Raw Value(dBuV) + Correction Factor(dB/m)
2. Correction Factor(dB/m) = Antenna Factor(dB/m) + Cable Factor(dB) – Pre-Amplifier Factor(dB)
3. Margin value = Emission Level – Limit value
4. The other emission levels were very low against the limit.
5. " * ": Fundamental frequency.
6. " # ": The radiated frequency is out of the restricted band.

802.11ax (HE40)

Channel	TX Channel 38	Detector Function	Peak (PK)
Frequency Range	1GHz ~ 40GHz		Average (AV)

Antenna Polarity & Test Distance : Horizontal at 3 m

No	Frequency (MHz)	Emission Level (dBuV/m)	Limit (dBuV/m)	Margin (dB)	Antenna Height (m)	Table Angle (Degree)	Raw Value (dBuV)	Correction Factor (dB/m)
1	5147.50	55.7 PK	74.0	-18.3	3.88 H	290	51.5	4.2
2	5147.50	48.5 AV	54.0	-5.5	3.88 H	290	44.3	4.2
3	*5190.00	108.2 PK			3.88 H	290	104.1	4.1
4	*5190.00	97.0 AV			3.88 H	290	92.9	4.1
5	#10380.00	47.4 PK	68.2	-20.8	1.61 H	240	34.2	13.2
6	15570.00	46.6 PK	74.0	-27.4	2.39 H	189	32.8	13.8
7	15570.00	34.5 AV	54.0	-19.5	2.39 H	189	20.7	13.8

Antenna Polarity & Test Distance : Vertical at 3 m

No	Frequency (MHz)	Emission Level (dBuV/m)	Limit (dBuV/m)	Margin (dB)	Antenna Height (m)	Table Angle (Degree)	Raw Value (dBuV)	Correction Factor (dB/m)
1	5150.00	60.6 PK	74.0	-13.4	1.07 V	66	56.4	4.2
2	5150.00	53.7 AV	54.0	-0.3	1.07 V	66	49.5	4.2
3	*5190.00	112.2 PK			1.07 V	66	108.1	4.1
4	*5190.00	101.1 AV			1.07 V	66	97.0	4.1
5	#10380.00	47.9 PK	68.2	-20.3	1.86 V	251	34.7	13.2
6	15570.00	47.2 PK	74.0	-26.8	1.44 V	100	33.4	13.8
7	15570.00	34.9 AV	54.0	-19.1	1.44 V	100	21.1	13.8

Remarks:

1. Emission Level(dBuV/m) = Raw Value(dBuV) + Correction Factor(dB/m)
2. Correction Factor(dB/m) = Antenna Factor(dB/m) + Cable Factor(dB) – Pre-Amplifier Factor(dB)
3. Margin value = Emission Level – Limit value
4. The other emission levels were very low against the limit.
5. " * ": Fundamental frequency.
6. " # ": The radiated frequency is out of the restricted band.

Channel	TX Channel 46	Detector Function	Peak (PK)
Frequency Range	1GHz ~ 40GHz		Average (AV)

Antenna Polarity & Test Distance : Horizontal at 3 m

No	Frequency (MHz)	Emission Level (dBuV/m)	Limit (dBuV/m)	Margin (dB)	Antenna Height (m)	Table Angle (Degree)	Raw Value (dBuV)	Correction Factor (dB/m)
1	5147.45	57.7 PK	74.0	-16.3	3.54 H	279	53.5	4.2
2	5147.45	48.4 AV	54.0	-5.6	3.54 H	279	44.2	4.2
3	*5230.00	112.2 PK			3.54 H	279	108.3	3.9
4	*5230.00	100.7 AV			3.54 H	279	96.8	3.9
5	5350.00	52.4 PK	74.0	-21.6	3.54 H	279	48.7	3.7
6	5350.00	42.0 AV	54.0	-12.0	3.54 H	279	38.3	3.7
7	#10460.00	46.9 PK	68.2	-21.3	1.57 H	229	33.6	13.3
8	15690.00	46.9 PK	74.0	-27.1	2.35 H	187	32.4	14.5
9	15690.00	34.4 AV	54.0	-19.6	2.35 H	187	19.9	14.5

Antenna Polarity & Test Distance : Vertical at 3 m

No	Frequency (MHz)	Emission Level (dBuV/m)	Limit (dBuV/m)	Margin (dB)	Antenna Height (m)	Table Angle (Degree)	Raw Value (dBuV)	Correction Factor (dB/m)
1	5146.30	63.0 PK	74.0	-11.0	1.03 V	66	58.8	4.2
2	5146.30	53.9 AV	54.0	-0.1	1.03 V	66	49.7	4.2
3	*5230.00	116.2 PK			1.03 V	66	112.3	3.9
4	*5230.00	105.7 AV			1.03 V	66	101.8	3.9
5	5355.30	55.7 PK	74.0	-18.3	1.03 V	66	52.0	3.7
6	5355.30	46.0 AV	54.0	-8.0	1.03 V	66	42.3	3.7
7	#10460.00	47.9 PK	68.2	-20.3	1.86 V	252	34.6	13.3
8	15690.00	47.6 PK	74.0	-26.4	1.49 V	85	33.1	14.5
9	15690.00	35.2 AV	54.0	-18.8	1.49 V	85	20.7	14.5

Remarks:

1. Emission Level(dBuV/m) = Raw Value(dBuV) + Correction Factor(dB/m)
2. Correction Factor(dB/m) = Antenna Factor(dB/m) + Cable Factor(dB) – Pre-Amplifier Factor(dB)
3. Margin value = Emission Level – Limit value
4. The other emission levels were very low against the limit.
5. " * ": Fundamental frequency.
6. " # ": The radiated frequency is out of the restricted band.

Channel	TX Channel 151	Detector Function	Peak (PK)
Frequency Range	1GHz ~ 40GHz		Average (AV)

Antenna Polarity & Test Distance : Horizontal at 3 m

No	Frequency (MHz)	Emission Level (dBuV/m)	Limit (dBuV/m)	Margin (dB)	Antenna Height (m)	Table Angle (Degree)	Raw Value (dBuV)	Correction Factor (dB/m)
1	#5649.81	56.1 PK	68.2	-12.1	1.24 H	309	51.7	4.4
2	*5755.00	109.4 PK			1.24 H	309	105.0	4.4
3	*5755.00	100.0 AV			1.24 H	309	95.6	4.4
4	#5964.00	50.9 PK	68.2	-17.3	1.24 H	309	45.9	5.0
5	11510.00	47.1 PK	74.0	-26.9	2.02 H	291	33.1	14.0
6	11510.00	34.8 AV	54.0	-19.2	2.02 H	291	20.8	14.0
7	#17265.00	49.7 PK	68.2	-18.5	1.58 H	285	31.6	18.1

Antenna Polarity & Test Distance : Vertical at 3 m

No	Frequency (MHz)	Emission Level (dBuV/m)	Limit (dBuV/m)	Margin (dB)	Antenna Height (m)	Table Angle (Degree)	Raw Value (dBuV)	Correction Factor (dB/m)
1	#5649.05	57.0 PK	68.2	-11.2	1.54 V	306	52.6	4.4
2	*5755.00	115.3 PK			1.54 V	306	110.9	4.4
3	*5755.00	105.5 AV			1.54 V	306	101.1	4.4
4	#5926.69	54.7 PK	68.2	-13.5	1.54 V	306	49.8	4.9
5	11510.00	47.4 PK	74.0	-26.6	1.10 V	88	33.4	14.0
6	11510.00	36.2 AV	54.0	-17.8	1.10 V	88	22.2	14.0
7	#17265.00	51.8 PK	68.2	-16.4	1.43 V	332	33.7	18.1

Remarks:

1. Emission Level(dBuV/m) = Raw Value(dBuV) + Correction Factor(dB/m)
2. Correction Factor(dB/m) = Antenna Factor(dB/m) + Cable Factor(dB) – Pre-Amplifier Factor(dB)
3. Margin value = Emission Level – Limit value
4. The other emission levels were very low against the limit.
5. " * ": Fundamental frequency.
6. " # ": The radiated frequency is out of the restricted band.

Channel	TX Channel 159	Detector Function	Peak (PK)
Frequency Range	1GHz ~ 40GHz		Average (AV)

Antenna Polarity & Test Distance : Horizontal at 3 m

No	Frequency (MHz)	Emission Level (dBuV/m)	Limit (dBuV/m)	Margin (dB)	Antenna Height (m)	Table Angle (Degree)	Raw Value (dBuV)	Correction Factor (dB/m)
1	#5573.09	51.7 PK	68.2	-16.5	1.26 H	292	47.4	4.3
2	*5795.00	110.2 PK			1.26 H	292	105.6	4.6
3	*5795.00	100.5 AV			1.26 H	292	95.9	4.6
4	#5934.14	52.9 PK	68.2	-15.3	1.26 H	292	48.0	4.9
5	11590.00	47.5 PK	74.0	-26.5	2.02 H	311	33.6	13.9
6	11590.00	35.5 AV	54.0	-18.5	2.02 H	311	21.6	13.9
7	#17385.00	50.5 PK	68.2	-17.7	1.55 H	297	32.1	18.4

Antenna Polarity & Test Distance : Vertical at 3 m

No	Frequency (MHz)	Emission Level (dBuV/m)	Limit (dBuV/m)	Margin (dB)	Antenna Height (m)	Table Angle (Degree)	Raw Value (dBuV)	Correction Factor (dB/m)
1	#5638.67	53.7 PK	68.2	-14.5	1.50 V	308	49.4	4.3
2	*5795.00	115.6 PK			1.50 V	308	111.0	4.6
3	*5795.00	106.1 AV			1.50 V	308	101.5	4.6
4	#5964.38	54.7 PK	68.2	-13.5	1.50 V	308	49.7	5.0
5	11590.00	47.9 PK	74.0	-26.1	1.20 V	97	34.0	13.9
6	11590.00	36.6 AV	54.0	-17.4	1.20 V	97	22.7	13.9
7	#17385.00	50.6 PK	68.2	-17.6	1.46 V	320	32.2	18.4

Remarks:

1. Emission Level(dBuV/m) = Raw Value(dBuV) + Correction Factor(dB/m)
2. Correction Factor(dB/m) = Antenna Factor(dB/m) + Cable Factor(dB) – Pre-Amplifier Factor(dB)
3. Margin value = Emission Level – Limit value
4. The other emission levels were very low against the limit.
5. " * ": Fundamental frequency.
6. " # ": The radiated frequency is out of the restricted band.

802.11ax (HE80)

Channel	TX Channel 42	Detector Function	Peak (PK)
Frequency Range	1GHz ~ 40GHz		Average (AV)

Antenna Polarity & Test Distance : Horizontal at 3 m								
No	Frequency (MHz)	Emission Level (dBuV/m)	Limit (dBuV/m)	Margin (dB)	Antenna Height (m)	Table Angle (Degree)	Raw Value (dBuV)	Correction Factor (dB/m)
1	5141.62	54.4 PK	74.0	-19.6	3.74 H	281	50.2	4.2
2	5141.62	47.1 AV	54.0	-6.9	3.74 H	281	42.9	4.2
3	*5210.00	103.7 PK			3.74 H	281	99.8	3.9
4	*5210.00	93.0 AV			3.74 H	281	89.1	3.9
5	5350.00	49.2 PK	74.0	-24.8	3.74 H	281	45.5	3.7
6	5350.00	40.0 AV	54.0	-14.0	3.74 H	281	36.3	3.7
7	#10420.00	47.3 PK	68.2	-20.9	1.57 H	242	34.1	13.2
8	15630.00	46.4 PK	74.0	-27.6	2.37 H	196	32.1	14.3
9	15630.00	34.1 AV	54.0	-19.9	2.37 H	196	19.8	14.3

Antenna Polarity & Test Distance : Vertical at 3 m								
No	Frequency (MHz)	Emission Level (dBuV/m)	Limit (dBuV/m)	Margin (dB)	Antenna Height (m)	Table Angle (Degree)	Raw Value (dBuV)	Correction Factor (dB/m)
1	5150.00	63.0 PK	74.0	-11.0	1.05 V	66	58.8	4.2
2	5150.00	53.5 AV	54.0	-0.5	1.05 V	66	49.3	4.2
3	*5210.00	107.3 PK			1.05 V	66	103.4	3.9
4	*5210.00	98.5 AV			1.05 V	66	94.6	3.9
5	5350.00	52.2 PK	74.0	-21.8	1.05 V	66	48.5	3.7
6	5350.00	42.8 AV	54.0	-11.2	1.05 V	66	39.1	3.7
7	#10420.00	48.2 PK	68.2	-20.0	1.85 V	239	35.0	13.2
8	15630.00	47.4 PK	74.0	-26.6	1.55 V	95	33.1	14.3
9	15630.00	35.0 AV	54.0	-19.0	1.55 V	95	20.7	14.3

Remarks:

1. Emission Level(dBuV/m) = Raw Value(dBuV) + Correction Factor(dB/m)
2. Correction Factor(dB/m) = Antenna Factor(dB/m) + Cable Factor(dB) – Pre-Amplifier Factor(dB)
3. Margin value = Emission Level – Limit value
4. The other emission levels were very low against the limit.
5. " * ": Fundamental frequency.
6. " # ": The radiated frequency is out of the restricted band.

Channel	TX Channel 155	Detector Function	Peak (PK)
Frequency Range	1GHz ~ 40GHz		Average (AV)

Antenna Polarity & Test Distance : Horizontal at 3 m

No	Frequency (MHz)	Emission Level (dBuV/m)	Limit (dBuV/m)	Margin (dB)	Antenna Height (m)	Table Angle (Degree)	Raw Value (dBuV)	Correction Factor (dB/m)
1	#5646.02	63.0 PK	68.2	-5.2	1.28 H	324	58.7	4.3
2	*5775.00	106.6 PK			1.28 H	324	102.1	4.5
3	*5775.00	95.9 AV			1.28 H	324	91.4	4.5
4	#5943.51	57.9 PK	68.2	-10.3	1.28 H	324	53.0	4.9
5	11550.00	46.6 PK	74.0	-27.4	2.06 H	287	32.7	13.9
6	11550.00	34.5 AV	54.0	-19.5	2.06 H	287	20.6	13.9
7	#17325.00	49.9 PK	68.2	-18.3	1.52 H	273	31.7	18.2

Antenna Polarity & Test Distance : Vertical at 3 m

No	Frequency (MHz)	Emission Level (dBuV/m)	Limit (dBuV/m)	Margin (dB)	Antenna Height (m)	Table Angle (Degree)	Raw Value (dBuV)	Correction Factor (dB/m)
1	#5641.78	65.3 PK	68.2	-2.9	1.57 V	307	61.0	4.3
2	*5775.00	111.1 PK			1.57 V	307	106.6	4.5
3	*5775.00	102.1 AV			1.57 V	307	97.6	4.5
4	#5929.77	61.8 PK	68.2	-6.4	1.57 V	307	56.9	4.9
5	11550.00	48.0 PK	74.0	-26.0	1.26 V	112	34.1	13.9
6	11550.00	36.9 AV	54.0	-17.1	1.26 V	112	23.0	13.9
7	#17325.00	50.9 PK	68.2	-17.3	1.41 V	320	32.7	18.2

Remarks:

1. Emission Level(dBuV/m) = Raw Value(dBuV) + Correction Factor(dB/m)
2. Correction Factor(dB/m) = Antenna Factor(dB/m) + Cable Factor(dB) – Pre-Amplifier Factor(dB)
3. Margin value = Emission Level – Limit value
4. The other emission levels were very low against the limit.
5. " * ": Fundamental frequency.
6. " # ": The radiated frequency is out of the restricted band.

Below 1GHz Data:

802.11a

Channel	TX Channel 48	Detector Function	Quasi-Peak (QP)
Frequency Range	9kHz ~ 1GHz		

Antenna Polarity & Test Distance : Horizontal at 3 m								
No	Frequency (MHz)	Emission Level (dBuV/m)	Limit (dBuV/m)	Margin (dB)	Antenna Height (m)	Table Angle (Degree)	Raw Value (dBuV)	Correction Factor (dB/m)
1	35.55	30.6 QP	40.0	-9.4	3.00 H	360	39.2	-8.6
2	59.66	27.6 QP	40.0	-12.4	2.00 H	91	35.9	-8.3
3	115.09	27.5 QP	43.5	-16.0	3.00 H	126	37.0	-9.5
4	150.91	29.0 QP	43.5	-14.5	2.00 H	253	35.9	-6.9
5	222.06	31.7 QP	46.0	-14.3	2.00 H	38	41.5	-9.8
6	279.02	38.8 QP	46.0	-7.2	1.00 H	103	45.4	-6.6

Remarks:

1. Emission Level(dBuV/m) = Raw Value(dBuV) + Correction Factor(dB/m)
2. Correction Factor(dB/m) = Antenna Factor(dB/m) + Cable Factor(dB) – Pre-Amplifier Factor(dB)
3. Margin value = Emission Level – Limit value
4. The other emission levels were very low against the limit of frequency range 30MHz~1000MHz.
5. The emission levels were very low against the limit of frequency range 9kHz~30MHz: the amplitude of spurious emissions attenuated more than 20 dB below the permissible value to be report.

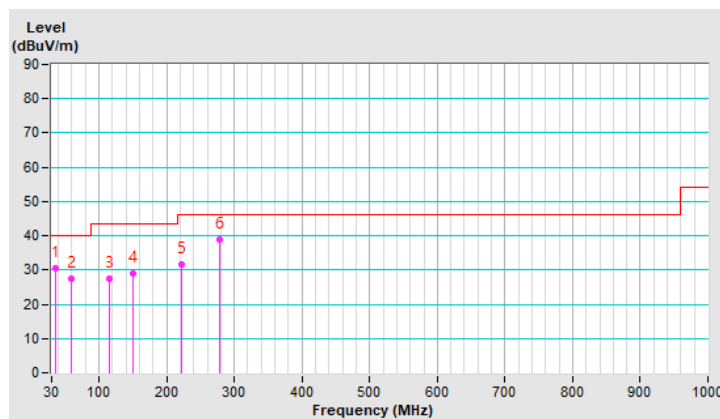

Channel	TX Channel 48	Detector Function	Quasi-Peak (QP)
Frequency Range	30MHz ~ 1GHz		

Antenna Polarity & Test Distance : Vertical at 3 m								
No	Frequency (MHz)	Emission Level (dBuV/m)	Limit (dBuV/m)	Margin (dB)	Antenna Height (m)	Table Angle (Degree)	Raw Value (dBuV)	Correction Factor (dB/m)
1	40.82	31.8 QP	40.0	-8.2	1.00 V	354	39.7	-7.9
2	70.21	28.1 QP	40.0	-11.9	1.00 V	113	38.1	-10.0
3	135.29	29.2 QP	43.5	-14.3	1.00 V	86	36.9	-7.7
4	171.45	25.6 QP	43.5	-17.9	1.00 V	321	33.1	-7.5
5	220.10	25.7 QP	46.0	-20.3	1.50 V	164	35.5	-9.8
6	267.67	35.3 QP	46.0	-10.7	1.50 V	243	42.5	-7.2

Remarks:

1. Emission Level(dBuV/m) = Raw Value(dBuV) + Correction Factor(dB/m)
2. Correction Factor(dB/m) = Antenna Factor(dB/m) + Cable Factor(dB) – Pre-Amplifier Factor(dB)
3. Margin value = Emission Level – Limit value
4. The other emission levels were very low against the limit of frequency range 30MHz~1000MHz.
5. The emission levels were very low against the limit of frequency range 9kHz~30MHz: the amplitude of spurious emissions attenuated more than 20 dB below the permissible value to be report.

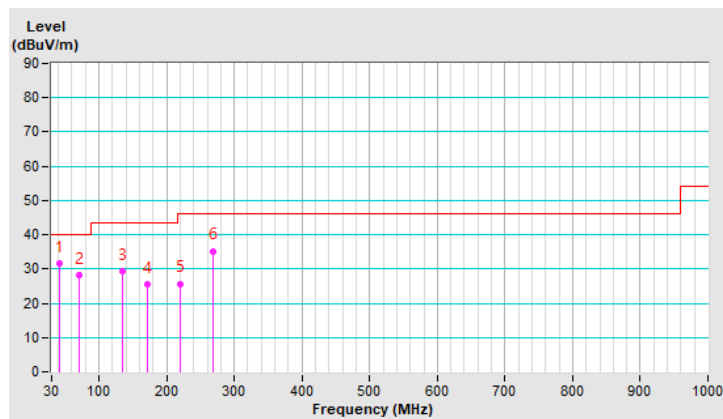

4.2 Conducted Emission Measurement

4.2.1 Limits of Conducted Emission Measurement

Frequency (MHz)	Conducted Limit (dBuV)	
	Quasi-peak	Average
0.15 - 0.5	66 - 56	56 - 46
0.50 - 5.0	56	46
5.0 - 30.0	60	50

Note: 1. The lower limit shall apply at the transition frequencies.

2. The limit decreases in line with the logarithm of the frequency in the range of 0.15 to 0.50MHz.

4.2.2 Test Instruments

DESCRIPTION & MANUFACTURER	MODEL NO.	SERIAL NO.	CALIBRATED DATE	CALIBRATED UNTIL
Test Receiver R&S	ESCS 30	847124/029	Oct. 23, 2019	Oct. 22, 2020
Line-Impedance Stabilization Network (for EUT) R&S	ESH3-Z5	848773/004	Oct. 23, 2019	Oct. 22, 2020
Line-Impedance Stabilization Network (for Peripheral) R&S	ESH3-Z5	835239/001	Mar. 19, 2020	Mar. 18, 2021
50 ohms Terminator	50	3	Oct. 23, 2019	Oct. 22, 2020
RF Cable	5D-FB	COCCAB-001	Sep. 26, 2020	Sep. 25, 2021
Fixed attenuator EMCI	STI02-2200-10	005	Aug. 29, 2020	Aug. 28, 2021
Software BVADT	BVADT_Cond_ V7.3.7.4	NA	NA	NA

Note:

1. The calibration interval of the above test instruments are 12 months and the calibrations are traceable to NML/ROC and NIST/USA.
2. The test was performed in Conduction 1.
- 3 Tested Date: Oct. 06, 2020

4.2.3 Test Procedure

- The EUT was placed 0.4 meters from the conducting wall of the shielded room with EUT being connected to the power mains through a line impedance stabilization network (LISN). Other support units were connected to the power mains through another LISN. The two LISNs provide 50 ohm/ 50uH of coupling impedance for the measuring instrument.
- Both lines of the power mains connected to the EUT were checked for maximum conducted interference.
- The frequency range from 150kHz to 30MHz was searched. Emission levels under (Limit - 20dB) was not recorded.

NOTE: All modes of operation were investigated and the worst-case emissions are reported.

4.2.4 Deviation from Test Standard

No deviation.

4.2.5 Test Setup

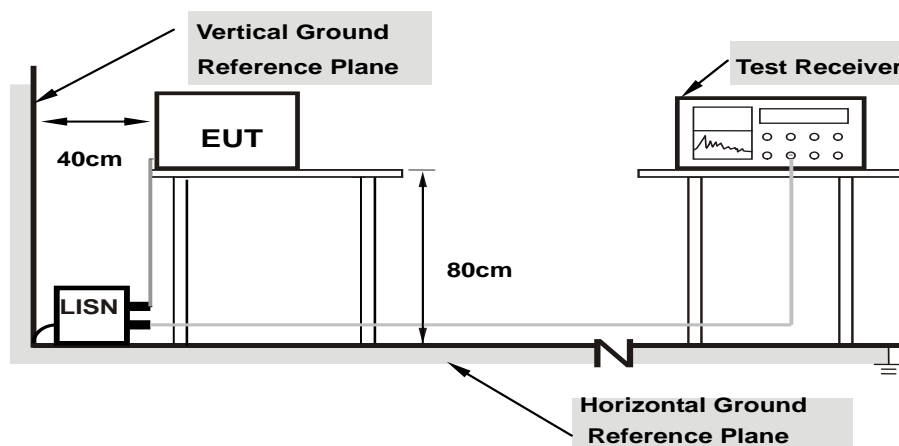

Note: 1.Support units were connected to second LISN.

For the actual test configuration, please refer to the attached file (Test Setup Photo).

4.2.6 EUT Operating Condition

Same as 4.1.6.

4.2.7 Test Results

Phase	Line (L)	Detector Function	Quasi-Peak (QP) / Average (AV)
-------	----------	-------------------	--------------------------------

No	Freq. [MHz]	Corr.	Reading Value		Emission Level		Limit		Margin	
		Factor	[dB (uV)]		[dB (uV)]		[dB (uV)]		(dB)	
	(dB)	Q.P.	AV.	Q.P.	AV.	Q.P.	AV.	Q.P.	AV.	
1	0.15391	9.92	33.60	18.03	43.52	27.95	65.79	55.79	-22.27	-27.84
2	0.23203	9.95	32.14	26.27	42.09	36.22	62.38	52.38	-20.29	-16.16
3	0.31016	9.97	35.38	31.81	45.35	41.78	59.97	49.97	-14.62	-8.19
4	0.33359	9.97	37.45	29.16	47.42	39.13	59.36	49.36	-11.94	-10.23
5	3.72266	10.21	22.63	14.27	32.84	24.48	56.00	46.00	-23.16	-21.52
6	19.64844	11.33	23.56	16.70	34.89	28.03	60.00	50.00	-25.11	-21.97

Remarks:

1. Q.P. and AV. are abbreviations of quasi-peak and average individually.
2. The emission levels of other frequencies were very low against the limit.
3. Margin value = Emission level – Limit value
4. Correction factor = Insertion loss + Cable loss
5. Emission Level = Correction Factor + Reading Value

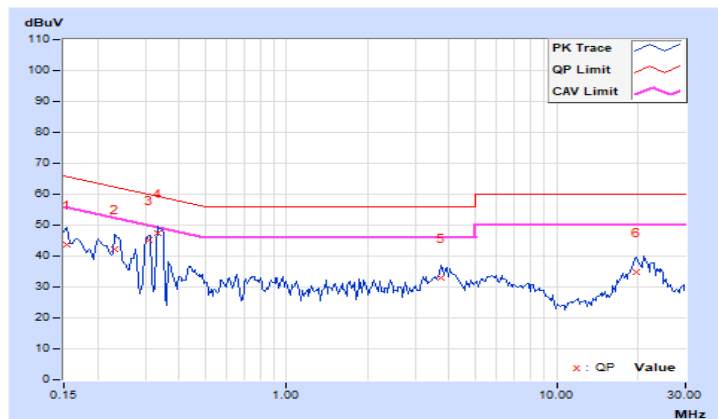

Phase	Neutral (N)	Detector Function	Quasi-Peak (QP) / Average (AV)
-------	-------------	-------------------	--------------------------------

No	Freq. [MHz]	Corr. Factor	Reading Value [dB (uV)]		Emission Level [dB (uV)]		Limit [dB (uV)]		Margin (dB)	
		(dB)	Q.P.	AV.	Q.P.	AV.	Q.P.	AV.	Q.P.	AV.
	1	0.15000	9.93	33.74	20.26	43.67	30.19	66.00	56.00	-22.33
2	0.23984	9.97	33.24	29.52	43.21	39.49	62.10	52.10	-18.89	-12.61
3	0.31016	9.98	34.26	31.51	44.24	41.49	59.97	49.97	-15.73	-8.48
4	0.34141	9.99	37.19	34.73	47.18	44.72	59.17	49.17	-11.99	-4.45
5	4.05078	10.23	21.64	12.98	31.87	23.21	56.00	46.00	-24.13	-22.79
6	21.03906	11.12	22.90	14.09	34.02	25.21	60.00	50.00	-25.98	-24.79

Remarks:

1. Q.P. and AV. are abbreviations of quasi-peak and average individually.
2. The emission levels of other frequencies were very low against the limit.
3. Margin value = Emission level – Limit value
4. Correction factor = Insertion loss + Cable loss
5. Emission Level = Correction Factor + Reading Value

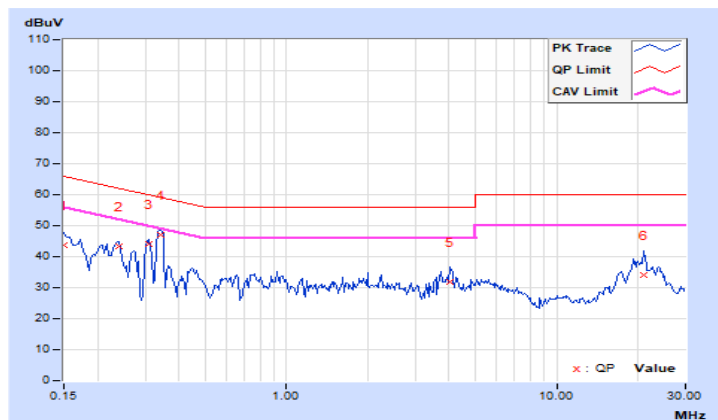

4.3 Transmit Power Measurement

4.3.1 Limits of Transmit Power Measurement

Operation Band	EUT Category		Limit
U-NII-1		Outdoor Access Point	1 Watt (30 dBm) (Max. e.i.r.p \leq 125mW(21 dBm) at any elevation angle above 30 degrees as measured from the horizon)
		Fixed point-to-point Access Point	1 Watt (30 dBm)
	√	Indoor Access Point	1 Watt (30 dBm)
	√	Client device	250mW (24 dBm)
U-NII-2A			250mW (24 dBm) or 11 dBm+10 log B*
U-NII-2C			250mW (24 dBm) or 11 dBm+10 log B*
U-NII-3		√	1 Watt (30 dBm)

*B is the 26 dB emission bandwidth in megahertz

Note: This device can support different category application which switched by access point mode and client mode by software.

Per KDB 662911 Method of conducted output power measurement on IEEE 802.11 devices,

Array Gain = 0 dB (i.e., no array gain) for $N_{ANT} \leq 4$;

Array Gain = 0 dB (i.e., no array gain) for channel widths ≥ 40 MHz for any N_{ANT} ;

Array Gain = $5 \log(N_{ANT}/N_{SS})$ dB or 3 dB, whichever is less for 20-MHz channel widths with $N_{ANT} \geq 5$.

For power measurements on all other devices: Array Gain = $10 \log(N_{ANT}/N_{SS})$ dB.

4.3.2 Test Setup

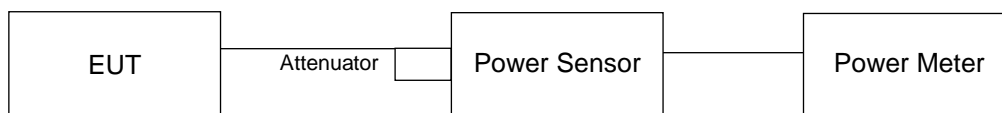

4.3.3 Test Instruments

Refer to section 4.1.2 to get information of above instrument.

4.3.4 Test Procedure

Method PM is used to perform output power measurement, trigger and gating function of wide band power meter is enabled to measure max output power of TX on burst. Duty factor is not added to measured value.

4.3.5 Deviation from Test Standard

No deviation.

4.3.6 EUT Operating Condition

The software provided by client to enable the EUT under transmission condition continuously at lowest, middle and highest channel frequencies individually.

4.3.7 Test Results

Master

CDD Mode

802.11a

Chan.	Chan. Freq. (MHz)	Maximum Conducted Power (dBm)		Total Power (mW)	Total Power (dBm)	Limit (dBm)	Pass / Fail
		Chain 0	Chain 1				
36	5180	22.12	21.72	311.523	24.93	30.00	Pass
40	5200	25.62	25.32	705.162	28.48	30.00	Pass
48	5240	25.84	25.46	735.268	28.66	30.00	Pass
149	5745	25.77	24.07	632.842	28.01	30.00	Pass
157	5785	25.93	24.04	645.255	28.10	30.00	Pass
165	5825	25.81	24.53	664.858	28.23	30.00	Pass

802.11ac (VHT20)

Chan.	Chan. Freq. (MHz)	Maximum Conducted Power (dBm)		Total Power (mW)	Total Power (dBm)	Limit (dBm)	Pass / Fail
		Chain 0	Chain 1				
36	5180	20.39	20.00	209.396	23.21	30.00	Pass
40	5200	24.86	24.71	601.998	27.80	30.00	Pass
48	5240	25.02	24.70	612.808	27.87	30.00	Pass
149	5745	24.92	23.16	517.47	27.14	30.00	Pass
157	5785	25.18	23.22	539.504	27.32	30.00	Pass
165	5825	24.99	23.23	525.878	27.21	30.00	Pass

802.11ac (VHT40)

Chan.	Chan. Freq. (MHz)	Maximum Conducted Power (dBm)		Total Power (mW)	Total Power (dBm)	Limit (dBm)	Pass / Fail
		Chain 0	Chain 1				
38	5190	19.09	18.90	158.721	22.01	30.00	Pass
46	5230	24.08	23.84	497.961	26.97	30.00	Pass
151	5755	25.71	23.93	619.564	27.92	30.00	Pass
159	5795	25.72	23.84	615.353	27.89	30.00	Pass

802.11ac (VHT80)

Chan.	Chan. Freq. (MHz)	Maximum Conducted Power (dBm)		Total Power (mW)	Total Power (dBm)	Limit (dBm)	Pass / Fail
		Chain 0	Chain 1				
42	5210	19.01	18.80	155.474	21.92	30.00	Pass
155	5775	25.43	23.53	574.564	27.59	30.00	Pass

802.11ax (HE20)

Chan.	Chan. Freq. (MHz)	Maximum Conducted Power (dBm)		Total Power (mW)	Total Power (dBm)	Limit (dBm)	Pass / Fail
		Chain 0	Chain 1				
36	5180	20.65	20.27	222.559	23.47	30.00	Pass
40	5200	25.13	24.92	636.293	28.04	30.00	Pass
48	5240	25.31	24.94	651.514	28.14	30.00	Pass
149	5745	25.17	23.41	548.132	27.39	30.00	Pass
157	5785	25.44	23.45	571.255	27.57	30.00	Pass
165	5825	25.22	23.47	554.991	27.44	30.00	Pass

802.11ax (HE40)

Chan.	Chan. Freq. (MHz)	Maximum Conducted Power (dBm)		Total Power (mW)	Total Power (dBm)	Limit (dBm)	Pass / Fail
		Chain 0	Chain 1				
38	5190	19.36	19.11	167.768	22.25	30.00	Pass
46	5230	24.31	24.05	523.871	27.19	30.00	Pass
151	5755	25.98	24.20	659.305	28.19	30.00	Pass
159	5795	25.99	24.12	655.418	28.17	30.00	Pass

802.11ax (HE80)

Chan.	Chan. Freq. (MHz)	Maximum Conducted Power (dBm)		Total Power (mW)	Total Power (dBm)	Limit (dBm)	Pass / Fail
		Chain 0	Chain 1				
42	5210	19.27	19.01	164.144	22.15	30.00	Pass
155	5775	25.63	23.97	615.054	27.89	30.00	Pass

Beamforming Mode

802.11ac (VHT20)

Chan.	Chan. Freq. (MHz)	Maximum Conducted Power (dBm)		Total Power (mW)	Total Power (dBm)	Limit (dBm)	Pass / Fail
		Chain 0	Chain 1				
36	5180	20.39	20.00	209.396	23.21	29.24	Pass
40	5200	24.86	24.71	601.998	27.80	29.24	Pass
48	5240	25.02	24.70	612.808	27.87	29.24	Pass
149	5745	24.92	23.16	517.47	27.14	29.24	Pass
157	5785	25.18	23.22	539.504	27.32	29.24	Pass
165	5825	24.99	23.23	525.878	27.21	29.24	Pass

Note: 1. The directional gain = $10 \log[(10^{G0/20} + 10^{G1/20})^2 / 2] = 6.76 \text{ dBi} > 6 \text{ dBi}$, so the power limit be reduced to $30 - (6.76 - 6) = 29.24 \text{ dBm}$.

802.11ac (VHT40)

Chan.	Chan. Freq. (MHz)	Maximum Conducted Power (dBm)		Total Power (mW)	Total Power (dBm)	Limit (dBm)	Pass / Fail
		Chain 0	Chain 1				
38	5190	19.09	18.90	158.721	22.01	29.24	Pass
46	5230	24.08	23.84	497.961	26.97	29.24	Pass
151	5755	25.71	23.93	619.564	27.92	29.24	Pass
159	5795	25.72	23.84	615.353	27.89	29.24	Pass

Note: 1. The directional gain = $10 \log[(10^{G0/20} + 10^{G1/20})^2 / 2] = 6.76 \text{ dBi} > 6 \text{ dBi}$, so the power limit be reduced to $30 - (6.76 - 6) = 29.24 \text{ dBm}$.

802.11ac (VHT80)

Chan.	Chan. Freq. (MHz)	Maximum Conducted Power (dBm)		Total Power (mW)	Total Power (dBm)	Limit (dBm)	Pass / Fail
		Chain 0	Chain 1				
42	5210	19.01	18.80	155.474	21.92	29.24	Pass
155	5775	25.43	23.53	574.564	27.59	29.24	Pass

Note: 1. The directional gain = $10 \log[(10^{G0/20} + 10^{G1/20})^2 / 2] = 6.76 \text{ dBi} > 6 \text{ dBi}$, so the power limit be reduced to $30 - (6.76 - 6) = 29.24 \text{ dBm}$.

802.11ax (HE20)

Chan.	Chan. Freq. (MHz)	Maximum Conducted Power (dBm)		Total Power (mW)	Total Power (dBm)	Limit (dBm)	Pass / Fail
		Chain 0	Chain 1				
36	5180	20.65	20.27	222.559	23.47	29.24	Pass
40	5200	25.13	24.92	636.293	28.04	29.24	Pass
48	5240	25.31	24.94	651.514	28.14	29.24	Pass
149	5745	25.17	23.41	548.132	27.39	29.24	Pass
157	5785	25.44	23.45	571.255	27.57	29.24	Pass
165	5825	25.22	23.47	554.991	27.44	29.24	Pass

Note: 1. The directional gain = $10 \log[(10^{G0/20} + 10^{G1/20})^2 / 2]$ = 6.76 dBi > 6 dBi, so the power limit be reduced to $30 - (6.76 - 6) = 29.24$ dBm.

802.11ax (HE40)

Chan.	Chan. Freq. (MHz)	Maximum Conducted Power (dBm)		Total Power (mW)	Total Power (dBm)	Limit (dBm)	Pass / Fail
		Chain 0	Chain 1				
38	5190	19.36	19.11	167.768	22.25	29.24	Pass
46	5230	24.31	24.05	523.871	27.19	29.24	Pass
151	5755	25.95	24.20	659.305	28.19	29.24	Pass
159	5795	25.99	24.12	655.418	28.17	29.24	Pass

Note: 1. The directional gain = $10 \log[(10^{G0/20} + 10^{G1/20})^2 / 2]$ = 6.76 dBi > 6 dBi, so the power limit be reduced to $30 - (6.76 - 6) = 29.24$ dBm.

802.11ax (HE80)

Chan.	Chan. Freq. (MHz)	Maximum Conducted Power (dBm)		Total Power (mW)	Total Power (dBm)	Limit (dBm)	Pass / Fail
		Chain 0	Chain 1				
42	5210	19.27	19.01	164.144	22.15	29.24	Pass
155	5775	25.63	23.97	615.054	27.89	29.24	Pass

Note: 1. The directional gain = $10 \log[(10^{G0/20} + 10^{G1/20})^2 / 2]$ = 6.76 dBi > 6 dBi, so the power limit be reduced to $30 - (6.76 - 6) = 29.24$ dBm.

Client
CDD Mode
802.11a

Chan.	Chan. Freq. (MHz)	Maximum Conducted Power (dBm)		Total Power (mW)	Total Power (dBm)	Limit (dBm)	Pass / Fail
		Chain 0	Chain 1				
36	5180	19.98	19.76	194.164	22.88	24.00	Pass
40	5200	20.04	19.85	197.53	22.96	24.00	Pass
48	5240	20.06	19.81	197.111	22.95	24.00	Pass

802.11ac (VHT20)

Chan.	Chan. Freq. (MHz)	Maximum Conducted Power (dBm)		Total Power (mW)	Total Power (dBm)	Limit (dBm)	Pass / Fail
		Chain 0	Chain 1				
36	5180	20.39	20.00	209.396	23.21	24.00	Pass
40	5200	20.10	19.90	200.053	23.01	24.00	Pass
48	5240	20.08	19.80	197.358	22.95	24.00	Pass

802.11ac (VHT40)

Chan.	Chan. Freq. (MHz)	Maximum Conducted Power (dBm)		Total Power (mW)	Total Power (dBm)	Limit (dBm)	Pass / Fail
		Chain 0	Chain 1				
38	5190	19.09	18.90	158.721	22.01	24.00	Pass
46	5230	20.49	20.36	220.586	23.44	24.00	Pass

802.11ac (VHT80)

Chan.	Chan. Freq. (MHz)	Maximum Conducted Power (dBm)		Total Power (mW)	Total Power (dBm)	Limit (dBm)	Pass / Fail
		Chain 0	Chain 1				
42	5210	19.01	18.80	155.474	21.92	24.00	Pass

802.11ax (HE20)

Chan.	Chan. Freq. (MHz)	Maximum Conducted Power (dBm)		Total Power (mW)	Total Power (dBm)	Limit (dBm)	Pass / Fail
		Chain 0	Chain 1				
36	5180	20.65	20.27	222.559	23.47	24.00	Pass
40	5200	20.32	20.10	209.976	23.22	24.00	Pass
48	5240	20.28	20.08	208.519	23.19	24.00	Pass

802.11ax (HE40)

Chan.	Chan. Freq. (MHz)	Maximum Conducted Power (dBm)		Total Power (mW)	Total Power (dBm)	Limit (dBm)	Pass / Fail
		Chain 0	Chain 1				
38	5190	19.36	19.11	167.768	22.25	24.00	Pass
46	5230	20.78	20.63	235.285	23.72	24.00	Pass

802.11ax (HE80)

Chan.	Chan. Freq. (MHz)	Maximum Conducted Power (dBm)		Total Power (mW)	Total Power (dBm)	Limit (dBm)	Pass / Fail
		Chain 0	Chain 1				
42	5210	19.27	19.01	164.144	22.15	24.00	Pass

Beamforming Mode

802.11ac (VHT20)

Chan.	Chan. Freq. (MHz)	Maximum Conducted Power (dBm)		Total Power (mW)	Total Power (dBm)	Limit (dBm)	Pass / Fail
		Chain 0	Chain 1				
36	5180	19.92	19.53	187.918	22.74	23.24	Pass
40	5200	20.10	19.85	198.934	22.99	23.24	Pass
48	5240	20.08	19.80	197.358	22.95	23.24	Pass

Note: 1. The directional gain = $10 \log[(10^{G0/20} + 10^{G1/20})^2 / 2] = 6.76 \text{ dBi} > 6 \text{ dBi}$, so the power limit be reduced to $24 - (6.76 - 6) = 23.24 \text{ dBm}$.

802.11ac (VHT40)

Chan.	Chan. Freq. (MHz)	Maximum Conducted Power (dBm)		Total Power (mW)	Total Power (dBm)	Limit (dBm)	Pass / Fail
		Chain 0	Chain 1				
38	5190	19.09	18.90	158.721	22.01	23.24	Pass
46	5230	19.71	19.45	181.645	22.59	23.24	Pass

Note: 1. The directional gain = $10 \log[(10^{G0/20} + 10^{G1/20})^2 / 2] = 6.76 \text{ dBi} > 6 \text{ dBi}$, so the power limit be reduced to $24 - (6.76 - 6) = 23.24 \text{ dBm}$.

802.11ac (VHT80)

Chan.	Chan. Freq. (MHz)	Maximum Conducted Power (dBm)		Total Power (mW)	Total Power (dBm)	Limit (dBm)	Pass / Fail
		Chain 0	Chain 1				
42	5210	19.01	18.80	155.474	21.92	23.24	Pass

Note: 1. The directional gain = $10 \log[(10^{G0/20} + 10^{G1/20})^2 / 2] = 6.76 \text{ dBi} > 6 \text{ dBi}$, so the power limit be reduced to $24 - (6.76 - 6) = 23.24 \text{ dBm}$.

802.11ax (HE20)

Chan.	Chan. Freq. (MHz)	Maximum Conducted Power (dBm)		Total Power (mW)	Total Power (dBm)	Limit (dBm)	Pass / Fail
		Chain 0	Chain 1				
36	5180	20.14	19.77	198.118	22.97	23.24	Pass
40	5200	20.32	20.05	208.804	23.20	23.24	Pass
48	5240	20.28	20.08	208.519	23.19	23.24	Pass

Note: 1. The directional gain = $10 \log[(10^{G0/20} + 10^{G1/20})^2 / 2] = 6.76 \text{ dBi} > 6 \text{ dBi}$, so the power limit be reduced to $24 - (6.76 - 6) = 23.24 \text{ dBm}$.

802.11ax (HE40)

Chan.	Chan. Freq. (MHz)	Maximum Conducted Power (dBm)		Total Power (mW)	Total Power (dBm)	Limit (dBm)	Pass / Fail
		Chain 0	Chain 1				
38	5190	19.36	19.11	167.768	22.25	23.24	Pass
46	5230	19.97	19.67	191.995	22.83	23.24	Pass

Note: 1. The directional gain = $10 \log[(10^{G0/20} + 10^{G1/20})^2 / 2] = 6.76 \text{ dBi} > 6 \text{ dBi}$, so the power limit be reduced to $24 - (6.76 - 6) = 23.24 \text{ dBm}$.

802.11ax (HE80)

Chan.	Chan. Freq. (MHz)	Maximum Conducted Power (dBm)		Total Power (mW)	Total Power (dBm)	Limit (dBm)	Pass / Fail
		Chain 0	Chain 1				
42	5210	19.27	19.01	164.144	22.15	23.24	Pass

Note: 1. The directional gain = $10 \log[(10^{G0/20} + 10^{G1/20})^2 / 2] = 6.76 \text{ dBi} > 6 \text{ dBi}$, so the power limit be reduced to $24 - (6.76 - 6) = 23.24 \text{ dBm}$.

4.4 Occupied Bandwidth Measurement

4.4.1 Test Setup

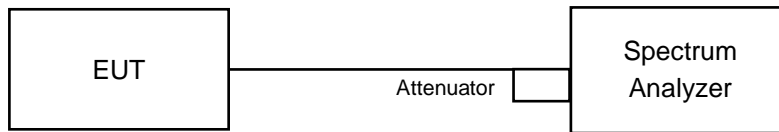

4.4.2 Test Instruments

Refer to section 4.1.2 to get information of above instrument.

4.4.3 Test Procedure

The transmitter output was connected to the spectrum analyzer through an attenuator. The bandwidth of the fundamental frequency was measured by spectrum analyzer with resolution bandwidth in the range of 1% to 5% of the anticipated emission bandwidth, and a video bandwidth at least 3x the resolution bandwidth and set the detector to SAMPLE. The width of a frequency band such that, below the lower and above the upper frequency limits, the mean powers emitted are each equal to a specified percentage 0.5% of the total mean power of a given emission.

4.4.4 Test Results

Master

CDD Mode

802.11a

Channel	Channel Frequency (MHz)	Occupied Bandwidth (MHz)	
		Chain 0	Chain 1
36	5180	16.56	16.56
40	5200	16.68	16.8
48	5240	16.68	16.56
149	5745	16.92	16.44
157	5785	16.92	16.44
165	5825	16.68	16.44

802.11ax (HE20)

Channel	Channel Frequency (MHz)	Occupied Bandwidth (MHz)	
		Chain 0	Chain 1
36	5180	18.96	18.96
40	5200	19.2	19.08
48	5240	18.96	18.96
149	5745	18.96	18.96
157	5785	19.08	18.96
165	5825	19.08	19.08

802.11ax (HE40)

Channel	Channel Frequency (MHz)	Occupied Bandwidth (MHz)	
		Chain 0	Chain 1
38	5190	37.92	37.92
46	5230	37.92	38.4
151	5755	38.4	37.92
159	5795	38.4	37.92

802.11ax (HE80)

Channel	Channel Frequency (MHz)	Occupied Bandwidth (MHz)	
		Chain 0	Chain 1
42	5210	77.28	77.28
155	5775	77.76	76.8

Spectrum Plot of Max. Value

802.11a_Chain 0 / CH149

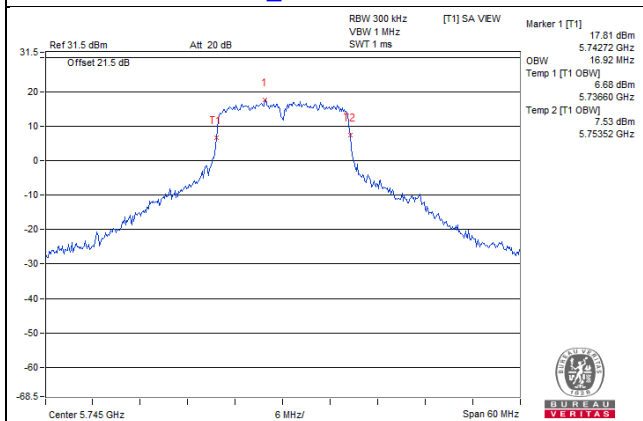

802.11ax (HE20)_Chain 0 / CH40

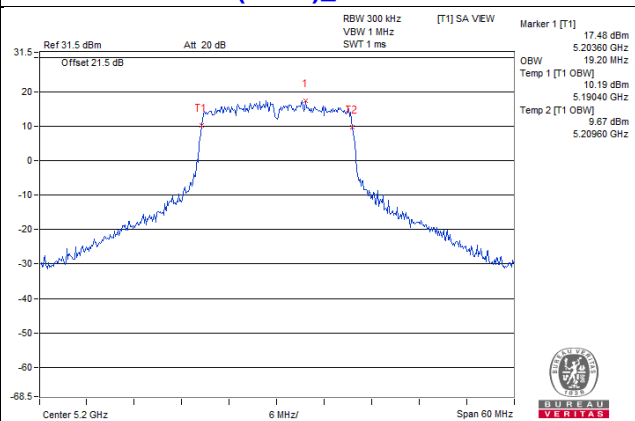

802.11ax (HE40)_Chain 0 / CH151

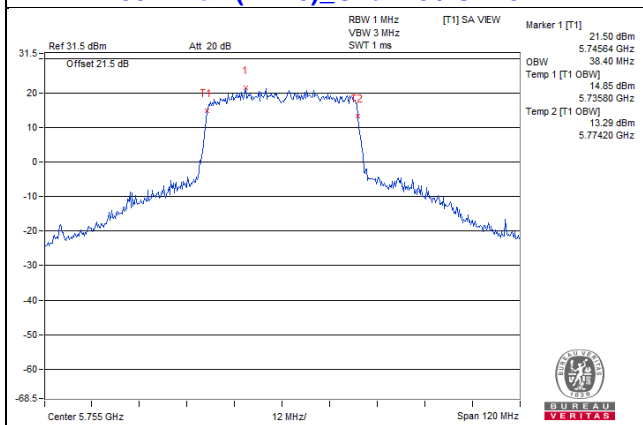

802.11ax (HE80)_Chain 0 / CH155

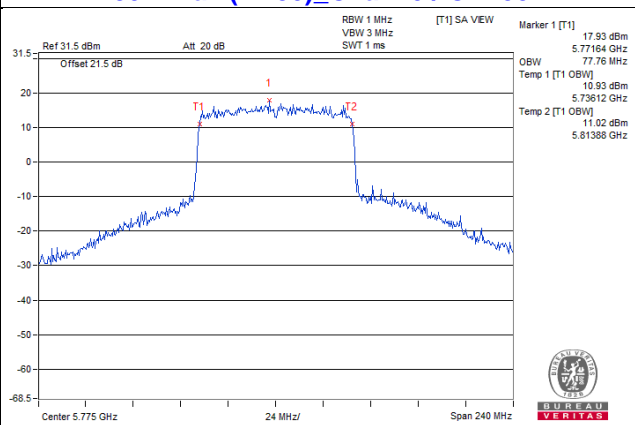

Client

CDD Mode

802.11a

Channel	Channel Frequency (MHz)	Occupied Bandwidth (MHz)	
		Chain 0	Chain 1
36	5180	16.44	16.32
40	5200	16.56	16.32
48	5240	16.44	16.56

802.11ax (HE20)

Channel	Channel Frequency (MHz)	Occupied Bandwidth (MHz)	
		Chain 0	Chain 1
36	5180	18.96	18.96
40	5200	19.08	18.96
48	5240	18.96	18.96

802.11ax (HE40)

Channel	Channel Frequency (MHz)	Occupied Bandwidth (MHz)	
		Chain 0	Chain 1
38	5190	37.92	37.92
46	5230	37.92	37.92

802.11ax (HE80)

Channel	Channel Frequency (MHz)	Occupied Bandwidth (MHz)	
		Chain 0	Chain 1
42	5210	77.28	77.28

Spectrum Plot of Max. Value

802.11a_Chain 0 / CH40

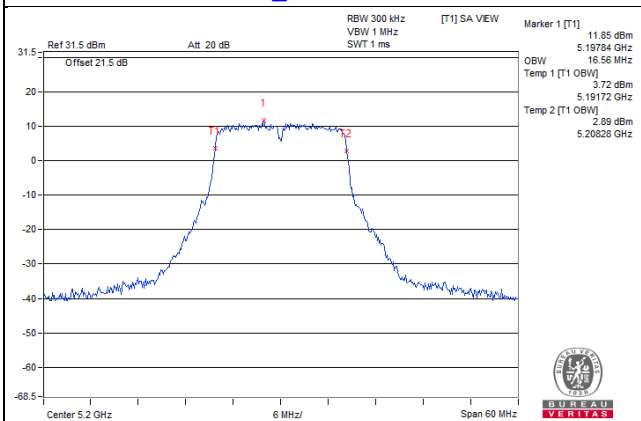

802.11ax (HE20)_Chain 0 / CH40

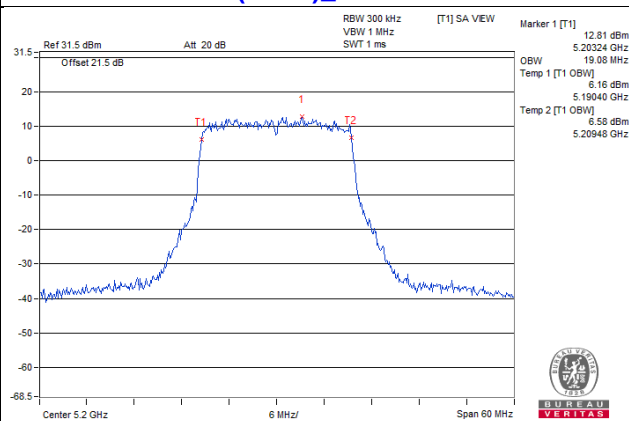

802.11ax (HE40)_Chain 0 / CH38

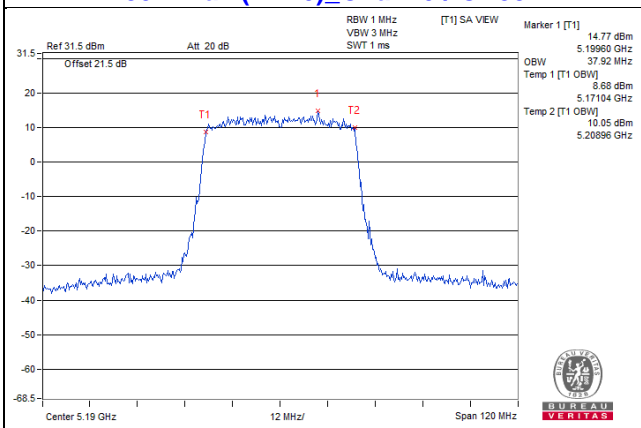

802.11ax (HE80)_Chain 0 / CH42

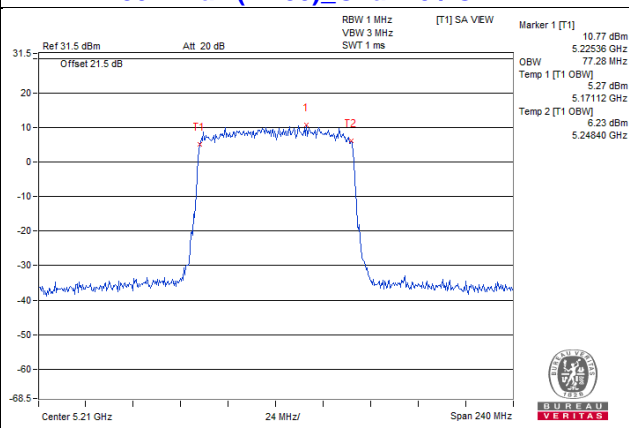

Master

Spectrum Plot for near by DFS band
(DFS is required, if 99% OCP straddle into U-NII-2A band)

802.11a Chain 0 / CH48

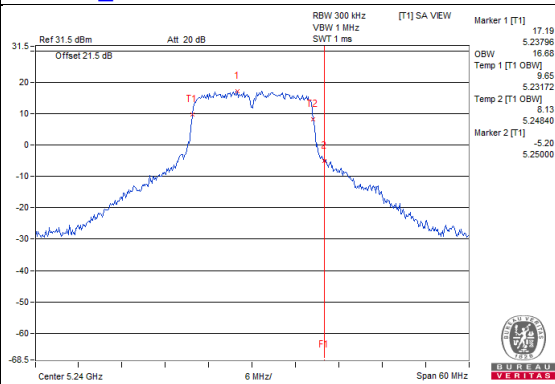

802.11a Chain 1 / CH48

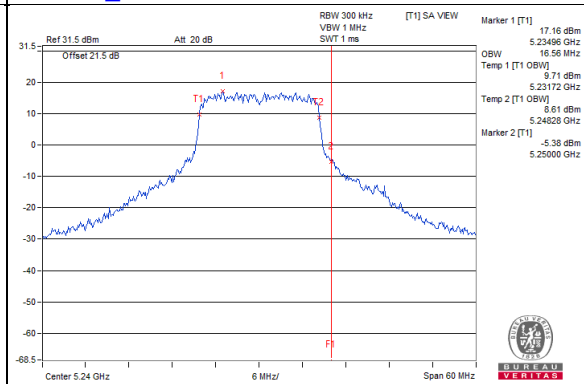

802.11ax (HE20) Chain 0 / CH48

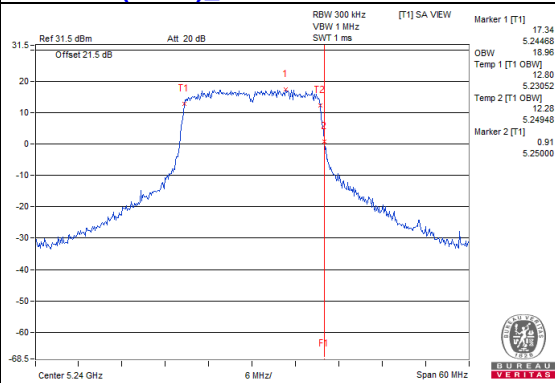

802.11ax (HE20) Chain 1 / CH48

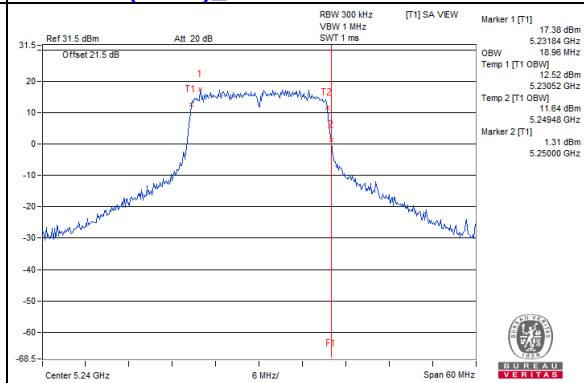

802.11ax (HE40) Chain 0 / CH46

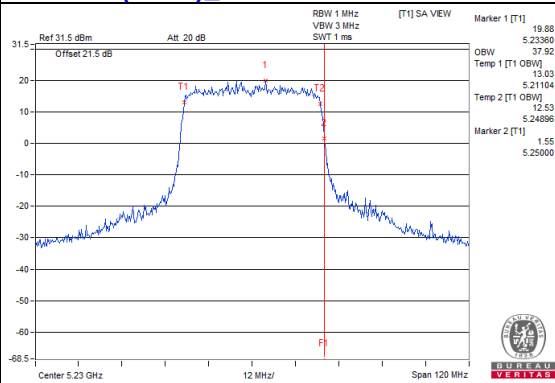

802.11ax (HE40) Chain 1 / CH46

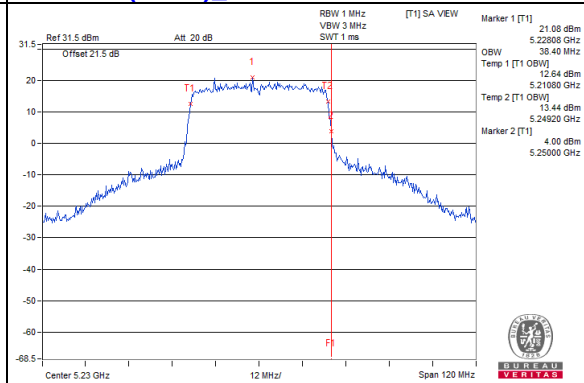

802.11ax (HE80) Chain 0 / CH42

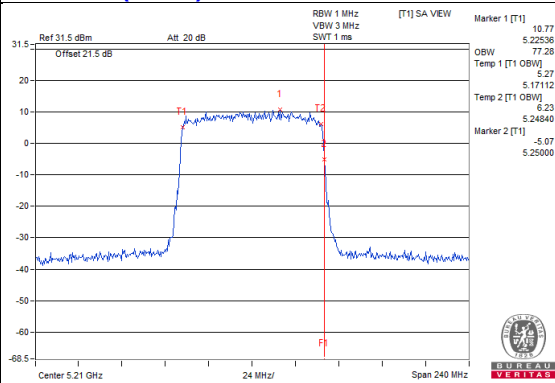

802.11ax (HE80) Chain 1 / CH42

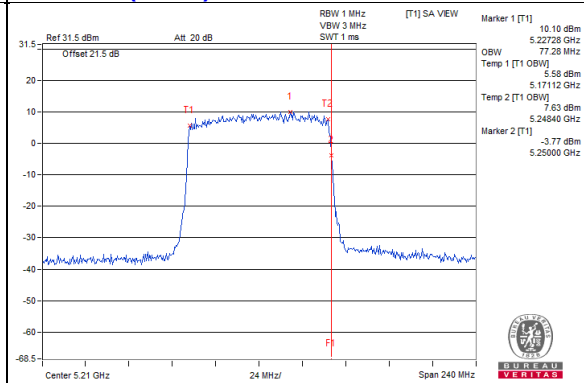

Spectrum Plot for near by DFS band
(DFS is required, if 99% OCP straddle into U-NII-2C band)

802.11a_Chain 0 / CH149

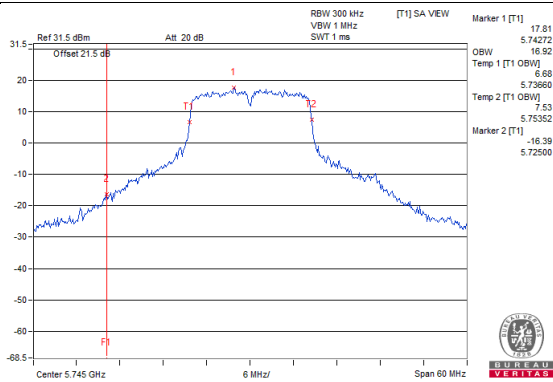

802.11a_Chain 1 / CH149

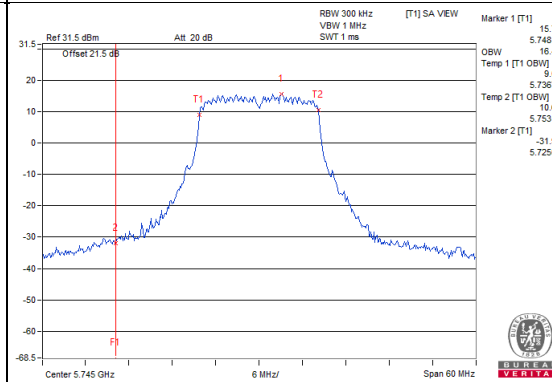

802.11ax (HE20)_Chain 0 / CH149

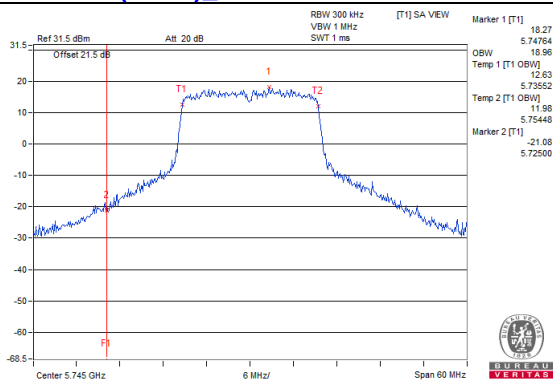

802.11ax (HE20)_Chain 1 / CH149

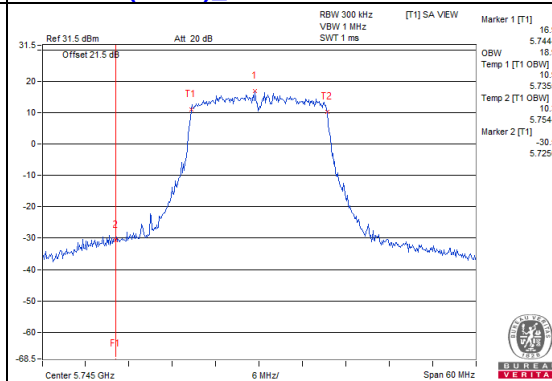

802.11ax (HE40)_Chain 0 / CH151

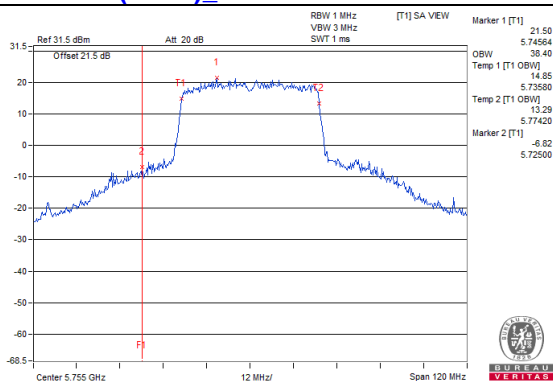

802.11ax (HE40)_Chain 1 / CH151

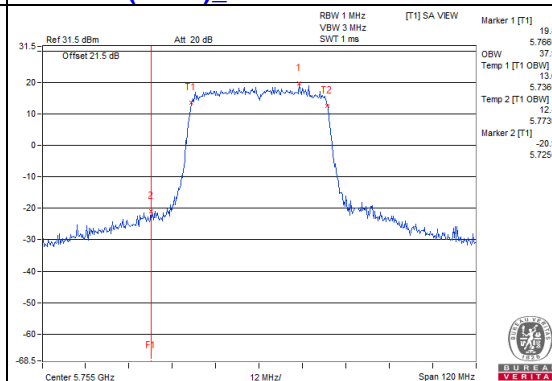

802.11ax (HE80)_Chain 0 / CH155

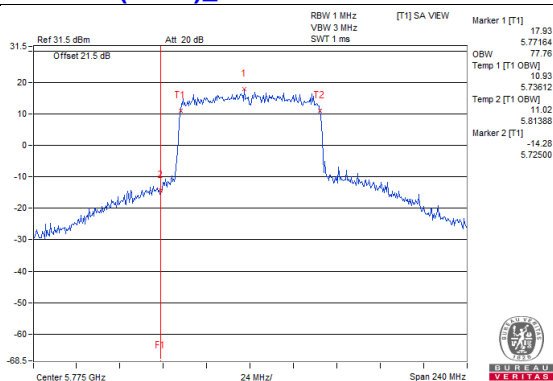

802.11ax (HE80)_Chain 1 / CH155

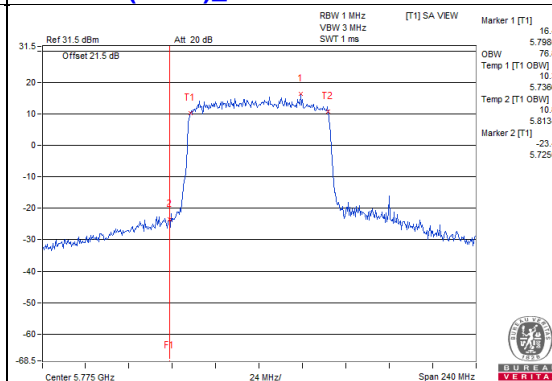

Client

Spectrum Plot for near by DFS band
(DFS is required, if 99% OCP straddle into U-NII-2A band)

802.11a_Chain 0 / CH48

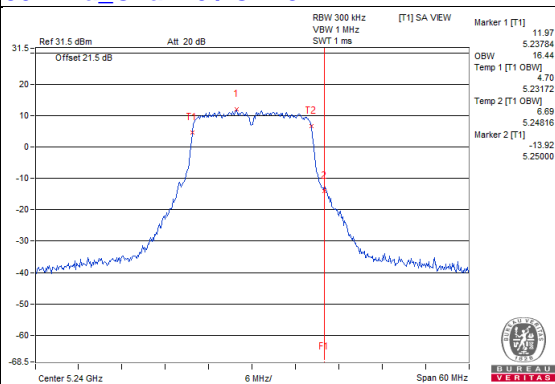

802.11a_Chain 1 / CH48

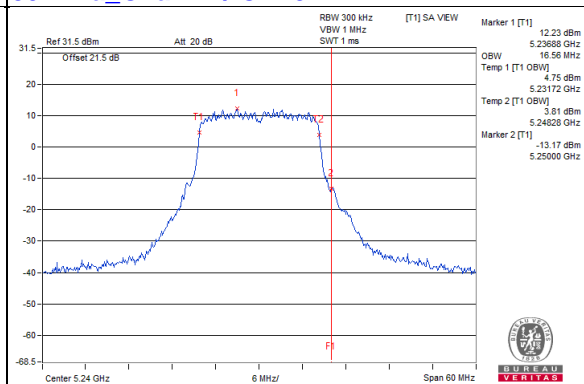

802.11ax (HE20)_Chain 0 / CH48

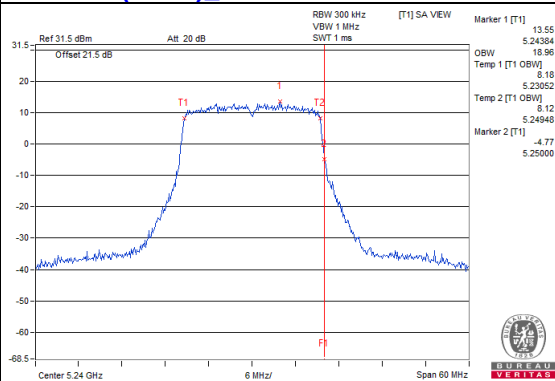

802.11ax (HE20)_Chain 1 / CH48

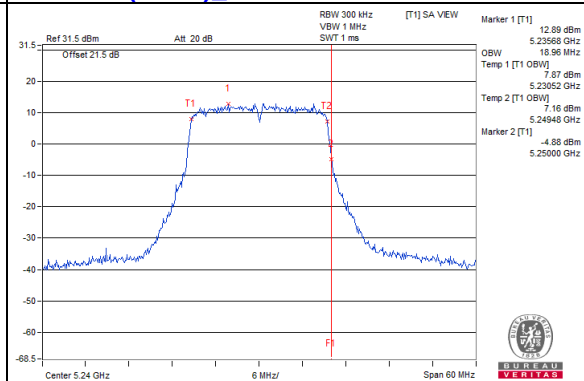

802.11ax (HE40)_Chain 0 / CH46

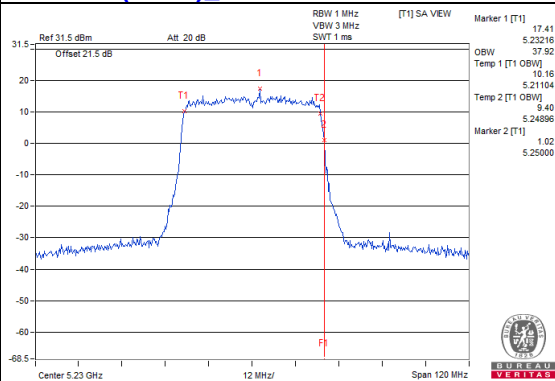

802.11ax (HE40)_Chain 1 / CH46

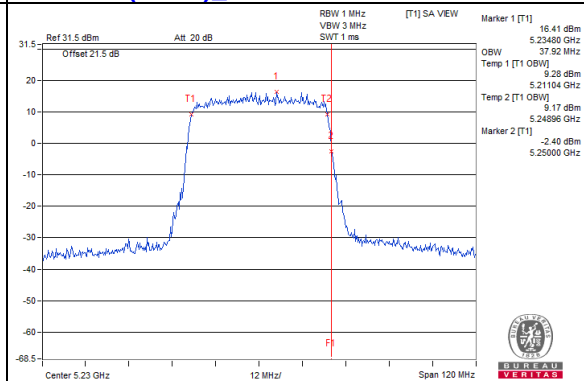

802.11ax (HE80)_Chain 0 / CH42

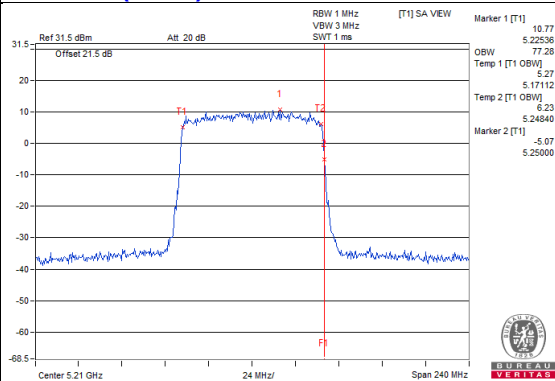

802.11ax (HE80)_Chain 1 / CH42

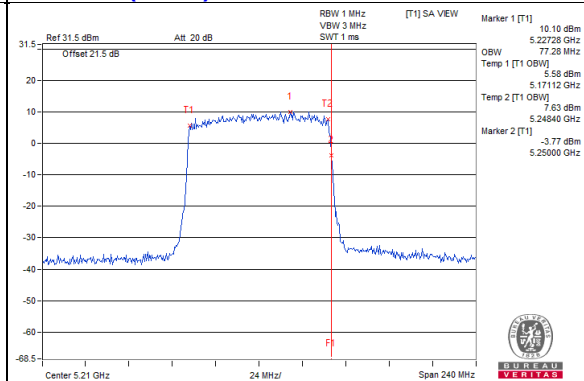

4.5 Peak Power Spectral Density Measurement

4.5.1 Limits of Peak Power Spectral Density Measurement

Operation Band	EUT Category		Limit
U-NII-1		Outdoor Access Point	17dBm/ MHz
		Fixed point-to-point Access Point	
	√	Indoor Access Point	11dBm/ MHz
	√	Client device	
U-NII-2A			11dBm/ MHz
U-NII-2C			11dBm/ MHz
U-NII-3	√		30dBm/ 500kHz

Note: This device can support different category application which switched by access point mode and client mode by software.

4.5.2 Test Setup



4.5.3 Test Instruments

Refer to section 4.1.2 to get information of above instrument.

4.5.4 Test Procedure

For U-NII-1 band:

Using method SA-2

1. Set span to encompass the entire emission bandwidth (EBW) of the signal.
2. Set RBW = 1 MHz, Set VBW \geq 3 MHz, Detector = RMS
3. Sweep time = auto, trigger set to "free run".
4. Trace average at least 100 traces in power averaging mode.
5. Record the max value and add 10 log (1/duty cycle)

For U-NII-3

1. Set span to encompass the entire emission bandwidth (EBW) of the signal.
2. Set RBW = 300 kHz, Set VBW \geq 1 MHz, Detector = RMS
3. Use the peak marker function to determine the maximum power level in any 300 kHz band segment within the fundamental EBW.
4. Scale the observed power level to an equivalent value in 500 kHz by adjusting (increasing) the measured power by a bandwidth correction factor (BWCF) where $BWCF = 10\log(500\text{ kHz}/300\text{kHz})$
5. Sweep time = auto, trigger set to "free run".
6. Trace average at least 100 traces in power averaging mode.
7. Record the max value and add 10 log (1/duty cycle)

4.5.5 Deviation from Test Standard

No deviation.

4.5.6 EUT Operating Condition

Same as Item 4.3.6.

4.5.7 Test Results

For U-NII-1:

Master

CDD Mode

802.11a

Chan.	Chan. Freq. (MHz)	PSD w/o Duty Factor (dBm/MHz)		Duty Factor (dB)	Total PSD (dBm/MHz)	Max. PSD Limit (dBm/MHz)	Pass / Fail
		Chain 0	Chain 1				
36	5180	8.34	7.62	0.36	11.36	16.24	PASS
40	5200	11.35	11.19	0.36	14.64	16.24	PASS
48	5240	12.62	11.61	0.36	15.51	16.24	PASS

- Note: 1. Method a) of power density measurement of KDB 662911 is using for calculating total power density. Total power density is summing entire spectra across corresponding frequency bins on the various outputs by computer.
2. The directional gain = $10 \log[(10^{G1/20} + 10^{G2/20})^2 / 2] = 6.76\text{dBi} > 6\text{dBi}$, so the power density limit shall be reduced to $17-(6.76-6) = 16.24 \text{ dBm}$.
3. Refer to section 3.3 for duty cycle spectrum plot.

802.11ax (HE20)

Chan.	Chan. Freq. (MHz)	PSD w/o Duty Factor (dBm/MHz)		Duty Factor (dB)	Total PSD (dBm/MHz)	Max. PSD Limit (dBm/MHz)	Pass / Fail
		Chain 0	Chain 1				
36	5180	6.72	5.86	0.22	9.55	16.24	PASS
40	5200	10.35	9.36	0.22	13.12	16.24	PASS
48	5240	11.58	9.09	0.22	13.75	16.24	PASS

- Note: 1. Method a) of power density measurement of KDB 662911 is using for calculating total power density. Total power density is summing entire spectra across corresponding frequency bins on the various outputs by computer.
2. The directional gain = $10 \log[(10^{G1/20} + 10^{G2/20})^2 / 2] = 6.76\text{dBi} > 6\text{dBi}$, so the power density limit shall be reduced to $17-(6.76-6) = 16.24 \text{ dBm}$.
3. Refer to section 3.3 for duty cycle spectrum plot.

802.11ax (HE40)

Chan.	Chan. Freq. (MHz)	PSD w/o Duty Factor (dBm/MHz)		Duty Factor (dB)	Total PSD (dBm/MHz)	Max. PSD Limit (dBm/MHz)	Pass / Fail
		Chain 0	Chain 1				
38	5190	2.67	-0.33	0.23	4.66	16.24	PASS
46	5230	6.17	8.80	0.23	10.92	16.24	PASS

- Note: 1. Method a) of power density measurement of KDB 662911 is using for calculating total power density. Total power density is summing entire spectra across corresponding frequency bins on the various outputs by computer.
2. The directional gain = $10 \log[(10^{G1/20} + 10^{G2/20})^2 / 2] = 6.76\text{dBi} > 6\text{dBi}$, so the power density limit shall be reduced to $17-(6.76-6) = 16.24 \text{ dBm}$.
3. Refer to section 3.3 for duty cycle spectrum plot.

802.11ax (HE80)

Chan.	Chan. Freq. (MHz)	PSD w/o Duty Factor (dBm/MHz)		Duty Factor (dB)	Total PSD (dBm/MHz)	Max. PSD Limit (dBm/MHz)	Pass / Fail
		Chain 0	Chain 1				
42	5210	-2.54	-1.17	0.22	1.43	16.24	PASS

- Note: 1. Method a) of power density measurement of KDB 662911 is using for calculating total power density. Total power density is summing entire spectra across corresponding frequency bins on the various outputs by computer.
2. The directional gain = $10 \log[(10^{G1/20} + 10^{G2/20})^2 / 2] = 6.76\text{dBi} > 6\text{dBi}$, so the power density limit shall be reduced to $17 - (6.76 - 6) = 16.24 \text{ dBm}$.
3. Refer to section 3.3 for duty cycle spectrum plot.

Spectrum Plot of Worst Value

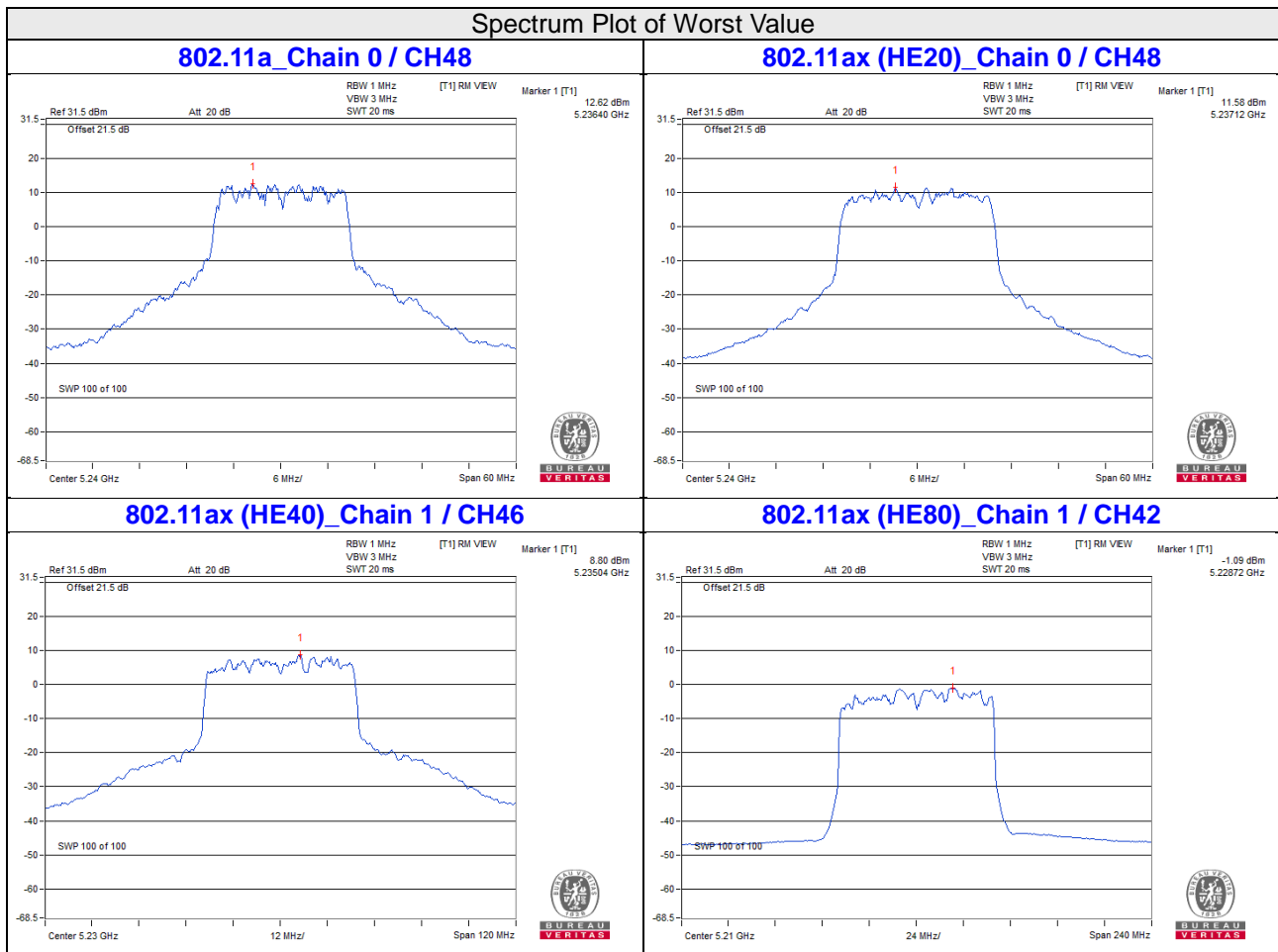

For U-NII-1:

Client

CDD Mode

802.11a

Chan.	Chan. Freq. (MHz)	PSD w/o Duty Factor (dBm/MHz)		Duty Factor (dB)	Total PSD (dBm/MHz)	Max. PSD Limit (dBm/MHz)	Pass / Fail
		Chain 0	Chain 1				
36	5180	6.39	5.92	0.36	9.53	10.24	PASS
40	5200	5.94	5.67	0.36	9.18	10.24	PASS
48	5240	6.51	5.73	0.36	9.51	10.24	PASS

- Note: 1. Method a) of power density measurement of KDB 662911 is using for calculating total power density. Total power density is summing entire spectra across corresponding frequency bins on the various outputs by computer.
2. The directional gain = $10 \log[(10^{G1/20} + 10^{G2/20})^2 / 2] = 6.76\text{dBi} > 6\text{dBi}$, so the power density limit shall be reduced to $11-(6.76-6) = 10.24 \text{ dBm}$.
3. Refer to section 3.3 for duty cycle spectrum plot.

802.11ax (HE20)

Chan.	Chan. Freq. (MHz)	PSD w/o Duty Factor (dBm/MHz)		Duty Factor (dB)	Total PSD (dBm/MHz)	Max. PSD Limit (dBm/MHz)	Pass / Fail
		Chain 0	Chain 1				
36	5180	6.72	5.86	0.22	9.55	10.24	PASS
40	5200	5.13	6.23	0.22	8.95	10.24	PASS
48	5240	5.51	5.63	0.22	8.80	10.24	PASS

- Note: 1. Method a) of power density measurement of KDB 662911 is using for calculating total power density. Total power density is summing entire spectra across corresponding frequency bins on the various outputs by computer.
2. The directional gain = $10 \log[(10^{G1/20} + 10^{G2/20})^2 / 2] = 6.76\text{dBi} > 6\text{dBi}$, so the power density limit shall be reduced to $11-(6.76-6) = 10.24 \text{ dBm}$.
3. Refer to section 3.3 for duty cycle spectrum plot.

802.11ax (HE40)

Chan.	Chan. Freq. (MHz)	PSD w/o Duty Factor (dBm/MHz)		Duty Factor (dB)	Total PSD (dBm/MHz)	Max. PSD Limit (dBm/MHz)	Pass / Fail
		Chain 0	Chain 1				
38	5190	2.67	-0.33	0.23	4.66	10.24	PASS
46	5230	3.79	3.50	0.23	6.89	10.24	PASS

- Note: 1. Method a) of power density measurement of KDB 662911 is using for calculating total power density. Total power density is summing entire spectra across corresponding frequency bins on the various outputs by computer.
2. The directional gain = $10 \log[(10^{G1/20} + 10^{G2/20})^2 / 2] = 6.76\text{dBi} > 6\text{dBi}$, so the power density limit shall be reduced to $11-(6.76-6) = 10.24 \text{ dBm}$.
3. Refer to section 3.3 for duty cycle spectrum plot.

802.11ax (HE80)

Chan.	Chan. Freq. (MHz)	PSD w/o Duty Factor (dBm/MHz)		Duty Factor (dB)	Total PSD (dBm/MHz)	Max. PSD Limit (dBm/MHz)	Pass / Fail
		Chain 0	Chain 1				
42	5210	-2.54	-1.17	0.22	1.43	10.24	PASS

- Note: 1. Method a) of power density measurement of KDB 662911 is using for calculating total power density. Total power density is summing entire spectra across corresponding frequency bins on the various outputs by computer.
2. The directional gain = $10 \log[(10^{G1/20} + 10^{G2/20})^2 / 2] = 6.76\text{dBi} > 6\text{dBi}$, so the power density limit shall be reduced to $11-(6.76-6) = 10.24 \text{ dBm}$.
3. Refer to section 3.3 for duty cycle spectrum plot.

Spectrum Plot of Worst Value

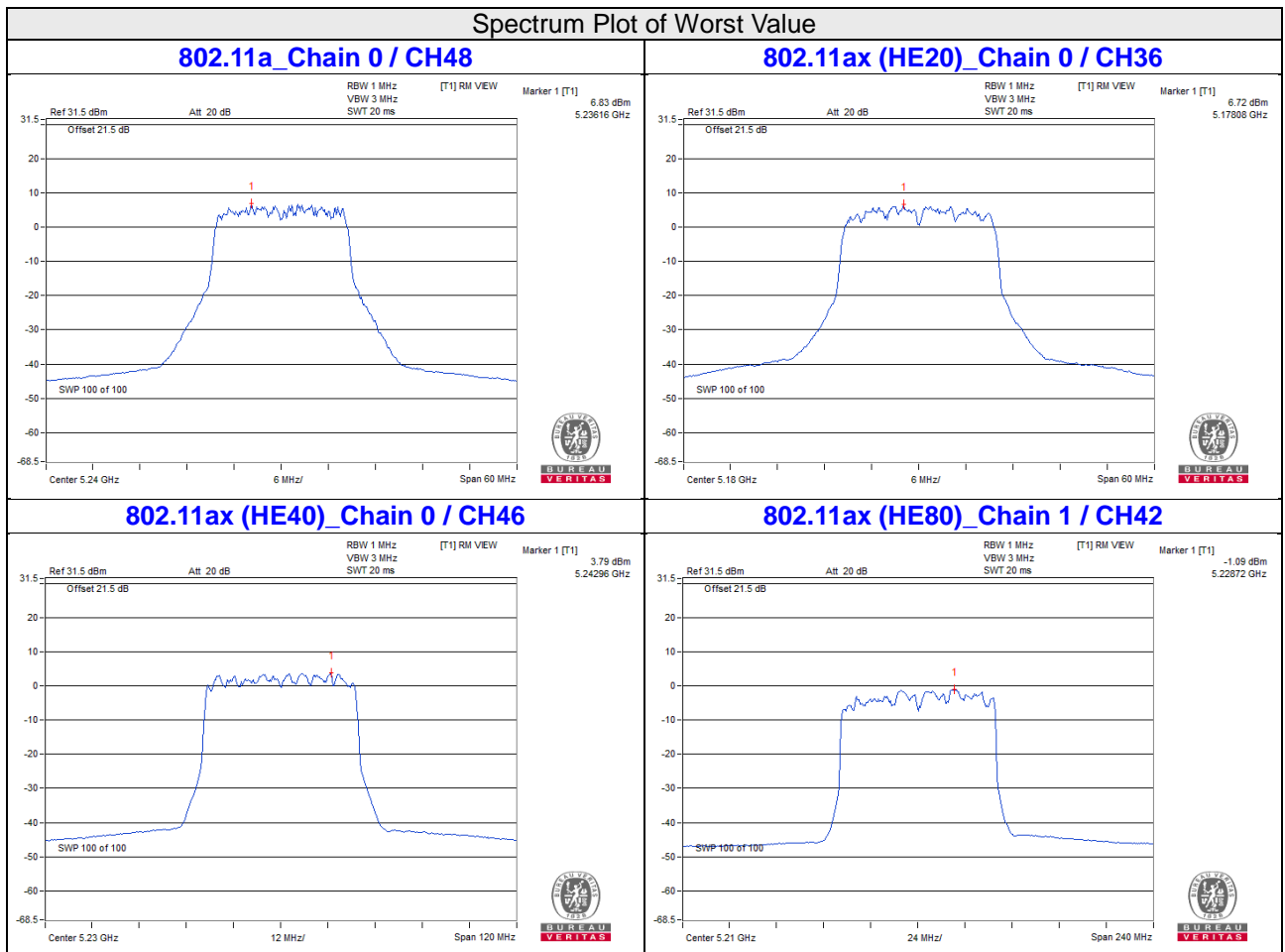

For U-NII-3:

CDD Mode

802.11a

Chan.	Chan. Freq. (MHz)	PSD w/o Duty Factor (dBm/300kHz)		Duty Factor (dB)	Total PSD (mW/300kHz)	Total PSD (dBm/300kHz)	Total PSD (dBm/500kHz)	PSD Limit (dBm/500kHz)	Pass / Fail
		Chain 0	Chain 1						
149	5745	3.90	1.76	0.36	4.294	6.33	8.55	29.24	PASS
157	5785	3.67	1.31	0.36	3.996	6.02	8.24	29.24	PASS
165	5825	3.47	2.07	0.36	4.163	6.19	8.41	29.24	PASS

- Note: 1. Method b) Measure and sum spectral maxima across the outputs of KDB 662911 is using for calculating total power density.
 2. The directional gain = $10 \log[(10^{G1/20} + 10^{G2/20})^2 / 2] = 6.76\text{dBi} > 6\text{dBi}$, so the power density limit shall be reduced to $30-(6.76-6) = 29.24 \text{ dBm}$.
 3. Refer to section 3.3 for duty cycle spectrum plot.

802.11ax (HE20)

Chan.	Chan. Freq. (MHz)	PSD w/o Duty Factor (dBm/300kHz)		Duty Factor (dB)	Total PSD (mW/300kHz)	Total PSD (dBm/300kHz)	Total PSD (dBm/500kHz)	PSD Limit (dBm/500kHz)	Pass / Fail
		Chain 0	Chain 1						
149	5745	1.86	-0.41	0.22	2.5738	4.11	6.33	29.24	PASS
157	5785	1.25	-0.42	0.22	2.3599	3.73	5.95	29.24	PASS
165	5825	1.89	-0.13	0.22	2.6488	4.23	6.45	29.24	PASS

- Note: 1. Method b) Measure and sum spectral maxima across the outputs of KDB 662911 is using for calculating total power density.
 2. The directional gain = $10 \log[(10^{G1/20} + 10^{G2/20})^2 / 2] = 6.76\text{dBi} > 6\text{dBi}$, so the power density limit shall be reduced to $30-(6.76-6) = 29.24 \text{ dBm}$.
 3. Refer to section 3.3 for duty cycle spectrum plot.

802.11ax (HE40)

Chan.	Chan. Freq. (MHz)	PSD w/o Duty Factor (dBm/300kHz)		Duty Factor (dB)	Total PSD (mW/300kHz)	Total PSD (dBm/300kHz)	Total PSD (dBm/500kHz)	PSD Limit (dBm/500kHz)	Pass / Fail
		Chain 0	Chain 1						
151	5755	-1.15	-3.12	0.23	1.323	1.22	3.44	29.24	PASS
159	5795	-0.84	-2.60	0.23	1.4482	1.61	3.83	29.24	PASS

- Note: 1. Method b) Measure and sum spectral maxima across the outputs of KDB 662911 is using for calculating total power density.
 2. The directional gain = $10 \log[(10^{G1/20} + 10^{G2/20})^2 / 2] = 6.76\text{dBi} > 6\text{dBi}$, so the power density limit shall be reduced to $30-(6.76-6) = 29.24 \text{ dBm}$.
 3. Refer to section 3.3 for duty cycle spectrum plot.

802.11ax (HE80)

Chan.	Chan. Freq. (MHz)	PSD w/o Duty Factor (dBm/300kHz)		Duty Factor (dB)	Total PSD (mW/300kHz)	Total PSD (dBm/300kHz)	Total PSD (dBm/500kHz)	PSD Limit (dBm/500kHz)	Pass / Fail
		Chain 0	Chain 1						
155	5775	-3.71	-5.76	0.22	0.7273	-1.38	0.84	29.24	PASS

- Note: 1. Method b) Measure and sum spectral maxima across the outputs of KDB 662911 is using for calculating total power density.
 2. The directional gain = $10 \log[(10^{G1/20} + 10^{G2/20})^2 / 2]$ = 6.76dBi > 6dBi , so the power density limit shall be reduced to 30-(6.76-6) =29.24 dBm.
 3. Refer to section 3.3 for duty cycle spectrum plot.

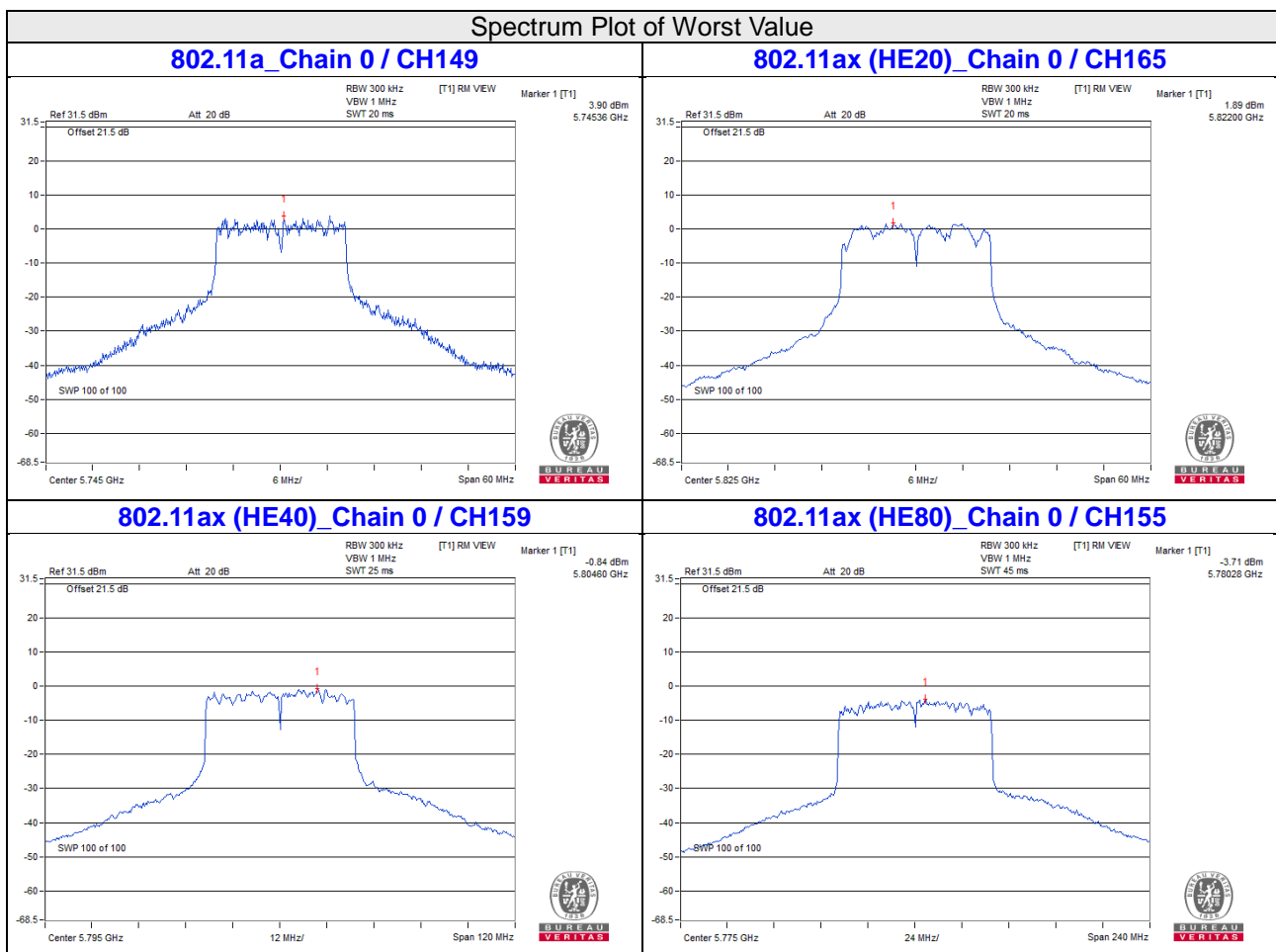

4.6 Frequency Stability Measurement

4.6.1 Limits of Frequency Stability Measurement

The frequency of the carrier signal shall be maintained within band of operation

4.6.2 Test Setup

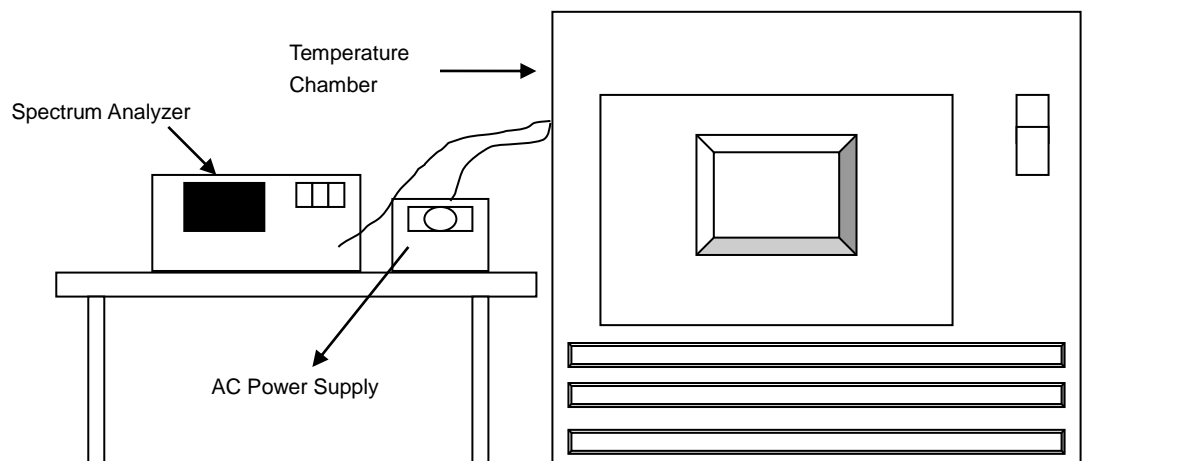

4.6.3 Test Instruments

Refer to section 4.1.2 to get information of above instrument.

4.6.4 Test Procedure

- The EUT was placed inside the environmental test chamber and powered by nominal AC voltage.
- Turn the EUT on and couple its output to a spectrum analyzer.
- Turn the EUT off and set the chamber to the highest temperature specified.
- Allow sufficient time (approximately 30 min) for the temperature of the chamber to stabilize, turn the EUT on and measure the operating frequency after 2, 5, and 10 Minutes.
- Repeat step (d) with the temperature chamber set to the next desired temperature until measurements down to the lowest specified temperature have been completed.
- The test chamber was allowed to stabilize at +20 degree C for a minimum of 30 Minutes. The supply voltage was then adjusted on the EUT from 85% to 115% and the frequency record.

4.6.5 Deviation from Test Standard

No deviation.

4.6.6 EUT Operating Condition

Set the EUT transmit at un-modulation mode to test frequency stability.

4.6.7 Test Results

Frequency Stability Versus Temp.									
Operating Frequency: 5180 MHz									
TEMP. (°C)	Power Supply (Vac)	0 Minute		2 Minutes		5 Minutes		10 Minutes	
		Measured Frequency (MHz)	Pass/Fail	Measured Frequency (MHz)	Pass/Fail	Measured Frequency (MHz)	Pass/Fail	Measured Frequency (MHz)	Pass/Fail
40	120	5180.0196	PASS	5180.0201	PASS	5180.0182	PASS	5180.0183	PASS
30	120	5180.002	PASS	5180.0012	PASS	5180.0042	PASS	5180.0035	PASS
20	120	5179.9996	PASS	5179.9984	PASS	5180.0011	PASS	5179.9966	PASS
10	120	5179.9789	PASS	5179.9781	PASS	5179.9794	PASS	5179.9765	PASS
0	120	5179.9763	PASS	5179.9727	PASS	5179.9755	PASS	5179.9739	PASS

Frequency Stability Versus Voltage									
Operating Frequency: 5180 MHz									
TEMP. (°C)	Power Supply (Vac)	0 Minute		2 Minutes		5 Minutes		10 Minutes	
		Measured Frequency (MHz)	Pass/Fail	Measured Frequency (MHz)	Pass/Fail	Measured Frequency (MHz)	Pass/Fail	Measured Frequency (MHz)	Pass/Fail
20	138	5179.999	PASS	5179.9993	PASS	5180.0018	PASS	5179.9963	PASS
	120	5179.9996	PASS	5179.9984	PASS	5180.0011	PASS	5179.9966	PASS
	102	5179.9993	PASS	5179.9989	PASS	5180.0009	PASS	5179.9959	PASS

4.7 6dB Bandwidth Measurement

4.7.1 Limits of 6dB Bandwidth Measurement

The minimum of 6dB Bandwidth Measurement is 0.5MHz.

4.7.2 Test Setup

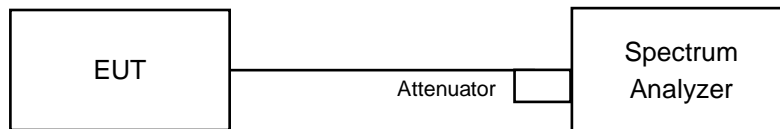

4.7.3 Test Instruments

Refer to section 4.1.2 to get information of above instrument.

4.7.4 Test Procedure

MEASUREMENT PROCEDURE REF

- Set resolution bandwidth (RBW) = 100kHz
- Set the video bandwidth (VBW) $\geq 3 \times$ RBW, Detector = Peak.
- Trace mode = max hold.
- Sweep = auto couple.
- Measure the maximum width of the emission that is constrained by the frequencies associated with the two amplitude points (upper and lower) that are attenuated by 6 dB relative to the maximum level measured in the fundamental emission.

4.7.5 Deviation from Test Standard

No deviation.

4.7.6 EUT Operating Condition

The software provided by client to enable the EUT under transmission condition continuously at lowest, middle and highest channel frequencies individually.

4.7.7 Test Results

CDD Mode

802.11a

Channel	Frequency (MHz)	6dB Bandwidth (MHz)		Minimum Limit (MHz)	Pass / Fail
		Chain 0	Chain 1		
149	5745	16.08	16.31	0.5	Pass
157	5785	16.07	16.09	0.5	Pass
165	5825	15.81	16.06	0.5	Pass

802.11ax (HE20)

Channel	Frequency (MHz)	6dB Bandwidth (MHz)		Minimum Limit (MHz)	Pass / Fail
		Chain 0	Chain 1		
149	5745	18.56	18.14	0.5	Pass
157	5785	18.4	18.15	0.5	Pass
165	5825	18.34	18.44	0.5	Pass

802.11ax (HE40)

Channel	Frequency (MHz)	6dB Bandwidth (MHz)		Minimum Limit (MHz)	Pass / Fail
		Chain 0	Chain 1		
151	5755	37.87	37.83	0.5	Pass
159	5795	38.09	38.04	0.5	Pass

802.11ax (HE80)

Channel	Frequency (MHz)	6dB Bandwidth (MHz)		Minimum Limit (MHz)	Pass / Fail
		Chain 0	Chain 1		
155	5775	77.56	75.66	0.5	Pass

Spectrum Plot of Worst Value

802.11a_Chain 0 / CH165

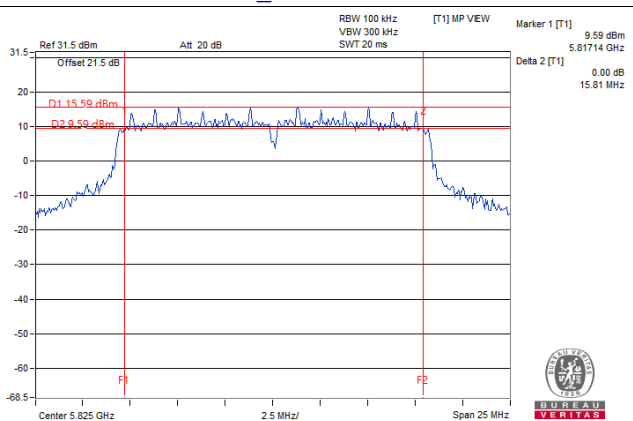

802.11ax (HE20)_Chain 1 / CH149

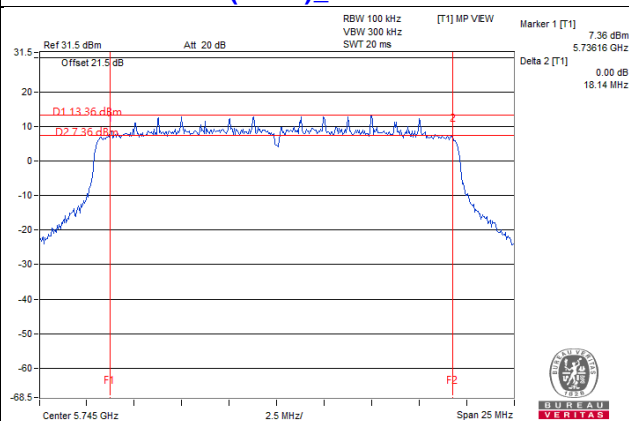

802.11ax (HE40)_Chain 1 / CH151

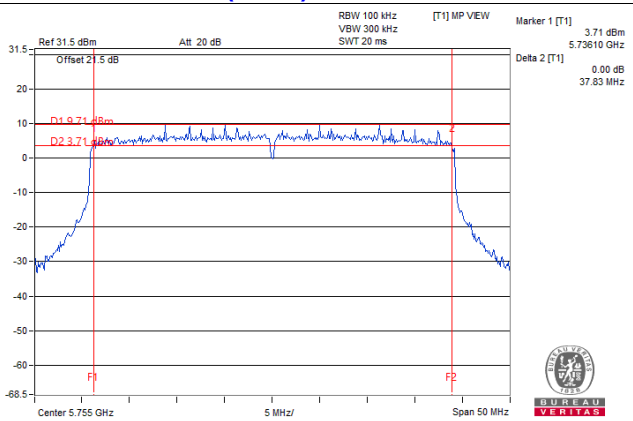

802.11ax (HE80)_Chain 0 / CH155

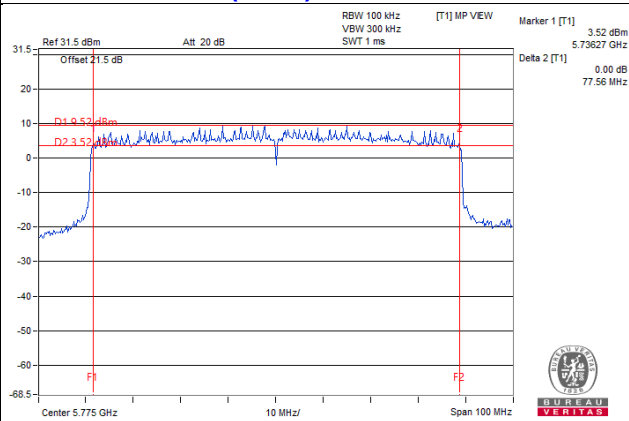

5 Pictures of Test Arrangements

Please refer to the attached file (Test Setup Photo).

Annex A- Radiated Out of Band Emission (OOBE) Measurement (For U-NII-3 band)

802.11a CH 149 : 5745 MHz

Horizontal

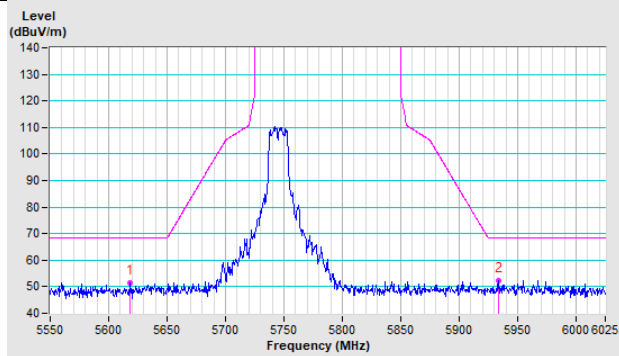

Vertical

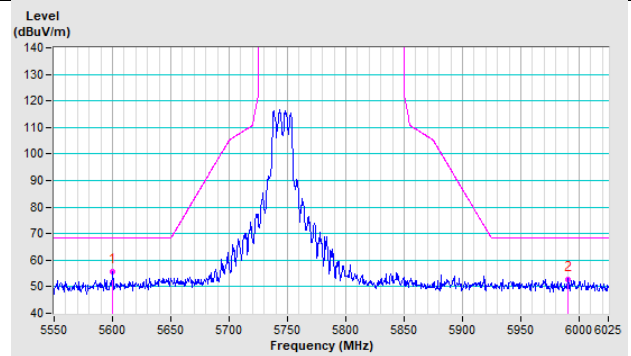

802.11a CH 157 : 5785 MHz

Horizontal

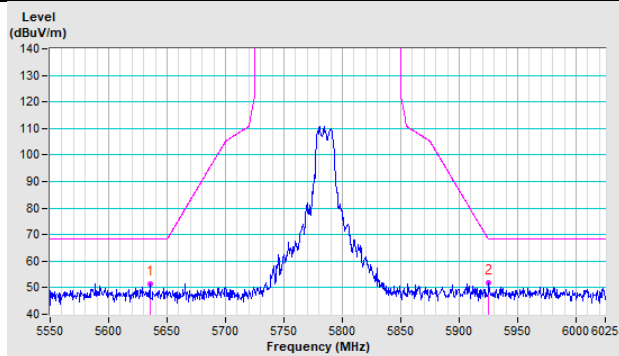

Vertical

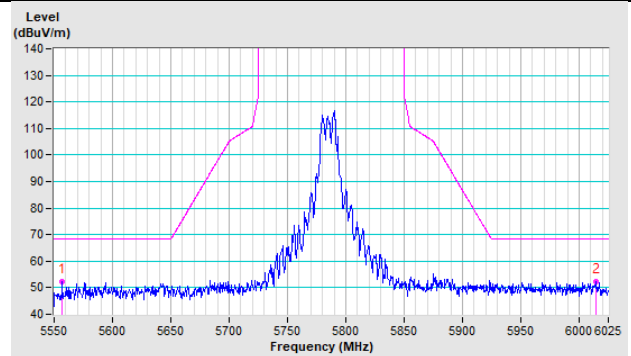

802.11a CH 165 : 5825 MHz

Horizontal

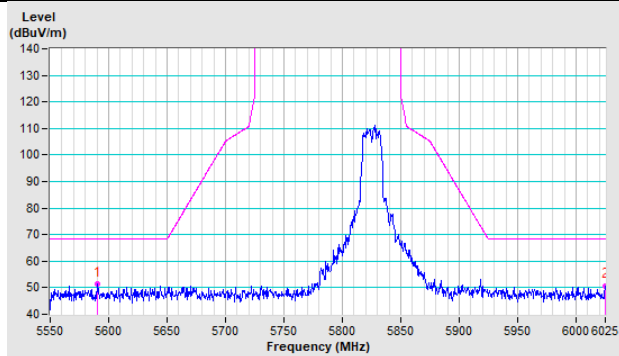

Vertical

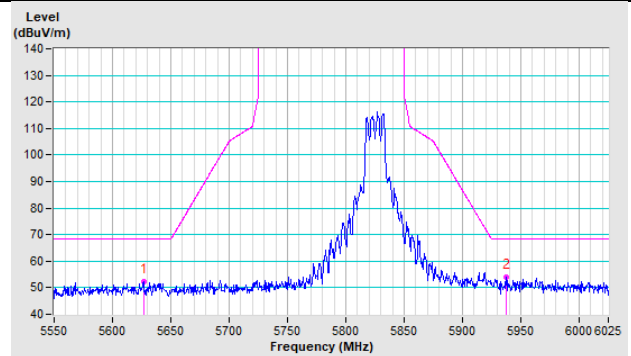

802.11ax (HE20) CH 149 : 5745 MHz

Horizontal

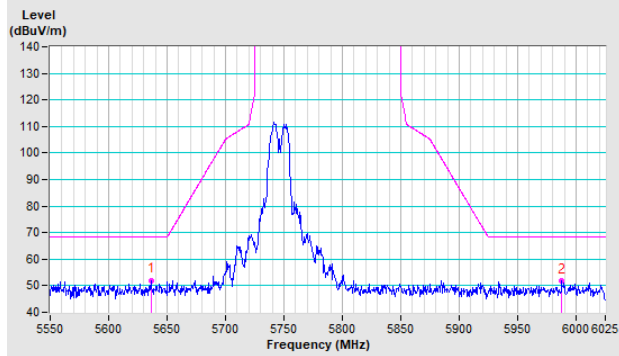

Vertical

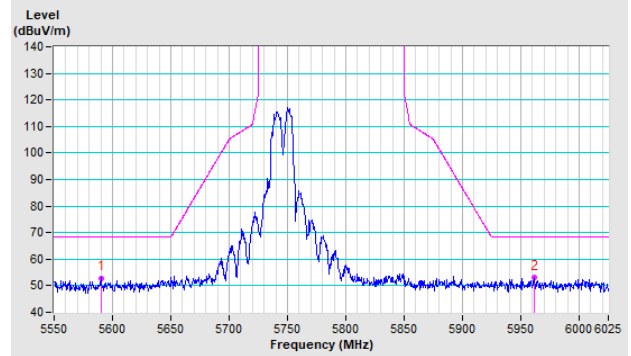

802.11ax (HE20) CH 157 : 5785 MHz

Horizontal

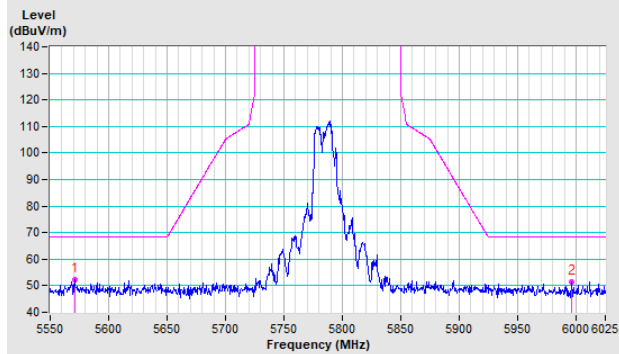

Vertical

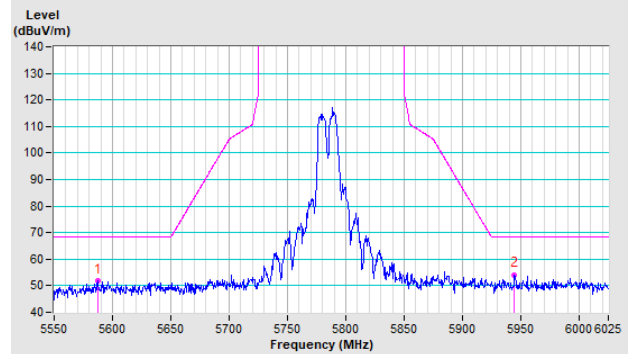

802.11ax (HE20) CH 165 : 5825 MHz

Horizontal

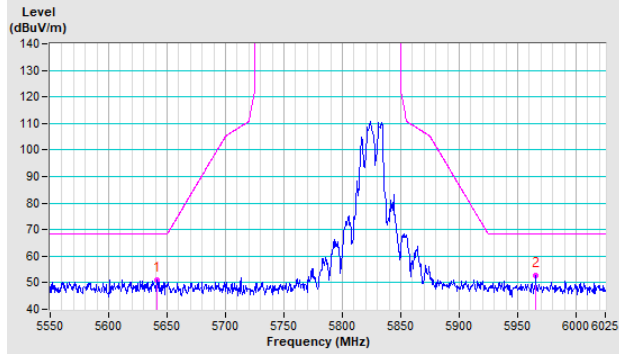

Vertical

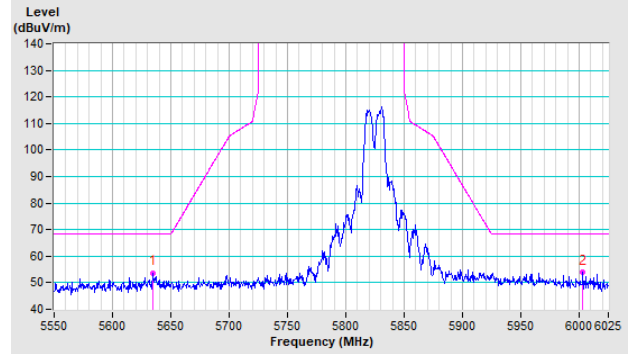

802.11ax (HE40) CH 151 : 5755 MHz

Horizontal

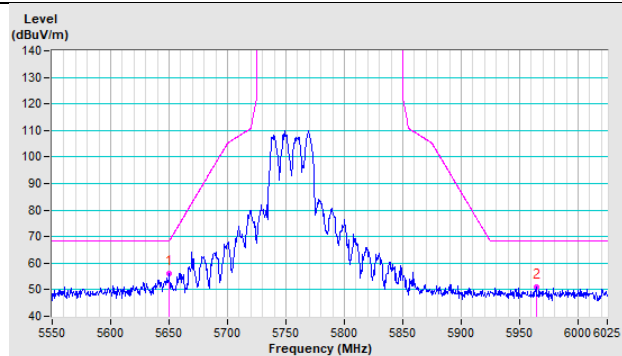

Vertical

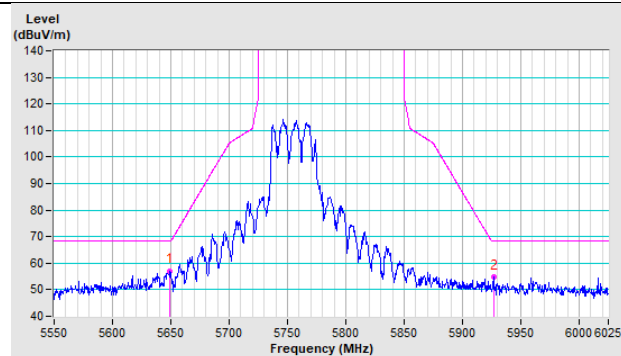

802.11ax (HE40) CH 159 : 5795 MHz

Horizontal

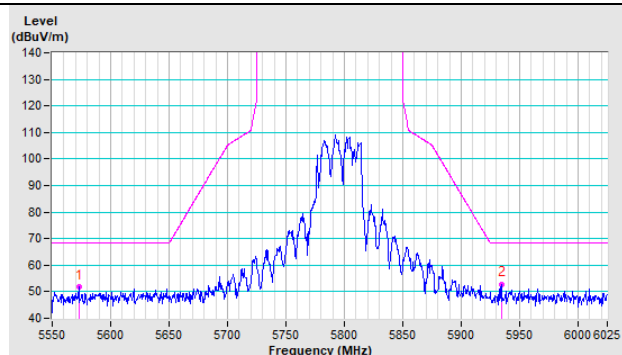

Vertical

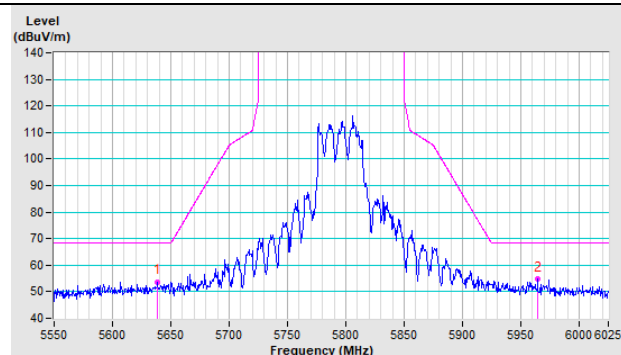

802.11ax (HE80) CH 155 : 5775 MHz

Horizontal

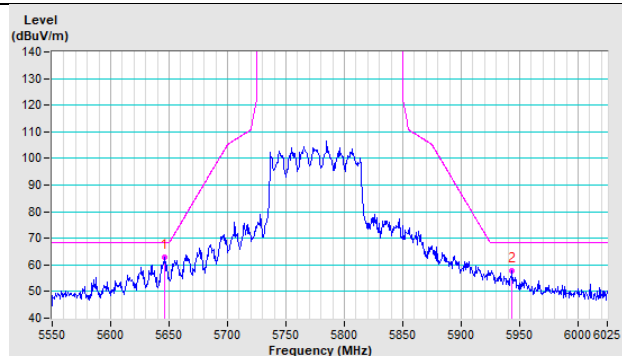

Vertical

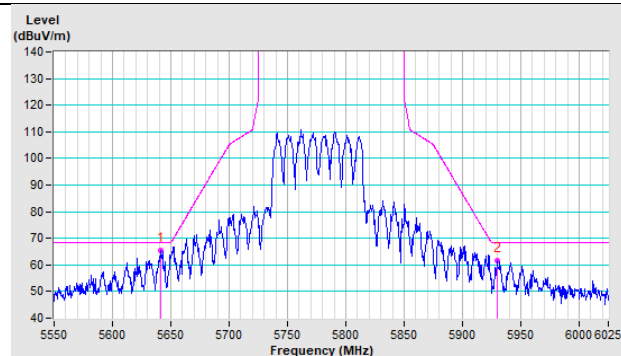

Annex B- Band-edge measurement (For U-NII-1 band)

802.11a

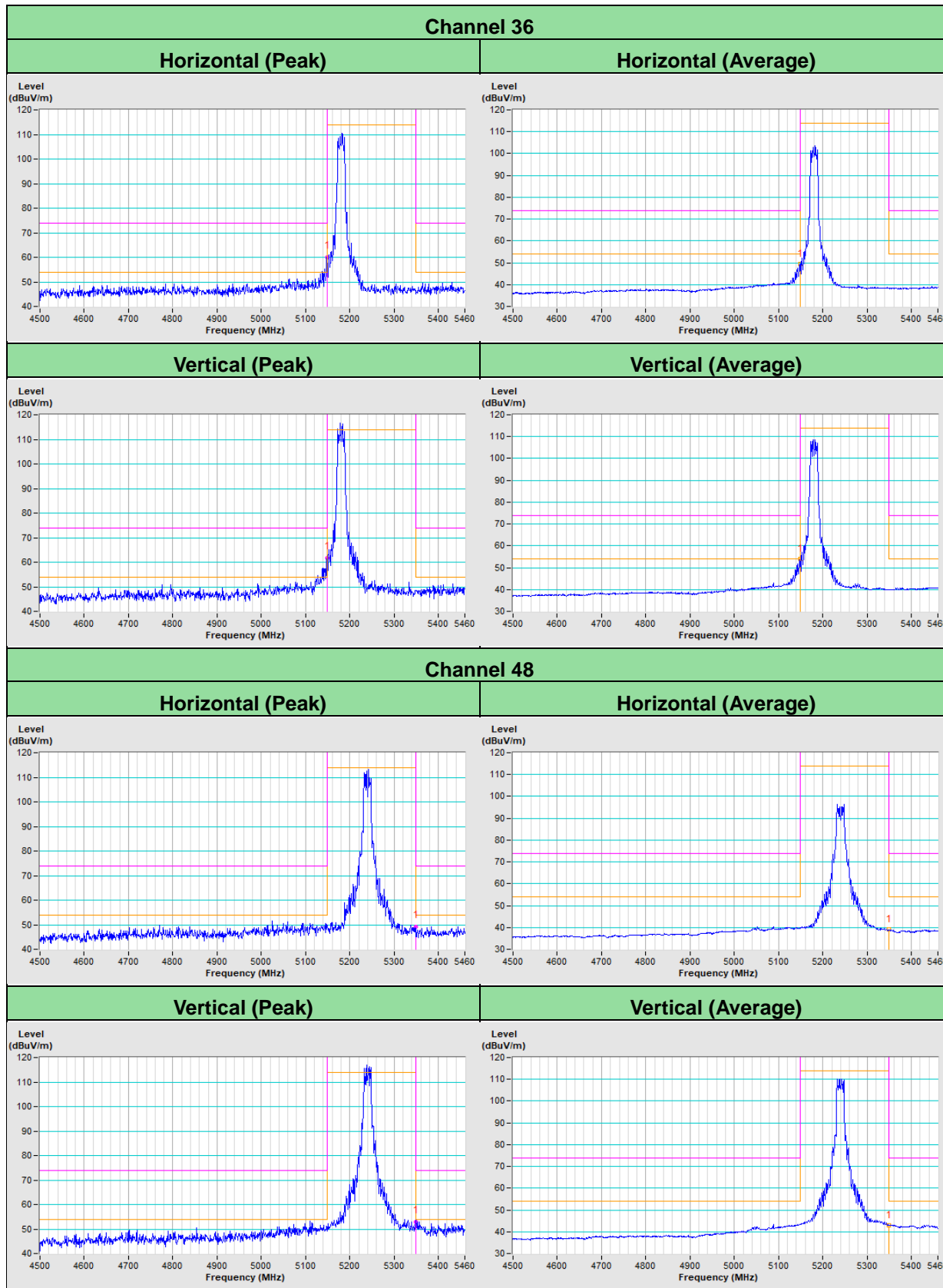

802.11ax (HE20)

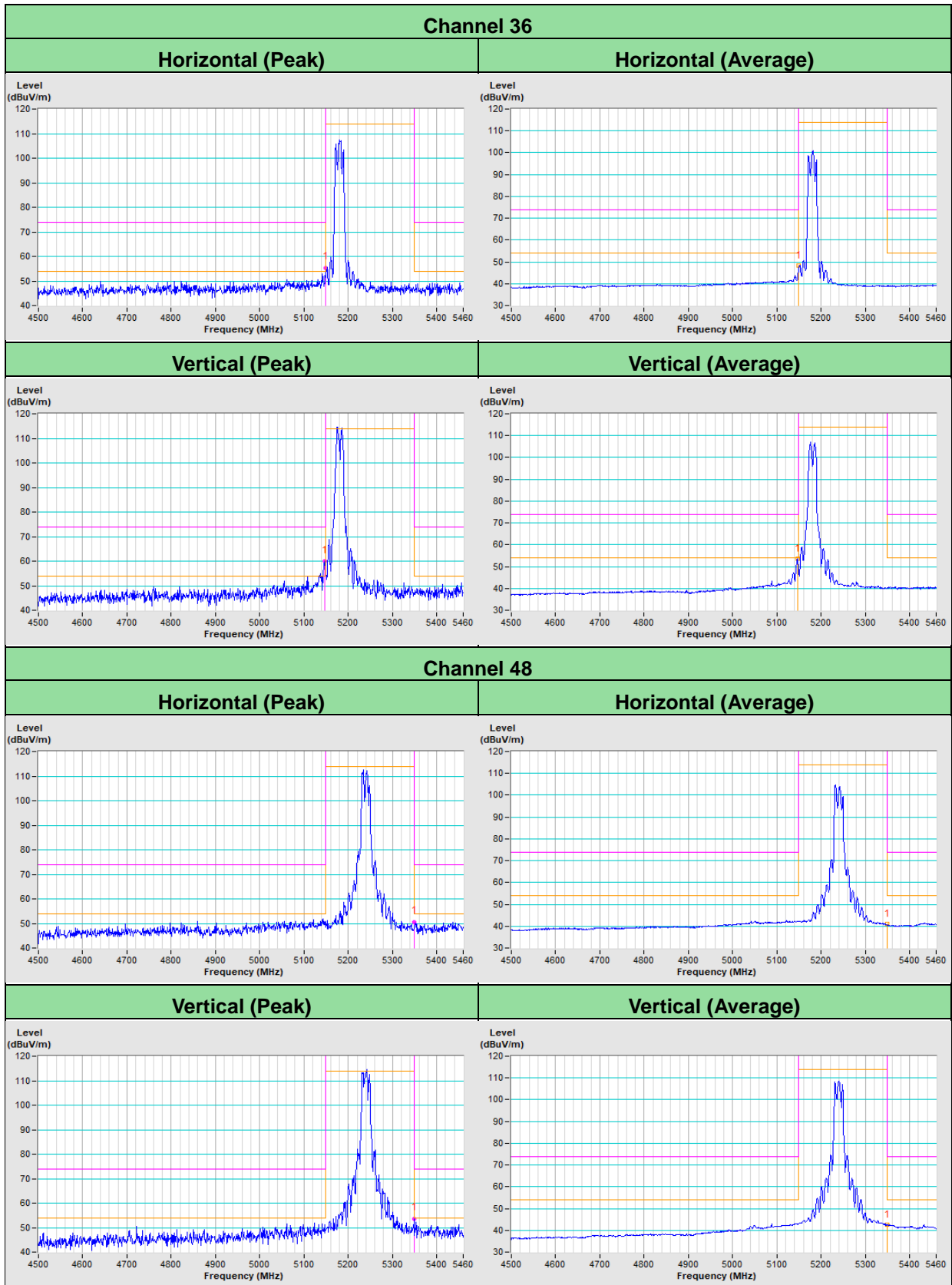

802.11ax (HE40)

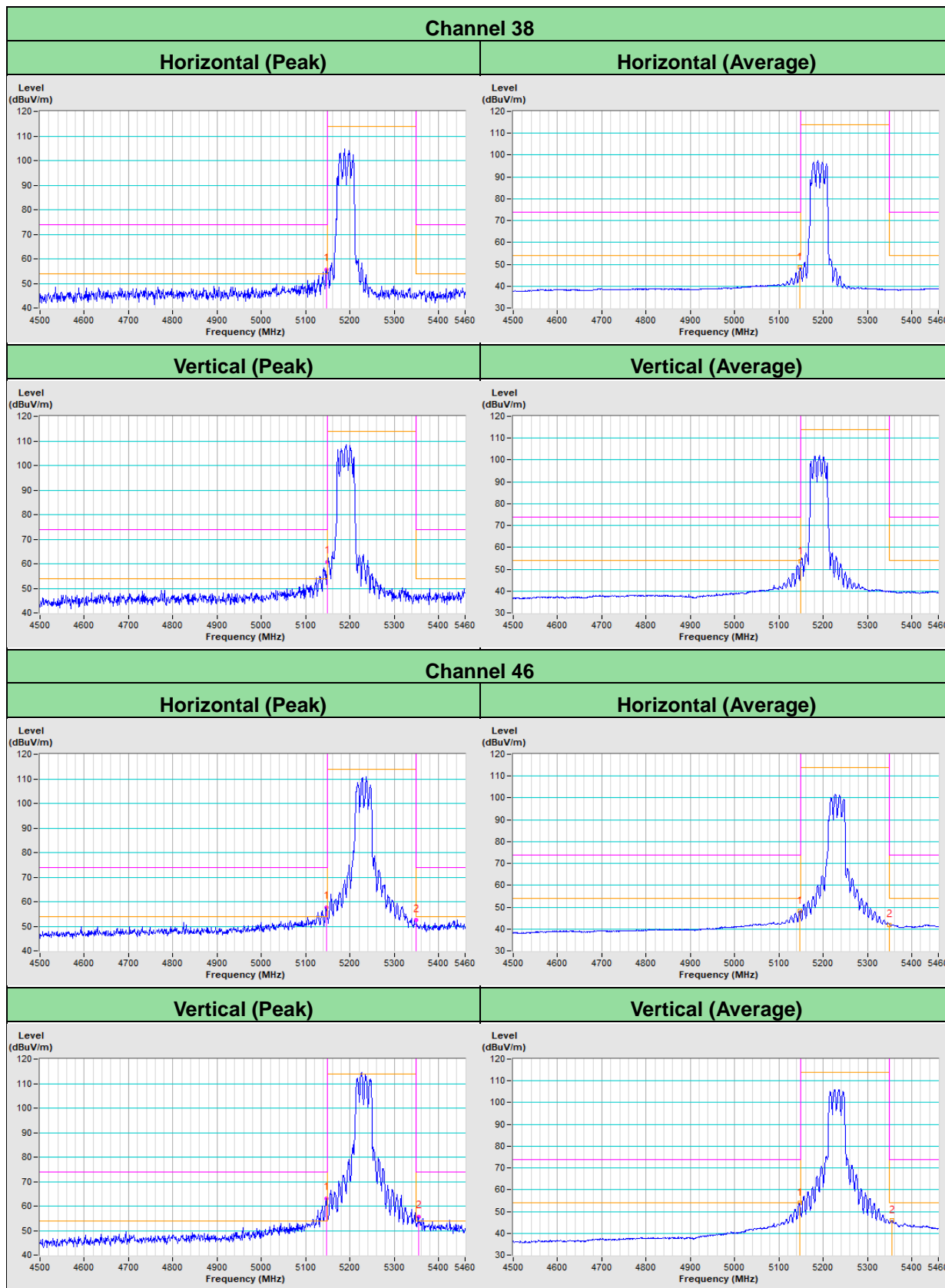

802.11ax (HE80)

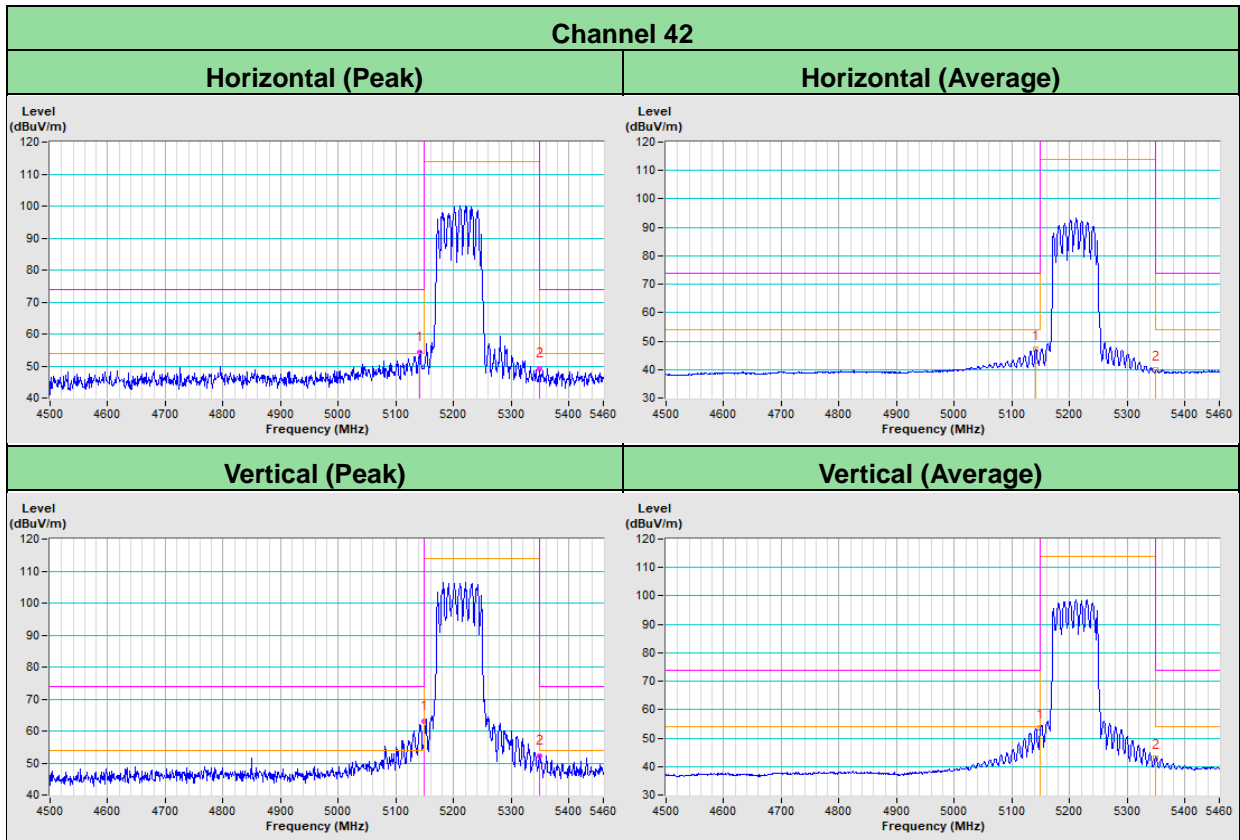

Appendix – Information of the Testing Laboratories

We, Bureau Veritas Consumer Products Services (H.K.) Ltd., Taoyuan Branch, were founded in 1988 to provide our best service in EMC, Radio, Telecom and Safety consultation. Our laboratories are FCC recognized accredited test firms and accredited according to ISO/IEC 17025.

If you have any comments, please feel free to contact us at the following:

Lin Kou EMC/RF Lab

Tel: 886-2-26052180

Fax: 886-2-26051924

Hsin Chu EMC/RF/Telecom Lab

Tel: 886-3-6668565

Fax: 886-3-6668323

Hwa Ya EMC/RF/Safety Lab

Tel: 886-3-3183232

Fax: 886-3-3270892

Email: service.adt@tw.bureauveritas.com

Web Site: www.bureauveritas-adt.com

The address and road map of all our labs can be found in our web site also.

--- END ---