

DFS Test Report

Report No.: RFB DWR-WTW-P20070121 R2

FCC ID: 2AHKM-CODA5519

Test Model: CODA-5519

Series Model: CODA-5512, CODA-5719, CODA-5712, CODA-5610, CODA-5810,
CODA-5814, CODA5610

Received Date: July 07, 2020

Test Date: July 24 to 31, 2020

Issued Date: Aug. 20, 2020

Applicant: Hitron Technologies Inc.

Address: No. 1-8, Li-Hsin 1st Rd. Hsinchu Science Park, Hsinchu 30078, Taiwan

Issued By: Bureau Veritas Consumer Products Services (H.K.) Ltd., Taoyuan Branch
Hsin Chu Laboratory

Lab Address: E-2, No.1, Li Hsin 1st Road, Hsinchu Science Park, Hsinchu City 300,
Taiwan

Test Location: E-2, No.1, Li Hsin 1st Road, Hsinchu Science Park, Hsinchu City 300,
Taiwan

**FCC Registration /
Designation Number:** 723255 / TW2022



This report is for your exclusive use. Any copying or replication of this report to or for any other person or entity, or use of our name or trademark, is permitted only with our prior written permission. This report sets forth our findings solely with respect to the test samples identified herein. The results set forth in this report are not indicative or representative of the quality or characteristics of the lot from which a test sample was taken or any similar or identical product unless specifically and expressly noted. Our report includes all of the tests requested by you and the results thereof based upon the information that you provided to us. You have 60 days from date of issuance of this report to notify us of any material error or omission caused by our negligence, provided, however, that such notice shall be in writing and shall specifically address the issue you wish to raise. A failure to raise such issue within the prescribed time shall constitute your unqualified acceptance of the completeness of this report, the tests conducted and the correctness of the report contents. Unless specific mention, the uncertainty of measurement has been explicitly taken into account to declare the compliance or non-compliance to the specification.

Table of Contents

| | |
|--|-----------|
| Release Control Record | 3 |
| 1 Certificate of Conformity | 4 |
| 2 EUT Information | 5 |
| 2.1 Operating Frequency Bands and Mode of EUT | 5 |
| 2.2 EUT Software and Firmware Version | 5 |
| 2.3 Description of Available Antennas to the EUT | 6 |
| 2.4 EUT Maximum and Minimum Conducted Power | 7 |
| 2.5 EUT Maximum and Minimum EIRP Power | 7 |
| 2.6 Transmit Power Control (TPC) | 8 |
| 2.7 Statement of Manufacturer | 8 |
| 3. U-NII DFS Rule Requirements | 9 |
| 3.1 Working Modes and Required Test Items | 9 |
| 3.2 Test Limits and Radar Signal Parameters | 10 |
| 4. Test & Support Equipment List | 13 |
| 4.1 Test Instruments | 13 |
| 4.2 Description of Support Units | 13 |
| 5. Test Procedure | 14 |
| 5.1 DFS Measurement System | 14 |
| 5.2 Calibration of DFS Detection Threshold Level | 15 |
| 5.3 Deviation from Test Standard | 15 |
| 5.4 Radiated Test Setup Configuration | 16 |
| 6. Test Results | 17 |
| 6.1 Summary of Test Results | 17 |
| 6.2 Test Results | 18 |
| 6.2.1 Test Mode: Device Operating In Master Mode | 18 |
| 6.2.2 U-NII Detection Bandwidth | 23 |
| 6.2.3 Channel Availability Check Time | 33 |
| 6.2.4 Channel Closing Transmission and Channel Move Time | 35 |
| 6.2.5 Non- Occupancy Period | 70 |
| 7. Information of the Testing Laboratories | 72 |
| 8. APPENDIX-A | 73 |

Release Control Record

| Issue No. | Description | Date Issued |
|-------------------------|--|---------------|
| RFBDWR-WTW-P20070121 | Original release. | Aug. 11, 2020 |
| RFBDWR-WTW-P20070121 R1 | Removed model name: CODA-5714 | Aug. 12, 2020 |
| RFBDWR-WTW-P20070121 R2 | 1. Added the one model name: CODA5610. 2. Modified the format of the antenna table. | Aug. 20, 2020 |

1 Certificate of Conformity

Product: DOCSIS 3.1 Wi-Fi 6 EMTA Gateway

Brand: hitron

Test Model: CODA-5519

Series Model: CODA-5512, CODA-5719, CODA-5712, CODA-5610, CODA-5810, CODA-5814, CODA5610

Sample Status: ENGINEERING SAMPLE

Applicant: Hitron Technologies Inc.

Test Date: July 24 to 31, 2020

Standards: FCC Part 15, Subpart E (Section 15.407)

KDB 905462 D02 UNII DFS Compliance Procedures New Rules v02

The above equipment has been tested by **Bureau Veritas Consumer Products Services (H.K.) Ltd., Taoyuan Branch**, and found compliance with the requirement of the above standards. The test record, data evaluation & Equipment Under Test (EUT) configurations represented herein are true and accurate accounts of the measurements of the sample's EMC characteristics under the conditions specified in this report.

Prepared by :  , **Date:** Aug. 20, 2020
Claire Kuan / Specialist

Approved by :  , **Date:** Aug. 20, 2020
Clark Lin / Technical Manager

2 EUT Information

2.1 Operating Frequency Bands and Mode of EUT

Table 1: Operating Frequency Bands and Mode of EUT

| Operational Mode | Operating Frequency Range | |
|------------------|---------------------------|--------------|
| | 5250~5350MHz | 5470~5725MHz |
| Master | ✓ | ✓ |

2.2 EUT Software and Firmware Version

Table 2: The EUT Software/Firmware Version

| No. | Product | Model No. | Software/Firmware Version |
|-----|---------------------------------|-----------|---------------------------|
| 1 | DOCSIS 3.1 Wi-Fi 6 EMTA Gateway | CODA-5519 | IntelCE-7.2.3.01b14 |

2.3 Description of Available Antennas to the EUT

Table 3: Antenna List

| Ant. | Port | Brand | Model Name | Type | Connector | Gain (dBi) | | | | |
|------|------|--------|----------------|------|-----------|------------|----------------|----------------|----------------|----------------|
| | | | | | | 2.4GHz | 5GHz Band 1 | 5GHz Band 2 | 5GHz Band 3 | 5GHz Band 4 |
| 1 | 3 | WIESON | GY196HC112-011 | PCB | MHF | 2.8 | 2.6 | 3 | 3.4 | 3 |
| 2 | 2 | WIESON | GY196HC112-012 | PCB | MHF | 2.8 | 2.6 | 3 | 3.4 | 3 |
| 3 | 1 | WIESON | GY196HC112-013 | PCB | MHF | 2.8 | 2.6 | 3 | 3.4 | 3 |
| 4 | 4 | WIESON | GY196HC112-014 | PCB | MHF | 2.8 | 2.6 | 3 | 3.4 | 3 |

*The above Antenna information is declared by manufacturer and for more detailed features description, please refer to the manufacturer's specifications, the laboratory shall not be held responsible.

2.4 EUT Maximum and Minimum Conducted Power

Table 4: The Measured Conducted Output Power

CDD Mode

| Frequency Band (MHz) | MAX. Power | | MIN. Power | |
|----------------------|-------------------|--------------------|-------------------|--------------------|
| | Output Power (mW) | Output Power (dBm) | Output Power (mW) | Output Power (dBm) |
| 5250~5350 | 236.592 | 23.74 | 59.429 | 17.74 |
| 5470~5725 | 247.172 | 23.93 | 62.087 | 17.93 |

2.5 EUT Maximum and Minimum EIRP Power

Table 5: The EIRP Output Power List

CDD Mode

| Frequency Band (MHz) | MAX. EIRP Power | | MIN. EIRP Power | |
|----------------------|-------------------|--------------------|-------------------|--------------------|
| | Output Power (mW) | Output Power (dBm) | Output Power (mW) | Output Power (dBm) |
| 5250~5350 | 472.063 | 26.74 | 118.577 | 20.74 |
| 5470~5725 | 540.754 | 27.33 | 135.831 | 21.33 |

2.6 Transmit Power Control (TPC)

U-NII devices operating in the 5.25-5.35 GHz band and the 5.47-5.725 GHz band shall employ a TPC mechanism. The U-NII device is required to have the capability to operate at least 6 dB below the mean EIRP value of 30 dBm. A TPC mechanism is not required for systems with an e.i.r.p. of less than 500 mW.

| Applicable | EIRP | FCC 15.407 (h)(1) |
|------------|--------|---|
| √ | >500mW | The TPC mechanism is required for system with an EIRP of above 500mW |
| | <500mW | The TPC mechanism is not required for system with an EIRP of less 500mW |

The UUT can adjust a transmitter's output power based on the signal level present at the receiver. TPC is auto controlled by software.

2.7 Statement of Manufacturer

Manufacturer statement confirming that information regarding the parameters of the detected Radar Waveforms is not available to the end user.

3. U-NII DFS Rule Requirements

3.1 Working Modes and Required Test Items

The manufacturer shall state whether the UUT is capable of operating as a Master and/or a Client. If the UUT is capable of operating in more than one operating mode then each operating mode shall be tested separately. See tables 6 and 7 for the applicability of DFS requirements for each of the operational modes.

Table 6: Applicability of DFS Requirements Prior to Use a Channel

| Requirement | Operational Mode | | |
|---------------------------------|------------------|--------------------------------|-----------------------------|
| | Master | Client without radar detection | Client with radar detection |
| Non-Occupancy Period | ✓ | ✓ note | ✓ |
| DFS Detection Threshold | ✓ | Not required | ✓ |
| Channel Availability Check Time | ✓ | Not required | Not required |
| U-NII Detection Bandwidth | ✓ | Not required | ✓ |

Note: Per KDB 905462 D03 UNII Clients Without Radar Detection New Rules v01r02 section (b)(5/6), If the client moves with the master, the device is considered compliant if nothing appears in the client non-occupancy period test. For devices that shut down (rather than moving channels), no beacons should appear. An analyzer plot that contains a single 30-minute sweep on the original channel.

Table 7: Applicability of DFS Requirements during Normal Operation

| Requirement | Operational Mode | |
|-----------------------------------|---------------------------------------|--------------------------------|
| | Master or Client with radar detection | Client without radar detection |
| DFS Detection Threshold | ✓ | Not required |
| Channel Closing Transmission Time | ✓ | ✓ |
| Channel Move Time | ✓ | ✓ |
| U-NII Detection Bandwidth | ✓ | Not required |

| Additional requirements for devices with multiple bandwidth modes | Master or Client with radar detection | Client without radar detection |
|---|---------------------------------------|--|
| U-NII Detection Bandwidth and Statistical Performance Check | All BW modes must be tested | Not required |
| Channel Move Time and Channel Closing Transmission Time | Test using widest BW mode available | Test using the widest BW mode available for the link |
| All other tests | Any single BW mode | Not required |

Note: Frequencies selected for statistical performance check (Section 7.8.4) should include several frequencies within the radar detection bandwidth and frequencies near the edge of the radar detection bandwidth. For 802.11 devices it is suggested to select frequencies in each of the bonded 20 MHz channels and the channel center frequency.

3.2 Test Limits and Radar Signal Parameters

Detection Threshold Values

Table 8: DFS Detection Thresholds for Master Devices and Client Devices with Radar Detection

| Maximum Transmit Power | Value (See Notes 1, 2, and 3) |
|---|----------------------------------|
| EIRP \geq 200 milliwatt | -64 dBm |
| EIRP < 200 milliwatt and power spectral density < 10 dBm/MHz | -62 dBm |
| EIRP < 200 milliwatt that do not meet the power spectral density requirement | -64 dBm |

Note 1: This is the level at the input of the receiver assuming a 0 dBi receive antenna.

Note 2: Throughout these test procedures an additional 1 dB has been added to the amplitude of the test transmission waveforms to account for variations in measurement equipment. This will ensure that the test signal is at or above the detection threshold level to trigger a DFS response.

Note 3: EIRP is based on the highest antenna gain. For MIMO devices refer to KDB Publication 662911 D01.

Table 9: DFS Response Requirement Values

| Parameter | Value |
|-----------------------------------|---|
| Non-occupancy period | Minimum 30 minutes |
| Channel Availability Check Time | 60 seconds |
| Channel Move Time | 10 seconds See Note 1. |
| Channel Closing Transmission Time | 200 milliseconds + an aggregate of 60 milliseconds over remaining 10 second period. See Notes 1 and 2. |
| U-NII Detection Bandwidth | Minimum 100% of the U-NII 99% transmission power bandwidth. See Note 3 |

Note 1: Channel Move Time and the Channel Closing Transmission Time should be performed with Radar Type 0. The measurement timing begins at the end of the Radar Type 0 burst.

Note 2: The Channel Closing Transmission Time is comprised of 200 milliseconds starting at the beginning of the Channel Move Time plus any additional intermittent control signals required to facilitate a Channel move (an aggregate of 60 milliseconds) during the remainder of the 10 second period. The aggregate duration of control signals will not count quiet periods in between transmissions.

Note 3: During the U-NII Detection Bandwidth detection test, radar type 0 should be used. For each frequency step the minimum percentage of detection is 90 percent. Measurements are performed with no data traffic.

Parameters of DFS Test Signals

Step intervals of 0.1 microsecond for Pulse Width, 1 microsecond for PRI, 1 MHz for chirp width and 1 for the number of pulses will be utilized for the random determination of specific test waveforms.

Table 10: Short Pulse Radar Test Waveforms

| Radar Type | Pulse Width (μsec) | PRI (μsec) | Number of Pulses | Minimum Percentage of Successful Detection | Minimum Number of Trials |
|--|--------------------|--|---|--|--------------------------|
| 0 | 1 | 1428 | 18 | See Note 1 | See Note 1 |
| 1 | 1 | Test A 15 unique PRI values randomly selected from the list of 23 PRI values | Roundup $\left\{ \begin{array}{l} \left(\frac{1}{360} \right) \cdot \\ \left(\frac{19 \cdot 10^6}{\text{PRI}_{\mu\text{sec}}} \right) \end{array} \right\}$ | 60% | 30 |
| | | 15 unique PRI values randomly selected within the range of 518~3066 μsec with a minimum of 1 μsec, excluding PRI values selected in Test A | | | |
| 2 | 1-5 | 150-230 | 23-29 | 60% | 30 |
| 3 | 6-10 | 200-500 | 16-18 | 60% | 30 |
| 4 | 11-20 | 200-500 | 12-16 | 60% | 30 |
| Aggregate (Radar Types 1-4) | | | | 80% | 120 |
| Note 1: Short Pulse Radar Type 0 should be used for the detection bandwidth test, channel move time, and channel closing time tests. | | | | | |

Table 11: Long Pulse Radar Test Waveform

| Radar Type | Pulse Width (µsec) | Chirp Width (MHz) | PRI (µsec) | Number of Pulses Per Burst | Number of Bursts | Minimum Percentage of Successful Detection | Minimum Number of Trials |
|------------|--------------------|-------------------|------------|----------------------------|------------------|--|--------------------------|
| 5 | 50-100 | 5-20 | 1000-2000 | 1-3 | 8-20 | 80% | 30 |

Three subsets of trials will be performed with a minimum of ten trials per subset. The subset of trials differ in where the Long Pulse Type 5 Signal is tuned in frequency.

- a) the Channel center frequency
- b) tuned frequencies such that 90% of the Long Pulse Type 5 frequency modulation is within the low edge of the UUT Occupied Bandwidth
- c) tuned frequencies such that 90% of the Long Pulse Type 5 frequency modulation is within the high edge of the UUT Occupied Bandwidth

It include 10 trails for every subset, the formula as below,

For subset case 1: the center frequency of the signal generator will remain fixed at the center of the UUT Channel.

For subset case 2: to retain 90% frequency overlap between the radar signal and the UUT Occupied Bandwidth, the center frequency of the signal generator will vary for each of the ten trials in subset case 2. The center frequency of the signal generator for each trial is calculated by:

$$FL+(0.4*Chirp\ Width\ [in\ MHz])$$

For subset case 3: to retain 90% frequency overlap between the radar signal and the UUT Occupied Bandwidth, the center frequency of the signal generator will vary for each of the ten trials in subset case 3. The center frequency of the signal generator for each trial is calculated by:

$$FH-(0.4*Chirp\ Width\ [in\ MHz])$$

Table 12: Frequency Hopping Radar Test Waveform

| Radar Type | Pulse Width (µsec) | PRI (µsec) | Pulses per Hop | Hopping Rate (kHz) | Hopping Sequence Length (msec) | Minimum Percentage of Successful Detection | Minimum Number of Trials |
|------------|--------------------|------------|----------------|--------------------|--------------------------------|--|--------------------------|
| 6 | 1 | 333 | 9 | 0.333 | 300 | 70% | 30 |

4. Test & Support Equipment List

4.1 Test Instruments

Table 13: Test Instruments List

| DESCRIPTION & MANUFACTURER | MODEL NO. | SERIAL NO. | CALIBRATED DATE | CALIBRATED UNTIL |
|------------------------------------|-----------|------------|-----------------|------------------|
| Spectrum Analyzer R&S | FSV40 | 101516 | Mar. 04, 2020 | Mar. 3, 2021 |
| Vector Signal Generator Agilent | N5182B | MY53051263 | Aug. 30, 2019 | Aug. 29, 2020 |
| Horn_Antenna EMCO | 1018G | 0001 | Nov. 24, 2019 | Nov. 23, 2020 |
| DFS Control Box | BV-DFS-CB | 001 | Nov. 29, 2019 | Nov. 28, 2020 |

4.2 Description of Support Units

Table 14: Support Unit Information

| No. | Product | Brand | Model No. | FCC ID | Spec |
|-----|----------------------|-------|--------------|------------|------|
| 1 | Intel® Wi-Fi 6 AX200 | Intel | AX200NG W | PD9AX200NG | |

NOTE: This device was functioned as a Master Slave device during the DFS test.

Table 15: Software/Firmware Information

| No. | Product | Model No. | Software/Firmware Version |
|-----|----------------------|-----------|---------------------------|
| 1 | Intel® Wi-Fi 6 AX200 | AX200NGW | 21.80.2.1 |

5. Test Procedure

5.1 DFS Measurement System

A complete DFS Measurement System consists of two subsystems: (1) the Radar Signal Generating system and (2) the Traffic Monitoring system. The control PC is necessary for generating the Radar waveforms in Table 10, 11 and 12. The traffic monitoring subsystem is specified to the type of unit under test (UUT).

Radiated Setup Configuration of DFS Measurement System

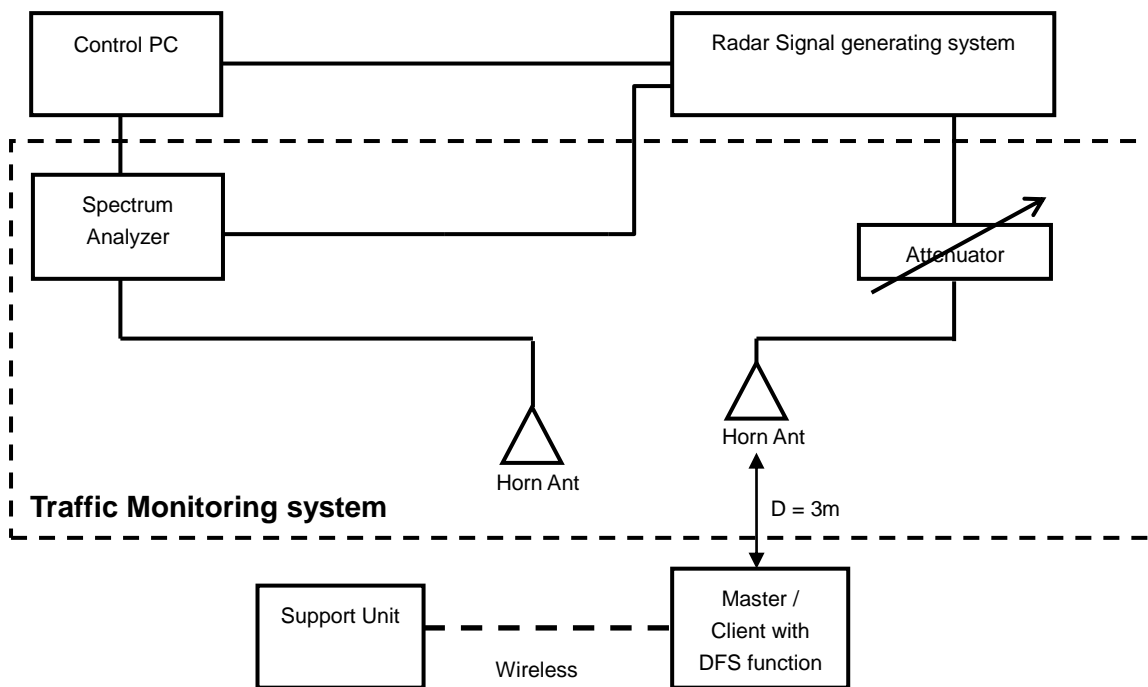

Channel Loading

System testing will be performed with channel-loading using means appropriate to the data types that are used by the unlicensed device. The following requirements apply:

| | | |
|----|---|---|
| a) | The data file must be of a type that is typical for the device (i.e., MPEG-2, MPEG-4, WAV, MP3, MP4, AVI, etc.) and must generally be transmitting in a streaming mode. | |
| b) | Software to ping the client is permitted to simulate data transfer but must have random ping intervals. | |
| c) | Timing plots are required with calculations demonstrating a minimum channel loading of approximately 17% or greater. | ✓ |
| d) | Unicast or Multicast protocols are preferable but other protocols may be used. The appropriate protocol used must be described in the test procedures. | |

5.2 Calibration of DFS Detection Threshold Level

The measured channel is chosen from the operating channels of the UUT within the 5250-5350MHz or 5470-5725MHz and using the all bandwidth mode available for the link. The radar signal was the same as transmitted channels, and injected into the antenna of AP (master) or Client Device with Radar Detection, measured the channel closing transmission time and channel move time.

Radiated setup configuration of Calibration of DFS Detection Threshold Level

The radar signal generate system is generating waveform pattern of radar types. The amplitude of the radar signal generator system is adjusted to yield a level of -64 dBm as measured on the spectrum analyzer.

The interference detection threshold level is lower than -64 dBm hence it provides margin to the limit.

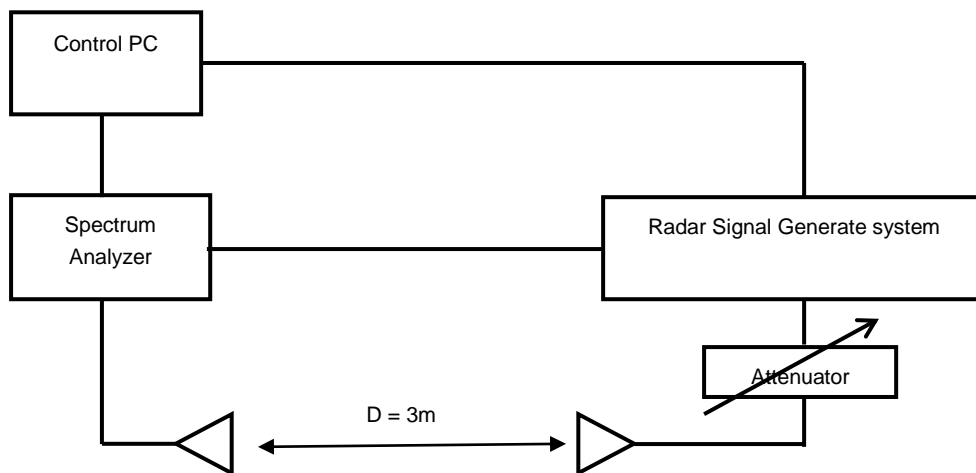

5.3 Deviation from Test Standard

No deviation.

5.4 Radiated Test Setup Configuration

Master mode

The EUT is a U-NII Device operating in Master mode. The radar test signals are injected into the Master Device.

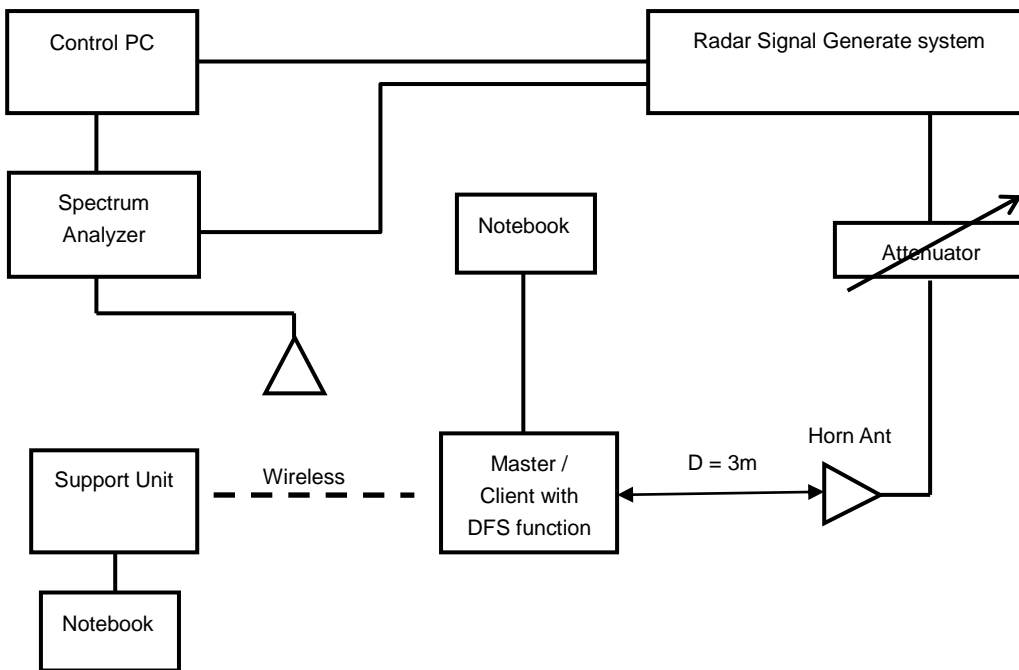

Note: The UUT main beam of the antenna is directly toward the radar emitter during testing.

6. Test Results

6.1 Summary of Test Results

| Clause | Test Parameter | Remarks | Pass/Fail |
|--------|---|------------|-----------|
| 15.407 | DFS Detection Threshold | Applicable | Pass |
| 15.407 | Channel Availability Check Time | Applicable | Pass |
| 15.407 | Channel Move Time | Applicable | Pass |
| 15.407 | Channel Closing Transmission Time | Applicable | Pass |
| 15.407 | Non- Occupancy Period | Applicable | Pass |
| 15.407 | U-NII Detection Bandwidth and Statistical Performance Check | Applicable | Pass |

Note: This device does not support "802.11ax Channel Puncturing" function.

6.2 Test Results

6.2.1 Test Mode: Device Operating In Master Mode

The radar test waveforms are injected into the Master.
This test was investigated for different bandwidth (20MHz · 40MHz · 80MHz and 160MHz).
The following plots was done on 160MHz as a representative

DFS Detection Threshold

For detection threshold level of -64dBm, the tested level is lower than required level for 1dB, hence it provides margin to the limit.

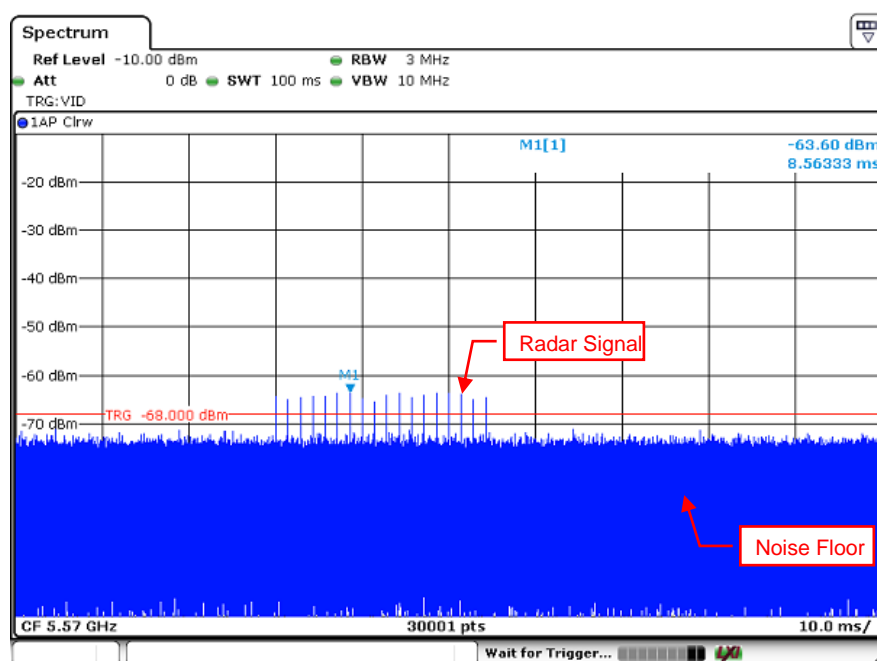

Radar Signal 0

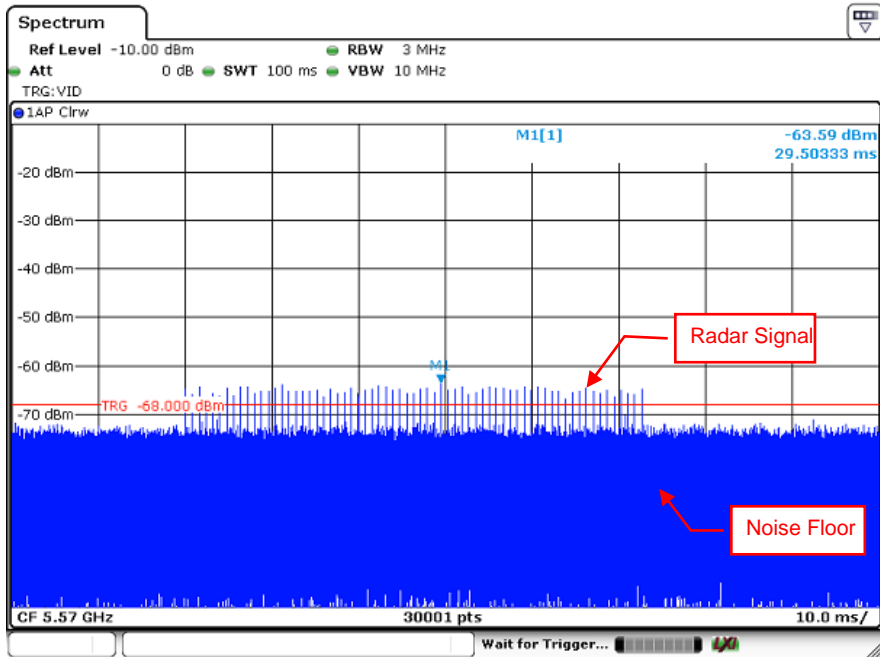

Radar Signal 1 (Test A)

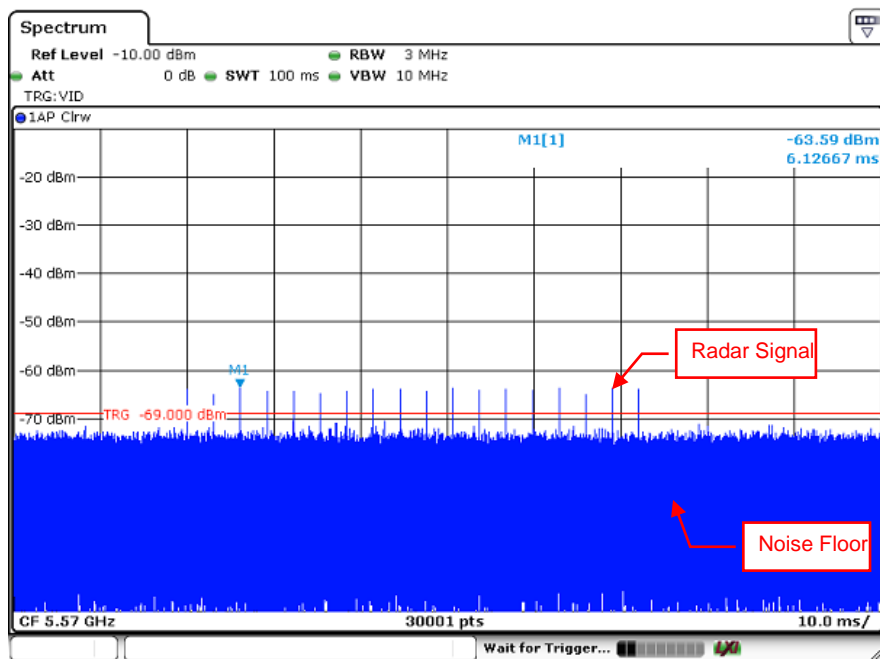

Radar Signal 1 (Test B)

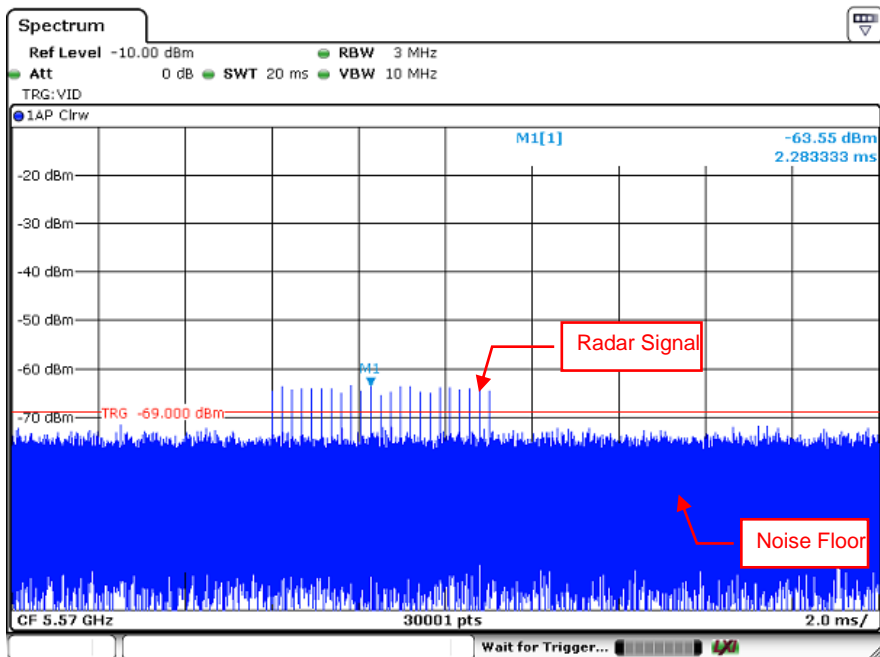

Radar Signal 2

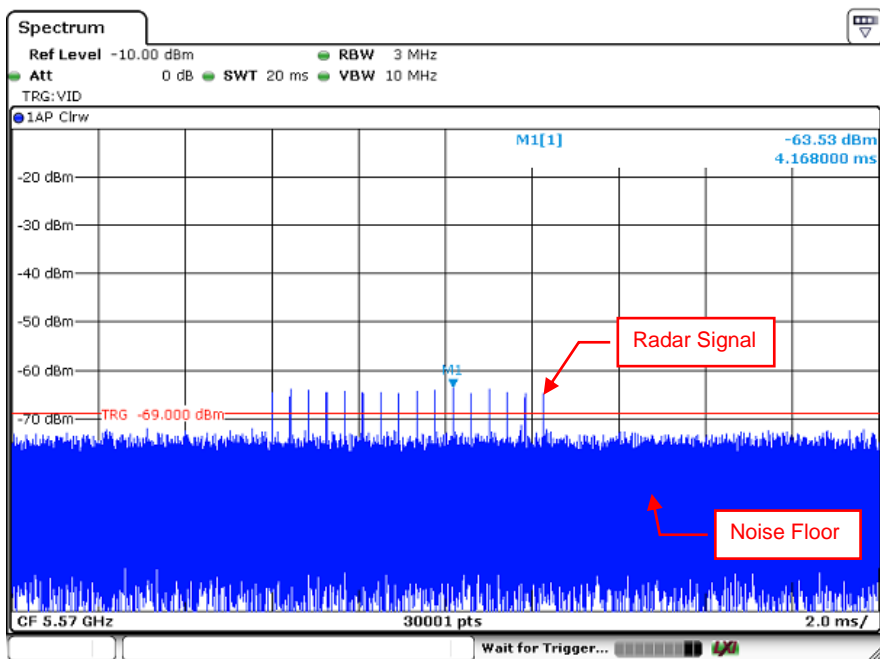

Radar Signal 3

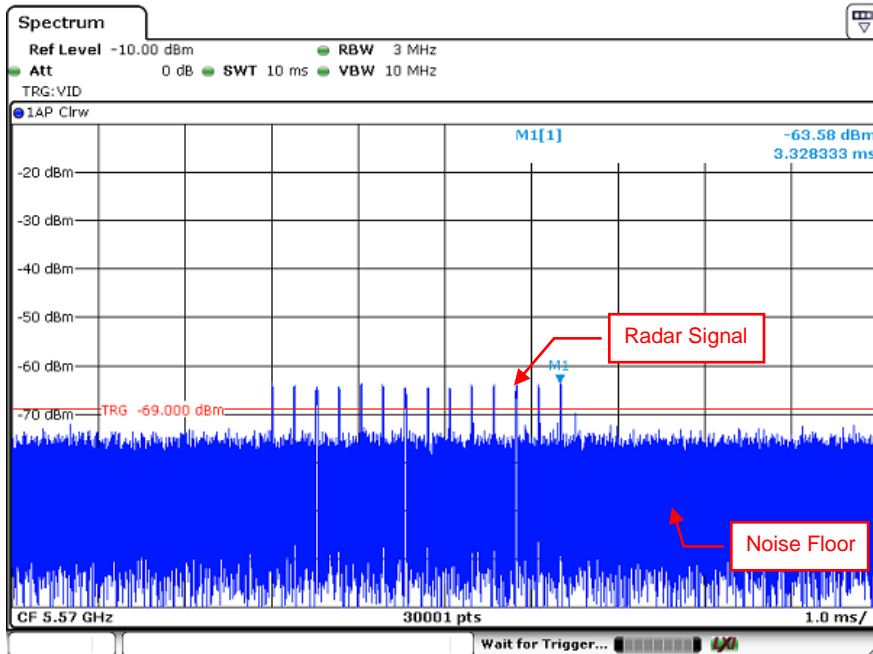

Single Burst of Radar Signal 4

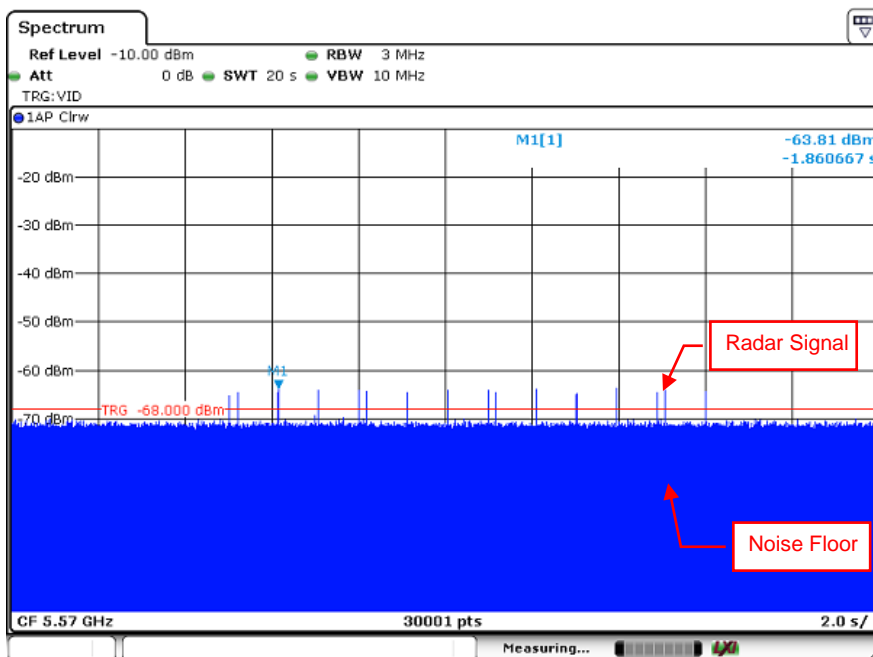

Radar Signal 5

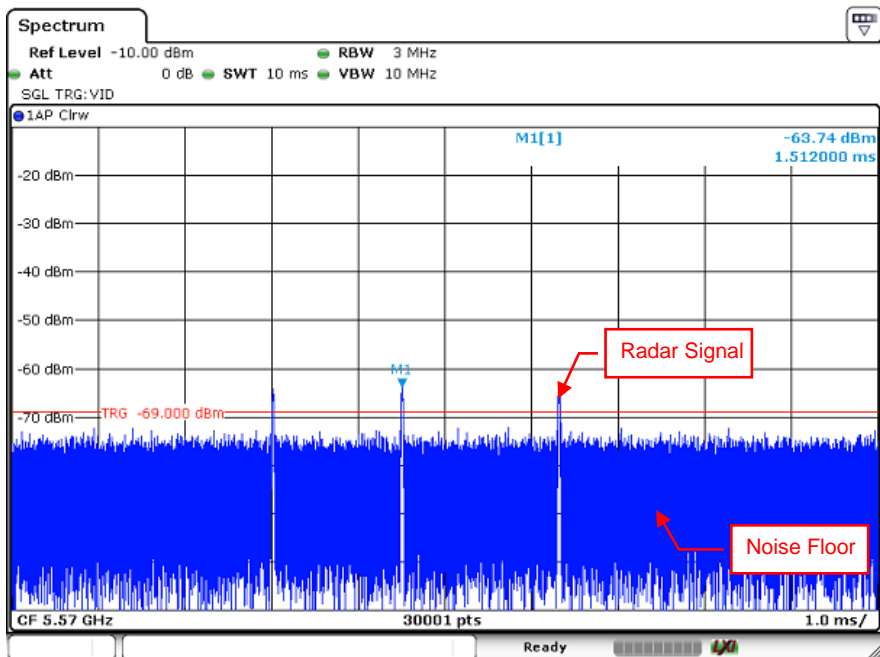

Single Burst of Radar Signal 5

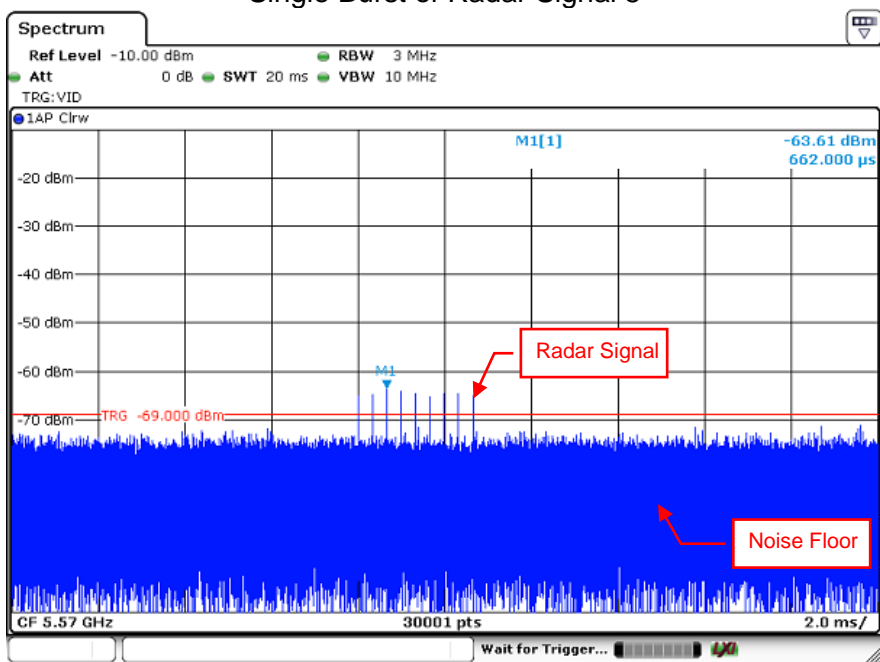

Radar Signal 6

6.2.2 U-NII Detection Bandwidth

802.11ax (HE20)

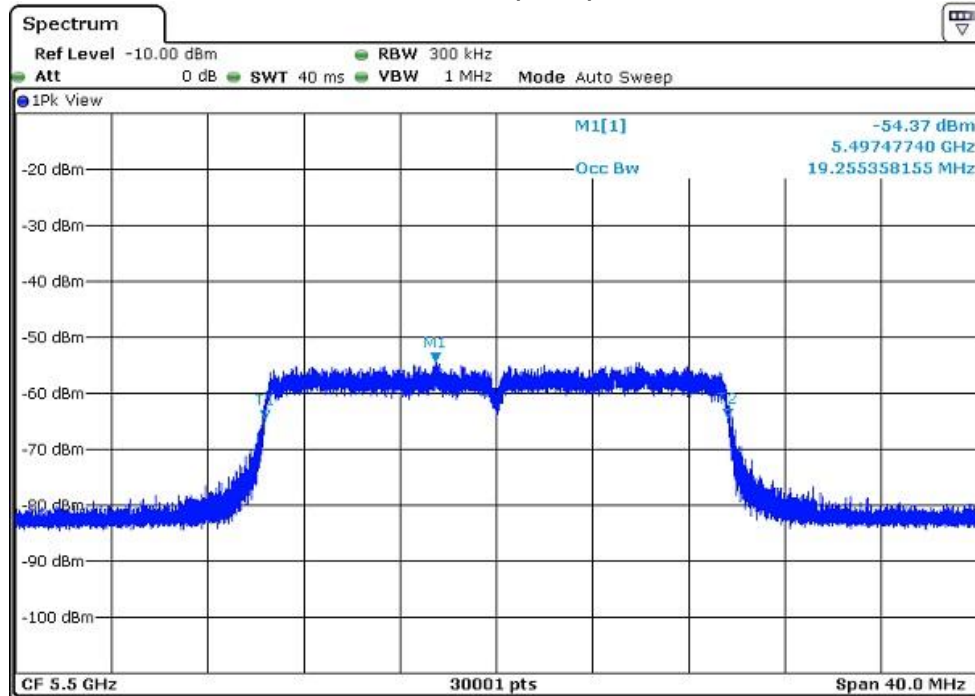

U-NII 99% Channel bandwidth

802.11ax (HE40)

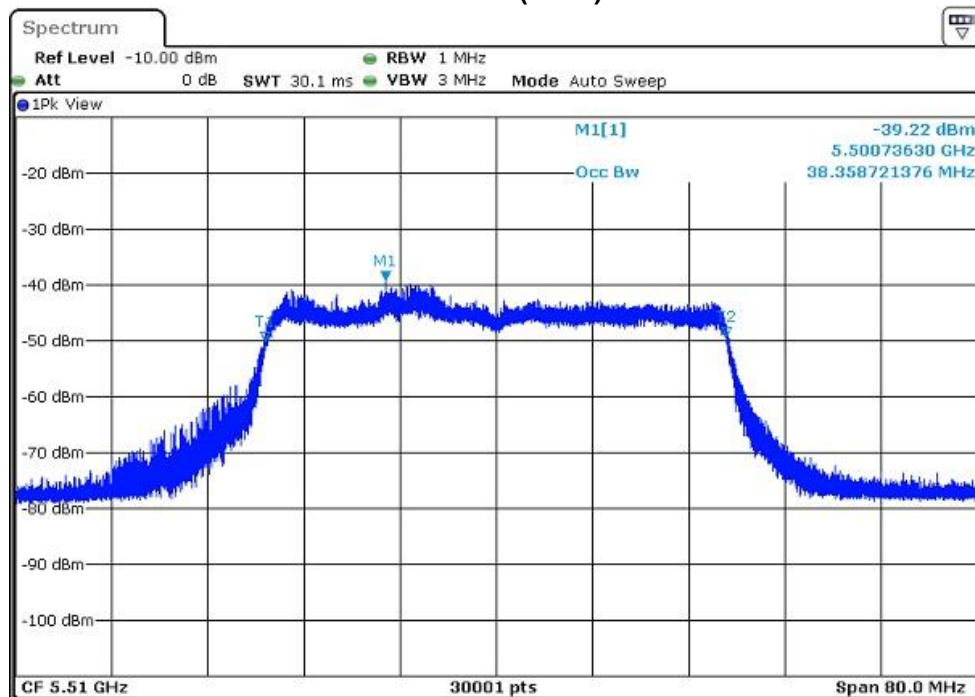

U-NII 99% Channel bandwidth



802.11ax (HE80)

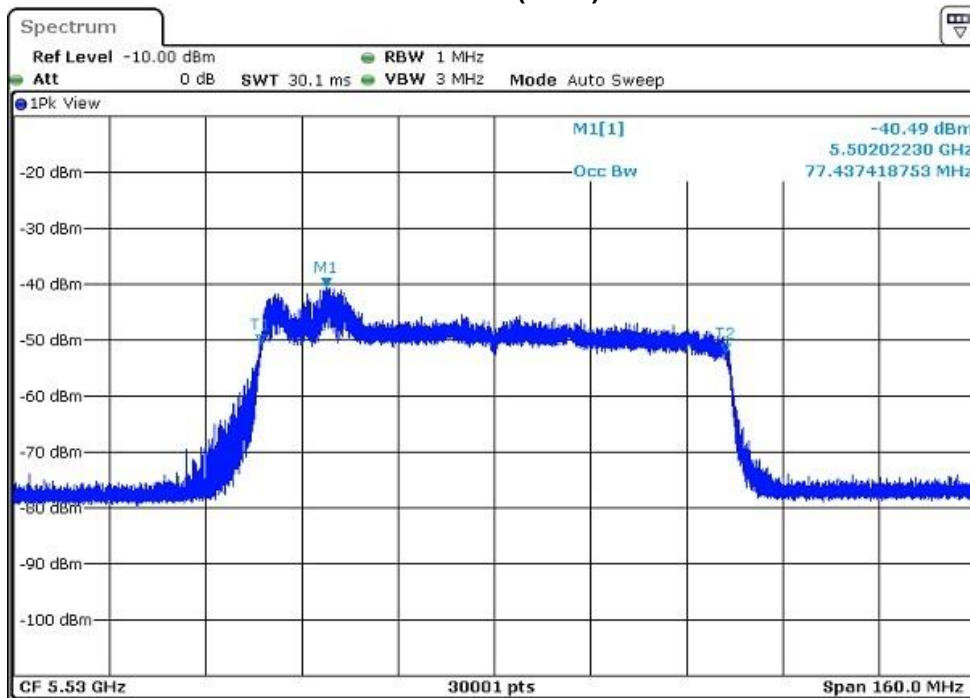

U-NII 99% Channel bandwidth

802.11ax (HE160)

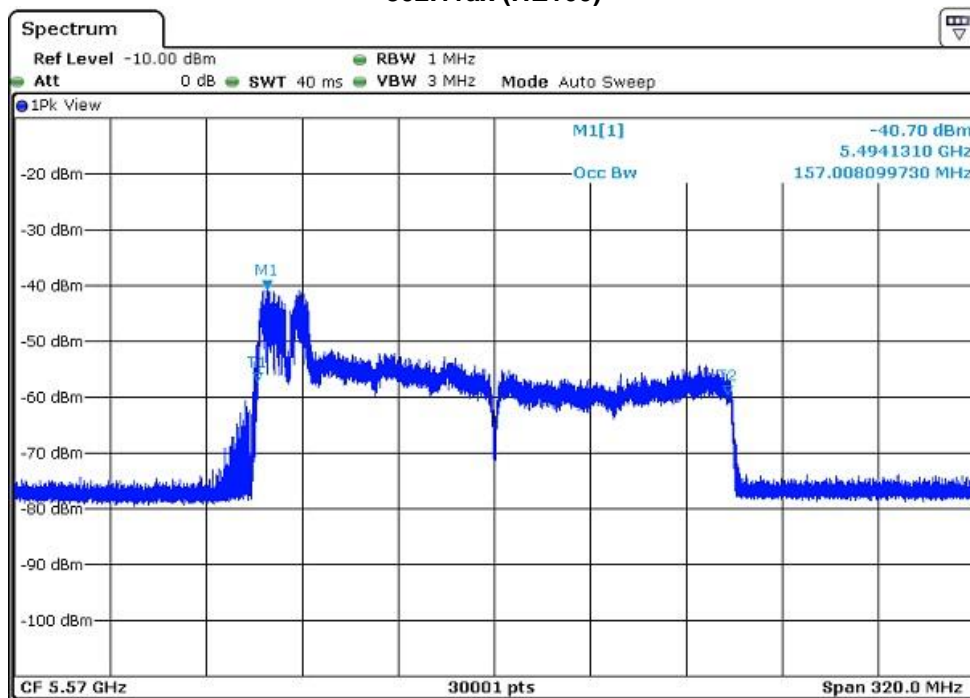

U-NII 99% Channel bandwidth

| Detection Bandwidth Test - 802.11ax (HE20) | | | | | | | | | | | |
|--|--------------------------|-----|-----|-----|-----|-----|-----|-----|-----|-----|--------------------|
| Radar Type 0 | | | | | | | | | | | |
| EUT Frequency: 5500MHz | | | | | | | | | | | |
| EUT 99% Power bandwidth: 19.255MHz | | | | | | | | | | | |
| Detection bandwidth limit (100% of EUT 99% Power bandwidth): 19.255MHz | | | | | | | | | | | |
| Detection bandwidth (5510(FH) – 5490(FL)) : 20MHz | | | | | | | | | | | |
| Test Result : PASS | | | | | | | | | | | |
| Radar Frequency (MHz) | Trial Number / Detection | | | | | | | | | | Detection Rate (%) |
| | 1 | 2 | 3 | 4 | 5 | 6 | 7 | 8 | 9 | 10 | |
| 5490(FL) | Yes | Yes | Yes | Yes | Yes | Yes | Yes | Yes | Yes | No | 90 |
| 5491 | Yes | Yes | Yes | Yes | Yes | Yes | Yes | Yes | Yes | Yes | 100 |
| 5492 | Yes | Yes | Yes | Yes | Yes | Yes | Yes | Yes | Yes | Yes | 100 |
| 5493 | Yes | Yes | Yes | Yes | Yes | Yes | Yes | Yes | Yes | Yes | 100 |
| 5494 | Yes | Yes | Yes | Yes | Yes | Yes | Yes | Yes | Yes | Yes | 100 |
| 5495 | No | Yes | Yes | Yes | Yes | Yes | Yes | Yes | Yes | Yes | 90 |
| 5496 | Yes | Yes | Yes | Yes | Yes | Yes | Yes | Yes | Yes | Yes | 100 |
| 5497 | Yes | Yes | Yes | Yes | Yes | Yes | Yes | Yes | Yes | Yes | 100 |
| 5498 | Yes | Yes | Yes | Yes | Yes | Yes | Yes | Yes | Yes | Yes | 100 |
| 5499 | Yes | Yes | Yes | Yes | Yes | Yes | Yes | Yes | Yes | Yes | 100 |
| 5500 | Yes | Yes | Yes | Yes | Yes | Yes | Yes | Yes | Yes | No | 90 |
| 5501 | Yes | Yes | Yes | Yes | Yes | Yes | Yes | Yes | Yes | Yes | 100 |
| 5502 | Yes | Yes | Yes | Yes | Yes | Yes | Yes | Yes | Yes | Yes | 100 |
| 5503 | Yes | Yes | Yes | Yes | Yes | Yes | Yes | Yes | Yes | Yes | 100 |
| 5504 | Yes | Yes | Yes | Yes | Yes | Yes | Yes | Yes | Yes | Yes | 100 |
| 5505 | Yes | Yes | Yes | Yes | Yes | Yes | Yes | Yes | Yes | Yes | 100 |
| 5506 | Yes | Yes | Yes | Yes | Yes | Yes | Yes | Yes | Yes | Yes | 100 |
| 5507 | Yes | Yes | Yes | Yes | Yes | Yes | Yes | Yes | Yes | Yes | 100 |
| 5508 | Yes | Yes | Yes | Yes | Yes | Yes | Yes | Yes | Yes | Yes | 100 |
| 5509 | Yes | Yes | Yes | Yes | Yes | Yes | Yes | Yes | Yes | Yes | 100 |
| 5510(FH) | Yes | Yes | Yes | Yes | Yes | Yes | Yes | Yes | No | Yes | 90 |

| Detection Bandwidth Test - 802.11ax (HE40) | | | | | | | | | | | |
|--|--------------------------|-----|-----|-----|-----|-----|-----|-----|-----|-----|--------------------|
| Radar Type 0 | | | | | | | | | | | |
| EUT Frequency: 5510MHz | | | | | | | | | | | |
| EUT 99% Power bandwidth: 38.358MHz | | | | | | | | | | | |
| Detection bandwidth limit (100% of EUT 99% Power bandwidth): 38.358MHz | | | | | | | | | | | |
| Detection bandwidth (5530(FH) – 5490(FL)) : 40MHz | | | | | | | | | | | |
| Test Result : PASS | | | | | | | | | | | |
| Radar Frequency (MHz) | Trial Number / Detection | | | | | | | | | | Detection Rate (%) |
| | 1 | 2 | 3 | 4 | 5 | 6 | 7 | 8 | 9 | 10 | |
| 5491(FL) | Yes | Yes | Yes | No | Yes | Yes | Yes | Yes | Yes | Yes | 90 |
| 5492 | Yes | Yes | Yes | Yes | Yes | Yes | Yes | Yes | Yes | Yes | 100 |
| 5493 | Yes | Yes | Yes | Yes | Yes | Yes | Yes | Yes | Yes | Yes | 100 |
| 5494 | Yes | Yes | Yes | Yes | Yes | Yes | Yes | Yes | Yes | Yes | 100 |
| 5495 | Yes | Yes | Yes | Yes | Yes | Yes | Yes | Yes | Yes | Yes | 100 |
| 5496 | Yes | Yes | Yes | Yes | Yes | Yes | Yes | Yes | Yes | Yes | 100 |
| 5497 | Yes | Yes | Yes | Yes | Yes | Yes | Yes | Yes | Yes | Yes | 100 |
| 5498 | Yes | Yes | Yes | Yes | Yes | Yes | Yes | Yes | Yes | Yes | 100 |
| 5499 | Yes | Yes | Yes | Yes | Yes | Yes | Yes | Yes | Yes | Yes | 100 |
| 5500 | Yes | Yes | Yes | Yes | Yes | Yes | No | Yes | Yes | Yes | 90 |
| 5501 | Yes | Yes | Yes | Yes | Yes | Yes | Yes | Yes | Yes | Yes | 100 |
| 5502 | Yes | Yes | Yes | Yes | Yes | Yes | Yes | Yes | Yes | Yes | 100 |
| 5503 | Yes | Yes | Yes | Yes | Yes | Yes | Yes | Yes | Yes | Yes | 100 |
| 5504 | Yes | Yes | Yes | Yes | Yes | Yes | Yes | Yes | Yes | Yes | 100 |
| 5505 | Yes | Yes | Yes | Yes | Yes | Yes | Yes | Yes | Yes | Yes | 100 |
| 5506 | Yes | Yes | Yes | Yes | Yes | Yes | Yes | Yes | Yes | Yes | 100 |
| 5507 | Yes | Yes | Yes | Yes | Yes | Yes | Yes | Yes | Yes | Yes | 100 |
| 5508 | Yes | Yes | Yes | Yes | Yes | Yes | Yes | Yes | Yes | Yes | 100 |
| 5509 | Yes | Yes | Yes | Yes | Yes | Yes | Yes | Yes | Yes | Yes | 100 |
| 5510 | Yes | Yes | Yes | Yes | Yes | Yes | Yes | No | Yes | Yes | 90 |
| 5511 | Yes | Yes | Yes | Yes | Yes | Yes | Yes | Yes | Yes | Yes | 100 |
| 5512 | Yes | Yes | Yes | Yes | Yes | Yes | Yes | Yes | Yes | Yes | 100 |
| 5513 | Yes | Yes | Yes | Yes | Yes | Yes | Yes | Yes | Yes | Yes | 100 |
| 5514 | Yes | Yes | Yes | Yes | Yes | Yes | Yes | Yes | Yes | Yes | 100 |
| 5515 | Yes | Yes | Yes | Yes | Yes | Yes | Yes | Yes | Yes | Yes | 100 |
| 5516 | Yes | Yes | Yes | Yes | Yes | Yes | Yes | Yes | Yes | Yes | 100 |
| 5517 | Yes | Yes | Yes | Yes | Yes | Yes | Yes | Yes | Yes | Yes | 100 |
| 5518 | Yes | Yes | Yes | Yes | Yes | Yes | Yes | Yes | Yes | Yes | 100 |
| 5519 | Yes | Yes | Yes | Yes | Yes | Yes | Yes | Yes | Yes | Yes | 100 |
| 5520 | Yes | Yes | Yes | Yes | Yes | Yes | Yes | Yes | Yes | Yes | 100 |
| 5521 | Yes | Yes | Yes | Yes | Yes | Yes | Yes | Yes | Yes | Yes | 100 |
| 5522 | Yes | Yes | Yes | Yes | Yes | Yes | Yes | Yes | Yes | Yes | 100 |
| 5523 | Yes | Yes | Yes | Yes | Yes | Yes | Yes | Yes | Yes | Yes | 100 |
| 5524 | Yes | Yes | Yes | Yes | Yes | Yes | Yes | Yes | Yes | Yes | 100 |
| 5525 | Yes | Yes | Yes | Yes | Yes | Yes | Yes | Yes | Yes | Yes | 100 |
| 5526 | Yes | Yes | Yes | Yes | Yes | Yes | Yes | Yes | Yes | Yes | 100 |
| 5527 | Yes | Yes | Yes | Yes | Yes | Yes | Yes | Yes | Yes | Yes | 100 |
| 5528 | Yes | Yes | No | Yes | Yes | Yes | Yes | Yes | Yes | Yes | 90 |
| 5529(FH) | No | Yes | Yes | Yes | Yes | Yes | Yes | Yes | Yes | Yes | 90 |

| Detection Bandwidth Test - 802.11ax (HE80) | | | | | | | | | | | |
|--|--------------------------|-----|-----|-----|-----|-----|-----|-----|-----|-----|--------------------|
| Radar Type 0 | | | | | | | | | | | |
| EUT Frequency: 5530MHz | | | | | | | | | | | |
| EUT 99% Power bandwidth: 77.437MHz | | | | | | | | | | | |
| Detection bandwidth limit (100% of EUT 99% Power bandwidth): 77.437MHz | | | | | | | | | | | |
| Detection bandwidth (5569(FH) – 5491(FL)) : 78MHz | | | | | | | | | | | |
| Test Result : PASS | | | | | | | | | | | |
| Radar Frequency (MHz) | Trial Number / Detection | | | | | | | | | | Detection Rate (%) |
| | 1 | 2 | 3 | 4 | 5 | 6 | 7 | 8 | 9 | 10 | |
| 5491(FL) | Yes | Yes | No | Yes | Yes | Yes | Yes | Yes | Yes | Yes | 90 |
| 5492 | Yes | Yes | Yes | Yes | Yes | Yes | Yes | Yes | Yes | Yes | 100 |
| 5493 | Yes | Yes | Yes | Yes | Yes | Yes | Yes | Yes | Yes | Yes | 100 |
| 5494 | Yes | Yes | Yes | Yes | Yes | Yes | Yes | Yes | Yes | Yes | 100 |
| 5495 | Yes | Yes | Yes | Yes | Yes | No | Yes | Yes | Yes | Yes | 90 |
| 5496 | Yes | Yes | Yes | Yes | Yes | Yes | Yes | Yes | Yes | Yes | 100 |
| 5497 | Yes | Yes | Yes | Yes | Yes | Yes | Yes | Yes | Yes | Yes | 100 |
| 5498 | Yes | Yes | Yes | Yes | Yes | Yes | Yes | Yes | Yes | Yes | 100 |
| 5499 | Yes | Yes | Yes | Yes | Yes | Yes | Yes | Yes | Yes | Yes | 100 |
| 5500 | Yes | Yes | Yes | Yes | Yes | Yes | Yes | Yes | Yes | Yes | 100 |
| 5501 | Yes | Yes | Yes | Yes | Yes | Yes | Yes | Yes | Yes | Yes | 100 |
| 5502 | Yes | Yes | Yes | Yes | Yes | Yes | Yes | Yes | Yes | Yes | 100 |
| 5503 | Yes | Yes | Yes | Yes | Yes | Yes | Yes | Yes | Yes | Yes | 100 |
| 5504 | Yes | Yes | Yes | Yes | Yes | Yes | Yes | Yes | Yes | Yes | 100 |
| 5505 | Yes | Yes | Yes | Yes | Yes | Yes | Yes | Yes | Yes | Yes | 100 |
| 5506 | Yes | Yes | Yes | Yes | Yes | Yes | Yes | Yes | Yes | Yes | 100 |
| 5507 | Yes | Yes | Yes | Yes | Yes | Yes | Yes | Yes | Yes | Yes | 100 |
| 5508 | Yes | Yes | Yes | Yes | Yes | Yes | Yes | Yes | Yes | Yes | 100 |
| 5509 | Yes | Yes | Yes | Yes | Yes | Yes | Yes | Yes | Yes | Yes | 100 |
| 5510 | No | Yes | Yes | Yes | Yes | Yes | Yes | Yes | Yes | Yes | 90 |
| 5511 | Yes | Yes | Yes | Yes | Yes | Yes | Yes | Yes | Yes | Yes | 100 |
| 5512 | Yes | Yes | Yes | Yes | Yes | Yes | Yes | Yes | Yes | Yes | 100 |
| 5513 | Yes | Yes | Yes | Yes | Yes | Yes | Yes | Yes | Yes | Yes | 100 |
| 5514 | Yes | Yes | Yes | Yes | Yes | Yes | Yes | Yes | Yes | Yes | 100 |
| 5515 | Yes | Yes | Yes | Yes | Yes | Yes | Yes | Yes | Yes | Yes | 100 |
| 5516 | Yes | Yes | Yes | Yes | Yes | Yes | Yes | Yes | Yes | Yes | 100 |
| 5517 | Yes | Yes | Yes | Yes | Yes | Yes | Yes | Yes | Yes | Yes | 100 |
| 5518 | Yes | Yes | Yes | Yes | Yes | Yes | Yes | Yes | Yes | Yes | 100 |
| 5519 | Yes | Yes | Yes | Yes | Yes | Yes | Yes | Yes | Yes | Yes | 100 |
| 5520 | Yes | Yes | Yes | Yes | Yes | Yes | Yes | Yes | Yes | Yes | 100 |
| 5521 | Yes | Yes | Yes | Yes | Yes | Yes | Yes | Yes | Yes | Yes | 100 |
| 5522 | Yes | Yes | Yes | Yes | Yes | Yes | Yes | Yes | Yes | Yes | 100 |
| 5523 | Yes | Yes | Yes | Yes | Yes | Yes | Yes | Yes | Yes | Yes | 100 |
| 5524 | Yes | Yes | Yes | Yes | Yes | Yes | Yes | Yes | Yes | Yes | 100 |
| 5525 | Yes | Yes | Yes | Yes | Yes | Yes | Yes | Yes | Yes | Yes | 100 |
| 5526 | Yes | Yes | Yes | Yes | Yes | Yes | Yes | Yes | Yes | Yes | 100 |
| 5527 | Yes | Yes | Yes | Yes | Yes | Yes | Yes | Yes | Yes | Yes | 100 |
| 5528 | Yes | Yes | Yes | Yes | Yes | Yes | Yes | Yes | Yes | Yes | 100 |
| 5529 | Yes | Yes | Yes | Yes | Yes | Yes | Yes | Yes | Yes | Yes | 100 |
| 5530 | Yes | Yes | No | Yes | Yes | Yes | Yes | Yes | Yes | Yes | 90 |
| 5531 | Yes | Yes | Yes | Yes | Yes | Yes | Yes | Yes | Yes | Yes | 100 |
| 5532 | Yes | Yes | Yes | Yes | Yes | Yes | Yes | Yes | Yes | Yes | 100 |
| 5533 | Yes | Yes | Yes | Yes | Yes | Yes | Yes | Yes | Yes | Yes | 100 |
| 5534 | Yes | Yes | Yes | Yes | Yes | No | Yes | Yes | Yes | Yes | 90 |
| 5535 | Yes | Yes | Yes | Yes | Yes | Yes | Yes | Yes | Yes | Yes | 100 |



| | | | | | | | | | | | |
|----------|-----|-----|-----|-----|-----|-----|-----|-----|-----|-----|-----|
| 5536 | No | Yes | Yes | Yes | Yes | Yes | Yes | Yes | Yes | Yes | 90 |
| 5537 | Yes | Yes | Yes | Yes | Yes | Yes | Yes | Yes | Yes | Yes | 100 |
| 5538 | Yes | Yes | Yes | Yes | Yes | Yes | Yes | Yes | Yes | Yes | 100 |
| 5539 | Yes | Yes | Yes | Yes | Yes | Yes | Yes | Yes | Yes | Yes | 100 |
| 5540 | Yes | Yes | Yes | Yes | Yes | Yes | Yes | Yes | Yes | Yes | 100 |
| 5541 | Yes | Yes | Yes | Yes | Yes | Yes | Yes | Yes | Yes | Yes | 100 |
| 5542 | Yes | Yes | Yes | Yes | Yes | Yes | Yes | Yes | Yes | Yes | 100 |
| 5543 | Yes | Yes | Yes | Yes | Yes | Yes | Yes | Yes | Yes | Yes | 100 |
| 5544 | Yes | Yes | Yes | Yes | Yes | Yes | Yes | Yes | Yes | Yes | 100 |
| 5545 | Yes | Yes | Yes | Yes | Yes | Yes | Yes | Yes | Yes | Yes | 100 |
| 5546 | Yes | Yes | Yes | Yes | Yes | Yes | Yes | Yes | Yes | Yes | 100 |
| 5547 | Yes | Yes | Yes | Yes | Yes | Yes | Yes | Yes | Yes | Yes | 100 |
| 5548 | Yes | Yes | Yes | Yes | Yes | Yes | Yes | Yes | Yes | Yes | 100 |
| 5549 | Yes | Yes | Yes | Yes | Yes | Yes | Yes | Yes | Yes | Yes | 100 |
| 5550 | Yes | Yes | Yes | Yes | Yes | Yes | Yes | Yes | Yes | Yes | 100 |
| 5551 | Yes | Yes | Yes | Yes | Yes | Yes | Yes | Yes | Yes | Yes | 100 |
| 5552 | Yes | Yes | Yes | Yes | Yes | Yes | Yes | Yes | Yes | Yes | 100 |
| 5553 | Yes | Yes | Yes | Yes | Yes | Yes | Yes | Yes | Yes | Yes | 100 |
| 5554 | Yes | Yes | Yes | Yes | Yes | No | Yes | Yes | Yes | Yes | 90 |
| 5555 | Yes | Yes | Yes | Yes | Yes | Yes | Yes | Yes | Yes | Yes | 100 |
| 5556 | Yes | Yes | Yes | Yes | Yes | Yes | Yes | Yes | Yes | Yes | 100 |
| 5557 | Yes | Yes | Yes | Yes | Yes | Yes | Yes | Yes | Yes | Yes | 100 |
| 5558 | Yes | Yes | Yes | Yes | Yes | Yes | Yes | Yes | Yes | Yes | 100 |
| 5559 | Yes | Yes | Yes | Yes | Yes | Yes | Yes | Yes | Yes | Yes | 100 |
| 5560 | Yes | Yes | Yes | Yes | Yes | Yes | Yes | Yes | Yes | Yes | 100 |
| 5561 | Yes | Yes | Yes | Yes | Yes | Yes | Yes | Yes | Yes | Yes | 100 |
| 5562 | Yes | Yes | Yes | Yes | Yes | Yes | Yes | Yes | Yes | Yes | 100 |
| 5563 | Yes | Yes | Yes | Yes | Yes | Yes | Yes | Yes | Yes | Yes | 100 |
| 5564 | Yes | Yes | No | Yes | Yes | Yes | Yes | Yes | Yes | Yes | 90 |
| 5565 | Yes | Yes | Yes | Yes | Yes | Yes | Yes | Yes | Yes | Yes | 100 |
| 5566 | Yes | Yes | Yes | Yes | Yes | Yes | Yes | Yes | Yes | Yes | 100 |
| 5567 | Yes | Yes | Yes | Yes | Yes | Yes | Yes | Yes | Yes | Yes | 100 |
| 5568 | Yes | Yes | Yes | Yes | Yes | Yes | Yes | Yes | Yes | Yes | 100 |
| 5569(FH) | Yes | No | Yes | Yes | Yes | Yes | Yes | Yes | Yes | Yes | 90 |



Detection Bandwidth Test - **802.11ax (HE160)**

Radar Type 0

EUT Frequency: 5570MHz

EUT 99% Power bandwidth: 157.008MHz

Detection bandwidth limit (100% of EUT 99% Power bandwidth): 157.008MHz

Detection bandwidth (5649(FH) – 5491(FL)) : 158MHz

Test Result : PASS

| Radar Frequency (MHz) | Trial Number / Detection | | | | | | | | | | Detection Rate (%) |
|-----------------------|--------------------------|-----|-----|-----|-----|-----|-----|-----|-----|-----|--------------------|
| | 1 | 2 | 3 | 4 | 5 | 6 | 7 | 8 | 9 | 10 | |
| 5491(FL) | Yes | No | Yes | Yes | Yes | Yes | Yes | Yes | Yes | Yes | 90 |
| 5492 | No | Yes | Yes | Yes | Yes | Yes | Yes | Yes | Yes | Yes | 90 |
| 5493 | Yes | Yes | Yes | Yes | Yes | Yes | Yes | Yes | Yes | Yes | 100 |
| 5494 | Yes | Yes | Yes | Yes | Yes | Yes | Yes | No | Yes | Yes | 90 |
| 5495 | Yes | Yes | Yes | Yes | Yes | Yes | Yes | Yes | Yes | Yes | 100 |
| 5496 | Yes | Yes | Yes | Yes | Yes | Yes | Yes | Yes | Yes | Yes | 100 |
| 5497 | Yes | Yes | Yes | Yes | Yes | Yes | Yes | Yes | Yes | Yes | 100 |
| 5498 | Yes | Yes | No | Yes | Yes | Yes | Yes | Yes | Yes | Yes | 90 |
| 5499 | Yes | Yes | Yes | Yes | Yes | Yes | Yes | Yes | Yes | Yes | 100 |
| 5500 | Yes | Yes | Yes | Yes | Yes | Yes | Yes | Yes | Yes | Yes | 100 |
| 5501 | Yes | Yes | Yes | Yes | Yes | Yes | Yes | Yes | Yes | Yes | 100 |
| 5502 | Yes | Yes | Yes | Yes | Yes | Yes | Yes | Yes | Yes | Yes | 100 |
| 5503 | Yes | Yes | Yes | Yes | Yes | Yes | Yes | Yes | Yes | Yes | 100 |
| 5504 | Yes | Yes | Yes | Yes | No | Yes | Yes | Yes | Yes | Yes | 90 |
| 5505 | Yes | Yes | Yes | Yes | Yes | Yes | Yes | Yes | Yes | Yes | 100 |
| 5506 | Yes | Yes | Yes | Yes | Yes | Yes | Yes | Yes | Yes | Yes | 100 |
| 5507 | Yes | Yes | Yes | Yes | Yes | No | Yes | Yes | Yes | Yes | 90 |
| 5508 | Yes | Yes | Yes | Yes | Yes | Yes | Yes | Yes | Yes | Yes | 100 |
| 5509 | Yes | Yes | Yes | Yes | Yes | Yes | Yes | Yes | Yes | Yes | 100 |
| 5510 | Yes | Yes | Yes | Yes | Yes | Yes | Yes | Yes | Yes | Yes | 100 |
| 5511 | Yes | Yes | Yes | Yes | Yes | Yes | Yes | Yes | Yes | Yes | 100 |
| 5512 | Yes | Yes | Yes | Yes | Yes | Yes | Yes | Yes | Yes | Yes | 100 |
| 5513 | Yes | Yes | Yes | Yes | Yes | Yes | Yes | Yes | Yes | Yes | 100 |
| 5514 | Yes | Yes | Yes | Yes | Yes | Yes | Yes | Yes | Yes | Yes | 100 |
| 5515 | Yes | Yes | Yes | Yes | Yes | Yes | Yes | Yes | Yes | Yes | 100 |
| 5516 | Yes | Yes | Yes | Yes | Yes | Yes | Yes | Yes | Yes | Yes | 100 |
| 5517 | Yes | Yes | Yes | Yes | Yes | Yes | Yes | Yes | Yes | Yes | 100 |
| 5518 | Yes | Yes | Yes | Yes | Yes | Yes | Yes | Yes | Yes | Yes | 100 |
| 5519 | Yes | Yes | Yes | Yes | Yes | Yes | Yes | Yes | Yes | Yes | 100 |
| 5520 | Yes | Yes | Yes | Yes | Yes | Yes | Yes | Yes | Yes | Yes | 100 |
| 5521 | Yes | Yes | Yes | Yes | Yes | Yes | Yes | Yes | Yes | Yes | 100 |
| 5522 | Yes | Yes | Yes | Yes | Yes | Yes | Yes | Yes | Yes | Yes | 100 |
| 5523 | Yes | Yes | Yes | Yes | Yes | Yes | Yes | Yes | Yes | Yes | 100 |
| 5524 | Yes | Yes | Yes | Yes | Yes | Yes | Yes | Yes | Yes | Yes | 100 |
| 5525 | Yes | Yes | Yes | Yes | Yes | Yes | Yes | Yes | Yes | Yes | 100 |
| 5526 | Yes | Yes | Yes | Yes | Yes | Yes | Yes | Yes | Yes | Yes | 100 |
| 5527 | Yes | Yes | Yes | Yes | Yes | Yes | Yes | Yes | Yes | Yes | 100 |
| 5528 | Yes | Yes | Yes | Yes | Yes | Yes | Yes | Yes | Yes | Yes | 100 |
| 5529 | Yes | No | Yes | Yes | Yes | Yes | Yes | Yes | Yes | Yes | 90 |
| 5530 | Yes | Yes | Yes | Yes | Yes | Yes | Yes | Yes | Yes | Yes | 100 |
| 5531 | Yes | Yes | Yes | Yes | Yes | Yes | Yes | Yes | Yes | Yes | 100 |
| 5532 | Yes | Yes | Yes | Yes | Yes | Yes | Yes | Yes | Yes | Yes | 100 |
| 5533 | Yes | Yes | Yes | Yes | Yes | Yes | Yes | Yes | Yes | Yes | 100 |
| 5534 | Yes | Yes | Yes | Yes | Yes | Yes | Yes | Yes | No | Yes | 90 |
| 5535 | Yes | Yes | Yes | Yes | Yes | Yes | Yes | Yes | Yes | Yes | 100 |



| | | | | | | | | | | | |
|------|-----|-----|-----|-----|-----|-----|-----|-----|-----|-----|-----|
| 5536 | Yes | Yes | Yes | Yes | Yes | Yes | Yes | Yes | Yes | Yes | 100 |
| 5537 | Yes | Yes | Yes | Yes | Yes | Yes | Yes | Yes | Yes | Yes | 100 |
| 5538 | Yes | Yes | Yes | Yes | Yes | Yes | Yes | Yes | Yes | Yes | 100 |
| 5539 | Yes | Yes | Yes | Yes | Yes | Yes | Yes | Yes | Yes | Yes | 100 |
| 5540 | Yes | Yes | Yes | Yes | Yes | Yes | Yes | Yes | Yes | Yes | 100 |
| 5541 | Yes | Yes | Yes | Yes | Yes | Yes | Yes | Yes | Yes | Yes | 100 |
| 5542 | Yes | Yes | Yes | Yes | Yes | Yes | Yes | Yes | Yes | Yes | 100 |
| 5543 | Yes | Yes | Yes | Yes | Yes | Yes | Yes | Yes | Yes | Yes | 100 |
| 5544 | Yes | Yes | Yes | Yes | Yes | Yes | Yes | Yes | Yes | Yes | 100 |
| 5545 | Yes | Yes | Yes | Yes | Yes | Yes | Yes | Yes | Yes | Yes | 100 |
| 5546 | Yes | Yes | Yes | Yes | Yes | Yes | Yes | Yes | Yes | Yes | 100 |
| 5547 | Yes | Yes | Yes | Yes | Yes | Yes | Yes | Yes | Yes | Yes | 100 |
| 5548 | Yes | Yes | Yes | Yes | Yes | Yes | Yes | Yes | Yes | Yes | 100 |
| 5549 | Yes | Yes | Yes | Yes | Yes | Yes | Yes | Yes | Yes | Yes | 100 |
| 5550 | Yes | Yes | Yes | Yes | Yes | Yes | Yes | Yes | Yes | Yes | 100 |
| 5551 | Yes | Yes | Yes | Yes | Yes | Yes | Yes | Yes | Yes | Yes | 100 |
| 5552 | Yes | Yes | Yes | Yes | Yes | Yes | Yes | Yes | Yes | Yes | 100 |
| 5553 | No | Yes | Yes | Yes | Yes | Yes | Yes | Yes | Yes | Yes | 90 |
| 5554 | Yes | Yes | Yes | Yes | Yes | Yes | Yes | Yes | Yes | Yes | 100 |
| 5555 | Yes | Yes | Yes | Yes | Yes | Yes | Yes | Yes | Yes | Yes | 100 |
| 5556 | Yes | Yes | Yes | Yes | Yes | Yes | Yes | Yes | Yes | Yes | 100 |
| 5557 | Yes | Yes | Yes | Yes | Yes | Yes | Yes | Yes | Yes | Yes | 100 |
| 5558 | Yes | Yes | Yes | Yes | Yes | Yes | Yes | Yes | Yes | Yes | 100 |
| 5559 | Yes | Yes | Yes | Yes | Yes | Yes | Yes | Yes | Yes | Yes | 100 |
| 5560 | Yes | Yes | Yes | Yes | Yes | Yes | Yes | Yes | Yes | Yes | 100 |
| 5561 | Yes | Yes | Yes | Yes | Yes | Yes | Yes | Yes | Yes | Yes | 100 |
| 5562 | Yes | Yes | Yes | Yes | Yes | Yes | Yes | Yes | Yes | Yes | 100 |
| 5563 | Yes | Yes | Yes | Yes | Yes | Yes | Yes | Yes | Yes | Yes | 100 |
| 5564 | Yes | Yes | Yes | Yes | Yes | No | Yes | Yes | Yes | Yes | 90 |
| 5565 | Yes | Yes | Yes | Yes | Yes | Yes | Yes | Yes | Yes | Yes | 100 |
| 5566 | Yes | Yes | Yes | Yes | Yes | Yes | Yes | Yes | Yes | Yes | 100 |
| 5567 | Yes | Yes | Yes | Yes | Yes | Yes | Yes | Yes | Yes | Yes | 100 |
| 5568 | Yes | Yes | Yes | Yes | Yes | Yes | Yes | Yes | Yes | Yes | 100 |
| 5569 | Yes | Yes | Yes | Yes | Yes | Yes | Yes | Yes | Yes | Yes | 100 |
| 5570 | Yes | Yes | Yes | Yes | Yes | Yes | Yes | Yes | Yes | Yes | 100 |
| 5571 | Yes | Yes | Yes | Yes | Yes | Yes | Yes | Yes | Yes | Yes | 100 |
| 5572 | Yes | Yes | Yes | Yes | Yes | Yes | Yes | Yes | Yes | Yes | 100 |
| 5573 | Yes | Yes | Yes | Yes | Yes | Yes | Yes | Yes | Yes | Yes | 100 |
| 5574 | Yes | Yes | Yes | Yes | Yes | Yes | Yes | Yes | Yes | Yes | 100 |
| 5575 | Yes | Yes | Yes | Yes | Yes | Yes | Yes | Yes | Yes | Yes | 100 |
| 5576 | Yes | Yes | Yes | Yes | Yes | Yes | Yes | Yes | Yes | Yes | 100 |
| 5577 | Yes | Yes | Yes | Yes | Yes | Yes | Yes | Yes | Yes | Yes | 100 |
| 5578 | Yes | Yes | Yes | Yes | Yes | Yes | Yes | Yes | Yes | Yes | 100 |
| 5579 | Yes | Yes | Yes | Yes | Yes | Yes | Yes | Yes | Yes | Yes | 100 |
| 5580 | Yes | Yes | Yes | Yes | Yes | Yes | Yes | Yes | Yes | Yes | 100 |
| 5581 | Yes | Yes | Yes | Yes | Yes | Yes | Yes | Yes | Yes | Yes | 100 |
| 5582 | Yes | Yes | Yes | Yes | Yes | Yes | Yes | Yes | Yes | Yes | 100 |
| 5583 | Yes | Yes | Yes | Yes | Yes | Yes | Yes | Yes | Yes | Yes | 100 |
| 5584 | Yes | Yes | No | Yes | Yes | Yes | Yes | Yes | Yes | Yes | 90 |
| 5585 | Yes | Yes | Yes | Yes | Yes | Yes | Yes | Yes | Yes | Yes | 100 |
| 5586 | Yes | Yes | Yes | Yes | Yes | Yes | Yes | Yes | Yes | Yes | 100 |
| 5587 | Yes | Yes | Yes | Yes | Yes | Yes | Yes | Yes | Yes | Yes | 100 |
| 5588 | Yes | Yes | Yes | Yes | Yes | Yes | Yes | Yes | Yes | Yes | 100 |
| 5589 | Yes | Yes | Yes | Yes | Yes | Yes | Yes | Yes | Yes | Yes | 100 |
| 5590 | Yes | Yes | Yes | Yes | Yes | Yes | Yes | Yes | Yes | Yes | 100 |



| | | | | | | | | | | | |
|------|-----|-----|-----|-----|-----|-----|-----|-----|-----|-----|-----|
| 5591 | Yes | Yes | Yes | Yes | Yes | Yes | Yes | Yes | Yes | Yes | 100 |
| 5592 | Yes | Yes | Yes | Yes | Yes | Yes | Yes | Yes | Yes | Yes | 100 |
| 5593 | Yes | Yes | Yes | Yes | Yes | Yes | Yes | Yes | Yes | Yes | 100 |
| 5594 | Yes | Yes | Yes | Yes | Yes | Yes | Yes | Yes | Yes | Yes | 100 |
| 5595 | Yes | Yes | Yes | Yes | Yes | Yes | Yes | Yes | Yes | Yes | 100 |
| 5596 | Yes | Yes | Yes | Yes | Yes | Yes | Yes | Yes | Yes | Yes | 100 |
| 5597 | Yes | Yes | Yes | Yes | Yes | Yes | Yes | Yes | Yes | Yes | 100 |
| 5598 | Yes | Yes | Yes | Yes | Yes | Yes | Yes | Yes | Yes | Yes | 100 |
| 5599 | Yes | Yes | Yes | Yes | Yes | Yes | Yes | Yes | Yes | Yes | 100 |
| 5600 | Yes | Yes | Yes | Yes | Yes | Yes | Yes | Yes | Yes | Yes | 100 |
| 5601 | Yes | Yes | Yes | Yes | Yes | No | Yes | Yes | Yes | Yes | 90 |
| 5602 | Yes | Yes | Yes | Yes | Yes | Yes | Yes | Yes | Yes | Yes | 100 |
| 5603 | Yes | Yes | Yes | Yes | Yes | Yes | Yes | Yes | Yes | Yes | 100 |
| 5604 | Yes | Yes | Yes | Yes | Yes | Yes | Yes | Yes | Yes | Yes | 100 |
| 5605 | Yes | Yes | Yes | Yes | Yes | Yes | Yes | Yes | Yes | Yes | 100 |
| 5606 | Yes | Yes | Yes | Yes | Yes | Yes | Yes | Yes | Yes | Yes | 100 |
| 5607 | Yes | Yes | Yes | Yes | Yes | Yes | Yes | Yes | Yes | Yes | 100 |
| 5608 | Yes | Yes | Yes | Yes | Yes | Yes | Yes | Yes | Yes | Yes | 100 |
| 5609 | Yes | Yes | Yes | Yes | Yes | Yes | Yes | Yes | Yes | Yes | 100 |
| 5610 | Yes | Yes | Yes | Yes | Yes | Yes | Yes | Yes | Yes | Yes | 100 |
| 5611 | Yes | Yes | Yes | Yes | Yes | Yes | Yes | Yes | Yes | Yes | 100 |
| 5612 | Yes | Yes | Yes | Yes | Yes | Yes | Yes | Yes | Yes | Yes | 100 |
| 5613 | Yes | Yes | Yes | Yes | Yes | Yes | Yes | Yes | Yes | Yes | 100 |
| 5614 | Yes | Yes | Yes | Yes | Yes | Yes | Yes | Yes | Yes | Yes | 100 |
| 5615 | Yes | Yes | Yes | Yes | Yes | Yes | Yes | Yes | Yes | Yes | 100 |
| 5616 | Yes | Yes | Yes | Yes | Yes | Yes | Yes | Yes | Yes | Yes | 100 |
| 5617 | Yes | Yes | Yes | Yes | Yes | Yes | Yes | Yes | Yes | Yes | 100 |
| 5618 | Yes | Yes | Yes | Yes | Yes | Yes | Yes | Yes | Yes | Yes | 100 |
| 5619 | Yes | Yes | Yes | Yes | Yes | Yes | Yes | No | Yes | Yes | 90 |
| 5620 | Yes | Yes | Yes | Yes | Yes | Yes | Yes | Yes | Yes | Yes | 100 |
| 5621 | Yes | Yes | Yes | Yes | Yes | Yes | Yes | Yes | Yes | Yes | 100 |
| 5622 | Yes | Yes | Yes | Yes | Yes | Yes | Yes | Yes | Yes | Yes | 100 |
| 5623 | Yes | Yes | Yes | Yes | Yes | Yes | Yes | Yes | Yes | Yes | 100 |
| 5624 | Yes | Yes | Yes | Yes | Yes | Yes | Yes | Yes | Yes | Yes | 100 |
| 5625 | Yes | Yes | Yes | Yes | Yes | Yes | Yes | Yes | Yes | Yes | 100 |
| 5626 | Yes | Yes | Yes | Yes | Yes | Yes | Yes | Yes | Yes | Yes | 100 |
| 5627 | Yes | Yes | Yes | Yes | Yes | Yes | Yes | Yes | Yes | Yes | 100 |
| 5628 | Yes | Yes | Yes | Yes | Yes | Yes | Yes | Yes | Yes | Yes | 100 |
| 5629 | Yes | Yes | Yes | Yes | Yes | Yes | Yes | Yes | Yes | Yes | 100 |
| 5630 | Yes | Yes | Yes | Yes | Yes | Yes | Yes | Yes | Yes | Yes | 100 |
| 5631 | Yes | Yes | Yes | Yes | Yes | Yes | Yes | Yes | Yes | Yes | 100 |
| 5632 | Yes | Yes | No | Yes | Yes | Yes | Yes | Yes | Yes | Yes | 90 |
| 5633 | Yes | Yes | Yes | Yes | Yes | Yes | Yes | Yes | Yes | Yes | 100 |
| 5634 | Yes | Yes | Yes | Yes | Yes | Yes | Yes | Yes | Yes | Yes | 100 |
| 5635 | Yes | Yes | Yes | Yes | Yes | Yes | Yes | Yes | Yes | Yes | 100 |
| 5636 | No | Yes | Yes | Yes | Yes | Yes | Yes | Yes | Yes | Yes | 90 |
| 5637 | Yes | Yes | Yes | Yes | Yes | Yes | Yes | Yes | Yes | Yes | 100 |
| 5638 | Yes | Yes | Yes | Yes | Yes | Yes | Yes | Yes | Yes | Yes | 100 |
| 5639 | Yes | Yes | Yes | Yes | Yes | Yes | Yes | Yes | Yes | Yes | 100 |
| 5640 | Yes | Yes | Yes | Yes | Yes | Yes | Yes | Yes | Yes | Yes | 100 |
| 5641 | Yes | Yes | Yes | Yes | Yes | Yes | Yes | Yes | Yes | Yes | 100 |
| 5642 | Yes | Yes | Yes | Yes | Yes | Yes | Yes | Yes | Yes | Yes | 100 |
| 5643 | Yes | Yes | Yes | Yes | Yes | Yes | Yes | Yes | Yes | No | 90 |
| 5644 | Yes | Yes | Yes | Yes | Yes | Yes | Yes | Yes | Yes | Yes | 100 |
| 5645 | Yes | Yes | Yes | Yes | Yes | Yes | Yes | Yes | Yes | Yes | 100 |



| | | | | | | | | | | | |
|----------|-----|-----|-----|-----|-----|-----|-----|-----|-----|-----|-----|
| 5646 | Yes | Yes | Yes | Yes | Yes | Yes | Yes | Yes | Yes | Yes | 100 |
| 5647 | Yes | Yes | Yes | Yes | Yes | Yes | Yes | Yes | Yes | Yes | 100 |
| 5648 | Yes | No | Yes | Yes | Yes | Yes | Yes | Yes | Yes | Yes | 90 |
| 5649(FH) | Yes | Yes | Yes | Yes | No | Yes | Yes | Yes | Yes | Yes | 90 |

6.2.3 Channel Availability Check Time

If the EUT successfully detected the radar burst, it should be observed as the EUT has no transmissions occurred until the EUT starts transmitting on another channel.

| Timing of Radar Signal | Observation | |
|------------------------|-------------|-------------------|
| | EUT | Spectrum Analyzer |
| Within 1 to 6 second | Detected | No transmissions |
| Within 54 to 60 second | Detected | No transmissions |

Initial Channel Availability Check Time

Channel Availability Check @ CH114 - 5570MHz

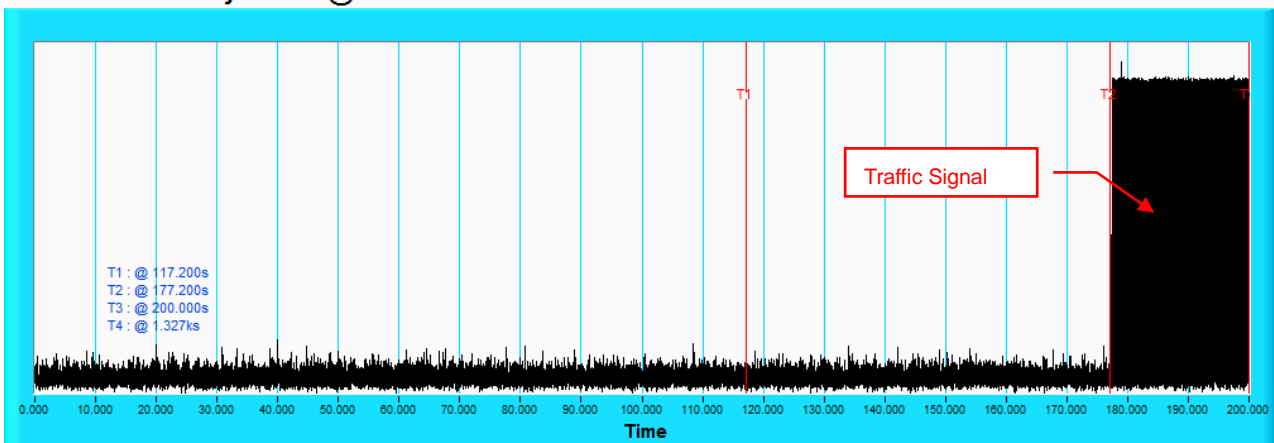

NOTE: T1 denotes the end of power-up time period is 117.2th second. T2 denotes the end of Channel Availability Check time is 177.2th second. Channel Availability Check time is equal to (T2 – T1) 60 seconds.

Radar Burst at the Beginning of the Channel Availability Check Time

Channel Availability Check @ CH114 - 5570MHz

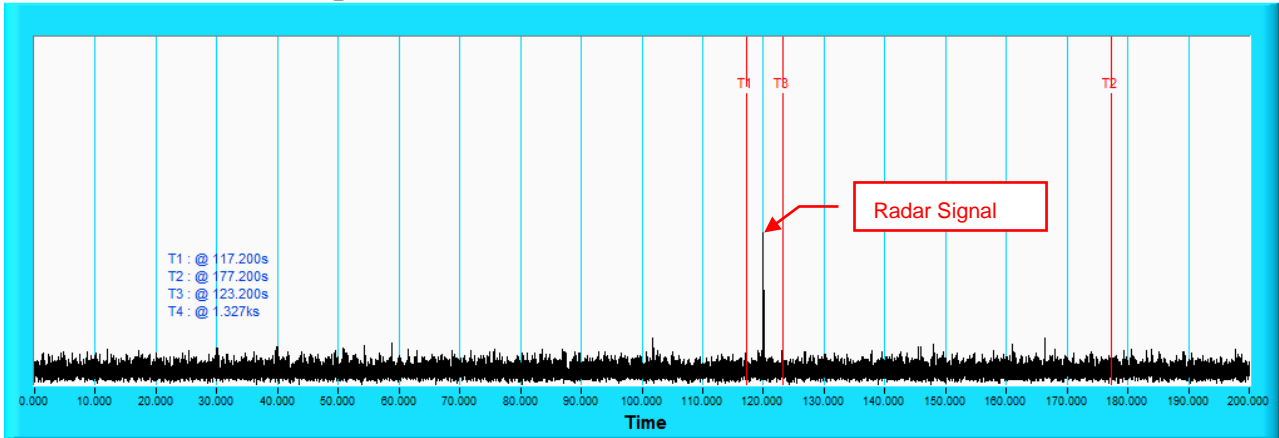

NOTE: T1 denotes the end of power up time period is 117.2th second. T3 denotes 123.2th second and the radar burst was commenced within a 6 second window starting from the end of power-up sequence. T2 denotes the 177.2th second.

Radar Burst at the End of the Channel Availability Check Time

Channel Availability Check @ CH114 - 5570MHz

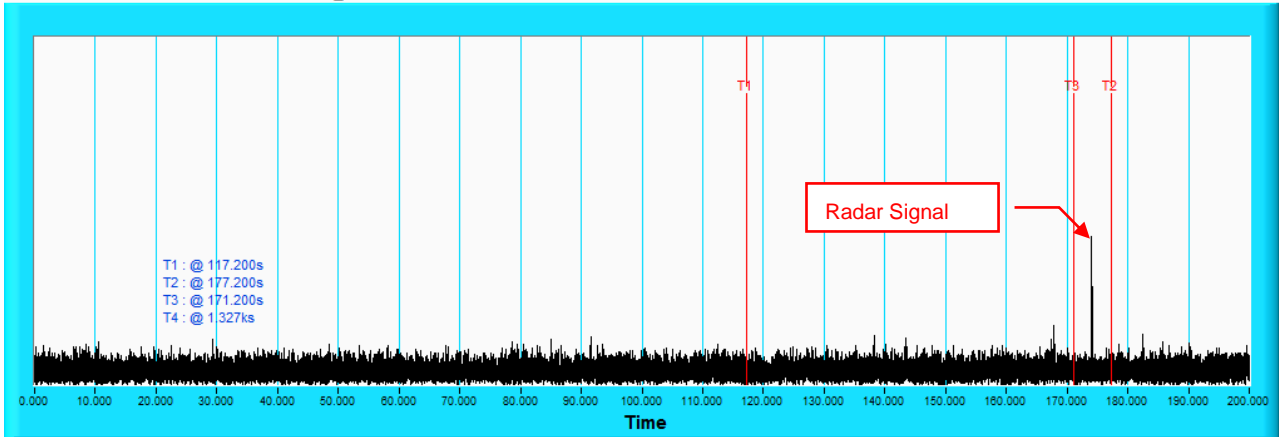

NOTE: T1 denotes the end of power up time period is 117.2th second. T3 denotes 171.2th second and the radar burst was commenced within 54th second to 60th second window starting from the end of power-up sequence. T2 denotes the 177.2th second.

6.2.4 Channel Closing Transmission and Channel Move Time

Wireless Traffic Loading

802.11ax (HE20)

Duty Cycle

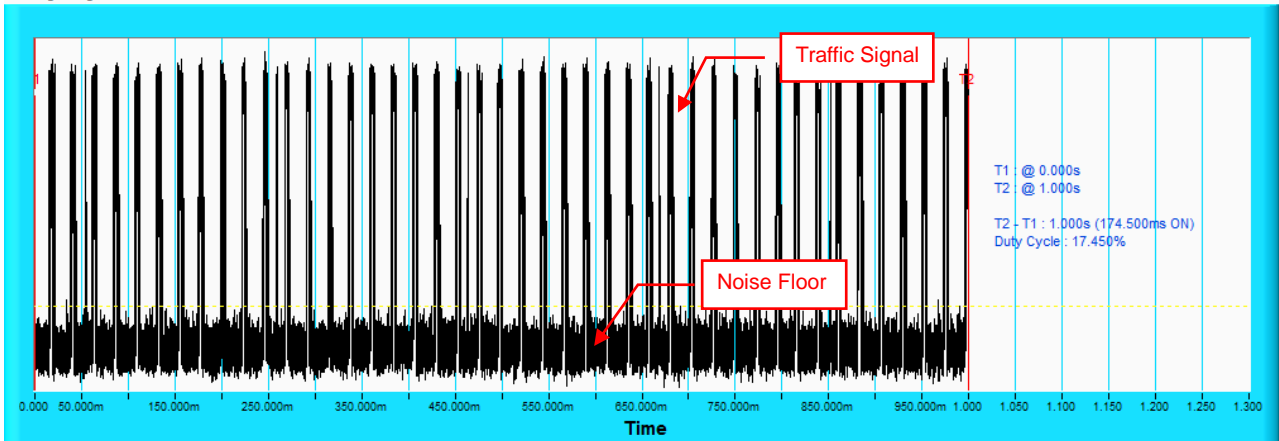

802.11ax (HE40)

Duty Cycle

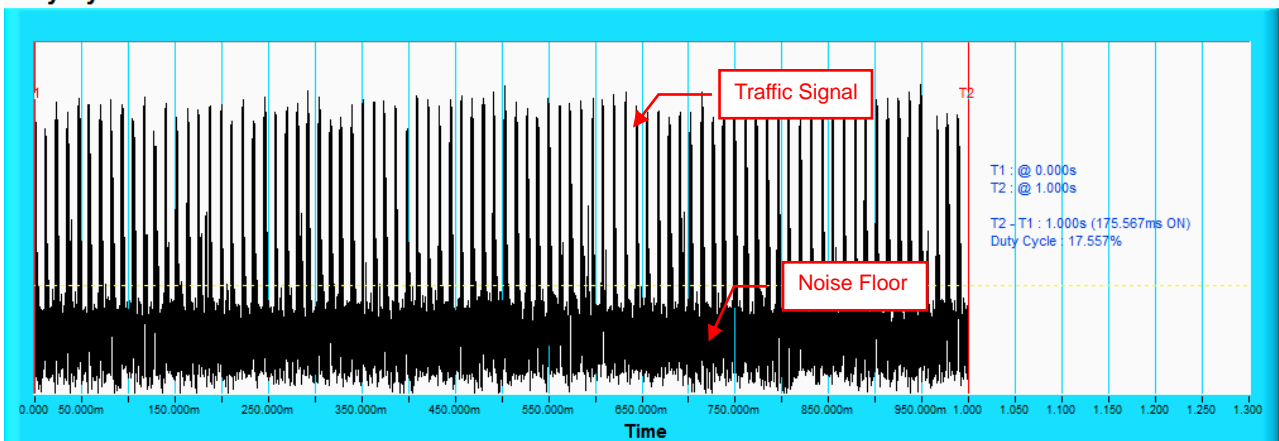

802.11ax (HE80)

Duty Cycle

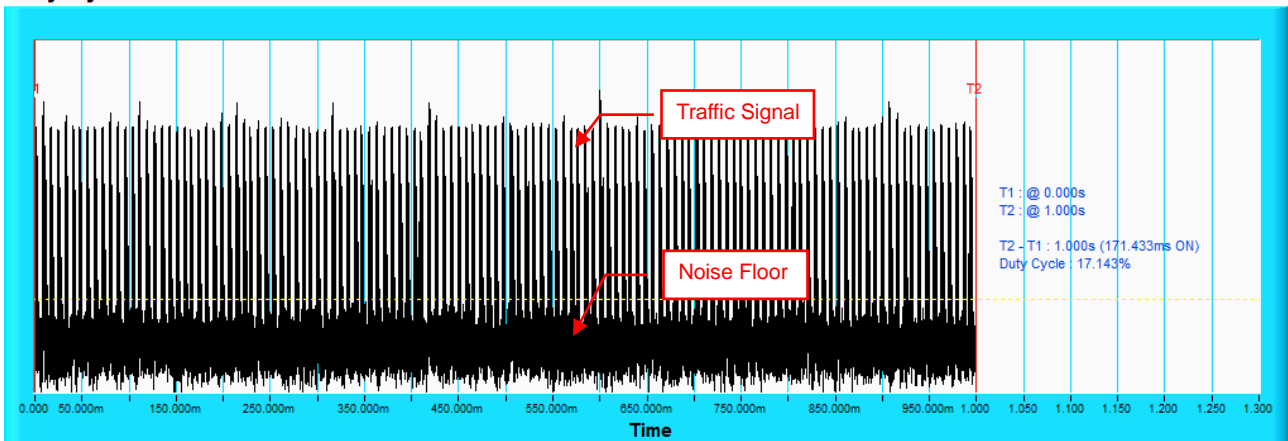



802.11ax (HE160)

Duty Cycle

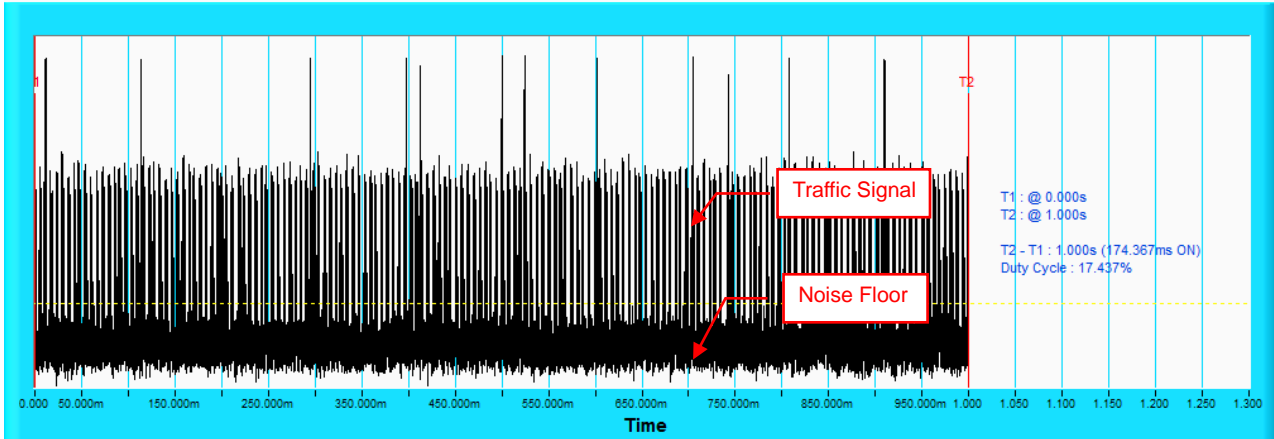

802.11ax (HE20)
Table 1: Short Pulse Radar Test Waveforms

| Radar Type | Pulse Width (μsec) | PRI (μsec) | Number of Pulses | Number of Trials(Times) | Percentage of Successful Detection (%) |
|-----------------------------|--|---|------------------|-------------------------|--|
| 1 | Test A 15 unique PRI values randomly selected from the list of 23 PRI values | Roundup $\left\{ \left(\frac{1}{360} \right) \cdot \left(\frac{19 \cdot 10^6}{\text{PRI}_{\mu\text{sec}}} \right) \right\}$ | 18 | 30 | 90 |
| | 15 unique PRI values randomly selected within the range of 518~3066 μ sec with a minimum of 1 μ sec, excluding PRI values selected in Test A | | | | |
| 2 | 1-5 | 150-230 | 23-29 | 30 | 80 |
| 3 | 6-10 | 200-500 | 16-18 | 30 | 86.7 |
| 4 | 11-20 | 200-500 | 12-16 | 30 | 73.3 |
| Aggregate (Radar Types 1-4) | | | | 120 | 82.5 |

Table 2: Long Pulse Radar Test Waveform

| Radar Type | Pulse Width (μsec) | Chirp Width (MHz) | PRI (μsec) | Number of Pulses per Burst | Number of Bursts | Number of Trials(Times) | Percentage of Successful Detection (%) |
|------------|--------------------|-------------------|------------|----------------------------|------------------|-------------------------|--|
| 5 | 50-100 | 5-20 | 1000-2000 | 1-3 | 8-20 | 30 | 80 |

Table 3: Frequency Hopping Radar Test Waveform

| Radar Type | Pulse Width (μsec) | PRI (μsec) | Pulses per Hop | Hopping Rate (kHz) | Hopping Sequence Length (msec) | Number of Trials(Times) | Percentage of Successful Detection (%) |
|------------|--------------------|------------|----------------|--------------------|--------------------------------|-------------------------|--|
| 6 | 1 | 333 | 9 | 0.333 | 300 | 30 | 90 |

802.11ax (HE40)
Table 1: Short Pulse Radar Test Waveforms

| Radar Type | Pulse Width (μsec) | PRI (μsec) | Number of Pulses | Number of Trials(Times) | Percentage of Successful Detection (%) |
|-----------------------------|--|---|------------------|-------------------------|--|
| 1 | Test A 15 unique PRI values randomly selected from the list of 23 PRI values | Roundup $\left\{ \left(\frac{1}{360} \right) \cdot \left(\frac{19 \cdot 10^6}{\text{PRI}_{\mu\text{sec}}} \right) \right\}$ | 18 | 30 | 86.7 |
| | 15 unique PRI values randomly selected within the range of 518~3066 μ sec with a minimum of 1 μ sec, excluding PRI values selected in Test A | | | | |
| 2 | 1-5 | 150-230 | 23-29 | 30 | 83.3 |
| 3 | 6-10 | 200-500 | 16-18 | 30 | 76.7 |
| 4 | 11-20 | 200-500 | 12-16 | 30 | 76.7 |
| Aggregate (Radar Types 1-4) | | | | 120 | 80.8 |

Table 2: Long Pulse Radar Test Waveform

| Radar Type | Pulse Width (μsec) | Chirp Width (MHz) | PRI (μsec) | Number of Pulses per Burst | Number of Bursts | Number of Trials(Times) | Percentage of Successful Detection (%) |
|------------|--------------------|-------------------|------------|----------------------------|------------------|-------------------------|--|
| 5 | 50-100 | 5-20 | 1000-2000 | 1-3 | 8-20 | 30 | 83.3 |

Table 3: Frequency Hopping Radar Test Waveform

| Radar Type | Pulse Width (μsec) | PRI (μsec) | Pulses per Hop | Hopping Rate (kHz) | Hopping Sequence Length (msec) | Number of Trials(Times) | Percentage of Successful Detection (%) |
|------------|--------------------|------------|----------------|--------------------|--------------------------------|-------------------------|--|
| 6 | 1 | 333 | 9 | 0.333 | 300 | 30 | 90 |

802.11ax (HE80)
Table 1: Short Pulse Radar Test Waveforms

| Radar Type | Pulse Width (μsec) | PRI (μsec) | Number of Pulses | Number of Trials(Times) | Percentage of Successful Detection (%) |
|-----------------------------|--|--|------------------|-------------------------|--|
| 1 | Test A 15 unique PRI values randomly selected from the list of 23 PRI values | $\left\{ \begin{array}{c} 360 \\ \left[\frac{\text{PRI}_{\mu\text{sec}} 19}{10^6} \right] \end{array} \right\}$ | 18 | 30 | 90 |
| | 15 unique PRI values randomly selected within the range of 518~3066 μ sec with a minimum of 1 μ sec, excluding PRI values selected in Test A | | | | |
| 2 | 1-5 | 150-230 | 23-29 | 30 | 86.7 |
| 3 | 6-10 | 200-500 | 16-18 | 30 | 80 |
| 4 | 11-20 | 200-500 | 12-16 | 30 | 73.3 |
| Aggregate (Radar Types 1-4) | | | | 120 | 82.5 |

Table 2: Long Pulse Radar Test Waveform

| Radar Type | Pulse Width (μsec) | Chirp Width (MHz) | PRI (μsec) | Number of Pulses per Burst | Number of Bursts | Number of Trials(Times) | Percentage of Successful Detection (%) |
|------------|--------------------|-------------------|------------|----------------------------|------------------|-------------------------|--|
| 5 | 50-100 | 5-20 | 1000-2000 | 1-3 | 8-20 | 30 | 83.3 |

Table 3: Frequency Hopping Radar Test Waveform

| Radar Type | Pulse Width (μsec) | PRI (μsec) | Pulses per Hop | Hopping Rate (kHz) | Hopping Sequence Length (msec) | Number of Trials(Times) | Percentage of Successful Detection (%) |
|------------|--------------------|------------|----------------|--------------------|--------------------------------|-------------------------|--|
| 6 | 1 | 333 | 9 | 0.333 | 300 | 30 | 86.7 |

802.11ax (HE160)
Table 1: Short Pulse Radar Test Waveforms

| Radar Type | Pulse Width (μsec) | PRI (μsec) | Number of Pulses | Number of Trials(Times) | Percentage of Successful Detection (%) |
|-----------------------------|--|---|------------------|-------------------------|--|
| 1 | Test A 15 unique PRI values randomly selected from the list of 23 PRI values | $\left\{ \begin{array}{l} \left\lceil \frac{1}{3601} \right\rceil \dots \\ \left\lfloor \frac{19 \cdot 10^6}{3601} \right\rfloor \end{array} \right\}$ Roundup Roundup | 18 | 30 | 83.3 |
| | 15 unique PRI values randomly selected within the range of 518~3066 μ sec with a minimum of 1 μ sec, excluding PRI values selected in Test A | | | | |
| 2 | 1-5 | 150-230 | 23-29 | 30 | 83.3 |
| 3 | 6-10 | 200-500 | 16-18 | 30 | 90 |
| 4 | 11-20 | 200-500 | 12-16 | 30 | 76.7 |
| Aggregate (Radar Types 1-4) | | | | 120 | 83.3 |

Table 2: Long Pulse Radar Test Waveform

| Radar Type | Pulse Width (μsec) | Chirp Width (MHz) | PRI (μsec) | Number of Pulses per Burst | Number of Bursts | Number of Trials(Times) | Percentage of Successful Detection (%) |
|------------|--------------------|-------------------|------------|----------------------------|------------------|-------------------------|--|
| 5 | 50-100 | 5-20 | 1000-2000 | 1-3 | 8-20 | 30 | 90 |

Table 3: Frequency Hopping Radar Test Waveform

| Radar Type | Pulse Width (μsec) | PRI (μsec) | Pulses per Hop | Hopping Rate (kHz) | Hopping Sequence Length (msec) | Number of Trials(Times) | Percentage of Successful Detection (%) |
|------------|--------------------|------------|----------------|--------------------|--------------------------------|-------------------------|--|
| 6 | 1 | 333 | 9 | 0.333 | 300 | 30 | 86.7 |

Radar signal 0

802.11ax (HE160)

Channel Closing Transmission Time & Channel Move Time @ CH114 - 5570MHz

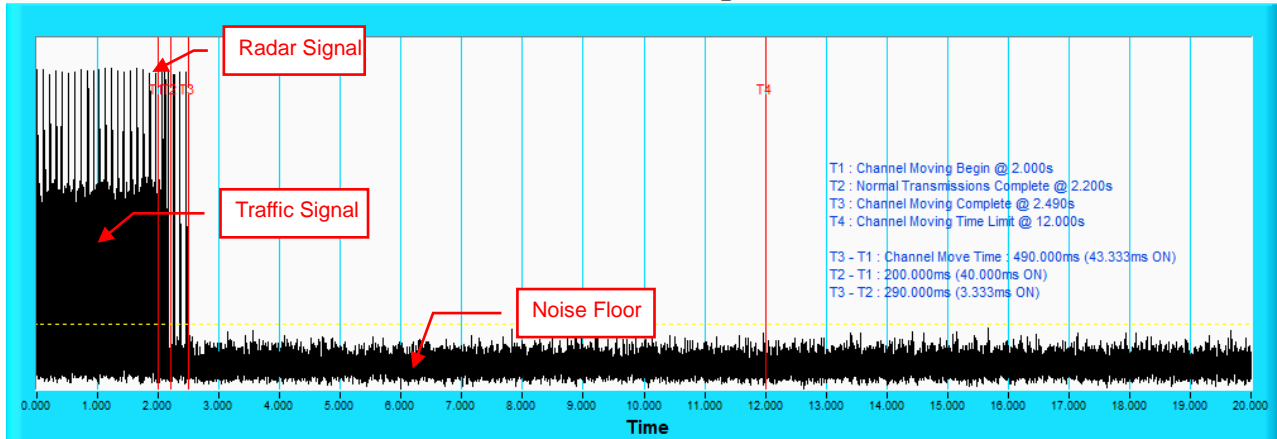

NOTE: T1 denotes the start of Channel Move Time upon the end of the last Radar burst. T2 denotes the data transmission time of 200ms from T1. T3 denotes the end of Channel Move Time. T4 denotes the 10 second from T1 to observe the aggregate duration of transmissions.

Channel Closing Transmission Time & Channel Move Time @ CH114 - 5570MHz

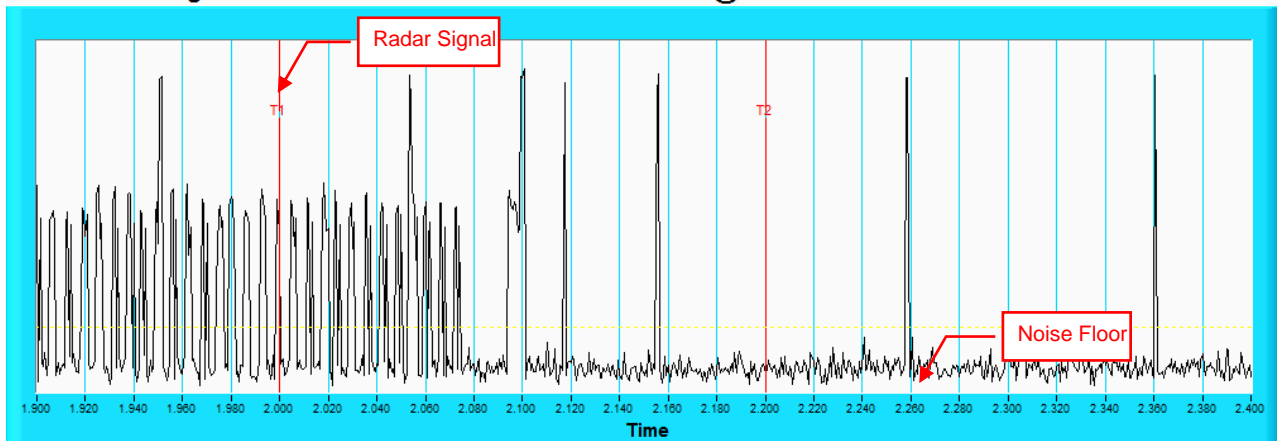

NOTE: Zoom in of the first 500ms after radar signal applied.

Radar signal 1

802.11ax (HE160)

Channel Closing Transmission Time & Channel Move Time @ CH114 - 5570MHz

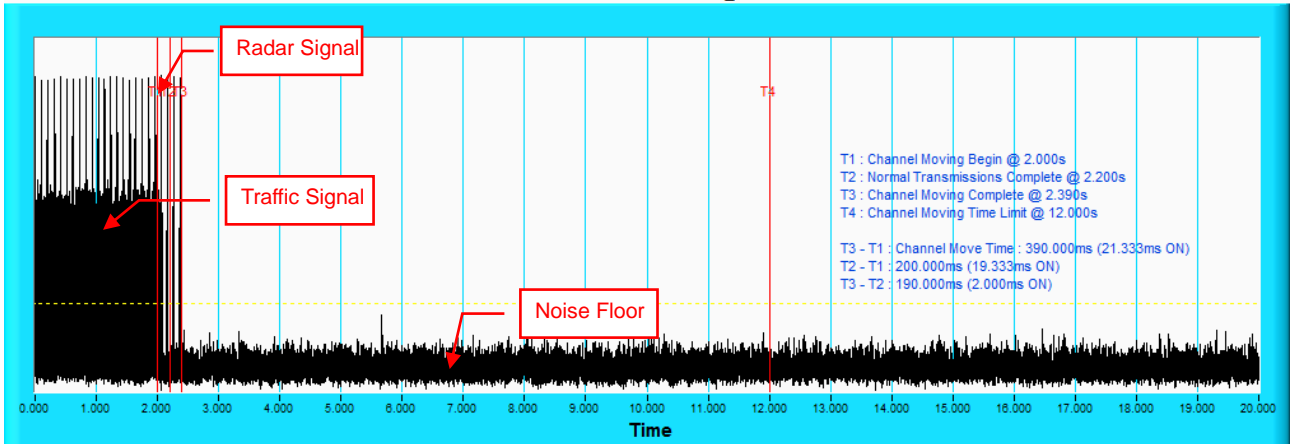

NOTE: T1 denotes the start of Channel Move Time upon the end of the last Radar burst. T2 denotes the data transmission time of 200ms from T1. T3 denotes the end of Channel Move Time. T4 denotes the 10 second from T1 to observe the aggregate duration of transmissions.

Channel Closing Transmission Time & Channel Move Time @ CH114 - 5570MHz

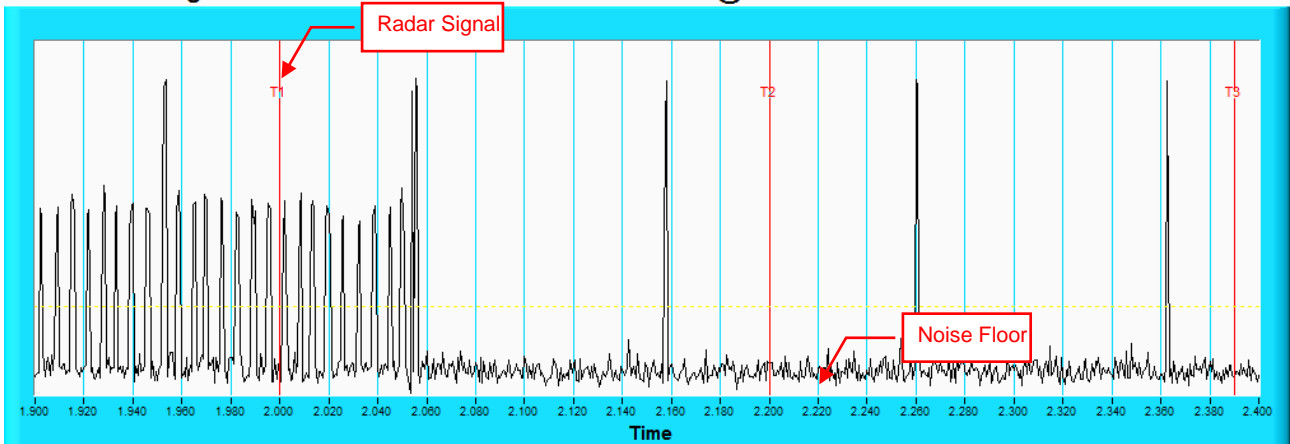

NOTE: Zoom in of the first 500ms after radar signal applied.

Radar signal 2

802.11ax (HE160)

Channel Closing Transmission Time & Channel Move Time @ CH114 - 5570MHz

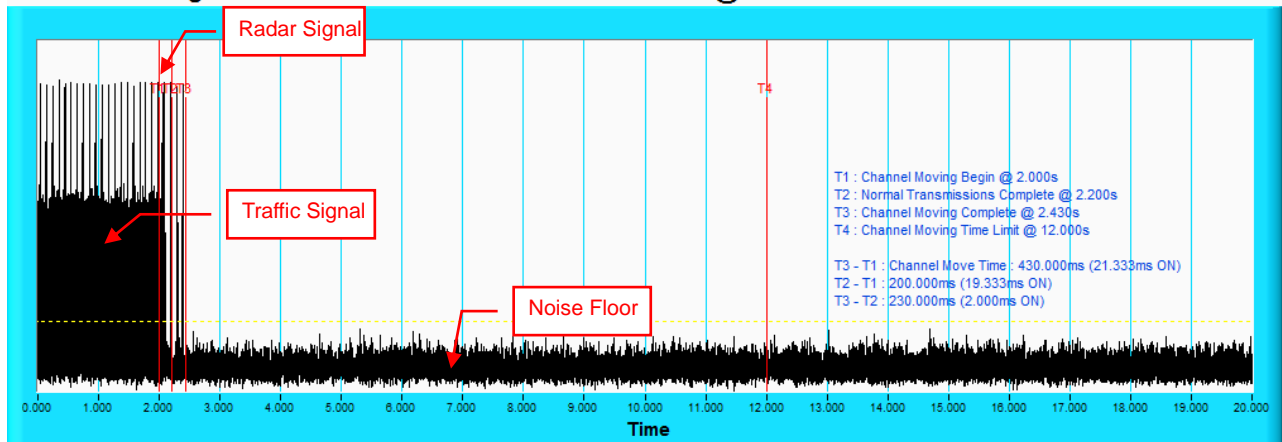

NOTE: T1 denotes the start of Channel Move Time upon the end of the last Radar burst. T2 denotes the data transmission time of 200ms from T1. T3 denotes the end of Channel Move Time. T4 denotes the 10 second from T1 to observe the aggregate duration of transmissions.

Channel Closing Transmission Time & Channel Move Time @ CH114 - 5570MHz

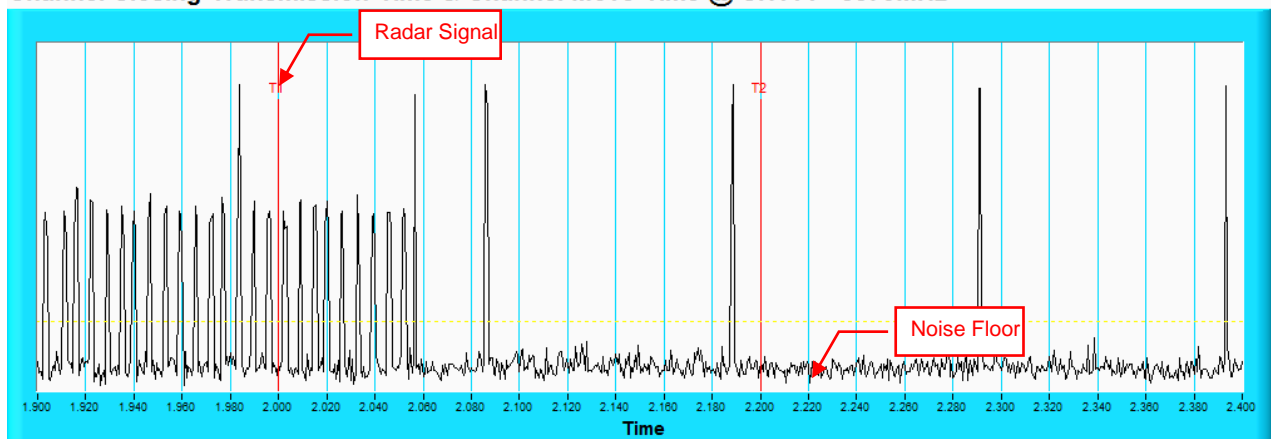

NOTE: Zoom in of the first 500ms after radar signal applied.

Radar signal 3

802.11ax (HE160)

Channel Closing Transmission Time & Channel Move Time @ CH114 - 5570MHz

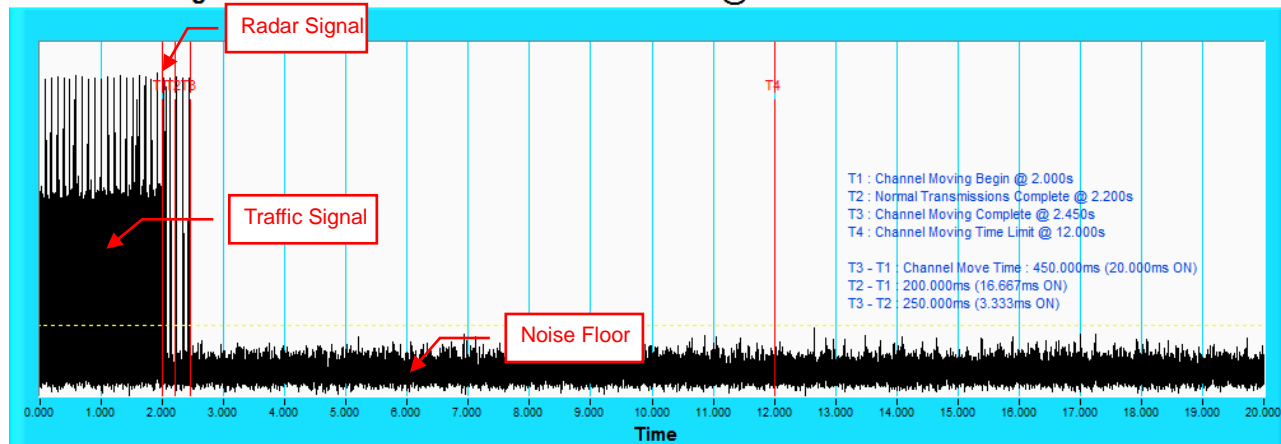

NOTE: T1 denotes the start of Channel Move Time upon the end of the last Radar burst. T2 denotes the data transmission time of 200ms from T1. T3 denotes the end of Channel Move Time. T4 denotes the 10 second from T1 to observe the aggregate duration of transmissions.

Channel Closing Transmission Time & Channel Move Time @ CH114 - 5570MHz

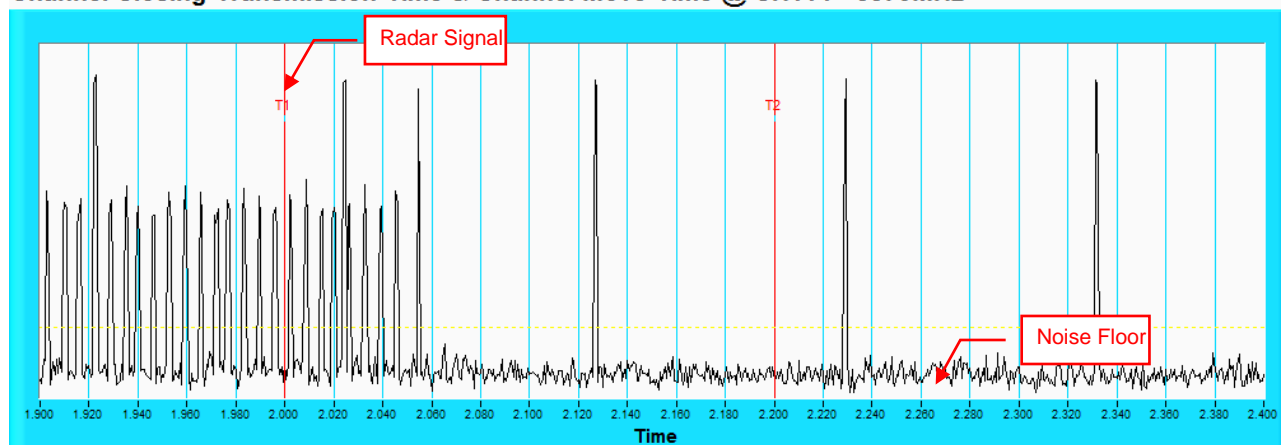

NOTE: Zoom in of the first 500ms after radar signal applied.

Radar signal 4

802.11ax (HE160)

Channel Closing Transmission Time & Channel Move Time @ CH114 - 5570MHz

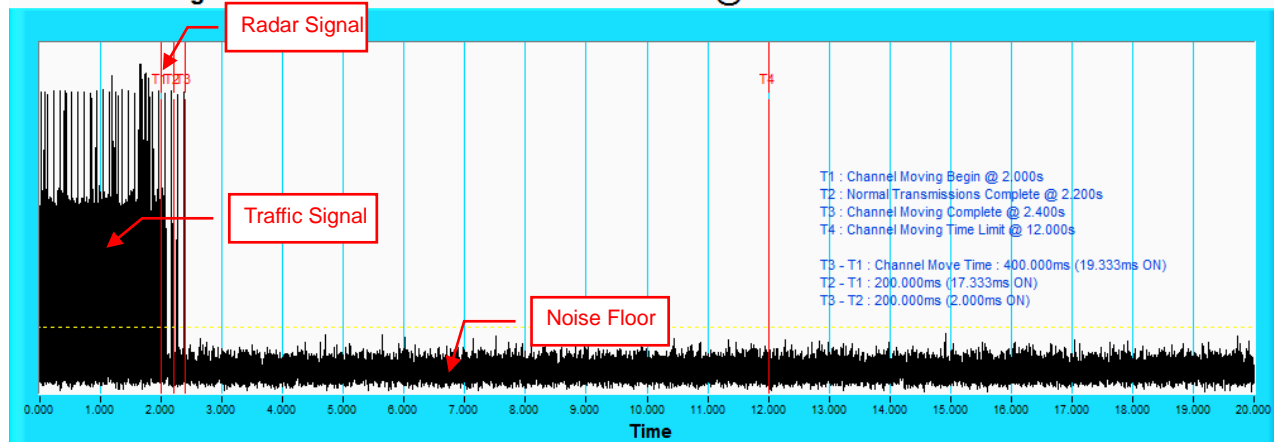

NOTE: T1 denotes the start of Channel Move Time upon the end of the last Radar burst. T2 denotes the data transmission time of 200ms from T1. T3 denotes the end of Channel Move Time. T4 denotes the 10 second from T1 to observe the aggregate duration of transmissions.

Channel Closing Transmission Time & Channel Move Time @ CH114 - 5570MHz

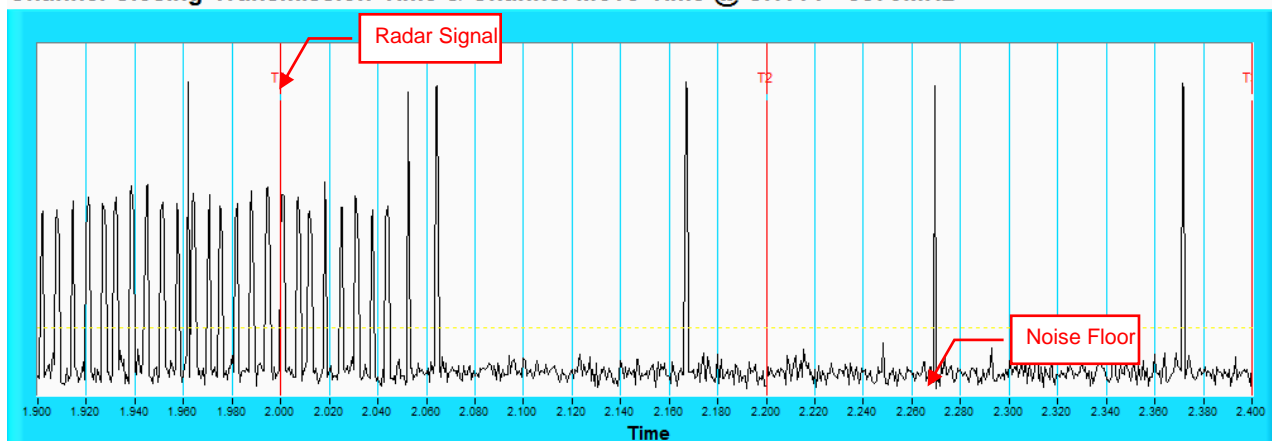

NOTE: Zoom in of the first 500ms after radar signal applied.



802.11ax (HE20)

Type 1 Radar Statistical Performances

| Trial # | Test Frequency (MHz) | Pulse Repetition Frequency Number (1 to 23) | Pulse Repetition Frequency (pps) | Pulses per Burst | Pulse Repetition Interval (µsec) | Detection |
|---------|----------------------|---|----------------------------------|------------------|----------------------------------|-----------|
| 1 | 5500 | 17 | 1193 | 63 | 838 | Yes |
| 2 | 5496 | 23 | 326.2 | 18 | 3066 | Yes |
| 3 | 5509 | 1 | 1931 | 102 | 518 | Yes |
| 4 | 5498 | 11 | 1393 | 74 | 718 | Yes |
| 5 | 5490 | 12 | 1355 | 72 | 738 | Yes |
| 6 | 5502 | 10 | 1433 | 76 | 698 | Yes |
| 7 | 5497 | 15 | 1253 | 67 | 798 | Yes |
| 8 | 5495 | 13 | 1319 | 70 | 758 | Yes |
| 9 | 5491 | 4 | 1730 | 92 | 578 | No |
| 10 | 5501 | 8 | 1520 | 81 | 658 | No |
| 11 | 5492 | 22 | 1066 | 57 | 938 | Yes |
| 12 | 5501 | 20 | 1114 | 59 | 898 | Yes |
| 13 | 5505 | 19 | 1139 | 61 | 878 | No |
| 14 | 5490 | 14 | 1285 | 68 | 778 | Yes |
| 15 | 5497 | 6 | 1618 | 86 | 618 | Yes |
| 16 | 5495 | - | 393.5 | 21 | 2541 | Yes |
| 17 | 5509 | - | 685.4 | 37 | 1459 | Yes |
| 18 | 5494 | - | 669.8 | 36 | 1493 | Yes |
| 19 | 5494 | - | 379.2 | 21 | 2637 | Yes |
| 20 | 5502 | - | 588.9 | 32 | 1698 | Yes |
| 21 | 5504 | - | 753.6 | 40 | 1327 | Yes |
| 22 | 5507 | - | 409.7 | 22 | 2441 | Yes |
| 23 | 5493 | - | 489.5 | 26 | 2043 | Yes |
| 24 | 5491 | - | 1647 | 87 | 607 | Yes |
| 25 | 5503 | - | 901.7 | 48 | 1109 | Yes |
| 26 | 5493 | - | 1024 | 55 | 977 | Yes |
| 27 | 5507 | - | 990.1 | 53 | 1010 | Yes |
| 28 | 5508 | - | 905.8 | 48 | 1104 | Yes |
| 29 | 5496 | - | 604.2 | 32 | 1655 | Yes |
| 30 | 5501 | - | 585.5 | 31 | 1708 | Yes |

Detection Rate : 90%

Note. " - " : 15 unique PRI values randomly selected within the range of 518-3066 µsec, with a minimum increment of 1µsec, excluding PRI values selected in Test A



802.11ax (HE20)

| Type 2 Radar Statistical Performances | | | | | |
|---------------------------------------|----------------------|------------------|-----------------|---------|-----------|
| Trial # | Test Frequency (MHz) | Pulses per Burst | Pulse Width(us) | PRI(us) | Detection |
| 1 | 5500 | 26 | 2.8 | 215 | Yes |
| 2 | 5506 | 29 | 4.5 | 230 | Yes |
| 3 | 5495 | 29 | 4.9 | 187 | Yes |
| 4 | 5501 | 27 | 3.8 | 164 | No |
| 5 | 5496 | 29 | 4.7 | 219 | Yes |
| 6 | 5507 | 23 | 1.3 | 228 | Yes |
| 7 | 5503 | 24 | 2 | 174 | Yes |
| 8 | 5496 | 23 | 1.4 | 208 | No |
| 9 | 5493 | 24 | 1.9 | 163 | Yes |
| 10 | 5505 | 28 | 4.1 | 152 | Yes |
| 11 | 5502 | 24 | 1.9 | 179 | Yes |
| 12 | 5491 | 28 | 4.1 | 170 | No |
| 13 | 5510 | 27 | 3.8 | 190 | Yes |
| 14 | 5496 | 29 | 4.9 | 172 | Yes |
| 15 | 5496 | 24 | 2.1 | 177 | Yes |
| 16 | 5491 | 29 | 4.5 | 191 | Yes |
| 17 | 5503 | 26 | 2.9 | 165 | No |
| 18 | 5504 | 25 | 2.5 | 159 | No |
| 19 | 5494 | 25 | 2.4 | 184 | Yes |
| 20 | 5499 | 27 | 3.6 | 218 | No |
| 21 | 5508 | 29 | 4.9 | 192 | Yes |
| 22 | 5498 | 23 | 1.5 | 171 | Yes |
| 23 | 5502 | 28 | 3.9 | 198 | Yes |
| 24 | 5508 | 27 | 3.5 | 157 | Yes |
| 25 | 5503 | 25 | 2.6 | 160 | Yes |
| 26 | 5505 | 24 | 1.8 | 211 | Yes |
| 27 | 5492 | 23 | 1.2 | 150 | Yes |
| 28 | 5500 | 23 | 1.1 | 226 | Yes |
| 29 | 5499 | 29 | 4.6 | 194 | Yes |
| 30 | 5500 | 28 | 4.3 | 199 | Yes |

Detection Rate : 80%



802.11ax (HE20)

Type 3 Radar Statistical Performances

| Trial # | Test Frequency (MHz) | Pulses per Burst | Pulse Width(us) | PRI(us) | Detection |
|---------|----------------------|------------------|-----------------|---------|-----------|
| 1 | 5500 | 17 | 7.8 | 417 | Yes |
| 2 | 5505 | 18 | 9.5 | 460 | Yes |
| 3 | 5507 | 18 | 9.9 | 499 | Yes |
| 4 | 5507 | 18 | 8.8 | 356 | Yes |
| 5 | 5508 | 18 | 9.7 | 293 | No |
| 6 | 5492 | 16 | 6.3 | 340 | Yes |
| 7 | 5509 | 16 | 7 | 223 | Yes |
| 8 | 5492 | 16 | 6.4 | 461 | Yes |
| 9 | 5494 | 16 | 6.9 | 445 | Yes |
| 10 | 5501 | 18 | 9.1 | 273 | Yes |
| 11 | 5492 | 16 | 6.9 | 234 | Yes |
| 12 | 5502 | 18 | 9.1 | 342 | Yes |
| 13 | 5503 | 18 | 8.8 | 479 | No |
| 14 | 5509 | 18 | 9.9 | 495 | Yes |
| 15 | 5495 | 16 | 7.1 | 472 | Yes |
| 16 | 5501 | 18 | 9.5 | 408 | Yes |
| 17 | 5491 | 17 | 7.9 | 203 | Yes |
| 18 | 5494 | 17 | 7.5 | 478 | Yes |
| 19 | 5493 | 17 | 7.4 | 244 | Yes |
| 20 | 5491 | 17 | 8.6 | 285 | No |
| 21 | 5491 | 18 | 9.9 | 422 | Yes |
| 22 | 5505 | 16 | 6.5 | 369 | Yes |
| 23 | 5492 | 18 | 8.9 | 367 | Yes |
| 24 | 5496 | 17 | 8.5 | 295 | No |
| 25 | 5498 | 17 | 7.6 | 300 | Yes |
| 26 | 5496 | 16 | 6.8 | 233 | Yes |
| 27 | 5500 | 16 | 6.2 | 238 | Yes |
| 28 | 5492 | 16 | 6.1 | 403 | Yes |
| 29 | 5493 | 18 | 9.6 | 372 | Yes |
| 30 | 5505 | 18 | 9.3 | 358 | Yes |

Detection Rate : 86.7%



802.11ax (HE20)

| Type 4 Radar Statistical Performances | | | | | |
|---------------------------------------|----------------------|------------------|-----------------|---------|-----------|
| Trial # | Test Frequency (MHz) | Pulses per Burst | Pulse Width(us) | PRI(us) | Detection |
| 1 | 5500 | 14 | 15 | 417 | Yes |
| 2 | 5505 | 16 | 18.8 | 460 | Yes |
| 3 | 5507 | 16 | 19.8 | 499 | Yes |
| 4 | 5507 | 15 | 17.2 | 356 | No |
| 5 | 5508 | 16 | 19.2 | 293 | Yes |
| 6 | 5492 | 12 | 11.6 | 340 | No |
| 7 | 5509 | 13 | 13.3 | 223 | Yes |
| 8 | 5492 | 12 | 11.9 | 461 | No |
| 9 | 5494 | 13 | 13 | 445 | No |
| 10 | 5501 | 15 | 18 | 273 | Yes |
| 11 | 5492 | 13 | 13 | 234 | Yes |
| 12 | 5502 | 15 | 17.8 | 342 | Yes |
| 13 | 5503 | 15 | 17.2 | 479 | Yes |
| 14 | 5509 | 16 | 19.8 | 495 | Yes |
| 15 | 5495 | 13 | 13.5 | 472 | Yes |
| 16 | 5501 | 16 | 18.8 | 408 | No |
| 17 | 5491 | 14 | 15.3 | 203 | Yes |
| 18 | 5494 | 13 | 14.4 | 478 | Yes |
| 19 | 5493 | 13 | 14.2 | 244 | Yes |
| 20 | 5491 | 15 | 16.8 | 285 | Yes |
| 21 | 5491 | 16 | 19.8 | 422 | No |
| 22 | 5505 | 12 | 12.2 | 369 | Yes |
| 23 | 5492 | 15 | 17.5 | 367 | Yes |
| 24 | 5496 | 15 | 16.6 | 295 | Yes |
| 25 | 5498 | 14 | 14.6 | 300 | Yes |
| 26 | 5496 | 13 | 12.8 | 233 | Yes |
| 27 | 5500 | 12 | 11.4 | 238 | Yes |
| 28 | 5492 | 12 | 11.2 | 403 | Yes |
| 29 | 5493 | 16 | 19.1 | 372 | No |
| 30 | 5505 | 16 | 18.3 | 358 | No |

Detection Rate : 73.3%



802.11ax (HE20)

Type 5 Radar Statistical Performances

| Trial # | Minimum Chirp Width(MHz) | Chirp Center Frequency(MHz) | Test Signal Name | Detection |
|---------|--------------------------|-----------------------------|------------------|-----------|
| 1 | 12 | 5500 | LP_Signal_01 | Yes |
| 2 | 18 | 5500 | LP_Signal_02 | Yes |
| 3 | 20 | 5500 | LP_Signal_03 | Yes |
| 4 | 16 | 5500 | LP_Signal_04 | Yes |
| 5 | 19 | 5500 | LP_Signal_05 | Yes |
| 6 | 6 | 5500 | LP_Signal_06 | Yes |
| 7 | 9 | 5500 | LP_Signal_07 | Yes |
| 8 | 6 | 5500 | LP_Signal_08 | Yes |
| 9 | 8 | 5500 | LP_Signal_09 | No |
| 10 | 17 | 5500 | LP_Signal_10 | Yes |
| 11 | 8 | 5493 | LP_Signal_11 | Yes |
| 12 | 17 | 5497 | LP_Signal_12 | Yes |
| 13 | 16 | 5496 | LP_Signal_13 | Yes |
| 14 | 20 | 5498 | LP_Signal_14 | Yes |
| 15 | 9 | 5494 | LP_Signal_15 | Yes |
| 16 | 18 | 5497 | LP_Signal_16 | Yes |
| 17 | 12 | 5495 | LP_Signal_17 | No |
| 18 | 11 | 5494 | LP_Signal_18 | Yes |
| 19 | 10 | 5494 | LP_Signal_19 | Yes |
| 20 | 15 | 5496 | LP_Signal_20 | Yes |
| 21 | 20 | 5502 | LP_Signal_21 | Yes |
| 22 | 7 | 5507 | LP_Signal_22 | Yes |
| 23 | 16 | 5504 | LP_Signal_23 | Yes |
| 24 | 14 | 5504 | LP_Signal_24 | No |
| 25 | 11 | 5506 | LP_Signal_25 | No |
| 26 | 8 | 5507 | LP_Signal_26 | No |
| 27 | 5 | 5508 | LP_Signal_27 | Yes |
| 28 | 5 | 5508 | LP_Signal_28 | No |
| 29 | 19 | 5502 | LP_Signal_29 | Yes |
| 30 | 17 | 5503 | LP_Signal_30 | Yes |

Detection Rate : 80%

Note: The Long Pulse Radar pattern shown in Appendix A.1



802.11ax (HE20)

| Type 6 Radar Statistical Performances | | | | | |
|---------------------------------------|------------------|-----------------|---------|---------------------------------|-----------|
| Trial # | Pulses per Burst | Pulse Width(us) | PRI(us) | Hopping Frequency Sequence Name | Detection |
| 1 | 9 | 1 | 333.3 | HOP_FREQ_SEQ_01 | Yes |
| 2 | 9 | 1 | 333.3 | HOP_FREQ_SEQ_02 | Yes |
| 3 | 9 | 1 | 333.3 | HOP_FREQ_SEQ_03 | Yes |
| 4 | 9 | 1 | 333.3 | HOP_FREQ_SEQ_04 | Yes |
| 5 | 9 | 1 | 333.3 | HOP_FREQ_SEQ_05 | Yes |
| 6 | 9 | 1 | 333.3 | HOP_FREQ_SEQ_06 | Yes |
| 7 | 9 | 1 | 333.3 | HOP_FREQ_SEQ_07 | Yes |
| 8 | 9 | 1 | 333.3 | HOP_FREQ_SEQ_08 | Yes |
| 9 | 9 | 1 | 333.3 | HOP_FREQ_SEQ_09 | Yes |
| 10 | 9 | 1 | 333.3 | HOP_FREQ_SEQ_10 | No |
| 11 | 9 | 1 | 333.3 | HOP_FREQ_SEQ_11 | Yes |
| 12 | 9 | 1 | 333.3 | HOP_FREQ_SEQ_12 | Yes |
| 13 | 9 | 1 | 333.3 | HOP_FREQ_SEQ_13 | Yes |
| 14 | 9 | 1 | 333.3 | HOP_FREQ_SEQ_14 | Yes |
| 15 | 9 | 1 | 333.3 | HOP_FREQ_SEQ_15 | Yes |
| 16 | 9 | 1 | 333.3 | HOP_FREQ_SEQ_16 | Yes |
| 17 | 9 | 1 | 333.3 | HOP_FREQ_SEQ_17 | Yes |
| 18 | 9 | 1 | 333.3 | HOP_FREQ_SEQ_18 | No |
| 19 | 9 | 1 | 333.3 | HOP_FREQ_SEQ_19 | Yes |
| 20 | 9 | 1 | 333.3 | HOP_FREQ_SEQ_20 | Yes |
| 21 | 9 | 1 | 333.3 | HOP_FREQ_SEQ_21 | Yes |
| 22 | 9 | 1 | 333.3 | HOP_FREQ_SEQ_22 | Yes |
| 23 | 9 | 1 | 333.3 | HOP_FREQ_SEQ_23 | Yes |
| 24 | 9 | 1 | 333.3 | HOP_FREQ_SEQ_24 | Yes |
| 25 | 9 | 1 | 333.3 | HOP_FREQ_SEQ_25 | Yes |
| 26 | 9 | 1 | 333.3 | HOP_FREQ_SEQ_26 | No |
| 27 | 9 | 1 | 333.3 | HOP_FREQ_SEQ_27 | Yes |
| 28 | 9 | 1 | 333.3 | HOP_FREQ_SEQ_28 | Yes |
| 29 | 9 | 1 | 333.3 | HOP_FREQ_SEQ_29 | Yes |
| 30 | 9 | 1 | 333.3 | HOP_FREQ_SEQ_30 | Yes |

Detection Rate : 90%

Note: The Frequency Hopping Radar pattern shown in Appendix A.2



802.11ax (HE40)

Type 1 Radar Statistical Performances

| Trial # | Test Frequency (MHz) | Pulse Repetition Frequency Number (1 to 23) | Pulse Repetition Frequency (pps) | Pulses per Burst | Pulse Repetition Interval (µsec) | Detection |
|---------|----------------------|---|----------------------------------|------------------|----------------------------------|-----------|
| 1 | 5510 | 17 | 1193 | 63 | 838 | Yes |
| 2 | 5520 | 23 | 326.2 | 18 | 3066 | Yes |
| 3 | 5500 | 1 | 1931 | 102 | 518 | Yes |
| 4 | 5517 | 11 | 1393 | 74 | 718 | Yes |
| 5 | 5519 | 12 | 1355 | 72 | 738 | Yes |
| 6 | 5528 | 10 | 1433 | 76 | 698 | Yes |
| 7 | 5496 | 15 | 1253 | 67 | 798 | Yes |
| 8 | 5529 | 13 | 1319 | 70 | 758 | Yes |
| 9 | 5511 | 4 | 1730 | 92 | 578 | Yes |
| 10 | 5501 | 8 | 1520 | 81 | 658 | Yes |
| 11 | 5498 | 22 | 1066 | 57 | 938 | Yes |
| 12 | 5515 | 20 | 1114 | 59 | 898 | Yes |
| 13 | 5521 | 19 | 1139 | 61 | 878 | No |
| 14 | 5526 | 14 | 1285 | 68 | 778 | No |
| 15 | 5499 | 6 | 1618 | 86 | 618 | Yes |
| 16 | 5511 | - | 393.5 | 21 | 2541 | Yes |
| 17 | 5522 | - | 685.4 | 37 | 1459 | Yes |
| 18 | 5513 | - | 669.8 | 36 | 1493 | Yes |
| 19 | 5502 | - | 379.2 | 21 | 2637 | Yes |
| 20 | 5499 | - | 588.9 | 32 | 1698 | Yes |
| 21 | 5526 | - | 753.6 | 40 | 1327 | Yes |
| 22 | 5499 | - | 409.7 | 22 | 2441 | Yes |
| 23 | 5522 | - | 489.5 | 26 | 2043 | No |
| 24 | 5511 | - | 1647 | 87 | 607 | No |
| 25 | 5508 | - | 901.7 | 48 | 1109 | Yes |
| 26 | 5510 | - | 1024 | 55 | 977 | Yes |
| 27 | 5512 | - | 990.1 | 53 | 1010 | Yes |
| 28 | 5522 | - | 905.8 | 48 | 1104 | Yes |
| 29 | 5514 | - | 604.2 | 32 | 1655 | Yes |
| 30 | 5499 | - | 585.5 | 31 | 1708 | Yes |

Detection Rate : 86.7%

Note. " - " : 15 unique PRI values randomly selected within the range of 518-3066 µsec, with a minimum increment of 1µsec, excluding PRI values selected in Test A



802.11ax (HE40)

| Type 2 Radar Statistical Performances | | | | | |
|---------------------------------------|----------------------|------------------|-----------------|---------|-----------|
| Trial # | Test Frequency (MHz) | Pulses per Burst | Pulse Width(us) | PRI(us) | Detection |
| 1 | 5510 | 26 | 2.8 | 215 | Yes |
| 2 | 5520 | 29 | 4.5 | 230 | Yes |
| 3 | 5500 | 29 | 4.9 | 187 | Yes |
| 4 | 5523 | 27 | 3.8 | 164 | Yes |
| 5 | 5508 | 29 | 4.7 | 219 | No |
| 6 | 5516 | 23 | 1.3 | 228 | Yes |
| 7 | 5514 | 24 | 2 | 174 | Yes |
| 8 | 5528 | 23 | 1.4 | 208 | Yes |
| 9 | 5492 | 24 | 1.9 | 163 | Yes |
| 10 | 5513 | 28 | 4.1 | 152 | Yes |
| 11 | 5517 | 24 | 1.9 | 179 | No |
| 12 | 5500 | 28 | 4.1 | 170 | Yes |
| 13 | 5497 | 27 | 3.8 | 190 | Yes |
| 14 | 5496 | 29 | 4.9 | 172 | Yes |
| 15 | 5528 | 24 | 2.1 | 177 | Yes |
| 16 | 5498 | 29 | 4.5 | 191 | Yes |
| 17 | 5491 | 26 | 2.9 | 165 | Yes |
| 18 | 5495 | 25 | 2.5 | 159 | Yes |
| 19 | 5521 | 25 | 2.4 | 184 | No |
| 20 | 5502 | 27 | 3.6 | 218 | Yes |
| 21 | 5527 | 29 | 4.9 | 192 | Yes |
| 22 | 5501 | 23 | 1.5 | 171 | Yes |
| 23 | 5514 | 28 | 3.9 | 198 | Yes |
| 24 | 5523 | 27 | 3.5 | 157 | Yes |
| 25 | 5524 | 25 | 2.6 | 160 | No |
| 26 | 5529 | 24 | 1.8 | 211 | Yes |
| 27 | 5518 | 23 | 1.2 | 150 | Yes |
| 28 | 5511 | 23 | 1.1 | 226 | Yes |
| 29 | 5527 | 29 | 4.6 | 194 | No |
| 30 | 5521 | 28 | 4.3 | 199 | Yes |

Detection Rate : 83.3%



802.11ax (HE40)

Type 3 Radar Statistical Performances

| Trial # | Test Frequency (MHz) | Pulses per Burst | Pulse Width(us) | PRI(us) | Detection |
|---------|----------------------|------------------|-----------------|---------|-----------|
| 1 | 5510 | 17 | 7.8 | 417 | Yes |
| 2 | 5520 | 18 | 9.5 | 460 | Yes |
| 3 | 5500 | 18 | 9.9 | 499 | Yes |
| 4 | 5502 | 18 | 8.8 | 356 | Yes |
| 5 | 5501 | 18 | 9.7 | 293 | Yes |
| 6 | 5509 | 16 | 6.3 | 340 | Yes |
| 7 | 5500 | 16 | 7 | 223 | Yes |
| 8 | 5527 | 16 | 6.4 | 461 | Yes |
| 9 | 5528 | 16 | 6.9 | 445 | Yes |
| 10 | 5518 | 18 | 9.1 | 273 | Yes |
| 11 | 5522 | 16 | 6.9 | 234 | No |
| 12 | 5499 | 18 | 9.1 | 342 | Yes |
| 13 | 5510 | 18 | 8.8 | 479 | Yes |
| 14 | 5501 | 18 | 9.9 | 495 | Yes |
| 15 | 5527 | 16 | 7.1 | 472 | Yes |
| 16 | 5515 | 18 | 9.5 | 408 | Yes |
| 17 | 5515 | 17 | 7.9 | 203 | No |
| 18 | 5495 | 17 | 7.5 | 478 | No |
| 19 | 5497 | 17 | 7.4 | 244 | Yes |
| 20 | 5507 | 17 | 8.6 | 285 | Yes |
| 21 | 5526 | 18 | 9.9 | 422 | No |
| 22 | 5495 | 16 | 6.5 | 369 | No |
| 23 | 5501 | 18 | 8.9 | 367 | No |
| 24 | 5505 | 17 | 8.5 | 295 | Yes |
| 25 | 5518 | 17 | 7.6 | 300 | Yes |
| 26 | 5526 | 16 | 6.8 | 233 | Yes |
| 27 | 5494 | 16 | 6.2 | 238 | No |
| 28 | 5513 | 16 | 6.1 | 403 | Yes |
| 29 | 5502 | 18 | 9.6 | 372 | Yes |
| 30 | 5517 | 18 | 9.3 | 358 | Yes |

Detection Rate : 76.7%



802.11ax (HE40)

Type 4 Radar Statistical Performances

| Trial # | Test Frequency (MHz) | Pulses per Burst | Pulse Width(us) | PRI(us) | Detection |
|---------|----------------------|------------------|-----------------|---------|-----------|
| 1 | 5510 | 14 | 15 | 417 | Yes |
| 2 | 5520 | 16 | 18.8 | 460 | Yes |
| 3 | 5500 | 16 | 19.8 | 499 | Yes |
| 4 | 5492 | 15 | 17.2 | 356 | No |
| 5 | 5492 | 16 | 19.2 | 293 | Yes |
| 6 | 5513 | 12 | 11.6 | 340 | Yes |
| 7 | 5500 | 13 | 13.3 | 223 | Yes |
| 8 | 5496 | 12 | 11.9 | 461 | Yes |
| 9 | 5500 | 13 | 13 | 445 | Yes |
| 10 | 5508 | 15 | 18 | 273 | Yes |
| 11 | 5521 | 13 | 13 | 234 | Yes |
| 12 | 5491 | 15 | 17.8 | 342 | No |
| 13 | 5498 | 15 | 17.2 | 479 | Yes |
| 14 | 5517 | 16 | 19.8 | 495 | Yes |
| 15 | 5510 | 13 | 13.5 | 472 | No |
| 16 | 5502 | 16 | 18.8 | 408 | No |
| 17 | 5491 | 14 | 15.3 | 203 | Yes |
| 18 | 5529 | 13 | 14.4 | 478 | Yes |
| 19 | 5505 | 13 | 14.2 | 244 | Yes |
| 20 | 5511 | 15 | 16.8 | 285 | Yes |
| 21 | 5491 | 16 | 19.8 | 422 | Yes |
| 22 | 5525 | 12 | 12.2 | 369 | Yes |
| 23 | 5519 | 15 | 17.5 | 367 | Yes |
| 24 | 5528 | 15 | 16.6 | 295 | Yes |
| 25 | 5522 | 14 | 14.6 | 300 | Yes |
| 26 | 5526 | 13 | 12.8 | 233 | Yes |
| 27 | 5492 | 12 | 11.4 | 238 | No |
| 28 | 5492 | 12 | 11.2 | 403 | Yes |
| 29 | 5494 | 16 | 19.1 | 372 | No |
| 30 | 5513 | 16 | 18.3 | 358 | No |

Detection Rate : 76.7%



802.11ax (HE40)

Type 5 Radar Statistical Performances

| Trial # | Minimum Chirp Width(MHz) | Chirp Center Frequency(MHz) | Test Signal Name | Detection |
|---------|--------------------------|-----------------------------|------------------|-----------|
| 1 | 12 | 5510 | LP_Signal_01 | Yes |
| 2 | 18 | 5510 | LP_Signal_02 | Yes |
| 3 | 20 | 5510 | LP_Signal_03 | No |
| 4 | 16 | 5510 | LP_Signal_04 | Yes |
| 5 | 19 | 5510 | LP_Signal_05 | Yes |
| 6 | 6 | 5510 | LP_Signal_06 | No |
| 7 | 9 | 5510 | LP_Signal_07 | No |
| 8 | 6 | 5510 | LP_Signal_08 | Yes |
| 9 | 8 | 5510 | LP_Signal_09 | Yes |
| 10 | 17 | 5510 | LP_Signal_10 | Yes |
| 11 | 8 | 5493 | LP_Signal_11 | Yes |
| 12 | 17 | 5497 | LP_Signal_12 | Yes |
| 13 | 16 | 5496 | LP_Signal_13 | Yes |
| 14 | 20 | 5498 | LP_Signal_14 | No |
| 15 | 9 | 5494 | LP_Signal_15 | Yes |
| 16 | 18 | 5497 | LP_Signal_16 | Yes |
| 17 | 12 | 5495 | LP_Signal_17 | Yes |
| 18 | 11 | 5494 | LP_Signal_18 | Yes |
| 19 | 10 | 5494 | LP_Signal_19 | Yes |
| 20 | 15 | 5496 | LP_Signal_20 | Yes |
| 21 | 20 | 5522 | LP_Signal_21 | Yes |
| 22 | 7 | 5527 | LP_Signal_22 | Yes |
| 23 | 16 | 5524 | LP_Signal_23 | No |
| 24 | 14 | 5524 | LP_Signal_24 | Yes |
| 25 | 11 | 5526 | LP_Signal_25 | Yes |
| 26 | 8 | 5527 | LP_Signal_26 | Yes |
| 27 | 5 | 5528 | LP_Signal_27 | Yes |
| 28 | 5 | 5528 | LP_Signal_28 | Yes |
| 29 | 19 | 5522 | LP_Signal_29 | Yes |
| 30 | 17 | 5523 | LP_Signal_30 | Yes |

Detection Rate : 83.3%

Note: The Long Pulse Radar pattern shown in Appendix A.1



802.11ax (HE40)

| Type 6 Radar Statistical Performances | | | | | |
|---------------------------------------|------------------|-----------------|---------|---------------------------------|-----------|
| Trial # | Pulses per Burst | Pulse Width(us) | PRI(us) | Hopping Frequency Sequence Name | Detection |
| 1 | 9 | 1 | 333.3 | HOP_FREQ_SEQ_01 | Yes |
| 2 | 9 | 1 | 333.3 | HOP_FREQ_SEQ_02 | Yes |
| 3 | 9 | 1 | 333.3 | HOP_FREQ_SEQ_03 | Yes |
| 4 | 9 | 1 | 333.3 | HOP_FREQ_SEQ_04 | Yes |
| 5 | 9 | 1 | 333.3 | HOP_FREQ_SEQ_05 | Yes |
| 6 | 9 | 1 | 333.3 | HOP_FREQ_SEQ_06 | Yes |
| 7 | 9 | 1 | 333.3 | HOP_FREQ_SEQ_07 | Yes |
| 8 | 9 | 1 | 333.3 | HOP_FREQ_SEQ_08 | No |
| 9 | 9 | 1 | 333.3 | HOP_FREQ_SEQ_09 | Yes |
| 10 | 9 | 1 | 333.3 | HOP_FREQ_SEQ_10 | Yes |
| 11 | 9 | 1 | 333.3 | HOP_FREQ_SEQ_11 | Yes |
| 12 | 9 | 1 | 333.3 | HOP_FREQ_SEQ_12 | Yes |
| 13 | 9 | 1 | 333.3 | HOP_FREQ_SEQ_13 | Yes |
| 14 | 9 | 1 | 333.3 | HOP_FREQ_SEQ_14 | Yes |
| 15 | 9 | 1 | 333.3 | HOP_FREQ_SEQ_15 | No |
| 16 | 9 | 1 | 333.3 | HOP_FREQ_SEQ_16 | Yes |
| 17 | 9 | 1 | 333.3 | HOP_FREQ_SEQ_17 | Yes |
| 18 | 9 | 1 | 333.3 | HOP_FREQ_SEQ_18 | Yes |
| 19 | 9 | 1 | 333.3 | HOP_FREQ_SEQ_19 | Yes |
| 20 | 9 | 1 | 333.3 | HOP_FREQ_SEQ_20 | Yes |
| 21 | 9 | 1 | 333.3 | HOP_FREQ_SEQ_21 | No |
| 22 | 9 | 1 | 333.3 | HOP_FREQ_SEQ_22 | Yes |
| 23 | 9 | 1 | 333.3 | HOP_FREQ_SEQ_23 | Yes |
| 24 | 9 | 1 | 333.3 | HOP_FREQ_SEQ_24 | Yes |
| 25 | 9 | 1 | 333.3 | HOP_FREQ_SEQ_25 | Yes |
| 26 | 9 | 1 | 333.3 | HOP_FREQ_SEQ_26 | Yes |
| 27 | 9 | 1 | 333.3 | HOP_FREQ_SEQ_27 | Yes |
| 28 | 9 | 1 | 333.3 | HOP_FREQ_SEQ_28 | Yes |
| 29 | 9 | 1 | 333.3 | HOP_FREQ_SEQ_29 | Yes |
| 30 | 9 | 1 | 333.3 | HOP_FREQ_SEQ_30 | Yes |

Detection Rate : 90%

Note: The Frequency Hopping Radar pattern shown in Appendix A.2



802.11ax (HE80)

Type 1 Radar Statistical Performances

| Trial # | Test Frequency (MHz) | Pulse Repetition Frequency Number (1 to 23) | Pulse Repetition Frequency (pps) | Pulses per Burst | Pulse Repetition Interval (µsec) | Detection |
|---------|----------------------|---|----------------------------------|------------------|----------------------------------|-----------|
| 1 | 5530 | 17 | 1193 | 63 | 838 | Yes |
| 2 | 5540 | 23 | 326.2 | 18 | 3066 | No |
| 3 | 5560 | 1 | 1931 | 102 | 518 | Yes |
| 4 | 5520 | 11 | 1393 | 74 | 718 | Yes |
| 5 | 5500 | 12 | 1355 | 72 | 738 | Yes |
| 6 | 5515 | 10 | 1433 | 76 | 698 | Yes |
| 7 | 5532 | 15 | 1253 | 67 | 798 | Yes |
| 8 | 5515 | 13 | 1319 | 70 | 758 | Yes |
| 9 | 5543 | 4 | 1730 | 92 | 578 | Yes |
| 10 | 5494 | 8 | 1520 | 81 | 658 | Yes |
| 11 | 5525 | 22 | 1066 | 57 | 938 | Yes |
| 12 | 5509 | 20 | 1114 | 59 | 898 | Yes |
| 13 | 5566 | 19 | 1139 | 61 | 878 | Yes |
| 14 | 5495 | 14 | 1285 | 68 | 778 | Yes |
| 15 | 5558 | 6 | 1618 | 86 | 618 | Yes |
| 16 | 5546 | - | 393.5 | 21 | 2541 | Yes |
| 17 | 5532 | - | 685.4 | 37 | 1459 | Yes |
| 18 | 5522 | - | 669.8 | 36 | 1493 | Yes |
| 19 | 5540 | - | 379.2 | 21 | 2637 | Yes |
| 20 | 5568 | - | 588.9 | 32 | 1698 | Yes |
| 21 | 5554 | - | 753.6 | 40 | 1327 | Yes |
| 22 | 5551 | - | 409.7 | 22 | 2441 | Yes |
| 23 | 5511 | - | 489.5 | 26 | 2043 | Yes |
| 24 | 5558 | - | 1647 | 87 | 607 | No |
| 25 | 5526 | - | 901.7 | 48 | 1109 | Yes |
| 26 | 5548 | - | 1024 | 55 | 977 | Yes |
| 27 | 5521 | - | 990.1 | 53 | 1010 | Yes |
| 28 | 5550 | - | 905.8 | 48 | 1104 | Yes |
| 29 | 5547 | - | 604.2 | 32 | 1655 | Yes |
| 30 | 5534 | - | 585.5 | 31 | 1708 | No |

Detection Rate : 90%

Note. " - " : 15 unique PRI values randomly selected within the range of 518-3066 µsec, with a minimum increment of 1µsec, excluding PRI values selected in Test A



802.11ax (HE80)

Type 2 Radar Statistical Performances

| Trial # | Test Frequency (MHz) | Pulses per Burst | Pulse Width(us) | PRI(us) | Detection |
|---------|----------------------|------------------|-----------------|---------|-----------|
| 1 | 5530 | 26 | 2.8 | 215 | Yes |
| 2 | 5540 | 29 | 4.5 | 230 | Yes |
| 3 | 5560 | 29 | 4.9 | 187 | Yes |
| 4 | 5520 | 27 | 3.8 | 164 | Yes |
| 5 | 5500 | 29 | 4.7 | 219 | Yes |
| 6 | 5494 | 23 | 1.3 | 228 | No |
| 7 | 5521 | 24 | 2 | 174 | Yes |
| 8 | 5563 | 23 | 1.4 | 208 | Yes |
| 9 | 5496 | 24 | 1.9 | 163 | No |
| 10 | 5558 | 28 | 4.1 | 152 | Yes |
| 11 | 5526 | 24 | 1.9 | 179 | Yes |
| 12 | 5548 | 28 | 4.1 | 170 | Yes |
| 13 | 5538 | 27 | 3.8 | 190 | Yes |
| 14 | 5514 | 29 | 4.9 | 172 | Yes |
| 15 | 5530 | 24 | 2.1 | 177 | Yes |
| 16 | 5520 | 29 | 4.5 | 191 | Yes |
| 17 | 5553 | 26 | 2.9 | 165 | Yes |
| 18 | 5545 | 25 | 2.5 | 159 | Yes |
| 19 | 5516 | 25 | 2.4 | 184 | Yes |
| 20 | 5493 | 27 | 3.6 | 218 | No |
| 21 | 5506 | 29 | 4.9 | 192 | Yes |
| 22 | 5523 | 23 | 1.5 | 171 | Yes |
| 23 | 5537 | 28 | 3.9 | 198 | Yes |
| 24 | 5505 | 27 | 3.5 | 157 | Yes |
| 25 | 5546 | 25 | 2.6 | 160 | Yes |
| 26 | 5513 | 24 | 1.8 | 211 | Yes |
| 27 | 5526 | 23 | 1.2 | 150 | Yes |
| 28 | 5565 | 23 | 1.1 | 226 | No |
| 29 | 5567 | 29 | 4.6 | 194 | Yes |
| 30 | 5528 | 28 | 4.3 | 199 | Yes |

Detection Rate : 86.7%



802.11ax (HE80)

Type 3 Radar Statistical Performances

| Trial # | Test Frequency (MHz) | Pulses per Burst | Pulse Width(us) | PRI(us) | Detection |
|---------|----------------------|------------------|-----------------|---------|-----------|
| 1 | 5530 | 17 | 7.8 | 417 | No |
| 2 | 5540 | 18 | 9.5 | 460 | Yes |
| 3 | 5560 | 18 | 9.9 | 499 | Yes |
| 4 | 5520 | 18 | 8.8 | 356 | Yes |
| 5 | 5500 | 18 | 9.7 | 293 | Yes |
| 6 | 5539 | 16 | 6.3 | 340 | Yes |
| 7 | 5510 | 16 | 7 | 223 | Yes |
| 8 | 5558 | 16 | 6.4 | 461 | Yes |
| 9 | 5524 | 16 | 6.9 | 445 | Yes |
| 10 | 5532 | 18 | 9.1 | 273 | Yes |
| 11 | 5536 | 16 | 6.9 | 234 | Yes |
| 12 | 5524 | 18 | 9.1 | 342 | Yes |
| 13 | 5558 | 18 | 8.8 | 479 | Yes |
| 14 | 5525 | 18 | 9.9 | 495 | No |
| 15 | 5504 | 16 | 7.1 | 472 | Yes |
| 16 | 5555 | 18 | 9.5 | 408 | No |
| 17 | 5556 | 17 | 7.9 | 203 | Yes |
| 18 | 5556 | 17 | 7.5 | 478 | Yes |
| 19 | 5546 | 17 | 7.4 | 244 | No |
| 20 | 5535 | 17 | 8.6 | 285 | Yes |
| 21 | 5534 | 18 | 9.9 | 422 | No |
| 22 | 5562 | 16 | 6.5 | 369 | Yes |
| 23 | 5536 | 18 | 8.9 | 367 | Yes |
| 24 | 5523 | 17 | 8.5 | 295 | Yes |
| 25 | 5497 | 17 | 7.6 | 300 | Yes |
| 26 | 5546 | 16 | 6.8 | 233 | No |
| 27 | 5555 | 16 | 6.2 | 238 | Yes |
| 28 | 5533 | 16 | 6.1 | 403 | Yes |
| 29 | 5543 | 18 | 9.6 | 372 | Yes |
| 30 | 5568 | 18 | 9.3 | 358 | Yes |

Detection Rate : 80%



802.11ax (HE80)

| Type 4 Radar Statistical Performances | | | | | |
|---------------------------------------|----------------------|------------------|-----------------|---------|-----------|
| Trial # | Test Frequency (MHz) | Pulses per Burst | Pulse Width(us) | PRI(us) | Detection |
| 1 | 5530 | 14 | 15 | 417 | Yes |
| 2 | 5540 | 16 | 18.8 | 460 | Yes |
| 3 | 5560 | 16 | 19.8 | 499 | Yes |
| 4 | 5520 | 15 | 17.2 | 356 | No |
| 5 | 5500 | 16 | 19.2 | 293 | No |
| 6 | 5560 | 12 | 11.6 | 340 | Yes |
| 7 | 5546 | 13 | 13.3 | 223 | Yes |
| 8 | 5497 | 12 | 11.9 | 461 | Yes |
| 9 | 5536 | 13 | 13 | 445 | Yes |
| 10 | 5565 | 15 | 18 | 273 | Yes |
| 11 | 5565 | 13 | 13 | 234 | No |
| 12 | 5503 | 15 | 17.8 | 342 | Yes |
| 13 | 5500 | 15 | 17.2 | 479 | Yes |
| 14 | 5522 | 16 | 19.8 | 495 | Yes |
| 15 | 5557 | 13 | 13.5 | 472 | Yes |
| 16 | 5497 | 16 | 18.8 | 408 | Yes |
| 17 | 5544 | 14 | 15.3 | 203 | Yes |
| 18 | 5551 | 13 | 14.4 | 478 | Yes |
| 19 | 5535 | 13 | 14.2 | 244 | Yes |
| 20 | 5554 | 15 | 16.8 | 285 | No |
| 21 | 5521 | 16 | 19.8 | 422 | No |
| 22 | 5513 | 12 | 12.2 | 369 | Yes |
| 23 | 5567 | 15 | 17.5 | 367 | No |
| 24 | 5525 | 15 | 16.6 | 295 | Yes |
| 25 | 5514 | 14 | 14.6 | 300 | Yes |
| 26 | 5499 | 13 | 12.8 | 233 | Yes |
| 27 | 5537 | 12 | 11.4 | 238 | No |
| 28 | 5532 | 12 | 11.2 | 403 | Yes |
| 29 | 5518 | 16 | 19.1 | 372 | Yes |
| 30 | 5528 | 16 | 18.3 | 358 | No |

Detection Rate : 73.3%



802.11ax (HE80)

Type 5 Radar Statistical Performances

| Trial # | Minimum Chirp Width(MHz) | Chirp Center Frequency(MHz) | Test Signal Name | Detection |
|---------|--------------------------|-----------------------------|------------------|-----------|
| 1 | 12 | 5530 | LP_Signal_01 | No |
| 2 | 18 | 5530 | LP_Signal_02 | Yes |
| 3 | 20 | 5530 | LP_Signal_03 | Yes |
| 4 | 16 | 5530 | LP_Signal_04 | Yes |
| 5 | 19 | 5530 | LP_Signal_05 | Yes |
| 6 | 6 | 5530 | LP_Signal_06 | Yes |
| 7 | 9 | 5530 | LP_Signal_07 | Yes |
| 8 | 6 | 5530 | LP_Signal_08 | Yes |
| 9 | 8 | 5530 | LP_Signal_09 | Yes |
| 10 | 17 | 5530 | LP_Signal_10 | Yes |
| 11 | 8 | 5494 | LP_Signal_11 | No |
| 12 | 17 | 5498 | LP_Signal_12 | Yes |
| 13 | 16 | 5497 | LP_Signal_13 | Yes |
| 14 | 20 | 5499 | LP_Signal_14 | Yes |
| 15 | 9 | 5495 | LP_Signal_15 | Yes |
| 16 | 18 | 5498 | LP_Signal_16 | No |
| 17 | 12 | 5496 | LP_Signal_17 | Yes |
| 18 | 11 | 5495 | LP_Signal_18 | Yes |
| 19 | 10 | 5495 | LP_Signal_19 | Yes |
| 20 | 15 | 5497 | LP_Signal_20 | Yes |
| 21 | 20 | 5561 | LP_Signal_21 | Yes |
| 22 | 7 | 5566 | LP_Signal_22 | Yes |
| 23 | 16 | 5563 | LP_Signal_23 | No |
| 24 | 14 | 5563 | LP_Signal_24 | Yes |
| 25 | 11 | 5565 | LP_Signal_25 | Yes |
| 26 | 8 | 5566 | LP_Signal_26 | Yes |
| 27 | 5 | 5567 | LP_Signal_27 | Yes |
| 28 | 5 | 5567 | LP_Signal_28 | No |
| 29 | 19 | 5561 | LP_Signal_29 | Yes |
| 30 | 17 | 5562 | LP_Signal_30 | Yes |

Detection Rate : 83.3%

Note: The Long Pulse Radar pattern shown in Appendix A.1

802.11ax (HE80)

| Type 6 Radar Statistical Performances | | | | | |
|---------------------------------------|------------------|-----------------|---------|---------------------------------|-----------|
| Trial # | Pulses per Burst | Pulse Width(us) | PRI(us) | Hopping Frequency Sequence Name | Detection |
| 1 | 9 | 1 | 333.3 | HOP_FREQ_SEQ_01 | No |
| 2 | 9 | 1 | 333.3 | HOP_FREQ_SEQ_02 | Yes |
| 3 | 9 | 1 | 333.3 | HOP_FREQ_SEQ_03 | Yes |
| 4 | 9 | 1 | 333.3 | HOP_FREQ_SEQ_04 | Yes |
| 5 | 9 | 1 | 333.3 | HOP_FREQ_SEQ_05 | No |
| 6 | 9 | 1 | 333.3 | HOP_FREQ_SEQ_06 | Yes |
| 7 | 9 | 1 | 333.3 | HOP_FREQ_SEQ_07 | Yes |
| 8 | 9 | 1 | 333.3 | HOP_FREQ_SEQ_08 | Yes |
| 9 | 9 | 1 | 333.3 | HOP_FREQ_SEQ_09 | Yes |
| 10 | 9 | 1 | 333.3 | HOP_FREQ_SEQ_10 | No |
| 11 | 9 | 1 | 333.3 | HOP_FREQ_SEQ_11 | Yes |
| 12 | 9 | 1 | 333.3 | HOP_FREQ_SEQ_12 | Yes |
| 13 | 9 | 1 | 333.3 | HOP_FREQ_SEQ_13 | Yes |
| 14 | 9 | 1 | 333.3 | HOP_FREQ_SEQ_14 | Yes |
| 15 | 9 | 1 | 333.3 | HOP_FREQ_SEQ_15 | Yes |
| 16 | 9 | 1 | 333.3 | HOP_FREQ_SEQ_16 | Yes |
| 17 | 9 | 1 | 333.3 | HOP_FREQ_SEQ_17 | Yes |
| 18 | 9 | 1 | 333.3 | HOP_FREQ_SEQ_18 | Yes |
| 19 | 9 | 1 | 333.3 | HOP_FREQ_SEQ_19 | Yes |
| 20 | 9 | 1 | 333.3 | HOP_FREQ_SEQ_20 | Yes |
| 21 | 9 | 1 | 333.3 | HOP_FREQ_SEQ_21 | Yes |
| 22 | 9 | 1 | 333.3 | HOP_FREQ_SEQ_22 | Yes |
| 23 | 9 | 1 | 333.3 | HOP_FREQ_SEQ_23 | Yes |
| 24 | 9 | 1 | 333.3 | HOP_FREQ_SEQ_24 | Yes |
| 25 | 9 | 1 | 333.3 | HOP_FREQ_SEQ_25 | Yes |
| 26 | 9 | 1 | 333.3 | HOP_FREQ_SEQ_26 | Yes |
| 27 | 9 | 1 | 333.3 | HOP_FREQ_SEQ_27 | Yes |
| 28 | 9 | 1 | 333.3 | HOP_FREQ_SEQ_28 | Yes |
| 29 | 9 | 1 | 333.3 | HOP_FREQ_SEQ_29 | Yes |
| 30 | 9 | 1 | 333.3 | HOP_FREQ_SEQ_30 | No |
| Detection Rate : 86.7% | | | | | |

Note: The Frequency Hopping Radar pattern shown in Appendix A.2



802.11ax (HE160)

Type 1 Radar Statistical Performances

| Trial # | Test Frequency (MHz) | Pulse Repetition Frequency Number (1 to 23) | Pulse Repetition Frequency (pps) | Pulses per Burst | Pulse Repetition Interval (µsec) | Detection |
|---------|----------------------|---|----------------------------------|------------------|----------------------------------|-----------|
| 1 | 5570 | 17 | 1193 | 63 | 838 | Yes |
| 2 | 5580 | 23 | 326.2 | 18 | 3066 | No |
| 3 | 5600 | 1 | 1931 | 102 | 518 | Yes |
| 4 | 5560 | 11 | 1393 | 74 | 718 | Yes |
| 5 | 5540 | 12 | 1355 | 72 | 738 | Yes |
| 6 | 5500 | 10 | 1433 | 76 | 698 | Yes |
| 7 | 5508 | 15 | 1253 | 67 | 798 | Yes |
| 8 | 5561 | 13 | 1319 | 70 | 758 | Yes |
| 9 | 5620 | 4 | 1730 | 92 | 578 | No |
| 10 | 5581 | 8 | 1520 | 81 | 658 | Yes |
| 11 | 5539 | 22 | 1066 | 57 | 938 | Yes |
| 12 | 5595 | 20 | 1114 | 59 | 898 | Yes |
| 13 | 5646 | 19 | 1139 | 61 | 878 | Yes |
| 14 | 5539 | 14 | 1285 | 68 | 778 | Yes |
| 15 | 5639 | 6 | 1618 | 86 | 618 | Yes |
| 16 | 5592 | - | 393.5 | 21 | 2541 | Yes |
| 17 | 5563 | - | 685.4 | 37 | 1459 | Yes |
| 18 | 5506 | - | 669.8 | 36 | 1493 | No |
| 19 | 5632 | - | 379.2 | 21 | 2637 | Yes |
| 20 | 5569 | - | 588.9 | 32 | 1698 | Yes |
| 21 | 5591 | - | 753.6 | 40 | 1327 | Yes |
| 22 | 5605 | - | 409.7 | 22 | 2441 | Yes |
| 23 | 5492 | - | 489.5 | 26 | 2043 | Yes |
| 24 | 5598 | - | 1647 | 87 | 607 | Yes |
| 25 | 5602 | - | 901.7 | 48 | 1109 | Yes |
| 26 | 5494 | - | 1024 | 55 | 977 | Yes |
| 27 | 5632 | - | 990.1 | 53 | 1010 | No |
| 28 | 5642 | - | 905.8 | 48 | 1104 | No |
| 29 | 5643 | - | 604.2 | 32 | 1655 | Yes |
| 30 | 5550 | - | 585.5 | 31 | 1708 | Yes |

Detection Rate : 83.3%

Note. " - " : 15 unique PRI values randomly selected within the range of 518-3066 µsec, with a minimum increment of 1µsec, excluding PRI values selected in Test A



802.11ax (HE160)

| Type 2 Radar Statistical Performances | | | | | |
|---------------------------------------|----------------------|------------------|-----------------|---------|-----------|
| Trial # | Test Frequency (MHz) | Pulses per Burst | Pulse Width(us) | PRI(us) | Detection |
| 1 | 5570 | 26 | 2.8 | 215 | Yes |
| 2 | 5580 | 29 | 4.5 | 230 | Yes |
| 3 | 5600 | 29 | 4.9 | 187 | Yes |
| 4 | 5560 | 27 | 3.8 | 164 | Yes |
| 5 | 5540 | 29 | 4.7 | 219 | Yes |
| 6 | 5647 | 23 | 1.3 | 228 | Yes |
| 7 | 5528 | 24 | 2 | 174 | Yes |
| 8 | 5531 | 23 | 1.4 | 208 | Yes |
| 9 | 5493 | 24 | 1.9 | 163 | Yes |
| 10 | 5644 | 28 | 4.1 | 152 | Yes |
| 11 | 5498 | 24 | 1.9 | 179 | Yes |
| 12 | 5558 | 28 | 4.1 | 170 | Yes |
| 13 | 5585 | 27 | 3.8 | 190 | Yes |
| 14 | 5574 | 29 | 4.9 | 172 | No |
| 15 | 5641 | 24 | 2.1 | 177 | Yes |
| 16 | 5534 | 29 | 4.5 | 191 | Yes |
| 17 | 5549 | 26 | 2.9 | 165 | Yes |
| 18 | 5567 | 25 | 2.5 | 159 | Yes |
| 19 | 5561 | 25 | 2.4 | 184 | No |
| 20 | 5600 | 27 | 3.6 | 218 | Yes |
| 21 | 5614 | 29 | 4.9 | 192 | No |
| 22 | 5561 | 23 | 1.5 | 171 | Yes |
| 23 | 5491 | 28 | 3.9 | 198 | Yes |
| 24 | 5573 | 27 | 3.5 | 157 | Yes |
| 25 | 5575 | 25 | 2.6 | 160 | Yes |
| 26 | 5598 | 24 | 1.8 | 211 | No |
| 27 | 5620 | 23 | 1.2 | 150 | Yes |
| 28 | 5615 | 23 | 1.1 | 226 | No |
| 29 | 5594 | 29 | 4.6 | 194 | Yes |
| 30 | 5532 | 28 | 4.3 | 199 | Yes |

Detection Rate : 83.3%



802.11ax (HE160)

Type 3 Radar Statistical Performances

| Trial # | Test Frequency (MHz) | Pulses per Burst | Pulse Width(us) | PRI(us) | Detection |
|---------|----------------------|------------------|-----------------|---------|-----------|
| 1 | 5570 | 17 | 7.8 | 417 | Yes |
| 2 | 5580 | 18 | 9.5 | 460 | Yes |
| 3 | 5600 | 18 | 9.9 | 499 | Yes |
| 4 | 5560 | 18 | 8.8 | 356 | Yes |
| 5 | 5540 | 18 | 9.7 | 293 | Yes |
| 6 | 5607 | 16 | 6.3 | 340 | Yes |
| 7 | 5497 | 16 | 7 | 223 | Yes |
| 8 | 5612 | 16 | 6.4 | 461 | Yes |
| 9 | 5541 | 16 | 6.9 | 445 | Yes |
| 10 | 5572 | 18 | 9.1 | 273 | Yes |
| 11 | 5511 | 16 | 6.9 | 234 | Yes |
| 12 | 5615 | 18 | 9.1 | 342 | Yes |
| 13 | 5631 | 18 | 8.8 | 479 | Yes |
| 14 | 5593 | 18 | 9.9 | 495 | Yes |
| 15 | 5579 | 16 | 7.1 | 472 | Yes |
| 16 | 5497 | 18 | 9.5 | 408 | No |
| 17 | 5604 | 17 | 7.9 | 203 | Yes |
| 18 | 5614 | 17 | 7.5 | 478 | Yes |
| 19 | 5577 | 17 | 7.4 | 244 | Yes |
| 20 | 5613 | 17 | 8.6 | 285 | Yes |
| 21 | 5626 | 18 | 9.9 | 422 | No |
| 22 | 5575 | 16 | 6.5 | 369 | Yes |
| 23 | 5559 | 18 | 8.9 | 367 | Yes |
| 24 | 5555 | 17 | 8.5 | 295 | Yes |
| 25 | 5607 | 17 | 7.6 | 300 | No |
| 26 | 5519 | 16 | 6.8 | 233 | Yes |
| 27 | 5562 | 16 | 6.2 | 238 | Yes |
| 28 | 5611 | 16 | 6.1 | 403 | Yes |
| 29 | 5624 | 18 | 9.6 | 372 | Yes |
| 30 | 5639 | 18 | 9.3 | 358 | Yes |

Detection Rate : 90%



802.11ax (HE160)

| Type 4 Radar Statistical Performances | | | | | |
|---------------------------------------|----------------------|------------------|-----------------|---------|-----------|
| Trial # | Test Frequency (MHz) | Pulses per Burst | Pulse Width(us) | PRI(us) | Detection |
| 1 | 5570 | 14 | 15 | 417 | No |
| 2 | 5580 | 16 | 18.8 | 460 | No |
| 3 | 5600 | 16 | 19.8 | 499 | Yes |
| 4 | 5560 | 15 | 17.2 | 356 | Yes |
| 5 | 5540 | 16 | 19.2 | 293 | Yes |
| 6 | 5559 | 12 | 11.6 | 340 | Yes |
| 7 | 5565 | 13 | 13.3 | 223 | Yes |
| 8 | 5644 | 12 | 11.9 | 461 | Yes |
| 9 | 5645 | 13 | 13 | 445 | Yes |
| 10 | 5502 | 15 | 18 | 273 | Yes |
| 11 | 5597 | 13 | 13 | 234 | No |
| 12 | 5587 | 15 | 17.8 | 342 | Yes |
| 13 | 5627 | 15 | 17.2 | 479 | Yes |
| 14 | 5555 | 16 | 19.8 | 495 | Yes |
| 15 | 5644 | 13 | 13.5 | 472 | No |
| 16 | 5616 | 16 | 18.8 | 408 | Yes |
| 17 | 5640 | 14 | 15.3 | 203 | Yes |
| 18 | 5550 | 13 | 14.4 | 478 | No |
| 19 | 5629 | 13 | 14.2 | 244 | Yes |
| 20 | 5591 | 15 | 16.8 | 285 | Yes |
| 21 | 5548 | 16 | 19.8 | 422 | No |
| 22 | 5530 | 12 | 12.2 | 369 | Yes |
| 23 | 5531 | 15 | 17.5 | 367 | Yes |
| 24 | 5536 | 15 | 16.6 | 295 | Yes |
| 25 | 5581 | 14 | 14.6 | 300 | No |
| 26 | 5513 | 13 | 12.8 | 233 | Yes |
| 27 | 5553 | 12 | 11.4 | 238 | Yes |
| 28 | 5513 | 12 | 11.2 | 403 | Yes |
| 29 | 5548 | 16 | 19.1 | 372 | Yes |
| 30 | 5620 | 16 | 18.3 | 358 | Yes |

Detection Rate : 76.7%



802.11ax (HE160)

Type 5 Radar Statistical Performances

| Trial # | Minimum Chirp Width(MHz) | Chirp Center Frequency(MHz) | Test Signal Name | Detection |
|---------|--------------------------|-----------------------------|------------------|-----------|
| 1 | 12 | 5570 | LP_Signal_01 | No |
| 2 | 18 | 5570 | LP_Signal_02 | Yes |
| 3 | 20 | 5570 | LP_Signal_03 | Yes |
| 4 | 16 | 5570 | LP_Signal_04 | Yes |
| 5 | 19 | 5570 | LP_Signal_05 | Yes |
| 6 | 6 | 5570 | LP_Signal_06 | Yes |
| 7 | 9 | 5570 | LP_Signal_07 | Yes |
| 8 | 6 | 5570 | LP_Signal_08 | Yes |
| 9 | 8 | 5570 | LP_Signal_09 | Yes |
| 10 | 17 | 5570 | LP_Signal_10 | Yes |
| 11 | 8 | 5494 | LP_Signal_11 | Yes |
| 12 | 17 | 5498 | LP_Signal_12 | Yes |
| 13 | 16 | 5497 | LP_Signal_13 | Yes |
| 14 | 20 | 5499 | LP_Signal_14 | Yes |
| 15 | 9 | 5495 | LP_Signal_15 | Yes |
| 16 | 18 | 5498 | LP_Signal_16 | Yes |
| 17 | 12 | 5496 | LP_Signal_17 | Yes |
| 18 | 11 | 5495 | LP_Signal_18 | Yes |
| 19 | 10 | 5495 | LP_Signal_19 | Yes |
| 20 | 15 | 5497 | LP_Signal_20 | Yes |
| 21 | 20 | 5641 | LP_Signal_21 | Yes |
| 22 | 7 | 5646 | LP_Signal_22 | No |
| 23 | 16 | 5643 | LP_Signal_23 | Yes |
| 24 | 14 | 5643 | LP_Signal_24 | Yes |
| 25 | 11 | 5645 | LP_Signal_25 | Yes |
| 26 | 8 | 5646 | LP_Signal_26 | Yes |
| 27 | 5 | 5647 | LP_Signal_27 | No |
| 28 | 5 | 5647 | LP_Signal_28 | Yes |
| 29 | 19 | 5641 | LP_Signal_29 | Yes |
| 30 | 17 | 5642 | LP_Signal_30 | Yes |

Detection Rate : 90%

Note: The Long Pulse Radar pattern shown in Appendix A.1



802.11ax (HE160)

| Type 6 Radar Statistical Performances | | | | | |
|---------------------------------------|------------------|-----------------|---------|---------------------------------|-----------|
| Trial # | Pulses per Burst | Pulse Width(us) | PRI(us) | Hopping Frequency Sequence Name | Detection |
| 1 | 9 | 1 | 333.3 | HOP_FREQ_SEQ_01 | Yes |
| 2 | 9 | 1 | 333.3 | HOP_FREQ_SEQ_02 | No |
| 3 | 9 | 1 | 333.3 | HOP_FREQ_SEQ_03 | Yes |
| 4 | 9 | 1 | 333.3 | HOP_FREQ_SEQ_04 | Yes |
| 5 | 9 | 1 | 333.3 | HOP_FREQ_SEQ_05 | Yes |
| 6 | 9 | 1 | 333.3 | HOP_FREQ_SEQ_06 | No |
| 7 | 9 | 1 | 333.3 | HOP_FREQ_SEQ_07 | Yes |
| 8 | 9 | 1 | 333.3 | HOP_FREQ_SEQ_08 | Yes |
| 9 | 9 | 1 | 333.3 | HOP_FREQ_SEQ_09 | No |
| 10 | 9 | 1 | 333.3 | HOP_FREQ_SEQ_10 | Yes |
| 11 | 9 | 1 | 333.3 | HOP_FREQ_SEQ_11 | Yes |
| 12 | 9 | 1 | 333.3 | HOP_FREQ_SEQ_12 | Yes |
| 13 | 9 | 1 | 333.3 | HOP_FREQ_SEQ_13 | Yes |
| 14 | 9 | 1 | 333.3 | HOP_FREQ_SEQ_14 | Yes |
| 15 | 9 | 1 | 333.3 | HOP_FREQ_SEQ_15 | Yes |
| 16 | 9 | 1 | 333.3 | HOP_FREQ_SEQ_16 | Yes |
| 17 | 9 | 1 | 333.3 | HOP_FREQ_SEQ_17 | Yes |
| 18 | 9 | 1 | 333.3 | HOP_FREQ_SEQ_18 | Yes |
| 19 | 9 | 1 | 333.3 | HOP_FREQ_SEQ_19 | Yes |
| 20 | 9 | 1 | 333.3 | HOP_FREQ_SEQ_20 | Yes |
| 21 | 9 | 1 | 333.3 | HOP_FREQ_SEQ_21 | Yes |
| 22 | 9 | 1 | 333.3 | HOP_FREQ_SEQ_22 | Yes |
| 23 | 9 | 1 | 333.3 | HOP_FREQ_SEQ_23 | Yes |
| 24 | 9 | 1 | 333.3 | HOP_FREQ_SEQ_24 | Yes |
| 25 | 9 | 1 | 333.3 | HOP_FREQ_SEQ_25 | No |
| 26 | 9 | 1 | 333.3 | HOP_FREQ_SEQ_26 | Yes |
| 27 | 9 | 1 | 333.3 | HOP_FREQ_SEQ_27 | Yes |
| 28 | 9 | 1 | 333.3 | HOP_FREQ_SEQ_28 | Yes |
| 29 | 9 | 1 | 333.3 | HOP_FREQ_SEQ_29 | Yes |
| 30 | 9 | 1 | 333.3 | HOP_FREQ_SEQ_30 | Yes |

Detection Rate : 86.7%

Note: The Frequency Hopping Radar pattern shown in Appendix A.2

6.2.5 Non- Occupancy Period

1) Test results demonstrating an associated client link is established with the master on a test frequency.

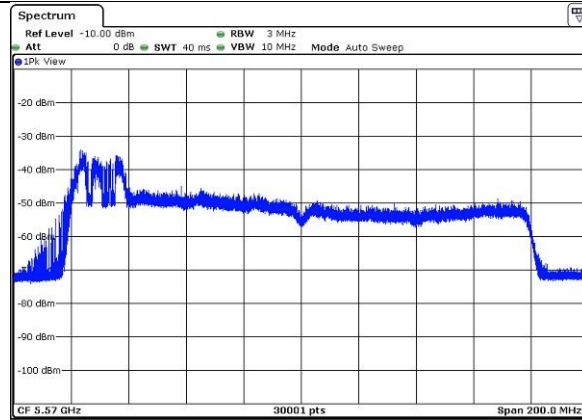

EUT (master) links with Client on 5570MHz

2) The master and DFS-certified client device are associated, and system testing will be performed with channel-loading for a non-occupancy period test.

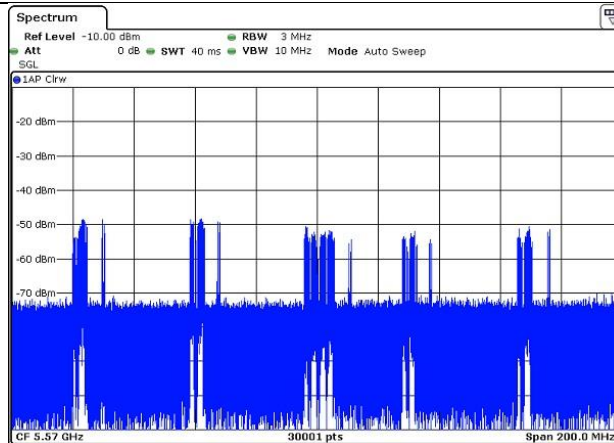

Client performed with channel-loading via master.

3). The device transmits one type of radar as specified in the DFS Order.

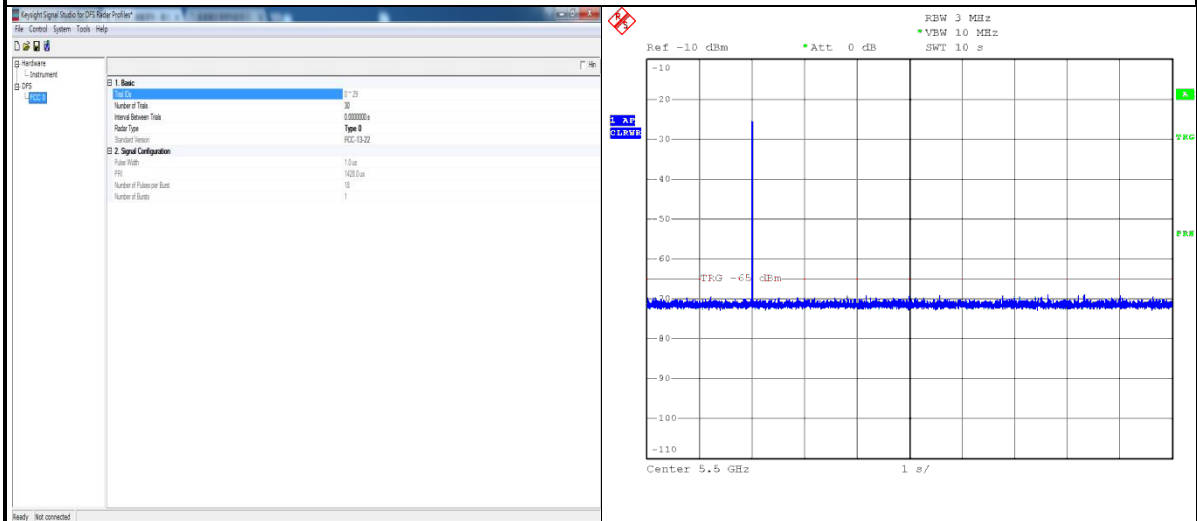

Radar 0 is used to test during DFS testing.

4) The test frequency has been monitored to ensure no transmission of any type has occurred for 30 minutes;

Note: If the client moves with the master, the device is considered compliant if nothing appears in the client non-occupancy period test. For devices that shut down (rather than moving channels), no beacons should appear;

5) An analyzer plot that contains a single 30-minute sweep on the original test frequency.

Non - Occupancy Period @ CH114 - 5570MHz

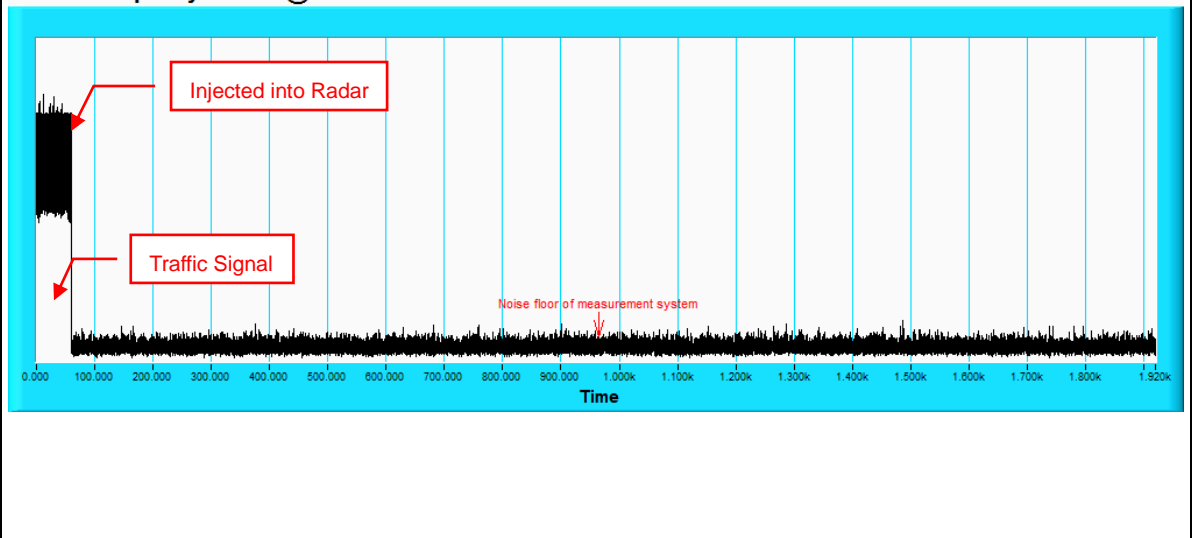

7. Information of the Testing Laboratories

We, Bureau Veritas Consumer Products Services (H.K.) Ltd., Taoyuan Branch, were founded in 1988 to provide our best service in EMC, Radio, Telecom and Safety consultation. Our laboratories are accredited and approved according to ISO/IEC 17025.

If you have any comments, please feel free to contact us at the following:

Lin Kou EMC/RF Lab:

Tel: 886-2-26052180

Fax: 886-2-26051924

Hsin Chu EMC/RF/Telecom Lab:

Tel: 886-3-6668565

Fax: 886-3-6668323

Hwa Ya EMC/RF/Safety Lab:

Tel: 886-3-3183232

Fax: 886-3-3270892

Email: service.adt@tw.bureauveritas.com

Web Site: www.bureauveritas-adt.com

The address and road map of all our labs can be found in our web site also.

8. APPENDIX-A

RADAR TEST SIGNAL

A.1 The Long Pulse Radar Pattern

Long Pulse Radar Test Signal

Test Signal Name: LP_Signal_01

Number of Bursts in Trial: 13

| Burst | Pulses per Burst | Chrip (MHz) | Pulse Width(us) | PRI-1 (us) | PRI-2 (us) | PRI-3 (us) |
|-------|------------------|-------------|-----------------|------------|------------|------------|
| 1 | 2 | 12 | 72.3 | 1755 | 1674 | - |
| 2 | 3 | 12 | 93.3 | 1628 | 1167 | 1284 |
| 3 | 3 | 12 | 98.4 | 1837 | 1798 | 1519 |
| 4 | 3 | 12 | 84.5 | 1613 | 1145 | 1805 |
| 5 | 3 | 12 | 95.2 | 1476 | 1854 | 1395 |
| 6 | 1 | 12 | 53.7 | 1358 | - | - |
| 7 | 1 | 12 | 63.2 | 1487 | - | - |
| 8 | 1 | 12 | 55.4 | 1756 | - | - |
| 9 | 1 | 12 | 61.2 | 1050 | - | - |
| 10 | 3 | 12 | 89 | 1609 | 1244 | 1978 |
| 11 | 1 | 12 | 61.4 | 1617 | - | - |
| 12 | 3 | 12 | 87.9 | 1036 | 1397 | 1221 |
| 13 | 3 | 12 | 84.5 | 1597 | 1420 | 1855 |
| 14 | - | - | - | - | - | - |
| 15 | - | - | - | - | - | - |
| 16 | - | - | - | - | - | - |
| 17 | - | - | - | - | - | - |
| 18 | - | - | - | - | - | - |
| 19 | - | - | - | - | - | - |
| 20 | - | - | - | - | - | - |

Long Pulse Radar Test Signal

Test Signal Name: LP_Signal_02

Number of Bursts in Trial: 19

| Burst | Pulses per Burst | Chrip (MHz) | Pulse Width(us) | PRI-1 (us) | PRI-2 (us) | PRI-3 (us) |
|-------|------------------|-------------|-----------------|------------|------------|------------|
| 1 | 3 | 18 | 98.8 | 2000 | 1421 | 1218 |
| 2 | 1 | 18 | 63.9 | 1982 | - | - |
| 3 | 3 | 18 | 92.9 | 1852 | 1405 | 1622 |
| 4 | 2 | 18 | 73.9 | 1102 | 1012 | - |
| 5 | 2 | 18 | 68.8 | 1924 | 1823 | - |
| 6 | 2 | 18 | 67.8 | 1692 | 1643 | - |
| 7 | 2 | 18 | 82.4 | 1510 | 1761 | - |
| 8 | 3 | 18 | 98.6 | 1461 | 1615 | 1561 |
| 9 | 1 | 18 | 56.8 | 1013 | - | - |
| 10 | 3 | 18 | 86.2 | 1290 | 1785 | 1120 |
| 11 | 2 | 18 | 80.9 | 1791 | 1542 | - |
| 12 | 2 | 18 | 70.1 | 1496 | 1591 | - |
| 13 | 1 | 18 | 60 | 1138 | - | - |
| 14 | 1 | 18 | 52.5 | 1638 | - | - |
| 15 | 1 | 18 | 51.4 | 1231 | - | - |
| 16 | 3 | 18 | 94.6 | 1948 | 1689 | 1417 |
| 17 | 3 | 18 | 90.6 | 1945 | 1774 | 1445 |
| 18 | 3 | 18 | 86.8 | 1929 | 1076 | 1626 |
| 19 | 2 | 18 | 76.5 | 1449 | 1775 | - |
| 20 | - | - | - | - | - | - |

Long Pulse Radar Test Signal

Test Signal Name: LP_Signal_03

Number of Bursts in Trial: 20

| Burst | Pulses per Burst | Chrip (MHz) | Pulse Width(us) | PRI-1 (us) | PRI-2 (us) | PRI-3 (us) |
|-------|------------------|-------------|-----------------|------------|------------|------------|
| 1 | 1 | 20 | 55.3 | 1256 | - | - |
| 2 | 2 | 20 | 73.5 | 1475 | 1085 | - |
| 3 | 1 | 20 | 60.5 | 1229 | - | - |
| 4 | 1 | 20 | 52.6 | 1919 | - | - |
| 5 | 1 | 20 | 51.8 | 1603 | - | - |
| 6 | 3 | 20 | 92.5 | 1468 | 1109 | 1577 |
| 7 | 1 | 20 | 64.8 | 1784 | - | - |
| 8 | 1 | 20 | 58.5 | 1915 | - | - |
| 9 | 2 | 20 | 75.4 | 1584 | 1130 | - |
| 10 | 1 | 20 | 61 | 1323 | - | - |
| 11 | 3 | 20 | 88.1 | 1880 | 1885 | 1678 |
| 12 | 2 | 20 | 73.8 | 1739 | 1514 | - |
| 13 | 1 | 20 | 55.1 | 1810 | - | - |
| 14 | 3 | 20 | 99 | 1737 | 1719 | 1034 |
| 15 | 1 | 20 | 50.9 | 1387 | - | - |
| 16 | 1 | 20 | 50.4 | 1275 | - | - |
| 17 | 3 | 20 | 91 | 1700 | 1738 | 1316 |
| 18 | 1 | 20 | 65.3 | 1534 | - | - |
| 19 | 3 | 20 | 95.6 | 1792 | 1937 | 1819 |
| 20 | 2 | 20 | 66.9 | 1770 | 1529 | - |

Long Pulse Radar Test Signal

Test Signal Name: LP_Signal_04

Number of Bursts in Trial: 16

| Burst | Pulses per Burst | Chrip (MHz) | Pulse Width(us) | PRI-1 (us) | PRI-2 (us) | PRI-3 (us) |
|-------|------------------|-------------|-----------------|------------|------------|------------|
| 1 | 2 | 16 | 78.4 | 1900 | 1706 | - |
| 2 | 2 | 16 | 82.9 | 1313 | 1579 | - |
| 3 | 1 | 16 | 50.8 | 1990 | - | - |
| 4 | 1 | 16 | 65.5 | 1382 | - | - |
| 5 | 1 | 16 | 57.1 | 1282 | - | - |
| 6 | 2 | 16 | 67.5 | 1314 | 1702 | - |
| 7 | 1 | 16 | 64.3 | 1286 | - | - |
| 8 | 3 | 16 | 85.1 | 1105 | 1540 | 1147 |
| 9 | 1 | 16 | 51.2 | 1815 | - | - |
| 10 | 1 | 16 | 61.7 | 1504 | - | - |
| 11 | 1 | 16 | 60.8 | 1592 | - | - |
| 12 | 2 | 16 | 70.7 | 1112 | 1894 | - |
| 13 | 1 | 16 | 52.2 | 1291 | - | - |
| 14 | 3 | 16 | 84.9 | 1441 | 1095 | 1644 |
| 15 | 2 | 16 | 82.5 | 1156 | 1732 | - |
| 16 | 1 | 16 | 61 | 1795 | - | - |
| 17 | - | - | - | - | - | - |
| 18 | - | - | - | - | - | - |
| 19 | - | - | - | - | - | - |
| 20 | - | - | - | - | - | - |

Long Pulse Radar Test Signal

Test Signal Name: LP_Signal_05

Number of Bursts in Trial: 19

| Burst | Pulses per Burst | Chrip (MHz) | Pulse Width(us) | PRI-1 (us) | PRI-2 (us) | PRI-3 (us) |
|-------|------------------|-------------|-----------------|------------|------------|------------|
| 1 | 3 | 19 | 88.2 | 1296 | 1994 | 1980 |
| 2 | 1 | 19 | 61.3 | 1018 | - | - |
| 3 | 3 | 19 | 91.1 | 1047 | 1179 | 1365 |
| 4 | 2 | 19 | 81.4 | 1160 | 1779 | - |
| 5 | 1 | 19 | 53.9 | 1428 | - | - |
| 6 | 1 | 19 | 59.3 | 1708 | - | - |
| 7 | 1 | 19 | 57 | 1587 | - | - |
| 8 | 3 | 19 | 87.6 | 1078 | 1844 | 1283 |
| 9 | 2 | 19 | 68.7 | 1453 | 1825 | - |
| 10 | 1 | 19 | 62.3 | 1927 | - | - |
| 11 | 2 | 19 | 75.7 | 1459 | 1471 | - |
| 12 | 2 | 19 | 71.2 | 1905 | 1489 | - |
| 13 | 1 | 19 | 59.1 | 1710 | - | - |
| 14 | 1 | 19 | 52.1 | 1308 | - | - |
| 15 | 1 | 19 | 60.5 | 1087 | - | - |
| 16 | 2 | 19 | 79.3 | 1828 | 1889 | - |
| 17 | 3 | 19 | 95 | 1139 | 1432 | 1588 |
| 18 | 2 | 19 | 69.9 | 1466 | 1838 | - |
| 19 | 3 | 19 | 98.1 | 1107 | 1419 | 1909 |
| 20 | | | | | | |

Long Pulse Radar Test Signal

Test Signal Name: LP_Signal_06

Number of Bursts in Trial: 8

| Burst | Pulses per Burst | Chrip (MHz) | Pulse Width(us) | PRI-1 (us) | PRI-2 (us) | PRI-3 (us) |
|-------|------------------|-------------|-----------------|------------|------------|------------|
| 1 | 2 | 6 | 72.5 | 1890 | 1292 | - |
| 2 | 2 | 6 | 72.6 | 1794 | 1408 | - |
| 3 | 3 | 6 | 95.1 | 1093 | 1310 | 1776 |
| 4 | 3 | 6 | 95.6 | 1225 | 1694 | 1778 |
| 5 | 3 | 6 | 84.4 | 1219 | 1640 | 1879 |
| 6 | 2 | 6 | 78.2 | 1448 | 1505 | - |
| 7 | 2 | 6 | 79.8 | 1930 | 1144 | - |
| 8 | 1 | 6 | 57.3 | 1021 | - | - |
| 9 | - | - | - | - | - | - |
| 10 | - | - | - | - | - | - |
| 11 | - | - | - | - | - | - |
| 12 | - | - | - | - | - | - |
| 13 | - | - | - | - | - | - |
| 14 | - | - | - | - | - | - |
| 15 | - | - | - | - | - | - |
| 16 | - | - | - | - | - | - |
| 17 | - | - | - | - | - | - |
| 18 | - | - | - | - | - | - |
| 19 | - | - | - | - | - | - |
| 20 | - | - | - | - | - | - |

Long Pulse Radar Test Signal

Test Signal Name: LP_Signal_07

Number of Bursts in Trial: 11

| Burst | Pulses per Burst | Chrip (MHz) | Pulse Width(us) | PRI-1 (us) | PRI-2 (us) | PRI-3 (us) |
|-------|------------------|-------------|-----------------|------------|------------|------------|
| 1 | 1 | 9 | 63.6 | 1490 | - | - |
| 2 | 1 | 9 | 50.1 | 1714 | - | - |
| 3 | 2 | 9 | 67.4 | 1605 | 1352 | - |
| 4 | 2 | 9 | 71.6 | 1431 | 1658 | - |
| 5 | 2 | 9 | 70.3 | 1281 | 1007 | - |
| 6 | 1 | 9 | 66.4 | 1015 | - | - |
| 7 | 3 | 9 | 90 | 1197 | 1005 | 1918 |
| 8 | 1 | 9 | 62.2 | 1153 | - | - |
| 9 | 2 | 9 | 79.6 | 1247 | 1295 | - |
| 10 | 2 | 9 | 74.3 | 1518 | 1646 | - |
| 11 | 1 | 9 | 64.1 | 1305 | - | - |
| 12 | - | - | - | - | - | - |
| 13 | - | - | - | - | - | - |
| 14 | - | - | - | - | - | - |
| 15 | - | - | - | - | - | - |
| 16 | - | - | - | - | - | - |
| 17 | - | - | - | - | - | - |
| 18 | - | - | - | - | - | - |
| 19 | - | - | - | - | - | - |
| 20 | - | - | - | - | - | - |

Long Pulse Radar Test Signal

Test Signal Name: LP_Signal_08

Number of Bursts in Trial: 9

| Burst | Pulses per Burst | Chrip (MHz) | Pulse Width(us) | PRI-1 (us) | PRI-2 (us) | PRI-3 (us) |
|-------|------------------|-------------|-----------------|------------|------------|------------|
| 1 | 1 | 6 | 63 | 1460 | - | - |
| 2 | 2 | 6 | 69.1 | 1943 | 1619 | - |
| 3 | 2 | 6 | 75.8 | 1000 | 1230 | - |
| 4 | 1 | 6 | 63.3 | 1620 | - | - |
| 5 | 3 | 6 | 96.8 | 1846 | 1213 | 1425 |
| 6 | 3 | 6 | 94.8 | 1122 | 1024 | 1920 |
| 7 | 3 | 6 | 91.8 | 1634 | 1991 | 1960 |
| 8 | 3 | 6 | 93.1 | 1424 | 1406 | 1744 |
| 9 | 2 | 6 | 76 | 1687 | 1763 | - |
| 10 | - | - | - | - | - | - |
| 11 | - | - | - | - | - | - |
| 12 | - | - | - | - | - | - |
| 13 | - | - | - | - | - | - |
| 14 | - | - | - | - | - | - |
| 15 | - | - | - | - | - | - |
| 16 | - | - | - | - | - | - |
| 17 | - | - | - | - | - | - |
| 18 | - | - | - | - | - | - |
| 19 | - | - | - | - | - | - |
| 20 | - | - | - | - | - | - |

Long Pulse Radar Test Signal

Test Signal Name: LP_Signal_09

Number of Bursts in Trial: 10

| Burst | Pulses per Burst | Chrip (MHz) | Pulse Width(us) | PRI-1 (us) | PRI-2 (us) | PRI-3 (us) |
|-------|------------------|-------------|-----------------|------------|------------|------------|
| 1 | 3 | 8 | 99.1 | 1635 | 1214 | 1201 |
| 2 | 1 | 8 | 51.2 | 1989 | - | - |
| 3 | 2 | 8 | 81.6 | 1817 | 1152 | - |
| 4 | 2 | 8 | 75.7 | 1816 | 1596 | - |
| 5 | 2 | 8 | 82.3 | 1783 | 1375 | - |
| 6 | 3 | 8 | 86.8 | 1649 | 1690 | 1434 |
| 7 | 1 | 8 | 60 | 1055 | - | - |
| 8 | 3 | 8 | 88.4 | 1136 | 1235 | 1868 |
| 9 | 3 | 8 | 93.1 | 1559 | 1813 | 1222 |
| 10 | 1 | 8 | 65.7 | 1503 | - | - |
| 11 | - | - | - | - | - | - |
| 12 | - | - | - | - | - | - |
| 13 | - | - | - | - | - | - |
| 14 | - | - | - | - | - | - |
| 15 | - | - | - | - | - | - |
| 16 | - | - | - | - | - | - |
| 17 | - | - | - | - | - | - |
| 18 | - | - | - | - | - | - |
| 19 | - | - | - | - | - | - |
| 20 | - | - | - | - | - | - |

Long Pulse Radar Test Signal

Test Signal Name: LP_Signal_10

Number of Bursts in Trial: 18

| Burst | Pulses per Burst | Chrip (MHz) | Pulse Width(us) | PRI-1 (us) | PRI-2 (us) | PRI-3 (us) |
|-------|------------------|-------------|-----------------|------------|------------|------------|
| 1 | 1 | 17 | 56.7 | 1263 | - | - |
| 2 | 1 | 17 | 53.2 | 1462 | - | - |
| 3 | 2 | 17 | 74.1 | 1180 | 1344 | - |
| 4 | 1 | 17 | 52 | 1269 | - | - |
| 5 | 3 | 17 | 93.5 | 1841 | 1931 | 1863 |
| 6 | 3 | 17 | 87.4 | 1972 | 1210 | 1610 |
| 7 | 1 | 17 | 51.3 | 1208 | - | - |
| 8 | 3 | 17 | 90.7 | 1608 | 1302 | 1759 |
| 9 | 1 | 17 | 55.4 | 1509 | - | - |
| 10 | 1 | 17 | 54.8 | 1253 | - | - |
| 11 | 2 | 17 | 69.1 | 1961 | 1499 | - |
| 12 | 3 | 17 | 89.9 | 1069 | 1717 | 1176 |
| 13 | 2 | 17 | 80.9 | 1315 | 1904 | - |
| 14 | 1 | 17 | 55 | 1553 | - | - |
| 15 | 2 | 17 | 80.8 | 1134 | 1439 | - |
| 16 | 1 | 17 | 56.9 | 1987 | - | - |
| 17 | 2 | 17 | 79 | 1106 | 1602 | - |
| 18 | 3 | 17 | 96.8 | 1874 | 1118 | 1595 |
| 19 | - | - | - | - | - | - |
| 20 | - | - | - | - | - | - |

Long Pulse Radar Test Signal

Test Signal Name: LP_Signal_11

Number of Bursts in Trial: 10

| Burst | Pulses per Burst | Chrip (MHz) | Pulse Width(us) | PRI-1 (us) | PRI-2 (us) | PRI-3 (us) |
|-------|------------------|-------------|-----------------|------------|------------|------------|
| 1 | 1 | 8 | 59.3 | 1126 | - | - |
| 2 | 3 | 8 | 98.4 | 1164 | 1660 | 1258 |
| 3 | 1 | 8 | 50.7 | 1351 | - | - |
| 4 | 3 | 8 | 92.6 | 1458 | 1173 | 1209 |
| 5 | 3 | 8 | 85.1 | 1474 | 1843 | 1374 |
| 6 | 1 | 8 | 53.8 | 1547 | - | - |
| 7 | 1 | 8 | 58.2 | 1833 | - | - |
| 8 | 1 | 8 | 62.4 | 1108 | - | - |
| 9 | 2 | 8 | 68.6 | 1869 | 1947 | - |
| 10 | 3 | 8 | 91.7 | 1321 | 1912 | 1443 |
| 11 | - | - | - | - | - | - |
| 12 | - | - | - | - | - | - |
| 13 | - | - | - | - | - | - |
| 14 | - | - | - | - | - | - |
| 15 | - | - | - | - | - | - |
| 16 | - | - | - | - | - | - |
| 17 | - | - | - | - | - | - |
| 18 | - | - | - | - | - | - |
| 19 | - | - | - | - | - | - |
| 20 | - | - | - | - | - | - |

Long Pulse Radar Test Signal

Test Signal Name: LP_Signal_12

Number of Bursts in Trial: 17

| Burst | Pulses per Burst | Chrip (MHz) | Pulse Width(us) | PRI-1 (us) | PRI-2 (us) | PRI-3 (us) |
|-------|------------------|-------------|-----------------|------------|------------|------------|
| 1 | 3 | 17 | 89.3 | 1766 | 1771 | 1623 |
| 2 | 3 | 17 | 83.5 | 1196 | 1410 | 1834 |
| 3 | 1 | 17 | 56.3 | 1913 | - | - |
| 4 | 1 | 17 | 51.6 | 1835 | - | - |
| 5 | 2 | 17 | 69.1 | 1333 | 1348 | - |
| 6 | 1 | 17 | 63.9 | 1583 | - | - |
| 7 | 2 | 17 | 67.5 | 1973 | 1142 | - |
| 8 | 1 | 17 | 60.9 | 1799 | - | - |
| 9 | 3 | 17 | 88.9 | 1178 | 1625 | 1851 |
| 10 | 2 | 17 | 67 | 1866 | 1908 | - |
| 11 | 2 | 17 | 82.4 | 1041 | 1010 | - |
| 12 | 2 | 17 | 76 | 1932 | 1512 | - |
| 13 | 3 | 17 | 95.4 | 1098 | 1278 | 1217 |
| 14 | 1 | 17 | 54 | 1494 | - | - |
| 15 | 3 | 17 | 86.4 | 1582 | 1979 | 1238 |
| 16 | 3 | 17 | 88.3 | 1551 | 1251 | 1294 |
| 17 | 1 | 17 | 56.8 | 1319 | - | - |
| 18 | - | - | - | - | - | - |
| 19 | - | - | - | - | - | - |
| 20 | - | - | - | - | - | - |

Long Pulse Radar Test Signal

Test Signal Name: LP_Signal_13

Number of Bursts in Trial: 16

| Burst | Pulses per Burst | Chrip (MHz) | Pulse Width(us) | PRI-1 (us) | PRI-2 (us) | PRI-3 (us) |
|-------|------------------|-------------|-----------------|------------|------------|------------|
| 1 | 1 | 16 | 59.1 | 1452 | - | - |
| 2 | 2 | 16 | 70.3 | 1722 | 1113 | - |
| 3 | 2 | 16 | 76.5 | 1394 | 1543 | - |
| 4 | 3 | 16 | 94.9 | 1044 | 1887 | 1983 |
| 5 | 2 | 16 | 75.4 | 1858 | 1131 | - |
| 6 | 1 | 16 | 57.8 | 1089 | - | - |
| 7 | 1 | 16 | 63.3 | 1037 | - | - |
| 8 | 2 | 16 | 79.1 | 1389 | 1165 | - |
| 9 | 3 | 16 | 94.8 | 1383 | 1882 | 1986 |
| 10 | 1 | 16 | 65 | 1600 | - | - |
| 11 | 1 | 16 | 64.1 | 1589 | - | - |
| 12 | 2 | 16 | 68.2 | 1268 | 1787 | - |
| 13 | 2 | 16 | 70.3 | 1048 | 1631 | - |
| 14 | 3 | 16 | 93.9 | 1418 | 1954 | 1353 |
| 15 | 2 | 16 | 81.1 | 1662 | 1331 | - |
| 16 | 2 | 16 | 68.7 | 1680 | 1733 | - |
| 17 | - | - | - | - | - | - |
| 18 | - | - | - | - | - | - |
| 19 | - | - | - | - | - | - |
| 20 | - | - | - | - | - | - |

Long Pulse Radar Test Signal

Test Signal Name: LP_Signal_14

Number of Bursts in Trial: 20

| Burst | Pulses per Burst | Chrip (MHz) | Pulse Width(us) | PRI-1 (us) | PRI-2 (us) | PRI-3 (us) |
|-------|------------------|-------------|-----------------|------------|------------|------------|
| 1 | 1 | 20 | 59.6 | 1570 | - | - |
| 2 | 1 | 20 | 51.4 | 1571 | - | - |
| 3 | 2 | 20 | 71.9 | 1059 | 1463 | - |
| 4 | 3 | 20 | 98.5 | 1667 | 1707 | 1558 |
| 5 | 2 | 20 | 67.5 | 1888 | 1339 | - |
| 6 | 2 | 20 | 70.7 | 1681 | 1663 | - |
| 7 | 2 | 20 | 67 | 1575 | 1936 | - |
| 8 | 3 | 20 | 87.5 | 1956 | 1995 | 1506 |
| 9 | 2 | 20 | 69.9 | 1998 | 1578 | - |
| 10 | 2 | 20 | 68 | 1606 | 1693 | - |
| 11 | 1 | 20 | 62 | 1630 | - | - |
| 12 | 1 | 20 | 64.3 | 1311 | - | - |
| 13 | 2 | 20 | 83.3 | 1731 | 1655 | - |
| 14 | 1 | 20 | 52.9 | 1958 | - | - |
| 15 | 3 | 20 | 96.7 | 1312 | 1415 | 1975 |
| 16 | 1 | 20 | 56.2 | 1790 | - | - |
| 17 | 3 | 20 | 96.8 | 1682 | 1974 | 1545 |
| 18 | 3 | 20 | 97 | 1735 | 1396 | 1427 |
| 19 | 3 | 20 | 99.1 | 1114 | 1827 | 1782 |
| 20 | 3 | 20 | 92.1 | 1023 | 1330 | 1500 |

Long Pulse Radar Test Signal

Test Signal Name: LP_Signal_15

Number of Bursts in Trial: 11

| Burst | Pulses per Burst | Chrip (MHz) | Pulse Width(us) | PRI-1 (us) | PRI-2 (us) | PRI-3 (us) |
|-------|------------------|-------------|-----------------|------------|------------|------------|
| 1 | 3 | 9 | 92.1 | 1337 | 1233 | 1636 |
| 2 | 3 | 9 | 96.9 | 1727 | 1248 | 1170 |
| 3 | 1 | 9 | 63.8 | 1081 | - | - |
| 4 | 2 | 9 | 75.7 | 1205 | 1380 | - |
| 5 | 3 | 9 | 93.1 | 1056 | 1416 | 1116 |
| 6 | 2 | 9 | 72.6 | 1299 | 1916 | - |
| 7 | 2 | 9 | 74.4 | 1740 | 1673 | - |
| 8 | 3 | 9 | 99 | 1356 | 1901 | 1450 |
| 9 | 1 | 9 | 53.4 | 1486 | - | - |
| 10 | 3 | 9 | 92.7 | 1182 | 1911 | 1992 |
| 11 | 2 | 9 | 68.5 | 1697 | 1227 | - |
| 12 | - | - | - | - | - | - |
| 13 | - | - | - | - | - | - |
| 14 | - | - | - | - | - | - |
| 15 | - | - | - | - | - | - |
| 16 | - | - | - | - | - | - |
| 17 | - | - | - | - | - | - |
| 18 | - | - | - | - | - | - |
| 19 | - | - | - | - | - | - |
| 20 | - | - | - | - | - | - |

Long Pulse Radar Test Signal

Test Signal Name: LP_Signal_16

Number of Bursts in Trial: 19

| Burst | Pulses per Burst | Chrip (MHz) | Pulse Width(us) | PRI-1 (us) | PRI-2 (us) | PRI-3 (us) |
|-------|------------------|-------------|-----------------|------------|------------|------------|
| 1 | 2 | 18 | 73.2 | 1907 | 1191 | - |
| 2 | 1 | 18 | 51.3 | 1764 | - | - |
| 3 | 1 | 18 | 57.2 | 1965 | - | - |
| 4 | 3 | 18 | 85.7 | 1647 | 1026 | 1632 |
| 5 | 1 | 18 | 52.6 | 1789 | - | - |
| 6 | 1 | 18 | 64.4 | 1586 | - | - |
| 7 | 3 | 18 | 89.8 | 1341 | 1976 | 1435 |
| 8 | 3 | 18 | 89.3 | 1572 | 1195 | 1379 |
| 9 | 3 | 18 | 88.4 | 1857 | 1309 | 1942 |
| 10 | 1 | 18 | 53.3 | 1574 | - | - |
| 11 | 3 | 18 | 89.1 | 1672 | 1875 | 1071 |
| 12 | 2 | 18 | 74.9 | 1952 | 1598 | - |
| 13 | 1 | 18 | 57.4 | 1549 | - | - |
| 14 | 3 | 18 | 95.8 | 1057 | 1151 | 1082 |
| 15 | 3 | 18 | 99 | 1115 | 1117 | 1741 |
| 16 | 3 | 18 | 95.8 | 1242 | 1127 | 1028 |
| 17 | 3 | 18 | 91.9 | 1480 | 1899 | 1250 |
| 18 | 2 | 18 | 68.3 | 1370 | 1103 | - |
| 19 | 1 | 18 | 57.9 | 1865 | - | - |
| 20 | - | - | - | - | - | - |

Long Pulse Radar Test Signal

Test Signal Name: LP_Signal_17

Number of Bursts in Trial: 14

| Burst | Pulses per Burst | Chrip (MHz) | Pulse Width(us) | PRI-1 (us) | PRI-2 (us) | PRI-3 (us) |
|-------|------------------|-------------|-----------------|------------|------------|------------|
| 1 | 2 | 12 | 71.5 | 1903 | 1440 | - |
| 2 | 2 | 12 | 73.4 | 1686 | 1538 | - |
| 3 | 3 | 12 | 94.8 | 1279 | 1481 | 1257 |
| 4 | 3 | 12 | 89 | 1873 | 1043 | 1601 |
| 5 | 2 | 12 | 76.7 | 1891 | 1677 | - |
| 6 | 1 | 12 | 62.8 | 1413 | - | - |
| 7 | 3 | 12 | 87.6 | 1226 | 1472 | 1552 |
| 8 | 3 | 12 | 96.3 | 1808 | 1277 | 1541 |
| 9 | 1 | 12 | 55.3 | 1404 | - | - |
| 10 | 3 | 12 | 95 | 1922 | 1950 | 1119 |
| 11 | 3 | 12 | 96.4 | 1092 | 1401 | 1881 |
| 12 | 2 | 12 | 68.1 | 1255 | 1223 | - |
| 13 | 3 | 12 | 84.1 | 1072 | 1086 | 1715 |
| 14 | 2 | 12 | 77.3 | 1752 | 1264 | - |
| 15 | - | - | - | - | - | - |
| 16 | - | - | - | - | - | - |
| 17 | - | - | - | - | - | - |
| 18 | - | - | - | - | - | - |
| 19 | - | - | - | - | - | - |
| 20 | - | - | - | - | - | - |

Long Pulse Radar Test Signal

Test Signal Name: LP_Signal_18

Number of Bursts in Trial: 12

| Burst | Pulses per Burst | Chrip (MHz) | Pulse Width(us) | PRI-1 (us) | PRI-2 (us) | PRI-3 (us) |
|-------|------------------|-------------|-----------------|------------|------------|------------|
| 1 | 3 | 11 | 99.6 | 1307 | 1027 | 1403 |
| 2 | 3 | 11 | 88.8 | 1839 | 1336 | 1473 |
| 3 | 1 | 11 | 63 | 1661 | - | - |
| 4 | 2 | 11 | 76 | 1793 | 1158 | - |
| 5 | 2 | 11 | 67.2 | 1171 | 1926 | - |
| 6 | 3 | 11 | 94.1 | 1762 | 1743 | 1254 |
| 7 | 3 | 11 | 91.8 | 1354 | 1058 | 1502 |
| 8 | 1 | 11 | 56.9 | 1133 | - | - |
| 9 | 1 | 11 | 57.7 | 1149 | - | - |
| 10 | 1 | 11 | 60.6 | 1189 | - | - |
| 11 | 3 | 11 | 88.7 | 1971 | 1508 | 1065 |
| 12 | 1 | 11 | 53 | 1734 | - | - |
| 13 | - | - | - | - | - | - |
| 14 | - | - | - | - | - | - |
| 15 | - | - | - | - | - | - |
| 16 | - | - | - | - | - | - |
| 17 | - | - | - | - | - | - |
| 18 | - | - | - | - | - | - |
| 19 | - | - | - | - | - | - |
| 20 | - | - | - | - | - | - |

Long Pulse Radar Test Signal

Test Signal Name: LP_Signal_19

Number of Bursts in Trial: 12

| Burst | Pulses per Burst | Chrip (MHz) | Pulse Width(us) | PRI-1 (us) | PRI-2 (us) | PRI-3 (us) |
|-------|------------------|-------------|-----------------|------------|------------|------------|
| 1 | 2 | 10 | 71.9 | 1368 | 1917 | - |
| 2 | 1 | 10 | 56.4 | 1886 | - | - |
| 3 | 2 | 10 | 79.9 | 1757 | 1566 | - |
| 4 | 3 | 10 | 94.2 | 1020 | 1243 | 1928 |
| 5 | 2 | 10 | 76.8 | 1154 | 1872 | - |
| 6 | 2 | 10 | 82.5 | 1633 | 1576 | - |
| 7 | 2 | 10 | 80.7 | 1665 | 1262 | - |
| 8 | 3 | 10 | 95.6 | 1848 | 1326 | 1132 |
| 9 | 2 | 10 | 71.2 | 1804 | 1372 | - |
| 10 | 3 | 10 | 95.2 | 1830 | 1521 | 1616 |
| 11 | 2 | 10 | 78.4 | 1546 | 1161 | - |
| 12 | 1 | 10 | 62.3 | 1068 | - | - |
| 13 | - | - | - | - | - | - |
| 14 | - | - | - | - | - | - |
| 15 | - | - | - | - | - | - |
| 16 | - | - | - | - | - | - |
| 17 | - | - | - | - | - | - |
| 18 | - | - | - | - | - | - |
| 19 | - | - | - | - | - | - |
| 20 | - | - | - | - | - | - |

Long Pulse Radar Test Signal

Test Signal Name: LP_Signal_20

Number of Bursts in Trial: 16

| Burst | Pulses per Burst | Chrip (MHz) | Pulse Width(us) | PRI-1 (us) | PRI-2 (us) | PRI-3 (us) |
|-------|------------------|-------------|-----------------|------------|------------|------------|
| 1 | 2 | 15 | 80.6 | 1777 | 1523 | - |
| 2 | 2 | 15 | 72.9 | 1198 | 1712 | - |
| 3 | 1 | 15 | 65 | 1207 | - | - |
| 4 | 2 | 15 | 68.2 | 1181 | 1174 | - |
| 5 | 3 | 15 | 84.4 | 1346 | 1329 | 1355 |
| 6 | 3 | 15 | 94.4 | 1022 | 1914 | 2000 |
| 7 | 3 | 15 | 92.1 | 1892 | 1536 | 1393 |
| 8 | 3 | 15 | 85.3 | 1483 | 1384 | 1362 |
| 9 | 1 | 15 | 55 | 1525 | - | - |
| 10 | 3 | 15 | 97.7 | 1442 | 1200 | 1046 |
| 11 | 1 | 15 | 57.8 | 1516 | - | - |
| 12 | 1 | 15 | 57 | 1864 | - | - |
| 13 | 3 | 15 | 85.9 | 1030 | 1042 | 1051 |
| 14 | 2 | 15 | 69.7 | 1691 | 1964 | - |
| 15 | 2 | 15 | 74.6 | 1246 | 1426 | - |
| 16 | 2 | 15 | 74.2 | 1614 | 1562 | - |
| 17 | - | - | - | - | - | - |
| 18 | - | - | - | - | - | - |
| 19 | - | - | - | - | - | - |
| 20 | - | - | - | - | - | - |

Long Pulse Radar Test Signal

Test Signal Name: LP_Signal_21

Number of Bursts in Trial: 20

| Burst | Pulses per Burst | Chrip (MHz) | Pulse Width(us) | PRI-1 (us) | PRI-2 (us) | PRI-3 (us) |
|-------|------------------|-------------|-----------------|------------|------------|------------|
| 1 | 1 | 20 | 66.1 | 1669 | - | - |
| 2 | 1 | 20 | 64.5 | 1414 | - | - |
| 3 | 1 | 20 | 65.6 | 1347 | - | - |
| 4 | 3 | 20 | 84.2 | 1135 | 1163 | 1934 |
| 5 | 1 | 20 | 50.2 | 1332 | - | - |
| 6 | 2 | 20 | 73.6 | 1016 | 1861 | - |
| 7 | 3 | 20 | 91 | 1511 | 1155 | 1814 |
| 8 | 2 | 20 | 81.2 | 1902 | 1391 | - |
| 9 | 1 | 20 | 66.3 | 1728 | - | - |
| 10 | 1 | 20 | 61.2 | 1696 | - | - |
| 11 | 2 | 20 | 68.2 | 1169 | 1557 | - |
| 12 | 1 | 20 | 63.9 | 1548 | - | - |
| 13 | 3 | 20 | 87.5 | 1345 | 1188 | 1011 |
| 14 | 3 | 20 | 88.5 | 1648 | 1493 | 1399 |
| 15 | 1 | 20 | 56.1 | 1679 | - | - |
| 16 | 1 | 20 | 54.3 | 1729 | - | - |
| 17 | 1 | 20 | 60.4 | 1993 | - | - |
| 18 | 1 | 20 | 50.7 | 1772 | - | - |
| 19 | 3 | 20 | 95.5 | 1957 | 1465 | 1166 |
| 20 | 3 | 20 | 94.4 | 1216 | 1862 | 1668 |

Long Pulse Radar Test Signal

Test Signal Name: LP_Signal_22

Number of Bursts in Trial: 9

| Burst | Pulses per Burst | Chrip (MHz) | Pulse Width(us) | PRI-1 (us) | PRI-2 (us) | PRI-3 (us) |
|-------|------------------|-------------|-----------------|------------|------------|------------|
| 1 | 2 | 7 | 79.1 | 1703 | 1045 | - |
| 2 | 2 | 7 | 73.6 | 1276 | 1666 | - |
| 3 | 2 | 7 | 72.6 | 1607 | 1895 | - |
| 4 | 1 | 7 | 63.4 | 1451 | - | - |
| 5 | 2 | 7 | 68.6 | 1711 | 1801 | - |
| 6 | 1 | 7 | 53.4 | 1328 | - | - |
| 7 | 3 | 7 | 98.1 | 1008 | 1539 | 1032 |
| 8 | 2 | 7 | 74.3 | 1357 | 1977 | - |
| 9 | 3 | 7 | 98.6 | 1893 | 1236 | 1411 |
| 10 | - | - | - | - | - | - |
| 11 | - | - | - | - | - | - |
| 12 | - | - | - | - | - | - |
| 13 | - | - | - | - | - | - |
| 14 | - | - | - | - | - | - |
| 15 | - | - | - | - | - | - |
| 16 | - | - | - | - | - | - |
| 17 | - | - | - | - | - | - |
| 18 | - | - | - | - | - | - |
| 19 | - | - | - | - | - | - |
| 20 | - | - | - | - | - | - |

Long Pulse Radar Test Signal

Test Signal Name: LP_Signal_23

Number of Bursts in Trial: 17

| Burst | Pulses per Burst | Chrip (MHz) | Pulse Width(us) | PRI-1 (us) | PRI-2 (us) | PRI-3 (us) |
|-------|------------------|-------------|-----------------|------------|------------|------------|
| 1 | 2 | 16 | 72.9 | 1327 | 1684 | - |
| 2 | 1 | 16 | 58.2 | 1704 | - | - |
| 3 | 1 | 16 | 57 | 1999 | - | - |
| 4 | 1 | 16 | 57.8 | 1141 | - | - |
| 5 | 1 | 16 | 56.4 | 1716 | - | - |
| 6 | 2 | 16 | 79.4 | 1388 | 1285 | - |
| 7 | 1 | 16 | 56.7 | 1507 | - | - |
| 8 | 2 | 16 | 79.5 | 1062 | 1001 | - |
| 9 | 3 | 16 | 94.3 | 1129 | 1705 | 1769 |
| 10 | 1 | 16 | 62 | 1654 | - | - |
| 11 | 1 | 16 | 57 | 1533 | - | - |
| 12 | 2 | 16 | 81.9 | 1361 | 1742 | - |
| 13 | 3 | 16 | 83.9 | 1017 | 1111 | 1373 |
| 14 | 1 | 16 | 51.9 | 1359 | - | - |
| 15 | 2 | 16 | 73.2 | 1140 | 1641 | - |
| 16 | 2 | 16 | 76.2 | 1988 | 1484 | - |
| 17 | 2 | 16 | 78.1 | 1698 | 1829 | - |
| 18 | - | - | - | - | - | - |
| 19 | - | - | - | - | - | - |
| 20 | - | - | - | - | - | - |

Long Pulse Radar Test Signal

Test Signal Name: LP_Signal_24

Number of Bursts in Trial: 16

| Burst | Pulses per Burst | Chrip (MHz) | Pulse Width(us) | PRI-1 (us) | PRI-2 (us) | PRI-3 (us) |
|-------|------------------|-------------|-----------------|------------|------------|------------|
| 1 | 3 | 14 | 97.8 | 1402 | 1676 | 1807 |
| 2 | 1 | 14 | 66.5 | 1168 | - | - |
| 3 | 3 | 14 | 91.5 | 1019 | 1985 | 1100 |
| 4 | 1 | 14 | 53.5 | 1204 | - | - |
| 5 | 3 | 14 | 96.6 | 1241 | 1765 | 1378 |
| 6 | 3 | 14 | 85.2 | 1856 | 1524 | 1501 |
| 7 | 2 | 14 | 74.3 | 1033 | 1604 | - |
| 8 | 2 | 14 | 80.3 | 1385 | 1261 | - |
| 9 | 3 | 14 | 95.2 | 1532 | 1709 | 1301 |
| 10 | 3 | 14 | 92.5 | 1871 | 1593 | 1749 |
| 11 | 3 | 14 | 91.9 | 1293 | 1412 | 1724 |
| 12 | 1 | 14 | 52.2 | 1298 | - | - |
| 13 | 1 | 14 | 65.5 | 1650 | - | - |
| 14 | 3 | 14 | 96.9 | 1867 | 1004 | 1259 |
| 15 | 2 | 14 | 75.6 | 1446 | 1966 | - |
| 16 | 1 | 14 | 66.6 | 1923 | - | - |
| 17 | - | - | - | - | - | - |
| 18 | - | - | - | - | - | - |
| 19 | - | - | - | - | - | - |
| 20 | - | - | - | - | - | - |

Long Pulse Radar Test Signal

Test Signal Name: LP_Signal_25

Number of Bursts in Trial: 13

| Burst | Pulses per Burst | Chrip (MHz) | Pulse Width(us) | PRI-1 (us) | PRI-2 (us) | PRI-3 (us) |
|-------|------------------|-------------|-----------------|------------|------------|------------|
| 1 | 2 | 11 | 82.6 | 1349 | 1573 | - |
| 2 | 3 | 11 | 93.4 | 1594 | 1563 | 1183 |
| 3 | 1 | 11 | 52.9 | 1725 | - | - |
| 4 | 1 | 11 | 61.1 | 1187 | - | - |
| 5 | 1 | 11 | 56 | 1515 | - | - |
| 6 | 2 | 11 | 81 | 1809 | 1877 | - |
| 7 | 1 | 11 | 59 | 1469 | - | - |
| 8 | 3 | 11 | 99.5 | 1831 | 1845 | 1438 |
| 9 | 2 | 11 | 74.9 | 1273 | 1535 | - |
| 10 | 1 | 11 | 66.1 | 1252 | - | - |
| 11 | 3 | 11 | 88.7 | 1157 | 1860 | 1997 |
| 12 | 3 | 11 | 88.4 | 1969 | 1407 | 1091 |
| 13 | 1 | 11 | 62.4 | 1699 | - | - |
| 14 | - | - | - | - | - | - |
| 15 | - | - | - | - | - | - |
| 16 | - | - | - | - | - | - |
| 17 | - | - | - | - | - | - |
| 18 | - | - | - | - | - | - |
| 19 | - | - | - | - | - | - |
| 20 | - | - | - | - | - | - |

Long Pulse Radar Test Signal

Test Signal Name: LP_Signal_26

Number of Bursts in Trial: 10

| Burst | Pulses per Burst | Chrip (MHz) | Pulse Width(us) | PRI-1 (us) | PRI-2 (us) | PRI-3 (us) |
|-------|------------------|-------------|-----------------|------------|------------|------------|
| 1 | 3 | 8 | 95.2 | 1002 | 1821 | 1527 |
| 2 | 2 | 8 | 71.7 | 1840 | 1035 | - |
| 3 | 3 | 8 | 99.4 | 1289 | 1177 | 1656 |
| 4 | 3 | 8 | 87.2 | 1786 | 1736 | 1925 |
| 5 | 3 | 8 | 90.5 | 1751 | 1803 | 1701 |
| 6 | 1 | 8 | 55.6 | 1067 | - | - |
| 7 | 2 | 8 | 81.5 | 1390 | 1946 | - |
| 8 | 2 | 8 | 82.8 | 1718 | 1245 | - |
| 9 | 3 | 8 | 95.1 | 1212 | 1713 | 1070 |
| 10 | 2 | 8 | 76.3 | 1317 | 1695 | - |
| 11 | - | - | - | - | - | - |
| 12 | - | - | - | - | - | - |
| 13 | - | - | - | - | - | - |
| 14 | - | - | - | - | - | - |
| 15 | - | - | - | - | - | - |
| 16 | - | - | - | - | - | - |
| 17 | - | - | - | - | - | - |
| 18 | - | - | - | - | - | - |
| 19 | - | - | - | - | - | - |
| 20 | - | - | - | - | - | - |

Long Pulse Radar Test Signal

Test Signal Name: LP_Signal_27

Number of Bursts in Trial: 8

| Burst | Pulses per Burst | Chrip (MHz) | Pulse Width(us) | PRI-1 (us) | PRI-2 (us) | PRI-3 (us) |
|-------|------------------|-------------|-----------------|------------|------------|------------|
| 1 | 2 | 5 | 73 | 1237 | 1485 | - |
| 2 | 2 | 5 | 82.7 | 1824 | 1750 | - |
| 3 | 2 | 5 | 77.5 | 1436 | 1398 | - |
| 4 | 1 | 5 | 61.3 | 1303 | - | - |
| 5 | 3 | 5 | 87 | 1618 | 1675 | 1753 |
| 6 | 1 | 5 | 64.8 | 1215 | - | - |
| 7 | 2 | 5 | 77.2 | 1146 | 1280 | - |
| 8 | 2 | 5 | 78.7 | 1567 | 1400 | - |
| 9 | - | - | - | - | - | - |
| 10 | - | - | - | - | - | - |
| 11 | - | - | - | - | - | - |
| 12 | - | - | - | - | - | - |
| 13 | - | - | - | - | - | - |
| 14 | - | - | - | - | - | - |
| 15 | - | - | - | - | - | - |
| 16 | - | - | - | - | - | - |
| 17 | - | - | - | - | - | - |
| 18 | - | - | - | - | - | - |
| 19 | - | - | - | - | - | - |
| 20 | - | - | - | - | - | - |

Long Pulse Radar Test Signal

Test Signal Name: LP_Signal_28

Number of Bursts in Trial: 8

| Burst | Pulses per Burst | Chrip (MHz) | Pulse Width(us) | PRI-1 (us) | PRI-2 (us) | PRI-3 (us) |
|-------|------------------|-------------|-----------------|------------|------------|------------|
| 1 | 1 | 5 | 65.2 | 1186 | - | - |
| 2 | 2 | 5 | 81.4 | 1193 | 1271 | - |
| 3 | 1 | 5 | 65.2 | 1556 | - | - |
| 4 | 1 | 5 | 51.2 | 1820 | - | - |
| 5 | 1 | 5 | 58.5 | 1381 | - | - |
| 6 | 2 | 5 | 70.2 | 1624 | 1564 | - |
| 7 | 1 | 5 | 65 | 1060 | - | - |
| 8 | 2 | 5 | 72.1 | 1364 | 1099 | - |
| 9 | - | - | - | - | - | - |
| 10 | - | - | - | - | - | - |
| 11 | - | - | - | - | - | - |
| 12 | - | - | - | - | - | - |
| 13 | - | - | - | - | - | - |
| 14 | - | - | - | - | - | - |
| 15 | - | - | - | - | - | - |
| 16 | - | - | - | - | - | - |
| 17 | - | - | - | - | - | - |
| 18 | - | - | - | - | - | - |
| 19 | - | - | - | - | - | - |
| 20 | - | - | - | - | - | - |

Long Pulse Radar Test Signal

Test Signal Name: LP_Signal_29

Number of Bursts in Trial: 19

| Burst | Pulses per Burst | Chrip (MHz) | Pulse Width(us) | PRI-1 (us) | PRI-2 (us) | PRI-3 (us) |
|-------|------------------|-------------|-----------------|------------|------------|------------|
| 1 | 2 | 19 | 66.8 | 1876 | 1342 | - |
| 2 | 1 | 19 | 57.4 | 1206 | - | - |
| 3 | 3 | 19 | 92.1 | 1454 | 1079 | 1482 |
| 4 | 2 | 19 | 78.6 | 1726 | 1066 | - |
| 5 | 2 | 19 | 80.4 | 1498 | 1611 | - |
| 6 | 3 | 19 | 96.6 | 1495 | 1671 | 1123 |
| 7 | 3 | 19 | 85.9 | 1800 | 1232 | 1159 |
| 8 | 2 | 19 | 67.9 | 1847 | 1128 | - |
| 9 | 3 | 19 | 100 | 1260 | 1970 | 1064 |
| 10 | 2 | 19 | 70.8 | 1639 | 1796 | - |
| 11 | 3 | 19 | 92.5 | 1080 | 1367 | 1780 |
| 12 | 1 | 19 | 65 | 1921 | - | - |
| 13 | 2 | 19 | 75 | 1324 | 1429 | - |
| 14 | 3 | 19 | 91.2 | 1334 | 1464 | 1340 |
| 15 | 3 | 19 | 94.1 | 1386 | 1747 | 1409 |
| 16 | 3 | 19 | 83.9 | 1544 | 1318 | 1530 |
| 17 | 3 | 19 | 87.6 | 1377 | 1110 | 1239 |
| 18 | 2 | 19 | 67 | 1392 | 1745 | - |
| 19 | 2 | 19 | 79.9 | 1343 | 1194 | - |
| 20 | - | - | - | - | - | - |

Long Pulse Radar Test Signal

Test Signal Name: LP_Signal_30

Number of Bursts in Trial: 18

| Burst | Pulses per Burst | Chrip (MHz) | Pulse Width(us) | PRI-1 (us) | PRI-2 (us) | PRI-3 (us) |
|-------|------------------|-------------|-----------------|------------|------------|------------|
| 1 | 2 | 17 | 78.4 | 1272 | 1101 | - |
| 2 | 2 | 17 | 78.5 | 1967 | 1366 | - |
| 3 | 2 | 17 | 69.7 | 1038 | 1083 | - |
| 4 | 2 | 17 | 72.1 | 1371 | 1422 | - |
| 5 | 3 | 17 | 84.7 | 1883 | 1063 | 1721 |
| 6 | 3 | 17 | 97.8 | 1897 | 1760 | 1651 |
| 7 | 3 | 17 | 87.5 | 1304 | 1457 | 1955 |
| 8 | 2 | 17 | 73.5 | 1685 | 1488 | - |
| 9 | 1 | 17 | 56.9 | 1996 | - | - |
| 10 | 3 | 17 | 97.2 | 1369 | 1376 | 1025 |
| 11 | 3 | 17 | 94 | 1568 | 1944 | 1806 |
| 12 | 1 | 17 | 63.1 | 1569 | - | - |
| 13 | 2 | 17 | 79.2 | 1802 | 1555 | - |
| 14 | 2 | 17 | 72.2 | 1531 | 1470 | - |
| 15 | 2 | 17 | 68.4 | 1288 | 1659 | - |
| 16 | 3 | 17 | 88.9 | 1832 | 1768 | 1287 |
| 17 | 2 | 17 | 74.1 | 1014 | 1723 | - |
| 18 | 3 | 17 | 90.8 | 1537 | 1423 | 1006 |
| 19 | - | - | - | - | - | - |
| 20 | - | - | - | - | - | - |

Hopping Frequency Sequence Name: HOP_FREQ_SEQ_01

| Frequency (MHz) | 0 | 1 | 2 | 3 | 4 |
|-----------------|------|------|------|------|------|
| 0 | 5558 | 5323 | 5719 | 5591 | 5368 |
| 5 | 5694 | 5637 | 5476 | 5532 | 5528 |
| 10 | 5456 | 5354 | 5585 | 5301 | 5530 |
| 15 | 5262 | 5450 | 5625 | 5691 | 5417 |
| 20 | 5706 | 5415 | 5294 | 5377 | 5685 |
| 25 | 5254 | 5302 | 5258 | 5677 | 5600 |
| 30 | 5384 | 5487 | 5429 | 5382 | 5652 |
| 35 | 5256 | 5263 | 5717 | 5306 | 5408 |
| 40 | 5290 | 5665 | 5548 | 5460 | 5555 |
| 45 | 5286 | 5401 | 5393 | 5592 | 5675 |
| 50 | 5464 | 5690 | 5250 | 5406 | 5577 |
| 55 | 5520 | 5601 | 5479 | 5305 | 5642 |
| 60 | 5293 | 5698 | 5404 | 5633 | 5400 |
| 65 | 5611 | 5434 | 5270 | 5431 | 5452 |
| 70 | 5682 | 5569 | 5383 | 5318 | 5661 |
| 75 | 5379 | 5338 | 5576 | 5643 | 5291 |
| 80 | 5390 | 5511 | 5629 | 5536 | 5707 |
| 85 | 5253 | 5489 | 5724 | 5627 | 5271 |
| 90 | 5607 | 5590 | 5695 | 5539 | 5411 |
| 95 | 5388 | 5606 | 5523 | 5546 | 5355 |

Hopping Frequency Sequence Name: HOP_FREQ_SEQ_02

| Frequency (MHz) | 0 | 1 | 2 | 3 | 4 |
|-----------------|------|------|------|------|------|
| 0 | 5338 | 5562 | 5655 | 5277 | 5588 |
| 5 | 5358 | 5659 | 5551 | 5695 | 5260 |
| 10 | 5387 | 5618 | 5626 | 5399 | 5253 |
| 15 | 5577 | 5261 | 5609 | 5617 | 5581 |
| 20 | 5397 | 5286 | 5350 | 5573 | 5678 |
| 25 | 5365 | 5521 | 5336 | 5300 | 5566 |
| 30 | 5557 | 5270 | 5633 | 5307 | 5568 |
| 35 | 5473 | 5448 | 5506 | 5652 | 5259 |
| 40 | 5325 | 5719 | 5648 | 5287 | 5594 |
| 45 | 5528 | 5615 | 5518 | 5511 | 5487 |
| 50 | 5582 | 5462 | 5452 | 5482 | 5415 |
| 55 | 5619 | 5362 | 5405 | 5544 | 5377 |
| 60 | 5706 | 5685 | 5546 | 5311 | 5703 |
| 65 | 5591 | 5507 | 5354 | 5530 | 5682 |
| 70 | 5705 | 5500 | 5460 | 5410 | 5704 |
| 75 | 5400 | 5572 | 5550 | 5635 | 5331 |
| 80 | 5442 | 5543 | 5401 | 5296 | 5433 |
| 85 | 5351 | 5455 | 5607 | 5441 | 5284 |
| 90 | 5449 | 5701 | 5713 | 5274 | 5407 |
| 95 | 5255 | 5505 | 5569 | 5323 | 5262 |

Hopping Frequency Sequence Name: HOP_FREQ_SEQ_03

| Frequency (MHz) | 0 | 1 | 2 | 3 | 4 |
|-----------------|------|------|------|------|------|
| 0 | 5593 | 5326 | 5591 | 5438 | 5430 |
| 5 | 5400 | 5584 | 5626 | 5383 | 5467 |
| 10 | 5318 | 5407 | 5667 | 5594 | 5572 |
| 15 | 5341 | 5704 | 5356 | 5306 | 5625 |
| 20 | 5650 | 5338 | 5375 | 5323 | 5364 |
| 25 | 5530 | 5568 | 5370 | 5342 | 5552 |
| 30 | 5514 | 5485 | 5310 | 5602 | 5707 |
| 35 | 5564 | 5659 | 5663 | 5573 | 5408 |
| 40 | 5657 | 5413 | 5284 | 5523 | 5508 |
| 45 | 5698 | 5576 | 5277 | 5361 | 5638 |
| 50 | 5503 | 5668 | 5713 | 5466 | 5365 |
| 55 | 5316 | 5595 | 5363 | 5348 | 5360 |
| 60 | 5491 | 5618 | 5529 | 5534 | 5317 |
| 65 | 5456 | 5390 | 5265 | 5372 | 5399 |
| 70 | 5589 | 5309 | 5386 | 5369 | 5692 |
| 75 | 5396 | 5531 | 5412 | 5441 | 5464 |
| 80 | 5614 | 5546 | 5314 | 5550 | 5475 |
| 85 | 5395 | 5532 | 5647 | 5391 | 5719 |
| 90 | 5699 | 5631 | 5521 | 5262 | 5336 |
| 95 | 5403 | 5451 | 5329 | 5460 | 5504 |

Hopping Frequency Sequence Name: HOP_FREQ_SEQ_04

| Frequency (MHz) | 0 | 1 | 2 | 3 | 4 |
|-----------------|------|------|------|------|------|
| 0 | 5276 | 5565 | 5527 | 5502 | 5650 |
| 5 | 5442 | 5606 | 5701 | 5546 | 5296 |
| 10 | 5627 | 5671 | 5708 | 5314 | 5593 |
| 15 | 5429 | 5259 | 5459 | 5254 | 5518 |
| 20 | 5633 | 5341 | 5376 | 5367 | 5252 |
| 25 | 5479 | 5404 | 5481 | 5441 | 5471 |
| 30 | 5603 | 5559 | 5325 | 5371 | 5655 |
| 35 | 5612 | 5337 | 5577 | 5412 | 5588 |
| 40 | 5595 | 5653 | 5281 | 5355 | 5488 |
| 45 | 5306 | 5537 | 5617 | 5639 | 5712 |
| 50 | 5339 | 5554 | 5282 | 5536 | 5410 |
| 55 | 5553 | 5270 | 5310 | 5560 | 5319 |
| 60 | 5489 | 5540 | 5533 | 5450 | 5615 |
| 65 | 5405 | 5426 | 5572 | 5264 | 5288 |
| 70 | 5575 | 5362 | 5622 | 5716 | 5539 |
| 75 | 5512 | 5664 | 5454 | 5299 | 5611 |
| 80 | 5686 | 5449 | 5689 | 5374 | 5267 |
| 85 | 5440 | 5446 | 5305 | 5370 | 5556 |
| 90 | 5250 | 5258 | 5513 | 5538 | 5317 |
| 95 | 5320 | 5301 | 5430 | 5432 | 5280 |



Hopping Frequency Sequence Name: HOP_FREQ_SEQ_05

| Frequency (MHz) | 0 | 1 | 2 | 3 | 4 |
|-----------------|------|------|------|------|------|
| 0 | 5531 | 5329 | 5463 | 5663 | 5492 |
| 5 | 5484 | 5301 | 5612 | 5503 | 5558 |
| 10 | 5557 | 5274 | 5509 | 5614 | 5517 |
| 15 | 5386 | 5465 | 5299 | 5710 | 5544 |
| 20 | 5507 | 5317 | 5456 | 5269 | 5615 |
| 25 | 5331 | 5499 | 5455 | 5341 | 5523 |
| 30 | 5330 | 5428 | 5343 | 5711 | 5620 |
| 35 | 5413 | 5271 | 5408 | 5587 | 5491 |
| 40 | 5251 | 5671 | 5436 | 5321 | 5278 |
| 45 | 5284 | 5468 | 5389 | 5595 | 5670 |
| 50 | 5429 | 5588 | 5515 | 5605 | 5371 |
| 55 | 5262 | 5257 | 5266 | 5602 | 5500 |
| 60 | 5379 | 5668 | 5521 | 5705 | 5478 |
| 65 | 5354 | 5365 | 5307 | 5534 | 5566 |
| 70 | 5640 | 5561 | 5606 | 5385 | 5716 |
| 75 | 5581 | 5685 | 5360 | 5585 | 5493 |
| 80 | 5344 | 5564 | 5260 | 5687 | 5608 |
| 85 | 5352 | 5337 | 5459 | 5308 | 5400 |
| 90 | 5553 | 5665 | 5721 | 5353 | 5298 |
| 95 | 5555 | 5372 | 5304 | 5296 | 5312 |

Hopping Frequency Sequence Name: HOP_FREQ_SEQ_06

| Frequency (MHz) | 0 | 1 | 2 | 3 | 4 |
|-----------------|------|------|------|------|------|
| 0 | 5311 | 5568 | 5399 | 5349 | 5712 |
| 5 | 5623 | 5553 | 5376 | 5300 | 5710 |
| 10 | 5392 | 5346 | 5315 | 5704 | 5635 |
| 15 | 5508 | 5513 | 5344 | 5427 | 5552 |
| 20 | 5576 | 5258 | 5448 | 5717 | 5406 |
| 25 | 5658 | 5605 | 5559 | 5375 | 5565 |
| 30 | 5316 | 5385 | 5558 | 5485 | 5343 |
| 35 | 5459 | 5301 | 5265 | 5502 | 5279 |
| 40 | 5374 | 5561 | 5275 | 5591 | 5472 |
| 45 | 5653 | 5723 | 5464 | 5691 | 5656 |
| 50 | 5460 | 5560 | 5676 | 5357 | 5556 |
| 55 | 5690 | 5673 | 5639 | 5650 | 5395 |
| 60 | 5423 | 5686 | 5579 | 5469 | 5542 |
| 65 | 5303 | 5401 | 5614 | 5329 | 5272 |
| 70 | 5547 | 5609 | 5709 | 5692 | 5540 |
| 75 | 5557 | 5480 | 5253 | 5474 | 5596 |
| 80 | 5674 | 5516 | 5627 | 5698 | 5352 |
| 85 | 5470 | 5397 | 5554 | 5273 | 5354 |
| 90 | 5388 | 5411 | 5359 | 5655 | 5600 |
| 95 | 5572 | 5669 | 5291 | 5638 | 5487 |

Hopping Frequency Sequence Name: HOP_FREQ_SEQ_07

| Frequency (MHz) | 0 | 1 | 2 | 3 | 4 |
|-----------------|------|------|------|------|------|
| 0 | 5566 | 5332 | 5335 | 5510 | 5554 |
| 5 | 5665 | 5478 | 5451 | 5463 | 5539 |
| 10 | 5323 | 5610 | 5453 | 5327 | 5656 |
| 15 | 5596 | 5640 | 5671 | 5389 | 5716 |
| 20 | 5560 | 5267 | 5296 | 5537 | 5690 |
| 25 | 5294 | 5607 | 5333 | 5663 | 5409 |
| 30 | 5704 | 5680 | 5342 | 5298 | 5637 |
| 35 | 5638 | 5691 | 5550 | 5572 | 5418 |
| 40 | 5416 | 5501 | 5362 | 5312 | 5326 |
| 45 | 5369 | 5520 | 5428 | 5555 | 5614 |
| 50 | 5301 | 5581 | 5718 | 5392 | 5707 |
| 55 | 5646 | 5383 | 5523 | 5545 | 5405 |
| 60 | 5492 | 5304 | 5368 | 5518 | 5502 |
| 65 | 5415 | 5365 | 5252 | 5437 | 5349 |
| 70 | 5696 | 5309 | 5630 | 5709 | 5558 |
| 75 | 5668 | 5499 | 5526 | 5600 | 5299 |
| 80 | 5455 | 5373 | 5687 | 5297 | 5316 |
| 85 | 5338 | 5505 | 5255 | 5360 | 5271 |
| 90 | 5616 | 5477 | 5683 | 5576 | 5263 |
| 95 | 5440 | 5686 | 5482 | 5567 | 5270 |

Hopping Frequency Sequence Name: HOP_FREQ_SEQ_08

| Frequency (MHz) | 0 | 1 | 2 | 3 | 4 |
|-----------------|------|------|------|------|------|
| 0 | 5724 | 5571 | 5271 | 5671 | 5299 |
| 5 | 5707 | 5500 | 5526 | 5626 | 5254 |
| 10 | 5399 | 5494 | 5522 | 5677 | 5684 |
| 15 | 5292 | 5337 | 5433 | 5471 | 5336 |
| 20 | 5712 | 5529 | 5663 | 5560 | 5459 |
| 25 | 5536 | 5443 | 5666 | 5416 | 5411 |
| 30 | 5361 | 5258 | 5641 | 5368 | 5668 |
| 35 | 5330 | 5340 | 5542 | 5250 | 5469 |
| 40 | 5366 | 5449 | 5311 | 5638 | 5672 |
| 45 | 5257 | 5468 | 5594 | 5568 | 5283 |
| 50 | 5260 | 5681 | 5467 | 5464 | 5498 |
| 55 | 5689 | 5484 | 5410 | 5350 | 5328 |
| 60 | 5458 | 5566 | 5676 | 5376 | 5656 |
| 65 | 5491 | 5353 | 5478 | 5616 | 5310 |
| 70 | 5644 | 5398 | 5720 | 5442 | 5436 |
| 75 | 5625 | 5322 | 5553 | 5383 | 5502 |
| 80 | 5613 | 5633 | 5629 | 5420 | 5581 |
| 85 | 5359 | 5406 | 5266 | 5371 | 5675 |
| 90 | 5721 | 5703 | 5537 | 5465 | 5627 |
| 95 | 5369 | 5694 | 5407 | 5447 | 5316 |

Hopping Frequency Sequence Name: HOP_FREQ_SEQ_09

| Frequency (MHz) | 0 | 1 | 2 | 3 | 4 |
|-----------------|------|------|------|------|------|
| 0 | 5504 | 5335 | 5682 | 5357 | 5519 |
| 5 | 5371 | 5425 | 5601 | 5692 | 5478 |
| 10 | 5563 | 5663 | 5535 | 5717 | 5698 |
| 15 | 5297 | 5322 | 5402 | 5382 | 5625 |
| 20 | 5479 | 5502 | 5653 | 5618 | 5636 |
| 25 | 5448 | 5408 | 5264 | 5493 | 5477 |
| 30 | 5313 | 5555 | 5256 | 5631 | 5656 |
| 35 | 5397 | 5257 | 5261 | 5346 | 5341 |
| 40 | 5654 | 5709 | 5363 | 5281 | 5291 |
| 45 | 5721 | 5255 | 5310 | 5258 | 5470 |
| 50 | 5269 | 5334 | 5349 | 5407 | 5314 |
| 55 | 5446 | 5418 | 5688 | 5508 | 5455 |
| 60 | 5562 | 5415 | 5355 | 5279 | 5629 |
| 65 | 5404 | 5389 | 5412 | 5488 | 5383 |
| 70 | 5550 | 5602 | 5337 | 5634 | 5620 |
| 75 | 5417 | 5367 | 5365 | 5432 | 5547 |
| 80 | 5561 | 5499 | 5430 | 5633 | 5568 |
| 85 | 5558 | 5449 | 5410 | 5498 | 5701 |
| 90 | 5431 | 5377 | 5679 | 5720 | 5592 |
| 95 | 5434 | 5606 | 5472 | 5405 | 5648 |

Hopping Frequency Sequence Name: HOP_FREQ_SEQ_10

| Frequency (MHz) | 0 | 1 | 2 | 3 | 4 |
|-----------------|------|------|------|------|------|
| 0 | 5284 | 5574 | 5618 | 5518 | 5361 |
| 5 | 5413 | 5447 | 5676 | 5380 | 5307 |
| 10 | 5494 | 5452 | 5576 | 5437 | 5719 |
| 15 | 5288 | 5449 | 5408 | 5427 | 5342 |
| 20 | 5487 | 5571 | 5691 | 5610 | 5609 |
| 25 | 5714 | 5260 | 5467 | 5597 | 5511 |
| 30 | 5444 | 5688 | 5371 | 5337 | 5476 |
| 35 | 5536 | 5348 | 5532 | 5499 | 5255 |
| 40 | 5493 | 5708 | 5601 | 5474 | 5360 |
| 45 | 5685 | 5271 | 5329 | 5363 | 5620 |
| 50 | 5346 | 5445 | 5385 | 5438 | 5705 |
| 55 | 5258 | 5634 | 5372 | 5403 | 5327 |
| 60 | 5426 | 5594 | 5580 | 5300 | 5586 |
| 65 | 5552 | 5350 | 5590 | 5351 | 5698 |
| 70 | 5653 | 5434 | 5340 | 5483 | 5596 |
| 75 | 5376 | 5388 | 5631 | 5495 | 5557 |
| 80 | 5711 | 5624 | 5496 | 5625 | 5410 |
| 85 | 5443 | 5275 | 5414 | 5364 | 5424 |
| 90 | 5480 | 5646 | 5464 | 5262 | 5647 |
| 95 | 5418 | 5261 | 5488 | 5575 | 5615 |

Hopping Frequency Sequence Name: HOP_FREQ_SEQ_11

| Frequency (MHz) | 0 | 1 | 2 | 3 | 4 |
|-----------------|------|------|------|------|------|
| 0 | 5539 | 5338 | 5554 | 5582 | 5581 |
| 5 | 5455 | 5372 | 5276 | 5543 | 5514 |
| 10 | 5425 | 5617 | 5535 | 5265 | 5376 |
| 15 | 5576 | 5511 | 5375 | 5534 | 5398 |
| 20 | 5262 | 5632 | 5699 | 5602 | 5587 |
| 25 | 5670 | 5701 | 5545 | 5494 | 5430 |
| 30 | 5645 | 5586 | 5489 | 5674 | 5675 |
| 35 | 5536 | 5328 | 5274 | 5644 | 5332 |
| 40 | 5413 | 5714 | 5357 | 5517 | 5251 |
| 45 | 5412 | 5416 | 5410 | 5600 | 5524 |
| 50 | 5436 | 5527 | 5528 | 5580 | 5347 |
| 55 | 5326 | 5593 | 5397 | 5723 | 5270 |
| 60 | 5720 | 5418 | 5378 | 5393 | 5523 |
| 65 | 5387 | 5530 | 5448 | 5615 | 5316 |
| 70 | 5671 | 5440 | 5475 | 5335 | 5683 |
| 75 | 5508 | 5299 | 5476 | 5334 | 5555 |
| 80 | 5371 | 5400 | 5687 | 5493 | 5345 |
| 85 | 5439 | 5349 | 5406 | 5370 | 5282 |
| 90 | 5415 | 5519 | 5719 | 5286 | 5486 |
| 95 | 5680 | 5346 | 5279 | 5702 | 5402 |

Hopping Frequency Sequence Name: HOP_FREQ_SEQ_12

| Frequency (MHz) | 0 | 1 | 2 | 3 | 4 |
|-----------------|------|------|------|------|------|
| 0 | 5319 | 5577 | 5490 | 5268 | 5423 |
| 5 | 5497 | 5394 | 5351 | 5706 | 5721 |
| 10 | 5259 | 5602 | 5658 | 5255 | 5286 |
| 15 | 5464 | 5703 | 5614 | 5420 | 5251 |
| 20 | 5406 | 5331 | 5573 | 5691 | 5555 |
| 25 | 5536 | 5301 | 5330 | 5579 | 5704 |
| 30 | 5263 | 5494 | 5717 | 5627 | 5599 |
| 35 | 5427 | 5655 | 5496 | 5477 | 5382 |
| 40 | 5451 | 5446 | 5495 | 5332 | 5469 |
| 45 | 5297 | 5476 | 5700 | 5487 | 5713 |
| 50 | 5524 | 5535 | 5280 | 5308 | 5343 |
| 55 | 5271 | 5377 | 5532 | 5287 | 5250 |
| 60 | 5679 | 5339 | 5472 | 5265 | 5340 |
| 65 | 5418 | 5485 | 5657 | 5443 | 5656 |
| 70 | 5294 | 5652 | 5628 | 5345 | 5457 |
| 75 | 5586 | 5665 | 5467 | 5372 | 5540 |
| 80 | 5439 | 5666 | 5369 | 5562 | 5722 |
| 85 | 5292 | 5442 | 5492 | 5617 | 5606 |
| 90 | 5585 | 5393 | 5282 | 5483 | 5629 |
| 95 | 5349 | 5306 | 5633 | 5690 | 5334 |

Hopping Frequency Sequence Name: HOP_FREQ_SEQ_13

| Frequency (MHz) | 0 | 1 | 2 | 3 | 4 |
|-----------------|------|------|------|------|------|
| 0 | 5477 | 5341 | 5426 | 5429 | 5643 |
| 5 | 5636 | 5319 | 5297 | 5453 | 5665 |
| 10 | 5391 | 5699 | 5450 | 5307 | 5552 |
| 15 | 5355 | 5717 | 5465 | 5443 | 5414 |
| 20 | 5497 | 5514 | 5305 | 5528 | 5281 |
| 25 | 5388 | 5504 | 5434 | 5613 | 5578 |
| 30 | 5683 | 5559 | 5444 | 5415 | 5692 |
| 35 | 5381 | 5718 | 5492 | 5580 | 5569 |
| 40 | 5582 | 5579 | 5318 | 5622 | 5448 |
| 45 | 5375 | 5686 | 5293 | 5522 | 5562 |
| 50 | 5352 | 5401 | 5538 | 5327 | 5371 |
| 55 | 5626 | 5709 | 5498 | 5637 | 5506 |
| 60 | 5697 | 5707 | 5557 | 5602 | 5285 |
| 65 | 5340 | 5421 | 5362 | 5572 | 5610 |
| 70 | 5696 | 5543 | 5408 | 5427 | 5253 |
| 75 | 5524 | 5273 | 5488 | 5438 | 5363 |
| 80 | 5678 | 5631 | 5435 | 5390 | 5260 |
| 85 | 5342 | 5508 | 5279 | 5590 | 5420 |
| 90 | 5262 | 5616 | 5651 | 5694 | 5410 |
| 95 | 5337 | 5467 | 5527 | 5328 | 5409 |

Hopping Frequency Sequence Name: HOP_FREQ_SEQ_14

| Frequency (MHz) | 0 | 1 | 2 | 3 | 4 |
|-----------------|------|------|------|------|------|
| 0 | 5257 | 5580 | 5362 | 5590 | 5485 |
| 5 | 5678 | 5341 | 5501 | 5460 | 5282 |
| 10 | 5499 | 5655 | 5265 | 5645 | 5328 |
| 15 | 5543 | 5385 | 5345 | 5510 | 5325 |
| 20 | 5566 | 5552 | 5297 | 5644 | 5337 |
| 25 | 5707 | 5635 | 5647 | 5717 | 5669 |
| 30 | 5516 | 5659 | 5664 | 5512 | 5520 |
| 35 | 5334 | 5288 | 5355 | 5483 | 5421 |
| 40 | 5662 | 5256 | 5387 | 5445 | 5682 |
| 45 | 5569 | 5661 | 5351 | 5478 | 5449 |
| 50 | 5606 | 5577 | 5589 | 5416 | 5375 |
| 55 | 5315 | 5339 | 5663 | 5688 | 5456 |
| 60 | 5652 | 5486 | 5428 | 5706 | 5638 |
| 65 | 5370 | 5398 | 5307 | 5502 | 5251 |
| 70 | 5546 | 5403 | 5687 | 5493 | 5296 |
| 75 | 5534 | 5419 | 5615 | 5313 | 5320 |
| 80 | 5498 | 5720 | 5447 | 5392 | 5374 |
| 85 | 5555 | 5691 | 5306 | 5601 | 5588 |
| 90 | 5427 | 5451 | 5425 | 5685 | 5651 |
| 95 | 5308 | 5283 | 5701 | 5410 | 5404 |

Hopping Frequency Sequence Name: HOP_FREQ_SEQ_15

| Frequency (MHz) | 0 | 1 | 2 | 3 | 4 |
|-----------------|------|------|------|------|------|
| 0 | 5512 | 5441 | 5298 | 5276 | 5705 |
| 5 | 5720 | 5363 | 5576 | 5623 | 5489 |
| 10 | 5430 | 5444 | 5403 | 5365 | 5349 |
| 15 | 5631 | 5351 | 5458 | 5449 | 5333 |
| 20 | 5257 | 5493 | 5386 | 5474 | 5435 |
| 25 | 5664 | 5264 | 5681 | 5284 | 5558 |
| 30 | 5473 | 5399 | 5341 | 5710 | 5562 |
| 35 | 5425 | 5559 | 5508 | 5494 | 5260 |
| 40 | 5367 | 5669 | 5627 | 5442 | 5611 |
| 45 | 5549 | 5269 | 5409 | 5531 | 5714 |
| 50 | 5482 | 5278 | 5640 | 5505 | 5673 |
| 55 | 5637 | 5527 | 5617 | 5306 | 5653 |
| 60 | 5659 | 5289 | 5552 | 5694 | 5318 |
| 65 | 5274 | 5364 | 5319 | 5337 | 5614 |
| 70 | 5297 | 5302 | 5323 | 5712 | 5581 |
| 75 | 5379 | 5646 | 5416 | 5677 | 5400 |
| 80 | 5392 | 5326 | 5445 | 5484 | 5658 |
| 85 | 5384 | 5272 | 5452 | 5566 | 5423 |
| 90 | 5464 | 5280 | 5471 | 5607 | 5622 |
| 95 | 5630 | 5340 | 5447 | 5532 | 5615 |

Hopping Frequency Sequence Name: HOP_FREQ_SEQ_16

| Frequency (MHz) | 0 | 1 | 2 | 3 | 4 |
|-----------------|------|------|------|------|------|
| 0 | 5292 | 5680 | 5709 | 5437 | 5547 |
| 5 | 5287 | 5288 | 5651 | 5311 | 5696 |
| 10 | 5361 | 5330 | 5444 | 5463 | 5370 |
| 15 | 5719 | 5639 | 5454 | 5503 | 5641 |
| 20 | 5341 | 5423 | 5434 | 5378 | 5447 |
| 25 | 5323 | 5516 | 5638 | 5368 | 5715 |
| 30 | 5326 | 5430 | 5517 | 5590 | 5530 |
| 35 | 5701 | 5452 | 5661 | 5408 | 5671 |
| 40 | 5450 | 5607 | 5295 | 5439 | 5443 |
| 45 | 5529 | 5352 | 5584 | 5601 | 5358 |
| 50 | 5691 | 5496 | 5581 | 5571 | 5472 |
| 55 | 5533 | 5321 | 5717 | 5625 | 5652 |
| 60 | 5695 | 5662 | 5268 | 5373 | 5349 |
| 65 | 5567 | 5483 | 5395 | 5698 | 5649 |
| 70 | 5258 | 5605 | 5334 | 5536 | 5723 |
| 75 | 5381 | 5436 | 5551 | 5721 | 5467 |
| 80 | 5623 | 5606 | 5415 | 5388 | 5379 |
| 85 | 5712 | 5478 | 5636 | 5613 | 5656 |
| 90 | 5512 | 5449 | 5558 | 5502 | 5546 |
| 95 | 5718 | 5572 | 5498 | 5707 | 5509 |

Hopping Frequency Sequence Name: HOP_FREQ_SEQ_17

| Frequency (MHz) | 0 | 1 | 2 | 3 | 4 |
|-----------------|------|------|------|------|------|
| 0 | 5450 | 5444 | 5645 | 5598 | 5292 |
| 5 | 5426 | 5310 | 5251 | 5377 | 5525 |
| 10 | 5670 | 5594 | 5485 | 5658 | 5391 |
| 15 | 5332 | 5291 | 5557 | 5548 | 5358 |
| 20 | 5252 | 5492 | 5472 | 5467 | 5420 |
| 25 | 5589 | 5465 | 5269 | 5274 | 5433 |
| 30 | 5387 | 5257 | 5267 | 5350 | 5365 |
| 35 | 5704 | 5723 | 5339 | 5322 | 5510 |
| 40 | 5533 | 5545 | 5535 | 5372 | 5509 |
| 45 | 5435 | 5428 | 5637 | 5709 | 5630 |
| 50 | 5305 | 5697 | 5686 | 5504 | 5407 |
| 55 | 5584 | 5457 | 5478 | 5641 | 5388 |
| 60 | 5692 | 5409 | 5656 | 5459 | 5286 |
| 65 | 5564 | 5684 | 5652 | 5657 | 5681 |
| 70 | 5362 | 5324 | 5546 | 5482 | 5715 |
| 75 | 5309 | 5378 | 5662 | 5526 | 5475 |
| 80 | 5256 | 5430 | 5676 | 5326 | 5619 |
| 85 | 5593 | 5297 | 5461 | 5575 | 5500 |
| 90 | 5691 | 5346 | 5392 | 5496 | 5255 |
| 95 | 5360 | 5460 | 5338 | 5333 | 5385 |

Hopping Frequency Sequence Name: HOP_FREQ_SEQ_18

| Frequency (MHz) | 0 | 1 | 2 | 3 | 4 |
|-----------------|------|------|------|------|------|
| 0 | 5705 | 5683 | 5581 | 5284 | 5609 |
| 5 | 5468 | 5710 | 5326 | 5540 | 5257 |
| 10 | 5601 | 5383 | 5526 | 5378 | 5412 |
| 15 | 5323 | 5418 | 5660 | 5593 | 5550 |
| 20 | 5260 | 5658 | 5413 | 5459 | 5393 |
| 25 | 5477 | 5317 | 5472 | 5673 | 5308 |
| 30 | 5507 | 5322 | 5344 | 5516 | 5548 |
| 35 | 5504 | 5320 | 5519 | 5589 | 5711 |
| 40 | 5349 | 5616 | 5483 | 5300 | 5530 |
| 45 | 5301 | 5489 | 5518 | 5486 | 5690 |
| 50 | 5278 | 5488 | 5331 | 5318 | 5394 |
| 55 | 5520 | 5372 | 5382 | 5401 | 5475 |
| 60 | 5579 | 5572 | 5529 | 5289 | 5684 |
| 65 | 5686 | 5641 | 5348 | 5391 | 5254 |
| 70 | 5564 | 5636 | 5292 | 5277 | 5506 |
| 75 | 5685 | 5523 | 5650 | 5437 | 5343 |
| 80 | 5576 | 5559 | 5263 | 5404 | 5387 |
| 85 | 5438 | 5570 | 5696 | 5384 | 5258 |
| 90 | 5496 | 5491 | 5625 | 5627 | 5654 |
| 95 | 5592 | 5612 | 5449 | 5590 | 5591 |

Hopping Frequency Sequence Name: HOP_FREQ_SEQ_19

| Frequency (MHz) | 0 | 1 | 2 | 3 | 4 |
|-----------------|------|------|------|------|------|
| 0 | 5485 | 5447 | 5517 | 5348 | 5354 |
| 5 | 5510 | 5257 | 5401 | 5703 | 5464 |
| 10 | 5532 | 5647 | 5567 | 5573 | 5433 |
| 15 | 5411 | 5448 | 5288 | 5541 | 5267 |
| 20 | 5268 | 5252 | 5548 | 5366 | 5365 |
| 25 | 5266 | 5675 | 5302 | 5342 | 5549 |
| 30 | 5308 | 5301 | 5687 | 5668 | 5368 |
| 35 | 5546 | 5315 | 5722 | 5663 | 5321 |
| 40 | 5421 | 5443 | 5527 | 5608 | 5469 |
| 45 | 5601 | 5543 | 5364 | 5507 | 5369 |
| 50 | 5483 | 5343 | 5694 | 5707 | 5336 |
| 55 | 5591 | 5307 | 5446 | 5708 | 5262 |
| 60 | 5571 | 5693 | 5702 | 5630 | 5412 |
| 65 | 5590 | 5384 | 5698 | 5621 | 5367 |
| 70 | 5330 | 5278 | 5280 | 5355 | 5661 |
| 75 | 5482 | 5619 | 5324 | 5580 | 5353 |
| 80 | 5669 | 5519 | 5568 | 5275 | 5674 |
| 85 | 5429 | 5326 | 5498 | 5665 | 5564 |
| 90 | 5338 | 5506 | 5656 | 5253 | 5536 |
| 95 | 5679 | 5609 | 5667 | 5565 | 5487 |

Hopping Frequency Sequence Name: HOP_FREQ_SEQ_20

| Frequency (MHz) | 0 | 1 | 2 | 3 | 4 |
|-----------------|------|------|------|------|------|
| 0 | 5265 | 5686 | 5453 | 5509 | 5671 |
| 5 | 5552 | 5657 | 5476 | 5391 | 5293 |
| 10 | 5366 | 5436 | 5608 | 5454 | 5499 |
| 15 | 5575 | 5294 | 5586 | 5459 | 5654 |
| 20 | 5418 | 5392 | 5637 | 5339 | 5631 |
| 25 | 5593 | 5403 | 5406 | 5376 | 5688 |
| 30 | 5672 | 5258 | 5330 | 5442 | 5566 |
| 35 | 5685 | 5502 | 5683 | 5420 | 5636 |
| 40 | 5404 | 5359 | 5524 | 5537 | 5449 |
| 45 | 5684 | 5505 | 5321 | 5430 | 5715 |
| 50 | 5669 | 5641 | 5638 | 5290 | 5306 |
| 55 | 5601 | 5320 | 5362 | 5427 | 5516 |
| 60 | 5525 | 5528 | 5576 | 5710 | 5539 |
| 65 | 5323 | 5433 | 5416 | 5645 | 5402 |
| 70 | 5264 | 5380 | 5679 | 5441 | 5491 |
| 75 | 5444 | 5723 | 5605 | 5304 | 5300 |
| 80 | 5635 | 5595 | 5272 | 5394 | 5332 |
| 85 | 5643 | 5461 | 5382 | 5529 | 5389 |
| 90 | 5514 | 5346 | 5259 | 5598 | 5691 |
| 95 | 5722 | 5549 | 5385 | 5365 | 5655 |

Hopping Frequency Sequence Name: HOP_FREQ_SEQ_21

| Frequency (MHz) | 0 | 1 | 2 | 3 | 4 |
|-----------------|------|------|------|------|------|
| 0 | 5520 | 5450 | 5389 | 5670 | 5416 |
| 5 | 5691 | 5679 | 5551 | 5554 | 5500 |
| 10 | 5297 | 5322 | 5649 | 5391 | 5475 |
| 15 | 5587 | 5702 | 5397 | 5631 | 5651 |
| 20 | 5662 | 5487 | 5333 | 5629 | 5312 |
| 25 | 5519 | 5445 | 5606 | 5510 | 5410 |
| 30 | 5255 | 5561 | 5690 | 5545 | 5594 |
| 35 | 5386 | 5349 | 5593 | 5479 | 5550 |
| 40 | 5438 | 5675 | 5448 | 5521 | 5369 |
| 45 | 5332 | 5292 | 5563 | 5277 | 5695 |
| 50 | 5591 | 5384 | 5471 | 5283 | 5367 |
| 55 | 5485 | 5608 | 5719 | 5496 | 5420 |
| 60 | 5291 | 5394 | 5592 | 5461 | 5357 |
| 65 | 5451 | 5619 | 5436 | 5488 | 5359 |
| 70 | 5265 | 5686 | 5351 | 5571 | 5250 |
| 75 | 5383 | 5528 | 5613 | 5400 | 5460 |
| 80 | 5564 | 5294 | 5285 | 5317 | 5556 |
| 85 | 5324 | 5658 | 5269 | 5589 | 5477 |
| 90 | 5343 | 5430 | 5712 | 5511 | 5535 |
| 95 | 5678 | 5325 | 5302 | 5630 | 5722 |

Hopping Frequency Sequence Name: HOP_FREQ_SEQ_22

| Frequency (MHz) | 0 | 1 | 2 | 3 | 4 |
|-----------------|------|------|------|------|------|
| 0 | 5678 | 5689 | 5325 | 5356 | 5258 |
| 5 | 5604 | 5626 | 5620 | 5707 | 5703 |
| 10 | 5586 | 5690 | 5496 | 5578 | 5354 |
| 15 | 5500 | 5579 | 5465 | 5670 | 5653 |
| 20 | 5274 | 5718 | 5382 | 5310 | 5394 |
| 25 | 5712 | 5711 | 5444 | 5297 | 5547 |
| 30 | 5647 | 5285 | 5368 | 5584 | 5488 |
| 35 | 5306 | 5275 | 5348 | 5561 | 5277 |
| 40 | 5667 | 5613 | 5688 | 5615 | 5298 |
| 45 | 5312 | 5375 | 5524 | 5330 | 5582 |
| 50 | 5370 | 5560 | 5522 | 5372 | 5665 |
| 55 | 5429 | 5321 | 5673 | 5686 | 5617 |
| 60 | 5262 | 5523 | 5282 | 5406 | 5664 |
| 65 | 5565 | 5637 | 5437 | 5395 | 5475 |
| 70 | 5629 | 5643 | 5333 | 5483 | 5280 |
| 75 | 5492 | 5359 | 5332 | 5684 | 5364 |
| 80 | 5537 | 5427 | 5337 | 5721 | 5266 |
| 85 | 5309 | 5710 | 5424 | 5484 | 5669 |
| 90 | 5362 | 5532 | 5676 | 5271 | 5569 |
| 95 | 5463 | 5357 | 5614 | 5656 | 5701 |

Hopping Frequency Sequence Name: HOP_FREQ_SEQ_23

| Frequency (MHz) | 0 | 1 | 2 | 3 | 4 |
|-----------------|------|------|------|------|------|
| 0 | 5458 | 5453 | 5261 | 5517 | 5478 |
| 5 | 5300 | 5626 | 5701 | 5308 | 5536 |
| 10 | 5537 | 5375 | 5353 | 5306 | 5666 |
| 15 | 5481 | 5603 | 5624 | 5657 | 5581 |
| 20 | 5722 | 5312 | 5710 | 5355 | 5673 |
| 25 | 5721 | 5440 | 5340 | 5436 | 5604 |
| 30 | 5500 | 5520 | 5404 | 5530 | 5397 |
| 35 | 5643 | 5501 | 5475 | 5591 | 5275 |
| 40 | 5551 | 5356 | 5612 | 5702 | 5292 |
| 45 | 5582 | 5383 | 5372 | 5573 | 5461 |
| 50 | 5488 | 5276 | 5509 | 5627 | 5304 |
| 55 | 5708 | 5652 | 5447 | 5448 | 5593 |
| 60 | 5675 | 5511 | 5460 | 5483 | 5334 |
| 65 | 5307 | 5373 | 5432 | 5337 | 5319 |
| 70 | 5486 | 5468 | 5318 | 5301 | 5707 |
| 75 | 5345 | 5314 | 5406 | 5641 | 5504 |
| 80 | 5613 | 5266 | 5544 | 5386 | 5705 |
| 85 | 5348 | 5451 | 5255 | 5366 | 5374 |
| 90 | 5506 | 5446 | 5299 | 5412 | 5598 |
| 95 | 5554 | 5583 | 5489 | 5349 | 5494 |

Hopping Frequency Sequence Name: HOP_FREQ_SEQ_24

| Frequency (MHz) | 0 | 1 | 2 | 3 | 4 |
|-----------------|------|------|------|------|------|
| 0 | 5713 | 5692 | 5672 | 5678 | 5320 |
| 5 | 5342 | 5551 | 5301 | 5471 | 5268 |
| 10 | 5468 | 5639 | 5394 | 5501 | 5538 |
| 15 | 5279 | 5511 | 5706 | 5669 | 5374 |
| 20 | 5589 | 5413 | 5253 | 5324 | 5328 |
| 25 | 5464 | 5670 | 5643 | 5444 | 5415 |
| 30 | 5478 | 5325 | 5561 | 5618 | 5294 |
| 35 | 5602 | 5488 | 5439 | 5276 | 5389 |
| 40 | 5430 | 5358 | 5489 | 5596 | 5609 |
| 45 | 5534 | 5272 | 5541 | 5640 | 5436 |
| 50 | 5259 | 5597 | 5437 | 5624 | 5550 |
| 55 | 5311 | 5695 | 5697 | 5581 | 5494 |
| 60 | 5255 | 5582 | 5306 | 5612 | 5393 |
| 65 | 5425 | 5457 | 5661 | 5432 | 5370 |
| 70 | 5517 | 5265 | 5710 | 5409 | 5305 |
| 75 | 5453 | 5277 | 5648 | 5352 | 5626 |
| 80 | 5326 | 5566 | 5719 | 5469 | 5638 |
| 85 | 5321 | 5613 | 5583 | 5507 | 5481 |
| 90 | 5573 | 5399 | 5699 | 5531 | 5380 |
| 95 | 5540 | 5605 | 5555 | 5316 | 5467 |

Hopping Frequency Sequence Name: HOP_FREQ_SEQ_25

| Frequency (MHz) | 0 | 1 | 2 | 3 | 4 |
|-----------------|------|------|------|------|------|
| 0 | 5493 | 5456 | 5608 | 5364 | 5540 |
| 5 | 5481 | 5573 | 5376 | 5634 | 5475 |
| 10 | 5302 | 5428 | 5435 | 5696 | 5559 |
| 15 | 5367 | 5638 | 5712 | 5714 | 5566 |
| 20 | 5597 | 5482 | 5669 | 5316 | 5301 |
| 25 | 5352 | 5522 | 5371 | 5548 | 5449 |
| 30 | 5520 | 5311 | 5518 | 5358 | 5446 |
| 35 | 5422 | 5333 | 5579 | 5710 | 5429 |
| 40 | 5400 | 5366 | 5441 | 5427 | 5361 |
| 45 | 5606 | 5463 | 5252 | 5624 | 5601 |
| 50 | 5489 | 5524 | 5473 | 5613 | 5675 |
| 55 | 5261 | 5512 | 5542 | 5410 | 5535 |
| 60 | 5684 | 5452 | 5553 | 5338 | 5257 |
| 65 | 5327 | 5500 | 5484 | 5381 | 5406 |
| 70 | 5349 | 5513 | 5578 | 5388 | 5589 |
| 75 | 5420 | 5711 | 5617 | 5472 | 5672 |
| 80 | 5307 | 5343 | 5660 | 5630 | 5408 |
| 85 | 5532 | 5635 | 5516 | 5470 | 5673 |
| 90 | 5538 | 5353 | 5273 | 5386 | 5574 |
| 95 | 5487 | 5567 | 5430 | 5663 | 5447 |

Hopping Frequency Sequence Name: HOP_FREQ_SEQ_26

| Frequency (MHz) | 0 | 1 | 2 | 3 | 4 |
|-----------------|------|------|------|------|------|
| 0 | 5651 | 5695 | 5544 | 5428 | 5382 |
| 5 | 5523 | 5498 | 5451 | 5700 | 5304 |
| 10 | 5708 | 5314 | 5476 | 5319 | 5580 |
| 15 | 5455 | 5290 | 5340 | 5662 | 5283 |
| 20 | 5508 | 5648 | 5707 | 5405 | 5274 |
| 25 | 5715 | 5471 | 5574 | 5483 | 5562 |
| 30 | 5675 | 5475 | 5573 | 5717 | 5375 |
| 35 | 5670 | 5506 | 5582 | 5680 | 5621 |
| 40 | 5365 | 5601 | 5603 | 5295 | 5659 |
| 45 | 5542 | 5252 | 5251 | 5350 | 5335 |
| 50 | 5486 | 5501 | 5489 | 5399 | 5271 |
| 55 | 5524 | 5467 | 5564 | 5250 | 5446 |
| 60 | 5685 | 5330 | 5345 | 5559 | 5694 |
| 65 | 5650 | 5374 | 5592 | 5529 | 5396 |
| 70 | 5288 | 5673 | 5411 | 5572 | 5692 |
| 75 | 5632 | 5711 | 5419 | 5364 | 5530 |
| 80 | 5293 | 5406 | 5404 | 5720 | 5568 |
| 85 | 5386 | 5392 | 5511 | 5369 | 5676 |
| 90 | 5447 | 5577 | 5647 | 5423 | 5323 |
| 95 | 5468 | 5682 | 5452 | 5641 | 5635 |

Hopping Frequency Sequence Name: HOP_FREQ_SEQ_27

| Frequency (MHz) | 0 | 1 | 2 | 3 | 4 |
|-----------------|------|------|------|------|------|
| 0 | 5431 | 5459 | 5480 | 5589 | 5602 |
| 5 | 5565 | 5520 | 5526 | 5388 | 5511 |
| 10 | 5639 | 5578 | 5517 | 5514 | 5601 |
| 15 | 5446 | 5417 | 5443 | 5707 | 5475 |
| 20 | 5516 | 5339 | 5648 | 5397 | 5722 |
| 25 | 5506 | 5323 | 5680 | 5378 | 5701 |
| 30 | 5564 | 5432 | 5313 | 5469 | 5440 |
| 35 | 5286 | 5399 | 5357 | 5703 | 5519 |
| 40 | 5704 | 5303 | 5269 | 5697 | 5699 |
| 45 | 5590 | 5315 | 5717 | 5498 | 5676 |
| 50 | 5603 | 5490 | 5302 | 5439 | 5633 |
| 55 | 5333 | 5689 | 5495 | 5596 | 5632 |
| 60 | 5325 | 5396 | 5551 | 5392 | 5508 |
| 65 | 5279 | 5381 | 5391 | 5497 | 5360 |
| 70 | 5692 | 5372 | 5629 | 5458 | 5712 |
| 75 | 5386 | 5275 | 5308 | 5667 | 5261 |
| 80 | 5280 | 5419 | 5493 | 5485 | 5371 |
| 85 | 5358 | 5291 | 5398 | 5545 | 5310 |
| 90 | 5464 | 5253 | 5718 | 5305 | 5426 |
| 95 | 5288 | 5664 | 5636 | 5675 | 5359 |

Hopping Frequency Sequence Name: HOP_FREQ_SEQ_28

| Frequency (MHz) | 0 | 1 | 2 | 3 | 4 |
|-----------------|------|------|------|------|------|
| 0 | 5686 | 5698 | 5416 | 5275 | 5444 |
| 5 | 5607 | 5445 | 5601 | 5551 | 5718 |
| 10 | 5473 | 5367 | 5558 | 5709 | 5622 |
| 15 | 5534 | 5544 | 5546 | 5277 | 5667 |
| 20 | 5524 | 5408 | 5589 | 5486 | 5695 |
| 25 | 5394 | 5650 | 5482 | 5268 | 5550 |
| 30 | 5389 | 5431 | 5621 | 5260 | 5653 |
| 35 | 5474 | 5670 | 5510 | 5714 | 5358 |
| 40 | 5312 | 5619 | 5509 | 5694 | 5628 |
| 45 | 5570 | 5398 | 5300 | 5466 | 5479 |
| 50 | 5666 | 5353 | 5528 | 5456 | 5402 |
| 55 | 5397 | 5304 | 5384 | 5369 | 5250 |
| 60 | 5322 | 5270 | 5325 | 5377 | 5435 |
| 65 | 5703 | 5320 | 5492 | 5346 | 5702 |
| 70 | 5251 | 5588 | 5427 | 5529 | 5347 |
| 75 | 5527 | 5418 | 5448 | 5328 | 5343 |
| 80 | 5723 | 5620 | 5553 | 5677 | 5409 |
| 85 | 5644 | 5586 | 5716 | 5501 | 5511 |
| 90 | 5481 | 5687 | 5712 | 5616 | 5284 |
| 95 | 5401 | 5631 | 5699 | 5374 | 5662 |

Hopping Frequency Sequence Name: HOP_FREQ_SEQ_29

| Frequency (MHz) | 0 | 1 | 2 | 3 | 4 |
|-----------------|------|------|------|------|------|
| 0 | 5466 | 5462 | 5352 | 5436 | 5664 |
| 5 | 5271 | 5467 | 5676 | 5714 | 5450 |
| 10 | 5404 | 5631 | 5599 | 5429 | 5643 |
| 15 | 5622 | 5574 | 5649 | 5322 | 5384 |
| 20 | 5435 | 5530 | 5478 | 5668 | 5660 |
| 25 | 5611 | 5586 | 5585 | 5310 | 5439 |
| 30 | 5346 | 5646 | 5395 | 5458 | 5317 |
| 35 | 5565 | 5663 | 5628 | 5672 | 5492 |
| 40 | 5557 | 5274 | 5691 | 5460 | 5550 |
| 45 | 5481 | 5261 | 5604 | 5353 | 5258 |
| 50 | 5367 | 5279 | 5590 | 5254 | 5494 |
| 55 | 5581 | 5340 | 5379 | 5487 | 5690 |
| 60 | 5632 | 5300 | 5381 | 5652 | 5356 |
| 65 | 5433 | 5578 | 5488 | 5320 | 5551 |
| 70 | 5702 | 5299 | 5380 | 5328 | 5304 |
| 75 | 5431 | 5704 | 5406 | 5526 | 5443 |
| 80 | 5700 | 5516 | 5297 | 5679 | 5363 |
| 85 | 5417 | 5309 | 5507 | 5296 | 5595 |
| 90 | 5267 | 5696 | 5514 | 5263 | 5535 |
| 95 | 5684 | 5613 | 5529 | 5445 | 5548 |

Hopping Frequency Sequence Name: HOP_FREQ_SEQ_30

| Frequency (MHz) | 0 | 1 | 2 | 3 | 4 |
|-----------------|------|------|------|------|------|
| 0 | 5721 | 5323 | 5288 | 5597 | 5506 |
| 5 | 5313 | 5392 | 5276 | 5305 | 5279 |
| 10 | 5335 | 5420 | 5640 | 5624 | 5664 |
| 15 | 5710 | 5701 | 5655 | 5270 | 5673 |
| 20 | 5443 | 5643 | 5568 | 5567 | 5641 |
| 25 | 5548 | 5451 | 5339 | 5312 | 5619 |
| 30 | 5449 | 5425 | 5303 | 5386 | 5547 |
| 35 | 5278 | 5359 | 5656 | 5438 | 5542 |
| 40 | 5608 | 5575 | 5495 | 5417 | 5688 |
| 45 | 5389 | 5530 | 5564 | 5319 | 5657 |
| 50 | 5618 | 5609 | 5543 | 5455 | 5328 |
| 55 | 5480 | 5683 | 5587 | 5400 | 5311 |
| 60 | 5508 | 5652 | 5257 | 5464 | 5601 |
| 65 | 5327 | 5258 | 5654 | 5381 | 5415 |
| 70 | 5678 | 5409 | 5268 | 5500 | 5718 |
| 75 | 5309 | 5556 | 5541 | 5582 | 5566 |
| 80 | 5523 | 5638 | 5700 | 5401 | 5576 |
| 85 | 5489 | 5414 | 5665 | 5507 | 5571 |
| 90 | 5513 | 5453 | 5653 | 5540 | 5612 |
| 95 | 5322 | 5302 | 5509 | 5620 | 5504 |

--- END ---