

FCC 47 CFR PART 15 SUBPART C AND ANSI C63.10:2013 TEST REPORT

For

DOCSIS 3.1 wifi Gateway

Model: CODA-4782

Data Applies To : CODA-4682, CODA-4580, CODA-4582

Trade Name: Hitron

Issued for

Hitron Technologies,Inc.

No. 1-8,Lihsin 1st Rd.,HsinChu Science Park,HsinChu,Taiwan 300,R.O.C.

Issued by

**Compliance Certification Services Inc.
Hsinchu Lab.**

**No.989-1, Wenshan Rd., Shangshan Village,
Qionglin Township, Hsinchu County 30741, Taiwan (R.O.C.)**

TEL: +886-3-5921698

FAX: +886-3-5921108

<http://www.ccsrf.com>

E-Mail: service@ccsrf.com

Issued Date: October 21, 2016



Note: This report shall not be reproduced except in full, without the written approval of Compliance Certification Services Inc. This document may be altered or revised by Compliance Certification Services Inc. personnel only, and shall be noted in the revision section of the document. The client should not use it to claim product endorsement by TAF or any government agencies. The test results of this report relate only to the tested sample identified in this report.

Revision History

Rev.	Issue Date	Revisions	Effect Page	Revised By
00	10/21/2016	Initial Issue	All Page 151	Gloria Chang

TABLE OF CONTENTS

TITLE	PAGE NO.
1. TEST REPORT CERTIFICATION	4
2. EUT DESCRIPTION	5
3. DESCRIPTION OF TEST MODES	6
4. TEST METHODOLOGY	8
5. FACILITIES AND ACCREDITATION	8
5.1 FACILITIES.....	8
5.2 ACCREDITATIONS	8
5.3 MEASUREMENT UNCERTAINTY.....	9
6. SETUP OF EQUIPMENT UNDER TEST	10
7. FCC PART 15.247 REQUIREMENTS	12
7.1 DUTY CYCLE MEASUREMENT.....	12
7.2 6dB BANDWIDTH.....	13
7.3 AVERAGE OUTPUT POWER	39
7.4 POWER SPECTRAL DENSITY	43
7.5 CONDUCTED SPURIOUS EMISSION.....	71
7.6 RADIATED EMISSION	108
7.7 CONDUCTED EMISSION.....	143
8. APPENDIX SETUP PHOTOS	148

1. TEST REPORT CERTIFICATION

Applicant : Hitron Technologies, Inc.
Address : No. 1-8, Lihsin 1st Rd., HsinChu Science Park, HsinChu, Taiwan 300, R.O.C.
Equipment Under Test : DOCSIS 3.1 wifi Gateway
Model : CODA-4782
Data Applies To : CODA-4682, CODA-4580, CODA-4582
Trade Name : Hitron
Tested Date : September 02 ~ October 03, 2016

APPLICABLE STANDARD	
Standard	Test Result
FCC Part 15 Subpart C AND ANSI C63.10:2013	PASS

WE HEREBY CERTIFY THAT: The above equipment has been tested by Compliance Certification Services Inc., and found compliance with the requirements set forth in the technical standards mentioned above. The results of testing in this report apply only to the product/system, which was tested. Other similar equipment will not necessarily produce the same results due to production tolerance and measurement uncertainties.

Approved by:



Sb. Lu
Sr. Engineer

Reviewed by:



Gundam Lin
Sr. Engineer

2. EUT DESCRIPTION

Product Name	DOCSIS 3.1 wifi Gateway
Model Number	CODA-4782
Data Applies To	CODA-4682, CODA-4580, CODA-4582
Identify Number	T160919S01
Received Date	September 02, 2016
Frequency Range	IEEE 802.11b/g, 802.11gn HT20 Mode: 2412MHz ~ 2462MHz IEEE 802.11gn HT40 Mode: 2422MHz ~ 2452MHz
Transmit Power (Average)	IEEE 802.11b Mode: 23.22 dBm (0.2099 W) IEEE 802.11g Mode: 24.31 dBm (0.2698 W) IEEE 802.11gn HT20 Mode: 25.16 dBm (0.3281 W) IEEE 802.11gn HT40 Mode: 20.87 dBm (0.1222 W)
Channel Spacing	5MHz
Channel Number	IEEE 802.11b/g, 802.11gn HT20 Mode: 11 Channels IEEE 802.11gn HT40 Mode: 7 Channels
Transmit Data Rate	IEEE 802.11b Mode: up to 11 Mbps IEEE 802.11g Mode: up to 54 Mbps IEEE 802.11gn HT20 Mode (800ns GI): up to 195.00 Mbps IEEE 802.11gn HT20 Mode (400ns GI): up to 216.60 Mbps IEEE 802.11gn HT40 Mode (800ns GI): up to 390.00 Mbps IEEE 802.11gn HT40 Mode (400ns GI): up to 450.00 Mbps
Type of Modulation	IEEE 802.11b Mode: DSSS (CCK, DQPSK, DBPSK) IEEE 802.11g Mode: OFDM (64QAM, 16QAM, QPSK, BPSK) IEEE 802.11gn HT20/40 Mode: OFDM (64QAM, 16QAM, QPSK, BPSK)
Antenna Type	Dipole Antenna × 3 , Ant. 1 (Chain 2), Antenna Gain: 3.69 dBi Ant. 2 (Chain 0), Antenna Gain: 3.23 dBi Ant. 3 (Chain 1), Antenna Gain: 4.28 dBi
Power Rating	100 - 120Vac, 0.5A, 50-60Hz
Test Voltage	120Vac, 60Hz
AC Power Cable Type	Non-shielded, 1.8m × 1 (Detachable)
I/O Port	RJ-45 Port × 4, USB Port × 1, Coaxial Port × 1, Power Port × 1
Signal Cable	Non-shielded RJ-45 cable, 1.5m × 1 (Detachable)

The difference of the series model

Model Number	Difference				
	Cable Upstream Freq	Downstream Freq	MOCA	Diplexer	Color
CODA-4580	5-85MHz	108-1002MHz	Without	1	Black
CODA-4582	5-85MHz	108-1002MHz	With	1	White
CODA-4682	5-42MHz 5-85MHz	108-1002MHz 258-1002MHz	With	2	Black
CODA-4782	5-85MHz 5-204MHz	108-1002MHz 258-1002MHz	With	2	Black

Remark:

1. The sample selected for test was engineering sample that approximated to production product and was provided by manufacturer.
2. For more details, please refer to the User's manual of the EUT.
3. This submittal(s) (test report) is intended for FCC ID: 2AHKM-CODA4782 filing to comply with Section 15.207, 15.209 and 15.247 of the FCC Part 15, Subpart C Rules.
4. The model CODA-4782 was considered the main model for testing.

3. DESCRIPTION OF TEST MODES

The EUT (DOCSIS 3.1 wifi Gateway) had been tested under operating condition.

IEEE 802.11b/g, 802.11gn HT20/HT40 Mode: 3TX / 3RX

Ant. 1 / Chain 2 & Ant. 2 / Chain 0 & Ant. 3 / Chain 1 transmit/receive.

Conducted Emission / Radiated Emission Test (Below 1 GHz)

1. The following test modes were scanned during the preliminary test:

No.	Pre-Test mode
1	Normal Operating Mode (Full Function)

2. After the preliminary scan, the following test mode was found to produce the highest emission level.

Final Test mode		
Emission	Radiated Emission	Mode 1
	Conducted Emission	Mode 1

Remark: Then, the above highest emission mode of the configuration of the EUT and cable was chosen for all final test items.

Conducted / Radiated Emission Test (Above 1 GHz)

IEEE 802.11b/g, 802.11gn HT20 Mode:

The EUT had been tested under operating condition.

There are three channels have been tested as following:

Channel	Frequency (MHz)
Low	2412
Middle	2437
High	2462

IEEE 802.11b Mode: 1Mbps data rate (worst case) was chosen for full testing.

IEEE 802.11g Mode: 6Mbps data rate (worst case) was chosen for full testing.

IEEE 802.11gn HT20 MCS0 Mode: 6.5Mbps data rate (worst case) was chosen for full testing.

IEEE 802.11gn HT40 Mode:

The EUT had been tested under operating condition.

There are three channels have been tested as following:

Channel	Frequency (MHz)
Low	2422
Middle	2437
High	2452

IEEE 802.11gn HT40 MCS0 Mode: 13.5Mbps data rate (worst case) was chosen for full testing.

4. TEST METHODOLOGY

The tests documented in this report were performed in accordance with ANSI C63.10:2013 and FCC CFR 47, 15.207, 15.209 and 15.247.

5. FACILITIES AND ACCREDITATION

5.1 FACILITIES

All measurement facilities used to collect the measurement data are located at No.989-1, Wenshan Rd., Shangshan Village, Qionglin Township, Hsinchu County 30741, Taiwan (R.O.C.)

The sites are constructed in conformance with the requirements of ANSI C63.10:2013 and CISPR 22. All receiving equipment conforms to CISPR 16-1-1, CISPR 16-1-2, CISPR 16-1-3, CISPR 16-1-4 and CISPR 16-1-5.

5.2 ACCREDITATIONS

Our laboratories are accredited and approved by the following approval agencies according to ISO/IEC 17025.

Taiwan	TAF
---------------	-----

The measuring facility of laboratories has been authorized or registered by the following approval agencies.

Canada	INDUSTRY CANADA
Japan	VCCI
Taiwan	BSMI
USA	FCC MRA

Copies of granted accreditation certificates are available for downloading from our web site, <http://www.ccsrf.com>

Remark: FCC Designation Number TW1027.

5.3 MEASUREMENT UNCERTAINTY

The following table is for the measurement uncertainty, which is calculated as per the document CISPR 16-4-2.

PARAMETER	UNCERTAINTY
Semi Anechoic Chamber (966 Chamber_B) / Radiated Emission, 30 to 1000 MHz	+/- 3.97
Semi Anechoic Chamber (966 Chamber_B) / Radiated Emission, 1 to 18GHz	+/- 3.58
Semi Anechoic Chamber (966 Chamber_B) / Radiated Emission, 18 to 26 GHz	+/- 3.59
Semi Anechoic Chamber (966 Chamber_B) / Radiated Emission, 26 to 40 GHz	+/- 3.81
Conducted Emission (Mains Terminals), 9kHz to 30MHz	+/- 2.48

This uncertainty represents an expanded uncertainty expressed at approximately the 95% confidence level using a coverage factor of $k=2$.

Consistent with industry standard (e.g. CISPR 22, clause 11, Measurement Uncertainty) determining compliance with the limits shall be base on the results of the compliance measurement. Consequently the measure emissions being less than the maximum allowed emission result in this be a compliant test or passing test.

The acceptable measurement uncertainty value without requiring revision of the compliance statement is base on conducted and radiated emissions being less than U_{CISPR} which is 3.6dB and 5.2dB respectively. CCS values (called U_{Lab} in CISPR 16-4-2) is less than U_{CISPR} as shown in the table above. Therefore, MU need not be considered for compliance.

6. SETUP OF EQUIPMENT UNDER TEST

SUPPORT EQUIPMENT

No.	Product	Manufacturer	Model No.	Serial No.
1	Notebook PC	Lenovo	TP00018A	R9LMB1Z
2	Notebook PC	TOSHIBA	PORTEGE R30-A	7F097011H
3	Notebook PC	TOSHIBA	PORTEGE R30-A	7F097001H
4	USB Flash Drive	Kingston	DTSE9 8G	---
5	CMTS	Hitron	RAC-500	S15070901-X0601

No.	Signal Cable Description
1	Non-shielded RJ-45 cable, 12m × 1
2	Non-shielded RJ-45 cable, 1.2m × 3

SETUP DIAGRAM FOR TESTS

EUT & peripherals setup diagram is shown in appendix setup photos.

EUT OPERATING CONDITION

1. EUT & peripherals setup diagram is shown in appendix setup photos.
2. Link USB Dongle (put [art2_3.1.0] file in USB)
3. USE HyperTerminal Link to EUT by Console → Transfer mode : 115200

Login: root

KeyIn Command Load Firmware (line by line keyin) ->

apdown

ifconfig br2 192.168.0.254

cd /tmp/mnt/diska1/art2_3.1.0/

./init_art2.sh

4. Link EUT by LAN and Run Art RF control software [autgui]
5. IPaddress 192.168.0.254 , Board Name: XB112-035 -> Load

6. TX Mode:

- ⇒ **TX Data Rate:** 1Mbps Bandwidth 20 (IEEE 802.11b Mode)
- 6Mbps Bandwidth 20 (IEEE 802.11g Mode)
- 6.5Mbps Bandwidth 20 (IEEE 802.11gn HT20 MCS0 Mode)
- 13.5Mbps Bandwidth 40 (IEEE 802.11gn HT40 MCS0 Mode)

⇒ **Power control**

Mode	Channel	Frequency (MHz)	Chain	Power Set
IEEE 802.11b	Low	2412	0/1/2	17
	Middle	2437	0/1/2	18.5
	High	2462	0/1/2	17.5
IEEE 802.11g	Low	2412	0/1/2	15
	Middle	2437	0/1/2	19
	High	2462	0/1/2	15
IEEE 802.11gn HT20 MCS0	Low	2412	0/1/2	13
	Middle	2437	0/1/2	20
	High	2462	0/1/2	13
IEEE 802.11gn HT40 MCS0	Low	2422	0/1/2	11
	Middle	2437	0/1/2	15
	High	2452	0/1/2	13

7. All of the functions are under run.

8. Start test.

Normal Mode :

1. EUT & peripherals setup diagram is shown in appendix setup photos.
2. Turn on the power of all equipment.
3. Coaxial cable link Headend-CMTS.
4. Notebook PC 1 Link EUT by LAN and ping to EUT and CMTS.
5. Notebook PC 2 Link EUT by 2.4G WiFi and ping to EUT and CMTS.
6. Notebook PC 3 Link EUT by 5G WiFi and ping to EUT and CMTS.
7. USB flash drive with load.
8. All of the functions are under run
9. Start test.

7. FCC PART 15.247 REQUIREMENTS

7.1 DUTY CYCLE MEASUREMENT

Product Name	DOCSIS 3.1 wifi Gateway	Test By	Waternil Guan
Test Model	CODA-4782	Test Date	2016/09/09
Test Mode	TX Mode	Temp. & Humidity	26°C, 58%

Mode	TX on (ms)	TX on + off (ms)	Duty Cycle (%)	Duty Factor (dB)	1/T Minimum VBW (kHz)
IEEE 802.11b	12.180	12.220	99.67	0.01	0.010
IEEE 802.11g	2.015	2.075	97.11	0.13	0.496
IEEE 802.11gn HT20	1.880	1.935	97.16	0.13	0.532
IEEE 802.11gn HT40	0.915	0.965	94.82	0.23	1.093

7.2 6dB BANDWIDTH

LIMITS

§ 15.247(a) (2) For direct sequence systems, the minimum 6dB bandwidth shall be at least 500kHz.

TEST EQUIPMENT

Name of Equipment	Manufacturer	Model	Serial Number	Calibration Due
EXA Signal Analyzer	Agilent	N9010A	MY52220817	03/15/2017
Test S/W	N/A			

Remark: Each piece of equipment is scheduled for calibration once a year.

TEST SETUP

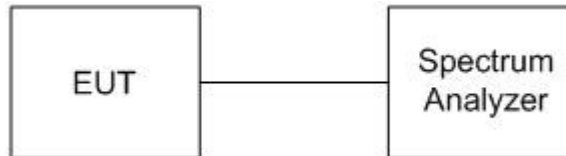

TEST PROCEDURE

1. The transmitter output was connected to a spectrum analyzer.
2. Set RBW = 100 kHz.
3. Set the video bandwidth (VBW) ≥ 3 x RBW.
4. Detector = Peak.
5. Trace mode = max hold.
6. Sweep = auto couple.
7. Allow the trace to stabilize.
8. Measure the maximum width of the emission that is constrained by the frequencies associated with the two outermost amplitude points (upper and lower frequencies) that are attenuated by 6 dB relative to the maximum level measured in the fundamental emission.

TEST RESULTS

Product Name	DOCSIS 3.1 wifi Gateway	Test By	Davis Tseng
Test Model	CODA-4782	Test Date	2016/09/20
Test Mode	TX Mode	Temp. & Humidity	26°C, 53%

IEEE 802.11b Mode (3TX)

Channel	Channel Frequency (MHz)	6dB Bandwidth (MHz)			Minimum Limit (kHz)	Result
		Chain 0	Chain 1	Chain 2		
Low	2412	10.05	10.07	10.04	500	PASS
Middle	2437	9.58	10.07	10.07	500	PASS
High	2462	10.05	9.58	10.07	500	PASS

IEEE 802.11g Mode (3TX)

Channel	Channel Frequency (MHz)	6dB Bandwidth (MHz)			Minimum Limit (kHz)	Result
		Chain 0	Chain 1	Chain 2		
Low	2412	16.42	16.38	16.33	500	PASS
Middle	2437	16.35	16.36	16.36	500	PASS
High	2462	15.97	16.37	16.34	500	PASS

IEEE 802.11gn HT20 MCS0 Mode (3TX)

Channel	Channel Frequency (MHz)	6dB Bandwidth (MHz)			Minimum Limit (kHz)	Result
		Chain 0	Chain 1	Chain 2		
Low	2412	17.56	17.59	17.59	500	PASS
Middle	2437	17.32	17.54	17.26	500	PASS
High	2462	16.95	17.58	17.56	500	PASS

IEEE 802.11gn HT40 MCS0 Mode (3TX)

Channel	Channel Frequency (MHz)	6dB Bandwidth (MHz)			Minimum Limit (kHz)	Result
		Chain 0	Chain 1	Chain 2		
Low	2422	35.69	36.35	36.36	500	PASS
Middle	2437	35.73	36.36	36.33	500	PASS
High	2452	36.32	36.33	36.37	500	PASS

6dB BANDWIDTH

CH Low (IEEE 802.11b Mode / Chain 0)

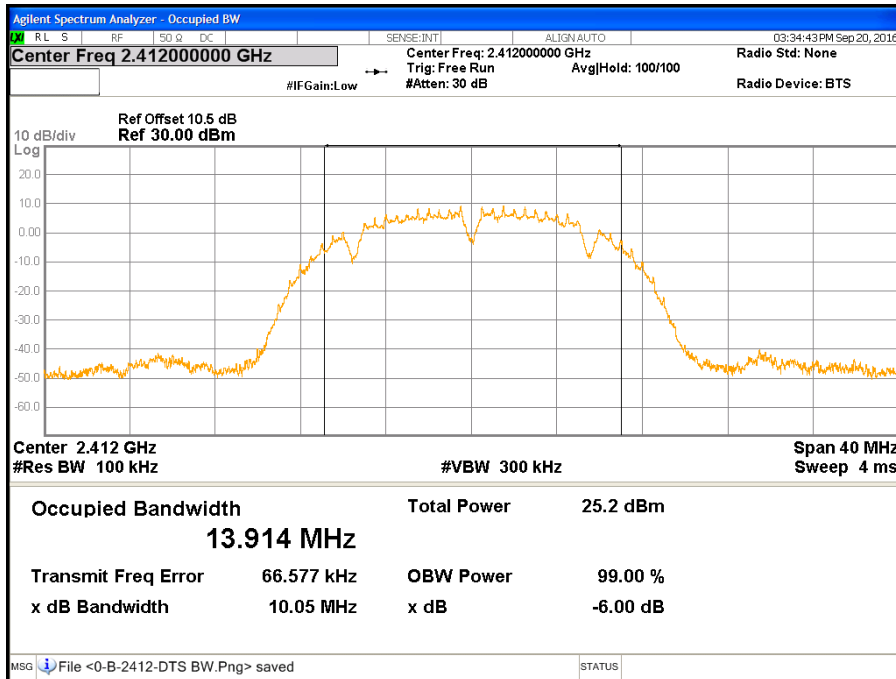

CH Middle (IEEE 802.11b Mode / Chain 0)

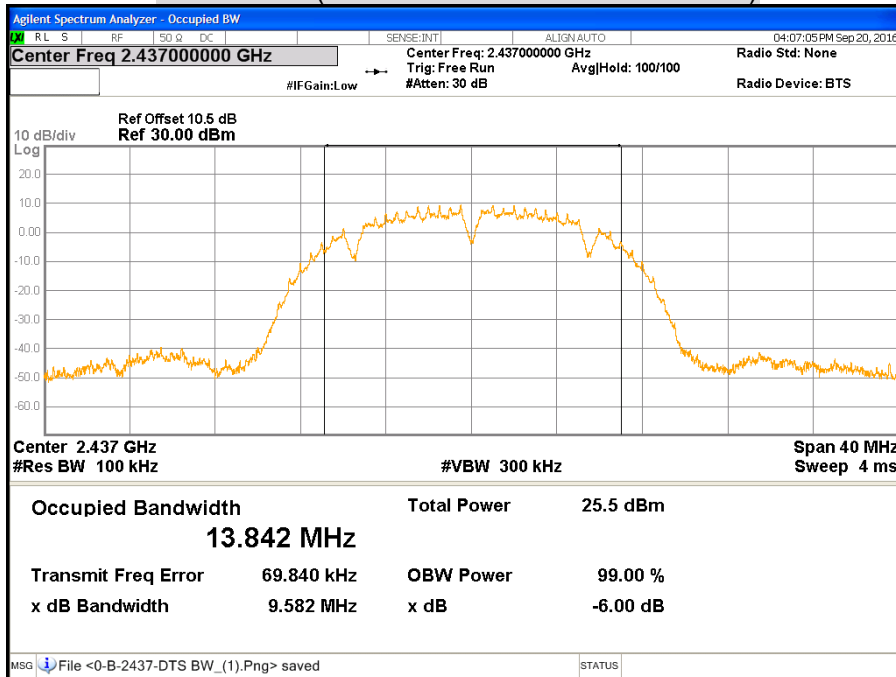

CH High (IEEE 802.11b Mode / Chain 0)

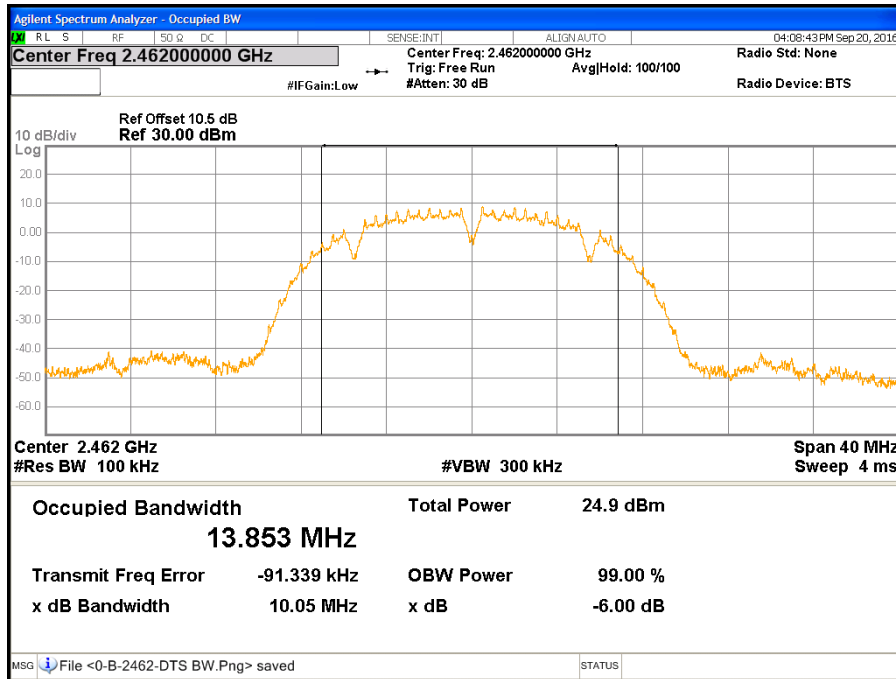

CH Low (IEEE 802.11b Mode / Chain 1)

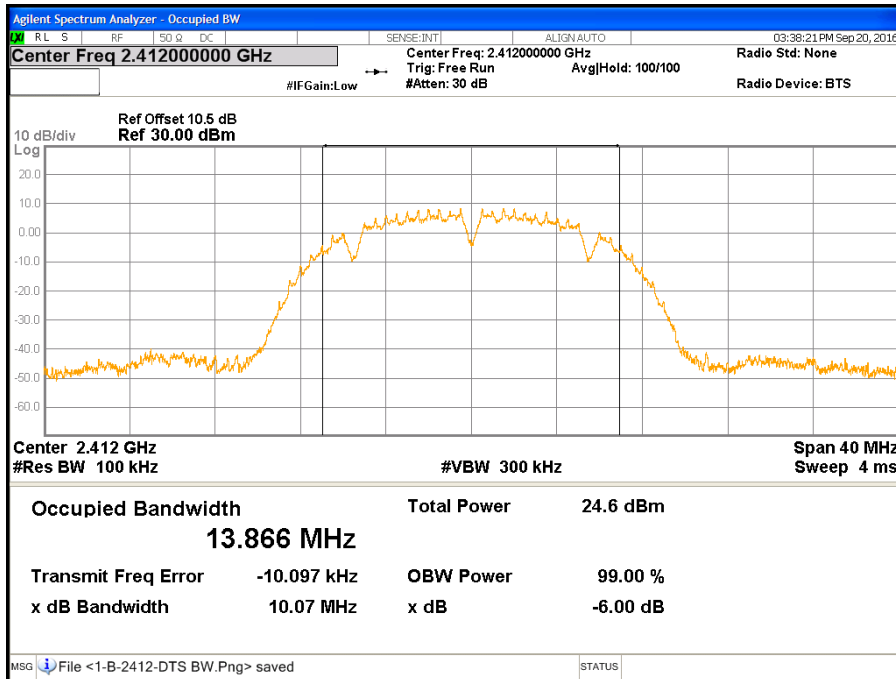

CH Middle (IEEE 802.11b Mode / Chain 1)

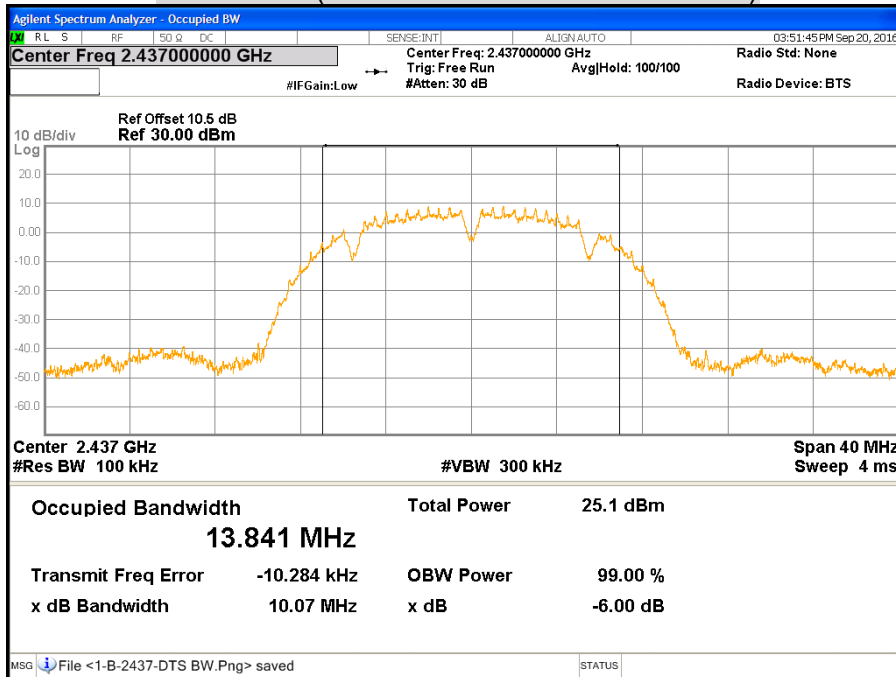

CH High (IEEE 802.11b Mode / Chain 1)

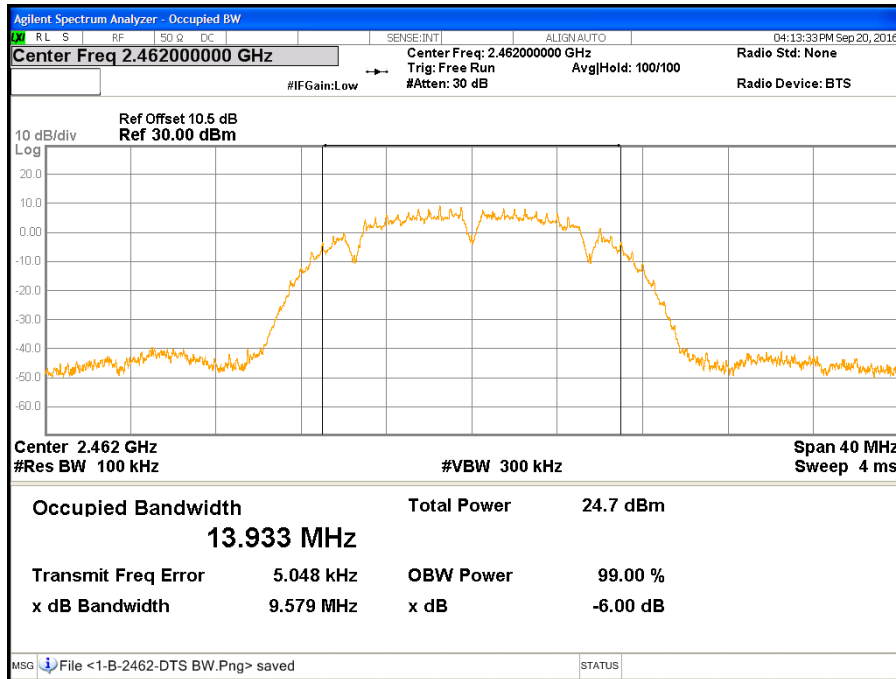

CH Low (IEEE 802.11b Mode / Chain 2)

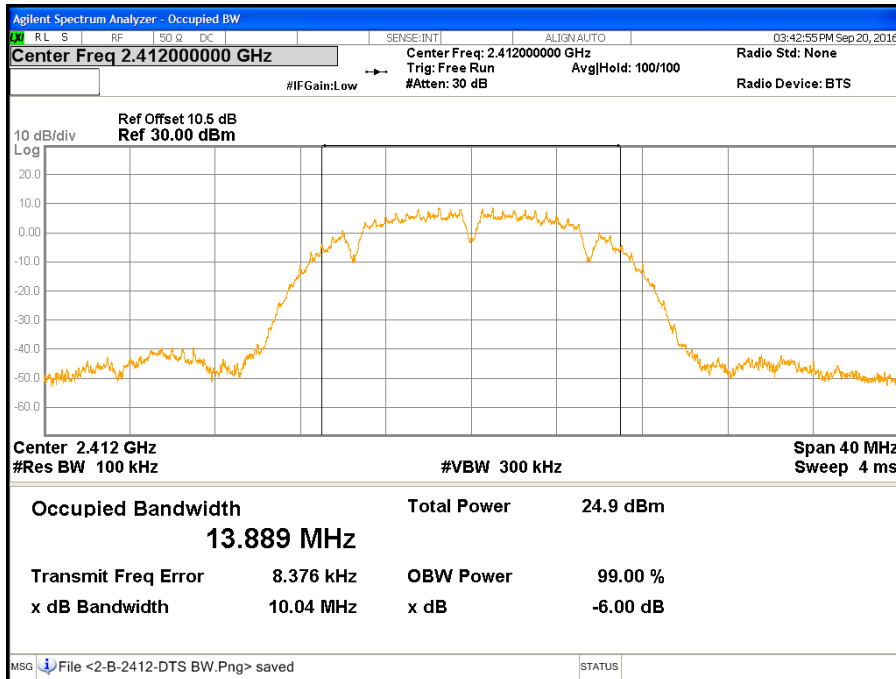

CH Middle (IEEE 802.11b Mode / Chain 2)

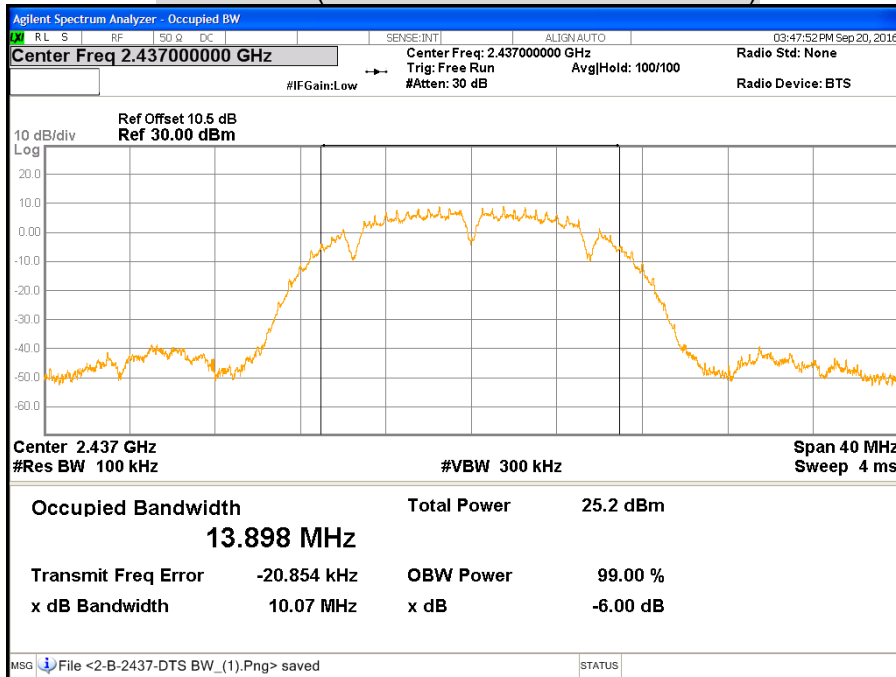

CH High (IEEE 802.11b Mode / Chain 2)

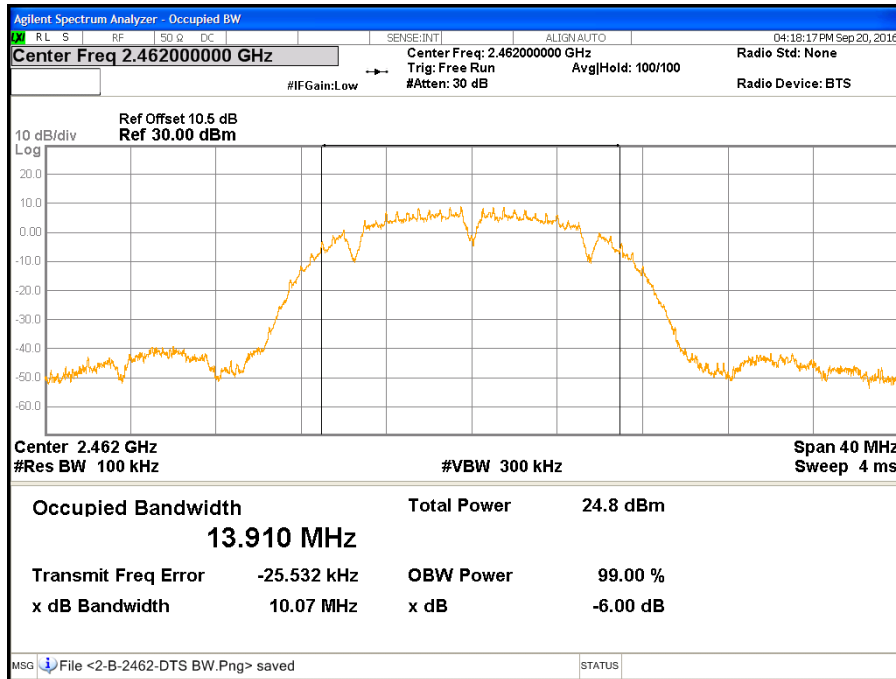

CH Low (IEEE 802.11g Mode / Chain 0)

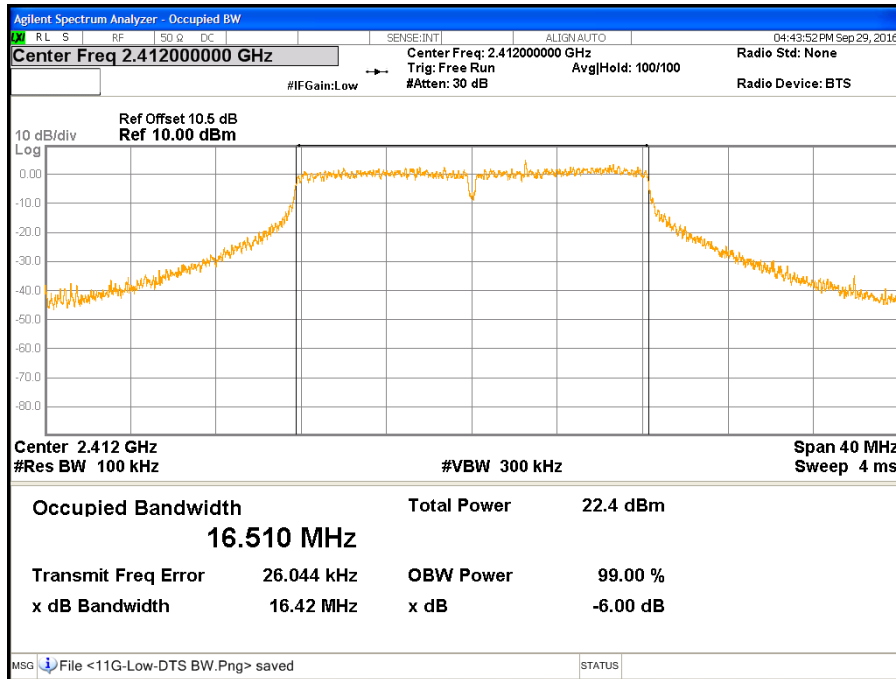

CH Middle (IEEE 802.11g Mode / Chain 0)

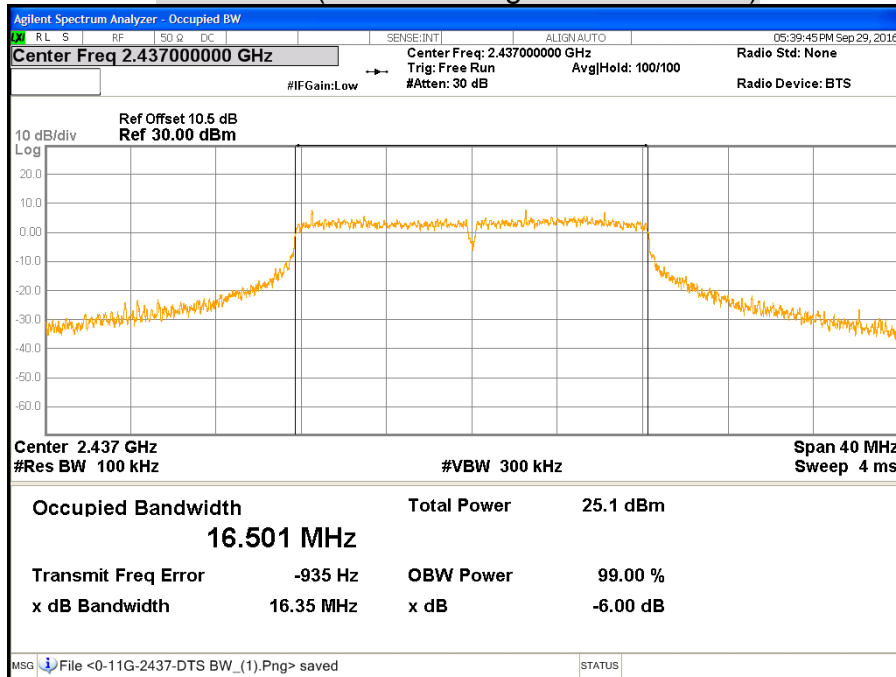

CH High (IEEE 802.11g Mode / Chain 0)

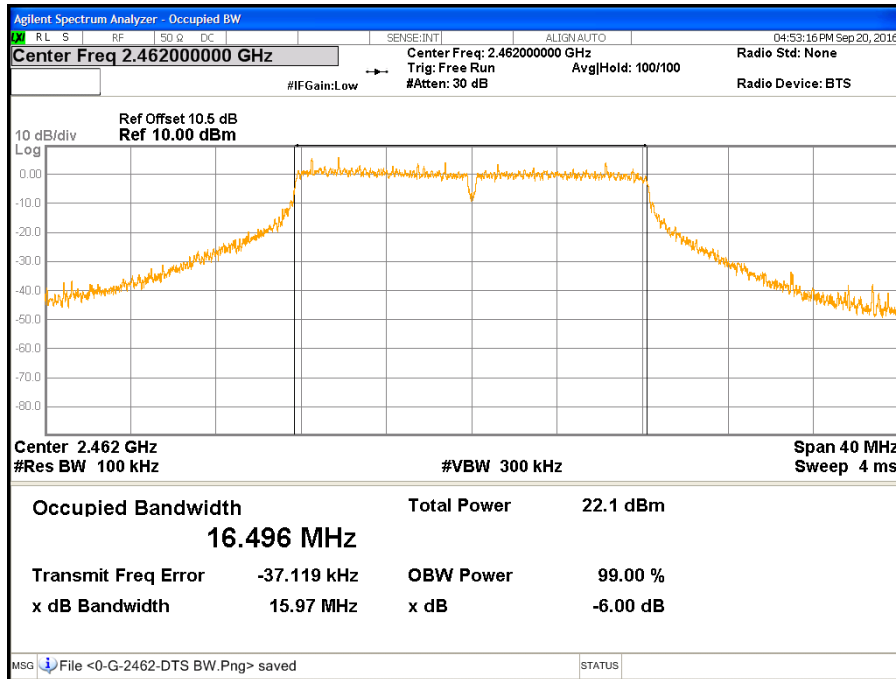

CH Low (IEEE 802.11g Mode / Chain 1)

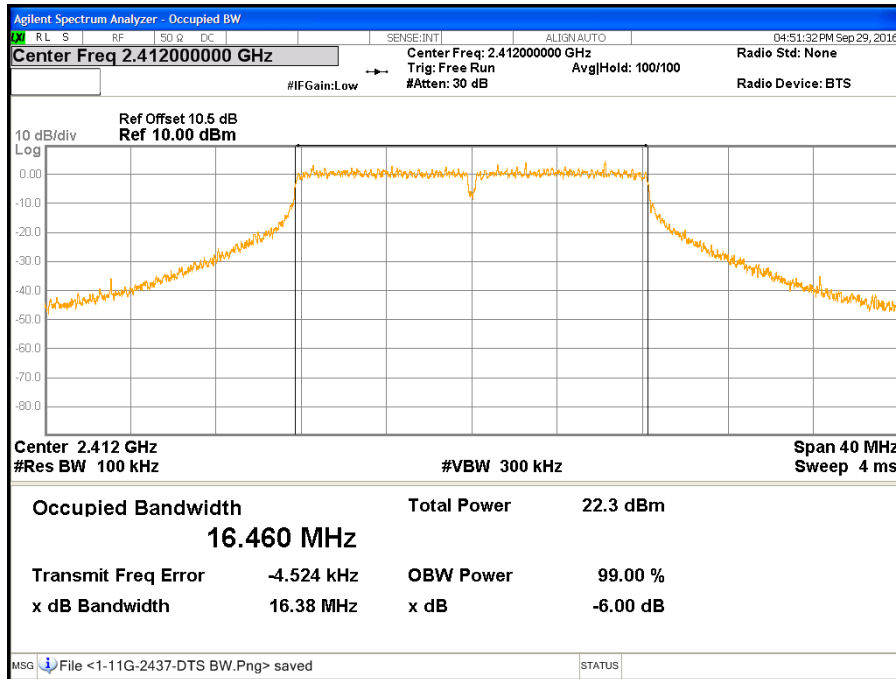

CH Middle (IEEE 802.11g Mode / Chain 1)

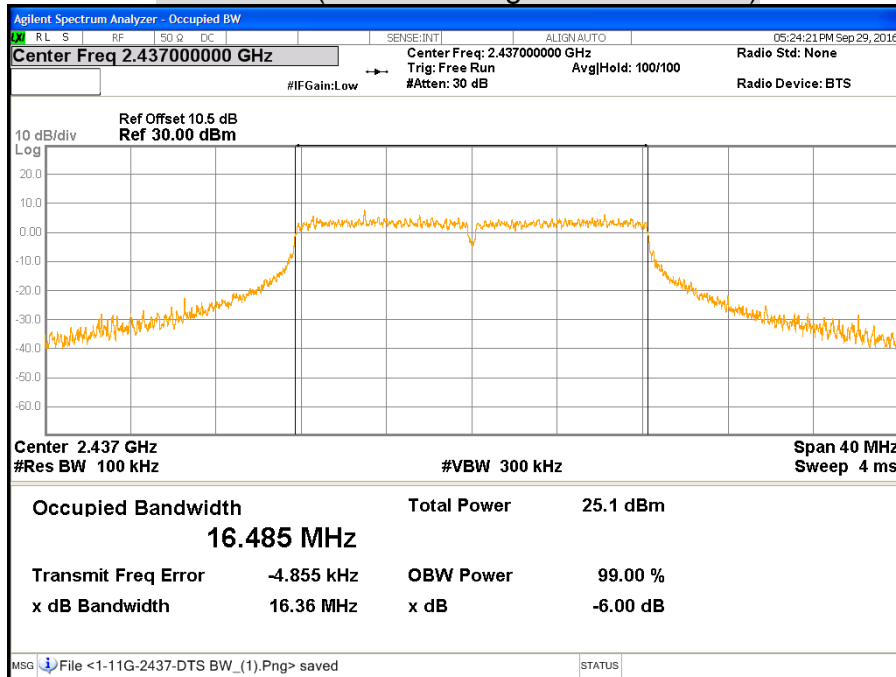

CH High (IEEE 802.11g Mode / Chain 1)

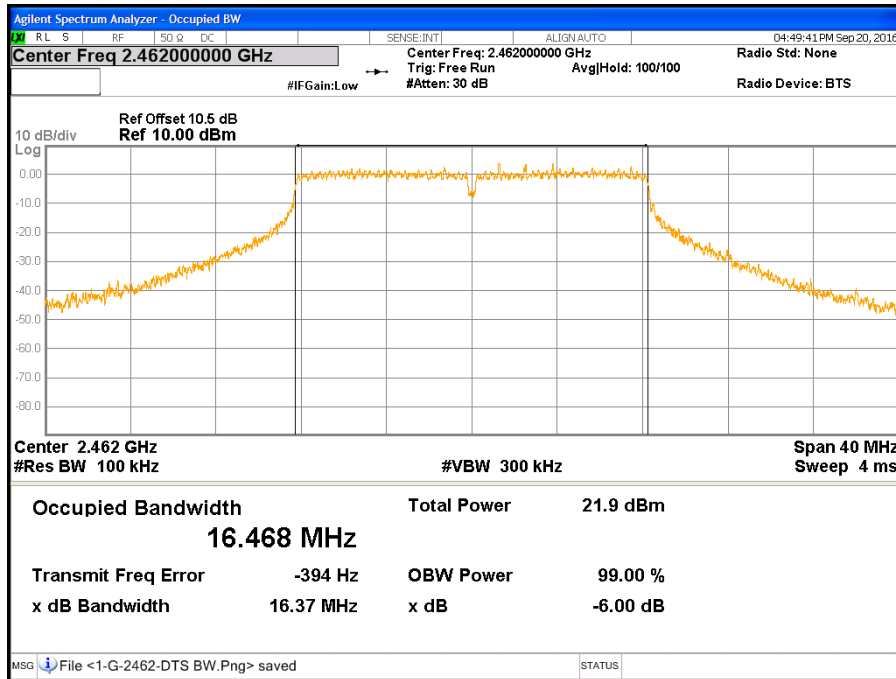

CH Low (IEEE 802.11g Mode / Chain 2)

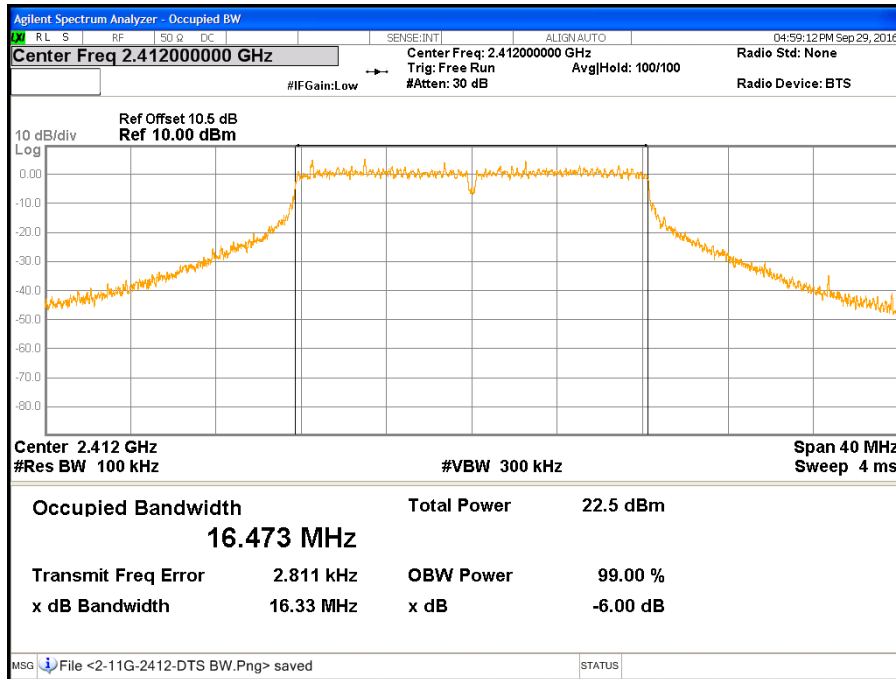

CH Middle (IEEE 802.11g Mode / Chain 2)

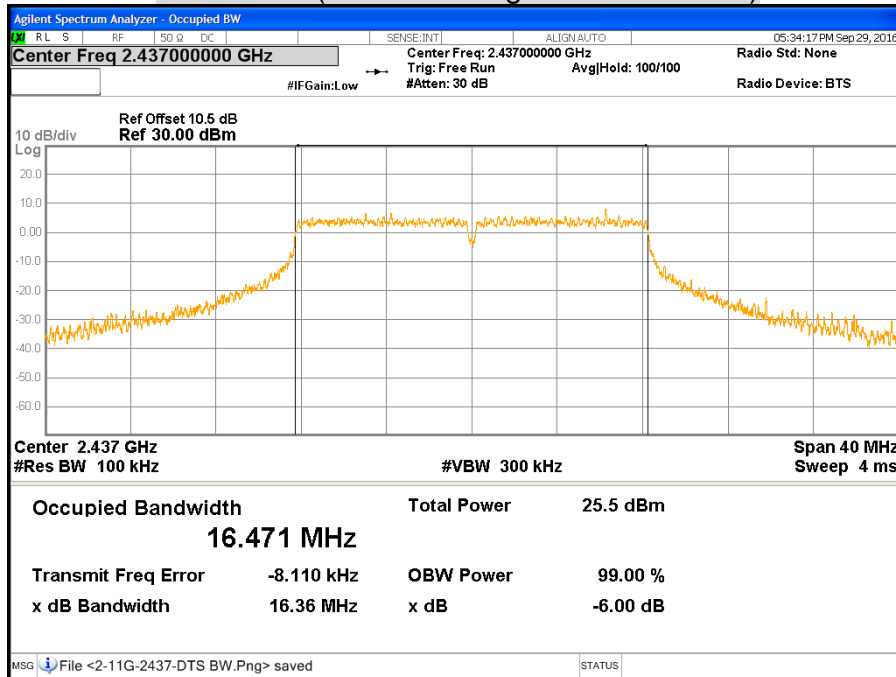

CH High (IEEE 802.11g Mode / Chain 2)

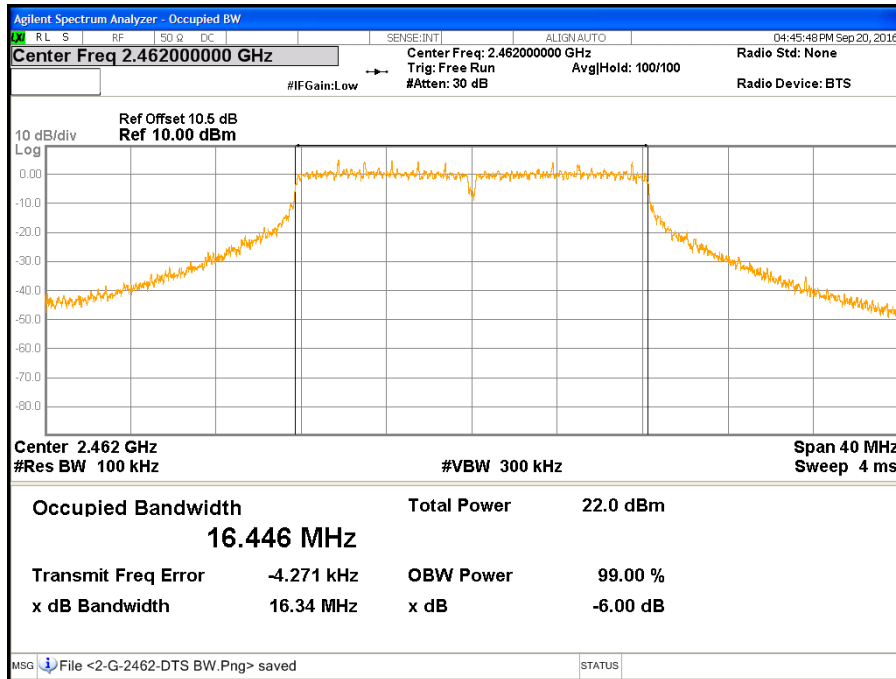

CH Low (IEEE 802.11gn HT20 MCS0 Mode / Chain 0)

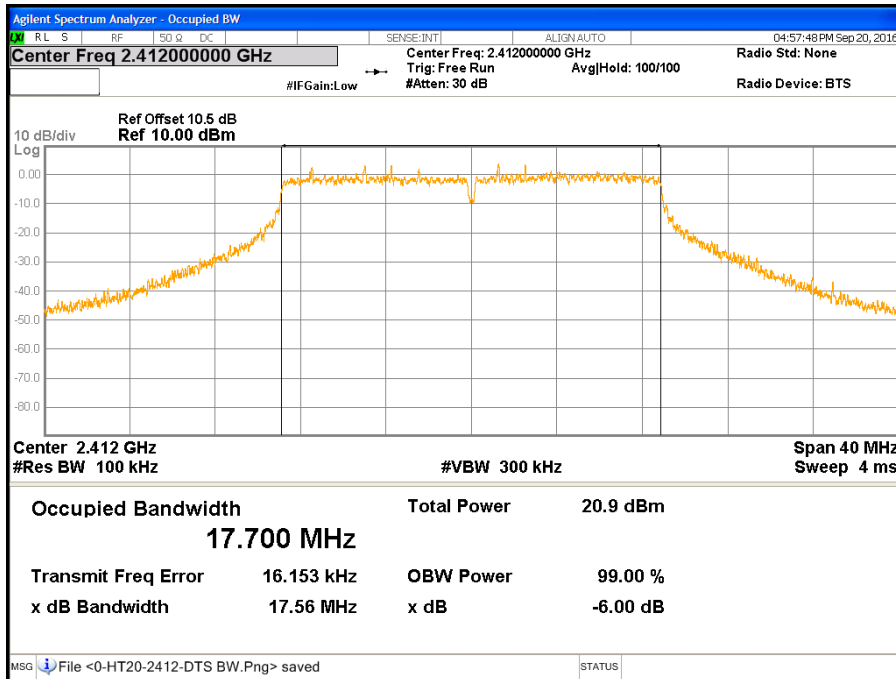

CH Middle (IEEE 802.11gn HT20 MCS0 Mode / Chain 0)

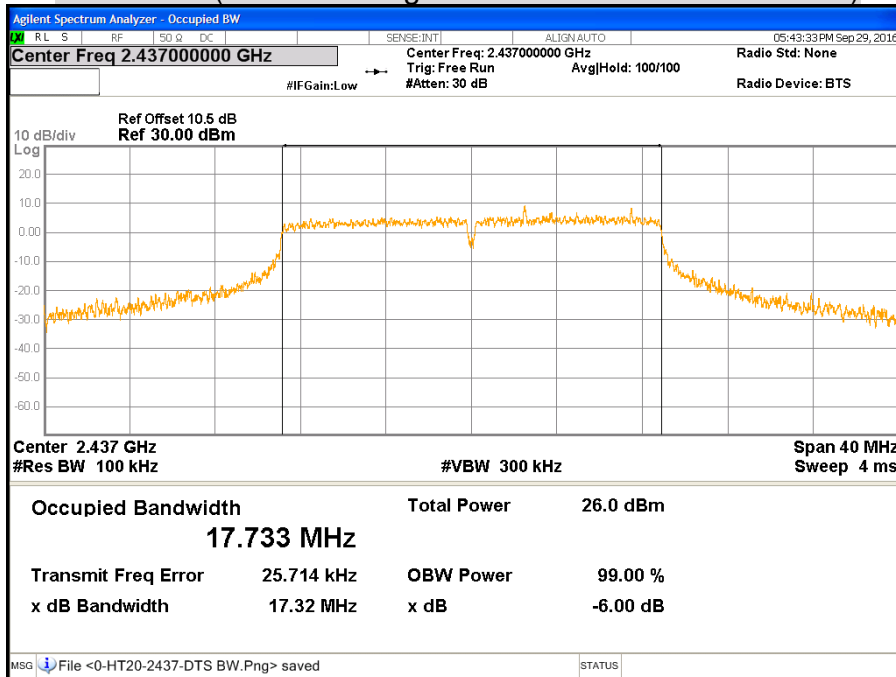

CH High (IEEE 802.11gn HT20 MCS0 Mode / Chain 0)

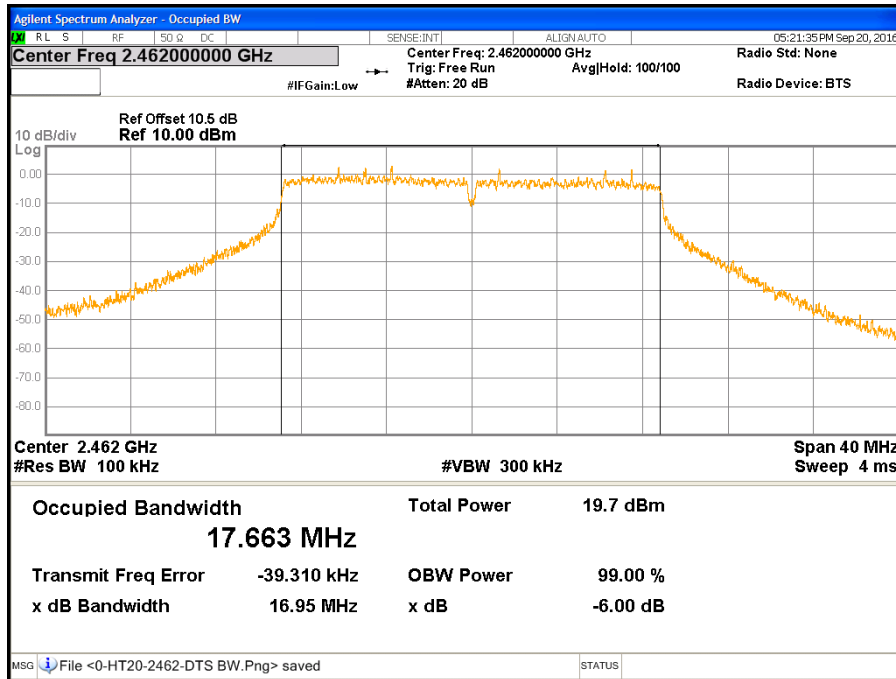

CH Low (IEEE 802.11gn HT20 MCS0 Mode / Chain 1)

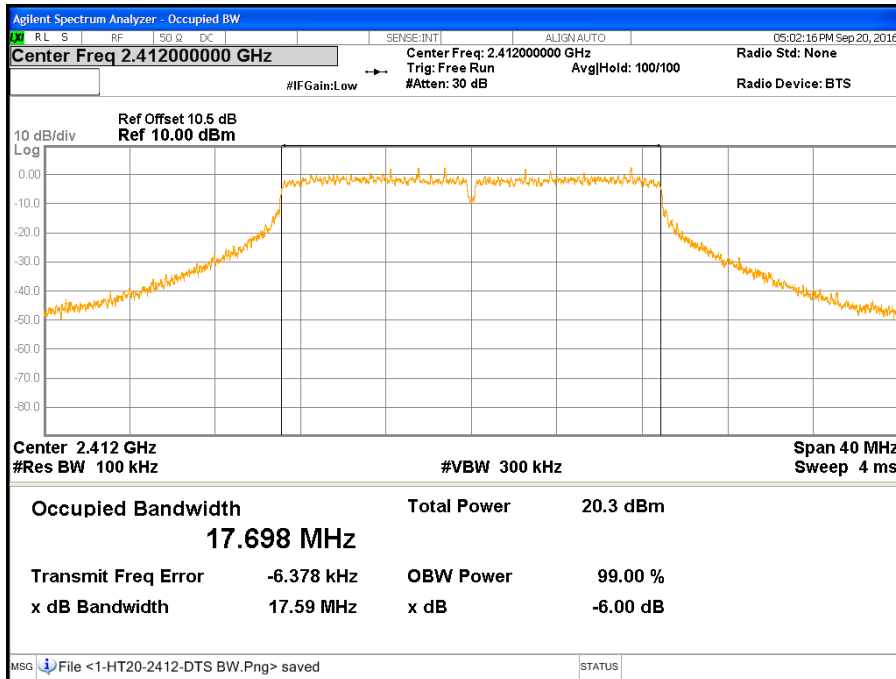

CH Middle (IEEE 802.11gn HT20 MCS0 Mode / Chain 1)

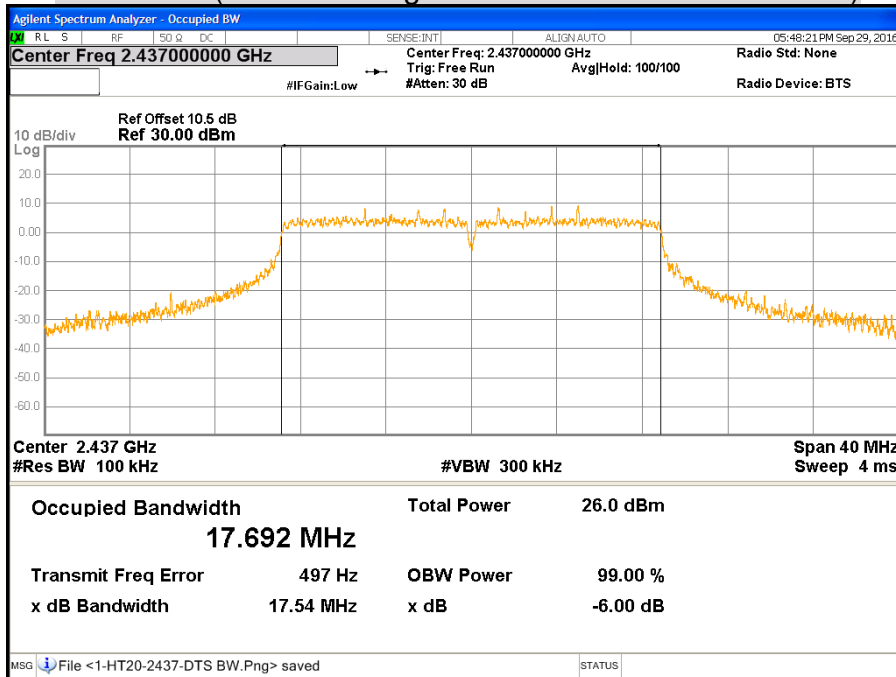

CH High (IEEE 802.11gn HT20 MCS0 Mode / Chain 1)

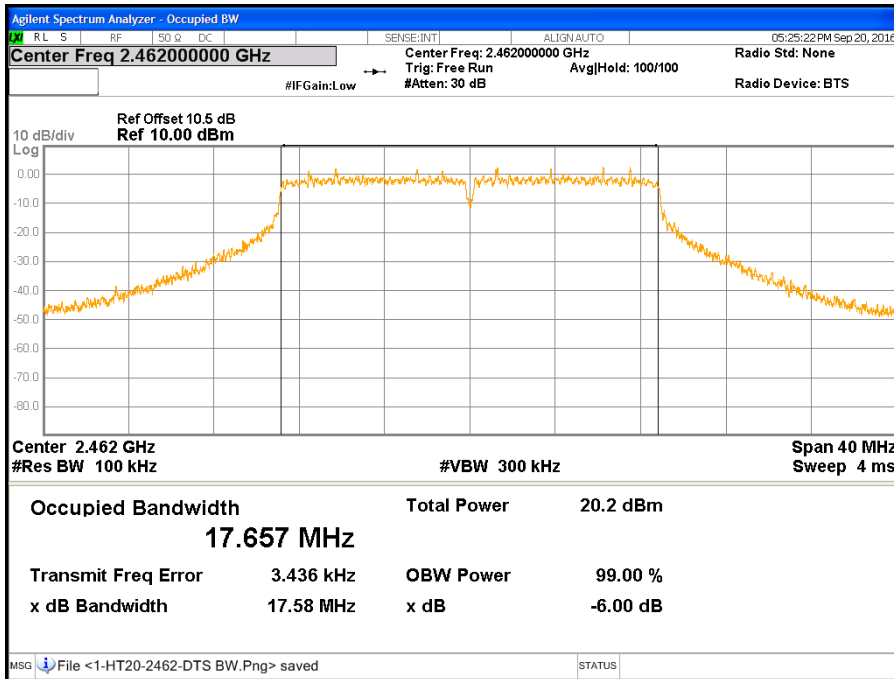

CH Low (IEEE 802.11gn HT20 MCS0 Mode / Chain 2)

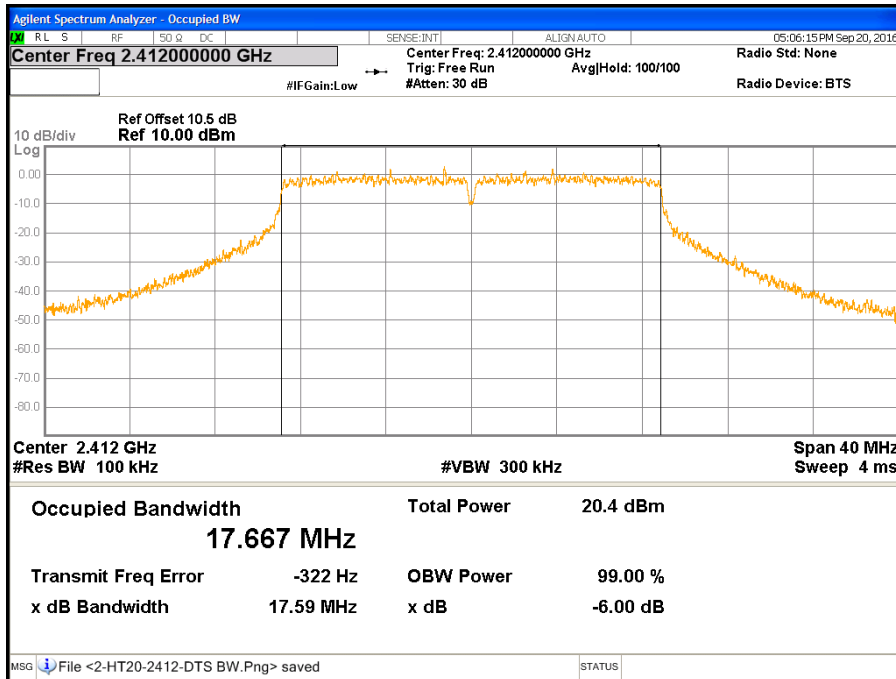

CH Middle (IEEE 802.11gn HT20 MCS0 Mode / Chain 2)

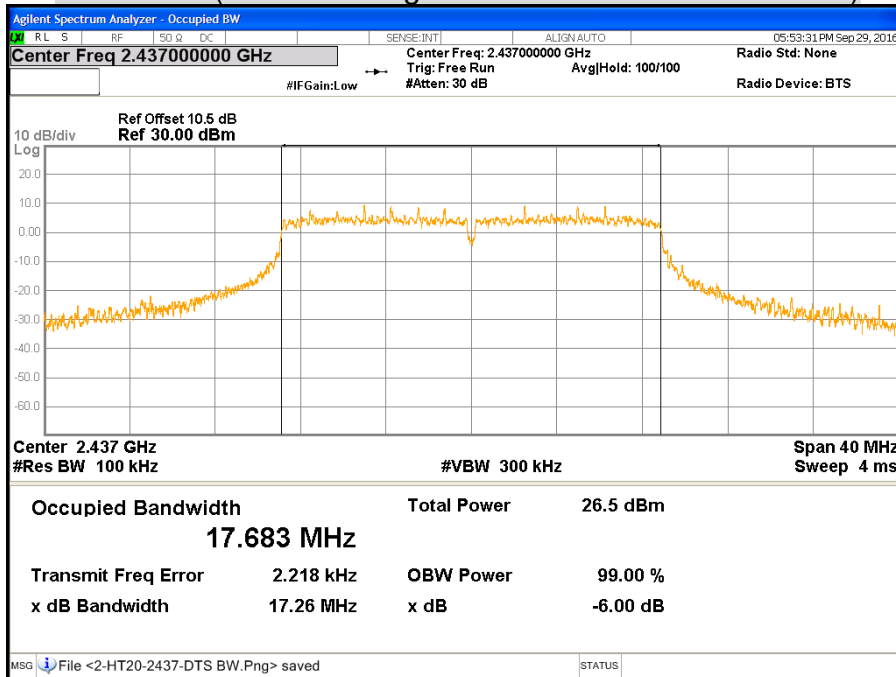

CH High (IEEE 802.11gn HT20 MCS0 Mode / Chain 2)

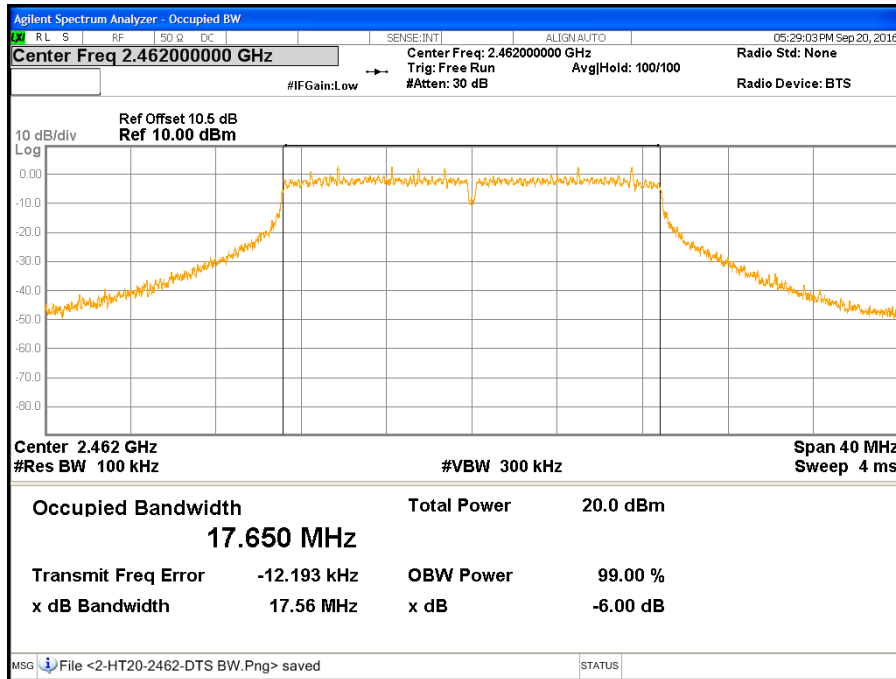

CH Low (IEEE 802.11gn HT40 MCS0 Mode / Chain 0)

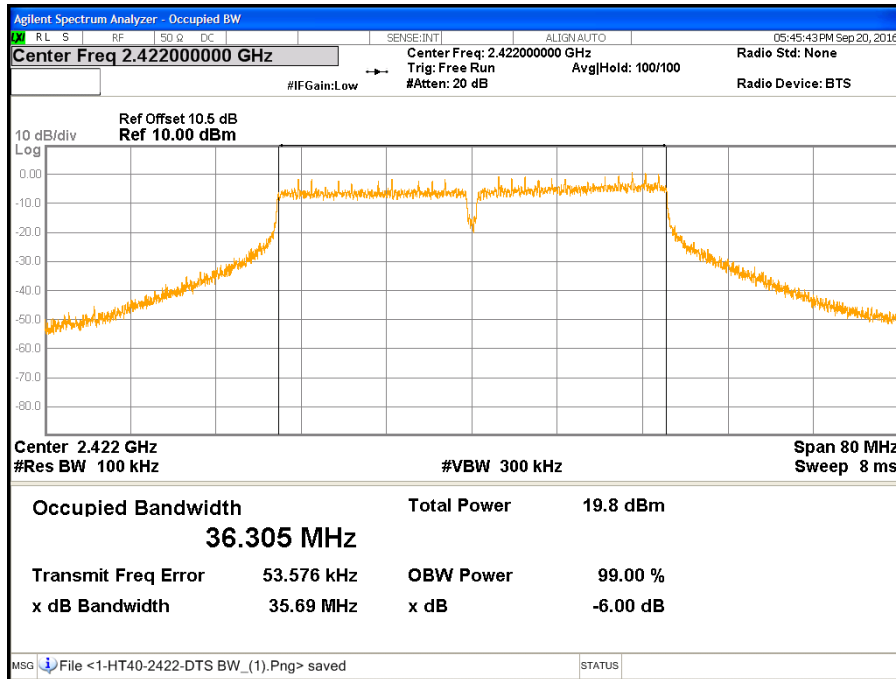

CH Middle (IEEE 802.11gn HT40 MCS0 Mode / Chain 0)

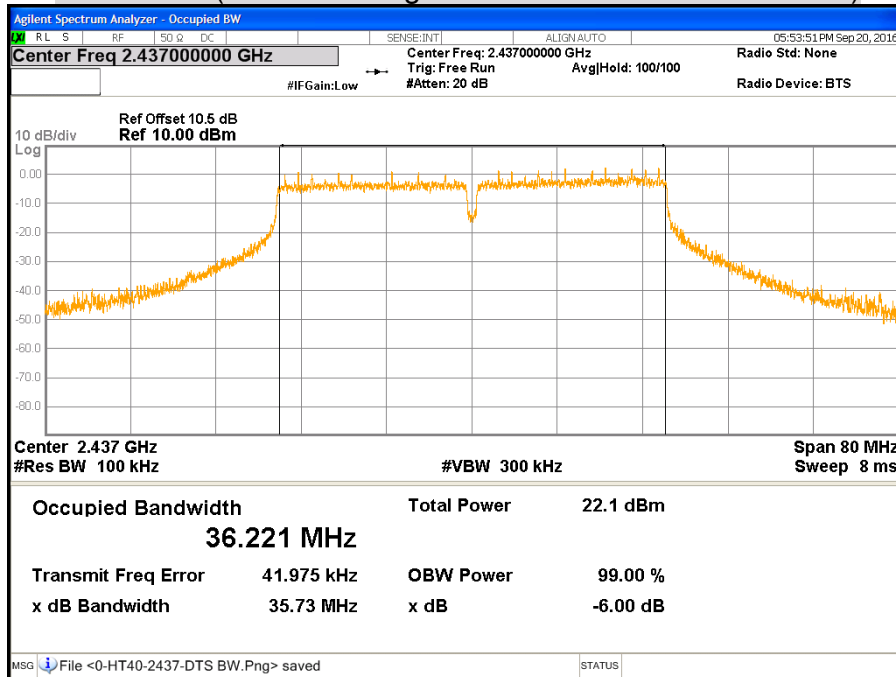

CH High (IEEE 802.11gn HT40 MCS0 Mode / Chain 0)

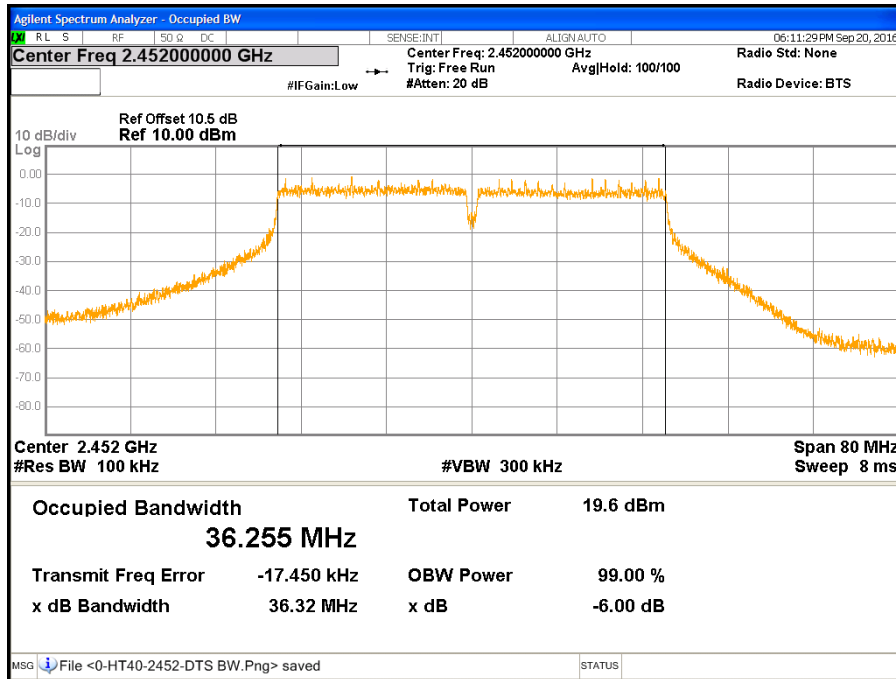

CH Low (IEEE 802.11gn HT40 MCS0 Mode / Chain 1)

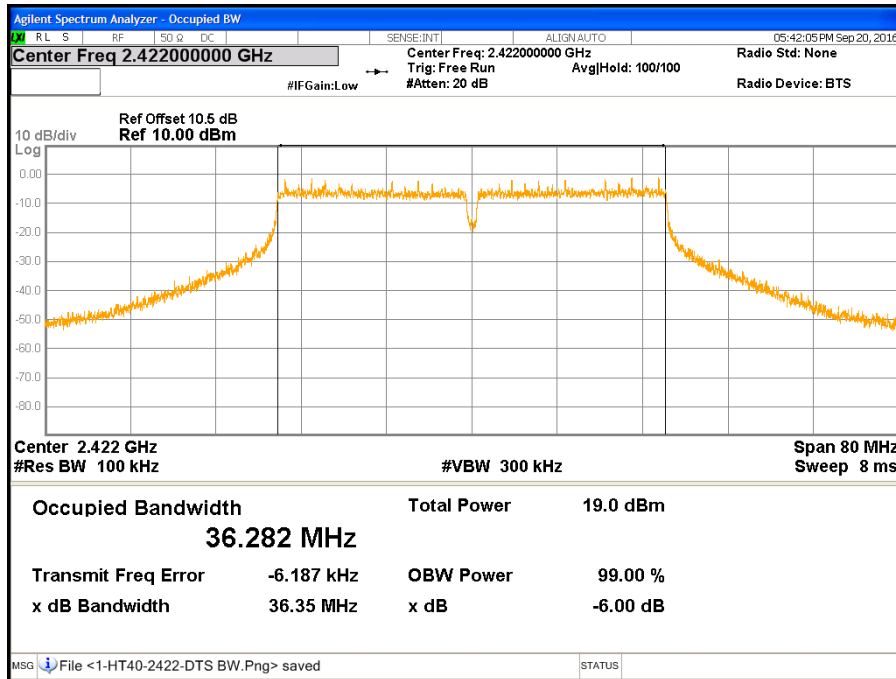

CH Middle (IEEE 802.11gn HT40 MCS0 Mode / Chain 1)

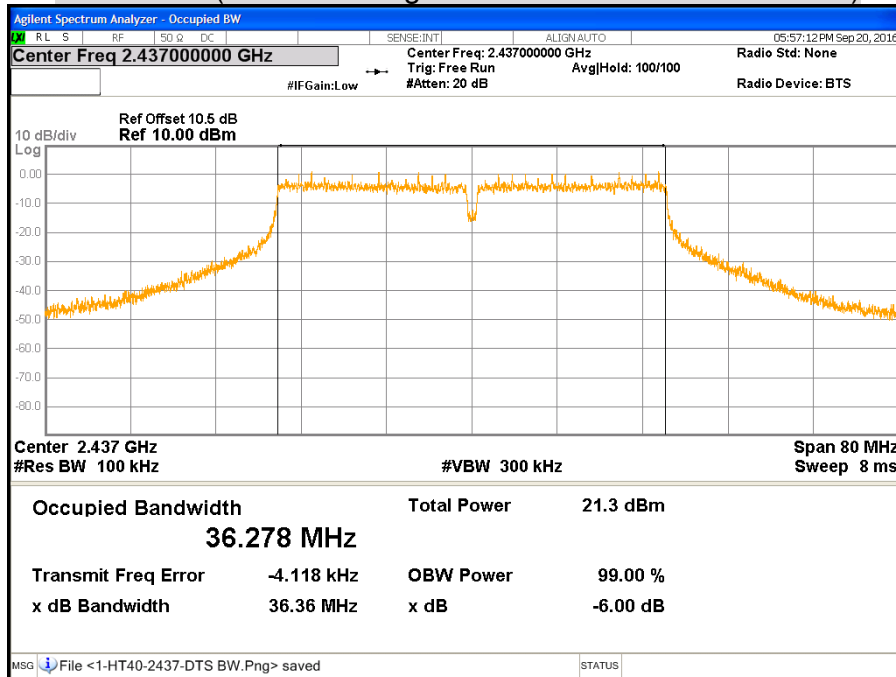

CH High (IEEE 802.11gn HT40 MCS0 Mode / Chain 1)

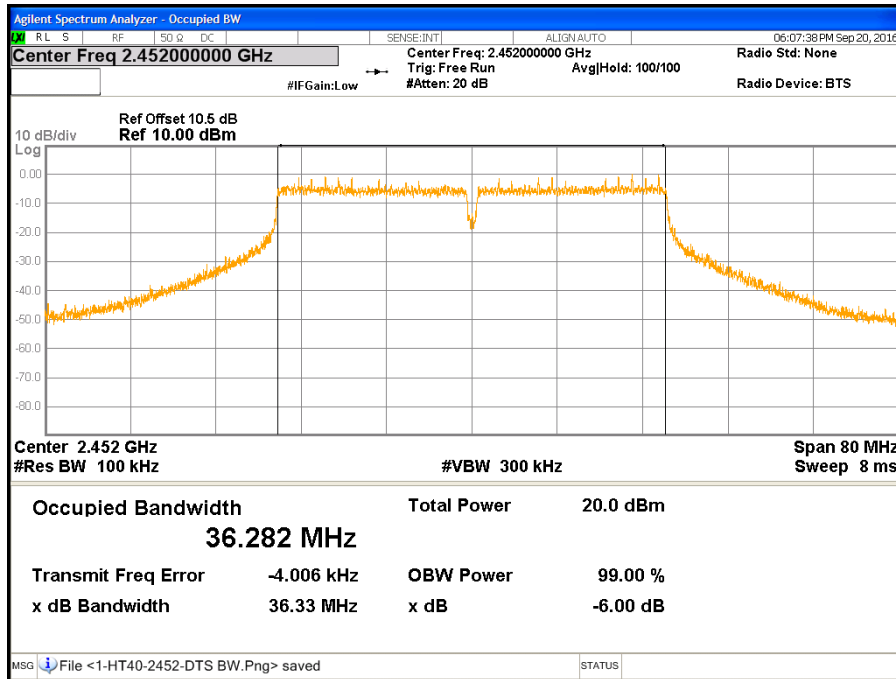

CH Low (IEEE 802.11gn HT40 MCS0 Mode / Chain 2)

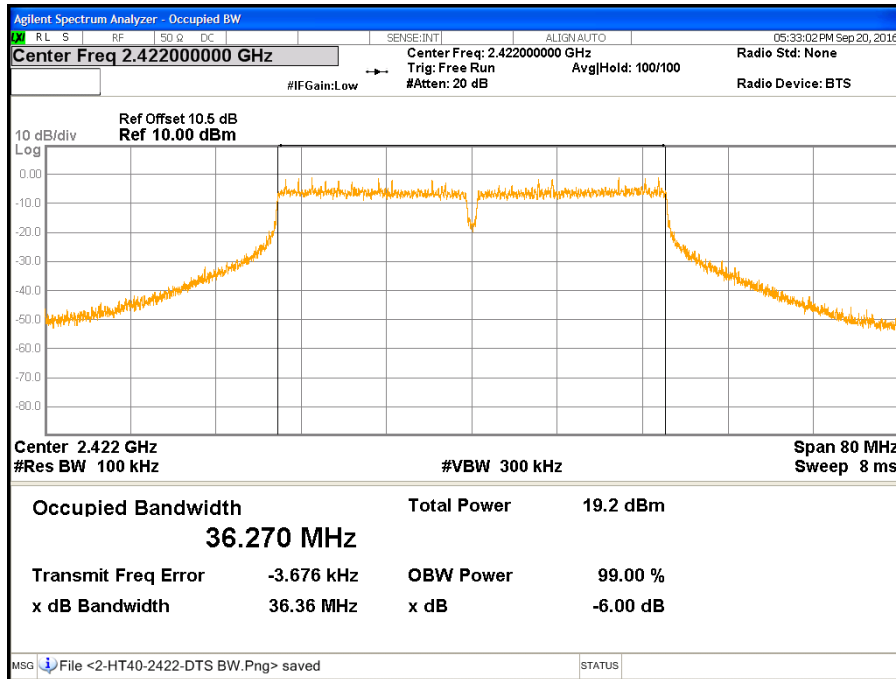

CH Middle (IEEE 802.11gn HT40 MCS0 Mode / Chain 2)

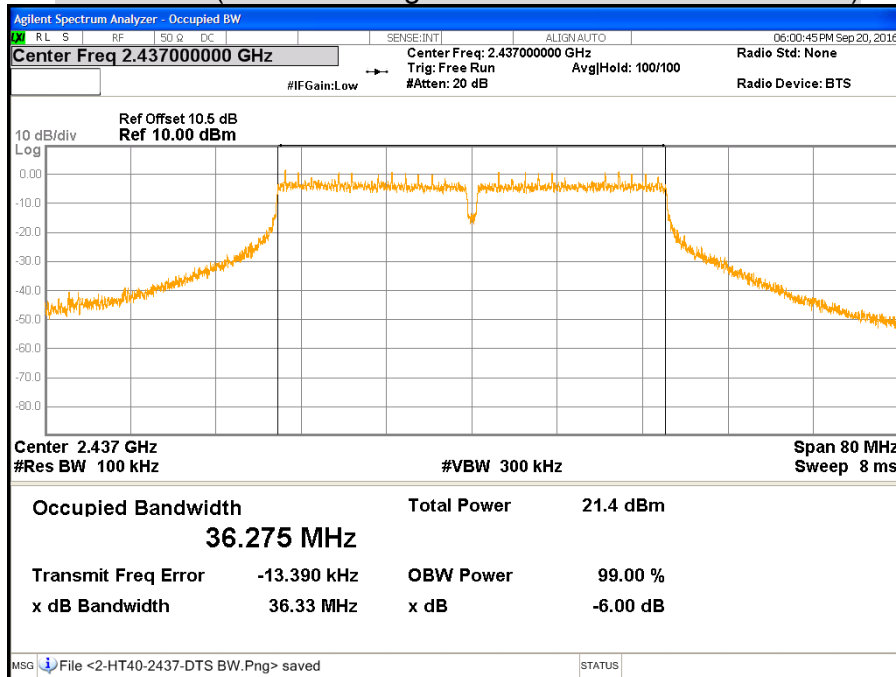

CH High (IEEE 802.11gn HT40 MCS0 Mode / Chain 2)

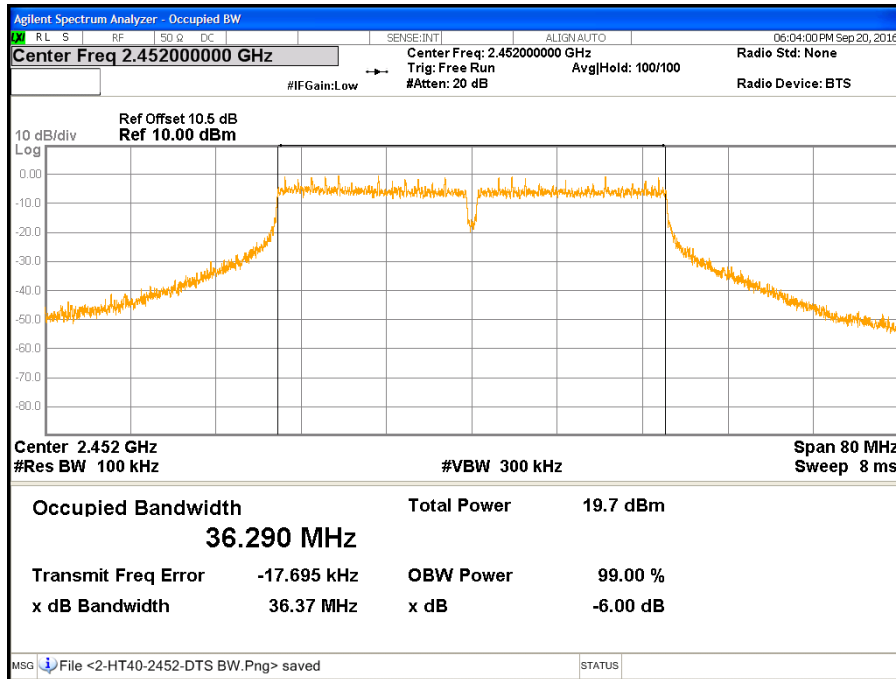

7.3 AVERAGE OUTPUT POWER

LIMITS

§ 15.247(b) The maximum peak output power of the intentional radiator shall not exceed the following:

§ 15.247(b) (3) For systems using digital modulation in the 902-928 MHz, 2400-2483.5 MHz, and 5725-5850 MHz bands: 1 watt.

§ 15.247(b) (4) Except as shown in paragraphs (c) of this section, if transmitting antennas of directional gain greater than 6 dBi are used the peak output power from the intentional radiator shall be reduced below the stated values in paragraphs (b)(1) or (b)(2), and (b)(3) of this section, as appropriate, by the amount in dB that the directional gain of the antenna exceeds 6 dBi.

§ KDB 662911:

If all antennas have the same gain, G_{ANT} , Directional gain = $G_{ANT} + \text{Array Gain}$, where Array Gain is as follows.

If antenna gains are not equal, the user may use either of the following methods to calculate directional gain, provided that each transmit antenna is driven by only one spatial stream:

Directional gain may be calculated by using the formulas applicable to equal gain antennas with G_{ANT} set equal to the gain of the antenna having the highest gain; or,

$$DirectionalGain = 10 \cdot \log \left[\frac{\sum_{j=1}^{N_{SS}} \left\{ \sum_{k=1}^{N_{ANT}} g_{j,k} \right\}^2}{N_{ANT}} \right]$$

TEST EQUIPMENT

Name of Equipment	Manufacturer	Model	Serial Number	Calibration Due
Power Meter	Anritsu	ML2495A	1149001	12/08/2016
Power Sensor	Anritsu	MA2411B	1126148	12/08/2016
Test S/W	N/A			

Remark: Each piece of equipment is scheduled for calibration once a year.

TEST SETUP

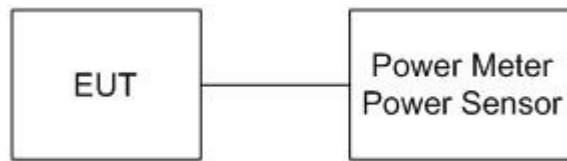

TEST PROCEDURE

The transmitter output is connected to the power meter. The power meter is set to the average power detection.

TEST RESULTS

Product Name	DOCSIS 3.1 wifi Gateway	Test By	Davis Tseng
Test Model	CODA-4782	Test Date	2016/09/20
Test Mode	TX Mode	Temp. & Humidity	26°C, 53%

IEEE 802.11b Mode (3TX)

Channel	Channel Frequency (MHz)	Average Output Power							Result
		Chain 0	Chain 1	Chain 2	Total		Limit		
		(dBm)	(dBm)	(dBm)	(dBm)	(W)	(dBm)	(W)	
Low	2412	18.30	18.26	18.41	23.10	0.2042	30.00	1.0000	PASS
Middle	2437	18.66	18.32	18.36	23.22	0.2099	30.00	1.0000	PASS
High	2462	18.43	18.11	17.89	22.92	0.1959	30.00	1.0000	PASS

Remark:

1. At final test to get the worst-case emission at 1Mbps.
2. The cable assembly insertion loss of 10.5 dB (including 10 dB pad and 0.5 dB cable) was entered as an offset in the power meter to allow for direct reading of power.
3. The maximum antenna gain is 4.28dBi which is less than 6dBi, the limit should be 1W.
4. Total power = Chain 0 + Chain 1 + Chain 2.

IEEE 802.11g Mode (3TX)

Channel	Channel Frequency (MHz)	Average Output Power							Result
		Chain 0	Chain 1	Chain 2	Total		Limit		
		(dBm)	(dBm)	(dBm)	(dBm)	(W)	(dBm)	(W)	
Low	2412	16.31	16.37	16.59	21.20	0.1318	30.00	1.0000	PASS
Middle	2437	19.37	19.53	19.71	24.31	0.2698	30.00	1.0000	PASS
High	2462	15.86	15.67	15.62	20.49	0.1119	30.00	1.0000	PASS

Remark:

1. At final test to get the worst-case emission at 6Mbps.
2. The cable assembly insertion loss of 10.5 dB (including 10 dB pad and 0.5 dB cable) was entered as an offset in the power meter to allow for direct reading of power.
3. The maximum antenna gain is 4.28dBi which is less than 6dBi, the limit should be 1W.
4. Total power = Chain 0 + Chain 1 + Chain 2.

IEEE 802.11gn HT20 MCS0 Mode (3TX)

Channel	Channel Frequency (MHz)	Average Output Power							Result
		Chain 0	Chain 1	Chain 2	Total		Limit		
		(dBm)	(dBm)	(dBm)	(dBm)	(W)	(dBm)	(W)	
Low	2412	14.43	13.98	14.41	19.05	0.0804	30.00	1.0000	PASS
Middle	2437	20.31	20.24	20.60	25.16	0.3281	30.00	1.0000	PASS
High	2462	13.31	13.72	13.66	18.34	0.0682	30.00	1.0000	PASS

Remark:

1. At final test to get the worst-case emission at 6.5Mbps.
2. The cable assembly insertion loss of 10.5 dB (including 10 dB pad and 0.5 dB cable) was entered as an offset in the power meter to allow for direct reading of power.
3. The maximum antenna gain is 4.28dBi which is less than 6dBi, the limit should be 1W.
4. Total power = Chain 0 + Chain 1 + Chain 2.

IEEE 802.11gn HT40 MCS0 Mode (3TX)

Channel	Channel Frequency (MHz)	Average Output Power							Result
		Chain 0	Chain 1	Chain 2	Total		Limit		
		(dBm)	(dBm)	(dBm)	(dBm)	(W)	(dBm)	(W)	
Low	2422	12.90	12.54	12.22	17.33	0.0541	30.00	1.0000	PASS
Middle	2437	16.41	16.01	15.86	20.87	0.1222	30.00	1.0000	PASS
High	2452	13.08	13.63	13.22	18.09	0.0644	30.00	1.0000	PASS

Remark:

1. At final test to get the worst-case emission at 13.5Mbps.
2. The cable assembly insertion loss of 10.5 dB (including 10 dB pad and 0.5 dB cable) was entered as an offset in the power meter to allow for direct reading of power.
3. The maximum antenna gain is 4.28dBi which is less than 6dBi, the limit should be 1W.
4. Total power = Chain 0 + Chain 1 + Chain 2.

7.4 POWER SPECTRAL DENSITY

LIMITS

§ 15.247(e) For digitally modulated systems, the power spectral density conducted from the intentional radiator to the antenna shall not greater than 8 dBm in any 3 kHz band during any time interval of continuous transmission.

§ KDB 662911:

If all antennas have the same gain, G_{ANT} , Directional gain = G_{ANT} + Array Gain, where Array Gain is as follows.

Array Gain = $10 \log(N_{ANT}/N_{SS})$ dB.

If antenna gains are not equal, the user may use either of the following methods to calculate directional gain, provided that each transmit antenna is driven by only one spatial stream:

Directional gain may be calculated by using the formulas applicable to equal gain antennas with G_{ANT} set equal to the gain of the antenna having the highest gain; or,

$$DirectionalGain = 10 \cdot \log \left[\frac{\sum_{j=1}^{N_{SS}} \left\{ \sum_{k=1}^{N_{ANT}} g_{j,k} \right\}^2}{N_{ANT}} \right]$$

TEST EQUIPMENT

Name of Equipment	Manufacturer	Model	Serial Number	Calibration Due
EXA Signal Analyzer	Agilent	N9010A	MY52220817	03/15/2017
Test S/W	N/A			

Remark: Each piece of equipment is scheduled for calibration once a year.

TEST SETUP

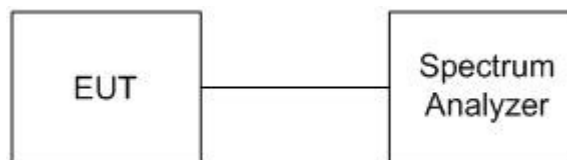

TEST PROCEDURE

1. The transmitter output was connected to the spectrum analyzer.
2. Set analyzer center frequency to DTS channel center frequency.
3. Set the span to 1.5 times the DTS channel bandwidth.
4. Set the RBW to: $3 \text{ kHz} \leq \text{RBW} \leq 100 \text{ kHz}$.
5. Set the VBW $\geq 3 \times \text{RBW}$.
6. Detector = peak.
7. Sweep time = auto couple.
8. Trace mode = max hold.
9. Allow trace to fully stabilize.
10. Use the peak marker function to determine the maximum amplitude level within the RBW.
11. If measured value exceeds limit, reduce RBW (no less than 3 kHz) and repeat.

TEST RESULTS

Product Name	DOCSIS 3.1 wifi Gateway	Test By	Davis Tseng
Test Model	CODA-4782	Test Date	2016/09/20
Test Mode	TX Mode	Temp. & Humidity	26°C, 53%

IEEE 802.11b Mode (3TX)

Channel	Channel Frequency (MHz)	Final RF Power Level in 3KHz BW (dBm)					Result
		Chain 0	Chain 1	Chain 2	Total	Limit	
Low	2412	0.19	-0.06	0.42	4.96	5.48	PASS
Middle	2437	0.83	0.81	0.25	5.41	5.48	PASS
High	2462	0.78	0.42	0.32	5.28	5.48	PASS

Remark:

1. At final test to get the worst-case emission at 1Mbps.
2. The cable assembly insertion loss of 10.5 dB (including 10 dB pad and 0.5 dB cable) was entered as an offset in the spectrum analyzer to allow for direct reading of power.
3. The directional gain is 8.52dBi which is more than 6dBi, the limit should be 5.48 dBm.
4. Total power spectral density = Chain 0 + Chain 1 + Chain 2.

IEEE 802.11g Mode (3TX)

Channel	Channel Frequency (MHz)	Final RF Power Level in 3KHz BW (dBm)					Result
		Chain 0	Chain 1	Chain 2	Total	Limit	
Low	2412	-2.15	-3.87	-3.03	1.81	5.48	PASS
Middle	2437	0.62	0.15	0.14	5.08	5.48	PASS
High	2462	-2.87	-3.51	-3.91	1.36	5.48	PASS

Remark:

1. At final test to get the worst-case emission at 6Mbps.
2. The cable assembly insertion loss of 10.5 dB (including 10 dB pad and 0.5 dB cable) was entered as an offset in the spectrum analyzer to allow for direct reading of power.
3. The directional gain is 8.52dBi which is more than 6dBi, the limit should be 5.48 dBm.
4. Total power spectral density = Chain 0 + Chain 1 + Chain 2.

IEEE 802.11gn HT20 MCS0 Mode (3TX)

Channel	Channel Frequency (MHz)	Final RF Power Level in 3KHz BW (dBm)					Result
		Chain 0	Chain 1	Chain 2	Total	Limit	
Low	2412	-4.80	-6.17	-5.34	-0.63	5.48	PASS
Middle	2437	-0.18	0.51	0.42	5.03	5.48	PASS
High	2462	-5.63	-5.73	-6.53	-1.17	5.48	PASS

Remark:

1. At final test to get the worst-case emission at 6.5Mbps.
2. The cable assembly insertion loss of 10.5 dB (including 10 dB pad and 0.5 dB cable) was entered as an offset in the spectrum analyzer to allow for direct reading of power.
3. The directional gain is 8.52dBi which is more than 6dBi, the limit should be 5.48 dBm.
4. Total power spectral density = Chain 0 + Chain 1 + Chain 2.

IEEE 802.11gn HT40 MCS0 Mode (3TX)

Channel	Channel Frequency (MHz)	Final RF Power Level in 3KHz BW (dBm)					Result
		Chain 0	Chain 1	Chain 2	Total	Limit	
Low	2412	-7.82	-9.99	-9.68	-4.28	5.48	PASS
Middle	2437	-6.78	-7.70	-7.87	-2.65	5.48	PASS
High	2462	-8.83	-8.41	-9.11	-4.00	5.48	PASS

Remark:

1. At final test to get the worst-case emission at 13.5Mbps.
2. The cable assembly insertion loss of 10.5 dB (including 10 dB pad and 0.5 dB cable) was entered as an offset in the spectrum analyzer to allow for direct reading of power.
3. The directional gain is 8.52dBi which is more than 6dBi, the limit should be 5.48 dBm.
4. Total power spectral density = Chain 0 + Chain 1 + Chain 2.

POWER SPECTRAL DENSITY

CH Low (IEEE 802.11b Mode / Chain 0)

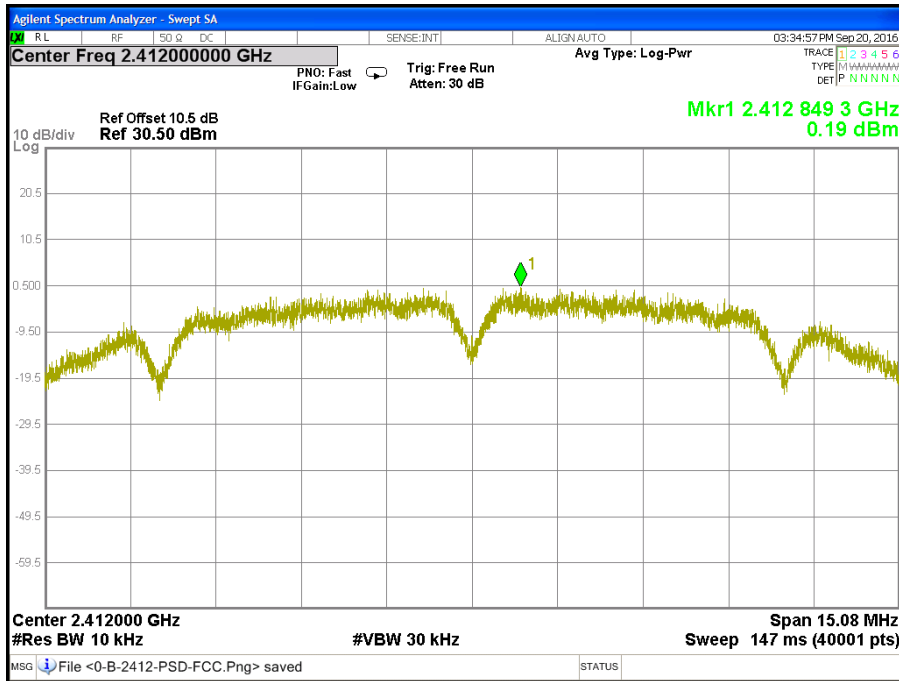

CH Middle (IEEE 802.11b Mode / Chain 0)

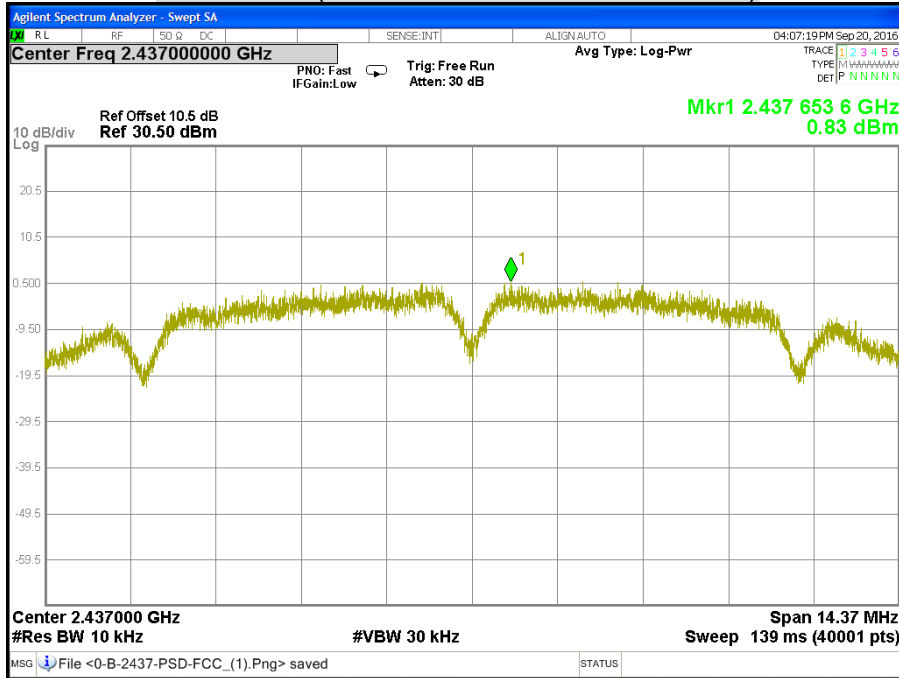

CH High (IEEE 802.11b Mode / Chain 0)

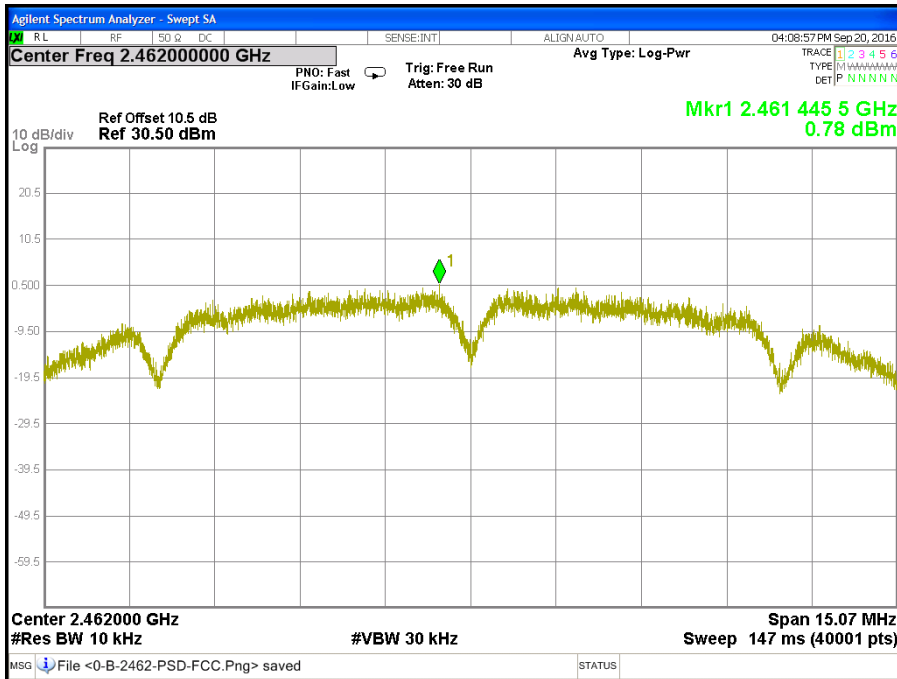

CH Low (IEEE 802.11b Mode / Chain 1)

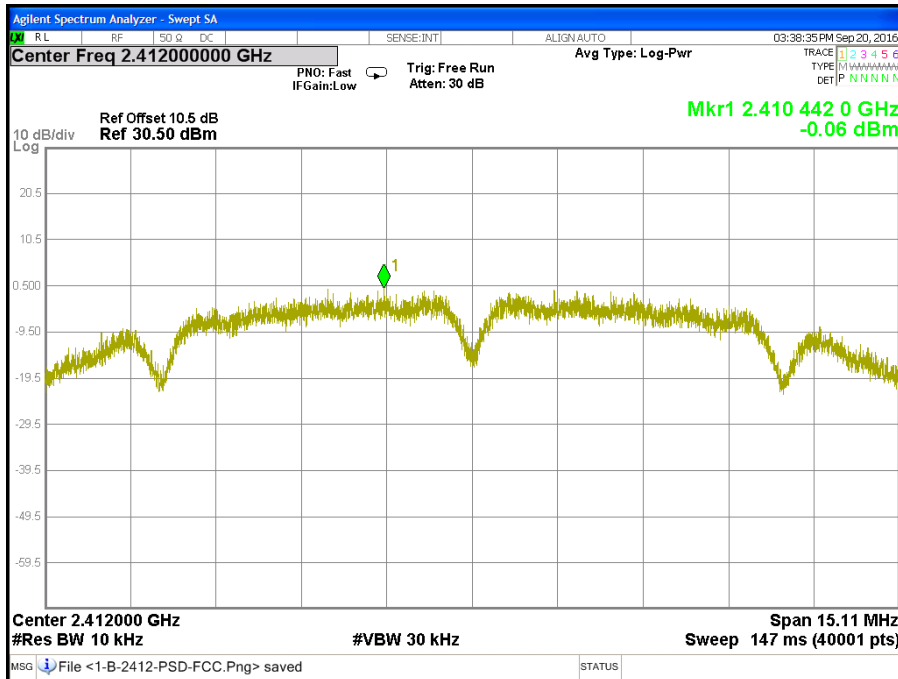

CH Middle (IEEE 802.11b Mode / Chain 1)

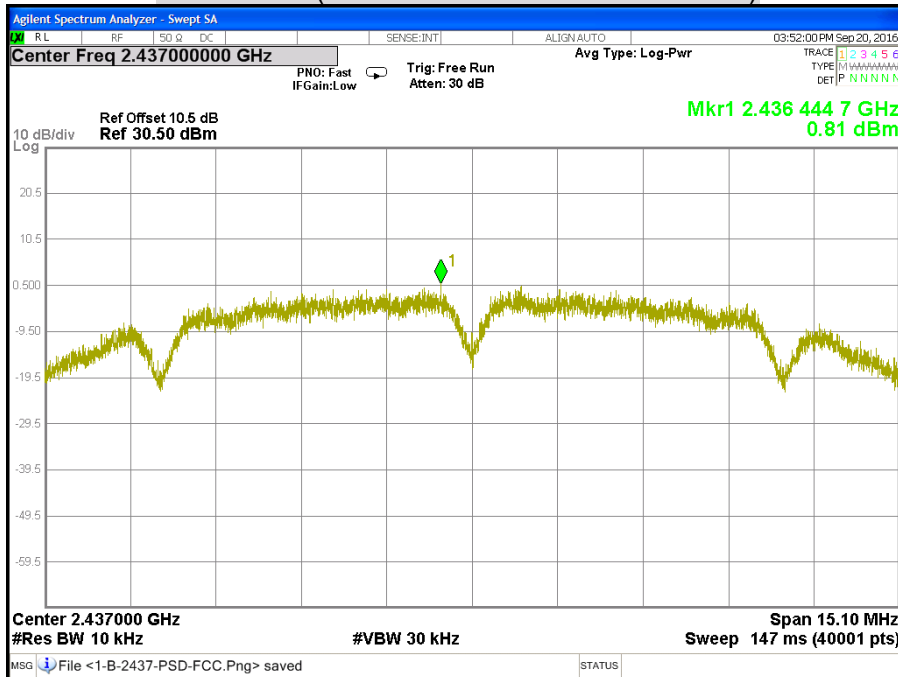

CH High (IEEE 802.11b Mode / Chain 1)

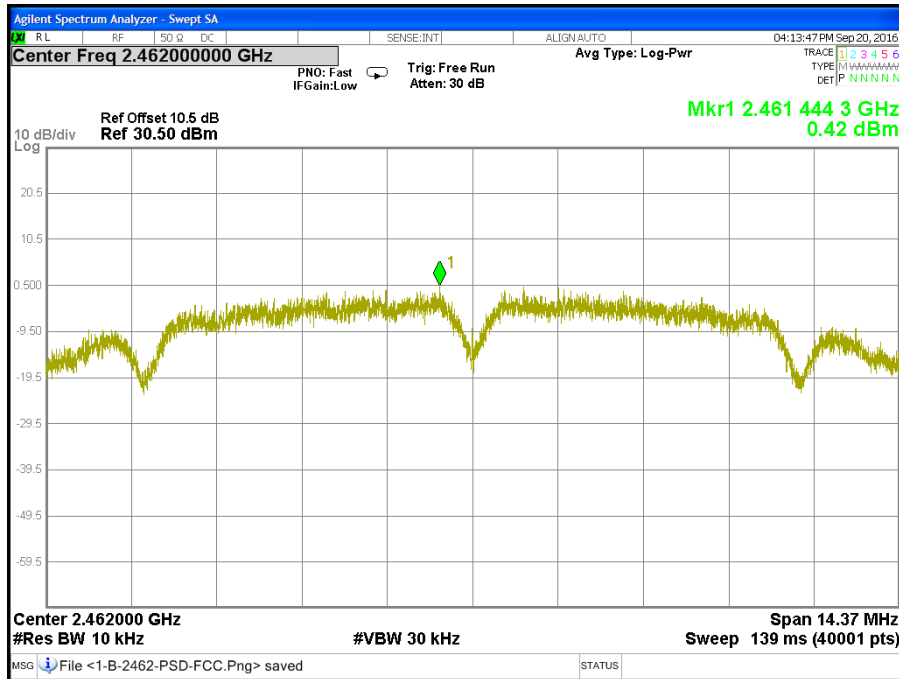

CH Low (IEEE 802.11b Mode / Chain 2)

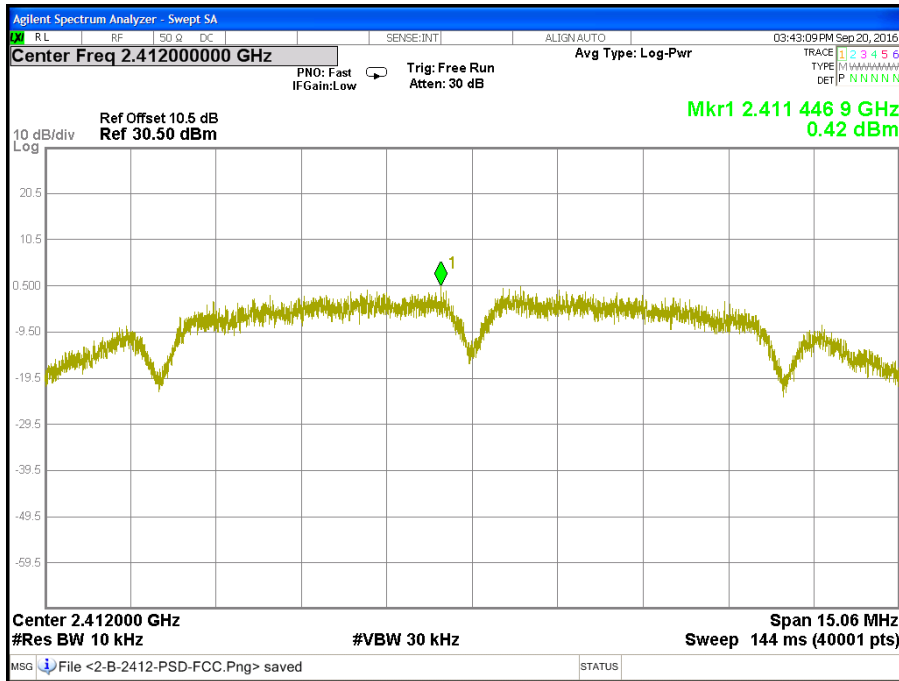

CH Middle (IEEE 802.11b Mode / Chain 2)

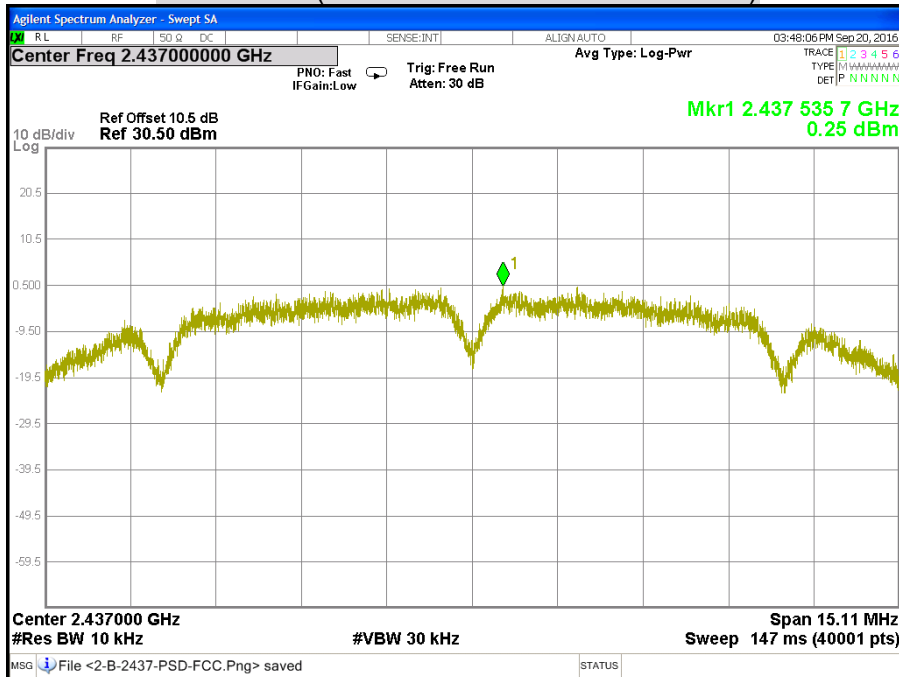

CH High (IEEE 802.11b Mode / Chain 2)

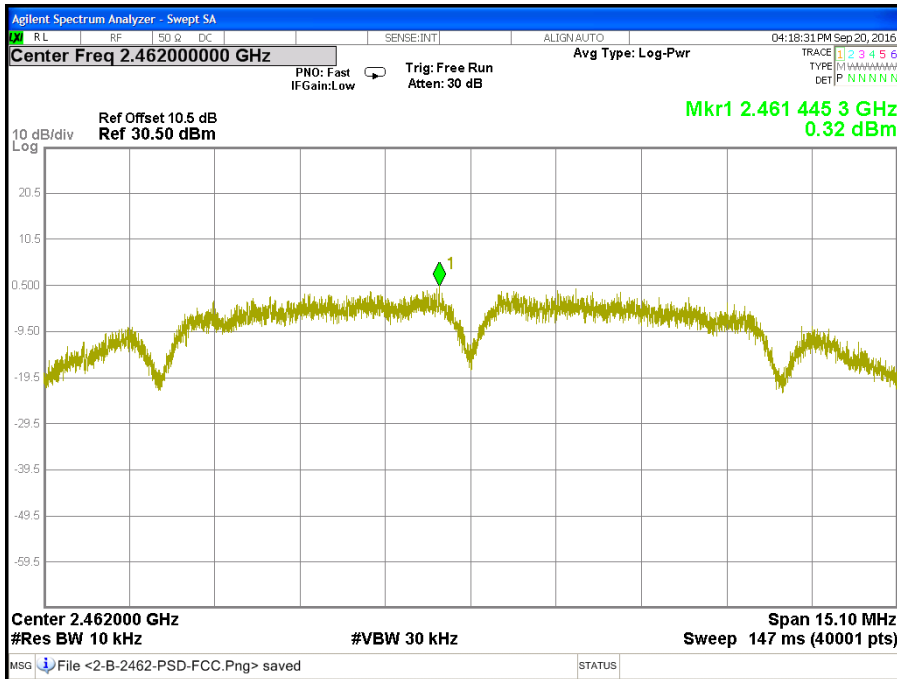

CH Low (IEEE 802.11g Mode / Chain 0)

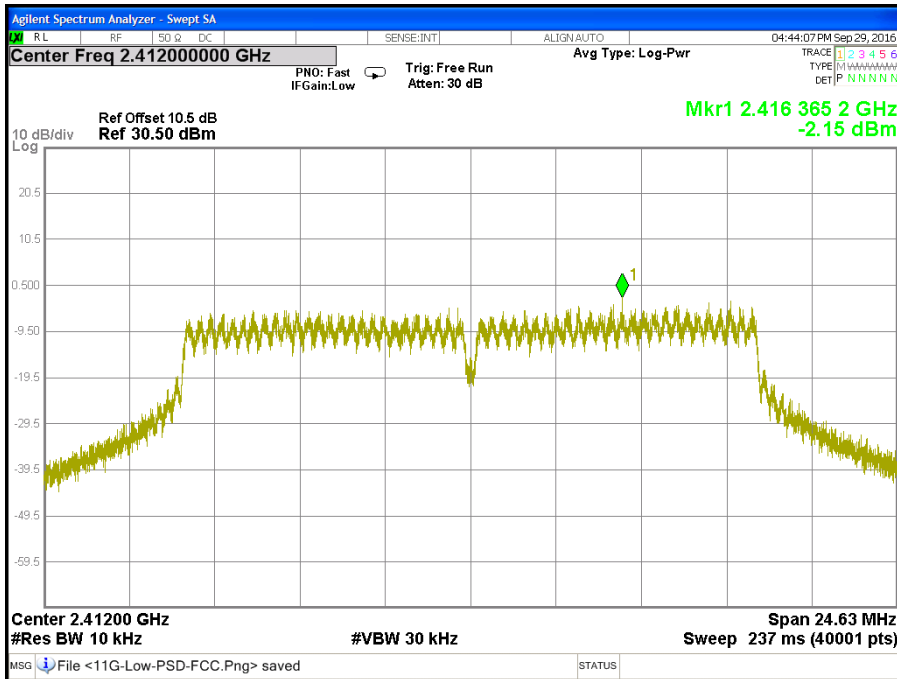

CH Middle (IEEE 802.11g Mode / Chain 0)

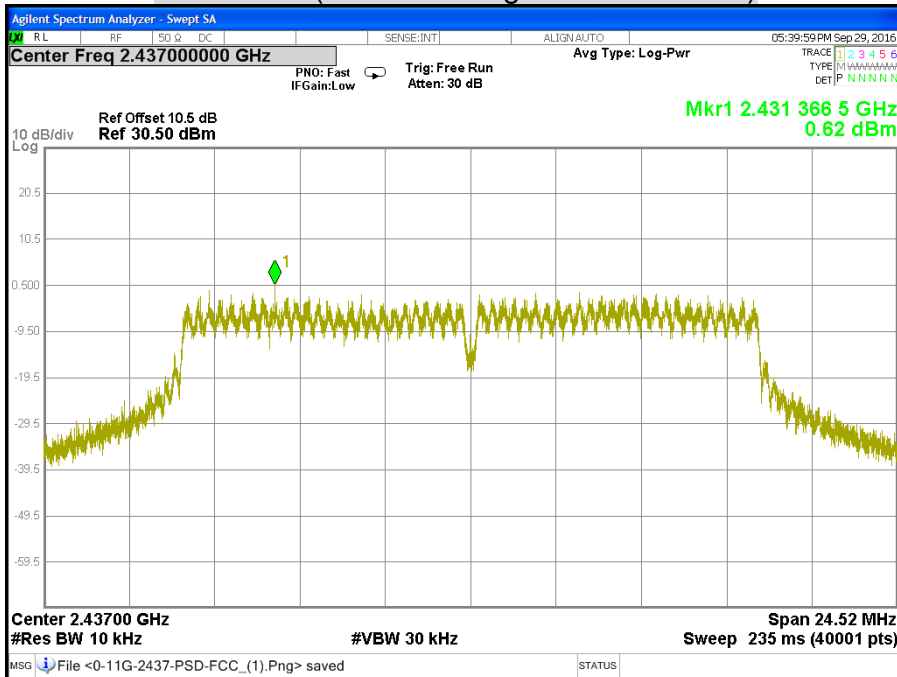

CH High (IEEE 802.11g Mode / Chain 0)

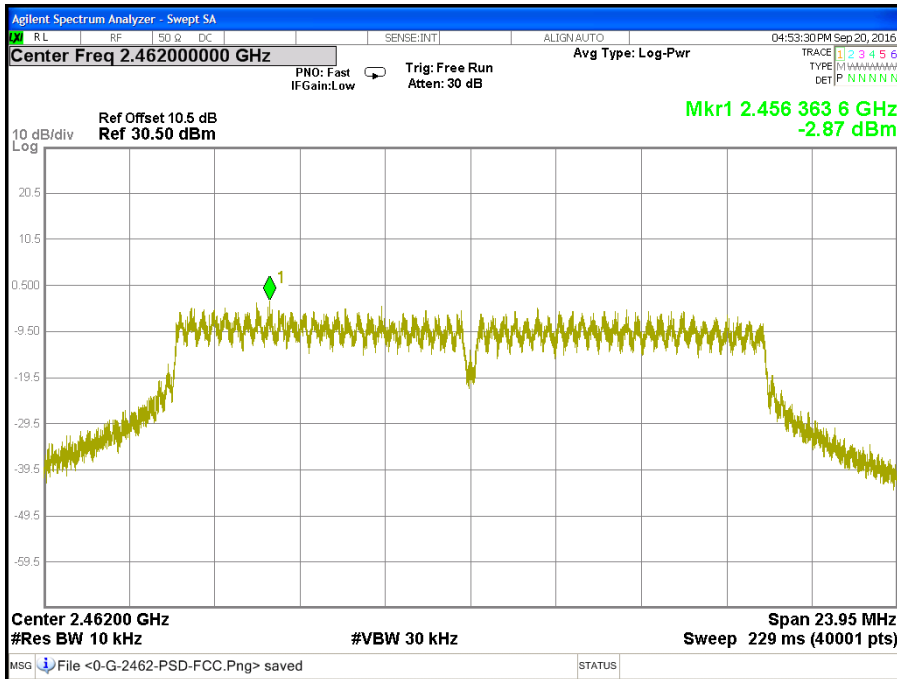

CH Low (IEEE 802.11g Mode / Chain 1)

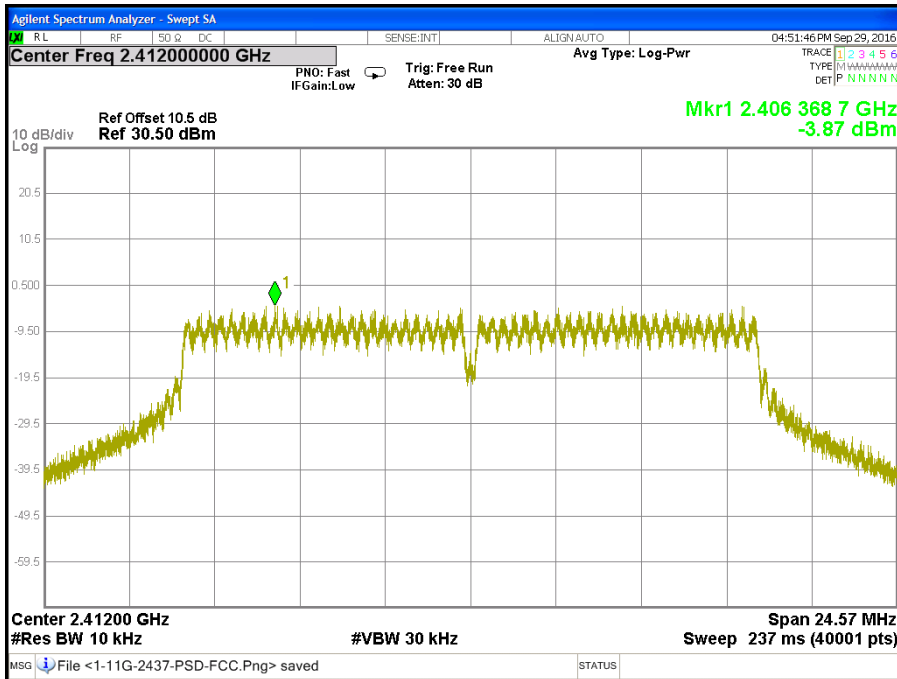

CH Middle (IEEE 802.11g Mode / Chain 1)

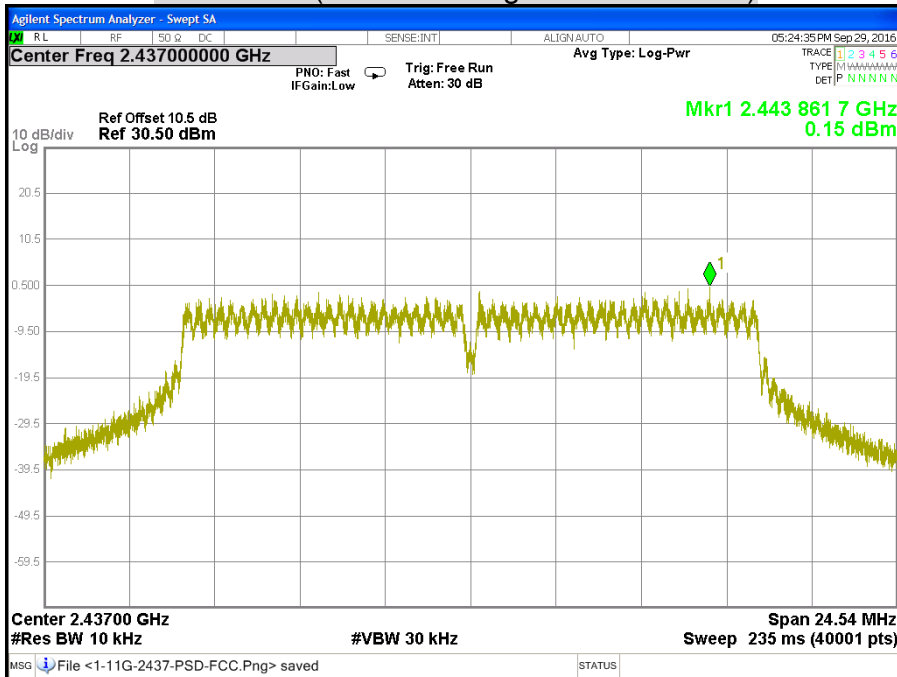

CH High (IEEE 802.11g Mode / Chain 1)

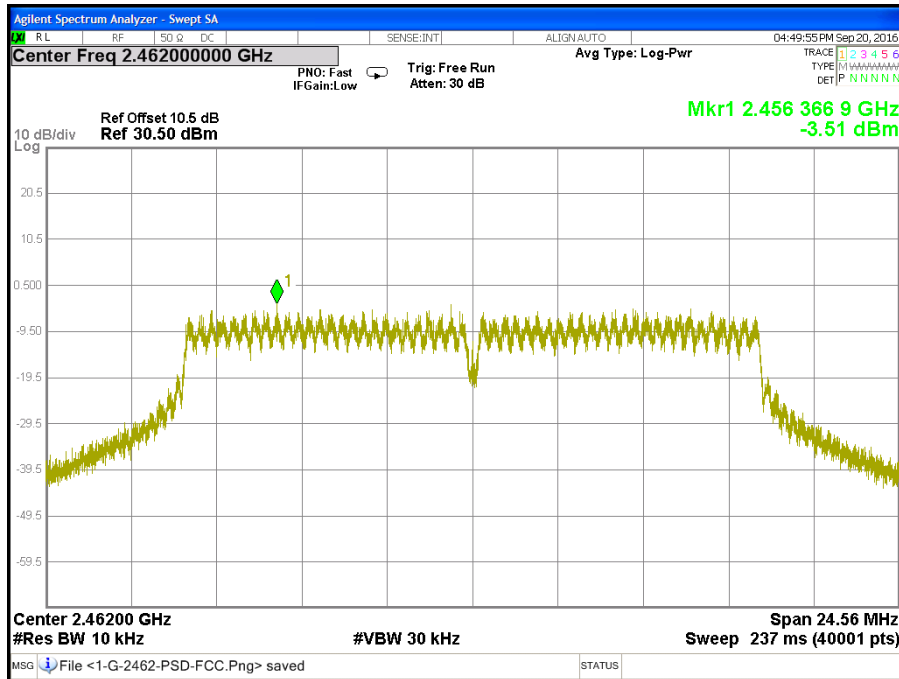

CH Low (IEEE 802.11g Mode / Chain 2)

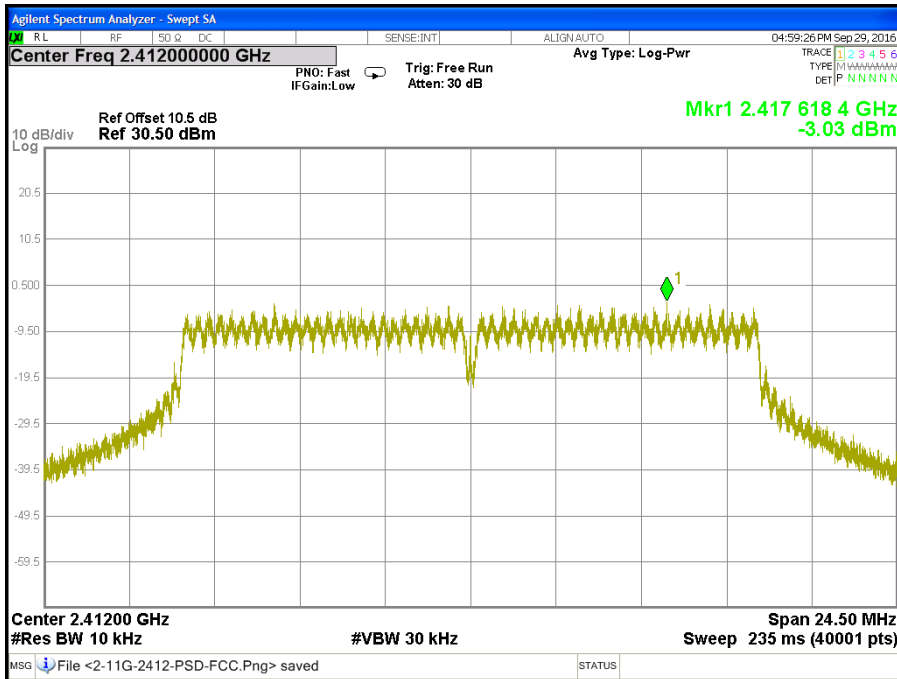

CH Middle (IEEE 802.11g Mode / Chain 2)

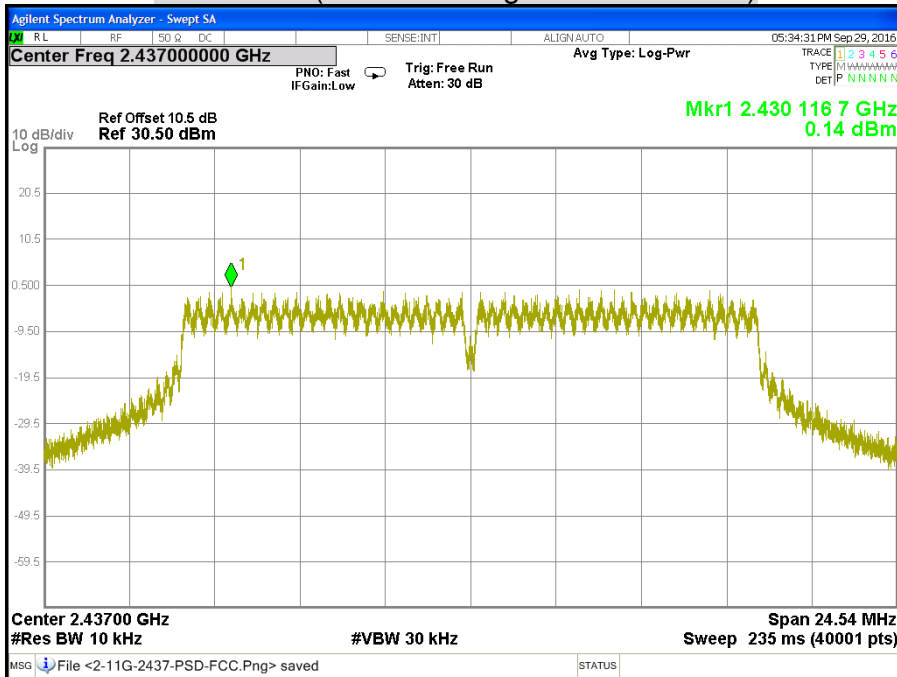

CH High (IEEE 802.11g Mode / Chain 2)

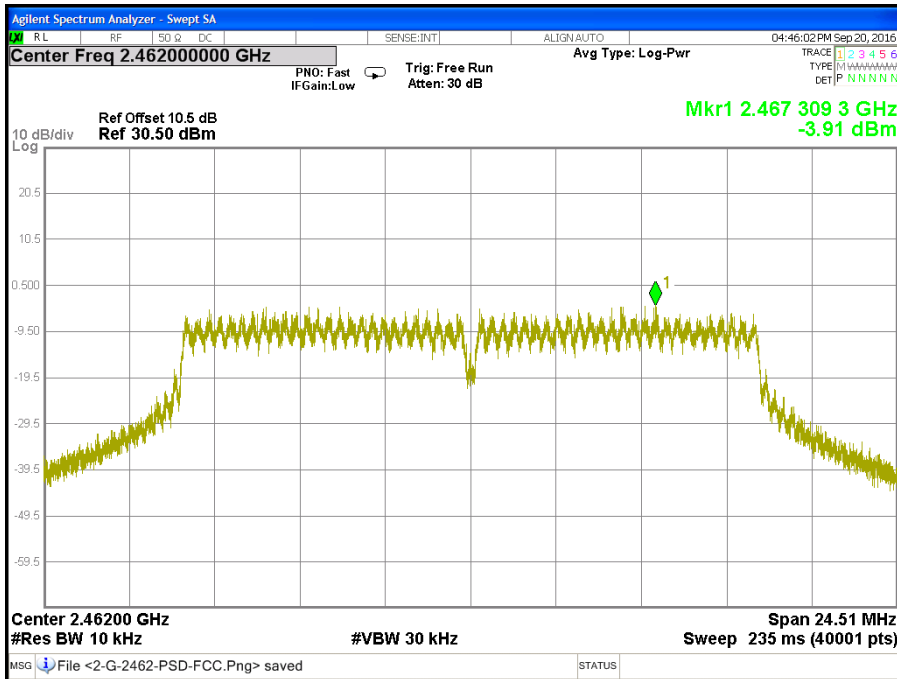

CH Low (IEEE 802.11gn HT20 MCS0 Mode / Chain 0)

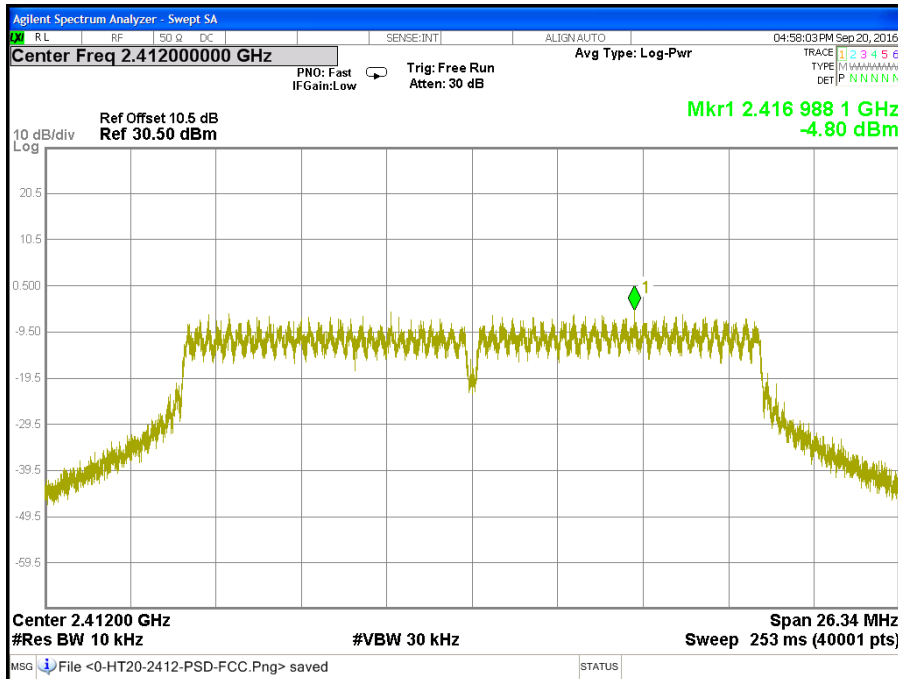

CH Middle (IEEE 802.11gn HT20 MCS0 Mode / Chain 0)

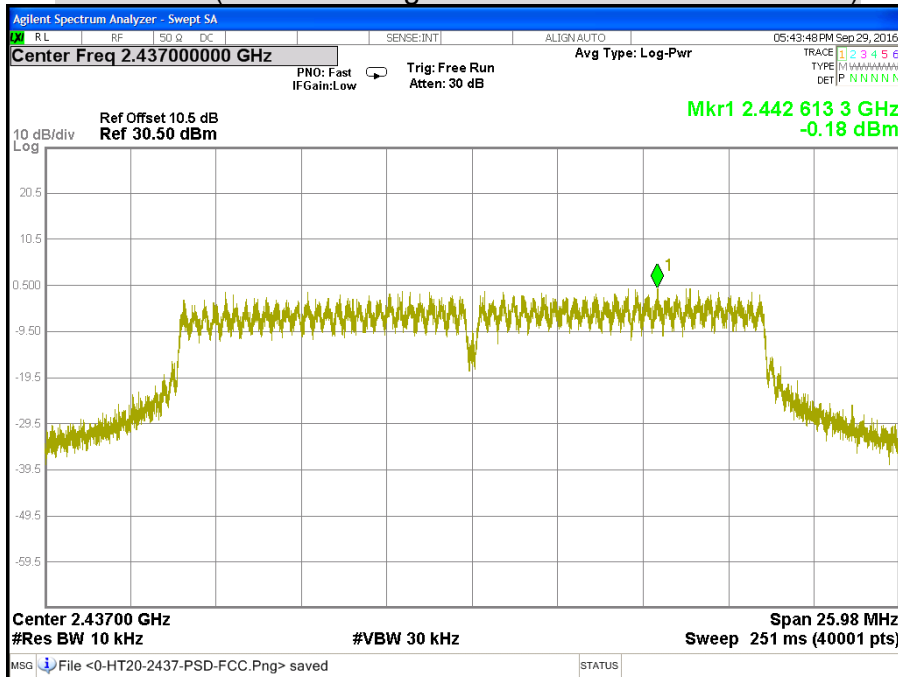

CH High (IEEE 802.11gn HT20 MCS0 Mode / Chain 0)

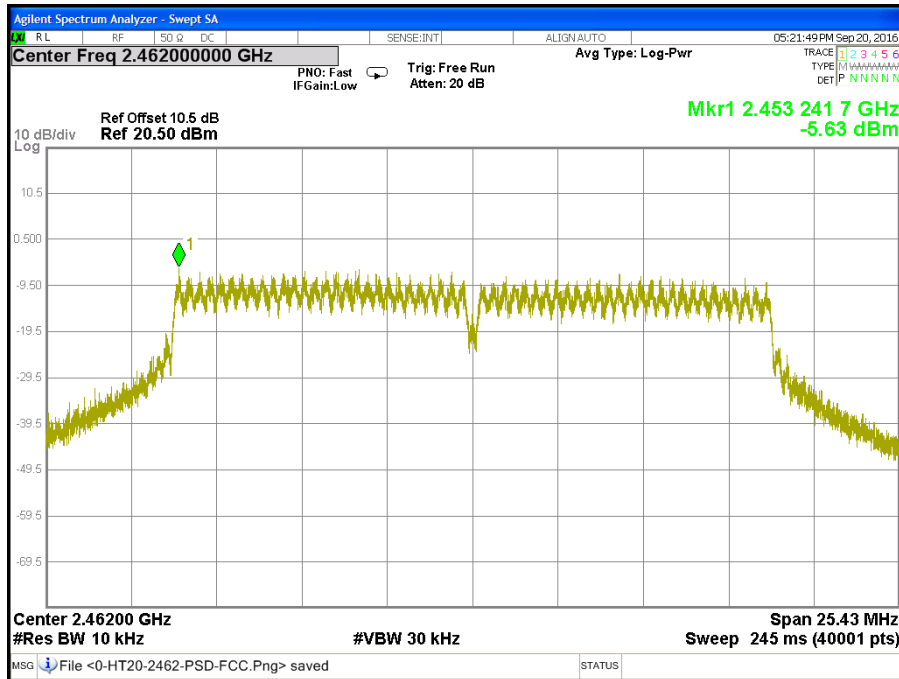

CH Low (IEEE 802.11gn HT20 MCS0 Mode / Chain 1)

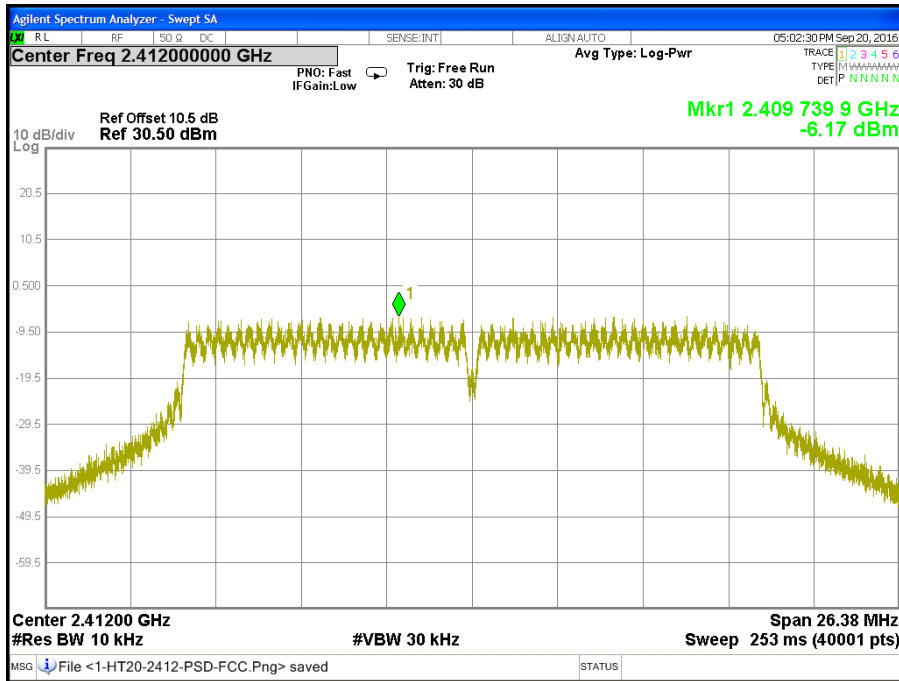

CH Middle (IEEE 802.11gn HT20 MCS0 Mode / Chain 1)

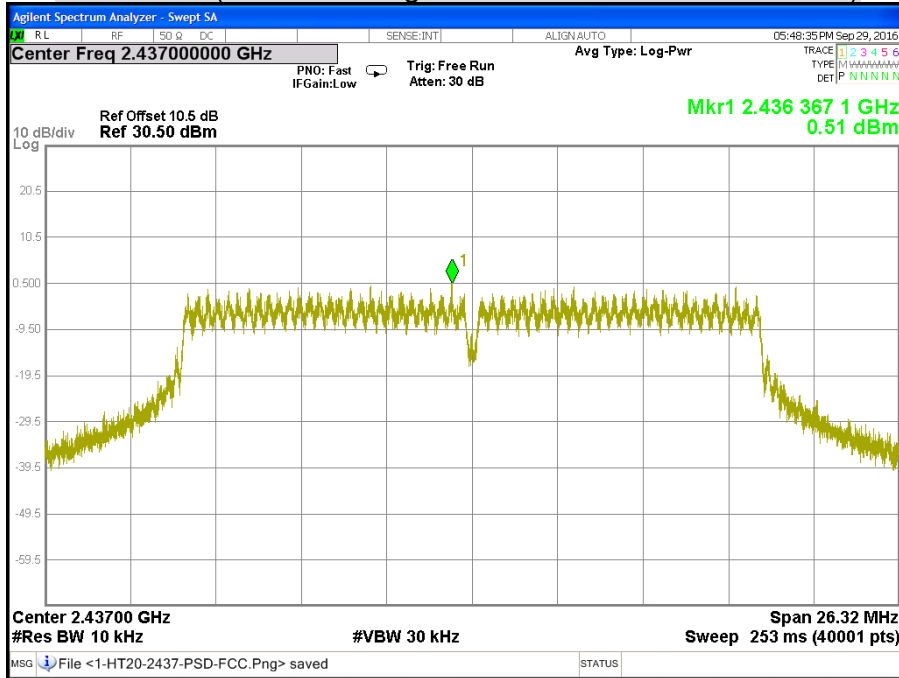

CH High (IEEE 802.11gn HT20 MCS0 Mode / Chain 1)

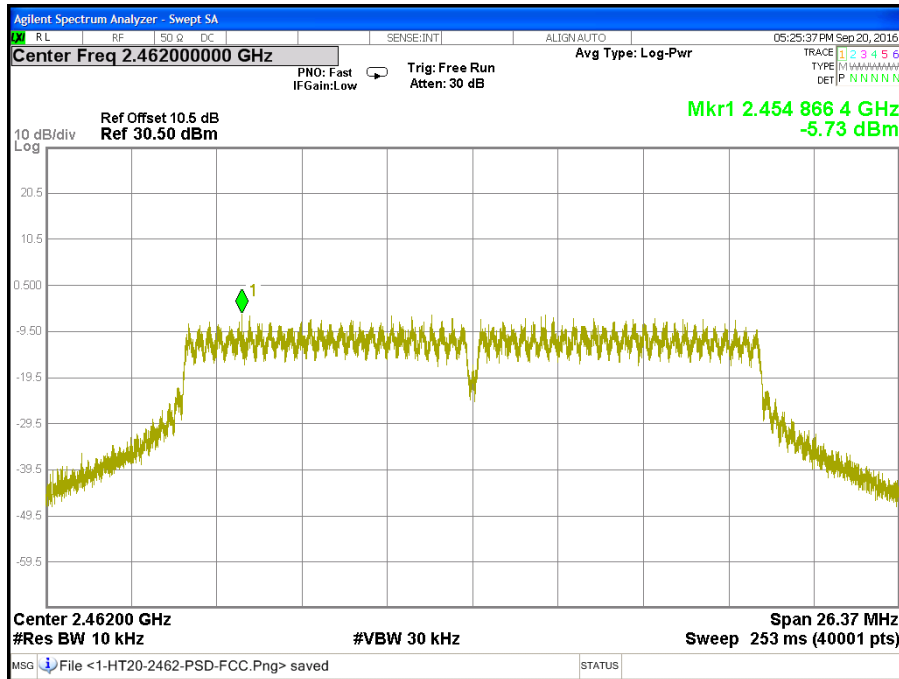

CH Low (IEEE 802.11gn HT20 MCS0 Mode / Chain 2)

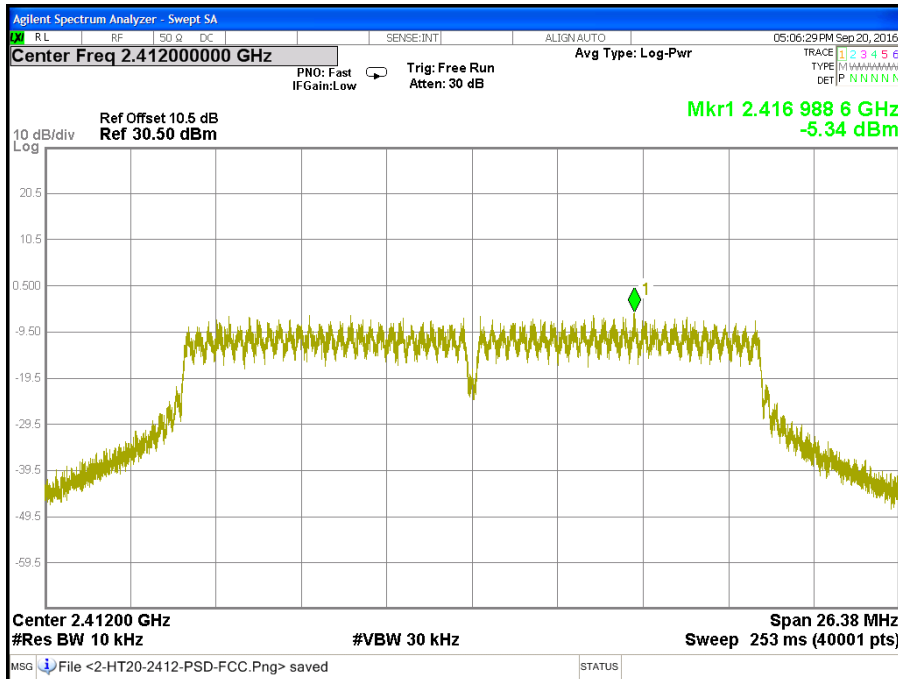

CH Middle (IEEE 802.11gn HT20 MCS0 Mode / Chain 2)

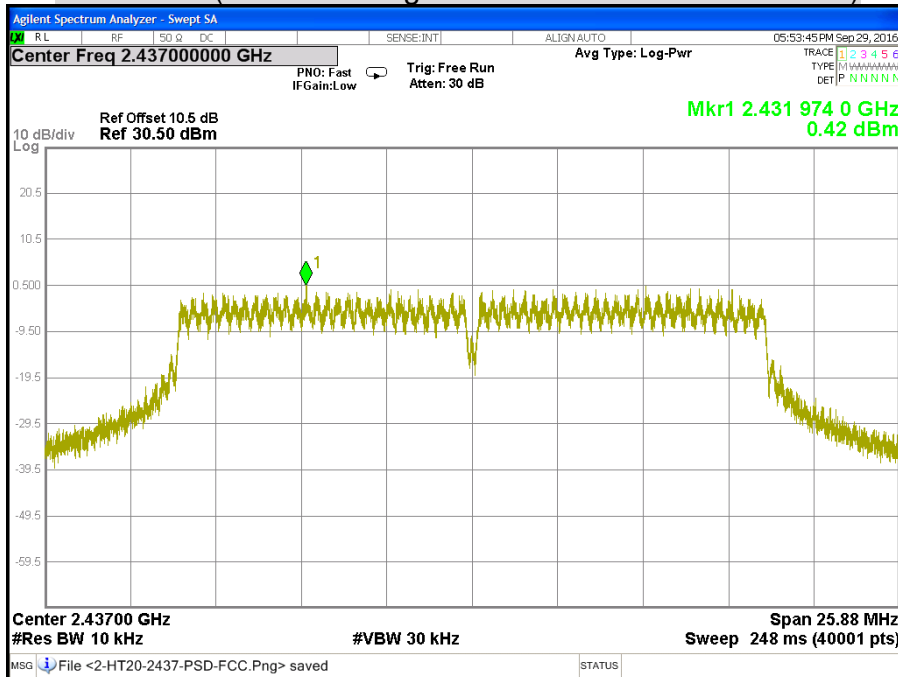

CH High (IEEE 802.11gn HT20 MCS0 Mode / Chain 2)

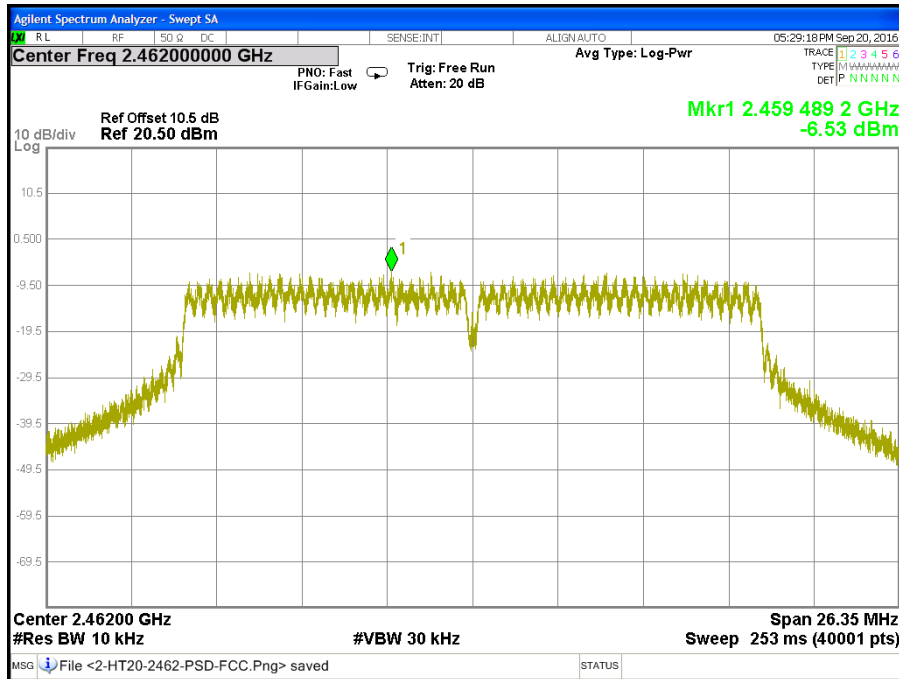

CH Low (IEEE 802.11gn HT40 MCS0 Mode / Chain 0)

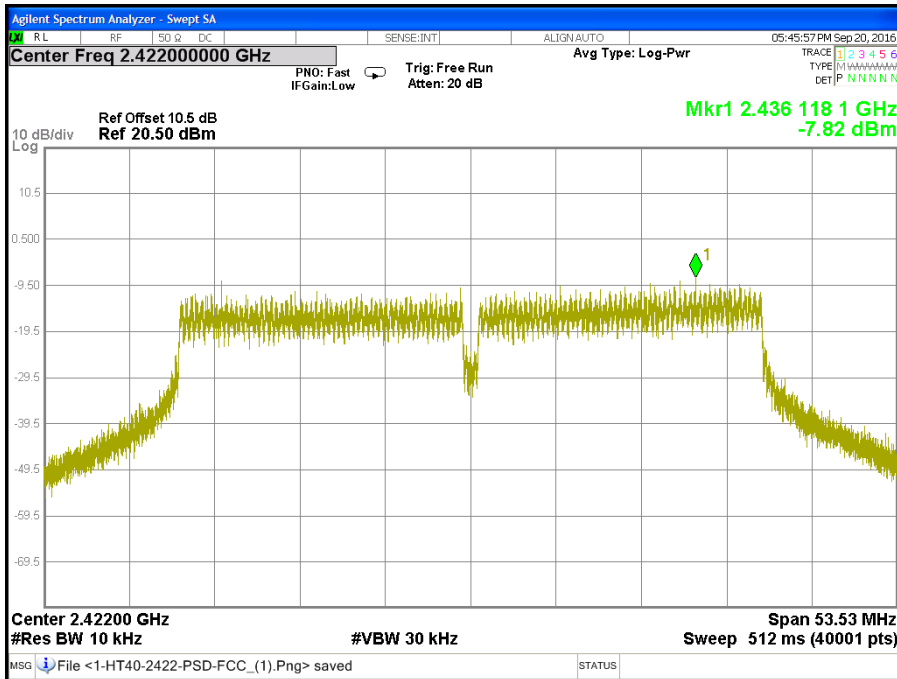

CH Middle (IEEE 802.11gn HT40 MCS0 Mode / Chain 0)

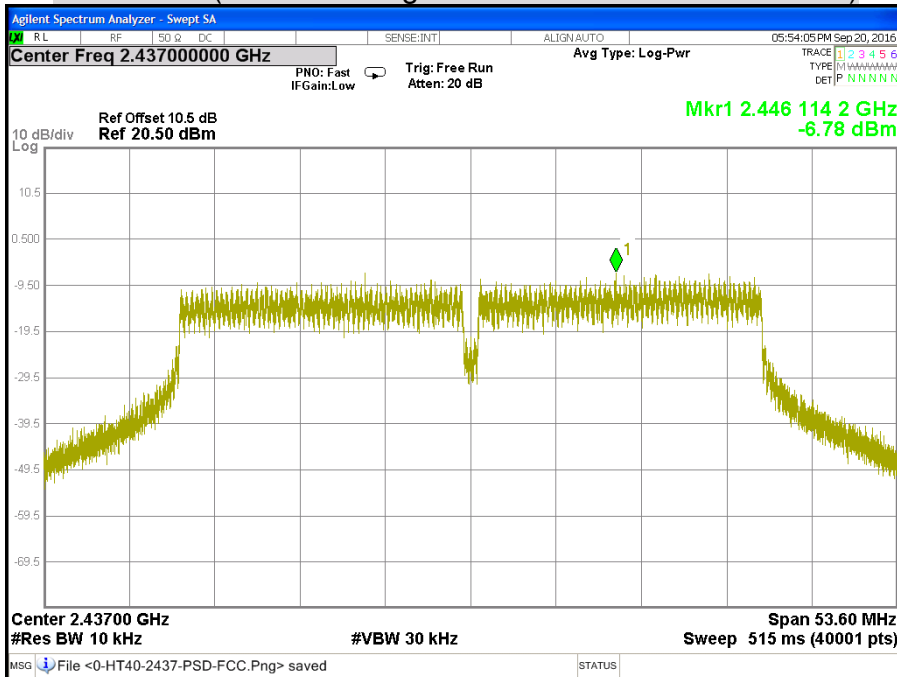

CH High (IEEE 802.11gn HT40 MCS0 Mode / Chain 0)

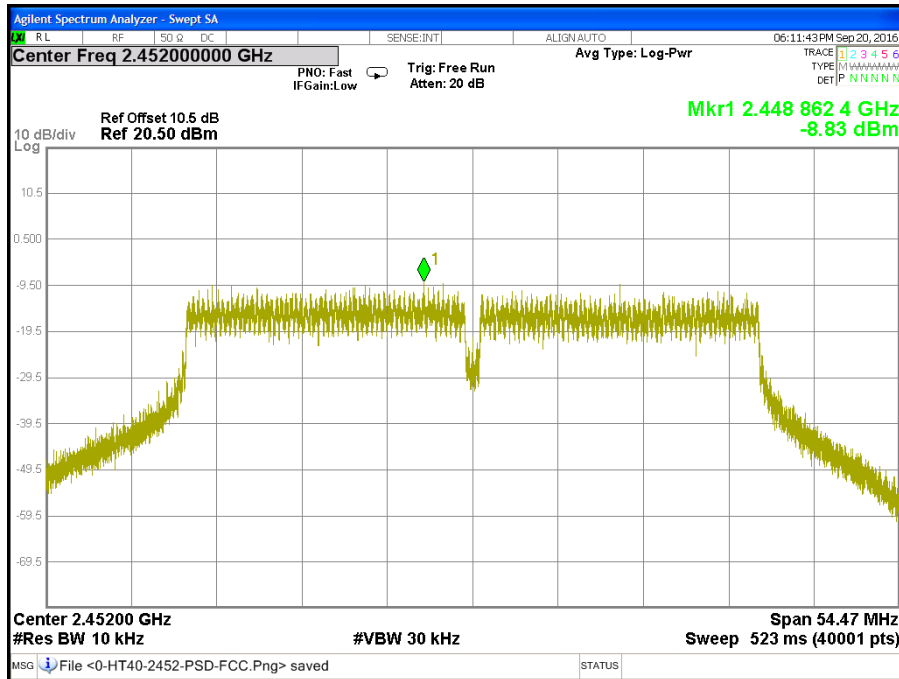

CH Low (IEEE 802.11gn HT40 MCS0 Mode / Chain 1)

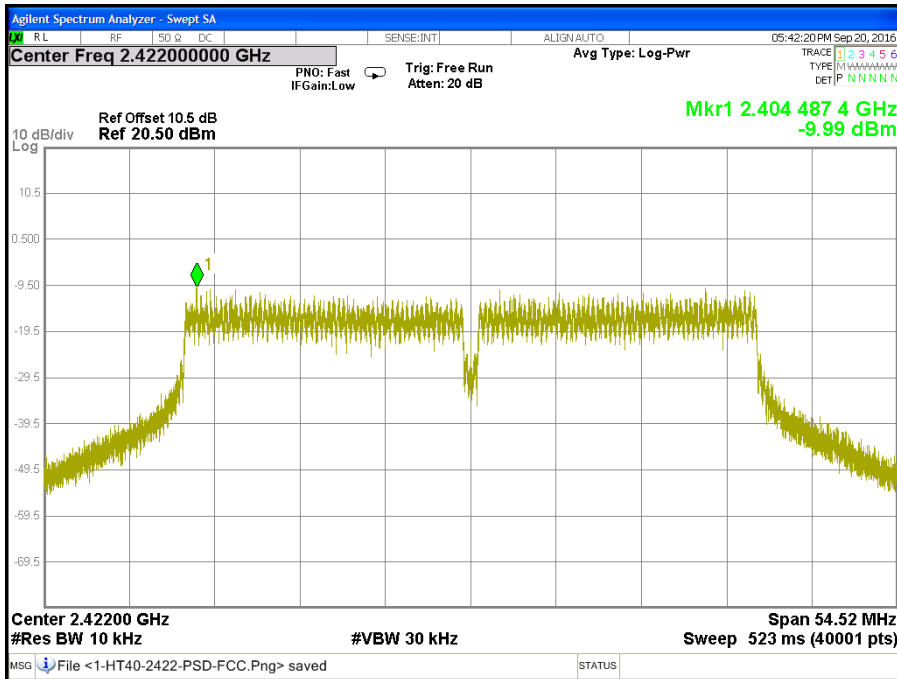

CH Middle (IEEE 802.11gn HT40 MCS0 Mode / Chain 1)

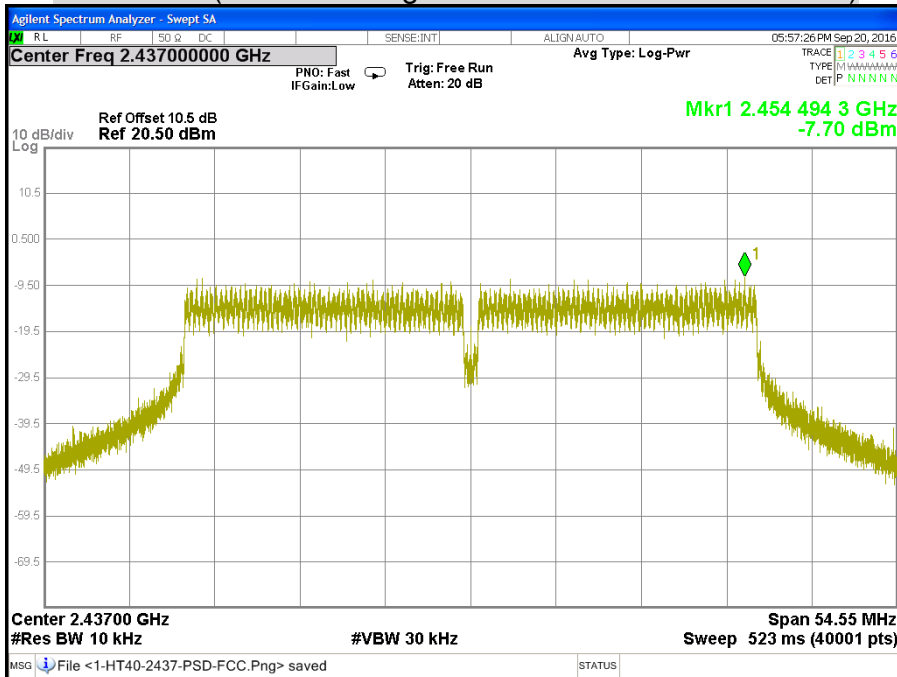

CH High (IEEE 802.11gn HT40 MCS0 Mode / Chain 1)

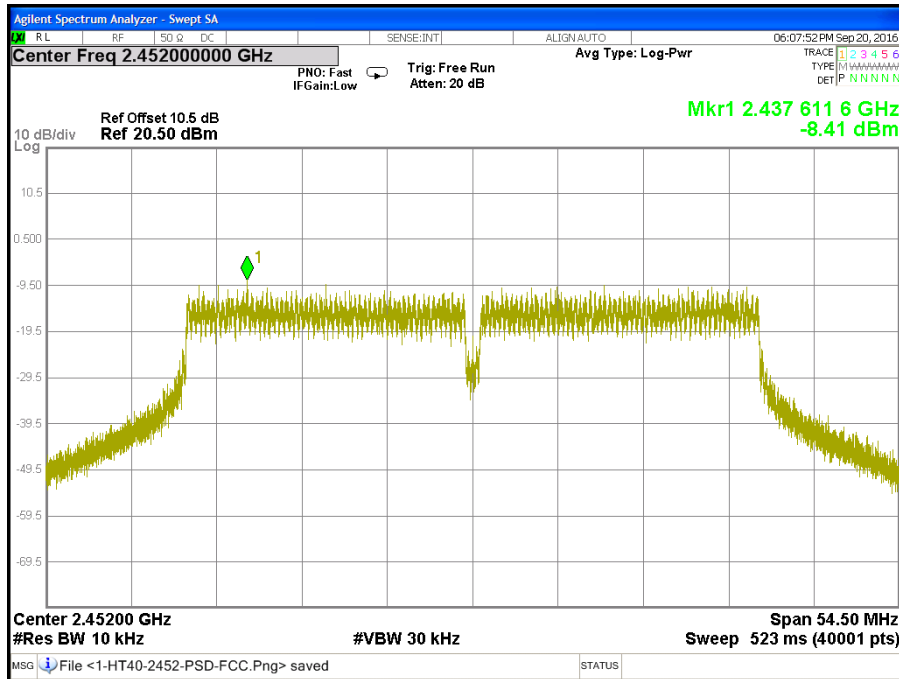

CH Low (IEEE 802.11gn HT40 MCS0 Mode / Chain 2)

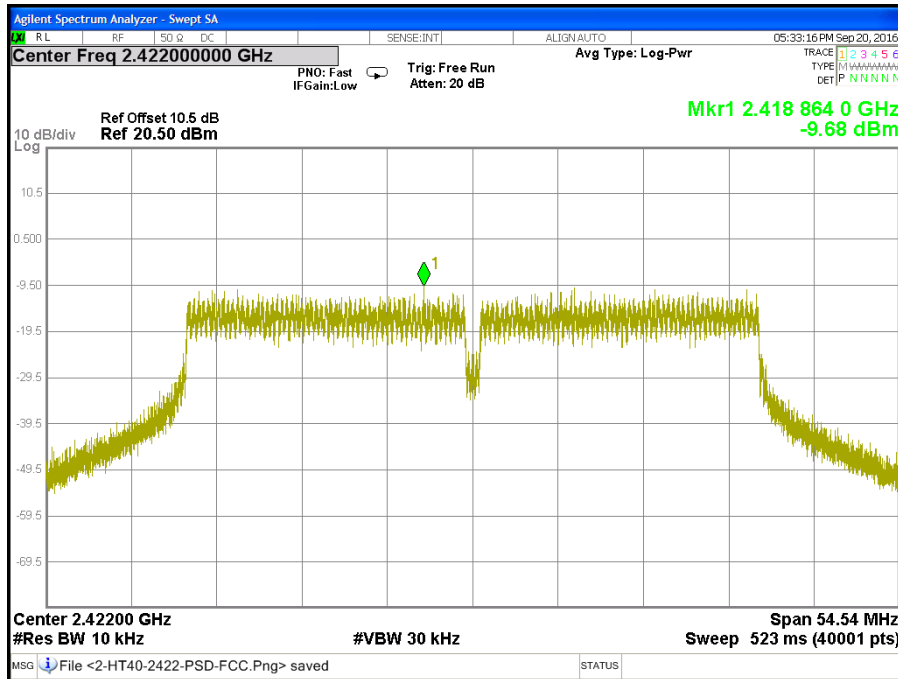

CH Middle (IEEE 802.11gn HT40 MCS0 Mode / Chain 2)

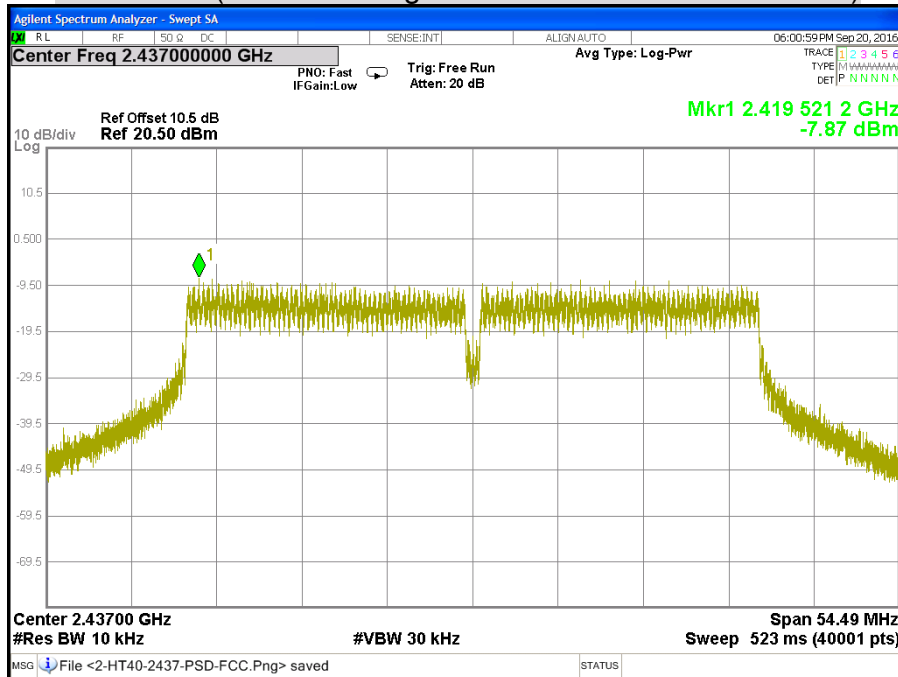

CH High (IEEE 802.11gn HT40 MCS0 Mode / Chain 2)

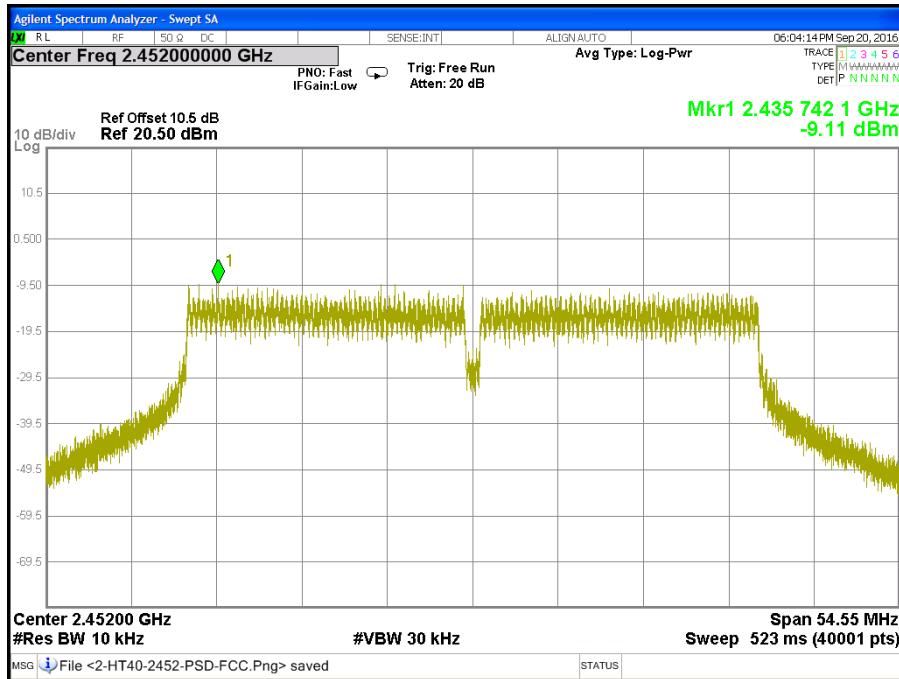

7.5 CONDUCTED SPURIOUS EMISSION

LIMITS

§ 15.247(d) In any 100 kHz bandwidth outside the frequency band in which the spread spectrum or digitally modulated intentional radiator is operating, the radio frequency power that is produced by the intentional radiator shall be at least 20 dB below that in the 100 kHz bandwidth within the band that contains the highest level of the desired power, based on either an RF conducted or a radiated measurement, provided the transmitter demonstrates compliance with the peak conducted power limits. If the transmitter complies with the conducted power limits based on the use of RMS averaging over a time interval, as permitted under paragraph (b)(3) of this section, the attenuation required under this paragraph shall be 30 dB instead of 20 dB. Attenuation below the general limits specified in §15.209(a) is not required. In addition, radiated emissions which fall in the restricted bands, as defined in §15.205(a), must also comply with the radiated emission limits specified in §15.209(a) (see §15.205(c)).

TEST EQUIPMENT

Name of Equipment	Manufacturer	Model	Serial Number	Calibration Due
EXA Signal Analyzer	Agilent	N9010A	MY52220817	03/15/2017
Test S/W	N/A			

Remark: Each piece of equipment is scheduled for calibration once a year.

TEST SETUP



TEST PROCEDURE

The transmitter output is connected to a spectrum analyzer. The resolution bandwidth is set to 100 kHz. The video bandwidth is set to 300 kHz.

The spectrum from 30 MHz to 26.5 GHz is investigated with the transmitter set to the lowest, middle, and highest channels in the 2.4 GHz band.

TEST RESULTS

Product Name	DOCSIS 3.1 wifi Gateway	Test By	Davis Tseng
Test Model	CODA-4782	Test Date	2016/09/20
Test Mode	TX Mode	Temp. & Humidity	26°C, 53%

OUT-OF-BAND SPURIOUS EMISSIONS-CONDUCTED MEASUREMENT

CH Low (2.38GHz ~ 2.5GHz / IEEE 802.11b Mode / Chain 0)

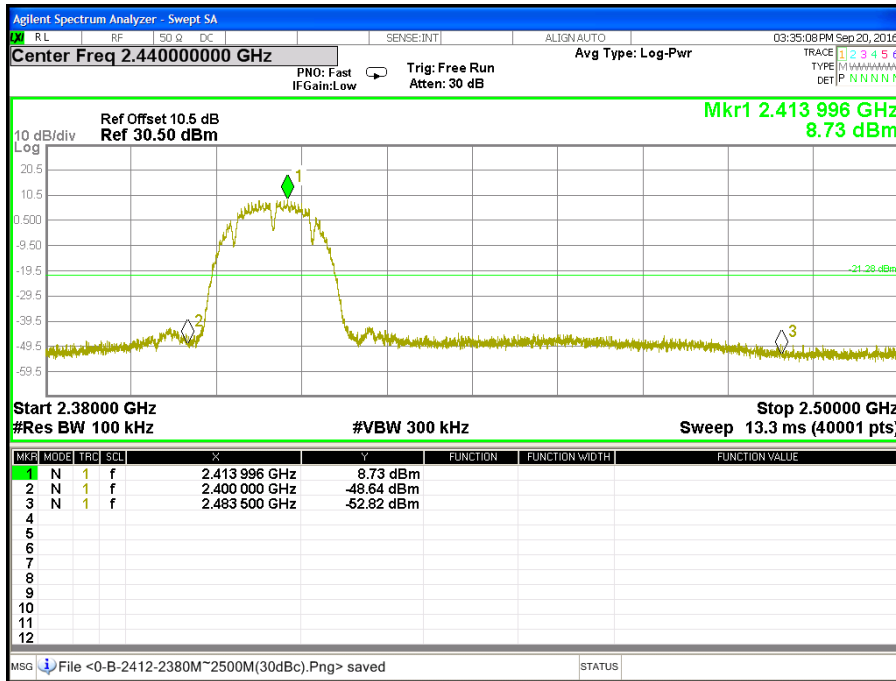

CH Low (30MHz ~ 26.5GHz / IEEE 802.11b Mode / Chain 0)

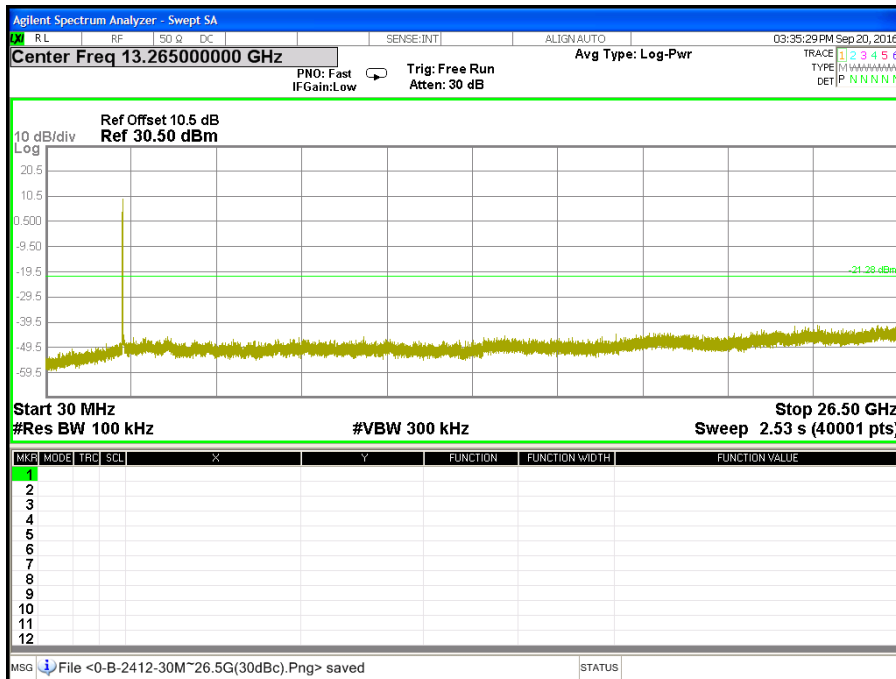

CH Middle (2.38GHz ~ 2.5GHz / IEEE 802.11b Mode / Chain 0)

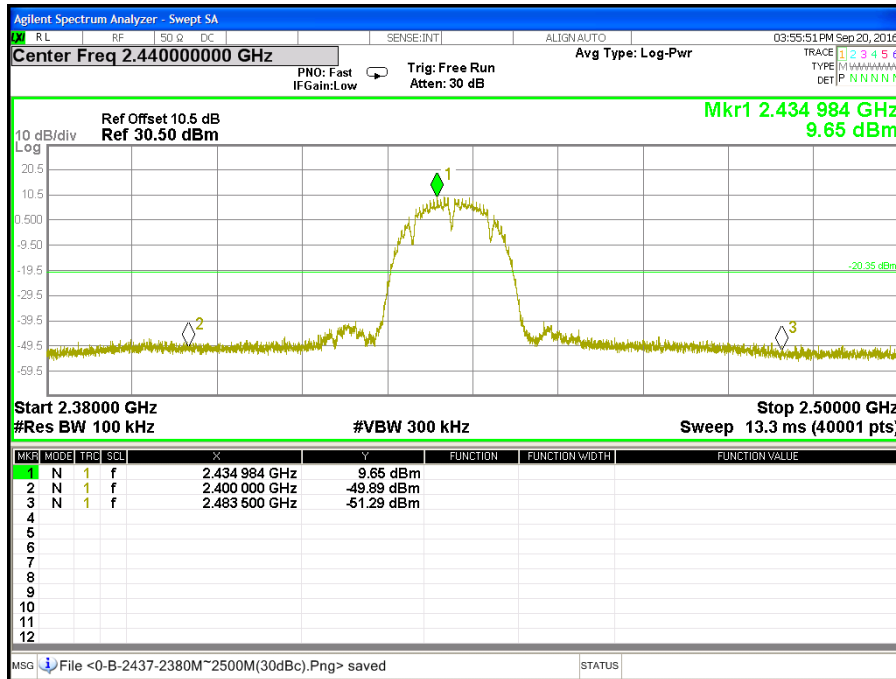

CH Middle (30MHz ~ 26.5GHz / IEEE 802.11b Mode / Chain 0)

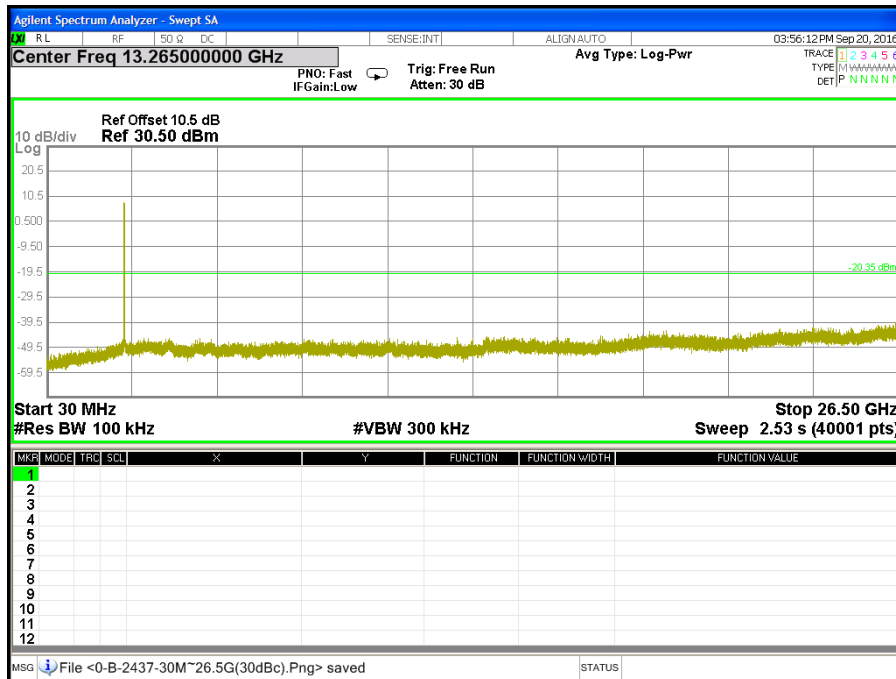

CH High (2.38GHz ~ 2.5GHz / IEEE 802.11b Mode / Chain 0)

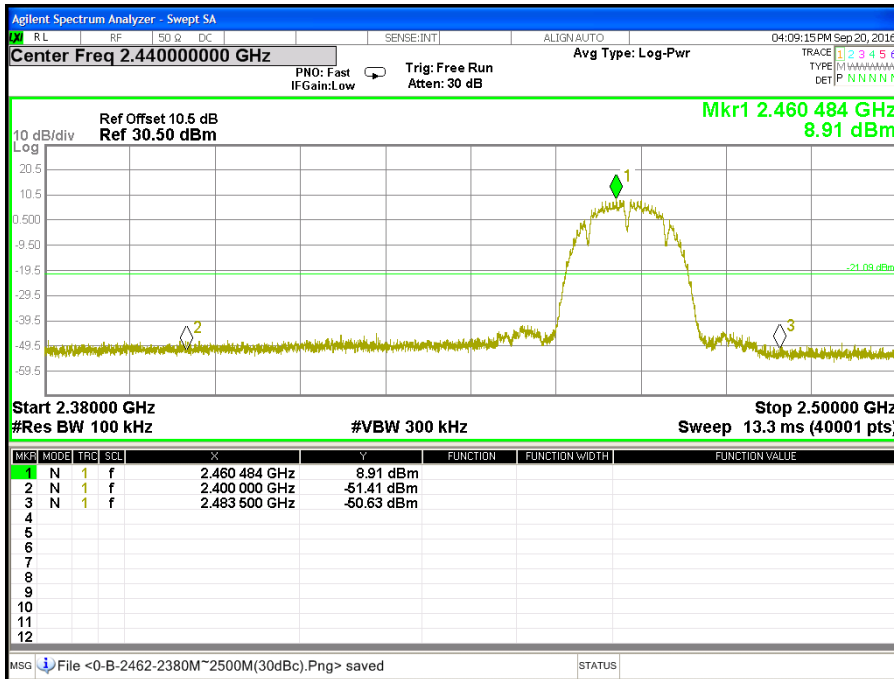

CH High (30MHz ~ 26.5GHz / IEEE 802.11b Mode / Chain 0)

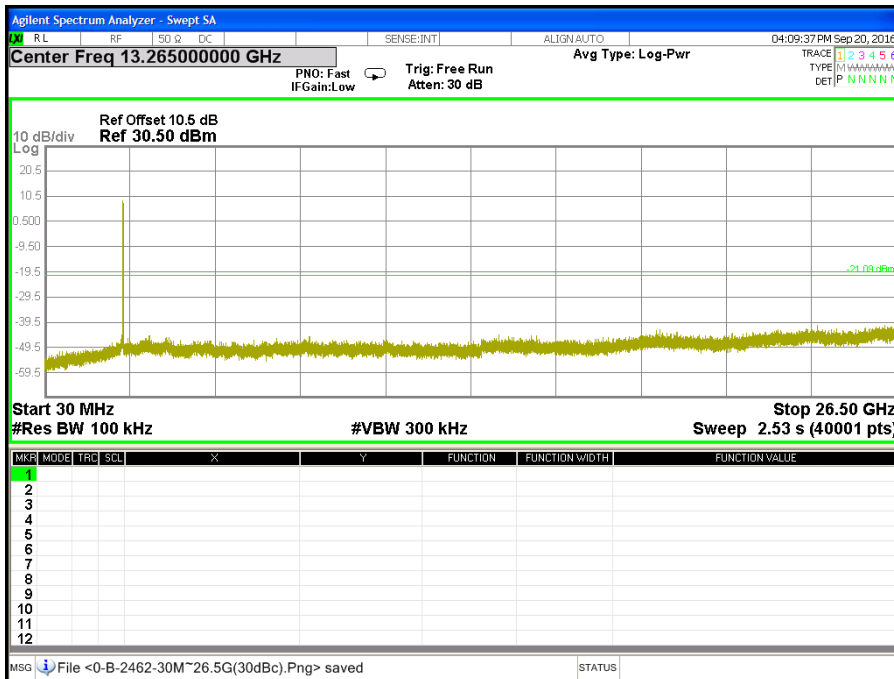

CH Low (2.38GHz ~ 2.5GHz / IEEE 802.11b Mode / Chain 1)

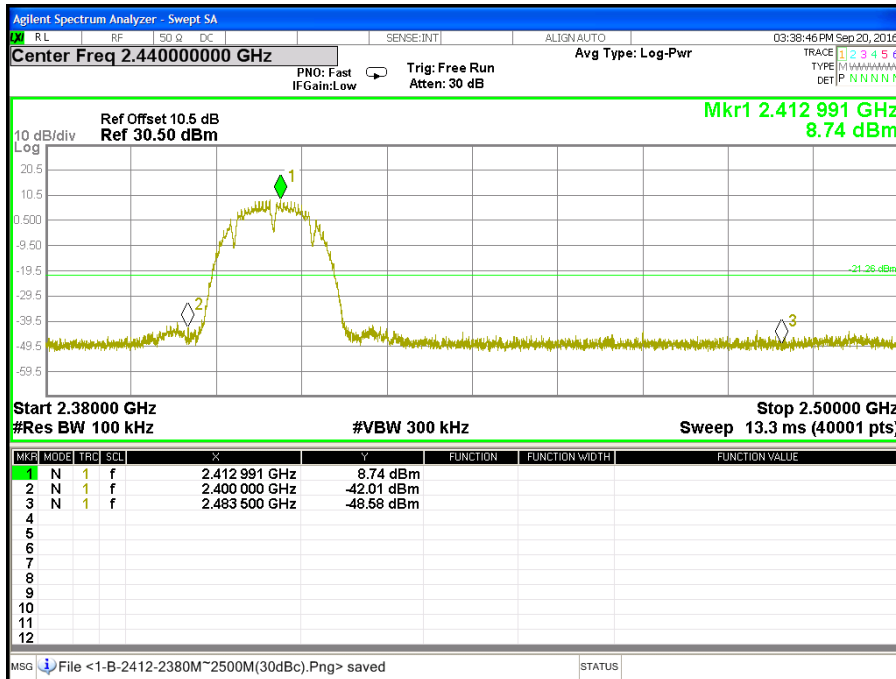

CH Low (30MHz ~ 26.5GHz / IEEE 802.11b Mode / Chain 1)

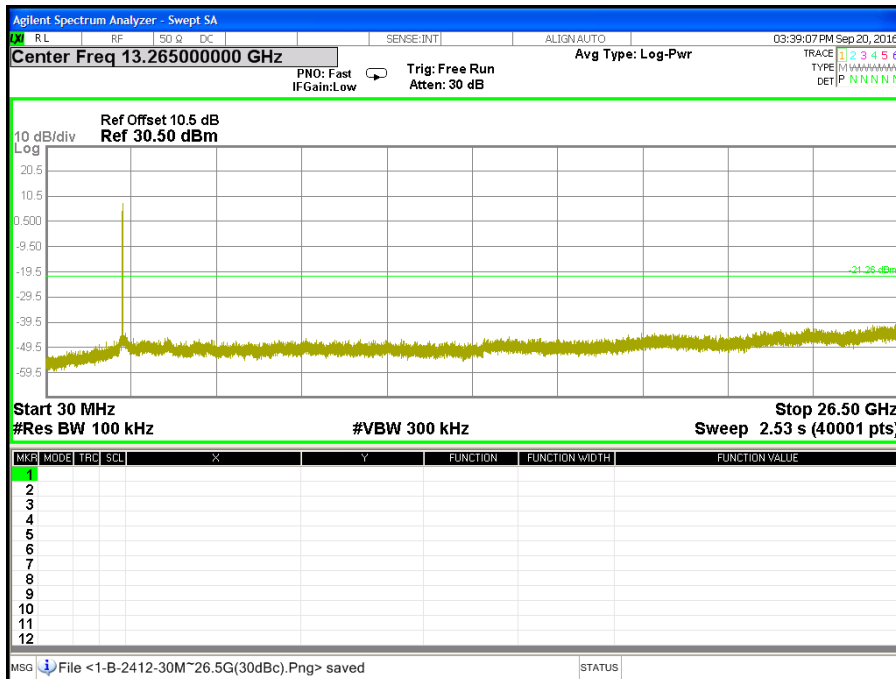

CH Middle (2.38GHz ~ 2.5GHz / IEEE 802.11b Mode / Chain 1)

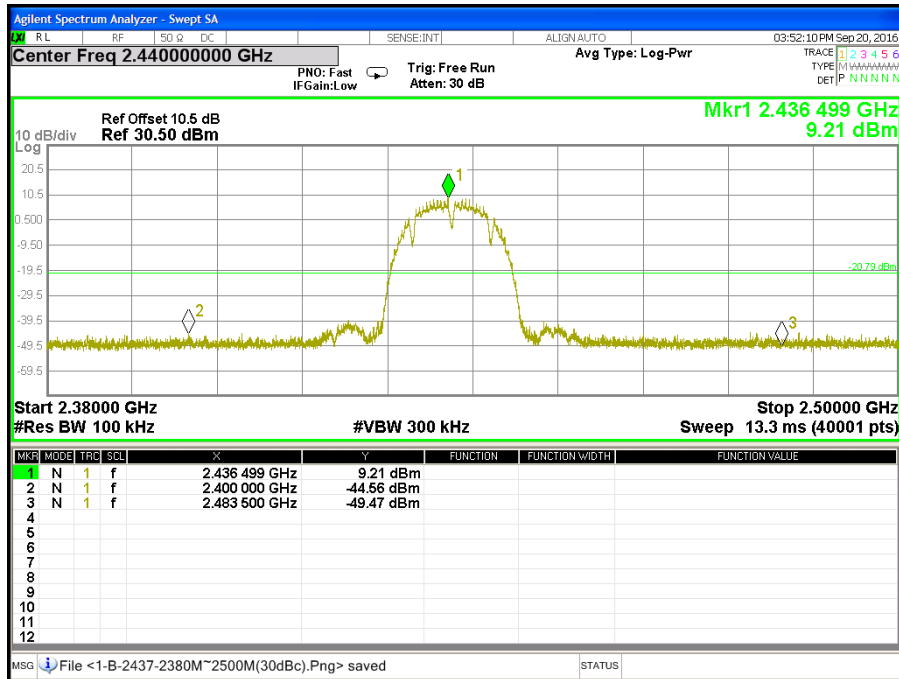

CH Middle (30MHz ~ 26.5GHz / IEEE 802.11b Mode / Chain 1)

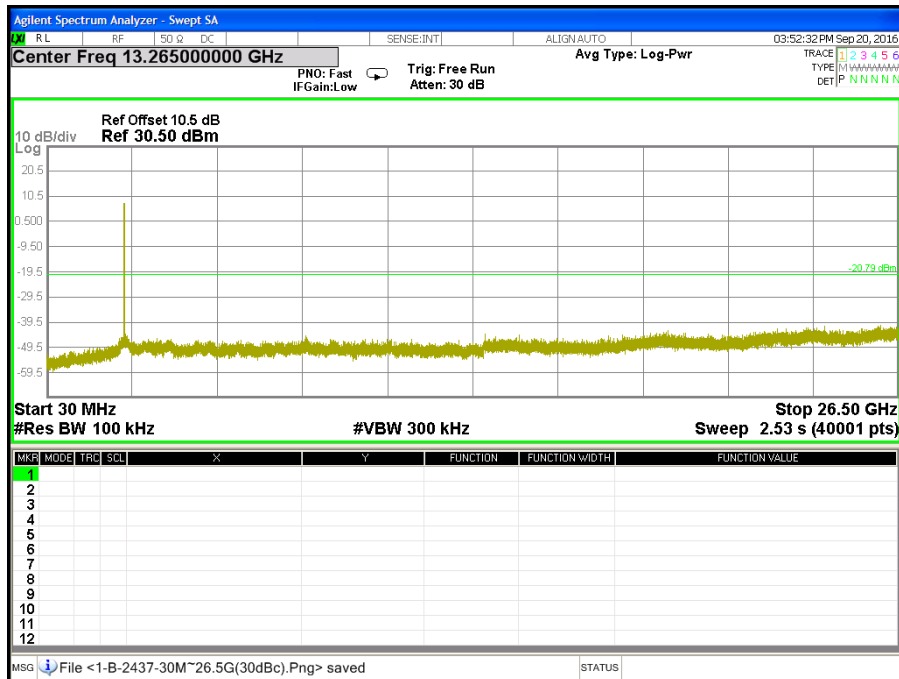

CH High (2.38GHz ~ 2.5GHz / IEEE 802.11b Mode / Chain 1)

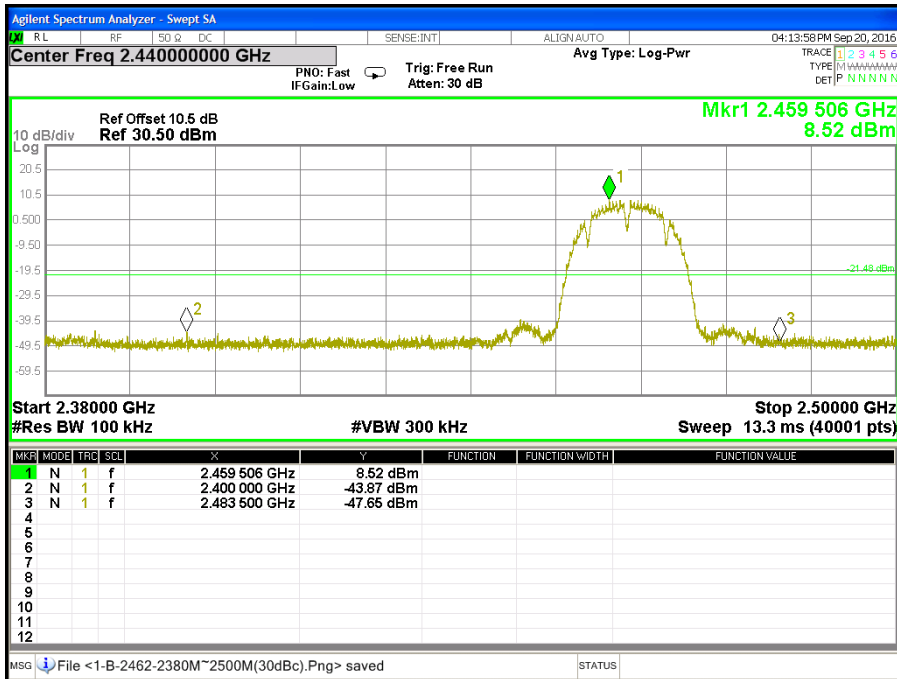

CH High (30MHz ~ 26.5GHz / IEEE 802.11b Mode / Chain 1)

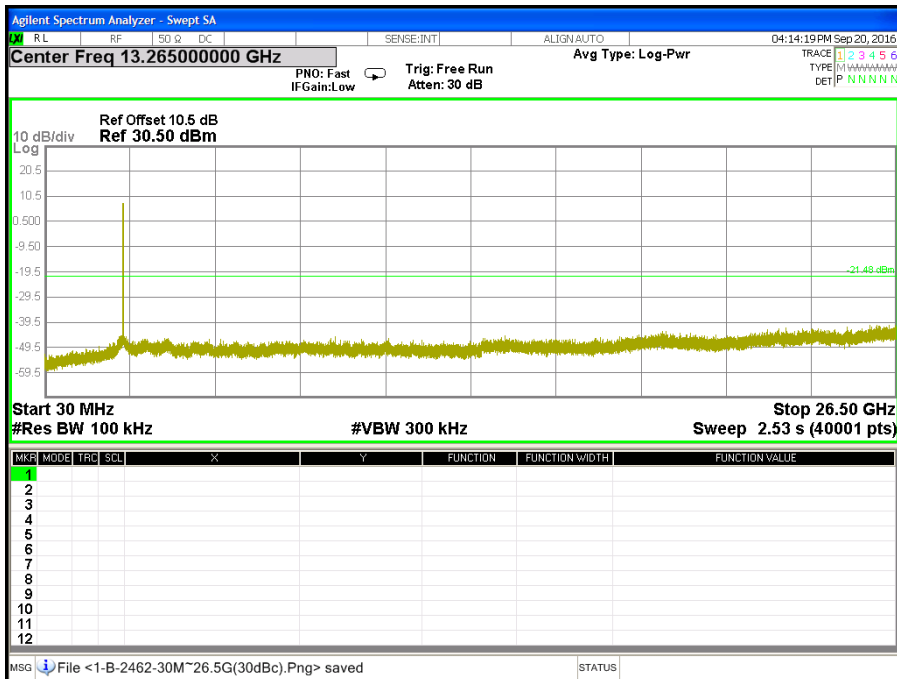

CH Low (2.38GHz ~ 2.5GHz / IEEE 802.11b Mode / Chain 2)

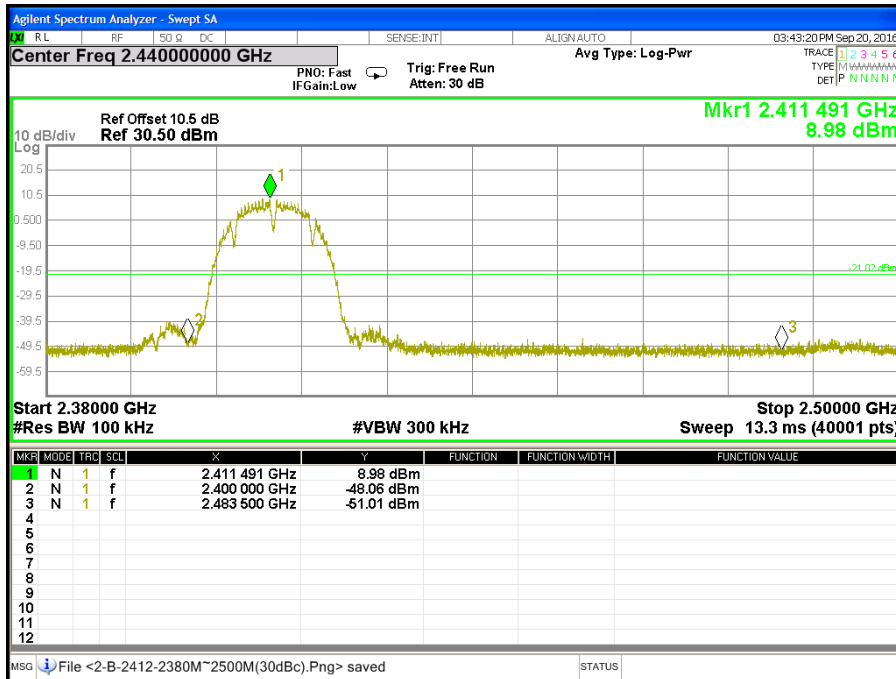

CH Low (30MHz ~ 26.5GHz / IEEE 802.11b Mode / Chain 2)

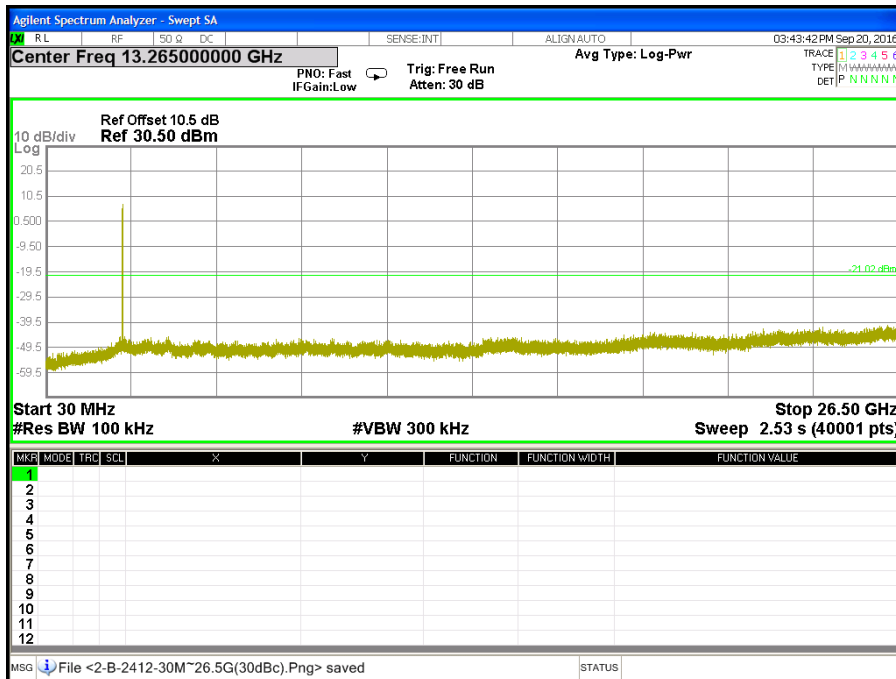

CH Middle (2.38GHz ~ 2.5GHz / IEEE 802.11b Mode / Chain 2)

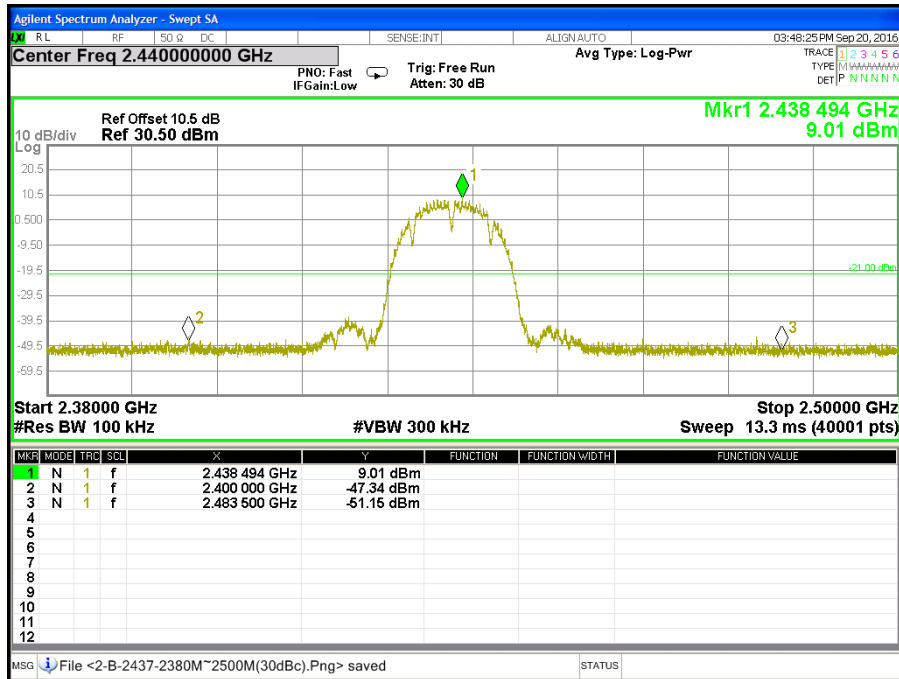

CH Middle (30MHz ~ 26.5GHz / IEEE 802.11b Mode / Chain 2)

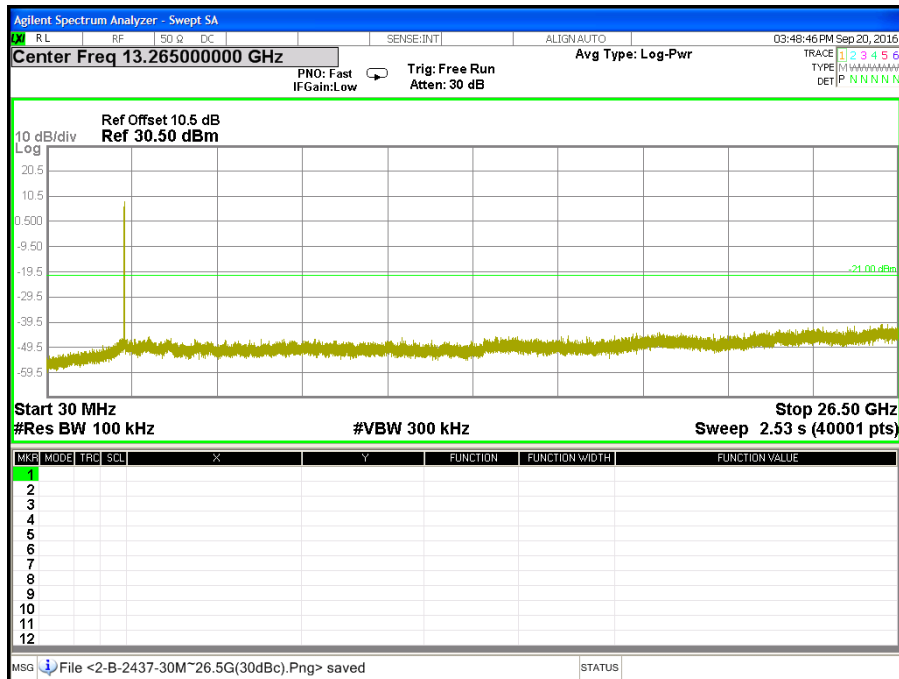

CH High (2.38GHz ~ 2.5GHz / IEEE 802.11b Mode / Chain 2)

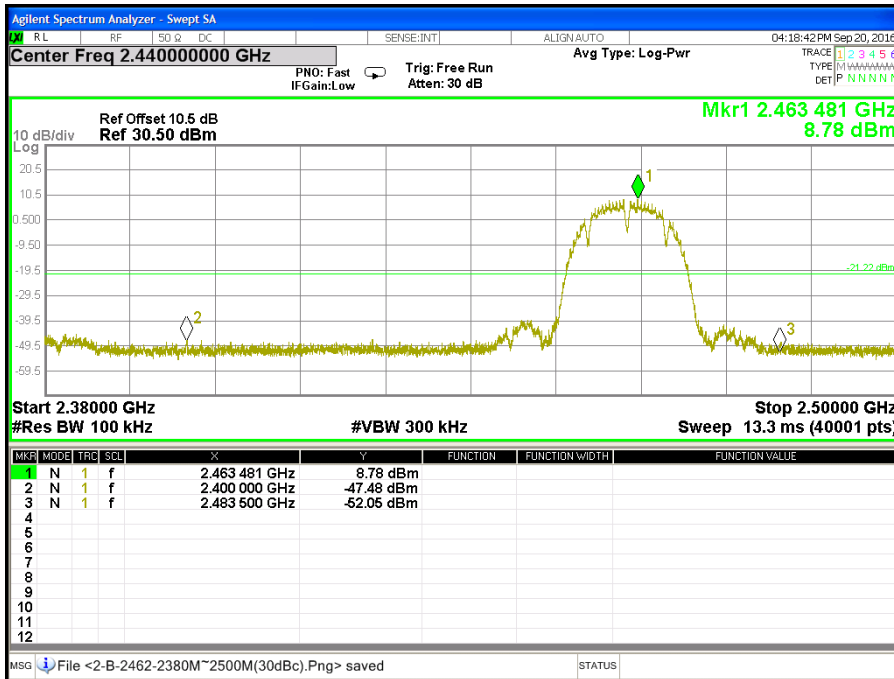

CH High (30MHz ~ 26.5GHz / IEEE 802.11b Mode / Chain 2)

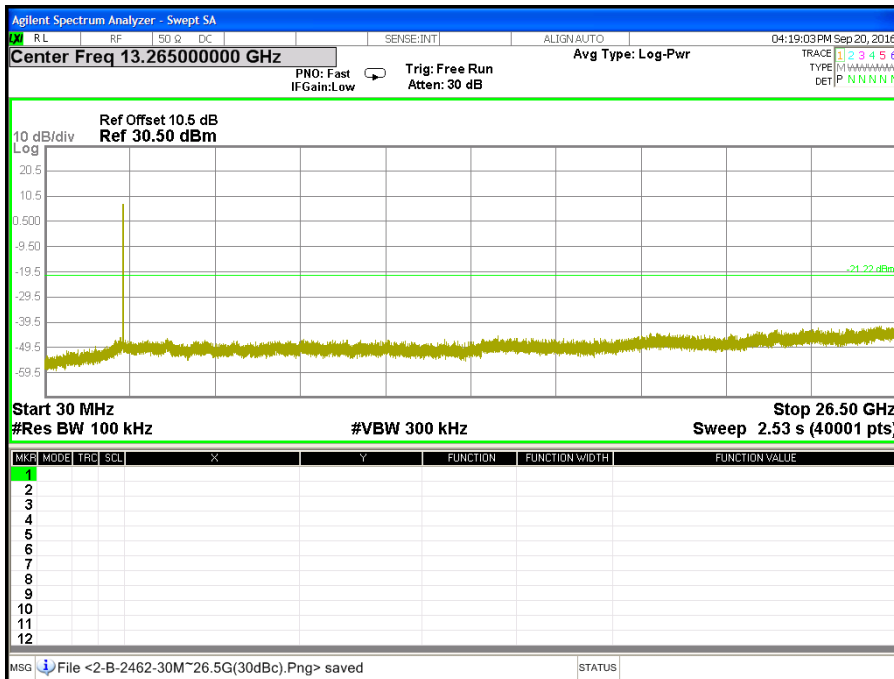

CH Low (2.38GHz ~ 2.5GHz / IEEE 802.11g Mode / Chain 0)

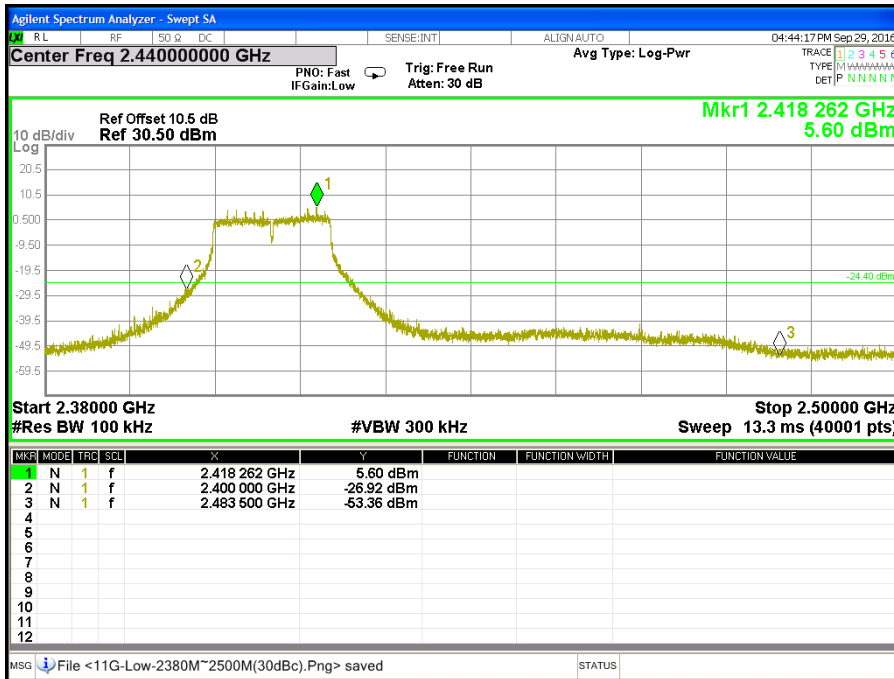

CH Low (30MHz ~ 26.5GHz / IEEE 802.11g Mode / Chain 0)

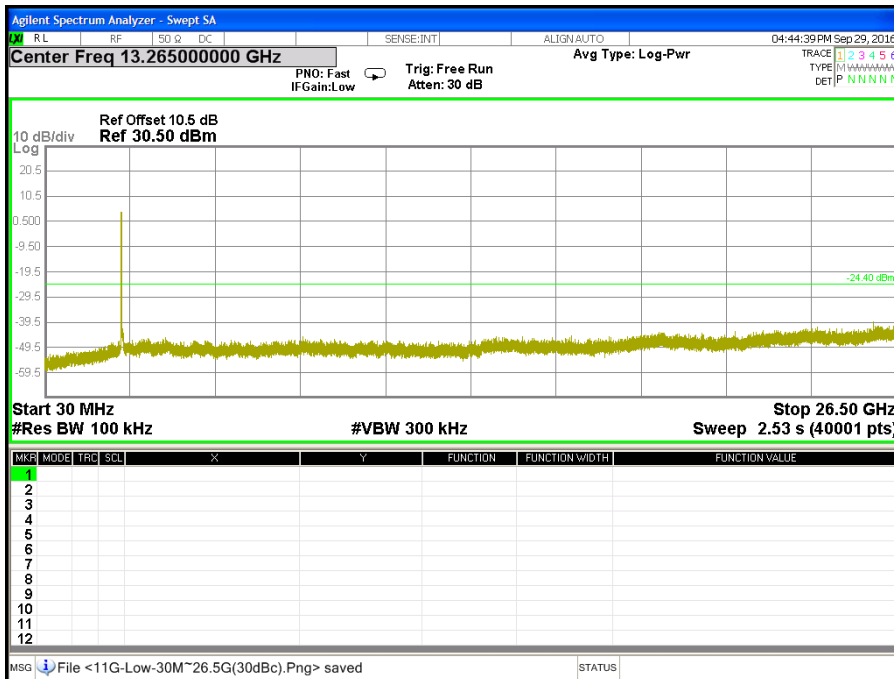

CH Middle (2.38GHz ~ 2.5GHz / IEEE 802.11g Mode / Chain 0)

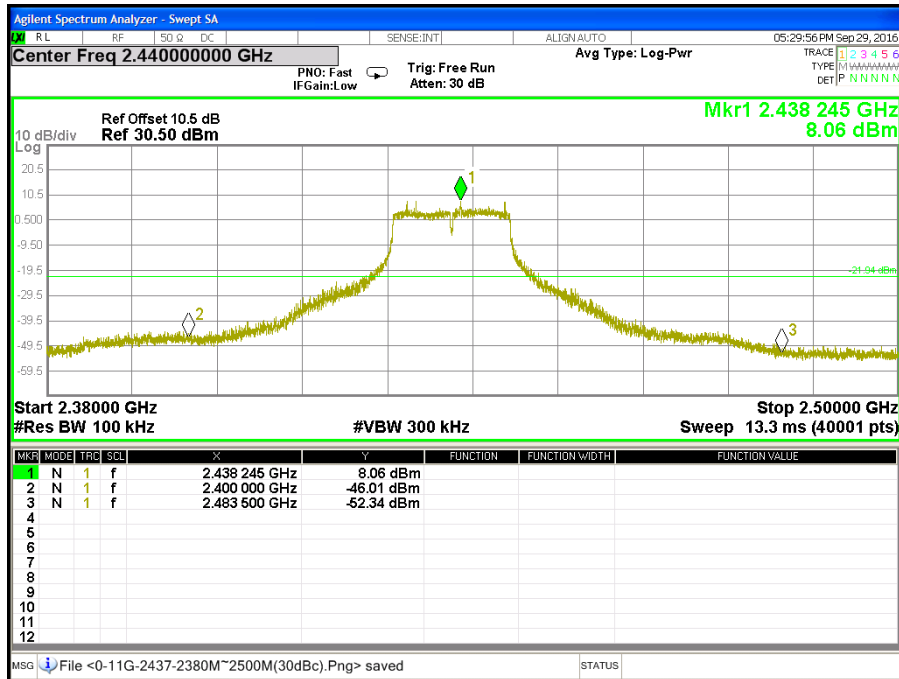

CH Middle (30MHz ~ 26.5GHz / IEEE 802.11g Mode / Chain 0)

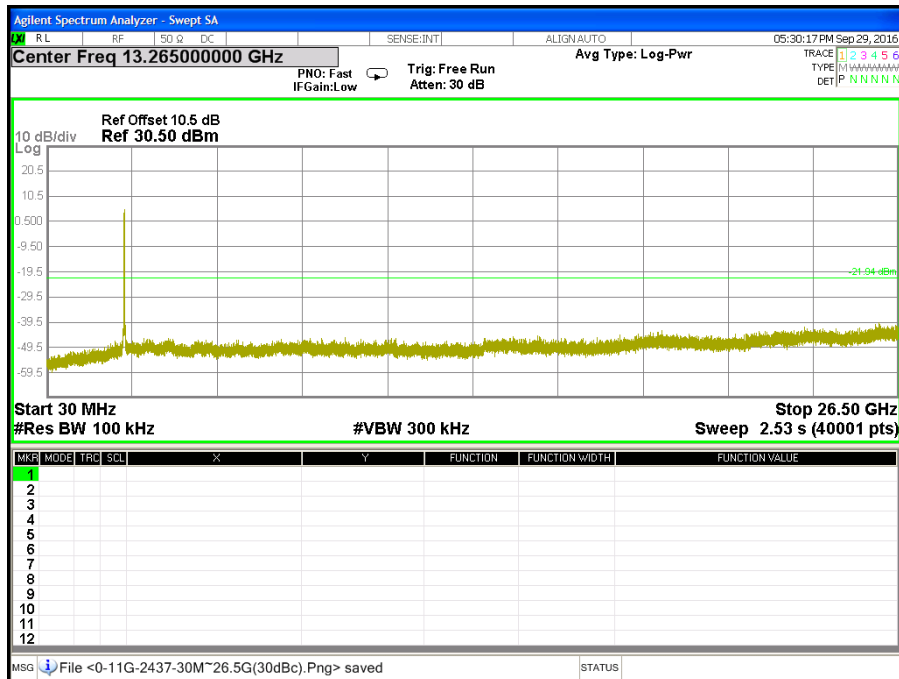

CH High (2.38GHz ~ 2.5GHz / IEEE 802.11g Mode / Chain 0)

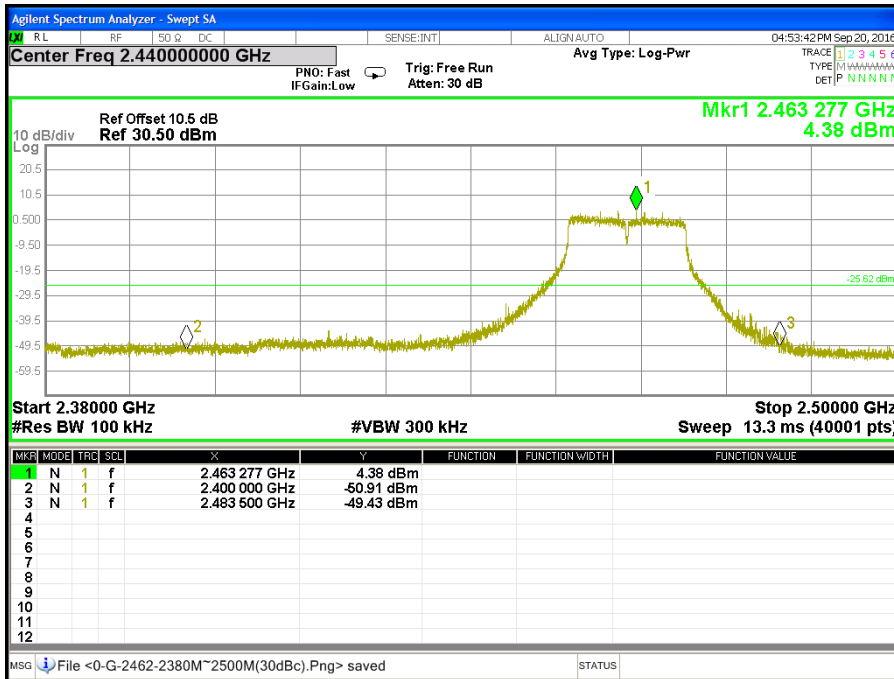

CH High (30MHz ~ 26.5GHz / IEEE 802.11g Mode / Chain 0)

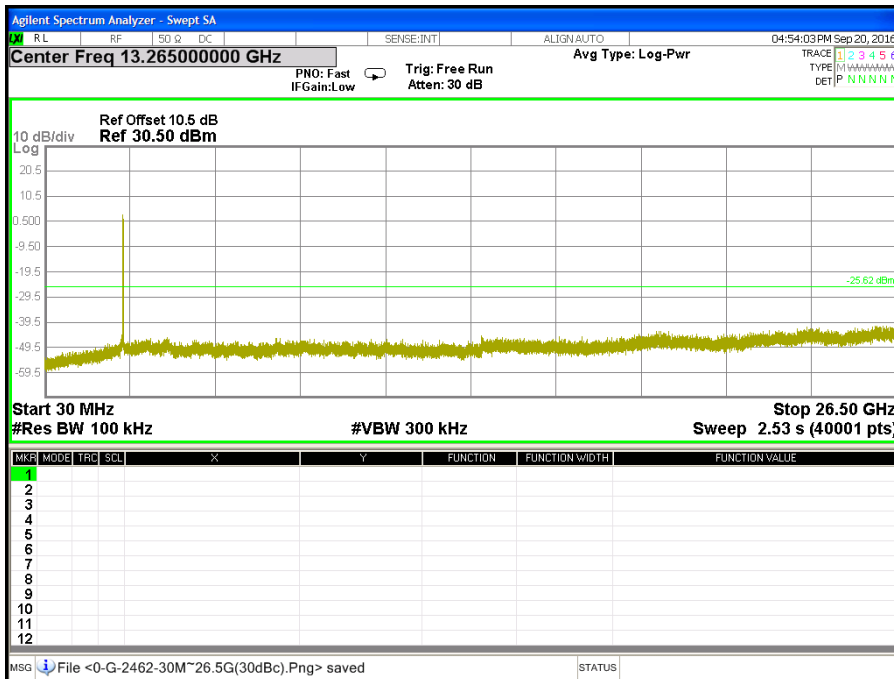

CH Low (2.38GHz ~ 2.5GHz / IEEE 802.11g Mode / Chain 1)

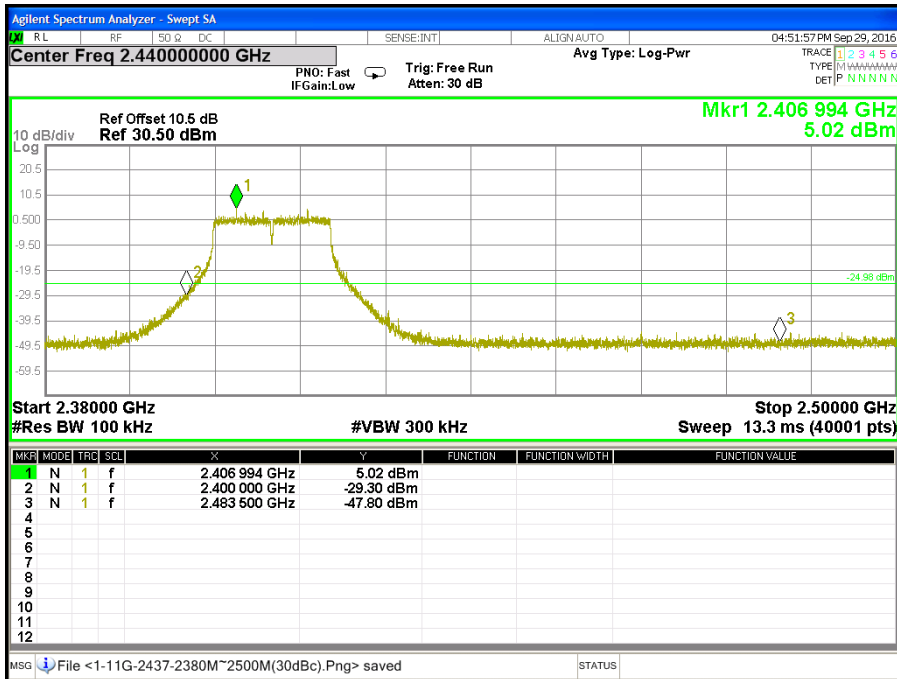

CH Low (30MHz ~ 26.5GHz / IEEE 802.11g Mode / Chain 1)

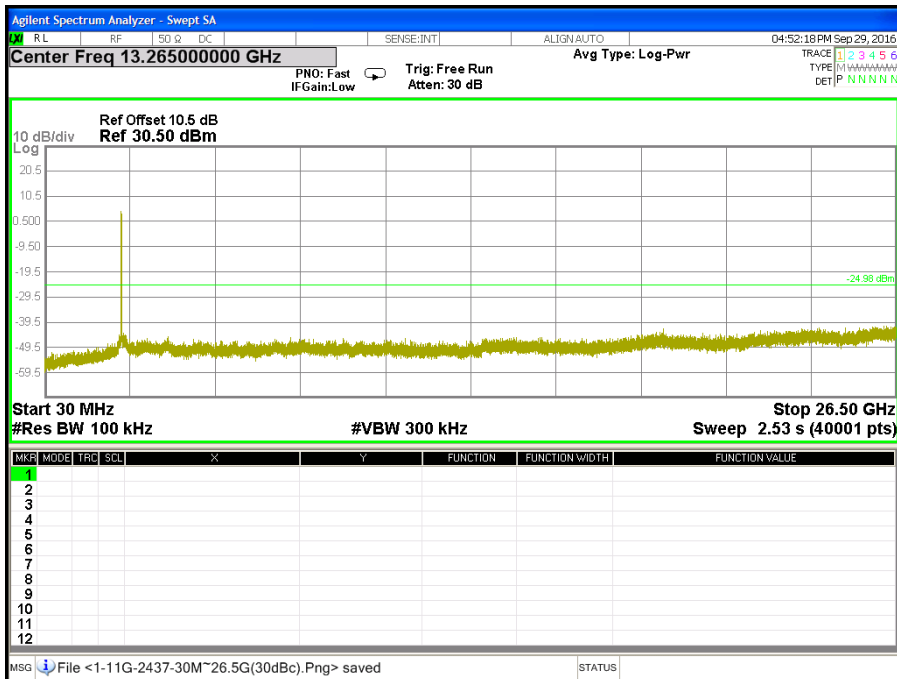

CH Middle (2.38GHz ~ 2.5GHz / IEEE 802.11g Mode / Chain 1)

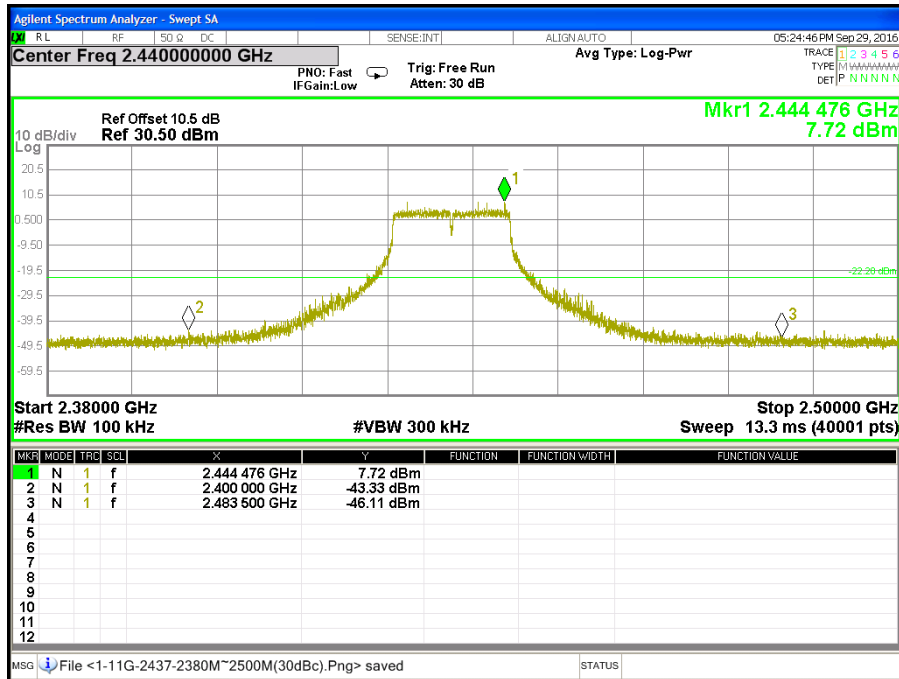

CH Middle (30MHz ~ 26.5GHz / IEEE 802.11g Mode / Chain 1)

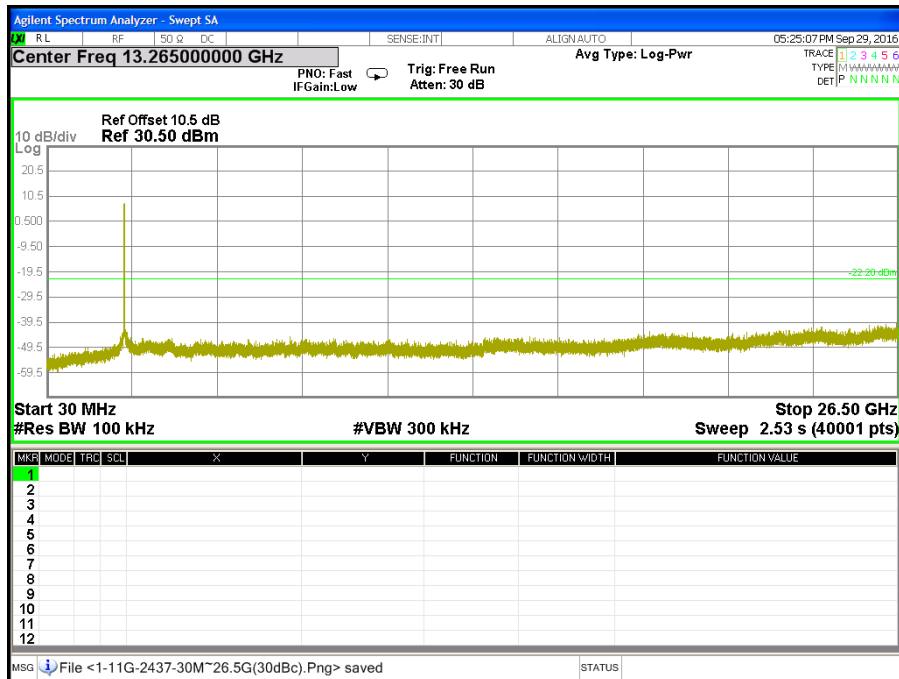

CH High (2.38GHz ~ 2.5GHz / IEEE 802.11g Mode / Chain 1)

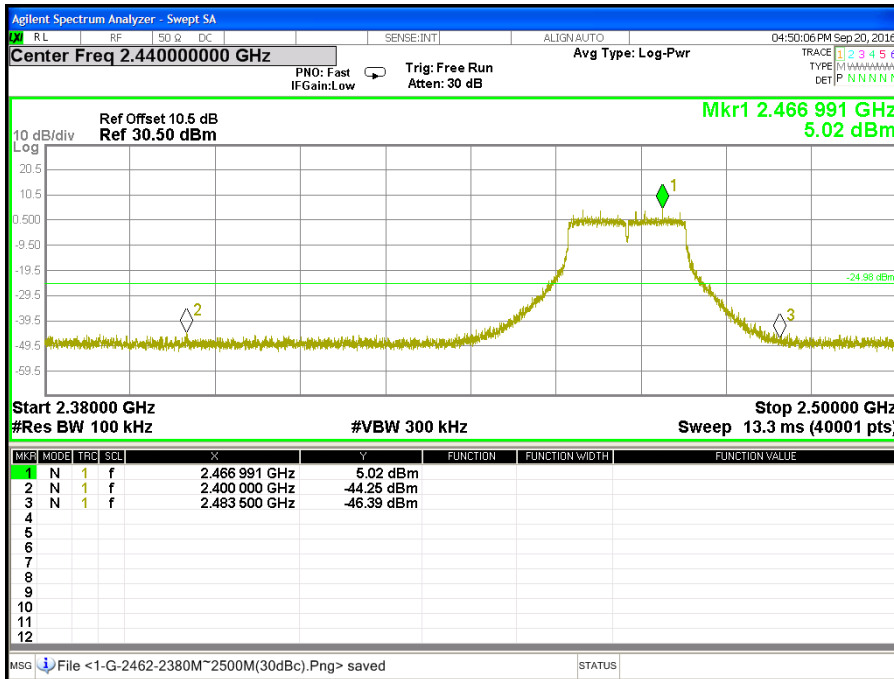

CH High (30MHz ~ 26.5GHz / IEEE 802.11g Mode / Chain 1)

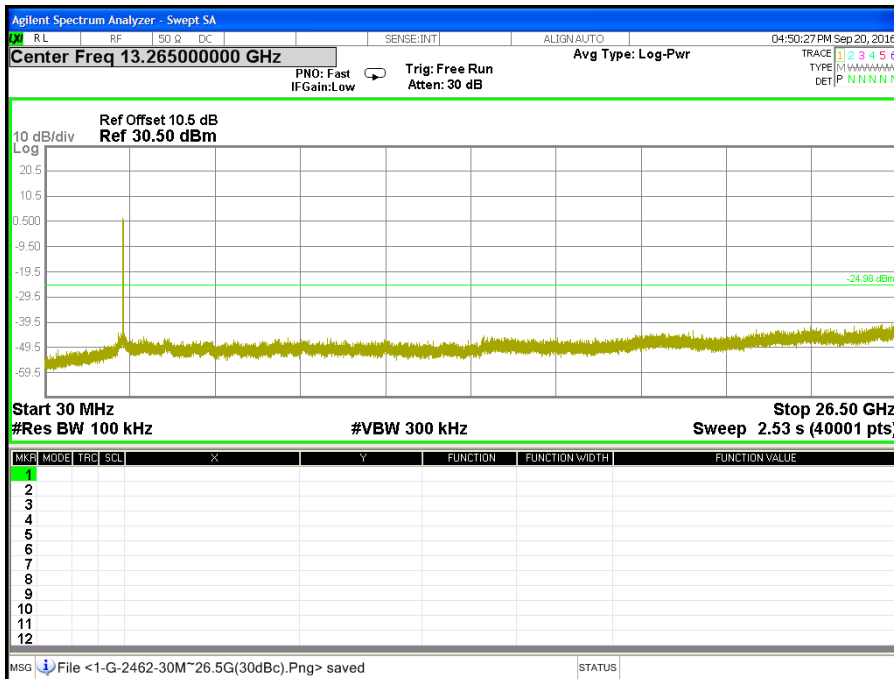

CH Low (2.38GHz ~ 2.5GHz / IEEE 802.11g Mode / Chain 2)

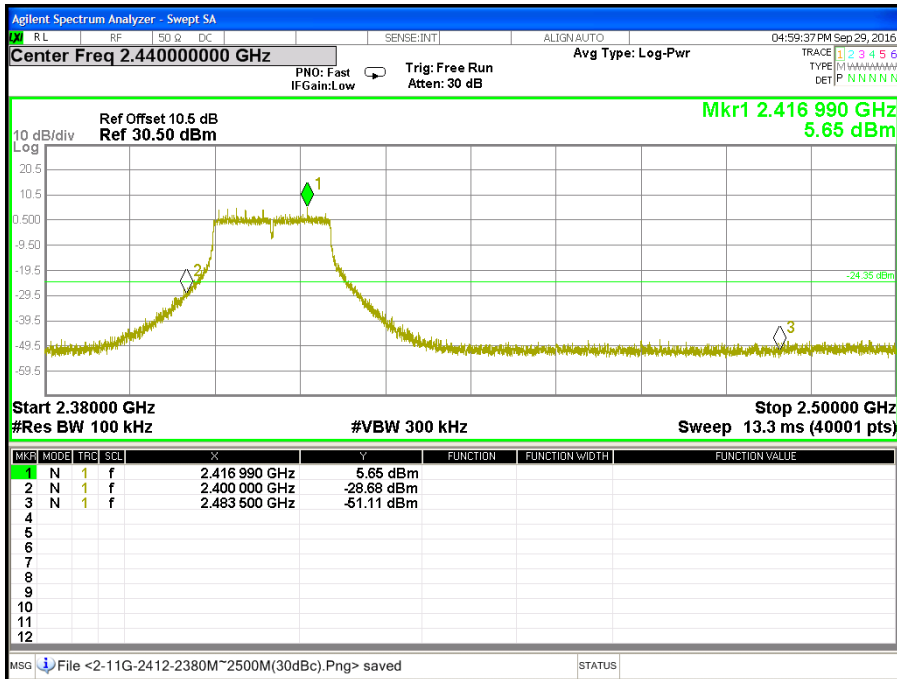

CH Low (30MHz ~ 26.5GHz / IEEE 802.11g Mode / Chain 2)

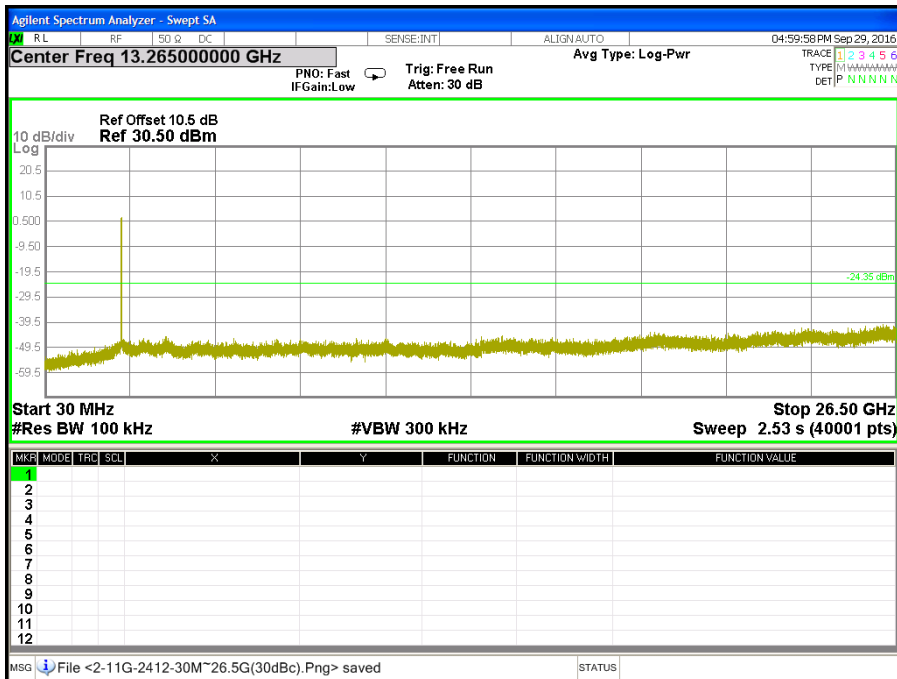

CH Middle (2.38GHz ~ 2.5GHz / IEEE 802.11g Mode / Chain 2)

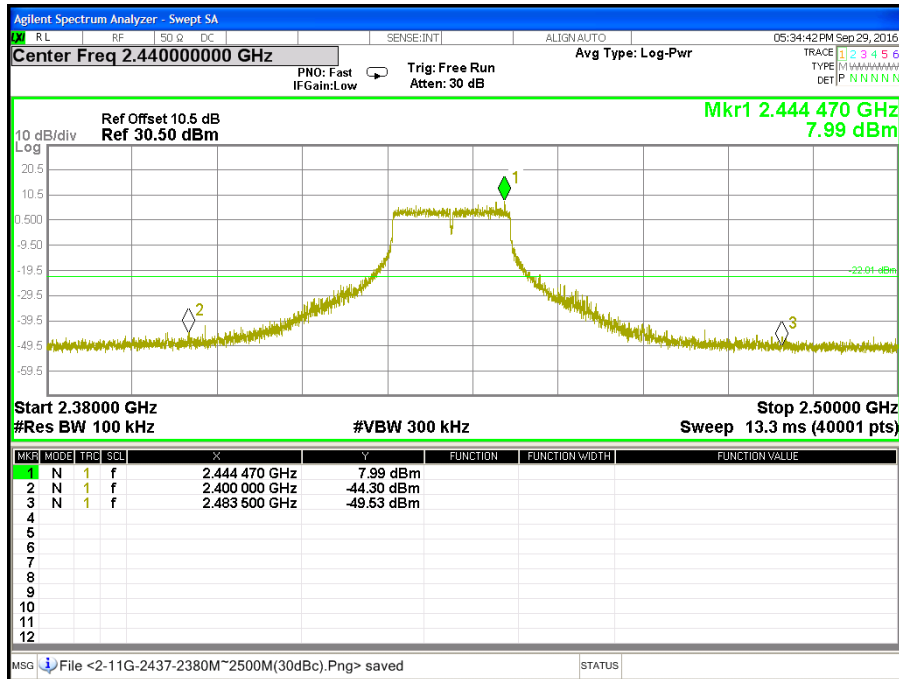

CH Middle (30MHz ~ 26.5GHz / IEEE 802.11g Mode / Chain 2)

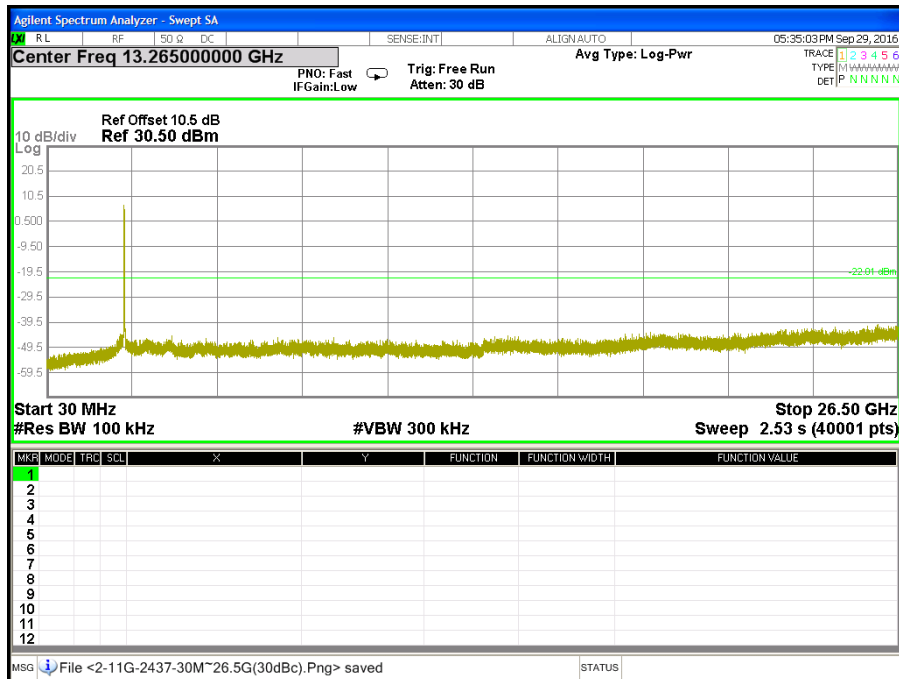

CH High (2.38GHz ~ 2.5GHz / IEEE 802.11g Mode / Chain 2)

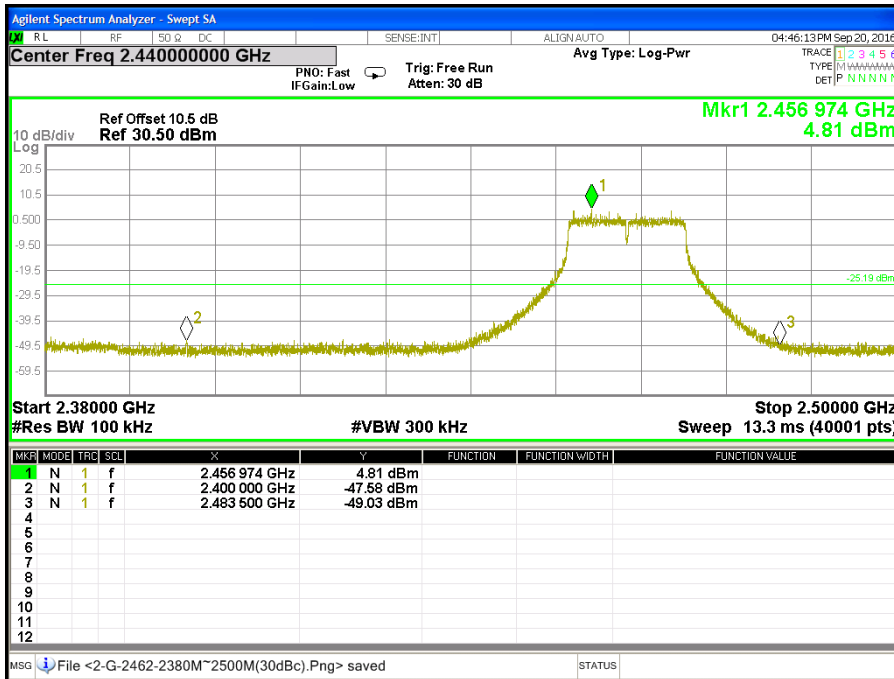

CH High (30MHz ~ 26.5GHz / IEEE 802.11g Mode / Chain 2)

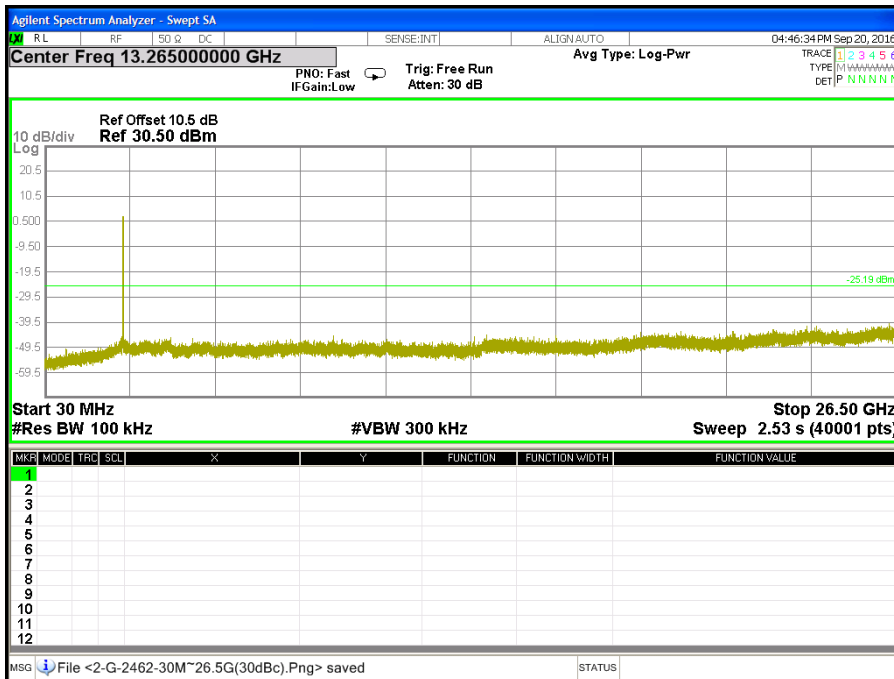

CH Low (2.38GHz ~ 2.5GHz / IEEE 802.11gn HT20 MCS0 Mode / Chain 0)

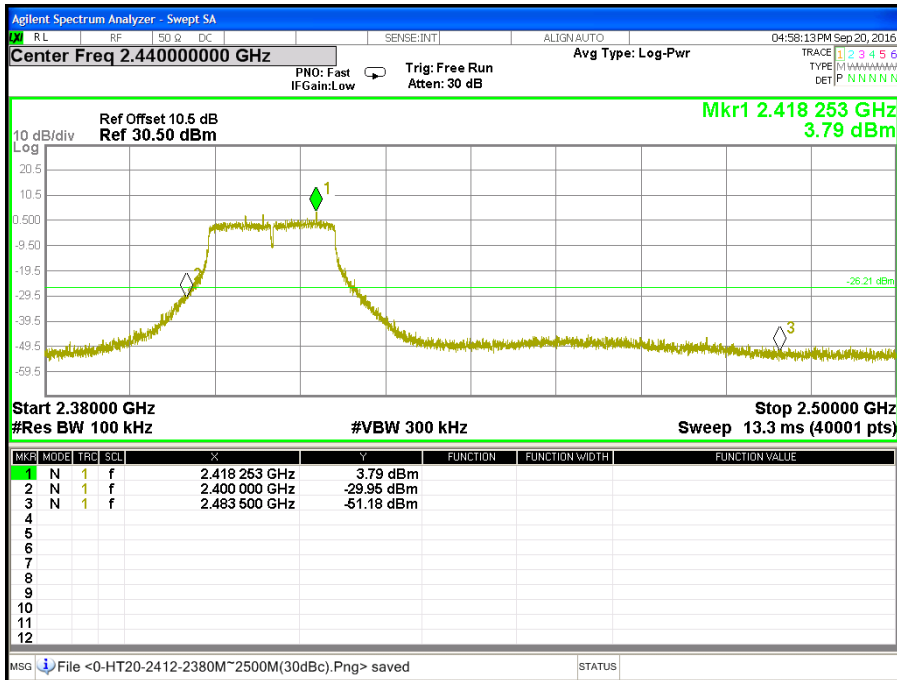

CH Low (30MHz ~ 26.5GHz / IEEE 802.11gn HT20 MCS0 Mode / Chain 0)

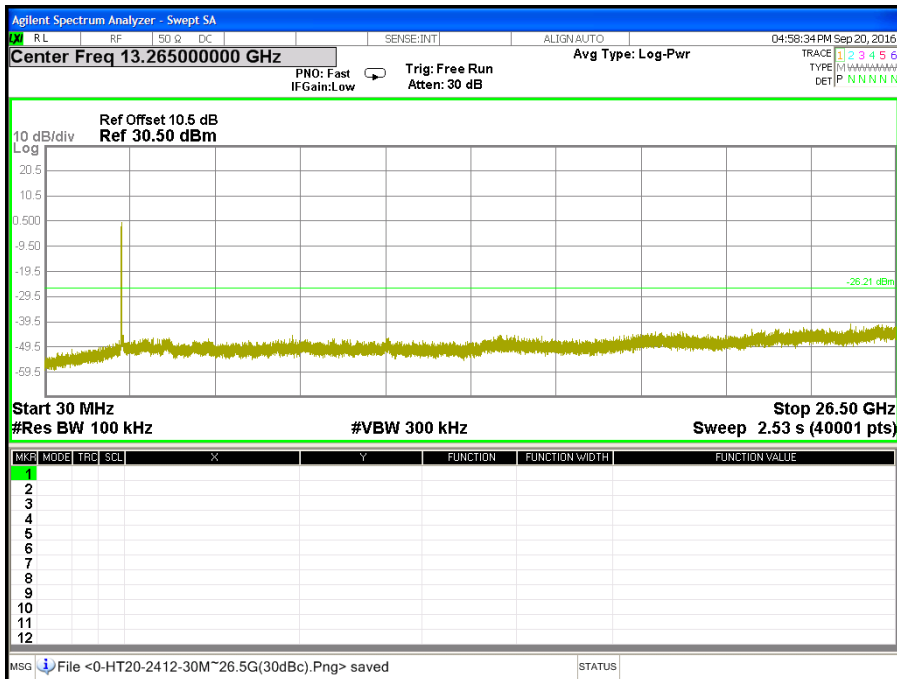

CH Middle (2.38GHz ~ 2.5GHz / IEEE 802.11gn HT20 MCS0 Mode / Chain 0)

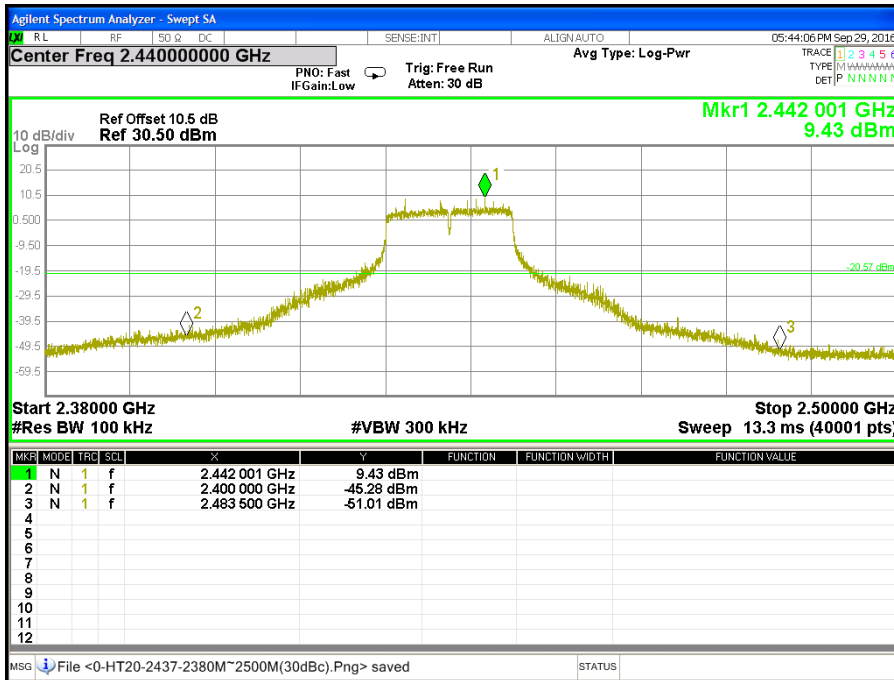

CH Middle (30MHz ~ 26.5GHz / IEEE 802.11gn HT20 MCS0 Mode / Chain 0)

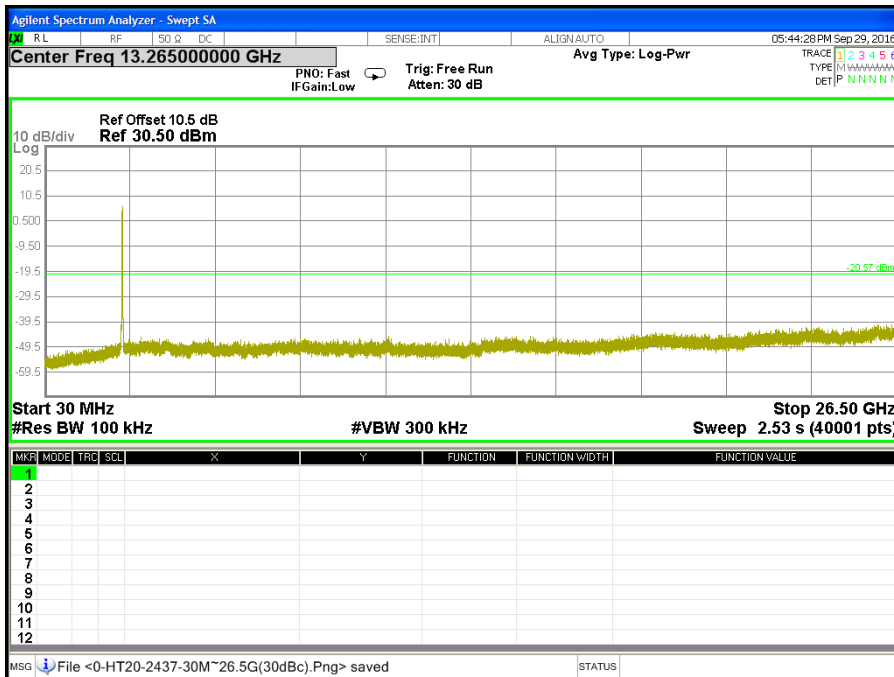

CH High (2.38GHz ~ 2.5GHz / IEEE 802.11gn HT20 MCS0 Mode / Chain 0)

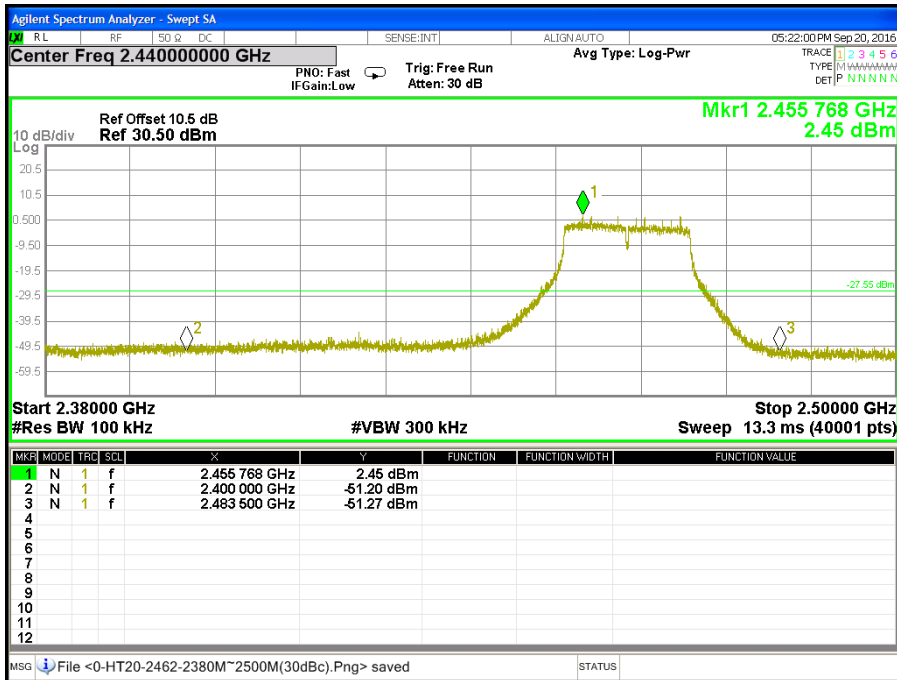

CH High (30MHz ~ 26.5GHz / IEEE 802.11gn HT20 MCS0 Mode / Chain 0)

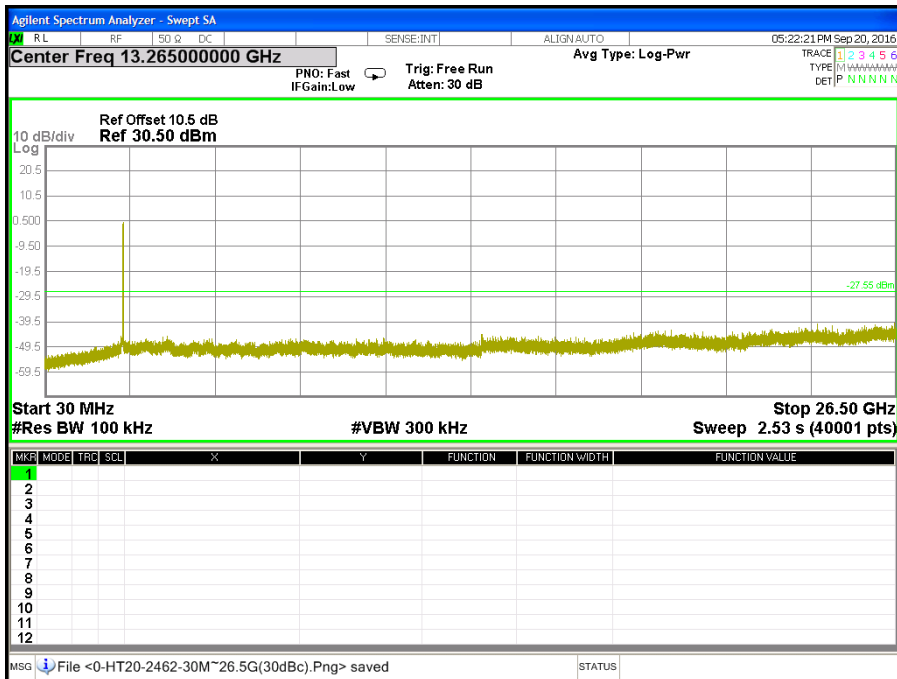

CH Low (2.38GHz ~ 2.5GHz / IEEE 802.11gn HT20 MCS0 Mode / Chain 1)

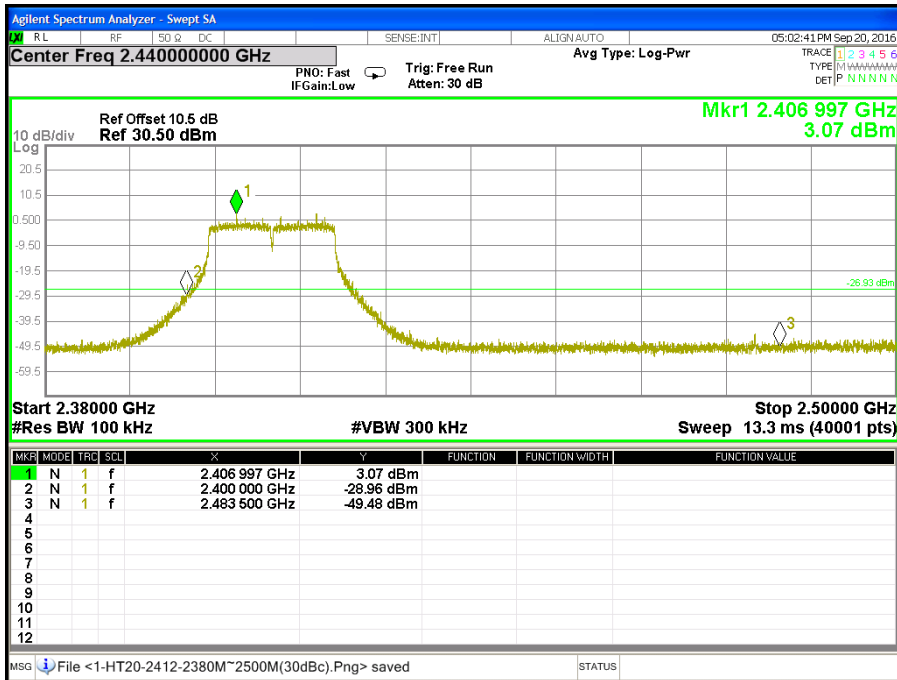

CH Low (30MHz ~ 26.5GHz / IEEE 802.11gn HT20 MCS0 Mode / Chain 1)

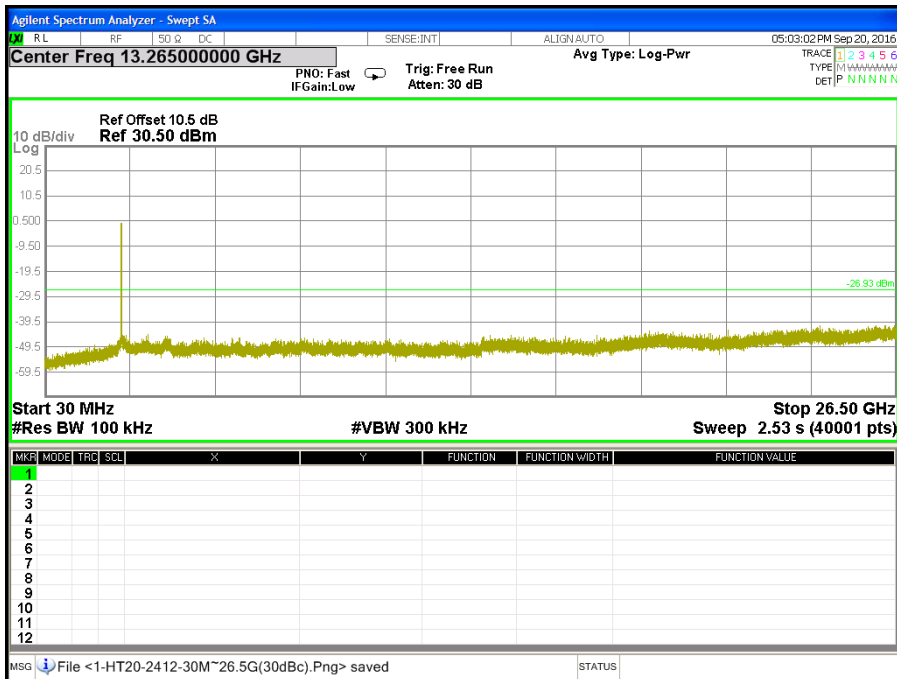

CH Middle (2.38GHz ~ 2.5GHz / IEEE 802.11gn HT20 MCS0 Mode / Chain 1)

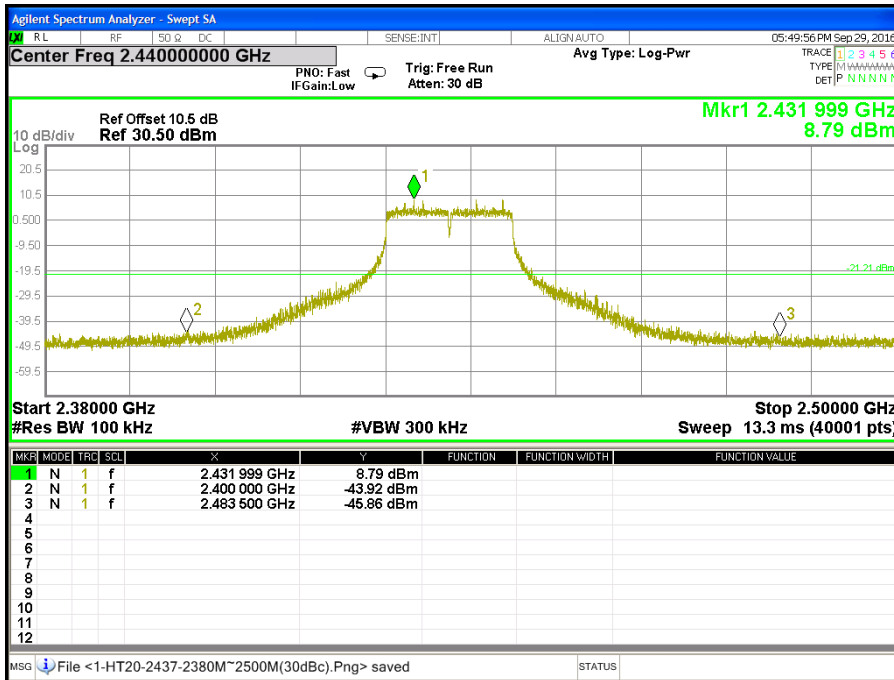

CH Middle (30MHz ~ 26.5GHz / IEEE 802.11gn HT20 MCS0 Mode / Chain 1)

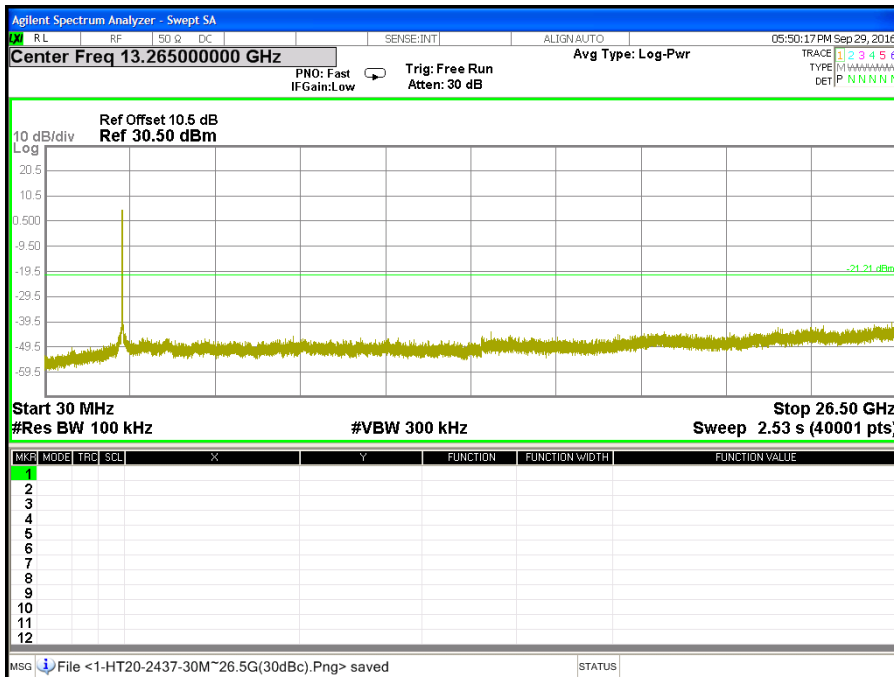

CH High (2.38GHz ~ 2.5GHz / IEEE 802.11gn HT20 MCS0 Mode / Chain 1)

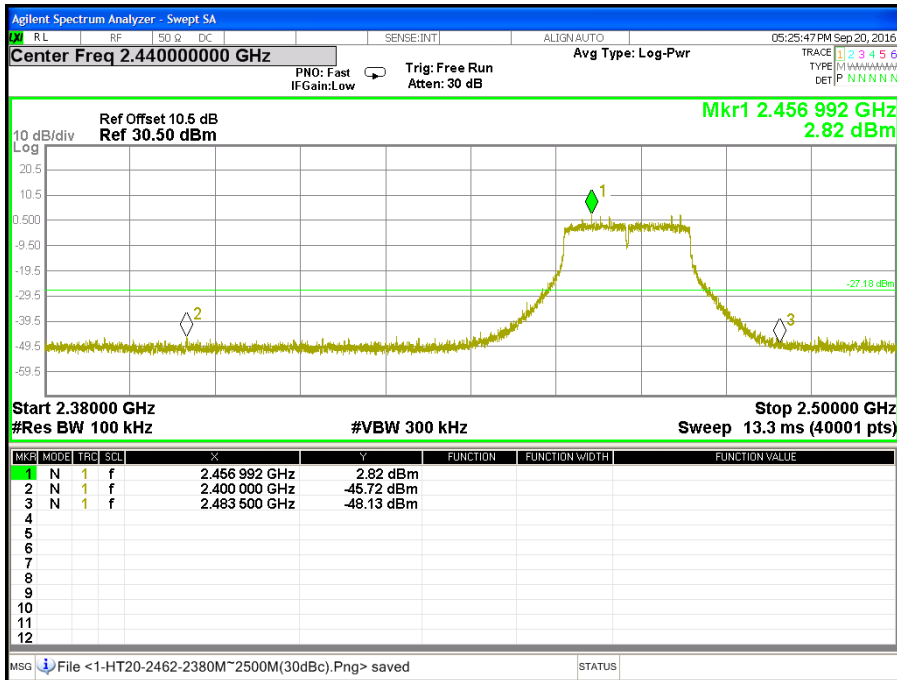

CH High (30MHz ~ 26.5GHz / IEEE 802.11gn HT20 MCS0 Mode / Chain 1)

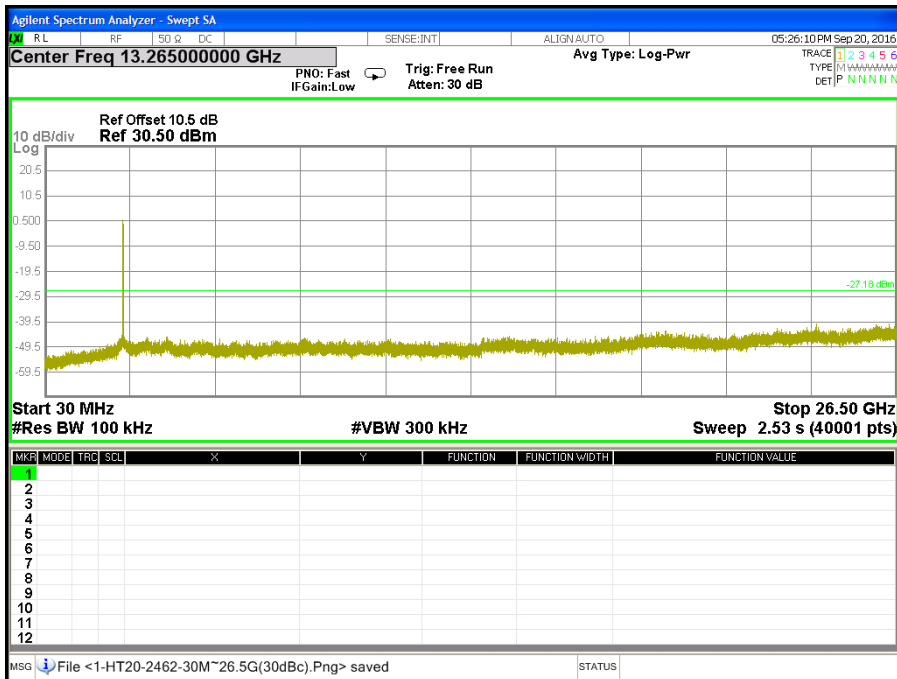

CH Low (2.38GHz ~ 2.5GHz / IEEE 802.11gn HT20 MCS0 Mode / Chain 2)

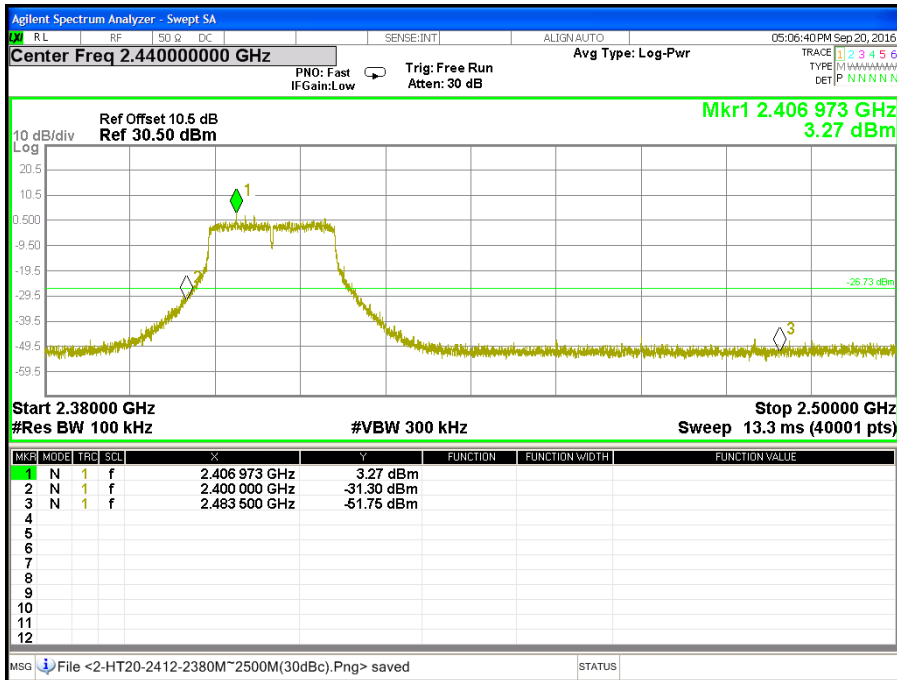

CH Low (30MHz ~ 26.5GHz / IEEE 802.11gn HT20 MCS0 Mode / Chain 2)

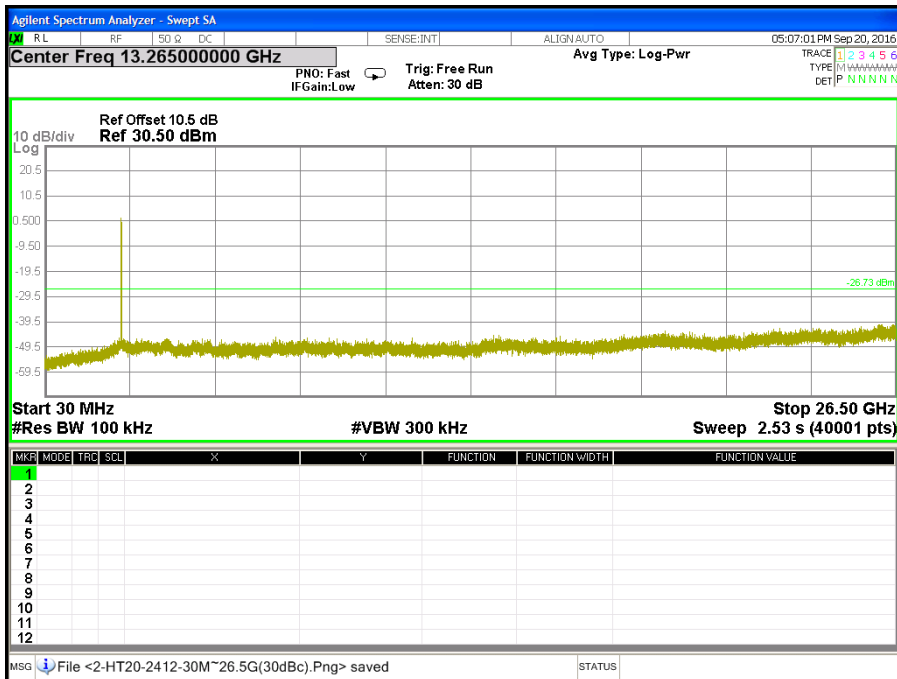

CH Middle (2.38GHz ~ 2.5GHz / IEEE 802.11gn HT20 MCS0 Mode / Chain 2)

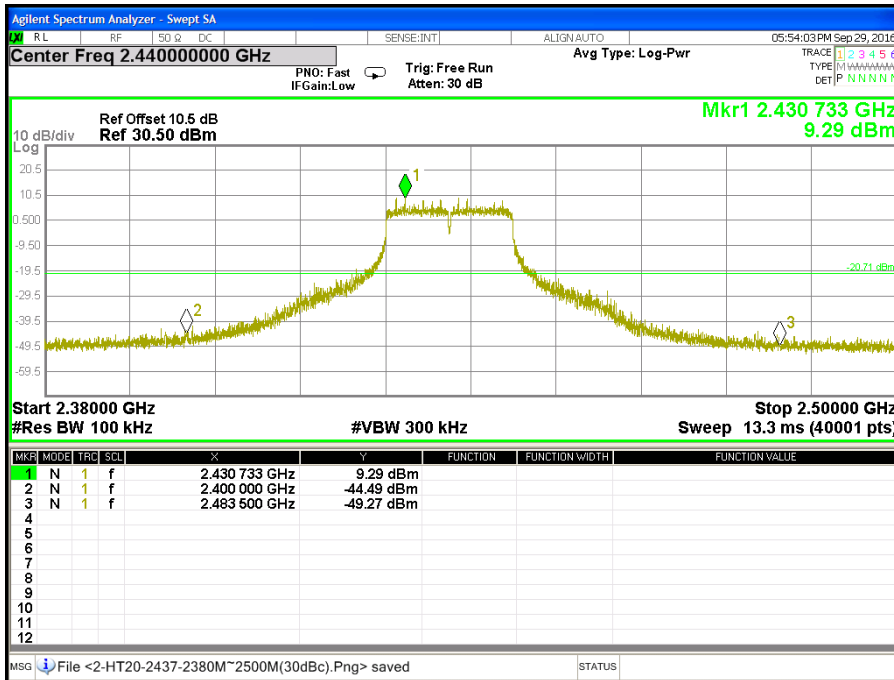

CH Middle (30MHz ~ 26.5GHz / IEEE 802.11gn HT20 MCS0 Mode / Chain 2)

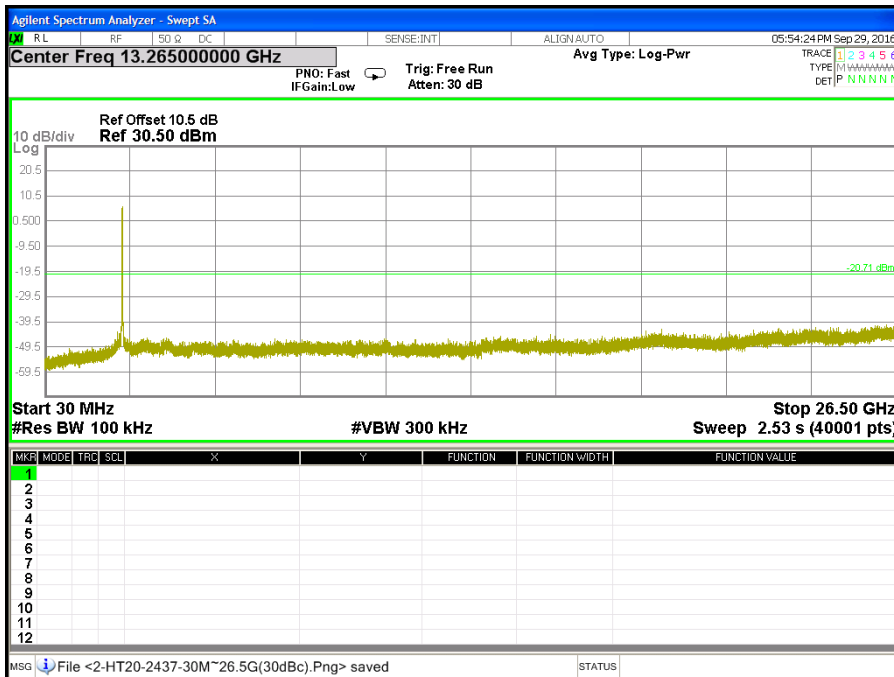

CH High (2.38GHz ~ 2.5GHz / IEEE 802.11gn HT20 MCS0 Mode / Chain 2)

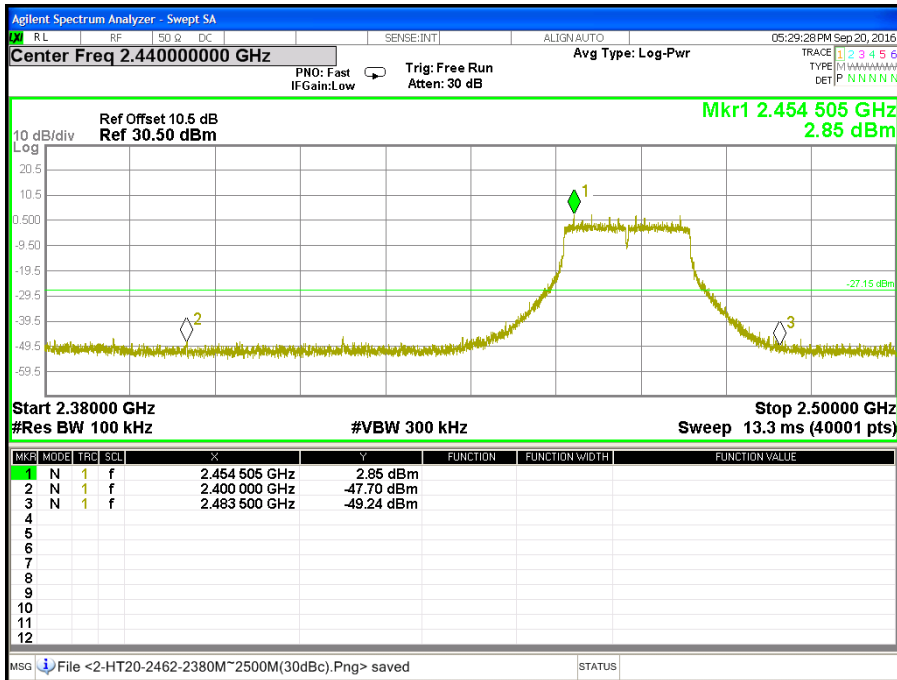

CH High (30MHz ~ 26.5GHz / IEEE 802.11gn HT20 MCS0 Mode / Chain 2)

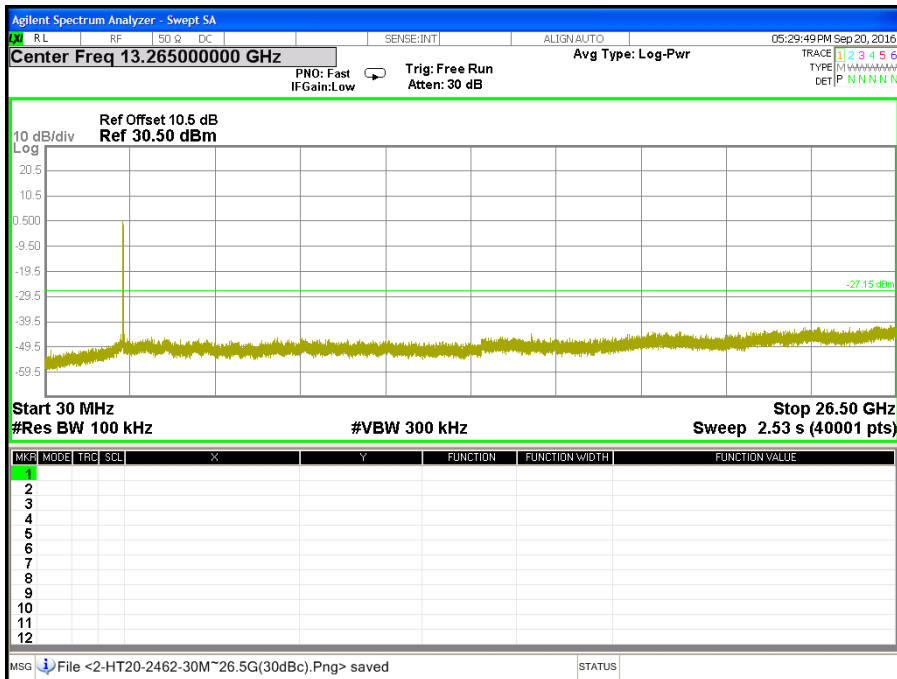

CH Low (2.38GHz ~ 2.5GHz / IEEE 802.11gn HT40 MCS0 Mode / Chain 0)

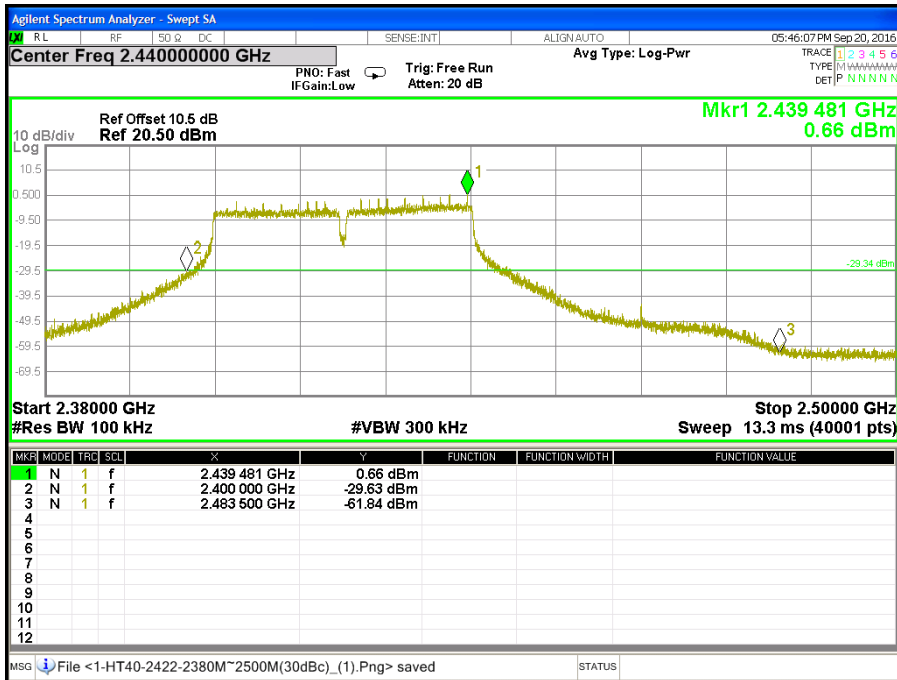

CH Low (30MHz ~ 26.5GHz / IEEE 802.11gn HT40 MCS0 Mode / Chain 0)

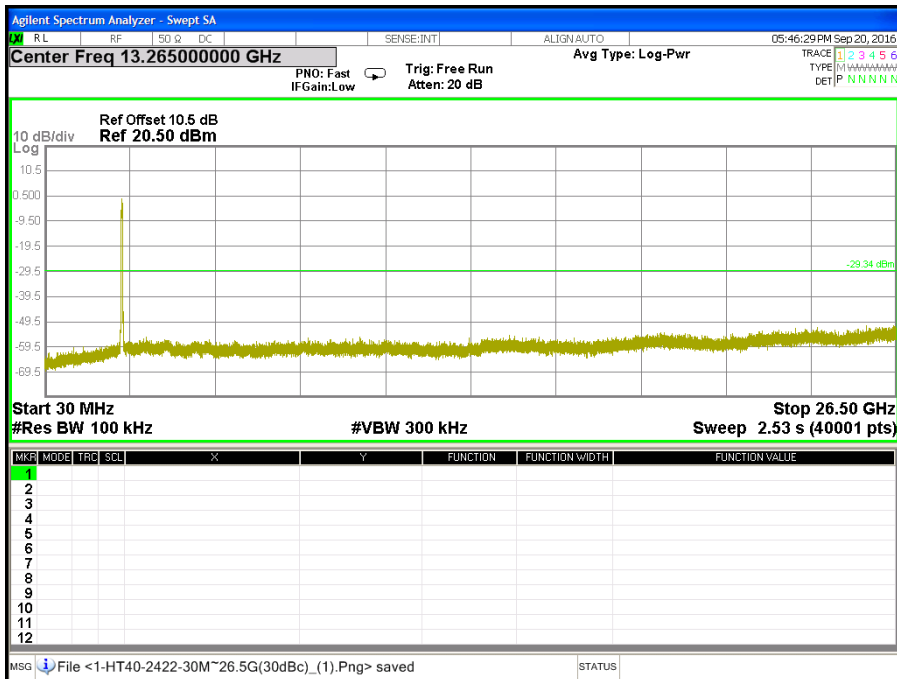

CH Middle (2.38GHz ~ 2.5GHz / IEEE 802.11gn HT40 MCS0 Mode / Chain 0)

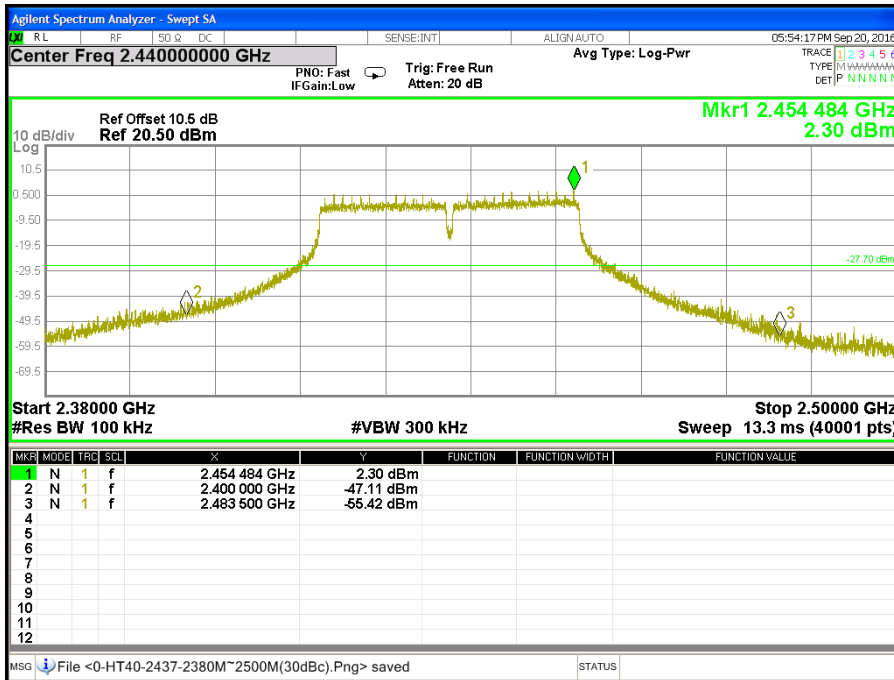

CH Middle (30MHz ~ 26.5GHz / IEEE 802.11gn HT40 MCS0 Mode / Chain 0)

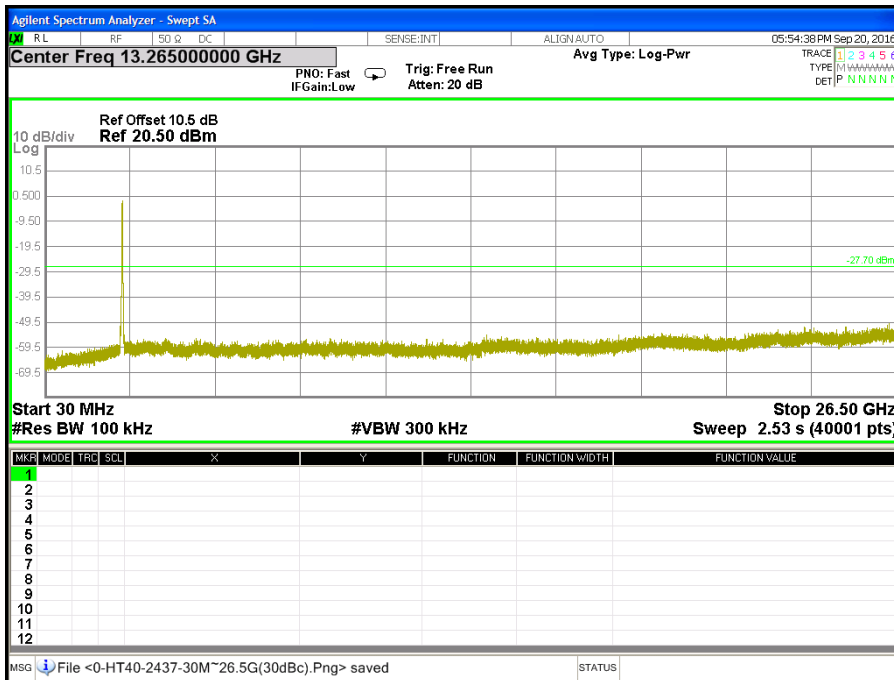

CH High (2.38GHz ~ 2.5GHz / IEEE 802.11gn HT40 MCS0 Mode / Chain 0)

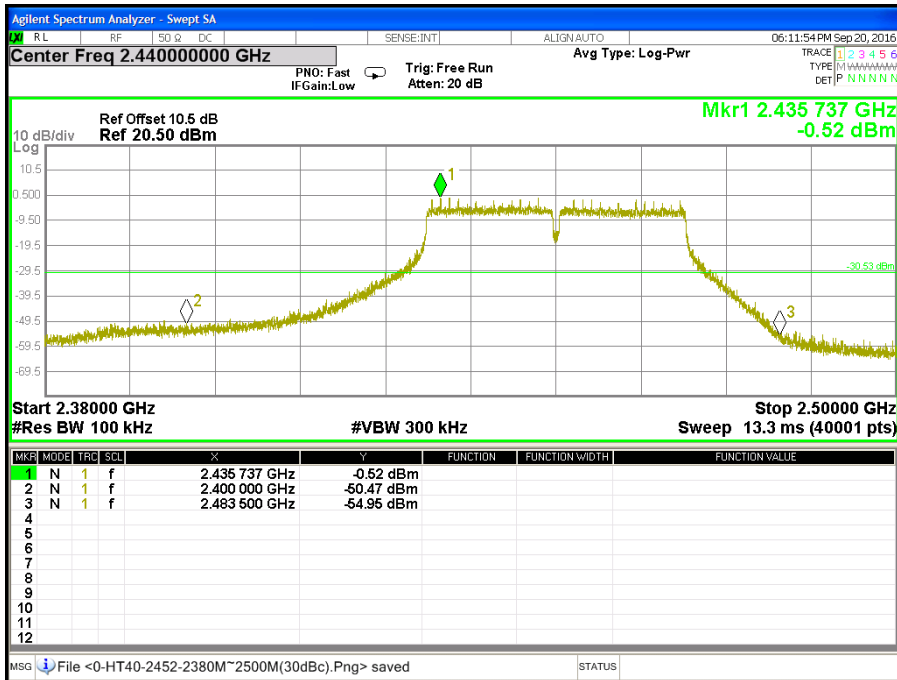

CH High (30MHz ~ 26.5GHz / IEEE 802.11gn HT40 MCS0 Mode / Chain 0)

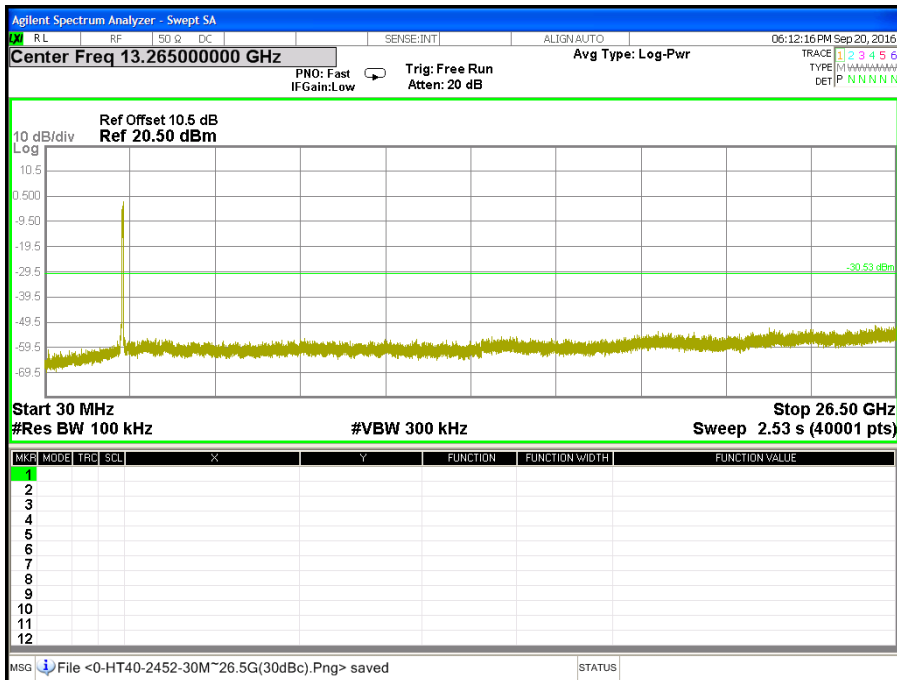

CH Low (2.38GHz ~ 2.5GHz / IEEE 802.11gn HT40 MCS0 Mode / Chain 1)

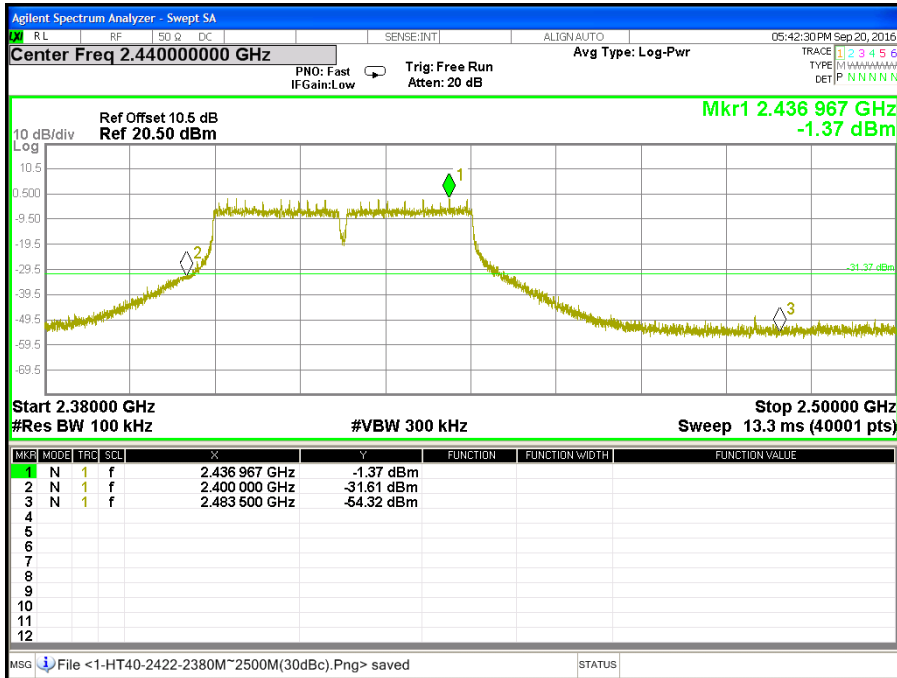

CH Low (30MHz ~ 26.5GHz / IEEE 802.11gn HT40 MCS0 Mode / Chain 1)

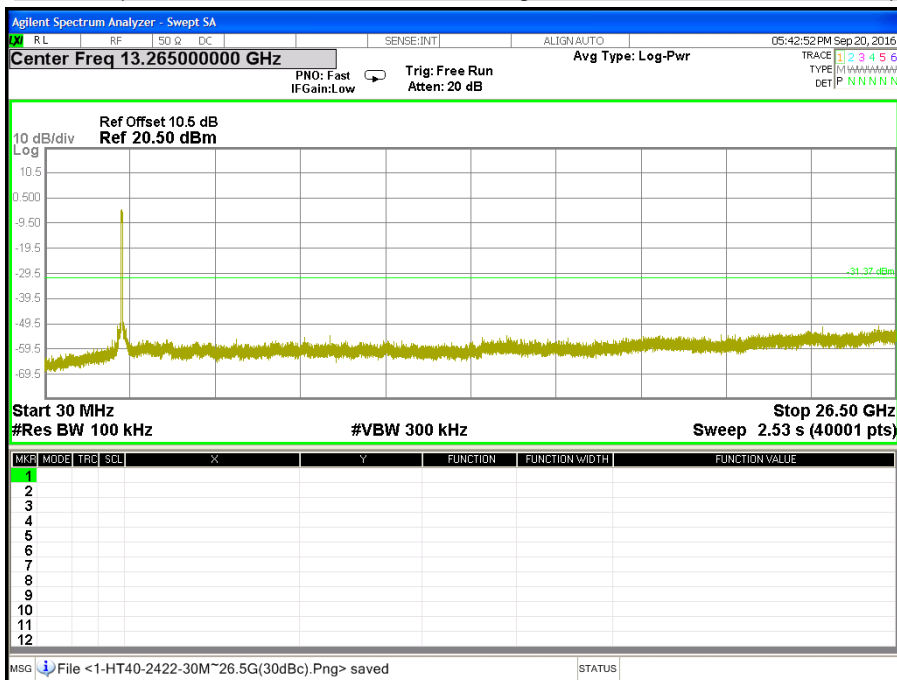

CH Middle (2.38GHz ~ 2.5GHz / IEEE 802.11gn HT40 MCS0 Mode / Chain 1)

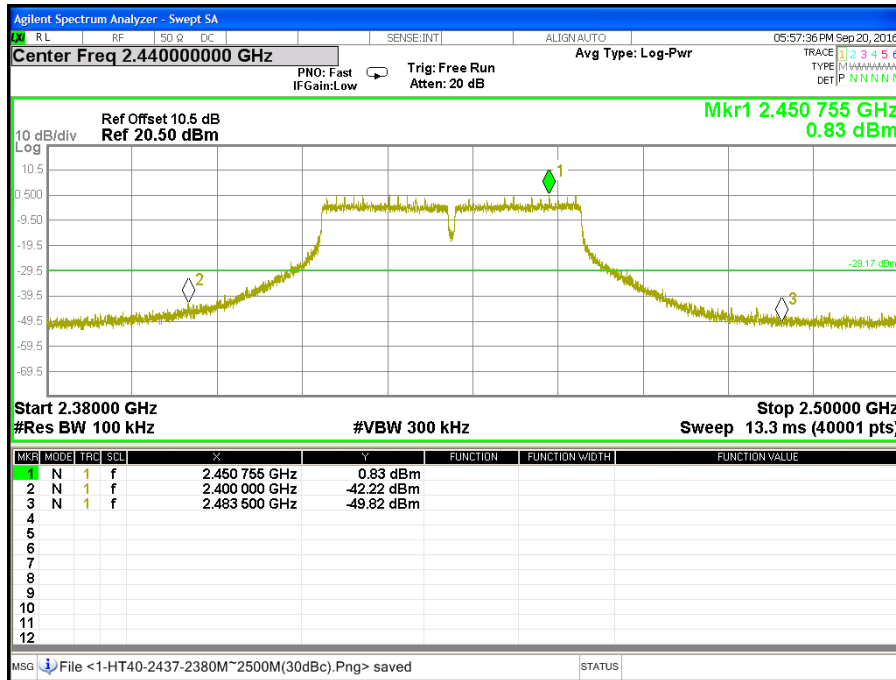

CH Middle (30MHz ~ 26.5GHz / IEEE 802.11gn HT40 MCS0 Mode / Chain 1)

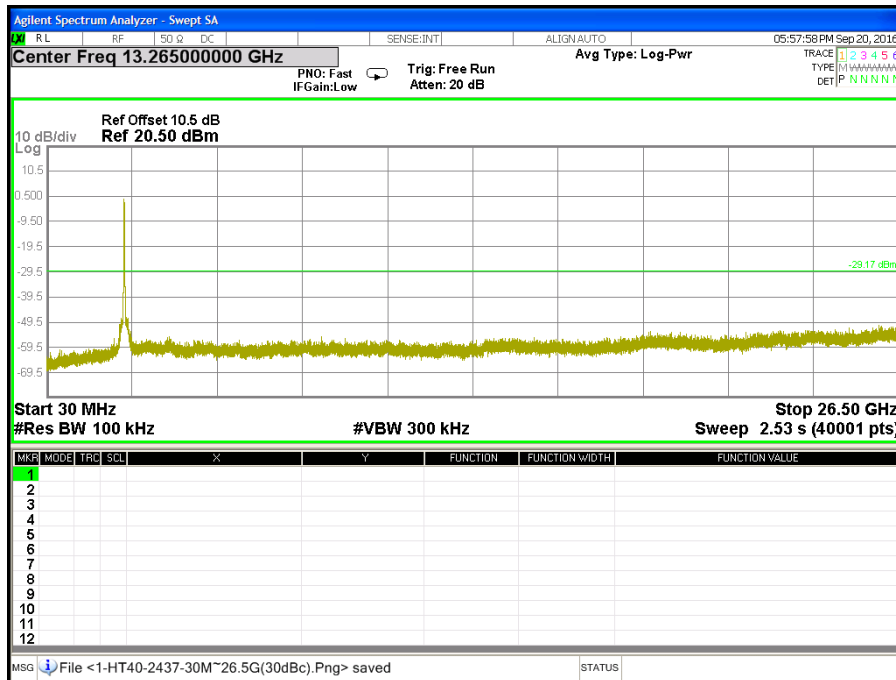

CH High (2.38GHz ~ 2.5GHz / IEEE 802.11gn HT40 MCS0 Mode / Chain 1)

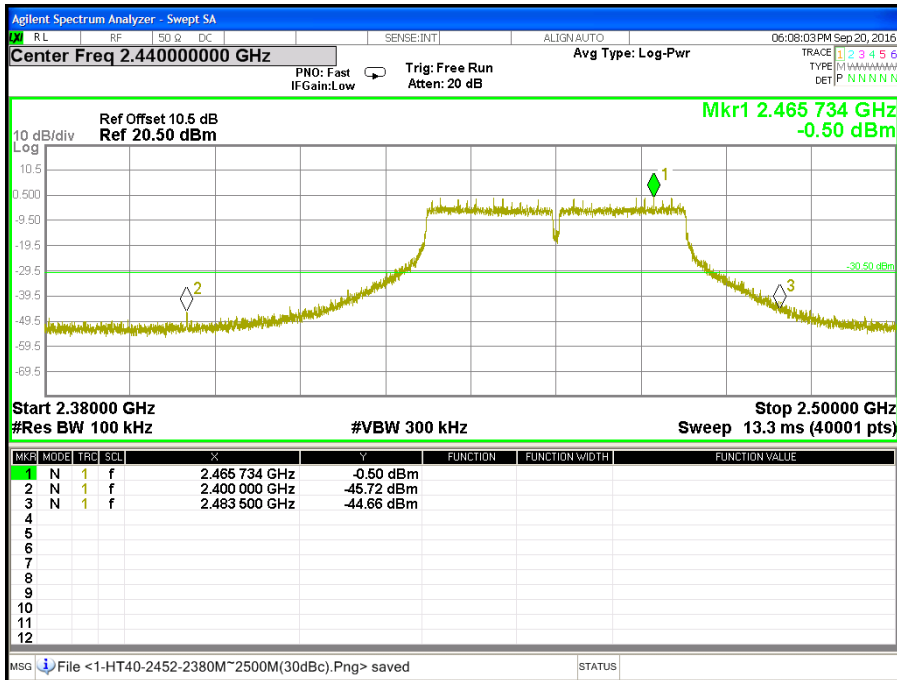

CH High (30MHz ~ 26.5GHz / IEEE 802.11gn HT40 MCS0 Mode / Chain 1)

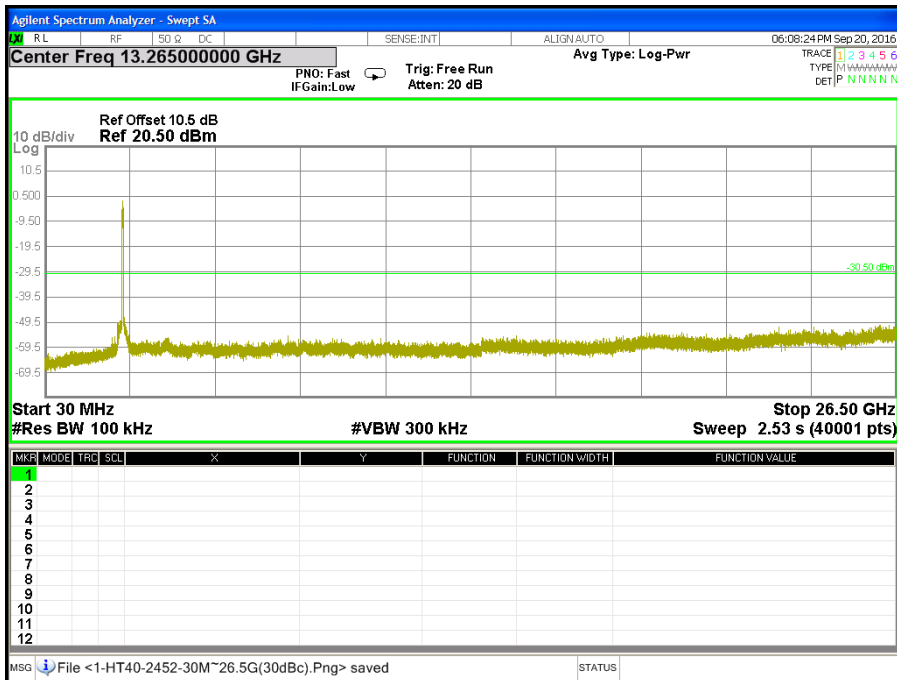

CH Low (2.38GHz ~ 2.5GHz / IEEE 802.11gn HT40 MCS0 Mode / Chain 2)

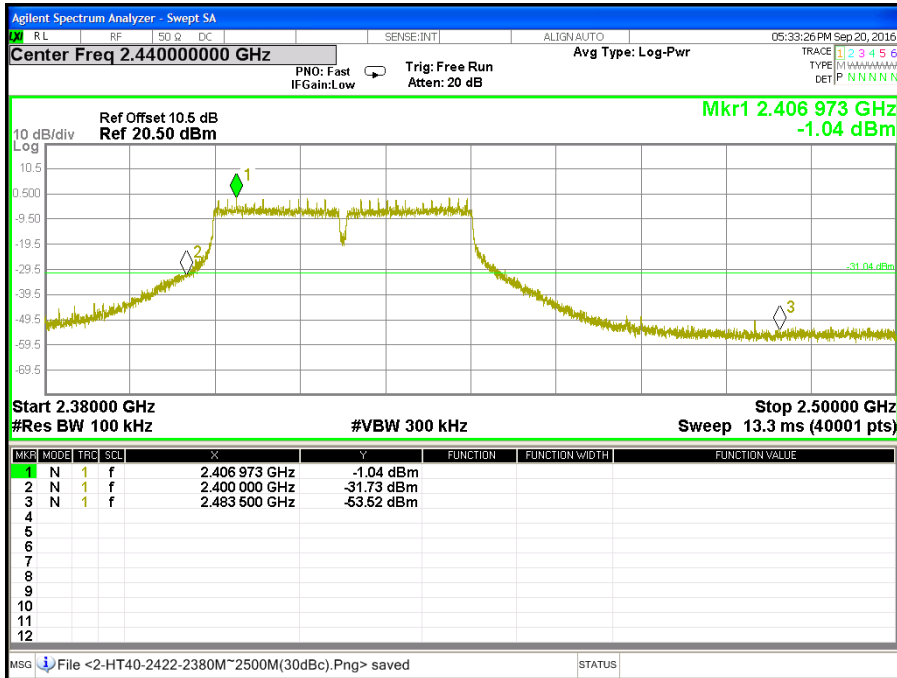

CH Low (30MHz ~ 26.5GHz / IEEE 802.11gn HT40 MCS0 Mode / Chain 2)

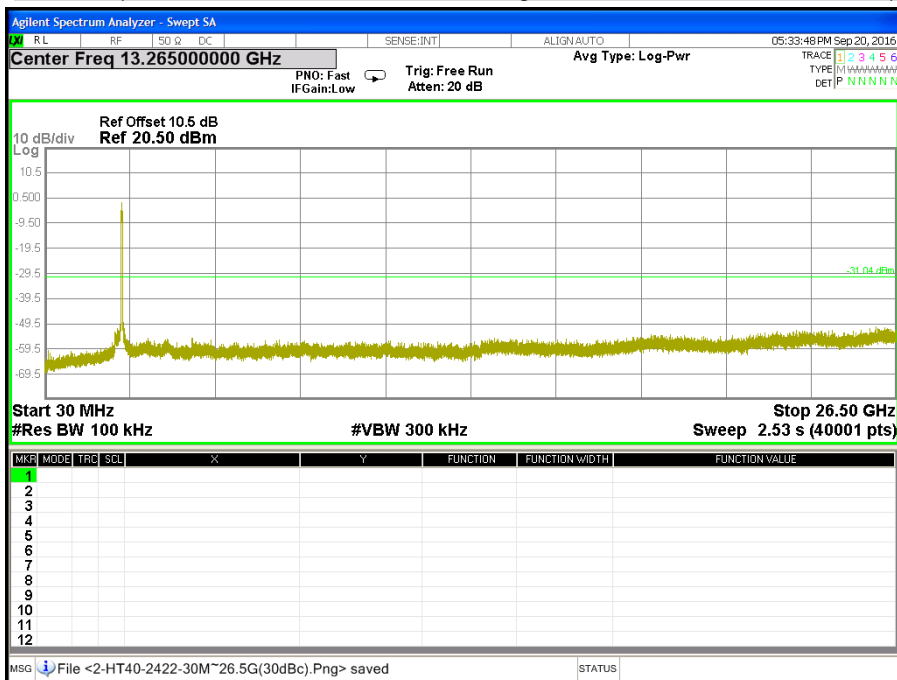

CH Middle (2.38GHz ~ 2.5GHz / IEEE 802.11gn HT40 MCS0 Mode / Chain 2)

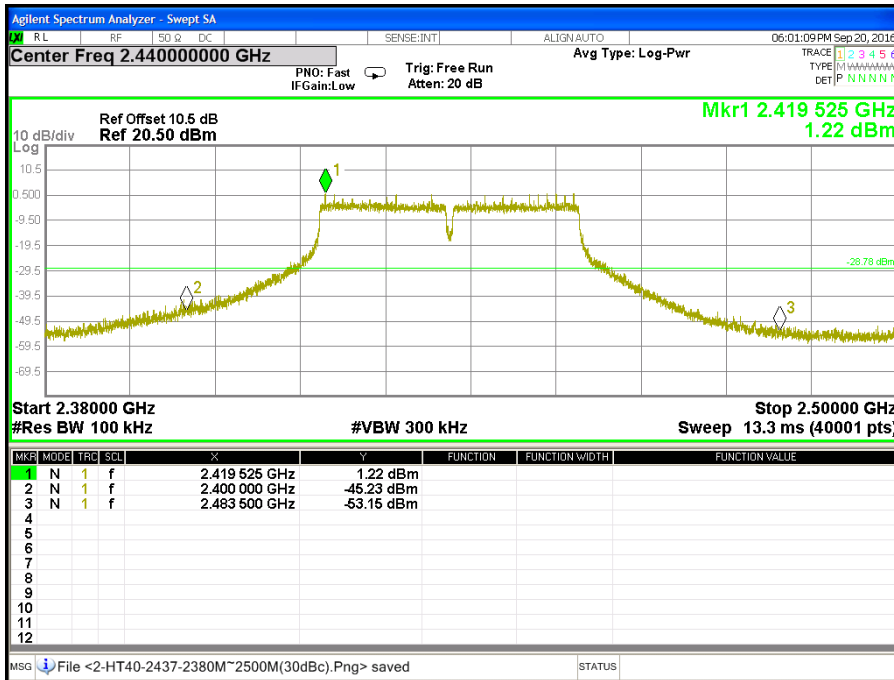

CH Middle (30MHz ~ 26.5GHz / IEEE 802.11gn HT40 MCS0 Mode / Chain 2)

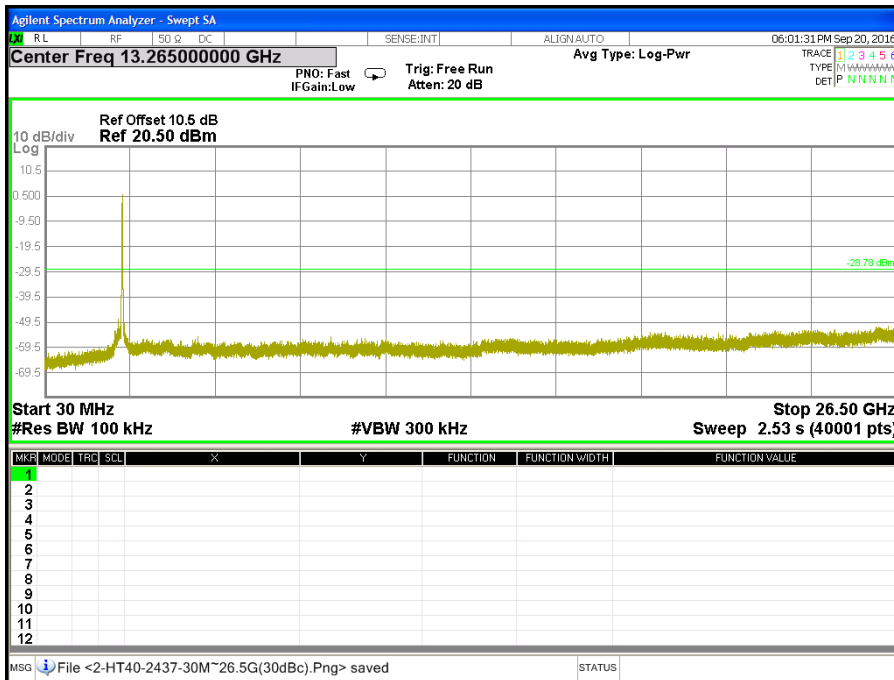

CH High (2.38GHz ~ 2.5GHz / IEEE 802.11gn HT40 MCS0 Mode / Chain 2)

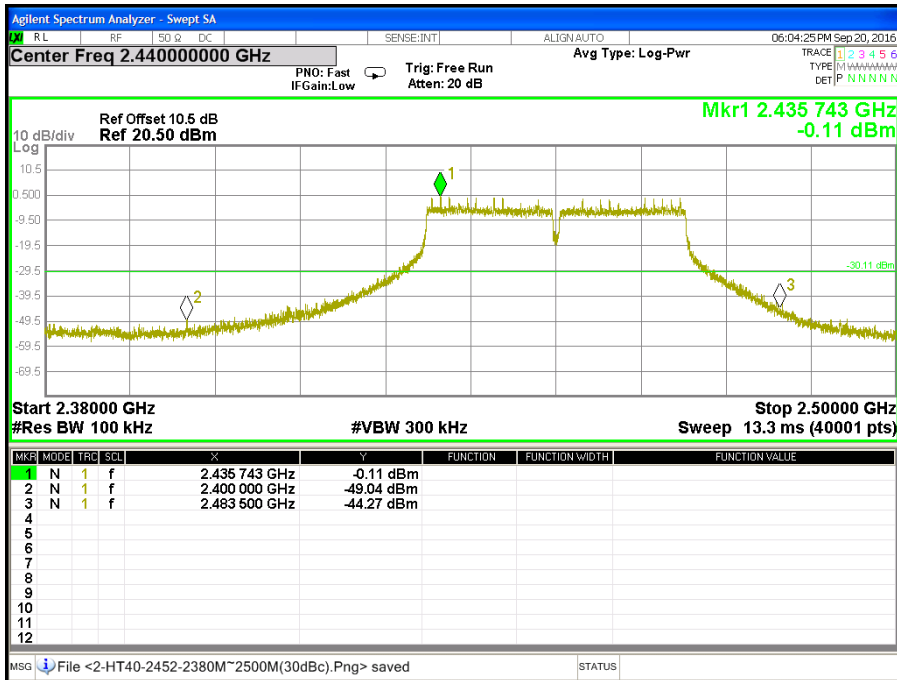

CH High (30MHz ~ 26.5GHz / IEEE 802.11gn HT40 MCS0 Mode / Chain 2)

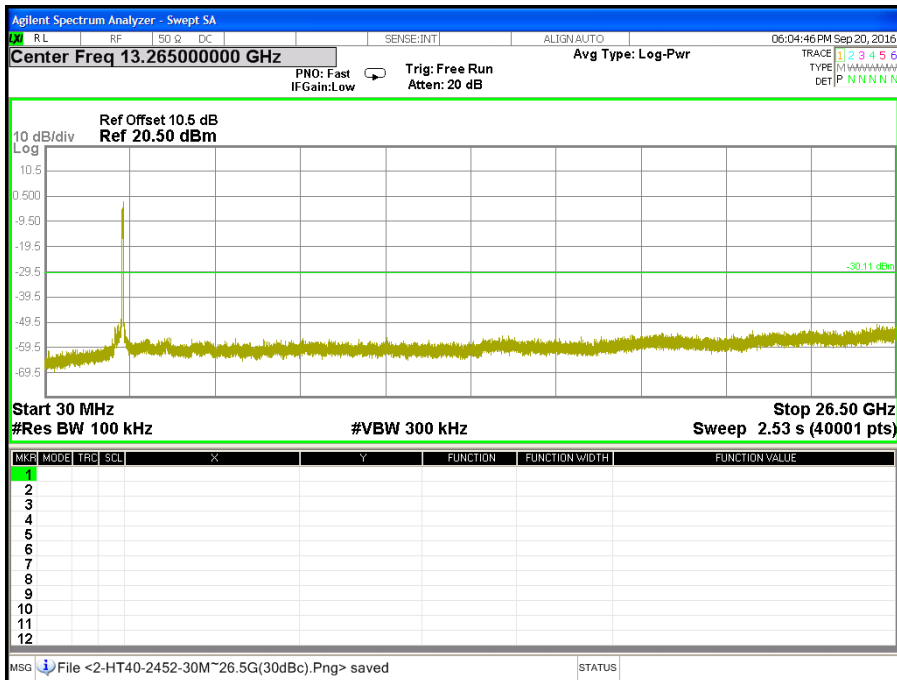

7.6 RADIATED EMISSION

LIMITS

(1) According to § 15.205 (a) Except as shown in paragraph (d) of this section, only spurious emissions are permitted in any of the frequency bands listed below:

MHz	MHz	MHz	GHz
0.090 - 0.110	16.42 - 16.423	399.9 - 410	4.5 - 5.15
¹ 0.495 - 0.505	16.69475 - 16.69525	608 - 614	5.35 - 5.46
2.1735 - 2.1905	16.80425 - 16.80475	960 - 1240	7.25 - 7.75
4.125 - 4.128	25.5 - 25.67	1300 - 1427	8.025 - 8.5
4.17725 - 4.17775	37.5 - 38.25	1435 - 1626.5	9.0 - 9.2
4.20725 - 4.20775	73 - 74.6	1645.5 - 1646.5	9.3 - 9.5
6.215 - 6.218	74.8 - 75.2	1660 - 1710	10.6 - 12.7
6.26775 - 6.26825	108 - 121.94	1718.8 - 1722.2	13.25 - 13.4
6.31175 - 6.31225	123 - 138	2200 - 2300	14.47 - 14.5
8.291 - 8.294	149.9 - 150.05	2310 - 2390	15.35 - 16.2
8.362 - 8.366	156.52475 - 156.52525	2483.5 - 2500	17.7 - 21.4
8.37625 - 8.38675	156.7 - 156.9	2655 - 2900	22.01 - 23.12
8.41425 - 8.41475	162.0125 - 167.17	3260 - 3267	23.6 - 24.0
12.29 - 12.293	167.72 - 173.2	3332 - 3339	31.2 - 31.8
12.51975 - 12.52025	240 - 285	3345.8 - 3338	36.43 - 36.5
12.57675 - 12.57725	322 - 335.4	3600 - 4400	(²)
13.36 - 13.41			

Remark:

1. ¹ Until February 1, 1999, this restricted band shall be 0.490-0.510 MHz.
2. ² Above 38.6

(2) According to § 15.205 (b) Except as provided in paragraphs (d) and (e), the field strength of emissions appearing within these frequency bands shall not exceed the limits shown in Section 15.209. At frequencies equal to or less than 1000 MHz, compliance with the limits in Section 15.209 shall be demonstrated using measurement instrumentation employing a CISPR quasi-peak detector. Above 1000 MHz, compliance with the emission limits in Section 15.209 shall be demonstrated based on the average value of the measured emissions. The provisions in Section 15.35 apply to these measurements.

(3) According to § 15.209 (a) Except as provided elsewhere in this Subpart, the emissions from an intentional radiator shall not exceed the field strength levels specified in the following table:

Frequency (MHz)	Field Strength (microvolts/meter)	Measurement Distance (meters)
0.009 – 0.490	2400/F(KHz)	300
0.490 – 1.705	24000/F(KHz)	30
1.705 – 30.0	30	30
30 - 88	100 **	3
88 - 216	150 **	3
216 - 960	200 **	3
Above 960	500	3

Remark: **Except as provided in paragraph (g), fundamental emissions from intentional radiators operating under this Section shall not be located in the frequency bands 54-72 MHz, 76-88 MHz, 174-216 MHz or 470-806 MHz. However, operation within these frequency bands is permitted under other sections of this Part, e.g., Sections 15.231 and 15.241.

(4) According to § 15.209 (b) In the emission table above, the tighter limit applies at the band edges.

TEST EQUIPMENT

Radiated Emission / 966Chamber_B

Name of Equipment	Manufacture	Model	Serial Number	Calibration Due
Spectrum Analyzer	Agilent	E4446A	MY46180323	04/12/2017
EMI Test Receiver	Rohde & Schwarz	ESCI	100221	04/26/2017
Bi-log Antenna	TESEQ	CBL 6112D	35403	07/02/2017
Broad-Band Horn Antenna	Schwarzbeck	BBHA 9120 D	9120D-778	07/14/2017
Double-Ridged Waveguide Horn	ETS-LINDGREN	3117	00078733	11/25/2016
Horn Antenna	COM-POWER	AH-840	03077	12/08/2016
Pre-Amplifier	Agilent	8447D	2944A10052	07/12/2017
Pre-Amplifier	Agilent	8449B	3008A01916	07/12/2017
LOOP Antenna	COM-POWER	AL-130	121060	05/23/2017
Test S/W	E3.815206a			

Remark: Each piece of equipment is scheduled for calibration once a year.

TEST SETUP

The diagram below shows the test setup that is utilized to make the measurements for emission below 1GHz.

9kHz ~ 30MHz

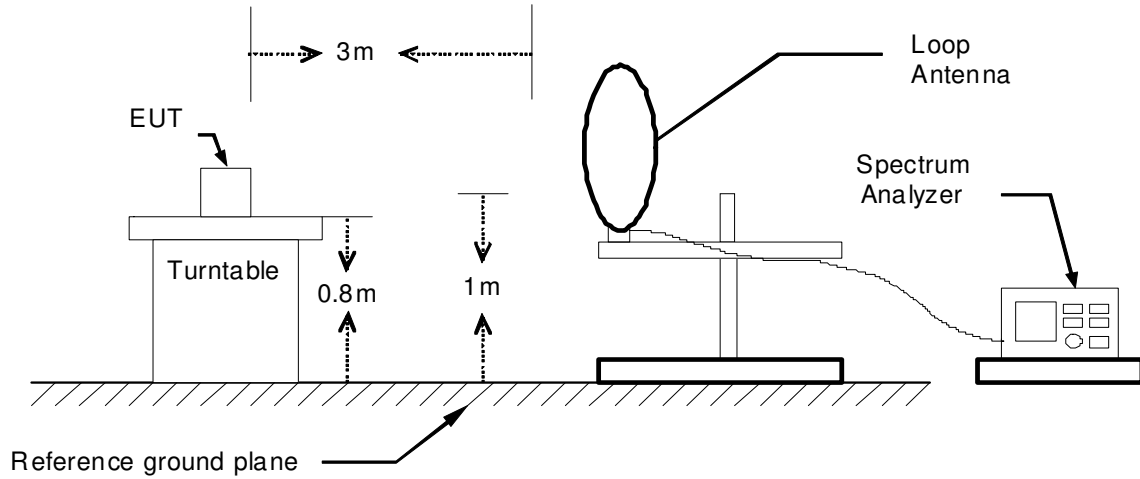

30MHz ~ 1GHz

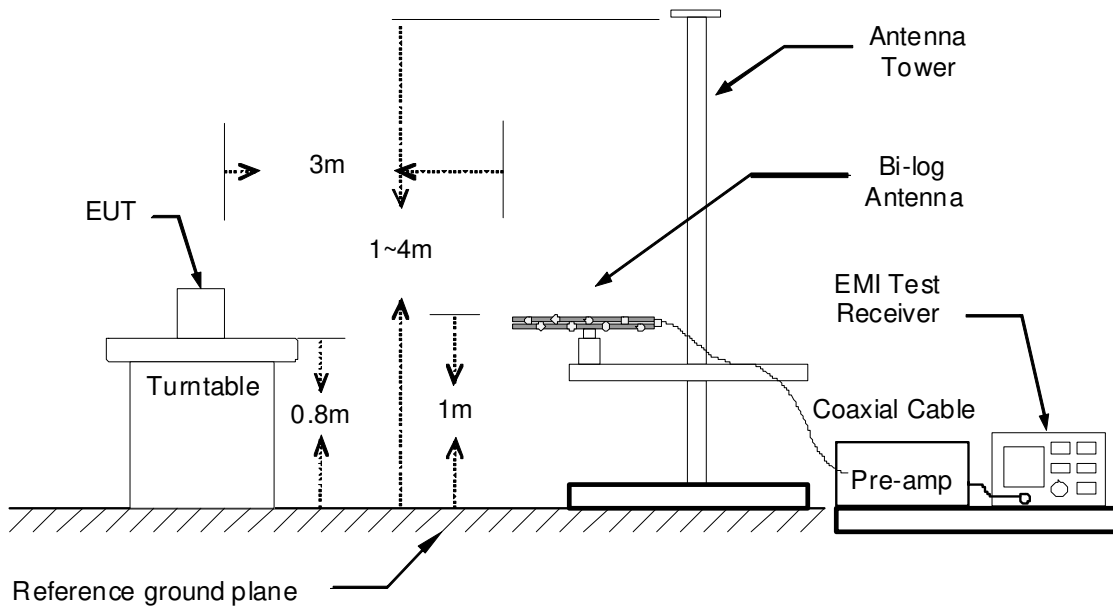

The diagram below shows the test setup that is utilized to make the measurements for emission above 1GHz.

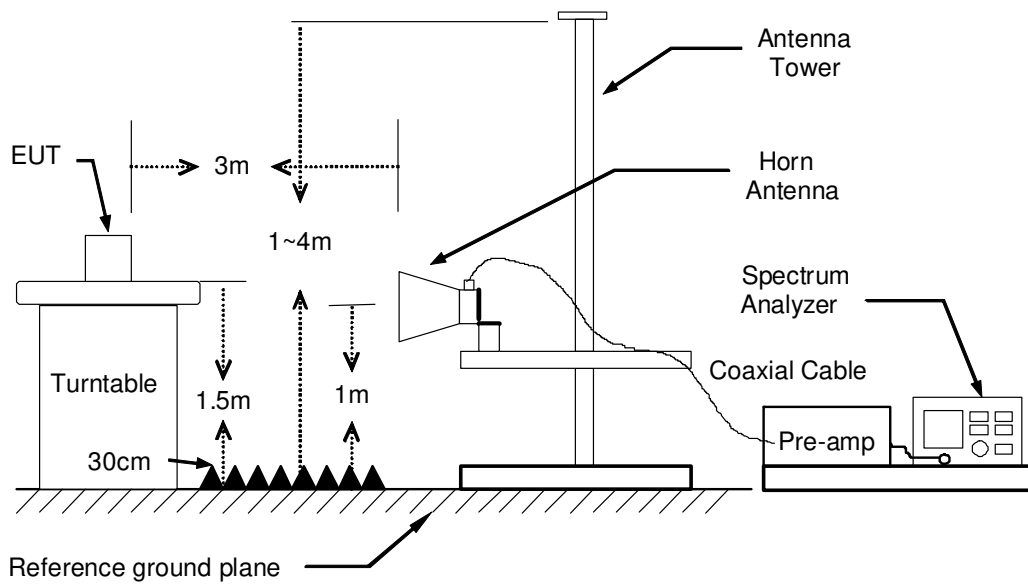

TEST PROCEDURE

1. The EUT was placed on the top of a rotating table 0.8 and 1.5 meters above the ground. The table was rotated 360 degrees to determine the position of the highest radiation.
2. While measuring the radiated emission below 1GHz, the EUT was set 3 meters away from the interference-receiving antenna, which was mounted on the top of a variable-height antenna tower. While measuring the radiated emission above 1GHz, the EUT was set 3 meters away from the interference-receiving antenna.
3. The antenna is a broadband antenna, and its height is varied from one meter to four meters above the ground to determine the maximum value of the field strength. Both horizontal and vertical polarization of the antenna are set to make the measurement.
4. For each suspected emission, the EUT was arranged to its worst case and then the antenna was tuned to heights from 1 meter to 4 meters and the table was turned from 0 degrees to 360 degrees to find the maximum reading.
5. The test-receiver system was set to Peak Detect Function and Specified Bandwidth with Maximum Hold mode.
6. If the emission level of the EUT in peak mode was 10 dB lower than the limit specified, then testing could be stopped and the peak values of the EUT would be reported. Otherwise the emissions that did not have 10 dB margin would be re-tested one by one using peak, quasi-peak or average method as specified and then reported in a data sheet.

Remark:

1. *The resolution bandwidth and video bandwidth of test receiver/spectrum analyzer is 120 KHz for Peak detection (PK) and Quasi-peak detection (QP) at frequency below 1GHz.*
2. *The resolution bandwidth and video bandwidth of test receiver/spectrum analyzer is 1 MHz for Peak detection and frequency above 1GHz.*
3. *The resolution bandwidth of test receiver/spectrum analyzer is 1 MHz and the video bandwidth is 10 Hz for Average detection (AV) at frequency above 1GHz.*

TEST RESULTS

Below 1 GHz (9kHz ~ 30MHz)

No emission found between lowest internal used/generated frequency to 30MHz.

Below 1 GHz (30MHz ~ 1GHz)

Product Name	DOCSIS 3.1 wifi Gateway	Test By	Waternil Guan
Test Model	CODA-4782	Test Date	2016/09/07
Test Mode	Mode 1	Temp. & Humidity	28°C, 54%

966Chamber_B at 3Meter / Horizontal

Freq. MHz	Reading dBuV	C.F. dB/m	Result dBuV/m	Limit dBuV/m	Margin dB	Azimuth deg	Height cm	Remark
102.75	47.43	-15.42	32.01	43.50	-11.49	225	100	Peak
157.07	49.29	-15.83	33.46	43.50	-10.04	93	200	Peak
250.19	45.01	-12.67	32.34	46.00	-13.66	254	100	Peak
400.54	39.71	-9.11	30.60	46.00	-15.40	76	100	Peak
506.27	40.03	-8.03	32.00	46.00	-14.00	117	100	Peak
600.36	49.70	-6.78	42.92	46.00	-3.08	124	100	QP
759.44	44.08	-4.84	39.24	46.00	-6.76	98	200	Peak
937.92	42.95	-2.55	40.40	46.00	-5.60	253	100	Peak

966Chamber_B at 3Meter / Vertical

Freq. MHz	Reading dBuV	C.F. dB/m	Result dBuV/m	Limit dBuV/m	Margin dB	Azimuth deg	Height cm	Remark
97.90	52.20	-16.07	36.13	43.50	-7.37	294	100	Peak
146.40	50.63	-15.19	35.44	43.50	-8.06	287	100	Peak
250.19	45.34	-12.67	32.67	46.00	-13.33	305	100	Peak
375.32	45.71	-9.66	36.05	46.00	-9.95	197	100	Peak
400.54	44.09	-9.11	34.98	46.00	-11.02	164	100	Peak
600.36	49.70	-6.78	42.92	46.00	-3.08	350	100	QP
888.45	38.98	-3.03	35.95	46.00	-10.05	172	100	Peak
937.92	43.41	-2.55	40.86	46.00	-5.14	188	100	Peak

Remark:

1. Quasi-peak test would be performed if the peak result were greater than the quasi-peak limit.
2. Correction Factor (dB/m) = Antenna Factor (dB/m) + Cable Loss (dB) – PreAmp.Gain (dB)
3. Result (dBuV/m) = Reading (dBuV) + Correction Factor (dB/m)
4. Margin (dB) = Remark result (dBuV/m) - Quasi-peak limit (dBuV/m).

Above 1 GHz

Product Name	DOCSIS 3.1 wifi Gateway	Test By	Waternil Guan
Test Model	CODA-4782	Test Date	2016/09/13
Test Mode	IEEE 802.11b Mode / TX / CH Low	Temp. & Humidity	26°C, 58%

966Chamber_B at 3Meter / Horizontal

Freq. MHz	Reading dBuV	C.F. dB/m	Result dBuV/m	Limit dBuV/m	Margin dB	Azimuth deg	Height cm	Remark
2240.00	55.16	-3.24	51.92	74.00	-22.08	138	100	Peak
2484.00	48.27	-2.25	46.02	54.00	-7.98	2	200	Average
2484.00	56.29	-2.25	54.04	74.00	-19.96	2	200	Peak
2494.00	50.41	-2.21	48.20	54.00	-5.80	360	200	Average
2494.00	58.41	-2.21	56.20	74.00	-17.80	360	200	Peak
4800.00	40.10	5.18	45.28	74.00	-28.72	266	100	Peak
4983.00	44.34	5.66	50.00	74.00	-24.00	172	200	Peak
6432.00	40.73	11.08	51.81	74.00	-22.19	173	200	Peak
7236.00	37.14	12.39	49.53	74.00	-24.47	332	100	Peak

966Chamber_B at 3Meter / Vertical

Freq. MHz	Reading dBuV	C.F. dB/m	Result dBuV/m	Limit dBuV/m	Margin dB	Azimuth deg	Height cm	Remark
2484.00	51.67	-2.25	49.42	54.00	-4.58	142	200	Average
2484.00	60.72	-2.25	58.47	74.00	-15.53	142	200	Peak
2490.00	53.63	-2.23	51.40	54.00	-2.60	138	200	Average
2490.00	64.03	-2.23	61.80	74.00	-12.20	138	200	Peak
2582.00	53.21	-1.95	51.26	54.00	-2.74	122	200	Average
2582.00	62.93	-1.95	60.98	74.00	-13.02	122	200	Peak
3216.00	48.43	-0.18	48.25	74.00	-25.75	113	200	Peak
4800.00	38.37	5.18	43.55	74.00	-30.45	10	200	Peak
7236.00	36.98	12.39	49.37	74.00	-24.63	202	200	Peak
7800.00	37.37	12.88	50.25	74.00	-23.75	100	100	Peak

Remark:

1. Measuring frequencies from 1 GHz to the 10th harmonic of highest fundamental frequency.
2. Average test would be performed if the peak result were greater than the average limit.
3. Measurements above show only up to 6 maximum emissions noted, or would be lesser, with " N/A " remark, if no specific emissions from the EUT are recorded (ie: margin>20dB from the applicable limit) and considered that's already beyond the background noise floor.
4. Result = Reading + Correction Factor
 Margin = Result – Limit
 Remark Peak = Result(PK) – Limit(PK)
 Remark AVG = Result(AV) – Limit(AV)

Product Name	DOCSIS 3.1 wifi Gateway	Test By	Waternil Guan
Test Model	CODA-4782	Test Date	2016/09/13
Test Mode	IEEE 802.11b Mode / TX / CH Middle	Temp. & Humidity	26°C, 58%

966Chamber_B at 3Meter / Horizontal

Freq. MHz	Reading dBuV	C.F. dB/m	Result dBuV/m	Limit dBuV/m	Margin dB	Azimuth deg	Height cm	Remark
2356.00	51.70	-2.77	48.93	54.00	-5.07	8	200	Average
2356.00	59.70	-2.77	56.93	74.00	-17.07	8	200	Peak
2390.00	46.49	-2.63	43.86	54.00	-10.14	160	200	Average
2390.00	55.48	-2.63	52.85	74.00	-21.15	160	200	Peak
2484.00	54.29	-2.25	52.04	74.00	-21.96	0	200	Peak
2520.00	49.38	-2.13	47.25	54.00	-6.75	190	200	Average
2520.00	57.39	-2.13	55.26	74.00	-18.74	190	200	Peak
6432.00	40.43	11.08	51.51	74.00	-22.49	171	200	Peak
7308.00	38.40	12.44	50.84	74.00	-23.16	302	100	Peak
4875.00	43.93	5.38	49.31	74.00	-24.69	301	200	Peak
4986.00	44.13	5.66	49.79	74.00	-24.21	172	200	Peak

966Chamber_B at 3Meter / Vertical

Freq. MHz	Reading dBuV	C.F. dB/m	Result dBuV/m	Limit dBuV/m	Margin dB	Azimuth deg	Height cm	Remark
2358.00	52.07	-2.76	49.31	54.00	-4.69	70	200	Average
2358.00	60.09	-2.76	57.33	74.00	-16.67	70	200	Peak
2390.00	51.43	-2.63	48.80	54.00	-5.20	148	200	Average
2390.00	59.43	-2.63	56.80	74.00	-17.20	148	200	Peak
2484.00	52.15	-2.25	49.90	54.00	-4.10	126	200	Average
2484.00	60.67	-2.25	58.42	74.00	-15.58	126	200	Peak
4530.00	42.49	4.48	46.97	74.00	-27.03	238	100	Peak
4800.00	39.67	5.18	44.85	74.00	-29.15	130	200	Peak
7092.00	37.93	12.30	50.23	74.00	-23.77	135	100	Peak
7308.00	39.88	12.44	52.32	74.00	-21.68	325	100	Peak

Remark:

1. Measuring frequencies from 1 GHz to the 10th harmonic of highest fundamental frequency.
2. Average test would be performed if the peak result were greater than the average limit.
3. Measurements above show only up to 6 maximum emissions noted, or would be lesser, with " N/A " remark, if no specific emissions from the EUT are recorded (ie: margin>20dB from the applicable limit) and considered that's already beyond the background noise floor.
4. Result = Reading + Correction Factor
 Margin = Result – Limit
 Remark Peak = Result(PK) – Limit(PK)
 Remark AVG = Result(AV) – Limit(AV)

Product Name	DOCSIS 3.1 wifi Gateway	Test By	Waternil Guan
Test Model	CODA-4782	Test Date	2016/09/13
Test Mode	IEEE 802.11b Mode / TX / CH High	Temp. & Humidity	26°C, 58%

966Chamber_B at 3Meter / Horizontal

Freq. MHz	Reading dBuV	C.F. dB/m	Result dBuV/m	Limit dBuV/m	Margin dB	Azimuth deg	Height cm	Remark
1196.00	54.46	-8.06	46.40	54.00	-7.60	17	100	Average
1196.00	62.19	-8.06	54.13	74.00	-19.87	17	100	Peak
2382.00	52.31	-2.67	49.64	54.00	-4.36	168	200	Average
2382.00	62.34	-2.67	59.67	74.00	-14.33	168	200	Peak
2390.00	47.82	-2.63	45.19	54.00	-8.81	188	100	Average
2390.00	57.90	-2.63	55.27	74.00	-18.73	188	100	Peak
4926.00	36.20	5.51	41.71	74.00	-32.29	132	200	Peak
4989.00	44.40	5.67	50.07	74.00	-23.93	152	200	Peak
6432.00	40.98	11.08	52.06	74.00	-21.94	178	200	Peak
7404.00	36.63	12.50	49.13	74.00	-24.87	40	100	Peak

966Chamber_B at 3Meter / Vertical

Freq. MHz	Reading dBuV	C.F. dB/m	Result dBuV/m	Limit dBuV/m	Margin dB	Azimuth deg	Height cm	Remark
1800.00	55.00	-4.95	50.05	74.00	-23.95	221	100	Peak
2380.00	55.09	-2.67	52.42	54.00	-1.58	95	200	Average
2380.00	63.75	-2.67	61.08	74.00	-12.92	95	200	Peak
2390.00	50.53	-2.63	47.90	54.00	-6.10	152	200	Average
2390.00	60.53	-2.63	57.90	74.00	-16.10	152	200	Peak
3216.00	46.44	-0.18	46.26	74.00	-27.74	132	200	Peak
4920.00	36.86	5.49	42.35	74.00	-31.65	112	200	Peak
6432.00	37.69	11.08	48.77	74.00	-25.23	139	200	Peak
7380.00	38.35	12.48	50.83	74.00	-23.17	39	100	Peak

Remark:

1. Measuring frequencies from 1 GHz to the 10th harmonic of highest fundamental frequency.
2. Average test would be performed if the peak result were greater than the average limit.
3. Measurements above show only up to 6 maximum emissions noted, or would be lesser, with " N/A " remark, if no specific emissions from the EUT are recorded (ie: margin>20dB from the applicable limit) and considered that's already beyond the background noise floor.
4. Result = Reading + Correction Factor
 Margin = Result - Limit
 Remark Peak = Result(PK) - Limit(PK)
 Remark AVG = Result(AV) - Limit(AV)

Product Name	DOCSIS 3.1 wifi Gateway	Test By	Waternil Guan
Test Model	CODA-4782	Test Date	2016/09/13
Test Mode	IEEE 802.11g Mode / TX / CH Low	Temp. & Humidity	26°C, 58%

966Chamber_B at 3Meter / Horizontal

Freq. MHz	Reading dBuV	C.F. dB/m	Result dBuV/m	Limit dBuV/m	Margin dB	Azimuth deg	Height cm	Remark
1196.00	54.37	-8.06	46.31	54.00	-7.69	231	100	Average
1196.00	62.39	-8.06	54.33	74.00	-19.67	231	100	Peak
1800.00	55.69	-4.95	50.74	74.00	-23.26	153	200	Peak
2484.00	48.67	-2.25	46.42	54.00	-7.58	0	200	Average
2484.00	58.64	-2.25	56.39	74.00	-17.61	0	200	Peak
4800.00	40.04	5.18	45.22	74.00	-28.78	267	100	Peak
4977.00	44.23	5.64	49.87	74.00	-24.13	165	200	Peak
6432.00	40.12	11.08	51.20	74.00	-22.80	182	200	Peak
7800.00	37.86	12.88	50.74	74.00	-23.26	22	100	Peak

966Chamber_B at 3Meter / Vertical

Freq. MHz	Reading dBuV	C.F. dB/m	Result dBuV/m	Limit dBuV/m	Margin dB	Azimuth deg	Height cm	Remark
1196.00	58.95	-8.06	50.89	74.00	-23.11	327	100	Peak
1800.00	55.62	-4.95	50.67	74.00	-23.33	85	200	Peak
2484.00	52.77	-2.25	50.52	54.00	-3.48	137	200	Average
2484.00	62.71	-2.25	60.46	74.00	-13.54	137	200	Peak
3216.00	46.63	-0.18	46.45	74.00	-27.55	114	200	Peak
4800.00	39.00	5.18	44.18	74.00	-29.82	132	200	Peak
6432.00	37.99	11.08	49.07	74.00	-24.93	134	200	Peak
7236.00	30.65	12.39	43.04	54.00	-10.96	255	200	Average
7236.00	42.55	12.39	54.94	74.00	-19.06	255	200	Peak

Remark:

1. Measuring frequencies from 1 GHz to the 10th harmonic of highest fundamental frequency.
2. Average test would be performed if the peak result were greater than the average limit.
3. Measurements above show only up to 6 maximum emissions noted, or would be lesser, with " N/A " remark, if no specific emissions from the EUT are recorded (ie: margin>20dB from the applicable limit) and considered that's already beyond the background noise floor.
4. Result = Reading + Correction Factor
 Margin = Result – Limit
 Remark Peak = Result(PK) – Limit(PK)
 Remark AVG = Result(AV) – Limit(AV)

Product Name	DOCSIS 3.1 wifi Gateway	Test By	Waternil Guan
Test Model	CODA-4782	Test Date	2016/09/13
Test Mode	IEEE 802.11g Mode / TX / CH Middle	Temp. & Humidity	26°C, 58%

966Chamber_B at 3Meter / Horizontal

Freq. MHz	Reading dBuV	C.F. dB/m	Result dBuV/m	Limit dBuV/m	Margin dB	Azimuth deg	Height cm	Remark
2360.00	52.60	-2.76	49.84	54.00	-4.16	341	200	Average
2360.00	59.61	-2.76	56.85	74.00	-17.15	341	200	Peak
2390.00	51.48	-2.63	48.85	54.00	-5.15	307	100	Average
2390.00	58.48	-2.63	55.85	74.00	-18.15	307	100	Peak
2484.00	49.57	-2.25	47.32	54.00	-6.68	0	200	Average
2484.00	57.57	-2.25	55.32	74.00	-18.68	0	200	Peak
4200.00	46.50	3.31	49.81	74.00	-24.19	313	200	Peak
4875.00	40.82	5.38	46.20	74.00	-27.80	311	200	Peak
7308.00	37.82	12.44	50.26	54.00	-3.74	282	100	Average
7308.00	47.72	12.44	60.16	74.00	-13.84	282	100	Peak
7800.00	39.45	12.88	52.33	74.00	-21.67	10	200	Peak

966Chamber_B at 3Meter / Vertical

Freq. MHz	Reading dBuV	C.F. dB/m	Result dBuV/m	Limit dBuV/m	Margin dB	Azimuth deg	Height cm	Remark
2390.00	55.59	-2.63	52.96	54.00	-1.04	359	100	Average
2390.00	65.59	-2.63	62.96	74.00	-11.04	359	100	Peak
2484.00	53.21	-2.25	50.96	54.00	-3.04	68	200	Average
2484.00	62.21	-2.25	59.96	74.00	-14.04	68	200	Peak
2524.00	54.81	-2.12	52.69	54.00	-1.31	109	200	Average
2524.00	64.80	-2.12	62.68	74.00	-11.32	109	200	Peak
3216.00	46.42	-0.18	46.24	74.00	-27.76	109	200	Peak
4869.00	37.67	5.36	43.03	74.00	-30.97	58	100	Peak
6432.00	37.84	11.08	48.92	74.00	-25.08	128	200	Peak
7308.00	40.00	12.44	52.44	54.00	-1.56	179	200	Average
7308.00	50.22	12.44	62.66	74.00	-11.34	179	200	Peak

Remark:

1. Measuring frequencies from 1 GHz to the 10th harmonic of highest fundamental frequency.
2. Average test would be performed if the peak result were greater than the average limit.
3. Measurements above show only up to 6 maximum emissions noted, or would be lesser, with " N/A " remark, if no specific emissions from the EUT are recorded (ie: margin>20dB from the applicable limit) and considered that's already beyond the background noise floor.
4. Result = Reading + Correction Factor
 Margin = Result – Limit
 Remark Peak = Result(PK) – Limit(PK)
 Remark AVG = Result(AV) – Limit(AV)

Product Name	DOCSIS 3.1 wifi Gateway	Test By	Waternil Guan
Test Model	CODA-4782	Test Date	2016/09/13
Test Mode	IEEE 802.11g Mode / TX / CH High	Temp. & Humidity	26°C, 58%

966Chamber_B at 3Meter / Horizontal

Freq. MHz	Reading dBuV	C.F. dB/m	Result dBuV/m	Limit dBuV/m	Margin dB	Azimuth deg	Height cm	Remark
1198.00	57.44	-8.05	49.39	54.00	-4.61	220	100	Average
1198.00	65.48	-8.05	57.43	74.00	-16.57	220	100	Peak
2390.00	49.12	-2.63	46.49	54.00	-7.51	192	100	Average
2390.00	56.36	-2.63	53.73	74.00	-20.27	192	100	Peak
2484.00	53.07	-2.25	50.82	54.00	-3.18	159	200	Average
2484.00	61.06	-2.25	58.81	74.00	-15.19	159	200	Peak
4923.00	36.89	5.50	42.39	74.00	-31.61	24	100	Peak
4986.00	44.50	5.66	50.16	74.00	-23.84	165	200	Peak
7380.00	37.60	12.48	50.08	74.00	-23.92	161	200	Peak
7800.00	39.87	12.88	52.75	74.00	-21.25	12	200	Peak

966Chamber_B at 3Meter / Vertical

Freq. MHz	Reading dBuV	C.F. dB/m	Result dBuV/m	Limit dBuV/m	Margin dB	Azimuth deg	Height cm	Remark
1196.00	60.25	-8.06	52.19	74.00	-21.81	349	200	Peak
2390.00	54.82	-2.63	52.19	54.00	-1.81	46	200	Average
2390.00	64.87	-2.63	62.24	74.00	-11.76	46	200	Peak
2540.00	54.26	-2.07	52.19	54.00	-1.81	128	200	Average
2540.00	64.77	-2.07	62.70	74.00	-11.30	128	200	Peak
3216.00	47.14	-0.18	46.96	74.00	-27.04	112	200	Peak
4920.00	36.16	5.49	41.65	74.00	-32.35	225	200	Peak
6552.00	37.48	11.33	48.81	74.00	-25.19	197	100	Peak
7380.00	39.45	12.48	51.93	74.00	-22.07	170	100	Peak

Remark:

1. Measuring frequencies from 1 GHz to the 10th harmonic of highest fundamental frequency.
2. Average test would be performed if the peak result were greater than the average limit.
3. Measurements above show only up to 6 maximum emissions noted, or would be lesser, with " N/A " remark, if no specific emissions from the EUT are recorded (ie: margin>20dB from the applicable limit) and considered that's already beyond the background noise floor.
4. Result = Reading + Correction Factor
 Margin = Result – Limit
 Remark Peak = Result(PK) – Limit(PK)
 Remark AVG = Result(AV) – Limit(AV)

Product Name	DOCSIS 3.1 wifi Gateway	Test By	Waternil Guan
Test Model	CODA-4782	Test Date	2016/09/13
Test Mode	IEEE 802.11gn HT20 MCS0 Mode / TX / CH Low	Temp. & Humidity	26°C, 58%

966Chamber_B at 3Meter / Horizontal

Freq. MHz	Reading dBuV	C.F. dB/m	Result dBuV/m	Limit dBuV/m	Margin dB	Azimuth deg	Height cm	Remark
1800.00	56.46	-4.95	51.51	74.00	-22.49	117	200	Peak
2484.00	49.28	-2.25	47.03	54.00	-6.97	14	200	Average
2484.00	56.23	-2.25	53.98	74.00	-20.02	14	200	Peak
2498.00	50.17	-2.20	47.97	54.00	-6.03	0	200	Average
2498.00	57.71	-2.20	55.51	74.00	-18.49	0	200	Peak
4800.00	39.83	5.18	45.01	74.00	-28.99	267	100	Peak
4980.00	43.51	5.65	49.16	74.00	-24.84	165	200	Peak
7212.00	36.33	12.38	48.71	74.00	-25.29	254	100	Peak
7800.00	40.31	12.88	53.19	74.00	-20.81	19	200	Peak

966Chamber_B at 3Meter / Vertical

Freq. MHz	Reading dBuV	C.F. dB/m	Result dBuV/m	Limit dBuV/m	Margin dB	Azimuth deg	Height cm	Remark
1972.00	53.97	-4.31	49.66	74.00	-24.34	134	200	Peak
2484.00	50.32	-2.25	48.07	54.00	-5.93	106	200	Average
2484.00	57.32	-2.25	55.07	74.00	-18.93	106	200	Peak
2492.00	52.33	-2.22	50.11	54.00	-3.89	119	200	Average
2492.00	59.32	-2.22	57.10	74.00	-16.90	119	200	Peak
3216.00	46.26	-0.18	46.08	74.00	-27.92	106	200	Peak
4800.00	38.73	5.18	43.91	74.00	-30.09	129	200	Peak
7236.00	36.25	12.39	48.64	74.00	-25.36	332	100	Peak
8016.00	36.45	13.11	49.56	74.00	-24.44	116	200	Peak

Remark:

1. Measuring frequencies from 1 GHz to the 10th harmonic of highest fundamental frequency.
2. Average test would be performed if the peak result were greater than the average limit.
3. Measurements above show only up to 6 maximum emissions noted, or would be lesser, with " N/A " remark, if no specific emissions from the EUT are recorded (ie: margin>20dB from the applicable limit) and considered that's already beyond the background noise floor.
4. Result = Reading + Correction Factor
 Margin = Result - Limit
 Remark Peak = Result(PK) - Limit(PK)
 Remark AVG = Result(AV) - Limit(AV)

Product Name	DOCSIS 3.1 wifi Gateway	Test By	Waternil Guan
Test Model	CODA-4782	Test Date	2016/09/13
Test Mode	IEEE 802.11gn HT20 MCS0 Mode / TX / CH Middle	Temp. & Humidity	26°C, 58%

966Chamber_B at 3Meter / Horizontal

Freq. MHz	Reading dBuV	C.F. dB/m	Result dBuV/m	Limit dBuV/m	Margin dB	Azimuth deg	Height cm	Remark
2360.00	53.45	-2.76	50.69	54.00	-3.31	1	200	Average
2360.00	60.46	-2.76	57.70	74.00	-16.30	1	200	Peak
2390.00	53.66	-2.63	51.03	54.00	-2.97	252	100	Average
2390.00	60.27	-2.63	57.64	74.00	-16.36	252	100	Peak
2484.00	52.28	-2.25	50.03	54.00	-3.97	23	200	Average
2484.00	58.26	-2.25	56.01	74.00	-17.99	23	200	Peak
4866.00	42.49	5.35	47.84	74.00	-26.16	255	200	Peak
4977.00	45.07	5.64	50.71	74.00	-23.29	168	200	Peak
7308.00	36.98	12.44	49.42	54.00	-4.58	144	100	Average
7308.00	46.79	12.44	59.23	74.00	-14.77	144	100	Peak
7800.00	39.47	12.88	52.35	74.00	-21.65	9	200	Peak

966Chamber_B at 3Meter / Vertical

Freq. MHz	Reading dBuV	C.F. dB/m	Result dBuV/m	Limit dBuV/m	Margin dB	Azimuth deg	Height cm	Remark
2390.00	55.04	-2.63	52.41	54.00	-1.59	359	200	Average
2390.00	65.77	-2.63	63.14	74.00	-10.86	359	200	Peak
2484.00	53.24	-2.25	50.99	54.00	-3.01	176	200	Average
2484.00	61.18	-2.25	58.93	74.00	-15.07	176	200	Peak
2520.00	55.30	-2.13	53.17	54.00	-0.83	137	200	Average
2520.00	64.30	-2.13	62.17	74.00	-11.83	137	200	Peak
4200.00	42.16	3.31	45.47	74.00	-28.53	226	100	Peak
4914.00	36.69	5.48	42.17	74.00	-31.83	304	200	Peak
7308.00	40.68	12.44	53.12	54.00	-0.88	178	200	Average
7308.00	51.20	12.44	63.64	74.00	-10.36	178	200	Peak
7800.00	36.83	12.88	49.71	74.00	-24.29	245	100	Peak

Remark:

1. Measuring frequencies from 1 GHz to the 10th harmonic of highest fundamental frequency.
2. Average test would be performed if the peak result were greater than the average limit.
3. Measurements above show only up to 6 maximum emissions noted, or would be lesser, with " N/A " remark, if no specific emissions from the EUT are recorded (ie: margin>20dB from the applicable limit) and considered that's already beyond the background noise floor.
4. Result = Reading + Correction Factor
 Margin = Result – Limit
 Remark Peak = Result(PK) – Limit(PK)
 Remark AVG = Result(AV) – Limit(AV)

Product Name	DOCSIS 3.1 wifi Gateway	Test By	Waternil Guan
Test Model	CODA-4782	Test Date	2016/09/13
Test Mode	IEEE 802.11gn HT20 MCS0 Mode / TX / CH High	Temp. & Humidity	26°C, 58%

966Chamber_B at 3Meter / Horizontal

Freq. MHz	Reading dBuV	C.F. dB/m	Result dBuV/m	Limit dBuV/m	Margin dB	Azimuth deg	Height cm	Remark
1012.00	59.84	-9.26	50.58	74.00	-23.42	47	100	Peak
1800.00	55.59	-4.95	50.64	74.00	-23.36	29	100	Peak
2390.00	48.24	-2.63	45.61	54.00	-8.39	139	100	Average
2390.00	55.24	-2.63	52.61	74.00	-21.39	139	100	Peak
4923.00	37.09	5.50	42.59	74.00	-31.41	309	200	Peak
4983.00	44.45	5.66	50.11	74.00	-23.89	167	200	Peak
7380.00	35.75	12.48	48.23	74.00	-25.77	242	200	Peak
7800.00	39.60	12.88	52.48	74.00	-21.52	360	200	Peak

966Chamber_B at 3Meter / Vertical

Freq. MHz	Reading dBuV	C.F. dB/m	Result dBuV/m	Limit dBuV/m	Margin dB	Azimuth deg	Height cm	Remark
1200.00	57.09	-8.03	49.06	74.00	-24.94	292	100	Peak
1800.00	54.96	-4.95	50.01	74.00	-23.99	78	200	Peak
2390.00	52.68	-2.63	50.05	54.00	-3.95	56	200	Average
2390.00	58.68	-2.63	56.05	74.00	-17.95	56	200	Peak
4923.00	36.19	5.50	41.69	74.00	-32.31	114	200	Peak
4986.00	38.39	5.66	44.05	74.00	-29.95	136	100	Peak
7380.00	38.26	12.48	50.74	74.00	-23.26	22	100	Peak
9804.00	37.02	14.83	51.85	74.00	-22.15	100	100	Peak

Remark:

1. Measuring frequencies from 1 GHz to the 10th harmonic of highest fundamental frequency.
2. Average test would be performed if the peak result were greater than the average limit.
3. Measurements above show only up to 6 maximum emissions noted, or would be lesser, with " N/A " remark, if no specific emissions from the EUT are recorded (ie: margin>20dB from the applicable limit) and considered that's already beyond the background noise floor.
4. Result = Reading + Correction Factor
 Margin = Result – Limit
 Remark Peak = Result(PK) – Limit(PK)
 Remark AVG = Result(AV) – Limit(AV)

Product Name	DOCSIS 3.1 wifi Gateway	Test By	Waternil Guan
Test Model	CODA-4782	Test Date	2016/09/13
Test Mode	IEEE 802.11gn HT40 MCS0 Mode / TX / CH Low	Temp. & Humidity	26°C, 58%

966Chamber_B at 3Meter / Horizontal

Freq. MHz	Reading dBuV	C.F. dB/m	Result dBuV/m	Limit dBuV/m	Margin dB	Azimuth deg	Height cm	Remark
1406.00	55.83	-6.68	49.15	74.00	-24.85	175	200	Peak
1800.00	55.54	-4.95	50.59	74.00	-23.41	62	100	Peak
2484.00	48.38	-2.25	46.13	54.00	-7.87	205	100	Average
2484.00	55.27	-2.25	53.02	74.00	-20.98	205	100	Peak
4800.00	40.32	5.18	45.50	74.00	-28.50	261	100	Peak
4977.00	44.99	5.64	50.63	74.00	-23.37	154	200	Peak
7260.00	35.66	12.41	48.07	74.00	-25.93	51	100	Peak
7800.00	39.13	12.88	52.01	74.00	-21.99	44	200	Peak

966Chamber_B at 3Meter / Vertical

Freq. MHz	Reading dBuV	C.F. dB/m	Result dBuV/m	Limit dBuV/m	Margin dB	Azimuth deg	Height cm	Remark
1012.00	58.10	-9.26	48.84	74.00	-25.16	140	100	Peak
1200.00	56.41	-8.03	48.38	74.00	-25.62	298	100	Peak
2484.00	52.07	-2.25	49.82	54.00	-4.18	97	100	Average
2484.00	57.02	-2.25	54.77	74.00	-19.23	97	100	Peak
3216.00	47.26	-0.18	47.08	74.00	-26.92	108	200	Peak
4800.00	40.56	5.18	45.74	74.00	-28.26	135	200	Peak
7260.00	36.03	12.41	48.44	74.00	-25.56	1	200	Peak
8112.00	37.07	13.14	50.21	74.00	-23.79	187	200	Peak

Remark:

1. Measuring frequencies from 1 GHz to the 10th harmonic of highest fundamental frequency.
2. Average test would be performed if the peak result were greater than the average limit.
3. Measurements above show only up to 6 maximum emissions noted, or would be lesser, with " N/A " remark, if no specific emissions from the EUT are recorded (ie: margin>20dB from the applicable limit) and considered that's already beyond the background noise floor.
4. Result = Reading + Correction Factor
 Margin = Result – Limit
 Remark Peak = Result(PK) – Limit(PK)
 Remark AVG = Result(AV) – Limit(AV)

Product Name	DOCSIS 3.1 wifi Gateway	Test By	Waternil Guan
Test Model	CODA-4782	Test Date	2016/09/13
Test Mode	IEEE 802.11gn HT40 MCS0 Mode / TX / CH Middle	Temp. & Humidity	26°C, 58%

966Chamber_B at 3Meter / Horizontal

Freq. MHz	Reading dBuV	C.F. dB/m	Result dBuV/m	Limit dBuV/m	Margin dB	Azimuth deg	Height cm	Remark
1800.00	56.06	-4.95	51.11	74.00	-22.89	138	200	Peak
2390.00	54.23	-2.63	51.60	54.00	-2.40	359	200	Average
2390.00	68.17	-2.63	65.54	74.00	-8.46	359	200	Peak
2484.00	51.37	-2.25	49.12	54.00	-4.88	1	200	Average
2484.00	65.33	-2.25	63.08	74.00	-10.92	1	200	Peak
4866.00	41.48	5.35	46.83	74.00	-27.17	258	200	Peak
4977.00	45.06	5.64	50.70	74.00	-23.30	174	200	Peak
7308.00	35.66	12.44	48.10	54.00	-5.90	268	100	Average
7308.00	44.72	12.44	57.16	74.00	-16.84	268	100	Peak
7800.00	39.22	12.88	52.10	74.00	-21.90	1	200	Peak

966Chamber_B at 3Meter / Vertical

Freq. MHz	Reading dBuV	C.F. dB/m	Result dBuV/m	Limit dBuV/m	Margin dB	Azimuth deg	Height cm	Remark
1406.00	55.90	-6.68	49.22	74.00	-24.78	38	100	Peak
2390.00	55.44	-2.63	52.81	54.00	-1.19	355	200	Average
2390.00	74.66	-2.63	72.03	74.00	-1.97	355	200	Peak
2484.00	53.69	-2.25	51.44	54.00	-2.56	237	200	Average
2484.00	74.22	-2.25	71.97	74.00	-2.03	237	200	Peak
3216.00	46.43	-0.18	46.25	74.00	-27.75	75	200	Peak
4875.00	37.06	5.38	42.44	74.00	-31.56	91	100	Peak
7308.00	40.11	12.44	52.55	54.00	-1.45	187	200	Average
7308.00	48.99	12.44	61.43	74.00	-12.57	187	200	Peak
7992.00	37.14	13.09	50.23	74.00	-23.77	154	200	Peak

Remark:

1. Measuring frequencies from 1 GHz to the 10th harmonic of highest fundamental frequency.
2. Average test would be performed if the peak result were greater than the average limit.
3. Measurements above show only up to 6 maximum emissions noted, or would be lesser, with " N/A " remark, if no specific emissions from the EUT are recorded (ie: margin>20dB from the applicable limit) and considered that's already beyond the background noise floor.
4. Result = Reading + Correction Factor
 Margin = Result – Limit
 Remark Peak = Result(PK) – Limit(PK)
 Remark AVG = Result(AV) – Limit(AV)

Product Name	DOCSIS 3.1 wifi Gateway	Test By	Waternil Guan
Test Model	CODA-4782	Test Date	2016/09/13
Test Mode	IEEE 802.11gn HT40 MCS0 Mode / TX / CH High	Temp. & Humidity	26°C, 58%

966Chamber_B at 3Meter / Horizontal

Freq. MHz	Reading dBuV	C.F. dB/m	Result dBuV/m	Limit dBuV/m	Margin dB	Azimuth deg	Height cm	Remark
1800.00	55.79	-4.95	50.84	74.00	-23.16	62	100	Peak
2282.00	55.29	-3.07	52.22	74.00	-21.78	170	200	Peak
2390.00	50.22	-2.63	47.59	54.00	-6.41	12	200	Average
2390.00	60.31	-2.63	57.68	74.00	-16.32	12	200	Peak
4200.00	47.09	3.31	50.40	74.00	-23.60	314	200	Peak
4902.00	36.47	5.45	41.92	74.00	-32.08	352	200	Peak
7356.00	35.87	12.47	48.34	74.00	-25.66	360	200	Peak
7800.00	38.17	12.88	51.05	74.00	-22.95	8	200	Peak

966Chamber_B at 3Meter / Vertical

Freq. MHz	Reading dBuV	C.F. dB/m	Result dBuV/m	Limit dBuV/m	Margin dB	Azimuth deg	Height cm	Remark
1012.00	58.96	-9.26	49.70	74.00	-24.30	140	100	Peak
1200.00	56.87	-8.03	48.84	74.00	-25.16	304	100	Peak
2390.00	53.41	-2.63	50.78	54.00	-3.22	2	100	Average
2390.00	62.75	-2.63	60.12	74.00	-13.88	2	100	Peak
3216.00	47.18	-0.18	47.00	74.00	-27.00	65	200	Peak
4905.00	36.90	5.45	42.35	74.00	-31.65	146	100	Peak
7392.00	37.65	12.49	50.14	74.00	-23.86	66	100	Peak
9060.00	36.60	13.78	50.38	74.00	-23.62	93	200	Peak

Remark:

1. Measuring frequencies from 1 GHz to the 10th harmonic of highest fundamental frequency.
2. Average test would be performed if the peak result were greater than the average limit.
3. Measurements above show only up to 6 maximum emissions noted, or would be lesser, with " N/A " remark, if no specific emissions from the EUT are recorded (ie: margin>20dB from the applicable limit) and considered that's already beyond the background noise floor.
4. Result = Reading + Correction Factor
 Margin = Result – Limit
 Remark Peak = Result(PK) – Limit(PK)
 Remark AVG = Result(AV) – Limit(AV)

Restricted Band Edges

Detector mode: Peak

Polarity: Horizontal

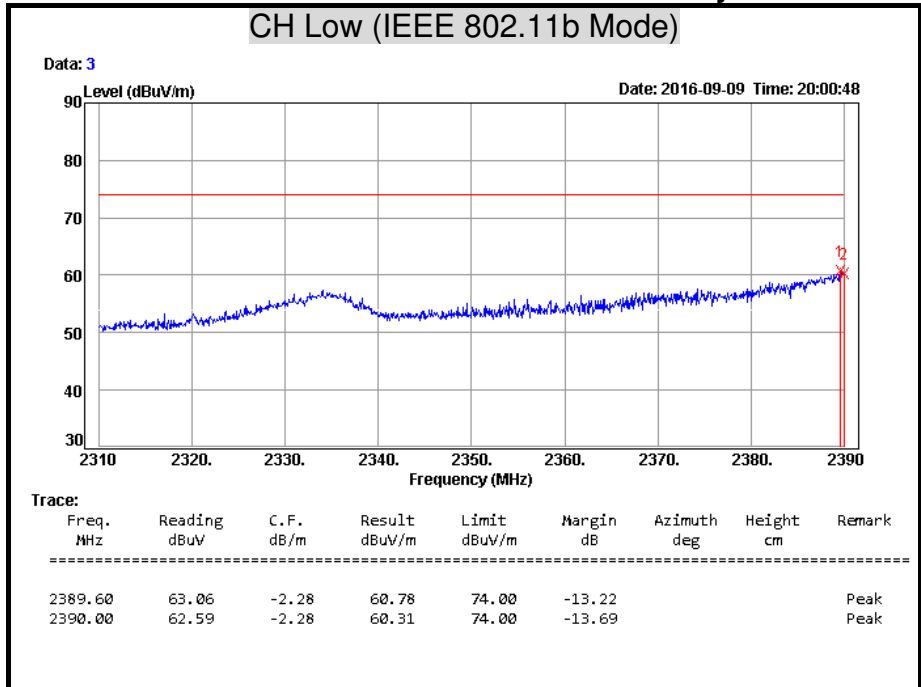

Remark: Result = Reading + Correction Factor
 Margin = Result – Limit
 Remark Peak = Result(PK) – Limit(PK)

Detector mode: Average

Polarity: Horizontal

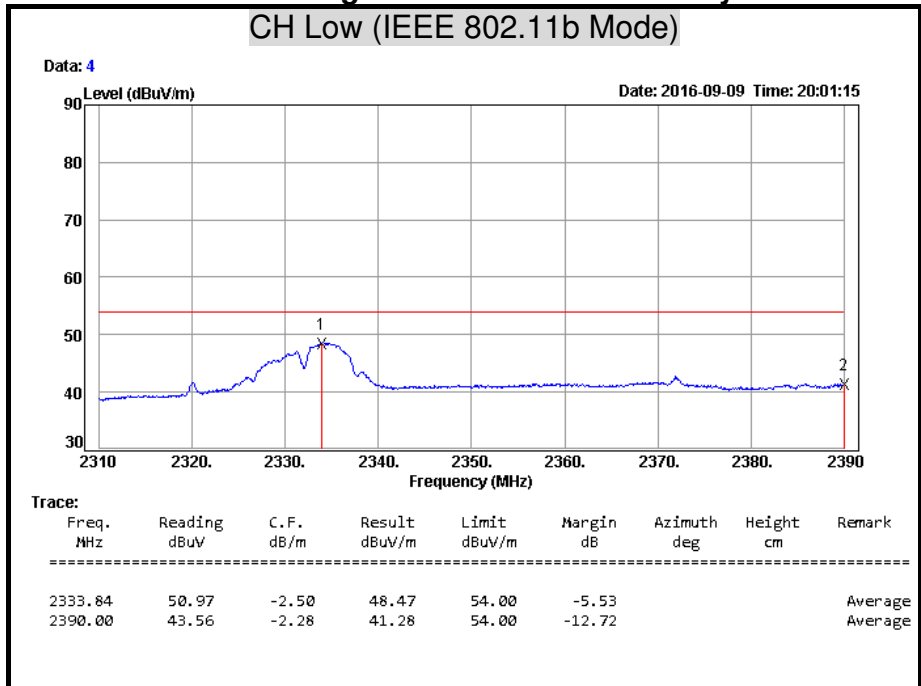

Remark: Result = Reading + Correction Factor
 Margin = Result – Limit
 Remark AVG = Result(AV) – Limit(AV)

Detector mode: Peak **Polarity: Vertical**

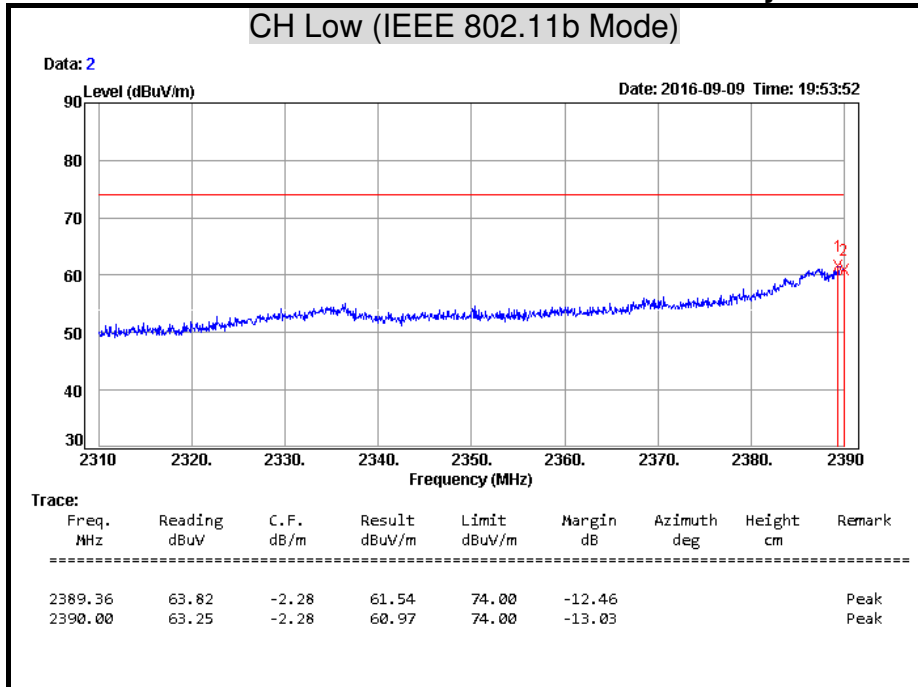

Remark: Result = Reading + Correction Factor
 Margin = Result – Limit
 Remark Peak = Result(PK) – Limit(PK)

Detector mode: Average **Polarity: Vertical**

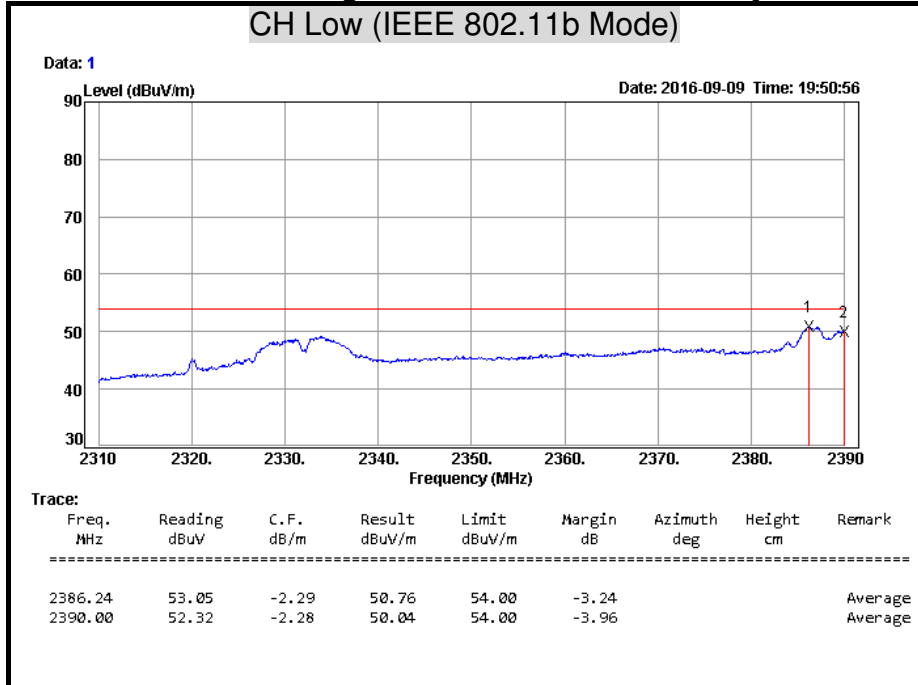

Remark: Result = Reading + Correction Factor
 Margin = Result – Limit
 Remark AVG = Result(AV) – Limit(AV)

Detector mode: Peak **Polarity: Horizontal**

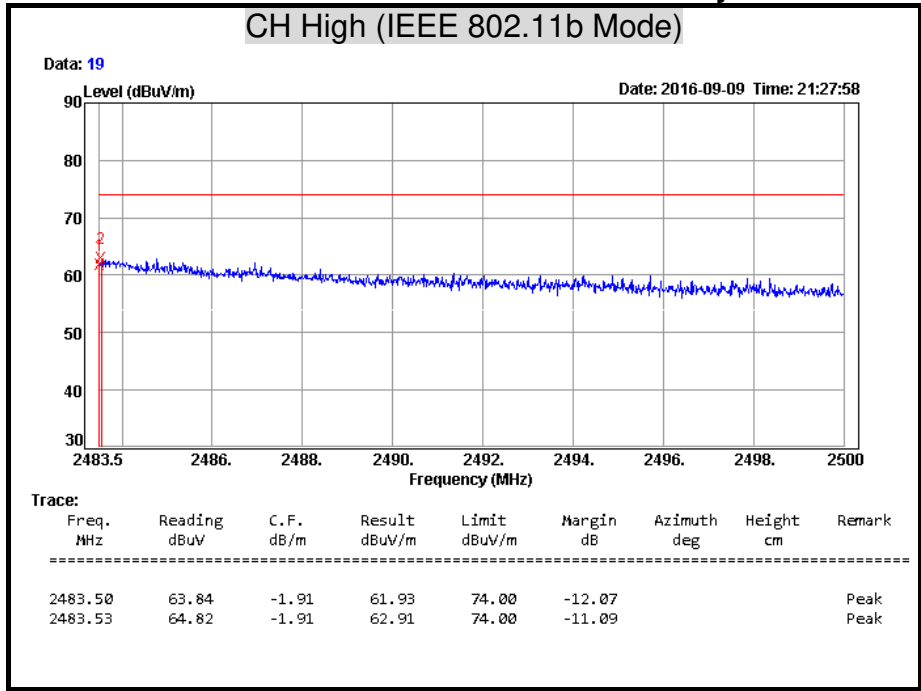

Remark: Result = Reading + Correction Factor
 Margin = Result – Limit
 Remark Peak = Result(PK) – Limit(PK)

Detector mode: Average **Polarity: Horizontal**

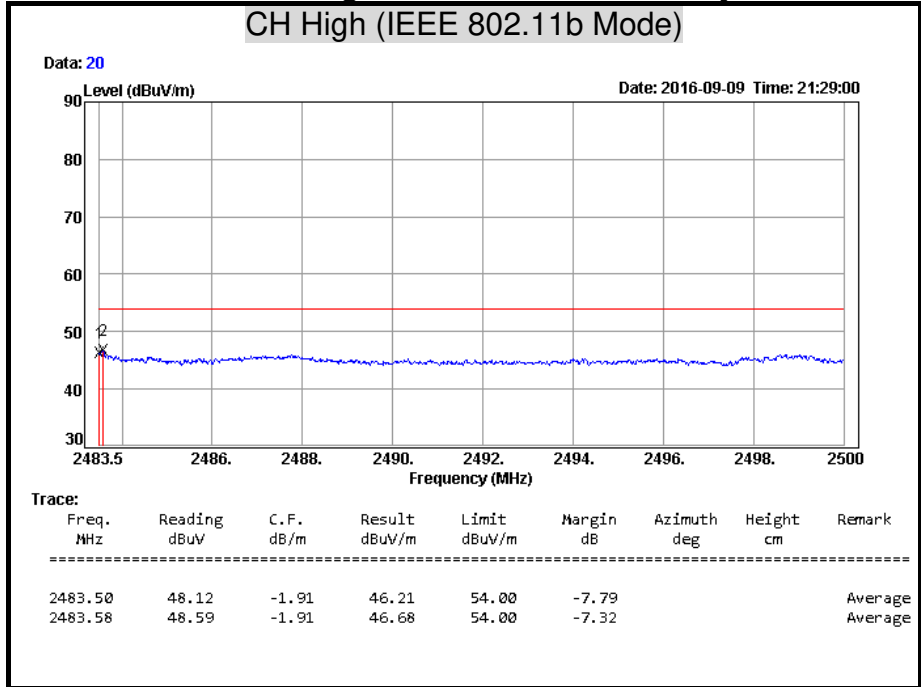

Remark: Result = Reading + Correction Factor
 Margin = Result – Limit
 Remark AVG = Result(AV) – Limit(AV)

Detector mode: Peak **Polarity: Vertical**

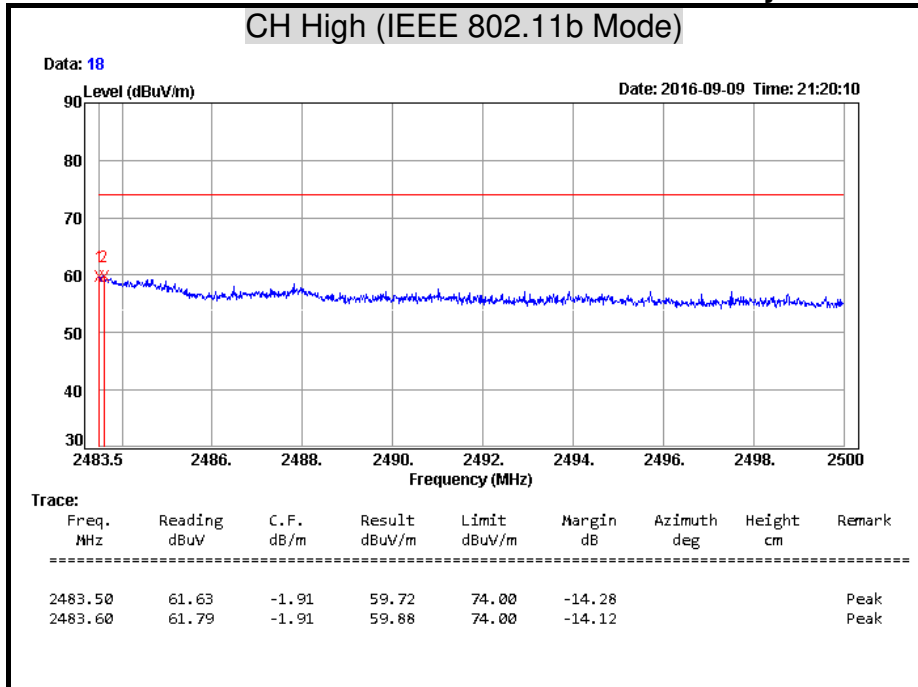

Remark: Result = Reading + Correction Factor
 Margin = Result – Limit
 Remark Peak = Result(PK) – Limit(PK)

Detector mode: Average **Polarity: Vertical**

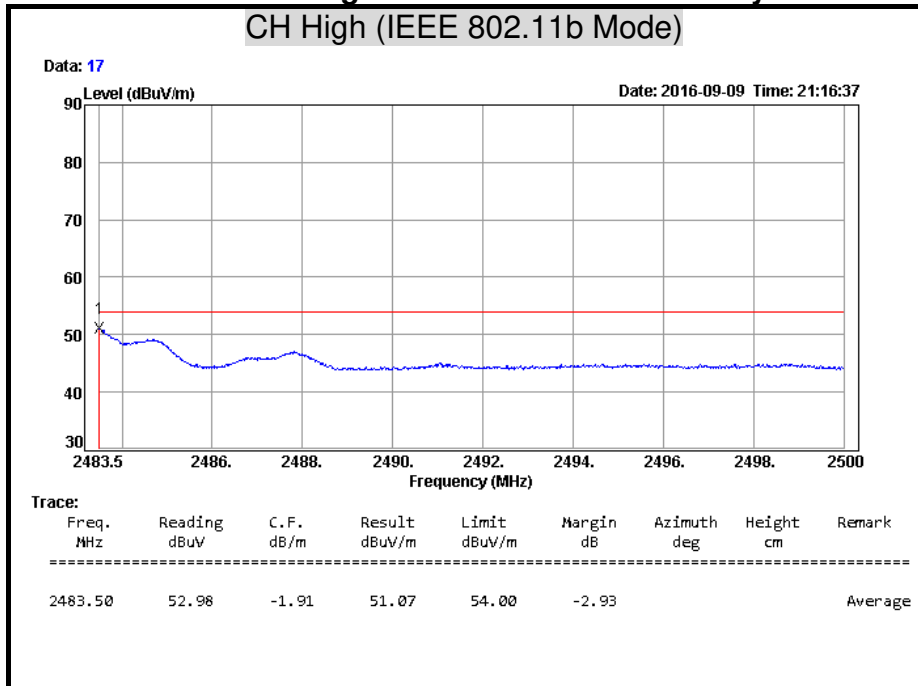

Remark: Result = Reading + Correction Factor
 Margin = Result – Limit
 Remark AVG = Result(AV) – Limit(AV)

Detector mode: Peak **Polarity: Horizontal**

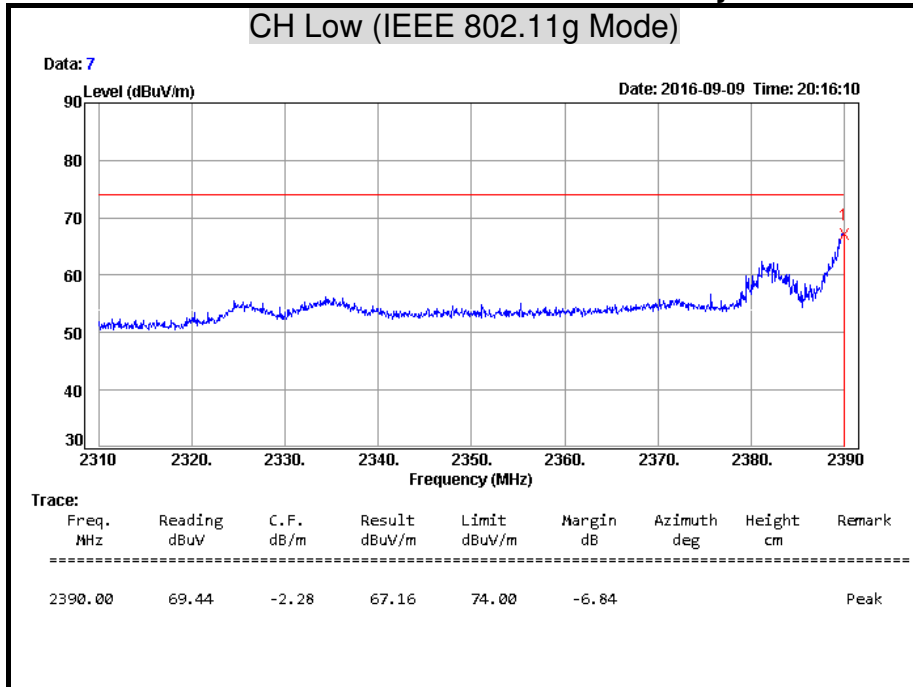

Remark: Result = Reading + Correction Factor
 Margin = Result – Limit
 Remark Peak = Result(PK) – Limit(PK)

Detector mode: Average **Polarity: Horizontal**

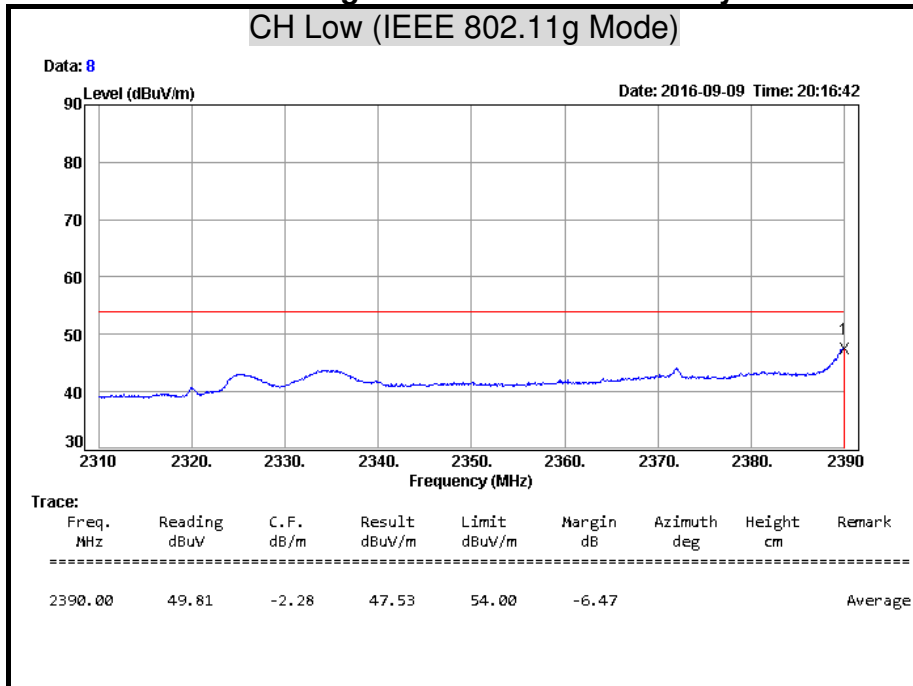

Remark: Result = Reading + Correction Factor
 Margin = Result – Limit
 Remark AVG = Result(AV) – Limit(AV)

Detector mode: Peak **Polarity: Vertical**

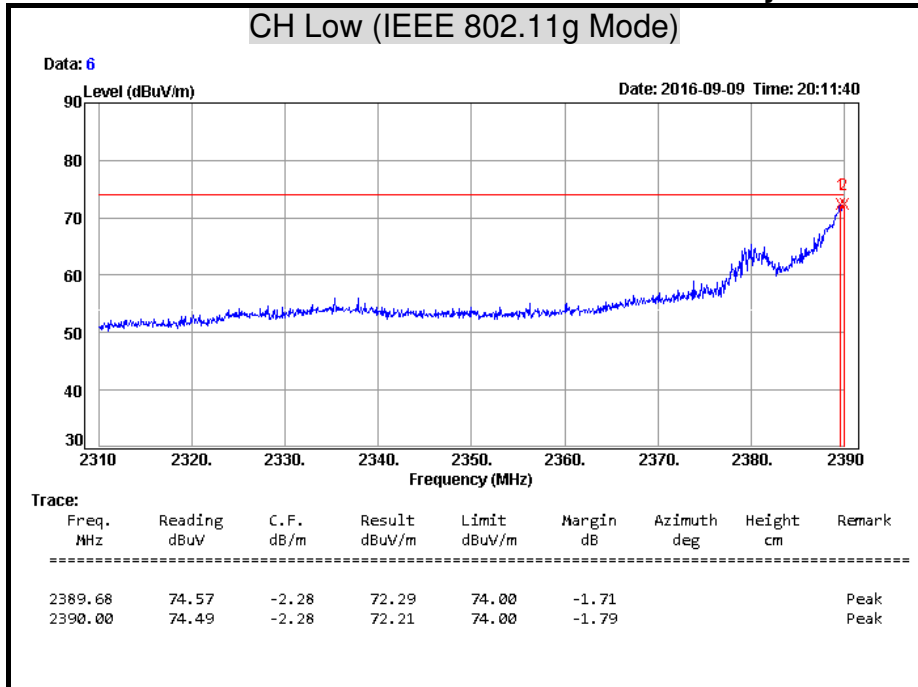

Remark: Result = Reading + Correction Factor
 Margin = Result – Limit
 Remark Peak = Result(PK) – Limit(PK)

Detector mode: Average **Polarity: Vertical**

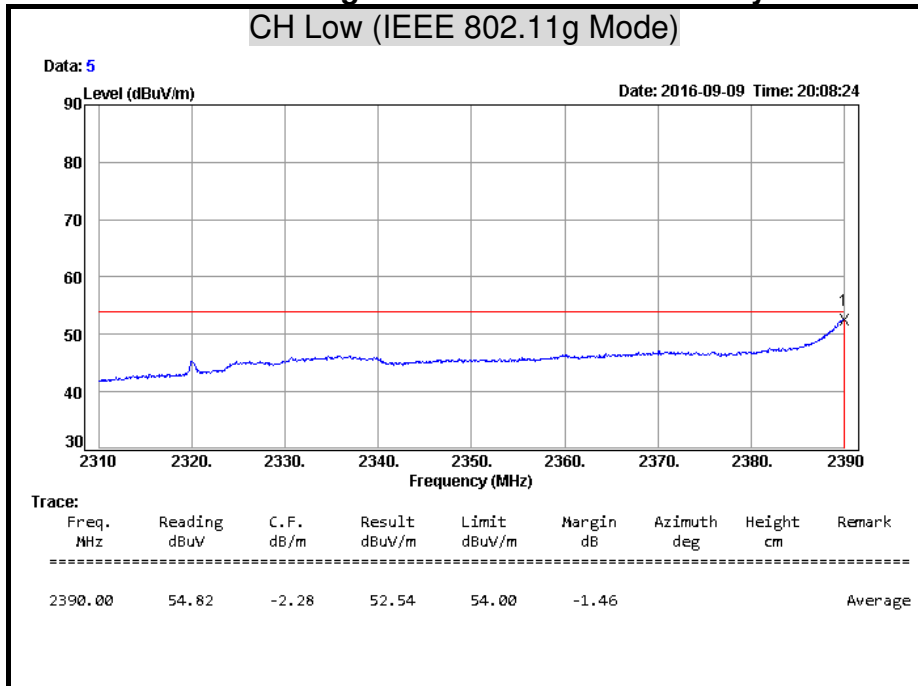

Remark: Result = Reading + Correction Factor
 Margin = Result – Limit
 Remark AVG = Result(AV) – Limit(AV)

Detector mode: Peak **Polarity: Horizontal**

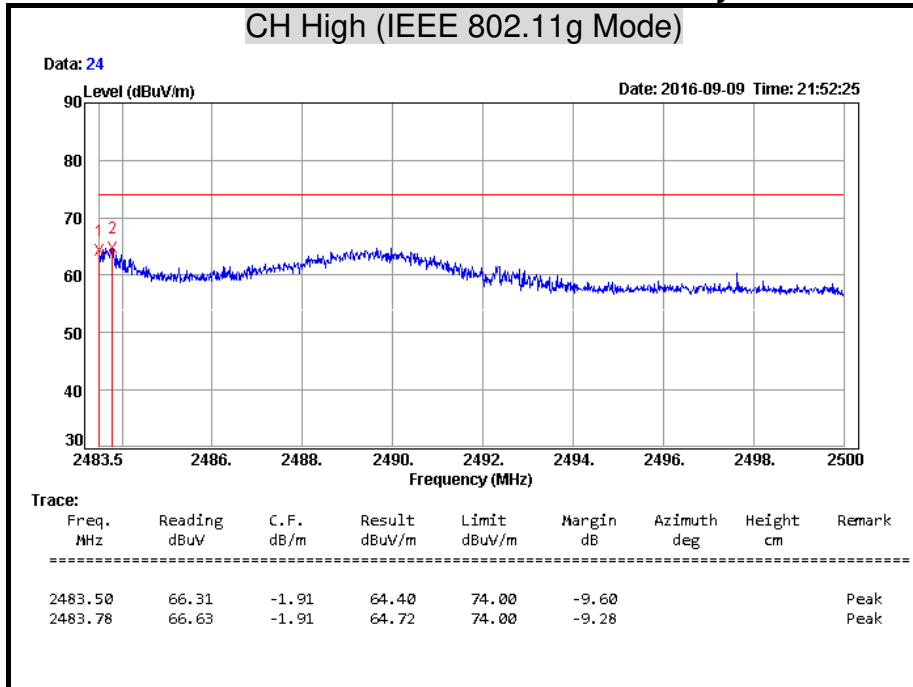

Remark: Result = Reading + Correction Factor
 Margin = Result – Limit
 Remark Peak = Result(PK) – Limit(PK)

Detector mode: Average **Polarity: Horizontal**

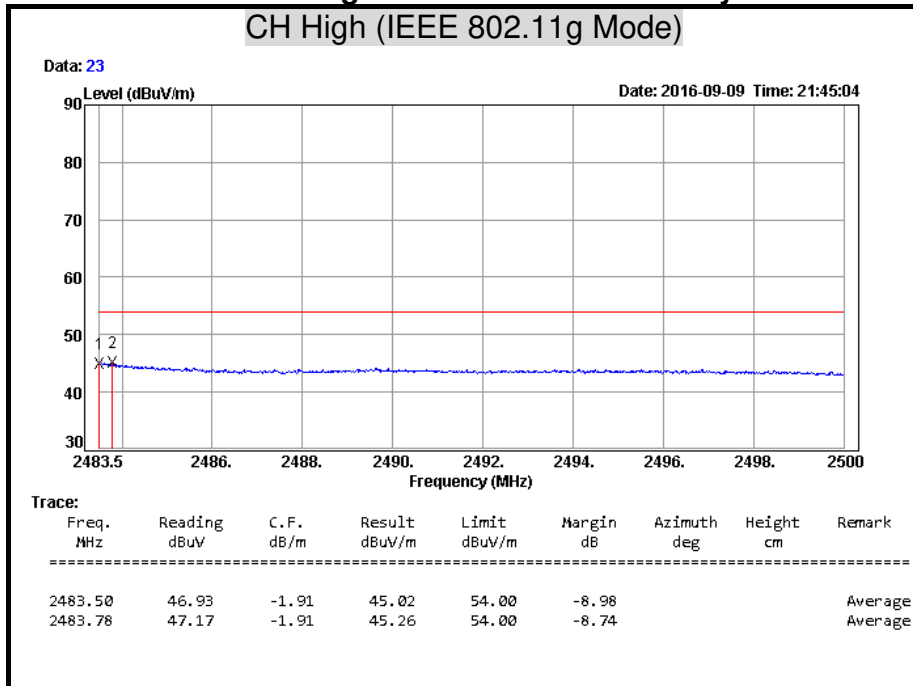

Remark: Result = Reading + Correction Factor
 Margin = Result – Limit
 Remark AVG = Result(AV) – Limit(AV)

Detector mode: Peak **Polarity: Vertical**

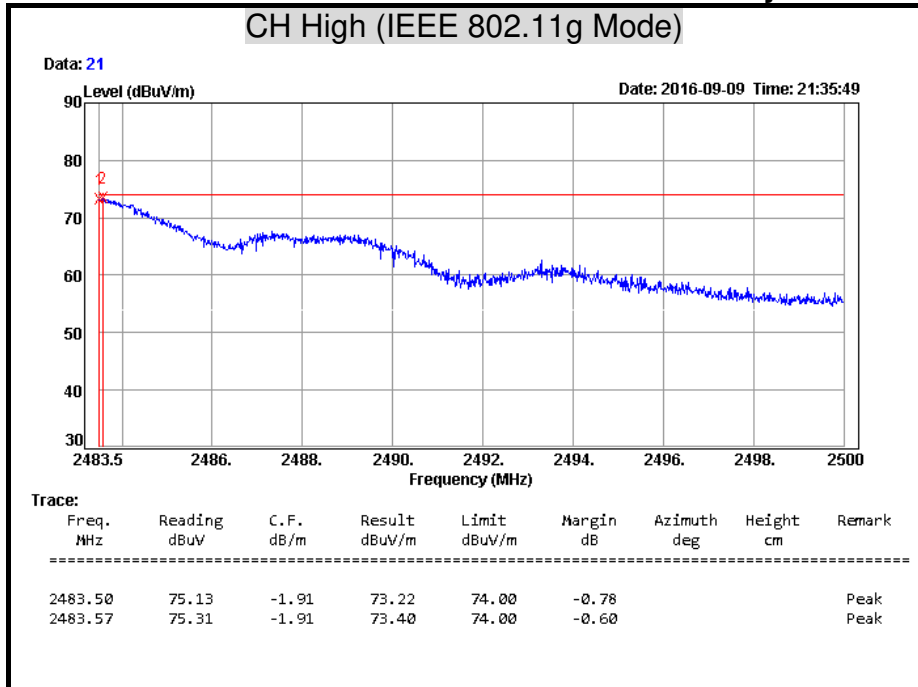

Remark: Result = Reading + Correction Factor
 Margin = Result – Limit
 Remark Peak = Result(PK) – Limit(PK)

Detector mode: Average **Polarity: Vertical**

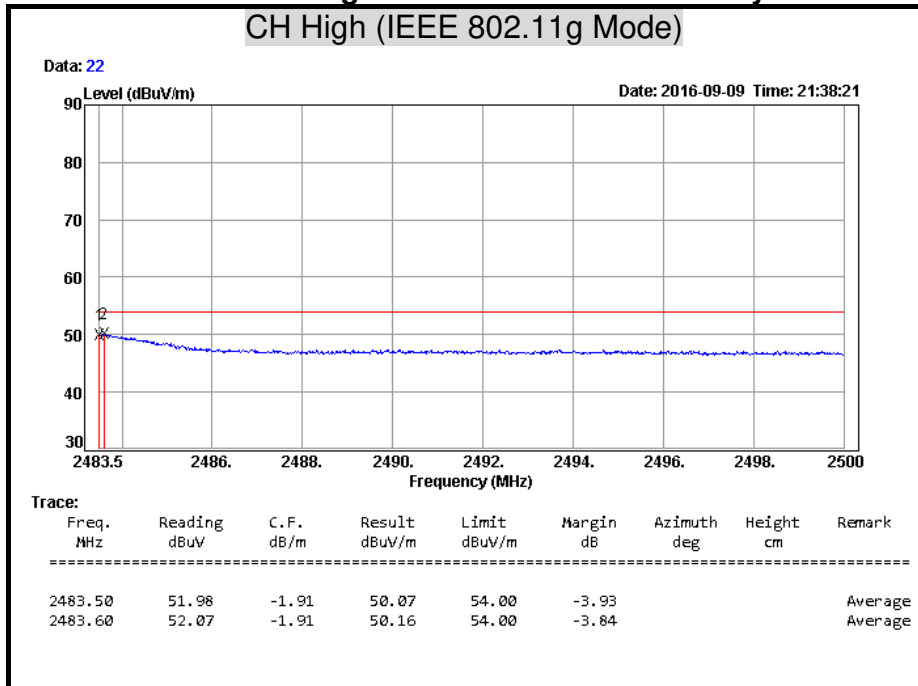

Remark: Result = Reading + Correction Factor
 Margin = Result – Limit
 Remark AVG = Result(AV) – Limit(AV)

Detector mode: Peak **Polarity: Horizontal**

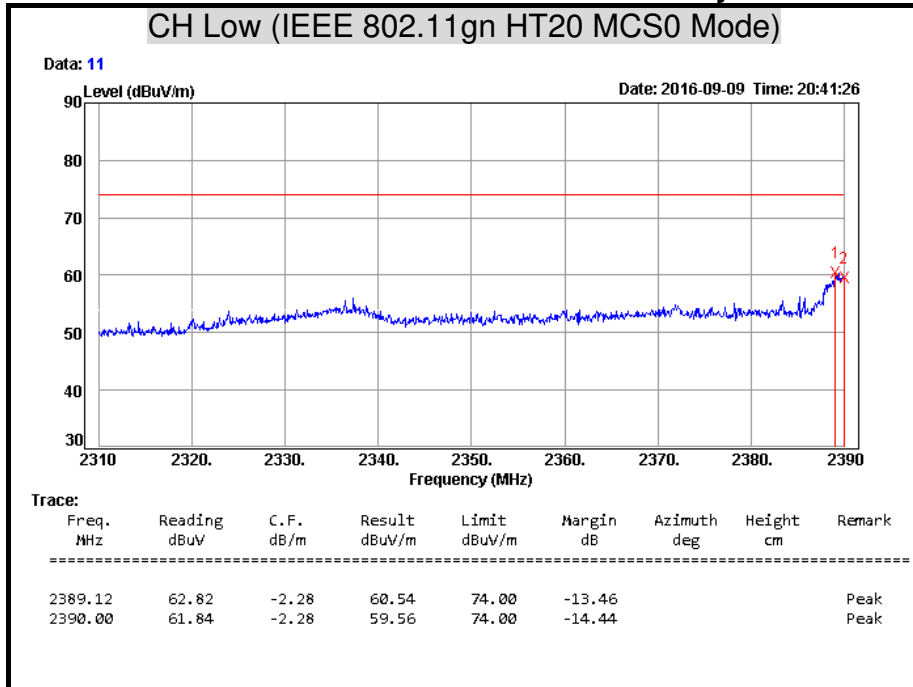

Remark: Result = Reading + Correction Factor
 Margin = Result – Limit
 Remark Peak = Result(PK) – Limit(PK)

Detector mode: Average **Polarity: Horizontal**

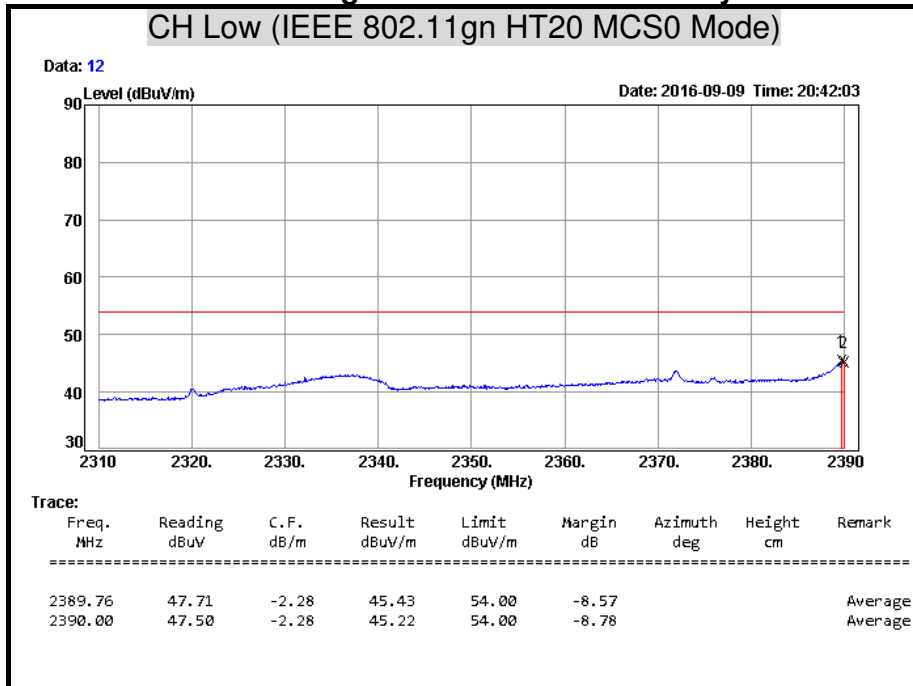

Remark: Result = Reading + Correction Factor
 Margin = Result – Limit
 Remark AVG = Result(AV) – Limit(AV)

Detector mode: Peak **Polarity: Vertical**

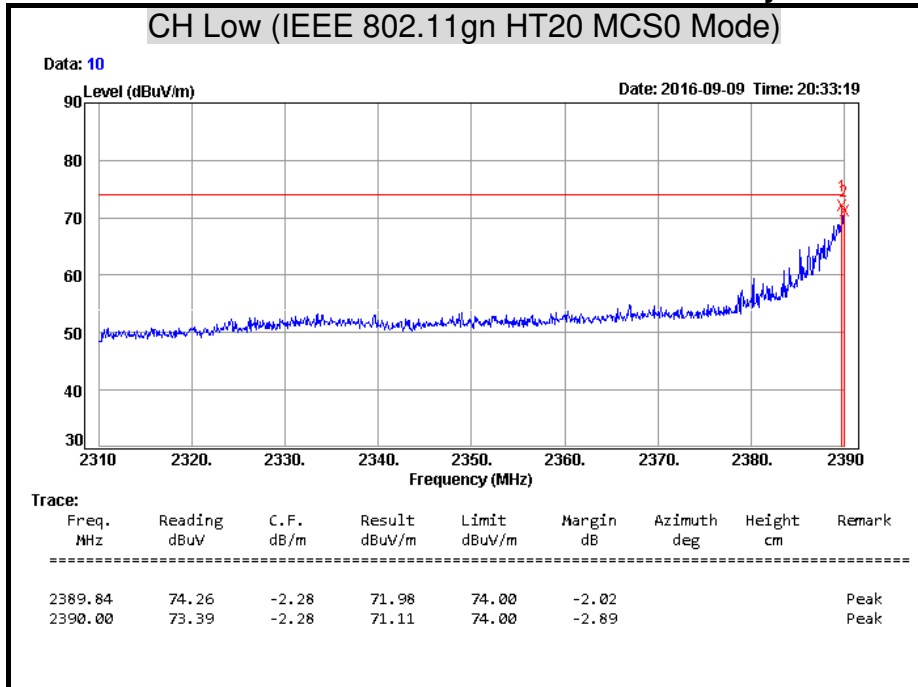

Remark: Result = Reading + Correction Factor
 Margin = Result – Limit
 Remark Peak = Result(PK) – Limit(PK)

Detector mode: Average **Polarity: Vertical**

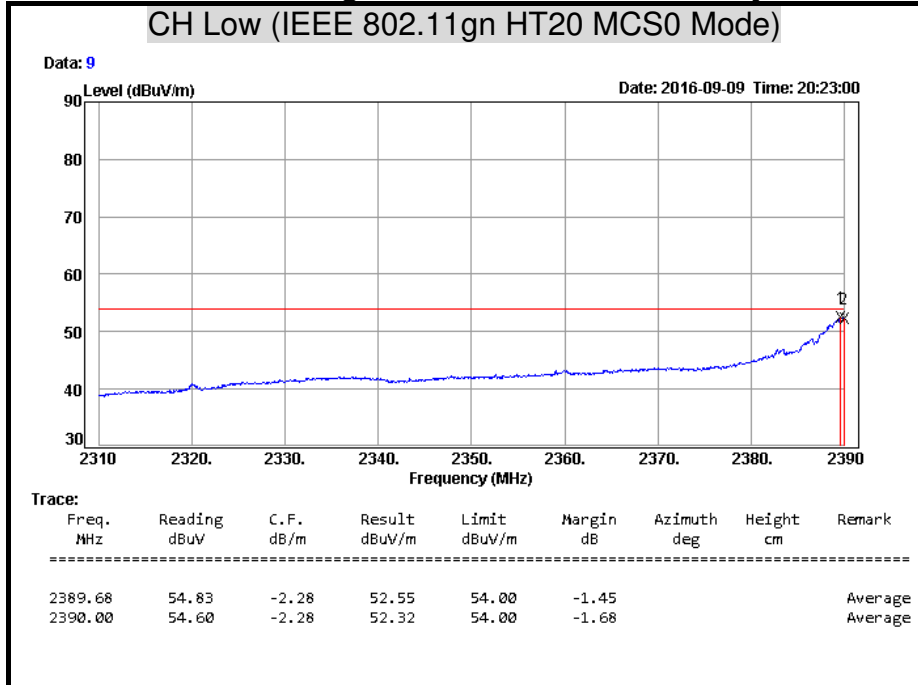

Remark: Result = Reading + Correction Factor
 Margin = Result – Limit
 Remark AVG = Result(AV) – Limit(AV)

Detector mode: Peak **Polarity: Horizontal**

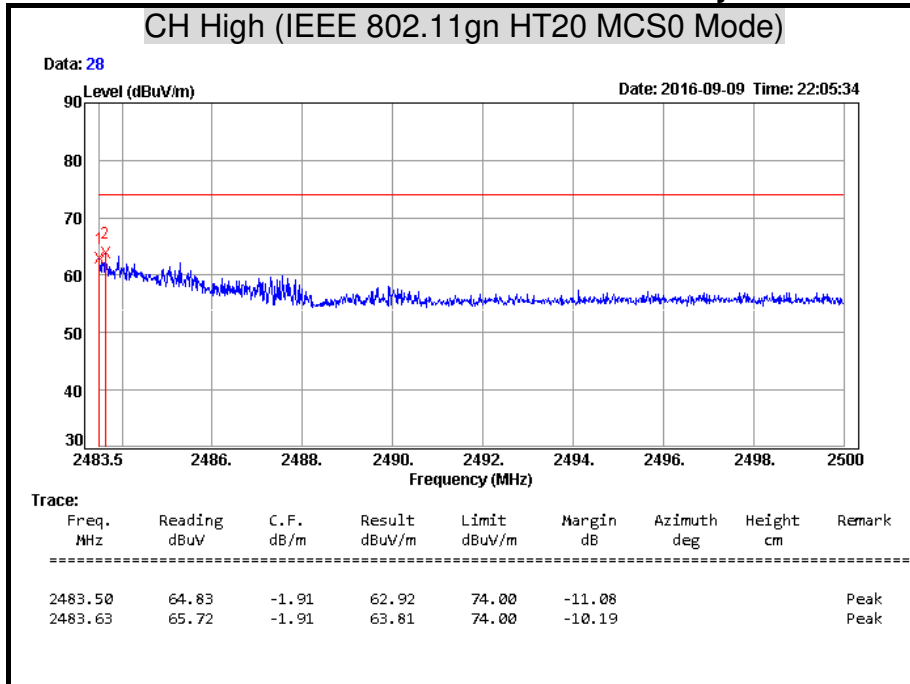

Remark: $Result = Reading + Correction\ Factor$
 $Margin = Result - Limit$
 $Remark\ Peak = Result(PK) - Limit(PK)$

Detector mode: Average **Polarity: Horizontal**

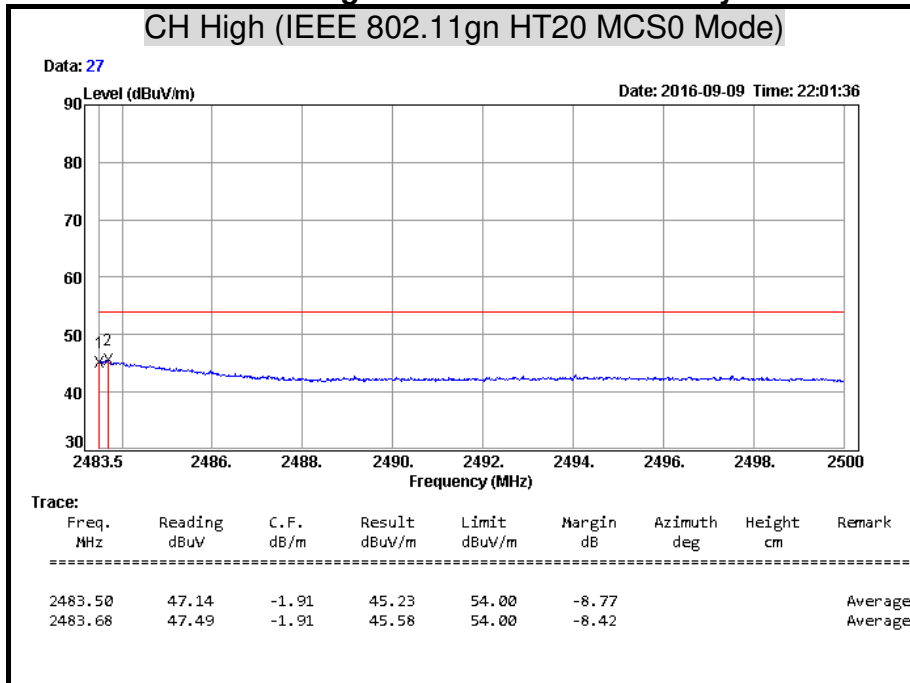

Remark: $Result = Reading + Correction\ Factor$
 $Margin = Result - Limit$
 $Remark\ AVG = Result(AV) - Limit(AV)$

Detector mode: Peak **Polarity: Vertical**

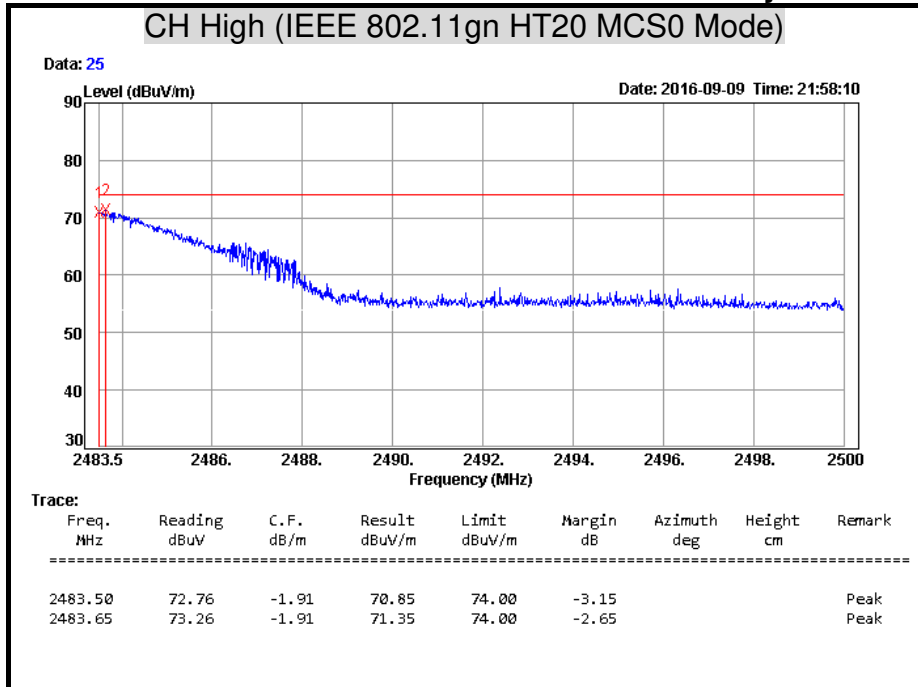

Remark: Result = Reading + Correction Factor
 Margin = Result – Limit
 Remark Peak = Result(PK) – Limit(PK)

Detector mode: Average **Polarity: Vertical**

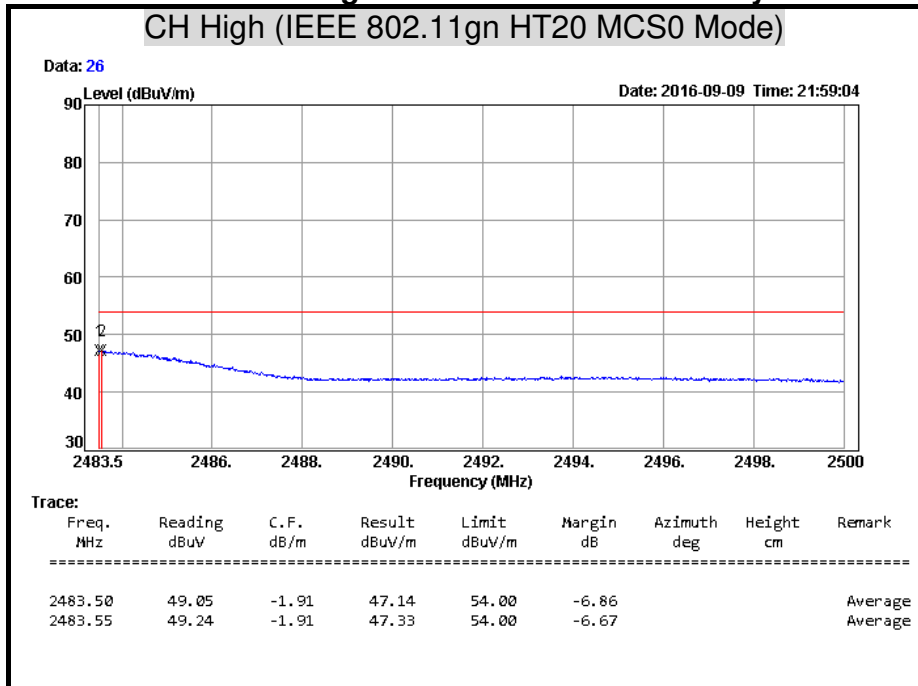

Remark: Result = Reading + Correction Factor
 Margin = Result – Limit
 Remark AVG = Result(AV) – Limit(AV)

Detector mode: Peak

Polarity: Horizontal

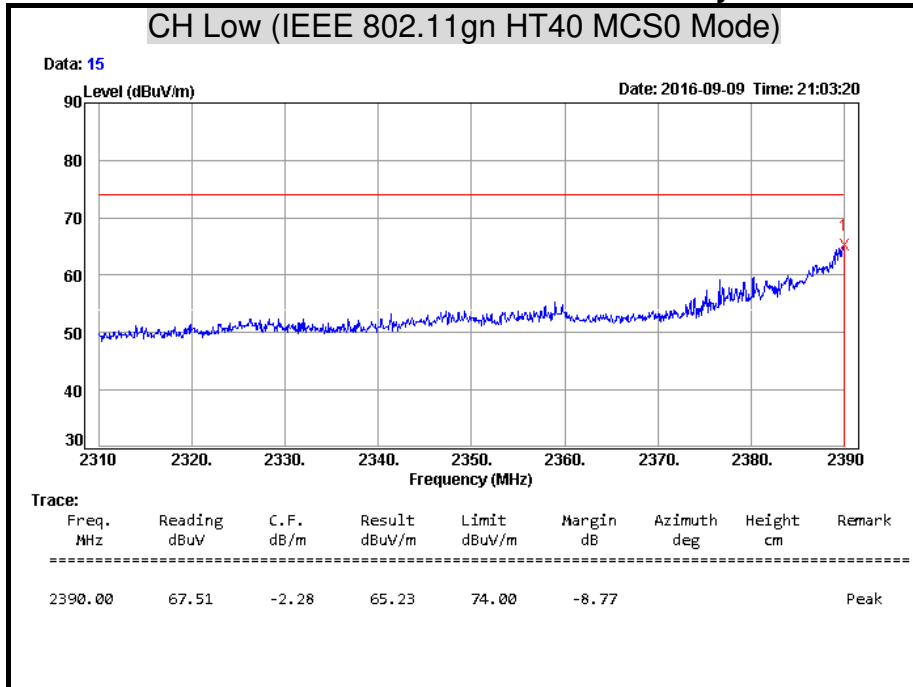

Remark: Result = Reading + Correction Factor
 Margin = Result – Limit
 Remark Peak = Result(PK) – Limit(PK)

Detector mode: Average

Polarity: Horizontal

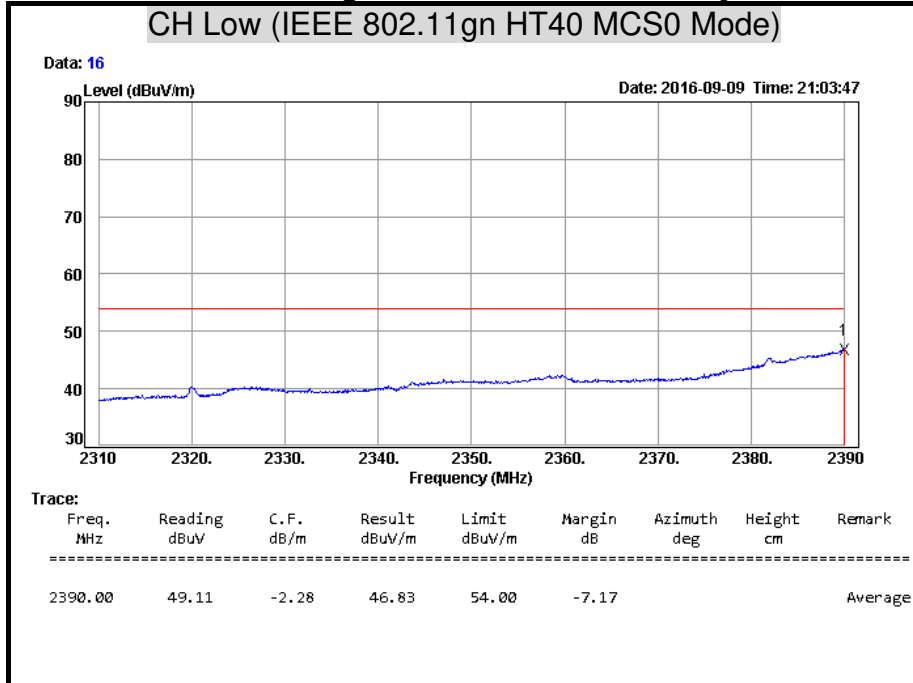

Remark: Result = Reading + Correction Factor
 Margin = Result – Limit
 Remark AVG = Result(AV) – Limit(AV)

Detector mode: Peak **Polarity: Vertical**

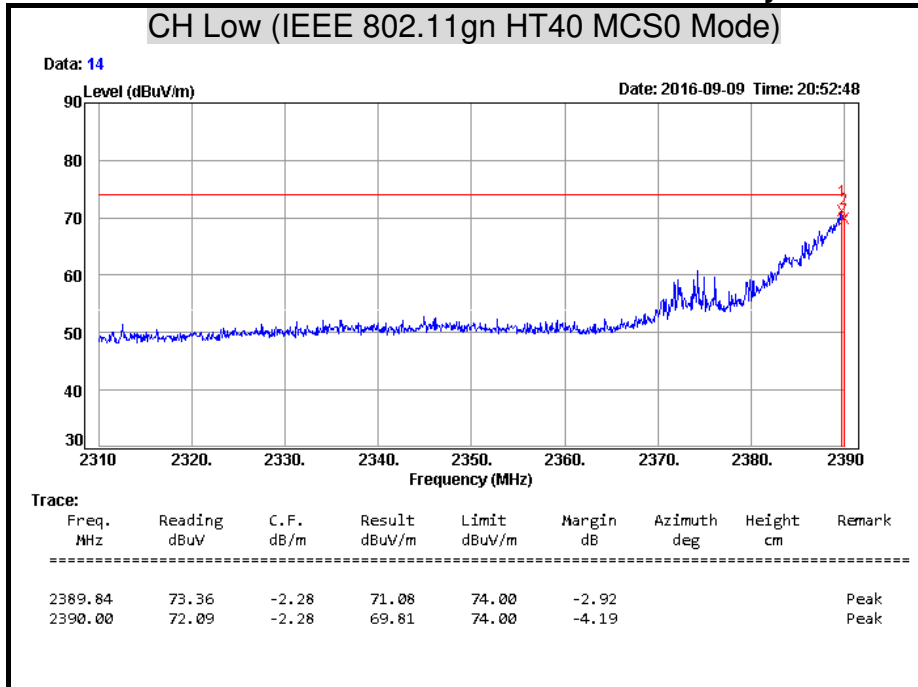

Remark: Result = Reading + Correction Factor
 Margin = Result – Limit
 Remark Peak = Result(PK) – Limit(PK)

Detector mode: Average **Polarity: Vertical**

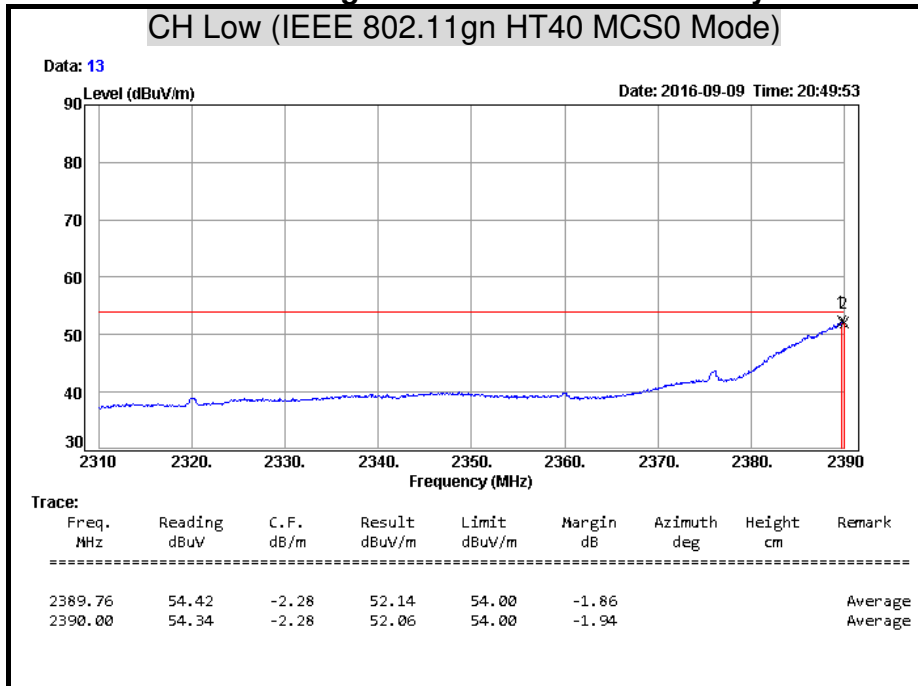

Remark: Result = Reading + Correction Factor
 Margin = Result – Limit
 Remark AVG = Result(AV) – Limit(AV)

Detector mode: Peak Polarity: Horizontal

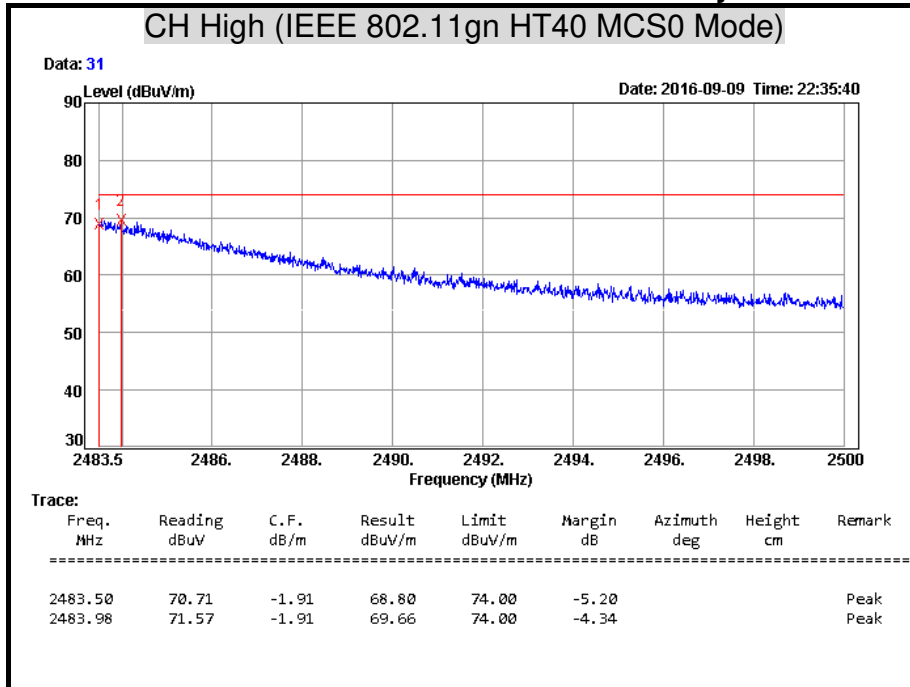

Remark: Result = Reading + Correction Factor
 Margin = Result – Limit
 Remark Peak = Result(PK) – Limit(PK)

Detector mode: Average Polarity: Horizontal

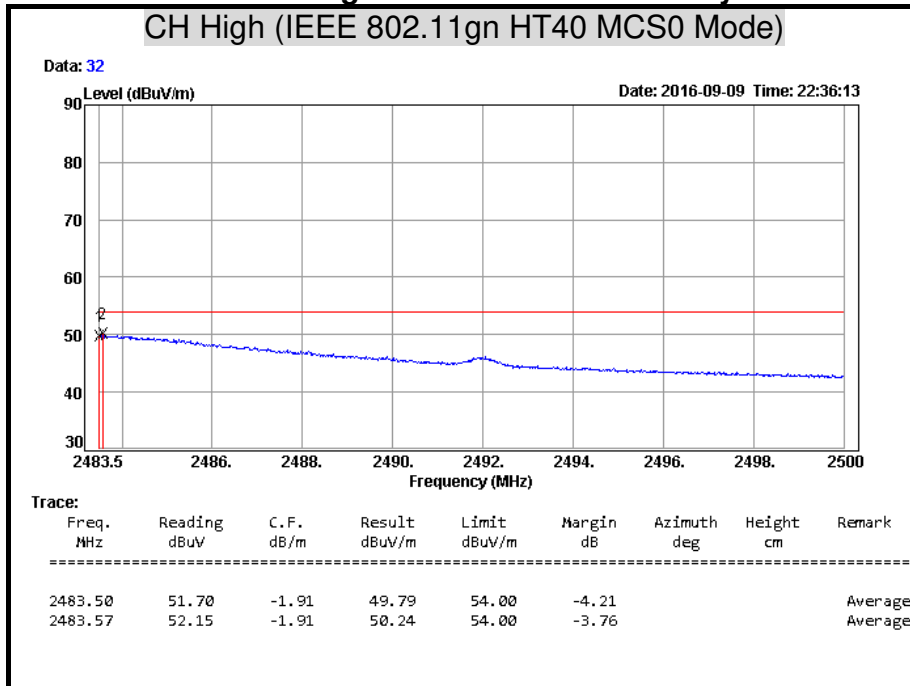

Remark: Result = Reading + Correction Factor
 Margin = Result – Limit
 Remark AVG = Result(AV) – Limit(AV)

Detector mode: Peak Polarity: Vertical

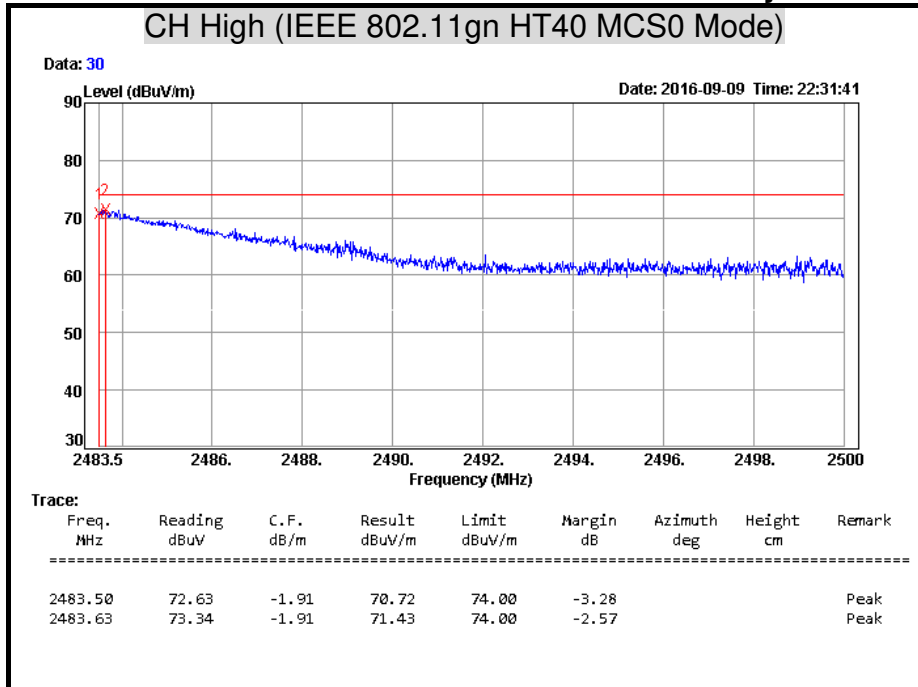

Remark: Result = Reading + Correction Factor
 Margin = Result – Limit
 Remark Peak = Result(PK) – Limit(PK)

Detector mode: Average Polarity: Vertical

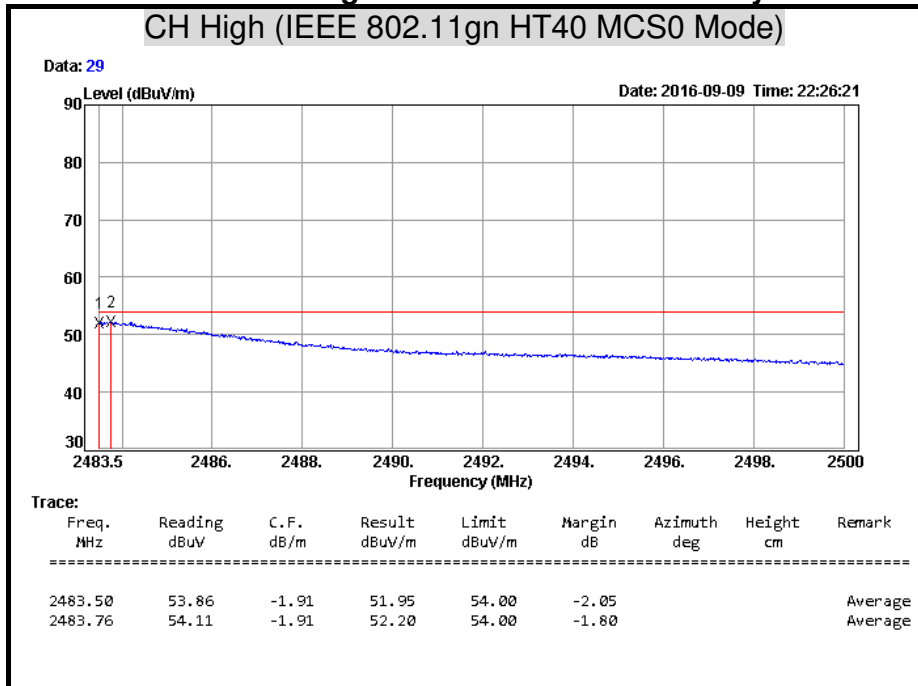

Remark: Result = Reading + Correction Factor
 Margin = Result – Limit
 Remark AVG = Result(AV) – Limit(AV)

7.7 CONDUCTED EMISSION

LIMITS

§ 15.207 (a) Except as shown in paragraph (b) and (c) this section, for an intentional radiator that is designed to be connected to the public utility (AC) power line, the radio frequency voltage that is conducted back onto the AC power line on any frequency or frequencies within the band 150 kHz to 30 MHz shall not exceed the limits in the following table, as measured using a 50 μ H/50 ohms line impedance stabilization network (LISN). Compliance with the provisions of this paragraph shall be based on the measurement of the radio frequency voltage between each power line and ground at the power terminal. The lower limit applies at the boundary between the frequency ranges.

Frequency Range (MHz)	Conducted Limit (dB μ v)	
	Quasi-peak	Average
0.15 - 0.50	66 to 56	56 to 46
0.50 - 5.00	56	46
5.00 - 30.0	60	50

TEST EQUIPMENT

Name of Equipment	Manufacturer	Model	Serial Number	Calibration Due
L.I.S.N	Schwarzbeck	NSLK 8127	8127 465	07/28/2017
L.I.S.N	Schwarzbeck	NSLK 8127	8127 473	03/10/2017
EMI Test Receiver	Rohde & Schwarz	ESHS 30	838550/003	10/31/2016
Pulse Limiter	Rohde & Schwarz	ESH3-Z2	100111	06/27/2017
Test S/W	E3.815206a			

Remark: Each piece of equipment is scheduled for calibration once a year.

TEST SETUP

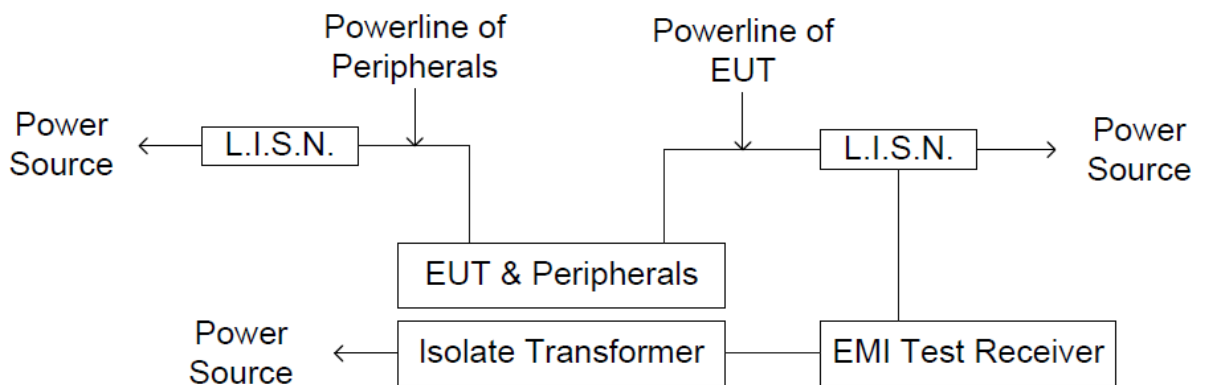
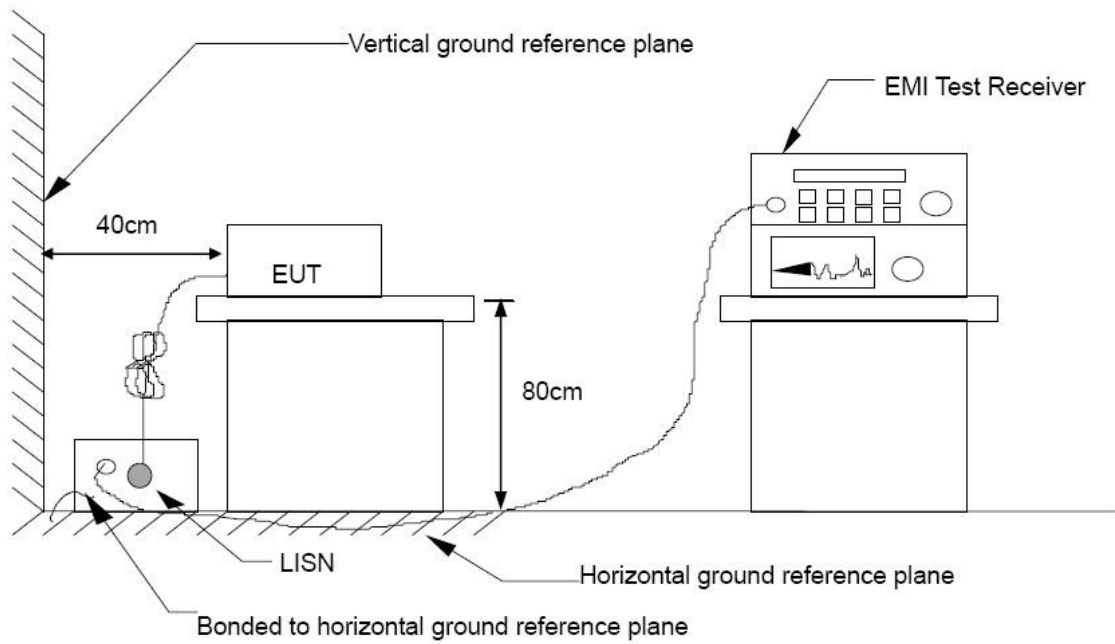

TEST PROCEDURE

The basic test procedure was in accordance with ANSI C63.10:2013.

The test procedure is performed in a 4m × 3m × 2.4m (L×W×H) shielded room.

The EUT along with its peripherals were placed on a 1.0m (W) × 1.5m (L) and 0.8m in height wooden table and the EUT was adjusted to maintain a 0.4 meter space from a vertical reference plane.

The EUT was connected to power mains through a line impedance stabilization network (LISN) which provides 50 ohm coupling impedance for measuring instrument and the chassis ground was bounded to the horizontal ground plane of shielded room. All peripherals were connected to the second LISN and the chassis ground also bounded to the horizontal ground plane of shielded room.

The EUT was located so that the distance between the boundary of the EUT and the closest surface of the LISN is 0.8 m. Where a mains flexible cord was provided by the manufacturer shall be 1 m long, or if in excess of 1 m, the excess cable was folded back and forth as far as possible so as to form a bundle not exceeding 0.4 m in length.

TEST RESULTS

Product Name	DOCSIS 3.1 wifi Gateway	Test By	Waternil Guan
Test Model	CODA-4782	Test Date	2016/09/30
Test Mode	Mode 1	Temp. & Humidity	22°C, 62%

LINE

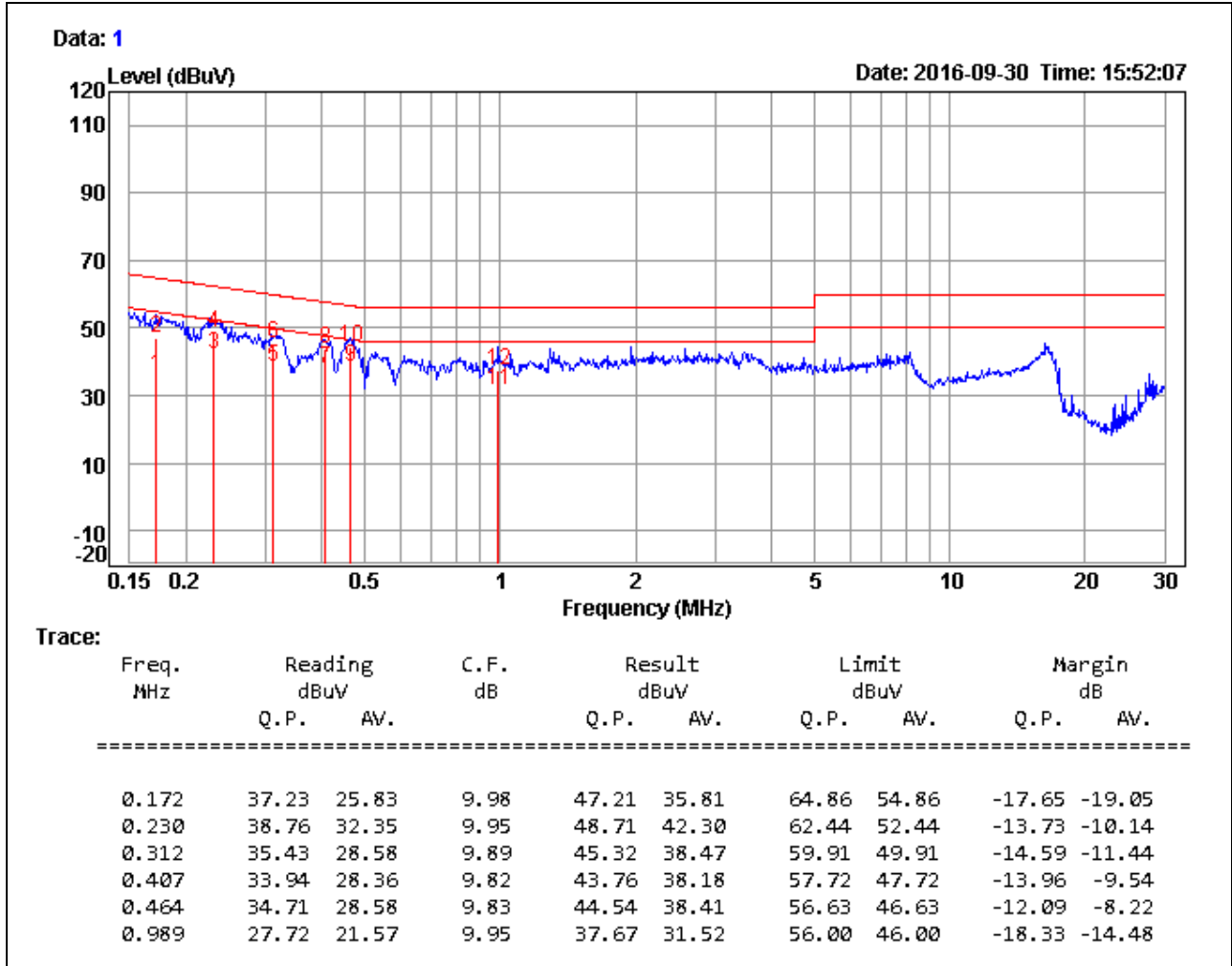

Remark:

1. Correction Factor = Insertion loss + Cable loss
2. Result level = Reading Value + Correction factor
3. Margin value = Result level – Limit value

Product Name	DOCSIS 3.1 wifi Gateway	Test By	Waternil Guan
Test Model	CODA-4782	Test Date	2016/09/30
Test Mode	Mode 1	Temp. & Humidity	22°C, 62%

NEUTRAL

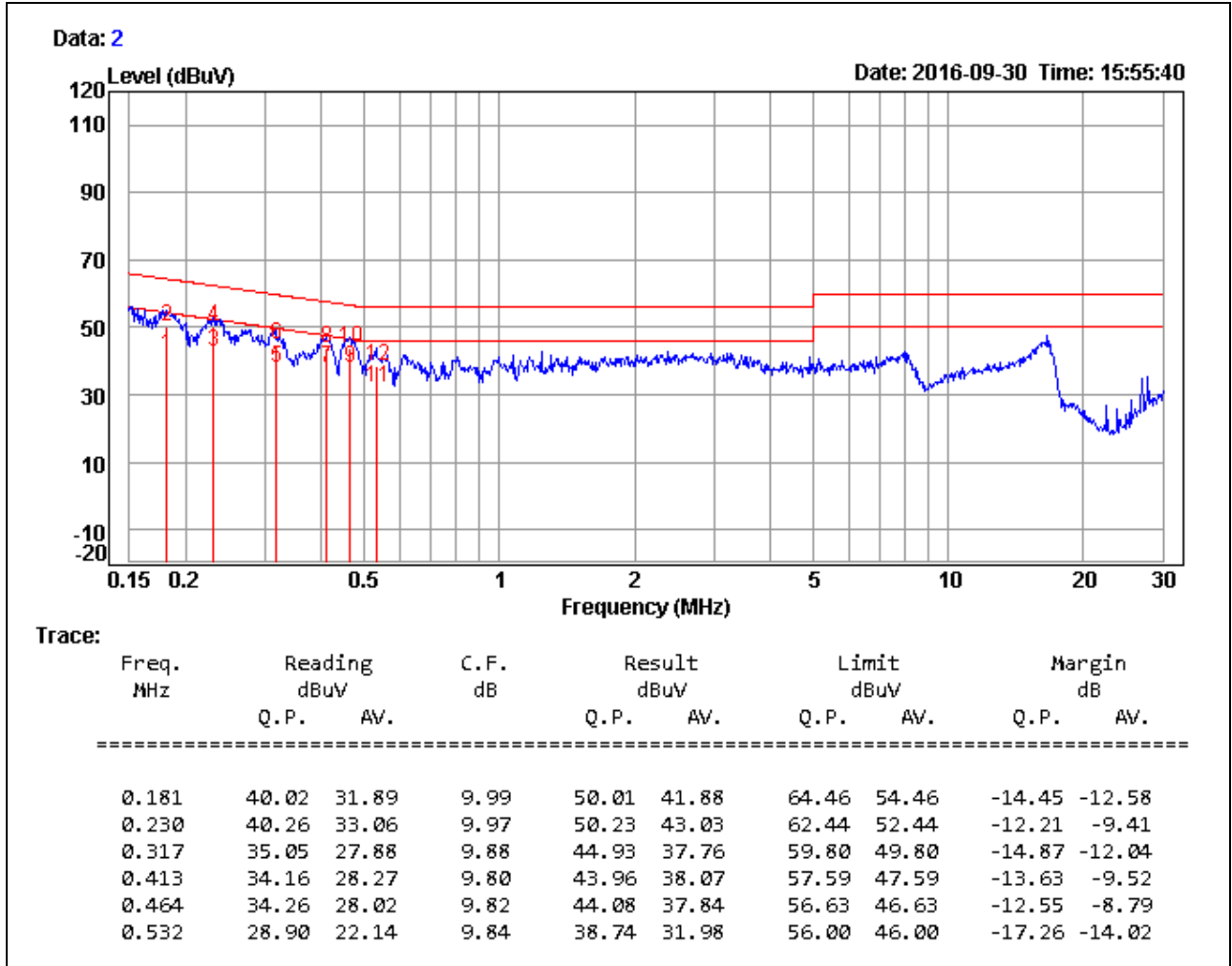

Remark:

1. Correction Factor = Insertion loss + Cable loss
2. Result level = Reading Value + Correction factor
3. Margin value = Result level – Limit value