



規格承認書
Specification for Approval

客 戶： 仲琦
Customer:
品 名： WIFI ANTENNA
Part name
料 號： GY196HC112-021
Part No.
客戶料號： 3930000254B8
Customer Part No.
REV: 02

客戶承認印 CUSTOMER APPROVED BY		
APPROVAL	CHIEF	SUPERVISOR
Approval No.		
Model		
Part No.		

CHIEF	SALES	R&D	DESIGN
ROX	Grant	Fountain	MARS
Date:2023/2/21		Date:2023/2/21	
驊陸科技股份有限公司 WIESON TECHNOLOGIES CO., LTD.			

表格編號：324012 版本：第四版

REV	DATE	DESCRIPTION	NAME
01	19.03.21	NEW RELEASE	JAY
02	19.08.19	△ Modify Print & Release Paper	JAY

RoHS Compliant

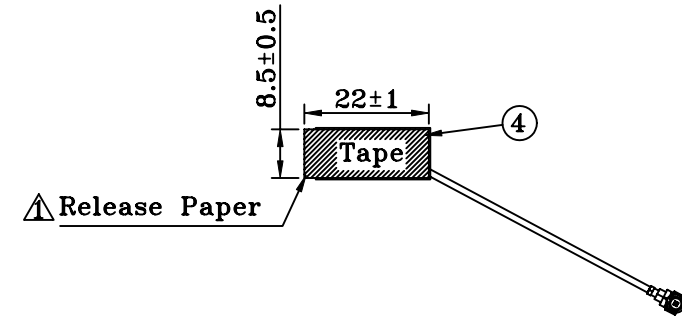
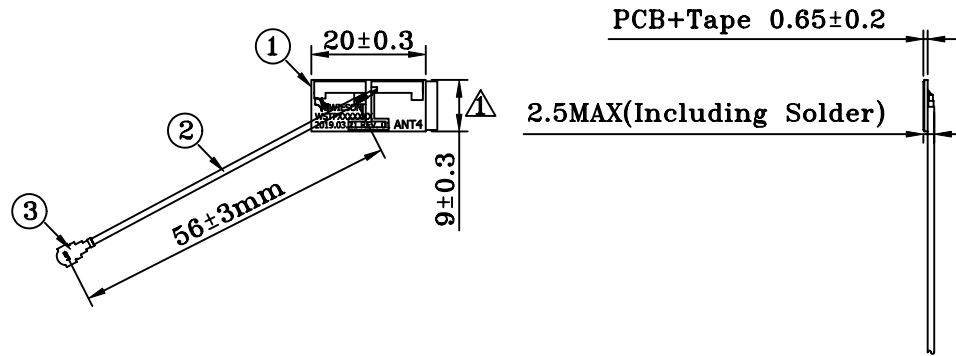

⑦								
⑥								
⑤								
④	Tape	G9000 , Size: 22 x 8.5mm△	1	TITLE: WIFI ANTENNA				
③	Connector	MHF Plug For 1.37mm Cable , Gold Plated	1	DRAWN BY	JAY(WST)	DRAWING NO.	WSTSXXXXXX	
②	Cable	1.37mm Normal Coaxial Cable , FEP Black Jacket	1	CHECKED BY		DRAWING SIZE	A4	
①	PCB	FR-4 , PCB Size: 20 x 9 x 0.4mm	1	APPROVED BY		UNIT	mm	
NO.	ITEM	DESCRIPTION	QTY	SORTING NO.	WSC	PAGE	1 OF 1	



WIESON TECHNOLOGIES CO., LTD
WIESON

PART NO.:
GY196HC112-021

The details of the antenna are as follows :

1. Model :

2. Quantity : 10

3. Results :

Name	Failure Rate	MTBF
GY196HC112-XXX	3678.2	31.0353 Years

*Fits (Failure Unit)=Failure Per Hour(10^9)

Failure Rate(λ)= 1×10^9 Hours (FITs)

MTBF= $1 / \lambda$

Bellcore Method I – Case 1 Equations

Device Steady – State Failure rate = $\lambda \text{ SSi}$

Where:

$$\lambda \text{ SSi} = \lambda \text{ Gi } \pi \text{ Qi } \pi \text{ Si } \pi \text{ Ti}$$

$\lambda \text{ Gi}$ =Generic steady-state failure rate for the ith device

$\pi \text{ Ti}$ =Temperature Factor based on 40°C temperature(value of 1.0)

$\pi \text{ Si}$ =Stress Factor =based on 50% stress(value of 1.0)

$\pi \text{ Qi}$ =Quality Factor for the ith device

Part Number	Description	Q'ty	$\lambda \text{ Gi}$	$\pi \text{ Ti}$	$\pi \text{ Si}$	$\pi \text{ Qi}$	$\lambda \text{ SSi}$	MTBF
	GY196HC112-XXX	1	3678.2	1	1	1	3678.2	31.0353 Years

驊 陸 科 技 股 份 有 限 公 司 WIESON TECHNOLOGES CO.,LTD	工 程 部		文件編號		
	產 品 編 號 規 範		版 本	A	頁 數

GY196 系列

品名: RF ANTENNA

GY196

HC112 -

XXX



RF Antenna 系列碼

客戶代碼

流水碼

General-purpose double coated tapes **G9000-SY**

Features

- Adhesive tape with lower environmental impact with UV curable manufacturing method (non solvent adhesive coating process).
- G9000-SY clears The VOC guideline of Japanese Health, Labor and Welfare.
- High adhesive quality (heat resistance and weather resistance) for wide ranging applications.
- Excellent holding power even at elevated temperature of 100°C.

Structure

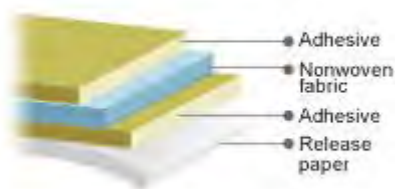

Product name	G9000-SY
Main component	Acrylic
Carrier	Nonwoven fabric
Color	Translucent
Adhesive thickness (μm)	About 150
Release paper thickness (μm)	About 120
Bonding strength (N/20mm) *1	11.77
Bonding strength (N/20mm) *2	8.00
St'd size (width & length)	500mm × 50m 1020mm × 50m

*1 180° peeling strength / substrate : stainless steel SUS304 (surface is polished by #280 sandpaper)

*2 180° peeling strength / substrate : stainless steel SUS304BA

Suitable use

- It is suitable for the material bonding usage of plastic such as nameplates and front panels of electricity and an electronic equipment (ABS, PS, and acrylic resin, etc.) and the metals (aluminum and stainless steel plate, etc.).

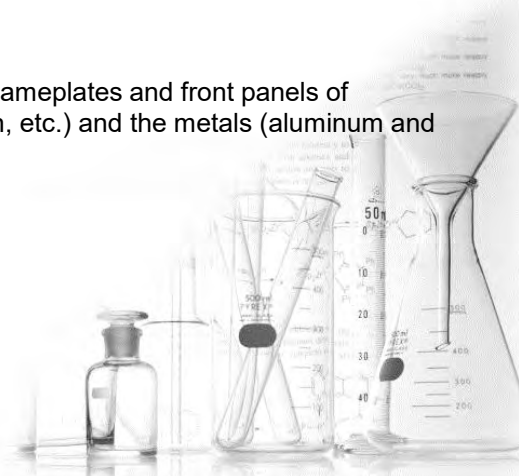

Technical data

[Remarks]

*The above values are sample observed values, not the guaranteed performance.

1. Bonding strength on various type of substrate (180° peeling)

<Test piece condition>

Tape width: 20mm

Bonding condition: One stroke with 2-kg roller

Measuring condition: 23°C±5°C 60%±20%RH

Peeling speed: 300mm/min

Backing material: 25µmPET

[Left at RT for one hour before measurement]

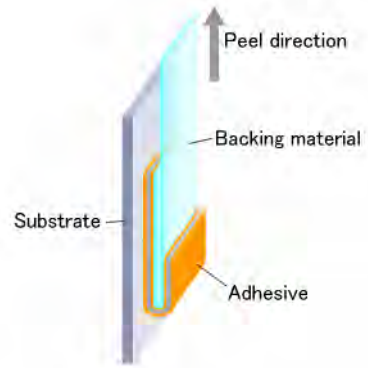

<180° peeling strength test>

<Results>

(N/20mm)

Substrate	AL	ABS	Acrylic	PS	PC	PP
180° peeling strength	8.8	11.6	12.4	11.5	11.9	5.1

Substrate	Soft PVC	Hard PVC	Glass	CR	NR	Slip and stick
180° peeling strength	12.6	13.2	12.9	3.4	4.0	

2. Holding power at different temperatures

<Test piece condition>

Substrate: Stainless steel SUS304

(surface is polished by #280 sandpaper)

Bonding area: 25mm × 25mm

Bonding condition: One stroke with 2-kg roller

[Left at RT for one hour and then at each temperature for 30 minutes before measurement]

[Creep length after one hour application of 1-kg load]

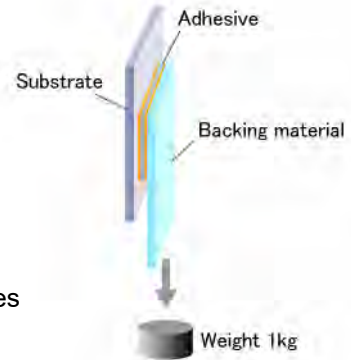

<Holding power test>

<Results>

Measurement temperature	40°C	60°C	80°C	100°C
Creep length (mm)	0.2	0.3	0.3	0.6

3. Bonding strength at different temperatures (180° peeling)

<Test piece condition>

Substrate: Stainless steel SUS304 (surface is polished by #280 sandpaper)

Tape width : 20mm

Bonding condition: One stroke with 2-kg roller

Peeling speed: 300mm/min

Backing material: 100µm Aluminum foil (-20°C to 5°C), 25µmPET (10°C to 100°C)

[Left at RT for one day and then at each temperature for 30 minutes before measurement]

<Results>

(N/20mm)

Measurement temperature	-20°C	0°C	5°C	10°C	23°C	40°C	60°C	80°C	100°C
180° peeling strength	*	32.4	28.3	25.5	17.4	14.4	11.9	10.8	9.3

* AF from backing material

4. Stable weight peeling

<Test piece condition>

Tape width: 20mm

Bonding condition: One stroke with 2-kg roller

Measurement condition: 23°C±5°C 60%±20%RH

[Left at RT for one hour, measure the peeled off distance by 100-g load]

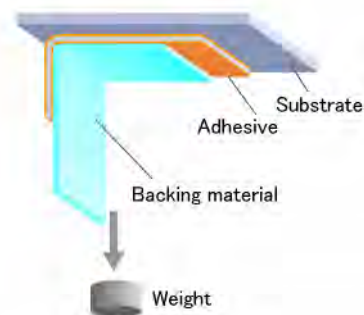

<Stable weight peeling test>

<Results>

		SUS	AL	ABS	PS	Acrylic	PP
Peel off distance (mm)	1 hour	1.0	2.0	2.0	2.5	2.0	3.5
	3 hours	1.3	3.0	3.5	5.0	3.3	7.8
	5 hours	1.3	2.8	4.5	7.5	4.5	11.0
	24 hours	1.5	9.5	18.5	34.0	16.0	59.0

5. Amount of VOC diffusion

<Methods of analysis>

JIS A-1901: Small chamber method

<Results>

(Volatile organic compound)	The indoor density indicator value ※	G9000-SY
formaldehyde	100µg/m ³	<2.5
toluene	260µg/m ³	<0.5
Xylene	870µg/m ³	<0.5
para-dichlorobenzene	240µg/m ³	<0.5
Ethylbenzene	3800µg/m ³	<0.5
styrene	220µg/m ³	<0.5
Chlorpyrifos	1µg/m ³	<0.02
Dibutyl phthalate	220µg/m ³	<0.02
tetradecane	330µg/m ³	0.7
Bis-(2-ethylhexyl)phthalate	120µg/m ³	<0.02
DIAZINON	0.29µg/m ³	<0.02
acetaldehyde	48µg/m ³	<2.5
FENOBUCARB	33µg/m ³	<0.02

※ The indoor density indicator value that the Ministry of Health, Labour and Welfare in Japan sets

Revision in Apr., 2015

Note on the characteristic data given— Data on the characteristics of the products described in this catalog are based on the results of evaluations carried out by the company. This does not guarantee that the characteristics of the product conform with your usage environment. Before use, review the usage conditions based on evaluation data obtained from the equipment and substrates actually used.

Dexerials Corporation

URL: <http://www.dexerials.jp/en/>

Head Office: Gate City Osaki, East Tower 8th floor, 1-11-2 Osaki, Shinagawa-ku, Tokyo, JAPAN 141-0032

Chemical Products Sales Dept. TEL: +81-3-5435-3946



ITEM	INDEX	PAGE
1.	THE PRODUCT SPECIFICATION LIST.....	1
2.	BILL OF MATERIAL.....	2
3.	SGS OF PCB.....	3~41
4.	SGS OF CABLE.....	42~78
5.	SGS OF MHF.....	79~100
6.	SGS OF TAPE.....	101~107
7.	TEST REPORT.....	108~137
8.	CPK.....	138
9.	CABLE SPEC.....	139
10.	MHF REPORT.....	140~141
11.	WIESON CERTIFICATE.....	142

					Approvals	
Rev	Date	Description	Edited by	Prepared :	MARS	
01	2019/10/14	ISSUE	MARS	Checked :	Fountain	
02	2023/2/21	Update test report	MARS	Approved :	ROX	
				Issued No :	02	
				Sheet :	1 OF 142	

No part of the information shown of this document may be used in any way without office stamp or written consent of WIESON TECHNOLOGIES CO., LTD.



WIESON TECHNOLOGIES CO.,LTD

BILL OF MATERIAL

Cust.	仲琦	TITLE	WIFI Antenna				
Cust.P/N		WIESON P/N	GY196HC112-021				
NO.	DESCRIPTION	SUPPLIER	SUPPLIER PART NO.	UL NO.	AVL	QUANTITY	REMARK
1	FR-4 , PCB Size: 20 x 9 x 0.4mm			/	/	1PCS	/
2	1.37mm Normal Coaxial Cable , FEP Black Jacket			/	/	MM	/
3	MHF Plug For 1.37mm Cable , Gold Plated					1PCS	/
4	G9000 , Size: 22 x 8.5mm					1PCS	
5							
6							
7							
8							

APPROVED BY:ROX

CHECKD BY: Fountain

DESIGNED BY:MARS

Test Report

No. SHAEC2204780903

Date: 29 Mar 2022

Page 1 of 13

Client Name : JIANGSU KUANGSHUN PHOTOSENSITIVITY NEW-MATERIAL STOCK CO., LTD.

Client Address : Huacheng Road 18, Qingyang Industried Area, Jiangyin City, Jiangsu Province

Sample Name : Liquid photoimageable solder mask

Model No. : KSM-S6189

Material No. : KSM-19

Client Ref. Information : To 75°C pre-bake for 3 hours; 150°C, 2 hours curable mixture

The above sample(s) and information were provided by the client.

SGS Job No. : SP22-007543 - SUZ

Date of Sample Received : 17 Mar 2022

Testing Period : 17 Mar 2022 - 29 Mar 2022

Test Requested : Selected test(s) as requested by client.

Test Method : Please refer to next page(s).

Test Results : Please refer to next page(s).

Conclusion : Based on the performed tests on submitted sample(s), the results of Cadmium, Lead, Mercury, Hexavalent chromium, Polybrominated biphenyls (PBBs), Polybrominated diphenyl ethers (PBDEs) and Phthalates such as Bis(2-ethylhexyl) phthalate (DEHP), Butyl benzyl phthalate (BBP), Dibutyl phthalate (DBP) and Diisobutyl phthalate (DIBP) comply with the limits as set by RoHS Directive (EU) 2015/863 amending Annex II to Directive 2011/65/EU.

Signed for and on behalf of
SGS-CSTC Standards Technical Services (Shanghai) Co., Ltd.

Dora Hu

Dora Hu
Approved Signatory

scan to see the report



E62126CF



Unless otherwise agreed in writing, this document is issued by the Company subject to its General Conditions of Service printed overleaf, available on request or accessible at <http://www.sgs.com/en/Terms-and-Conditions.aspx> and, for electronic format documents, subject to Terms and Conditions for Electronic Documents at <http://www.sgs.com/en/Terms-and-Conditions/Terms-e-Documents.aspx>. Attention is drawn to the limitation of liability, indemnification and jurisdiction issues defined therein. Any holder of this document is advised that information contained hereon reflects the Company's findings at the time of its intervention only and within the limits of Client's instructions, if any. The Company's sole responsibility is to its Client and this document does not exonerate parties to a transaction from exercising all their rights and obligations under the transaction documents. This document cannot be reproduced except in full, without prior written approval of the Company. Any unauthorized alteration, forgery or falsification of the content or appearance of this document is unlawful and offenders may be prosecuted to the fullest extent of the law. Unless otherwise stated the results shown in this test report refer only to the sample(s) tested.

Attention: To check the authenticity of testing /inspection report & certificate, please contact us at telephone: (86-755) 8307 1443, or email: CN.Doccheck@sgs.com

3rd Building, No. 889 Yishan Road Xuhui District, Shanghai China 200233 | E&E (86-21) 61402553 | E&E (86-21) 64953679 | www.sgs.com.cn
中国·上海·徐汇区宜山路889号3号楼 邮编: 200233 | THL (86-21) 61402594 | FHL (86-21) 61156899 | e sgs.china@sgs.com

Test Report

No. SHAEC2204780903

Date: 29 Mar 2022

Page 2 of 13

Test Results :

Test Part Description :

Specimen No.	SGS Sample ID	Description
SN1	SHA22-047809.002	Black solid

Remarks :

- (1) 1 mg/kg = 0.0001%
- (2) MDL = Method Detection Limit
- (3) ND = Not Detected (< MDL)
- (4) "-" = Not Regulated

RoHS Directive (EU) 2015/863 amending Annex II to Directive 2011/65/EU

Test Method : With reference to IEC 62321-4:2013+AMD1:2017, IEC62321-5:2013, IEC62321-7-2:2017, IEC 62321-6:2015 and IEC62321-8:2017, analyzed by ICP-OES, UV-Vis and GC-MS.

Test Item(s)	Limit	Unit	MDL	002
Cadmium (Cd)	100	mg/kg	2	ND
Lead (Pb)	1000	mg/kg	2	ND
Mercury (Hg)	1000	mg/kg	2	ND
Hexavalent Chromium (Cr(VI))	1000	mg/kg	8	ND
Sum of PBBs	1000	mg/kg	-	ND
Monobromobiphenyl	-	mg/kg	5	ND
Dibromobiphenyl	-	mg/kg	5	ND
Tribromobiphenyl	-	mg/kg	5	ND
Tetrabromobiphenyl	-	mg/kg	5	ND
Pentabromobiphenyl	-	mg/kg	5	ND
Hexabromobiphenyl	-	mg/kg	5	ND
Heptabromobiphenyl	-	mg/kg	5	ND
Octabromobiphenyl	-	mg/kg	5	ND
Nonabromobiphenyl	-	mg/kg	5	ND
Decabromobiphenyl	-	mg/kg	5	ND
Sum of PBDEs	1000	mg/kg	-	ND
Monobromodiphenyl ether	-	mg/kg	5	ND
Dibromodiphenyl ether	-	mg/kg	5	ND
Tribromodiphenyl ether	-	mg/kg	5	ND
Tetrabromodiphenyl ether	-	mg/kg	5	ND



Unless otherwise agreed in writing, this document is issued by the Company subject to its General Conditions of Service printed overleaf, available on request or accessible at <http://www.sgs.com/en/Terms-and-Conditions.aspx> and, for electronic format documents, subject to Terms and Conditions for Electronic Documents at <http://www.sgs.com/en/Terms-and-Conditions/Terms-e-Documents.aspx>. Attention is drawn to the limitation of liability, indemnification and jurisdiction issues defined therein. Any holder of this document is advised that information contained hereon reflects the Company's findings at the time of its intervention only and within the limits of Client's instructions, if any. The Company's sole responsibility is to its Client and this document does not exonerate parties to a transaction from exercising all their rights and obligations under the transaction documents. This document cannot be reproduced except in full, without prior written approval of the Company. Any unauthorized alteration, forgery or falsification of the content or appearance of this document is unlawful and offenders may be prosecuted to the fullest extent of the law. Unless otherwise stated the results shown in this test report refer only to the sample(s) tested.

Attention: To check the authenticity of testing /inspection report & certificate, please contact us at telephone: (86-755) 8307 1443, or email: CN.Doccheck@sgs.com

SGS-CSI (Shanghai) Inspection & Testing Services Co., Ltd. 3rd Building, No. 889 Yishan Road Xuhui District, Shanghai China 200233 1E&E (86-21) 61402553 1E&E (86-21) 64953879 www.sgsgroup.com.cn
 中国·上海·徐汇区宜山路889号3号楼 邮编: 200233 1HL (86-21) 61402594 1HL (86-21) 61156899 e sgs.china@sgs.com

Test Report

No. SHAEC2204780903

Date: 29 Mar 2022

Page 3 of 13

<u>Test Item(s)</u>	<u>Limit</u>	<u>Unit</u>	<u>MDL</u>	<u>002</u>
Pentabromodiphenyl ether	-	mg/kg	5	ND
Hexabromodiphenyl ether	-	mg/kg	5	ND
Heptabromodiphenyl ether	-	mg/kg	5	ND
Octabromodiphenyl ether	-	mg/kg	5	ND
Nonabromodiphenyl ether	-	mg/kg	5	ND
Decabromodiphenyl ether	-	mg/kg	5	ND
Di-butyl Phthalate (DBP)	1000	mg/kg	50	ND
Benzyl Butyl Phthalate (BBP)	1000	mg/kg	50	ND
Di-2-Ethyl Hexyl Phthalate (DEHP)	1000	mg/kg	50	ND
Diisobutyl Phthalates (DIBP)	1000	mg/kg	50	ND

Notes :

- (1) The maximum permissible limit is quoted from RoHS Directive (EU) 2015/863. IEC 62321 series is equivalent to EN 62321 series
https://www.cenelec.eu/dyn/www/f?p=104:30:1742232870351101:::FSP_ORG_ID,FSP_LANG_ID:1258637,25
- (2) The restriction of DEHP, BBP, DBP and DIBP shall apply to medical devices, including in vitro medical devices, and monitoring and control instruments, including industrial monitoring and control instruments, from 22 July 2021.

Element(s)

Test Method : With reference to US EPA 3052:1996, analysis was performed by ICP-OES.

<u>Test Item(s)</u>	<u>Unit</u>	<u>MDL</u>	<u>002</u>
Arsenic (As)	mg/kg	10	ND

Hexabromocyclododecane (HBCDD/HBCD)

Test Method : With reference to US EPA 3550C: 2007, analysis was performed by GC-MS.

<u>Test Item(s)</u>	<u>CAS NO.</u>	<u>Unit</u>	<u>MDL</u>	<u>002</u>
Hexabromocyclododecane (HBCDD/HBCD)	25637-99-4/	mg/kg	10	ND
	3194-55-6			

Phthalates Content



Unless otherwise agreed in writing, this document is issued by the Company subject to its General Conditions of Service printed overleaf, available on request or accessible at <http://www.sgs.com/en/Terms-and-Conditions.aspx> and, for electronic format documents, subject to Terms and Conditions for Electronic Documents at <http://www.sgs.com/en/Terms-and-Conditions/Terms-e-Document.aspx>. Attention is drawn to the limitation of liability, indemnification and jurisdiction issues defined therein. Any holder of this document is advised that information contained hereon reflects the Company's findings at the time of its intervention only and within the limits of Client's instructions, if any. The Company's sole responsibility is to its Client and this document does not exonerate parties to a transaction from exercising all their rights and obligations under the transaction documents. This document cannot be reproduced except in full, without prior written approval of the Company. Any unauthorized alteration, forgery or falsification of the content or appearance of this document is unlawful and offenders may be prosecuted to the fullest extent of the law. Unless otherwise stated the results shown in this test report refer only to the sample(s) tested.

Attention: To check the authenticity of testing /inspection report & certificate, please contact us at telephone: (86-755) 8307 1443, or email: CN.Doccheck@sgs.com

3rd Building, No. 889 Yishan Road Xuhui District, Shanghai China 200233 1E&E (86-21) 61402553 1E&E (86-21) 64953879 www.sgs.com.cn
 中国·上海·徐汇区宜山路889号3号楼 邮编: 200233 1HL (86-21) 61402594 1HL (86-21) 61156899 e sgs.china@sgs.com

Test Report

No. SHAEC2204780903

Date: 29 Mar 2022

Page 4 of 13

Test Method : With reference to EN 14372:2004, analysis was performed by GC-MS.

<u>Test Item(s)</u>	<u>CAS NO.</u>	<u>Unit</u>	<u>MDL</u>	<u>002</u>
Dibutyl Phthalate (DBP)	84-74-2	%	0.003	ND
Benzylbutyl Phthalate (BBP)	85-68-7	%	0.003	ND
Bis-(2-ethylhexyl) Phthalate (DEHP)	117-81-7	%	0.003	ND
Diisononyl Phthalate (DINP)	28553-12-0	%	0.01	ND
	/68515-48-0			
Di-n-octyl Phthalate (DNOP)	117-84-0	%	0.003	ND
Diisodecyl Phthalate (DIDP)	26761-40-0	%	0.01	ND
	/68515-49-1			
Dimethyl Phthalate (DMP)	131-11-3	%	0.003	ND
Diethyl Phthalate (DEP)	84-66-2	%	0.003	ND
Diisobutyl Phthalate (DIBP)	84-69-5	%	0.003	ND
Di-n-pentyl Phthalates (DnPP)	131-18-0	%	0.003	ND
Dicyclohexyl Phthalate (DCHP)	84-61-7	%	0.003	ND
Diphenyl Phthalate (DPhP)	84-62-8	%	0.003	ND
Dibenzyl Phthalate (DBzP)	523-31-9	%	0.003	ND
Diisooctyl Phthalate (DiOP)	27554-26-3	%	0.01	ND
Dipropyl Phthalate (DPrP)	131-16-8	%	0.003	ND
Dinonyl Phthalate (DNP)	84-76-4	%	0.003	ND
Di-n-hexyl Phthalate (DnHP)	84-75-3	%	0.003	ND

Perfluorooctanesulfonate (PFOS) and its derivatives and Perfluorooctanoic Acid (PFOA)

Test Method : With reference to CEN/TS 15968:2010, analysis is performed by HPLC-MS or LC-MS-MS.

<u>Test Item(s)</u>	<u>CAS NO.</u>	<u>Unit</u>	<u>MDL</u>	<u>002</u>
Perfluorooctane sulfonates (PFOS) and its derivatives		mg/kg	-	ND
Perfluorooctane Sulfonates (PFOS)^	1763-23-1	mg/kg	0.01	ND
2-(N-methylperfluoro-1-octanesulfonamido)- ethanol (MeFOSE)	24448-09-7	mg/kg	0.01	ND
2-(N-ethylperfluoro-1-octanesulfonamido)-ethanol (EtFOSE)	1691-99-2	mg/kg	0.01	ND
N-methylperfluoro-1-octanesulfonamide (MeFOSA)	31506-32-8	mg/kg	0.01	ND
N-ethylperfluoro-1-octanesulfonamide (EtFOSA)	4151-50-2	mg/kg	0.01	ND
Perfluorooctane Sulfonamide (PFOSA)	754-91-6	mg/kg	0.01	ND
Perfluorooctanoic Acid (PFOA) and its salts+		mg/kg	0.01	ND

Notes :

(1) + PFOA refer to its salts including PFOA-Na (CAS No.: 335-95-5), PFOA-K (CAS No.: 2395-00-8),



Unless otherwise agreed in writing, this document is issued by the Company subject to its General Conditions of Service printed overleaf, available on request or accessible at <http://www.sgs.com/en/Terms-and-Conditions.aspx> and, for electronic format documents, subject to Terms and Conditions for Electronic Documents at <http://www.sgs.com/en/Terms-and-Conditions/Terms-e-Documents.aspx>. Attention is drawn to the limitation of liability, indemnification and jurisdiction issues defined therein. Any holder of this document is advised that information contained hereon reflects the Company's findings at the time of its intervention only and within the limits of Client's instructions, if any. The Company's sole responsibility is to its Client and this document does not exonerate parties to a transaction from exercising all their rights and obligations under the transaction documents. This document cannot be reproduced except in full, without prior written approval of the Company. Any unauthorized alteration, forgery or falsification of the content or appearance of this document is unlawful and offenders may be prosecuted to the fullest extent of the law. Unless otherwise stated the results shown in this test report refer only to the sample(s) tested.

Attention: To check the authenticity of testing /inspection report & certificate, please contact us at telephone: (86-755) 8307 1443, or email: CN.Doccheck@sgs.com

3rd Building, No. 889 Yishan Road Xuhui District, Shanghai China 200233 | E&E (86-21) 61402553 | E&E (86-21) 64953679 | www.sgsgroup.com.cn
 中国·上海·徐汇区宜山路889号3号楼 邮编: 200233 | IHL (86-21) 61402594 | IHL (86-21) 61156899 | sgs.china@sgs.com

PFOA-Ag (CAS No.: 335-93-3), PFOA-F (CAS No.: 335-66-0) and APFO (CAS No.: 3825-26-1);
 (2) ^ PFOS including PFOS-K (CAS No.: 2795-39-3), PFOS-Li (CAS No.: 29457-72-5), PFOS-NH4 (CAS No.: 29081-56-9), PFOS-NH(OH)2 (CAS No.: 70225-14-8), PFOS-N(C2H5)4 (CAS No.: 56773-42-3), PFOS-DDA(CAS No.:251099-16-8) and POSF (CAS No.: 307-35-7)



Unless otherwise agreed in writing, this document is issued by the Company subject to its General Conditions of Service printed overleaf, available on request or accessible at <http://www.sgs.com/en/Terms-and-Conditions.aspx> and, for electronic format documents, subject to Terms and Conditions for Electronic Documents at <http://www.sgs.com/en/Terms-and-Conditions/Terms-e-Documents.aspx>. Attention is drawn to the limitation of liability, indemnification and jurisdiction issues defined therein. Any holder of this document is advised that information contained hereon reflects the Company's findings at the time of its intervention only and within the limits of Client's instructions, if any. The Company's sole responsibility is to its Client and this document does not exonerate parties to a transaction from exercising all their rights and obligations under the transaction documents. This document cannot be reproduced except in full, without prior written approval of the Company. Any unauthorized alteration, forgery or falsification of the content or appearance of this document is unlawful and offenders may be prosecuted to the fullest extent of the law. Unless otherwise stated the results shown in this test report refer only to the sample(s) tested.

Attention: To check the authenticity of testing /inspection report & certificate, please contact us at telephone: (86-755) 8307 1443, or email: CN.Doccheck@sgs.com

SGS-CSI (Shanghai) Technical Services (Group) Co., Ltd.
 Testing Center, China

3rd Building, No. 889 Yishan Road Xuhui District, Shanghai China 200233
 中国·上海·徐汇区宜山路889号3号楼 邮编: 200233

TEL (86-21) 61402553 TEL (86-21) 64953879 www.sgsgroup.com.cn
 TEL (86-21) 61402594 TEL (86-21) 61156899 sgs.china@sgs.com

ATTACHMENTS

Elements (IEC62321) Testing Flow Chart

1) These samples were dissolved totally by pre-conditioning method according to below flow chart.

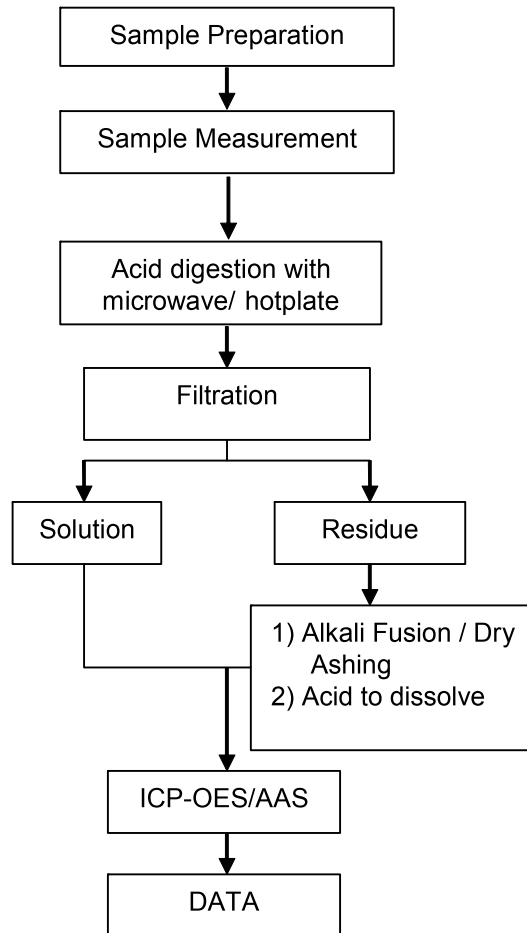

Unless otherwise agreed in writing, this document is issued by the Company subject to its General Conditions of Service printed overleaf, available on request or accessible at <http://www.sgs.com/en/Terms-and-Conditions.aspx> and, for electronic format documents, subject to Terms and Conditions for Electronic Documents at <http://www.sgs.com/en/Terms-and-Conditions/Terms-e-Documents.aspx>. Attention is drawn to the limitation of liability, indemnification and jurisdiction issues defined therein. Any holder of this document is advised that information contained hereon reflects the Company's findings at the time of its intervention only and within the limits of Client's instructions, if any. The Company's sole responsibility is to its Client and this document does not exonerate parties to a transaction from exercising all their rights and obligations under the transaction documents. This document cannot be reproduced except in full, without prior written approval of the Company. Any unauthorized alteration, forgery or falsification of the content or appearance of this document is unlawful and offenders may be prosecuted to the fullest extent of the law. Unless otherwise stated the results shown in this test report refer only to the sample(s) tested.

Attention: To check the authenticity of testing /inspection report & certificate, please contact us at telephone: (86-755) 8307 1443, or email: CN.Doccheck@sgs.com

SGS-CSI (Shanghai) Technical Services Co., Ltd. 3rd Building, No. 889 Yishan Road Xuhui District, Shanghai China 200233 1E&E (86-21) 61402553 1E&E (86-21) 64953879 www.sgs.com.cn
 中国·上海·徐汇区宜山路889号3号楼 邮编: 200233 1HL (86-21) 61402594 1HL (86-21) 61156899 e sgs.china@sgs.com

ATTACHMENTS

Hexavalent Chromium (Cr(VI)) Testing Flow Chart

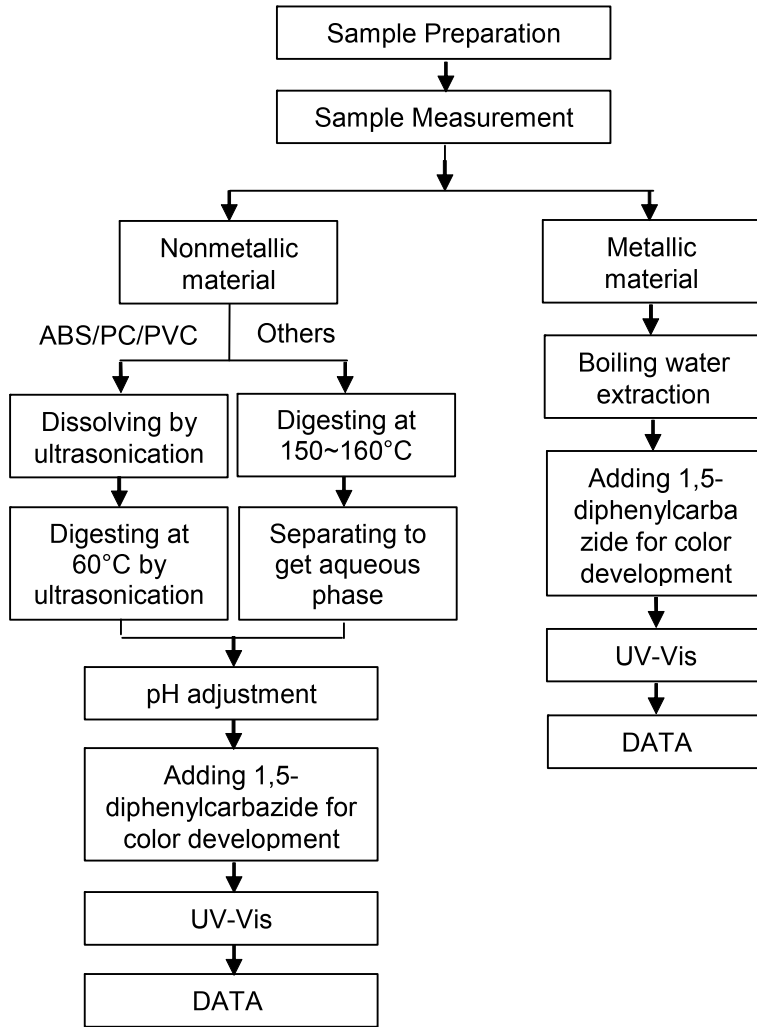

Unless otherwise agreed in writing, this document is issued by the Company subject to its General Conditions of Service printed overleaf, available on request or accessible at <http://www.sgs.com/en/Terms-and-Conditions.aspx> and, for electronic format documents, subject to Terms and Conditions for Electronic Documents at <http://www.sgs.com/en/Terms-and-Conditions/Terms-e-Document.aspx>. Attention is drawn to the limitation of liability, indemnification and jurisdiction issues defined therein. Any holder of this document is advised that information contained hereon reflects the Company's findings at the time of its intervention only and within the limits of Client's instructions, if any. The Company's sole responsibility is to its Client and this document does not exonerate parties to a transaction from exercising all their rights and obligations under the transaction documents. This document cannot be reproduced except in full, without prior written approval of the Company. Any unauthorized alteration, forgery or falsification of the content or appearance of this document is unlawful and offenders may be prosecuted to the fullest extent of the law. Unless otherwise stated the results shown in this test report refer only to the sample(s) tested.

Attention: To check the authenticity of testing /inspection report & certificate, please contact us at telephone: (86-755) 8307 1443, or email: CN.Doccheck@sgs.com

ATTACHMENTS

PBBs/PBDEs Testing Flow Chart

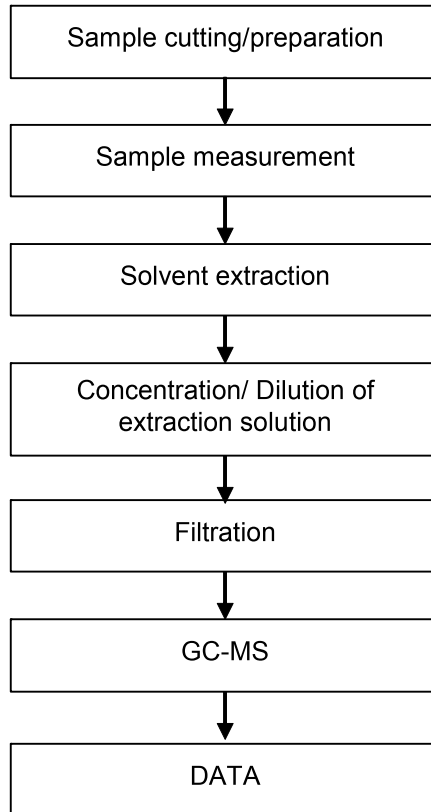

Unless otherwise agreed in writing, this document is issued by the Company subject to its General Conditions of Service printed overleaf, available on request or accessible at <http://www.sgs.com/en/Terms-and-Conditions.aspx> and, for electronic format documents, subject to Terms and Conditions for Electronic Documents at <http://www.sgs.com/en/Terms-and-Conditions/Terms-e-Documents.aspx>. Attention is drawn to the limitation of liability, indemnification and jurisdiction issues defined therein. Any holder of this document is advised that information contained hereon reflects the Company's findings at the time of its intervention only and within the limits of Client's instructions, if any. The Company's sole responsibility is to its Client and this document does not exonerate parties to a transaction from exercising all their rights and obligations under the transaction documents. This document cannot be reproduced except in full, without prior written approval of the Company. Any unauthorized alteration, forgery or falsification of the content or appearance of this document is unlawful and offenders may be prosecuted to the fullest extent of the law. Unless otherwise stated the results shown in this test report refer only to the sample(s) tested.

Attention: To check the authenticity of testing /inspection report & certificate, please contact us at telephone: (86-755) 8307 1443, or email: CN.Doccheck@sgs.com

SGS-CSI (Shanghai) Technical Services (Shanghai) Co., Ltd.
Testing Center (China) (Shanghai)

3rd Building, No. 889 Yishan Road Xuhui District, Shanghai China 200233
中国·上海·徐汇区宜山路889号3号楼 邮编: 200233

TEL (86-21) 61402553 | E&E (86-21) 64953679 | www.sgs.com
1HL (86-21) 61402594 | 1HL (86-21) 61156899 | sgs.china@sgs.com

ATTACHMENTS

Phthalates Testing Flow Chart

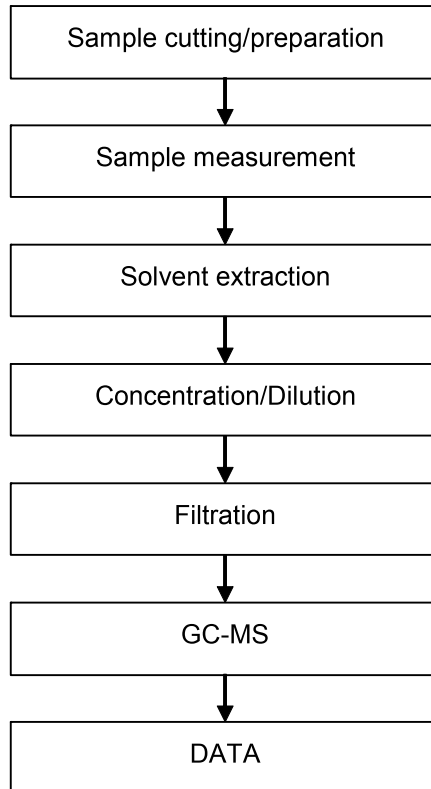

Unless otherwise agreed in writing, this document is issued by the Company subject to its General Conditions of Service printed overleaf, available on request or accessible at <http://www.sgs.com/en/Terms-and-Conditions.aspx> and, for electronic format documents, subject to Terms and Conditions for Electronic Documents at <http://www.sgs.com/en/Terms-and-Conditions/Terms-e-Documents.aspx>. Attention is drawn to the limitation of liability, indemnification and jurisdiction issues defined therein. Any holder of this document is advised that information contained hereon reflects the Company's findings at the time of its intervention only and within the limits of Client's instructions, if any. The Company's sole responsibility is to its Client and this document does not exonerate parties to a transaction from exercising all their rights and obligations under the transaction documents. This document cannot be reproduced except in full, without prior written approval of the Company. Any unauthorized alteration, forgery or falsification of the content or appearance of this document is unlawful and offenders may be prosecuted to the fullest extent of the law. Unless otherwise stated the results shown in this test report refer only to the sample(s) tested.

Attention: To check the authenticity of testing /inspection report & certificate, please contact us at telephone: (86-755) 8307 1443, or email: CN.Doccheck@sgs.com

SGS-CSI (Shanghai) Technical Services Co., Ltd.
Testing Center

3rd Building, No. 889 Yishan Road Xuhui District, Shanghai China 200233
中国·上海·徐汇区宜山路889号3号楼 邮编: 200233

TEL (86-21) 61402553 | E&E (86-21) 64953679 | www.sgs.com.cn
TEL (86-21) 61402594 | TEL (86-21) 61156899 | sgs.china@sgs.com

ATTACHMENTS

HBCDD Testing Flow Chart

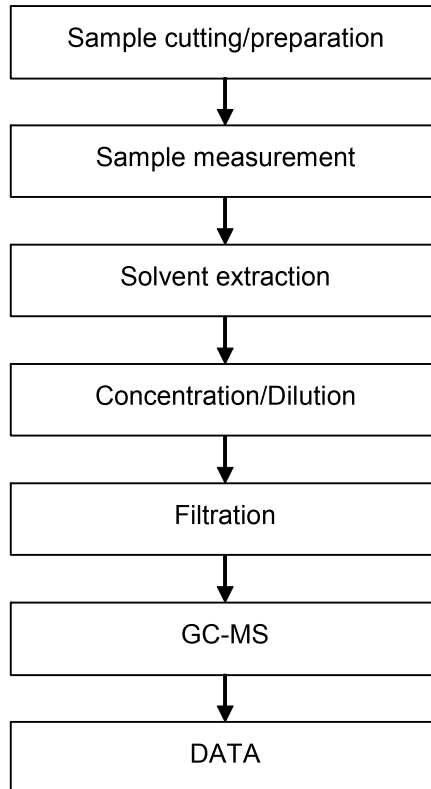

Unless otherwise agreed in writing, this document is issued by the Company subject to its General Conditions of Service printed overleaf, available on request or accessible at <http://www.sgs.com/en/Terms-and-Conditions.aspx> and, for electronic format documents, subject to Terms and Conditions for Electronic Documents at <http://www.sgs.com/en/Terms-and-Conditions/Terms-e-Documents.aspx>. Attention is drawn to the limitation of liability, indemnification and jurisdiction issues defined therein. Any holder of this document is advised that information contained hereon reflects the Company's findings at the time of its intervention only and within the limits of Client's instructions, if any. The Company's sole responsibility is to its Client and this document does not exonerate parties to a transaction from exercising all their rights and obligations under the transaction documents. This document cannot be reproduced except in full, without prior written approval of the Company. Any unauthorized alteration, forgery or falsification of the content or appearance of this document is unlawful and offenders may be prosecuted to the fullest extent of the law. Unless otherwise stated the results shown in this test report refer only to the sample(s) tested.

Attention: To check the authenticity of testing /inspection report & certificate, please contact us at telephone: (86-755) 8307 1443, or email: CN.Doccheck@sgs.com

SGS-CSI (Shanghai) Technical Services Co., Ltd.
Testing Center

3rd Building, No. 889 Yishan Road Xuhui District, Shanghai China 200233
中国·上海·徐汇区宜山路889号3号楼 邮编: 200233

TEL (86-21) 61402553 | E&E (86-21) 64953879 | www.sgs.com.cn
1HL (86-21) 61402594 | 1HL (86-21) 61156899 | sgs.china@sgs.com

ATTACHMENTS

PFASs/ PFOS/PFOA Testing Flow Chart

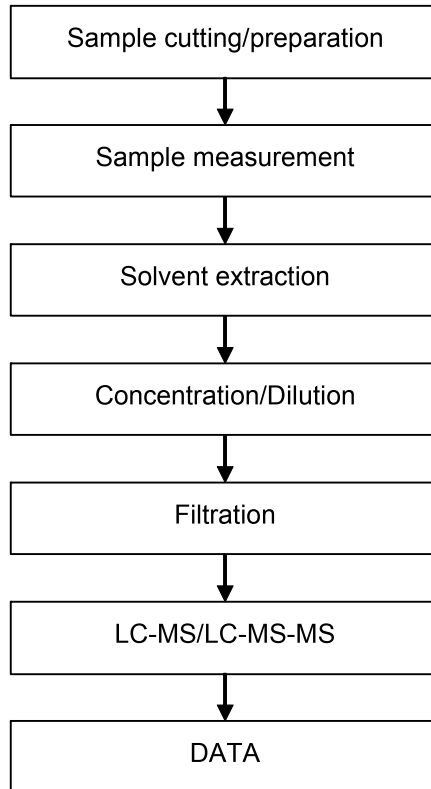

Unless otherwise agreed in writing, this document is issued by the Company subject to its General Conditions of Service printed overleaf, available on request or accessible at <http://www.sgs.com/en/Terms-and-Conditions.aspx> and, for electronic format documents, subject to Terms and Conditions for Electronic Documents at <http://www.sgs.com/en/Terms-and-Conditions/Terms-e-Documents.aspx>. Attention is drawn to the limitation of liability, indemnification and jurisdiction issues defined therein. Any holder of this document is advised that information contained hereon reflects the Company's findings at the time of its intervention only and within the limits of Client's instructions, if any. The Company's sole responsibility is to its Client and this document does not exonerate parties to a transaction from exercising all their rights and obligations under the transaction documents. This document cannot be reproduced except in full, without prior written approval of the Company. Any unauthorized alteration, forgery or falsification of the content or appearance of this document is unlawful and offenders may be prosecuted to the fullest extent of the law. Unless otherwise stated the results shown in this test report refer only to the sample(s) tested.

Attention: To check the authenticity of testing /inspection report & certificate, please contact us at telephone: (86-755) 8307 1443, or email: CN.Doccheck@sgs.com

3rd Building, No. 889 Yishan Road Xuhui District, Shanghai China 200233 | E&E (86-21) 61402553 | E&E (86-21) 64953879 | www.sgs.com
 中国·上海·徐汇区宜山路889号3号楼 邮编: 200233 | 1HL (86-21) 61402594 | 1HL (86-21) 61156899 | sgs.china@sgs.com

ATTACHMENTS

Elements Testing Flow Chart

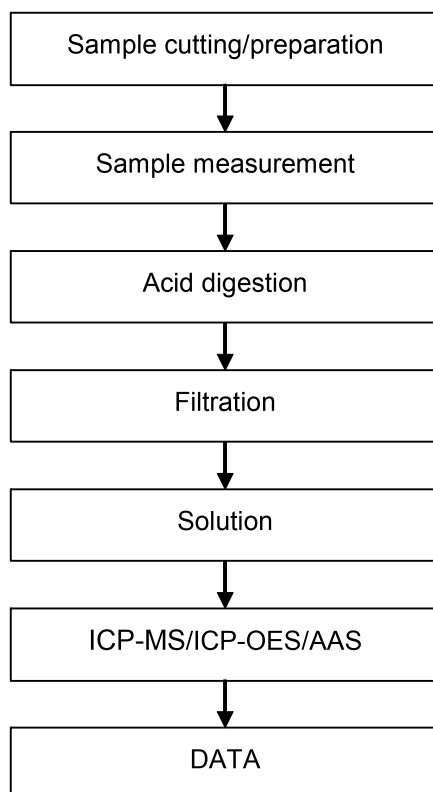

Unless otherwise agreed in writing, this document is issued by the Company subject to its General Conditions of Service printed overleaf, available on request or accessible at <http://www.sgs.com/en/Terms-and-Conditions.aspx> and, for electronic format documents, subject to Terms and Conditions for Electronic Documents at <http://www.sgs.com/en/Terms-and-Conditions/Terms-e-Documents.aspx>. Attention is drawn to the limitation of liability, indemnification and jurisdiction issues defined therein. Any holder of this document is advised that information contained hereon reflects the Company's findings at the time of its intervention only and within the limits of Client's instructions, if any. The Company's sole responsibility is to its Client and this document does not exonerate parties to a transaction from exercising all their rights and obligations under the transaction documents. This document cannot be reproduced except in full, without prior written approval of the Company. Any unauthorized alteration, forgery or falsification of the content or appearance of this document is unlawful and offenders may be prosecuted to the fullest extent of the law. Unless otherwise stated the results shown in this test report refer only to the sample(s) tested.

Attention: To check the authenticity of testing /inspection report & certificate, please contact us at telephone: (86-755) 8307 1443, or email: CN.Doccheck@sgs.com

Sample photo:



SGS authenticate the photo on original report only

*** End of Report ***



Unless otherwise agreed in writing, this document is issued by the Company subject to its General Conditions of Service printed overleaf, available on request or accessible at <http://www.sgs.com/en/Terms-and-Conditions.aspx> and, for electronic format documents, subject to Terms and Conditions for Electronic Documents at <http://www.sgs.com/en/Terms-and-Conditions/Terms-e-Document.aspx>. Attention is drawn to the limitation of liability, indemnification and jurisdiction issues defined therein. Any holder of this document is advised that information contained hereon reflects the Company's findings at the time of its intervention only and within the limits of Client's instructions, if any. The Company's sole responsibility is to its Client and this document does not exonerate parties to a transaction from exercising all their rights and obligations under the transaction documents. This document cannot be reproduced except in full, without prior written approval of the Company. Any unauthorized alteration, forgery or falsification of the content or appearance of this document is unlawful and offenders may be prosecuted to the fullest extent of the law. Unless otherwise stated the results shown in this test report refer only to the sample(s) tested.

Attention: To check the authenticity of testing /inspection report & certificate, please contact us at telephone: (86-755) 8307 1443, or email: CN.Doccheck@sgs.com

3rd Building, No. 889 Yishan Road Xuhui District, Shanghai China 200233 1E&E (86-21) 61402553 1E&E (86-21) 64953879 www.sgs.com
中国·上海·徐汇区宜山路889号3号楼 邮编: 200233 1HL (86-21) 61402594 1HL (86-21) 61156899 sgs.china@sgs.com

检测报告

编号: CANEC2202185402

日期: 2022年03月08日 第1页,共26页

客户名称: 建滔积层板控股有限公司
 客户地址: 香港新界沙田安耀街三号汇达大厦二十三楼

样品名称: KB-6160
 型号: KB-6160
 客户参考信息: KB-6160A, KB-6160C, KB-6164, KB-6150, KB-6150C, KB-6160F, P-138
 以上样品及信息由客户提供。

SGS工作编号: CP22-005249 - GZ
 样品接收日期: 2022年02月16日
 检测周期: 2022年02月16日 - 2022年03月02日
 检测要求: 根据客户要求检测
 检测方法: 请参见下一页
 检测结果: 请参见下一页

检测结果概要:

检测要求	结论
RoHS指令2011/65/EU附录II的修正指令(EU) 2015/863	符合
卤素	见检测结果
元素分析	见检测结果
石棉	见检测结果
四溴双酚-A	见检测结果
红磷	见检测结果
双酚-A	见检测结果
聚氯乙烯(PVC)	见检测结果
邻苯二甲酸盐(或酯)	见检测结果
甲醛	见检测结果
六溴环十二烷(HBCDD)	见检测结果
全氟辛酸(PFOA)及其盐 & 全氟辛烷磺酸 (PFOS)及其衍生物	见检测结果
美国环保署有毒物质控制法 (TSCA) 第6 (h)节规定的持久性、生物累积性和毒性 (PBT) 化学物质	符合



Unless otherwise agreed in writing, this document is issued by the Company subject to its General Conditions of Service printed overleaf, available on request or accessible at <http://www.sgs.com/en/Terms-and-Conditions.aspx> and, for electronic format documents, subject to Terms and Conditions for Electronic Documents at <http://www.sgs.com/en/Terms-and-Conditions/Terms-e-Documents.aspx>. Attention is drawn to the limitation of liability, indemnification and jurisdiction issues defined therein. Any holder of this document is advised that information contained hereon reflects the Company's findings at the time of its intervention only and within the limits of Client's instructions, if any. The Company's sole responsibility is to its Client and this document does not exonerate parties to a transaction from exercising all their rights and obligations under the transaction documents. This document cannot be reproduced except in full, without prior written approval of the Company. Any unauthorized alteration, forgery or falsification of the content or appearance of this document is unlawful and offenders may be prosecuted to the fullest extent of the law. Unless otherwise stated the results shown in this test report refer only to the sample(s) tested.

检测报告

编号: CANEC2202185402

日期: 2022年03月08日 第2页,共26页

有机锡	见检测结果
欧盟POPs法规(EU) 2019/1021-短链氯化石蜡(SCCPs) (C ₁₀ ~C ₁₃)	符合
AfPS GS 2019:01 PAK-多环芳香烃	见检测结果
多氯联苯(PCBs)	见检测结果
苯并三唑类紫外吸收剂	见检测结果

通标标准技术服务有限公司广州分公司
授权签名

李嘉欣

Jessie Li 李嘉欣
批准签署人

scan to see the report



D0FC8&CF



Unless otherwise agreed in writing, this document is issued by the Company subject to its General Conditions of Service printed overleaf, available on request or accessible at <http://www.sgs.com/en/Terms-and-Conditions.aspx> and, for electronic format documents, subject to Terms and Conditions for Electronic Documents at <http://www.sgs.com/en/Terms-and-Conditions/Terms-e-Document.aspx>. Attention is drawn to the limitation of liability, indemnification and jurisdiction issues defined therein. Any holder of this document is advised that information contained hereon reflects the Company's findings at the time of its intervention only and within the limits of Client's instructions, if any. The Company's sole responsibility is to its Client and this document does not exonerate parties to a transaction from exercising all their rights and obligations under the transaction documents. This document cannot be reproduced except in full, without prior written approval of the Company. Any unauthorized alteration, forgery or falsification of the content or appearance of this document is unlawful and offenders may be prosecuted to the fullest extent of the law. Unless otherwise stated the results shown in this test report refer only to the sample(s) tested.

Attention: To check the authenticity of testing /inspection report & certificate, please contact us at telephone: (86-755) 8307 1443, or email: CN.Doccheck@sgs.com

检测报告

编号: CANEC2202185402

日期: 2022年03月08日 第3页,共26页

检测结果:

检测样品描述:

样品编号	SGS样品ID	描述
SN1	CAN22-021854.003	双面覆铜板

备注:

- (1) 1 mg/kg = 0.0001%
- (2) MDL = 方法检测限
- (3) ND = 未检出 (< MDL)
- (4) "-" = 未规定

RoHS指令2011/65/EU附录II的修正指令(EU) 2015/863

检测方法: 参考IEC 62321-4:2013+A1:2017, IEC 62321-5:2013, IEC 62321-7-2:2017, IEC 62321-6:2015 和 IEC 62321-8:2017, 采用 ICP-OES, UV-Vis 和 GC-MS 进行分析.

检测项目	限值	单位	MDL	003
镉 (Cd)	100	mg/kg	2	ND
铅 (Pb)	1000	mg/kg	2	16
汞 (Hg)	1000	mg/kg	2	ND
六价铬(Cr(VI))	1000	mg/kg	8	ND
多溴联苯之和(PBBs)	1000	mg/kg	-	ND
一溴联苯	-	mg/kg	5	ND
二溴联苯	-	mg/kg	5	ND
三溴联苯	-	mg/kg	5	ND
四溴联苯	-	mg/kg	5	ND
五溴联苯	-	mg/kg	5	ND
六溴联苯	-	mg/kg	5	ND
七溴联苯	-	mg/kg	5	ND
八溴联苯	-	mg/kg	5	ND
九溴联苯	-	mg/kg	5	ND
十溴联苯	-	mg/kg	5	ND
多溴二苯醚之和(PBDEs)	1000	mg/kg	-	ND
一溴二苯醚	-	mg/kg	5	ND
二溴二苯醚	-	mg/kg	5	ND
三溴二苯醚	-	mg/kg	5	ND
四溴二苯醚	-	mg/kg	5	ND
五溴二苯醚	-	mg/kg	5	ND
六溴二苯醚	-	mg/kg	5	ND



Unless otherwise agreed in writing, this document is issued by the Company subject to its General Conditions of Service printed overleaf, available on request or accessible at <http://www.sgs.com/en/Terms-and-Conditions.aspx> and, for electronic format documents, subject to Terms and Conditions for Electronic Documents at <http://www.sgs.com/en/Terms-and-Conditions/Terms-e-Documents.aspx>. Attention is drawn to the limitation of liability, indemnification and jurisdiction issues defined therein. Any holder of this document is advised that information contained hereon reflects the Company's findings at the time of its intervention only and within the limits of Client's instructions, if any. The Company's sole responsibility is to its Client and this document does not exonerate parties to a transaction from exercising all their rights and obligations under the transaction documents. This document cannot be reproduced except in full, without prior written approval of the Company. Any unauthorized alteration, forgery or falsification of the content or appearance of this document is unlawful and offenders may be prosecuted to the fullest extent of the law. Unless otherwise stated the results shown in this test report refer only to the sample(s) tested.

Attention: To check the authenticity of testing / inspection report & certificate, please contact us at telephone: (86-755) 8307 1443, or email: CN.Doccheck@sgs.com

检测报告

编号: CANEC2202185402

日期: 2022年03月08日 第4页,共26页

检测项目	限值	单位	MDL	003
七溴二苯醚	-	mg/kg	5	ND
八溴二苯醚	-	mg/kg	5	ND
九溴二苯醚	-	mg/kg	5	ND
十溴二苯醚	-	mg/kg	5	ND
邻苯二甲酸二丁酯 (DBP)	1000	mg/kg	50	ND
邻苯二甲酸丁苄酯(BBP)	1000	mg/kg	50	ND
邻苯二甲酸二(2-乙基己基)酯(DEHP)	1000	mg/kg	50	ND
邻苯二甲酸二异丁酯(DIBP)	1000	mg/kg	50	ND

备注:

(1)最大允许极限值引用自RoHS指令(EU) 2015/863。

(2) IEC 62321 系列等同于 EN 62321 系列

https://www.cenelec.eu/dyn/www/f?p=104:30:1742232870351101:::FSP_ORG_ID,FSP_LANG_ID:1258637,25

(3) 2021年7月22号开始, DEHP, BBP, DBP 和 DIBP的限制适用于医疗器械, 包括体外医疗器械, 监控仪表, 包括工业监测和控制仪器。

卤素

检测方法: 参考EN 14582:2016, 用 IC分析。

检测项目	单位	MDL	003
氟 (F)	mg/kg	50	859
氯 (Cl)	mg/kg	50	330
溴 (Br)	mg/kg	50	32943
碘 (I)	mg/kg	50	ND

元素分析

检测方法: SGS内部方法 (GZTC CHEM-TOP-004-01, 参考EPA 3052: 1996), 采用ICP-OES进行分析。

检测项目	单位	MDL	003
砷 (As)	mg/kg	10	ND
锑 (Sb)	mg/kg	10	ND
铍 (Be)	mg/kg	5	ND

石棉



Unless otherwise agreed in writing, this document is issued by the Company subject to its General Conditions of Service printed overleaf, available on request or accessible at <http://www.sgs.com/en/Terms-and-Conditions.aspx> and, for electronic format documents, subject to Terms and Conditions for Electronic Documents at <http://www.sgs.com/en/Terms-and-Conditions/Terms-e-Documents.aspx>. Attention is drawn to the limitation of liability, indemnification and jurisdiction issues defined therein. Any holder of this document is advised that information contained hereon reflects the Company's findings at the time of its intervention only and within the limits of Client's instructions, if any. The Company's sole responsibility is to its Client and this document does not exonerate parties to a transaction from exercising all their rights and obligations under the transaction documents. This document cannot be reproduced except in full, without prior written approval of the Company. Any unauthorized alteration, forgery or falsification of the content or appearance of this document is unlawful and offenders may be prosecuted to the fullest extent of the law. Unless otherwise stated the results shown in this test report refer only to the sample(s) tested.

Attention: To check the authenticity of testing /inspection report & certificate, please contact us at telephone: (86-755) 8307 1443, or email: CN.Doccheck@sgs.com

检测报告

编号: CANEC2202185402

日期: 2022年03月08日 第5页,共26页

检测方法: 参考NIOSH 9000:2015 / NIOSH 9002:1994, 采用XRD / PLM进行分析。

检测项目	CAS NO.	单位	MDL	003
温石棉	12001-29-5/13220 7-32-0	% (m/m)	0.1	阴性
铁石棉	12172-73-5	% (m/m)	0.1	阴性
青石棉	12001-28-4	% (m/m)	0.1	阴性
直闪石	77536-67-5	% (m/m)	0.1	阴性
透闪石	77536-68-6	% (m/m)	0.1	阴性
阳起石	77536-66-4	% (m/m)	0.1	阴性

备注:

(1)阴性表示未检出石棉, 阳性表示检出石棉。

四溴双酚-A

检测方法: SGS内部方法(GZTC CHEM-TOP-065, 参考EPA 3540C:1996 & EPA 8270E:2017), 采用LC-MS/MS进行分析。

检测项目	单位	MDL	003
四溴双酚-A	mg/kg	5	ND

红磷

检测方法: SGS内部方法(SGS-CCL-TOP-215-01), 采用PY-GC/MS / ICP-OES / GC-MS 进行分析。

检测项目	单位	MDL	003
红磷	mg/kg	500	ND

双酚-A

检测方法: SGS内部方法(GZTC CHEM-TOP-075-02, 参考EPA 3550C:2007 和EPA 8321B:2007), 采用LC-MS进行分析。



Unless otherwise agreed in writing, this document is issued by the Company subject to its General Conditions of Service printed overleaf, available on request or accessible at <http://www.sgs.com/en/Terms-and-Conditions.aspx> and, for electronic format documents, subject to Terms and Conditions for Electronic Documents at <http://www.sgs.com/en/Terms-and-Conditions/Terms-e-Documents.aspx>. Attention is drawn to the limitation of liability, indemnification and jurisdiction issues defined therein. Any holder of this document is advised that information contained hereon reflects the Company's findings at the time of its intervention only and within the limits of Client's instructions, if any. The Company's sole responsibility is to its Client and this document does not exonerate parties to a transaction from exercising all their rights and obligations under the transaction documents. This document cannot be reproduced except in full, without prior written approval of the Company. Any unauthorized alteration, forgery or falsification of the content or appearance of this document is unlawful and offenders may be prosecuted to the fullest extent of the law. Unless otherwise stated the results shown in this test report refer only to the sample(s) tested.

Attention: To check the authenticity of testing / inspection report & certificate, please contact us at telephone: (86-755) 8307 1443, or email: CN.Doccheck@sgs.com

检测报告

编号: CANEC2202185402

日期: 2022年03月08日 第6页,共26页

检测项目	CAS NO.	单位	MDL	003
双酚-A	80-05-7	mg/kg	1.0	ND

聚氯乙烯(PVC)

检测方法: SGS内部方法(SGS-CCL-TOP-066-01), 采用FTIR进行分析。

检测项目	CAS NO.	单位	MDL	003
聚氯乙烯(PVC)	9002-86-2	-	-	阴性

备注:

(1) 阴性 = 未检测到, 阳性 = 已检测到

邻苯二甲酸盐(或酯)

检测方法: 参考EN 14372: 2004的方法测定, 采用GC-MS进行分析。

检测项目	CAS NO.	单位	MDL	003
邻苯二甲酸二丁酯 (DBP)	84-74-2	%(w/w)	0.003	ND
邻苯二甲酸丁苄酯 (BBP)	85-68-7	%(w/w)	0.003	ND
邻苯二甲酸二(2-乙基己基)酯 (DEHP)	117-81-7	%(w/w)	0.003	ND
邻苯二甲酸二异壬酯 (DINP)	28553-12-0 / 68515-48-0	%(w/w)	0.010	ND
邻苯二甲酸二正辛酯 (DNOP)	117-84-0	%(w/w)	0.003	ND
邻苯二甲酸二异癸酯 (DIDP)	26761-40-0 / 68515-49-1	%(w/w)	0.010	ND
邻苯二甲酸二甲酯 (DMP)	131-11-3	%(w/w)	0.003	ND
邻苯二甲酸二乙酯 (DEP)	84-66-2	%(w/w)	0.003	ND
邻苯二甲酸二丙酯 (DPrP)	131-16-8	%(w/w)	0.003	ND
邻苯二甲酸二异丁酯 (DIBP)	84-69-5	%(w/w)	0.003	ND
邻苯二甲酸二戊酯 (DPENP/ DnPP)	131-18-0	%(w/w)	0.003	ND
邻苯二甲酸二正己酯 (DnHP)	84-75-3	%(w/w)	0.003	ND
邻苯二甲酸二环己酯 (DCHP)	84-61-7	%(w/w)	0.003	ND
邻苯二甲酸二苯酯 (DPhP)	84-62-8	%(w/w)	0.003	ND
邻苯二甲酸二苄酯 (DBzP)	523-31-9	%(w/w)	0.003	ND
邻苯二甲酸二壬酯 (DNP)	84-76-4	%(w/w)	0.003	ND
邻苯二甲酸二异辛酯 (DIOP)	27554-26-3	%(w/w)	0.010	ND
邻苯二甲酸二(2-甲氧基乙基)酯 (DMEP)	117-82-8	%(w/w)	0.003	ND



Unless otherwise agreed in writing, this document is issued by the Company subject to its General Conditions of Service printed overleaf, available on request or accessible at <http://www.sgs.com/en/Terms-and-Conditions.aspx> and, for electronic format documents, subject to Terms and Conditions for Electronic Documents at <http://www.sgs.com/en/Terms-and-Conditions/Terms-e-Documents.aspx>. Attention is drawn to the limitation of liability, indemnification and jurisdiction issues defined therein. Any holder of this document is advised that information contained hereon reflects the Company's findings at the time of its intervention only and within the limits of Client's instructions, if any. The Company's sole responsibility is to its Client and this document does not exonerate parties to a transaction from exercising all their rights and obligations under the transaction documents. This document cannot be reproduced except in full, without prior written approval of the Company. Any unauthorized alteration, forgery or falsification of the content or appearance of this document is unlawful and offenders may be prosecuted to the fullest extent of the law. Unless otherwise stated the results shown in this test report refer only to the sample(s) tested.

Attention: To check the authenticity of testing / inspection report & certificate, please contact us at telephone: (86-755) 8307 1443, or email: CN.Doccheck@sgs.com

检测报告

编号: CANEC2202185402

日期: 2022年03月08日 第7页,共26页

检测项目	CAS NO.	单位	MDL	003
邻苯二甲酸二烯丙酯 (DAP)	131-17-9	%(w/w)	0.003	ND
邻苯二甲酸癸基辛基酯 (nDnOP)	119-07-3	%(w/w)	0.003	ND
邻苯二甲酸二癸酯 (DnDP)	84-77-5	%(w/w)	0.003	ND
邻苯二甲酸二异戊酯 (DIPP)	605-50-5	%(w/w)	0.003	ND
邻苯二甲酸正戊基异戊基酯 (nPIPP)	776297-69-9	%(w/w)	0.003	ND
邻苯二甲酸二(C6-8支链)烷基酯(富C7) (DIHP)	71888-89-6	%(w/w)	0.010	ND
邻苯二甲酸二(C7-11支链与直链)烷基(醇)酯 (DHNUP)	68515-42-4	%(w/w)	0.010	ND
己二酸二(2-乙基己基)酯(DEHA)	103-23-1	%(w/w)	0.003	ND
邻苯二甲酸二(4-甲基-2-戊基)酯 (BMPP)	146-50-9	%(w/w)	0.003	ND
邻苯二甲酸二(2-乙氧基)乙酯 (DEEP)	605-54-9	%(w/w)	0.003	ND
邻苯二甲酸二(2-丁氧基)乙酯 (DBEP)	117-83-9	%(w/w)	0.003	ND
邻苯二甲酸双十一烷酯 (DUDP)	3648-20-2	%(w/w)	0.003	ND
己二酸二异壬酯(DINA)	33703-08-1	%(w/w)	0.010	ND
邻苯二甲酸双十三烷基酯 (DTDP)	119-06-2	%(w/w)	0.003	ND
偏苯三酸三(2-乙基己基)酯 (TOTM)	3319-31-1	%(w/w)	0.003	ND
对苯二甲酸二(2-乙基己基)酯 (DOTP)	6422-86-2	%(w/w)	0.003	ND
邻苯二甲酸二庚酯 (DnHpP)	3648-21-3	%(w/w)	0.003	ND
乙酰柠檬酸三丁酯 (Citroflex, ATBC)	77-90-7	%(w/w)	0.010	ND
邻苯二甲酸二(支链与直链)戊基酯 (DPP)	84777-06-0	%(w/w)	0.010	ND
邻苯二甲酸二(支链与直链)己基酯 (DHP)	68515-50-4	%(w/w)	0.010	ND
邻苯二甲酸二(2-丙基庚)酯(DPHpP)	53306-54-0	%(w/w)	0.010	ND

备注:

(1) DBP、BBP、DEHP、DIBP参考信息: 欧盟决议(EC) No 1907/2006 REACH 附录XVII及其修正案(EU) 2018/2005 第51条:

i) 不允许DBP、BBP、DEHP、DIBP单一质量浓度或质量浓度总和等于或高于0.1%的可塑性物料用于玩具和儿童护理品。

ii) 当玩具和儿童护理品中的可塑性物料含DBP、BBP、DEHP单一质量浓度或质量浓度总和等于或高于0.1%时, 不得投放市场。另外, 当玩具和儿童护理品中的可塑性物料含DIBP单一质量浓度或DBP、BBP、DEHP、DIBP质量浓度总和等于或高于0.1%时, 2020年7月7日后不得投放市场。

iii) 当成品中的可塑性物料含DBP、BBP、DEHP、DIBP单一质量浓度或质量浓度总和等于或高于0.1%时, 2020年7月7日后不得投放市场。

详细信息请参见Regulation (EU) 2018/2005

(2) DINP、DNOP、DIDP参考信息: 欧盟决议(EC) No 1907/2006 REACH 附录XVII及修正案(EU) 2015/326 第52条:

i) 不允许DINP、DNOP、DIDP质量浓度高于0.1%的可塑性物料用于可放入儿童口中的玩具和儿童护理品。

ii) 当可放入儿童口中的玩具和儿童护理品中的可塑性物料含DINP, DNOP, DIDP质量浓度高于0.1%时, 不得投放市场。

详细信息请参见Regulation (EU) 2015/326



Unless otherwise agreed in writing, this document is issued by the Company subject to its General Conditions of Service printed overleaf, available on request or accessible at <http://www.sgs.com/en/Terms-and-Conditions.aspx> and, for electronic format documents, subject to Terms and Conditions for Electronic Documents at <http://www.sgs.com/en/Terms-and-Conditions/Terms-e-Document.aspx>. Attention is drawn to the limitation of liability, indemnification and jurisdiction issues defined therein. Any holder of this document is advised that information contained hereon reflects the Company's findings at the time of its intervention only and within the limits of Client's instructions, if any. The Company's sole responsibility is to its Client and this document does not exonerate parties to a transaction from exercising all their rights and obligations under the transaction documents. This document cannot be reproduced except in full, without prior written approval of the Company. Any unauthorized alteration, forgery or falsification of the content or appearance of this document is unlawful and offenders may be prosecuted to the fullest extent of the law. Unless otherwise stated the results shown in this test report refer only to the sample(s) tested.

Attention: To check the authenticity of testing (inspection report & certificate), please contact us at telephone: (86-755) 8307 1443, or email: CN.Doccheck@sgs.com

检测报告

编号: CANEC2202185402

日期: 2022年03月08日 第8页,共26页

甲醛

检测方法: 参考 ISO 14184-1:2011, 用 UV-Vis 分析。

检测项目	CAS NO.	单位	MDL	003
甲醛	50-00-0	mg/kg	16	ND

六溴环十二烷(HBCDD)

检测方法: SGS 内部方法(GZTC CHEM-TOP-073, 参考EPA 3550C:2007), 采用GC-MS进行分析。

检测项目	CAS NO.	单位	MDL	003
六溴环十二烷(HBCDD) 及其非对映异构体(α -HBCDD, β -HBCDD, γ -HBCDD)	25637-99-4 3194-55-6 134237-50-6 134237-51-7 134237-52-8	mg/kg	10	ND

全氟辛酸(PFOA)及其盐 & 全氟辛烷磺酸 (PFOS)及其衍生物

检测方法: 参考CEN/TS 15968:2010, 采用LC-MS或LC-MS/MS进行分析。

检测项目	CAS NO.	单位	MDL	003
全氟辛酸 (PFOA) 及其盐+	335-67-1	mg/kg	0.010	ND
全氟辛烷磺酸 (PFOS) [^]	1763-23-1	mg/kg	0.010	ND
全氟辛基磺酰胺(PFOSA)	754-91-6	mg/kg	0.010	ND
N-甲基全氟辛烷磺酰胺(MeFOSA)	31506-32-8	mg/kg	0.010	ND
N-乙基全氟辛烷磺酰胺(EtFOSA)	4151-50-2	mg/kg	0.010	ND
2-(N-甲基全氟辛基磺酰胺)乙醇(MeFOSE)	24448-09-7	mg/kg	0.010	ND
2-(N-乙基全氟辛基磺酰胺)乙醇(EtFOSE)	1691-99-2	mg/kg	0.010	ND
全氟辛烷磺酸 (PFOS) 及其衍生物	-	mg/kg	-	ND

备注:

- (1) + PFOA 及其盐包含PFOA-Na (CAS No.: 335-95-5), PFOA-K (CAS No.: 2395-00-8), PFOA-Ag (CAS No.: 335-93-3), PFOA-F (CAS No.: 335-66-0) 和 APFO (CAS No.: 3825-26-1);
- (2) ^ 全氟辛烷磺酸 (PFOS) 包含 PFOS-K (CAS No.: 2795-39-3), PFOS-Li (CAS No.: 29457-72-5), PFOS-NH₄ (CAS No.: 29081-56-9), PFOS-NH(OH)₂ (CAS No.: 70225-14-8), PFOS-N(C₂H₅)₄ (CAS No.: 56773-42-3), PFOS-DDA (CAS No.:251099-16-8) 和 POSF (CAS No.: 307-35-7)

美国环保署有毒物质控制法 (TSCA) 第6 (h)节规定的持久性、生物累积性和毒性 (PBT) 化学物质



Unless otherwise agreed in writing, this document is issued by the Company subject to its General Conditions of Service printed overleaf, available on request or accessible at <http://www.sgs.com/en/Terms-and-Conditions.aspx> and, for electronic format documents, subject to Terms and Conditions for Electronic Documents at <http://www.sgs.com/en/Terms-and-Conditions/Terms-e-Documents.aspx>. Attention is drawn to the limitation of liability, indemnification and jurisdiction issues defined therein. Any holder of this document is advised that information contained hereon reflects the Company's findings at the time of its intervention only and within the limits of Client's instructions, if any. The Company's sole responsibility is to its Client and this document does not exonerate parties to a transaction from exercising all their rights and obligations under the transaction documents. This document cannot be reproduced except in full, without prior written approval of the Company. Any unauthorized alteration, forgery or falsification of the content or appearance of this document is unlawful and offenders may be prosecuted to the fullest extent of the law. Unless otherwise stated the results shown in this test report refer only to the sample(s) tested.

Attention: To check the authenticity of testing (inspection report & certificate), please contact us at telephone: (86-755) 8307 1443, or email: CN.Doccheck@sgs.com

SGS CSTC (Guangzhou) Technical Services Co., Ltd.
Guangzhou Branch Inspection & Testing Services Laboratory

198 Kazhu Road, Sciencetech Park Guangzhou Economic & Technology Development District, Guangzhou, China 510663
中国·广州·经济技术开发区科学城科珠路198号 邮编: 510663

t (86-20) 82155555 www.sgsgroup.com.cn
t (86-20) 82155555 sgs.china@sgs.com

检测报告

编号: CANEC2202185402

日期: 2022年03月08日 第9页,共26页

检测方法: SGS内部方法(SGS-CCL-TOP-149-07, 参考US EPA 方法 3550C:2007), 采用GC-MS进行分析。

检测项目	CAS NO.	限值	单位	MDL	003
十溴二苯醚 (Deca-BDE) Δ^1	1163-19-5	★	mg/kg	5	ND
异丙基化磷酸三苯酯 (PIP 3:1) Δ^2	68937-41-7	★	mg/kg	5	ND
2,4,6-三叔丁基苯酚 (2,4,6-TTBP) Δ^3	732-26-3	3000	mg/kg	5	ND
六氯丁二烯 (HCBd)	87-68-3	★	mg/kg	5	ND
五氯苯硫酚 (PCTP)	133-49-3	10000	mg/kg	5	ND
结论					符合

备注:

1. “★”= 禁止使用
2. 法规信息请参见下链接
<https://www.epa.gov/assessing-and-managing-chemicals-under-tsca/persistent-bioaccumulative-and-toxic-pbt-chemicals-under>
3. Δ^1 : 若送测样品来自于产品或物品含有十溴二苯醚的产品或物品的回收塑料, 则可豁免;
4. Δ^2 : 提交的样品有下列情形之一的, 不在法规的管控范围内:
 - 用于航空或军事用途的液压油;
 - 润滑剂和润滑油;
 - 汽车和航空航天车辆的新零件和替换零件;
 - 生产氰基丙烯酸酯胶粘剂的中间体;
 - 机车和船用专用发动机空气滤清器;
 - 来自于含有PIP (3:1) 的产品或物品的回收塑料;
 - 用含有PIP (3:1) 回收产品或物品的塑料制成的产品或物品
5. Δ^3 : 提交的样品如果不是机油或润滑油, 则不在法规的管控范围内;

有机锡

检测方法: SGS内部方法 (GZTC CHEM-TOP-031, 参考ISO 17353:2004), 采用GC-MS进行分析。

检测项目	单位	MDL	003
二丁基锡(DBT)	mg/kg	0.02	ND
三丁基锡(TBT)	mg/kg	0.02	ND
二辛基锡(DOT)	mg/kg	0.02	ND
三苯基锡(TPhT)	mg/kg	0.02	ND

欧盟POPs法规(EU) 2019/1021-短链氯化石蜡(SCCPs) (C₁₀-C₁₃)

检测方法: 参考ISO 18219-1:2021, 采用GC-NCI-MS进行分析。



Unless otherwise agreed in writing, this document is issued by the Company subject to its General Conditions of Service printed overleaf, available on request or accessible at <http://www.sgs.com/en/Terms-and-Conditions.aspx> and, for electronic format documents, subject to Terms and Conditions for Electronic Documents at <http://www.sgs.com/en/Terms-and-Conditions/Terms-e-Documents.aspx>. Attention is drawn to the limitation of liability, indemnification and jurisdiction issues defined therein. Any holder of this document is advised that information contained hereon reflects the Company's findings at the time of its intervention only and within the limits of Client's instructions, if any. The Company's sole responsibility is to its Client and this document does not exonerate parties to a transaction from exercising all their rights and obligations under the transaction documents. This document cannot be reproduced except in full, without prior written approval of the Company. Any unauthorized alteration, forgery or falsification of the content or appearance of this document is unlawful and offenders may be prosecuted to the fullest extent of the law. Unless otherwise stated the results shown in this test report refer only to the sample(s) tested.

Attention: To check the authenticity of testing (inspection report & certificate), please contact us at telephone: (86-755) 8307 1443, or email: CN.Doccheck@sgs.com

检测报告

编号: CANEC2202185402

日期: 2022年03月08日 第10页,共26页

检测项目	限值	单位	MDL	003
短链氯化石蜡(SCCPs) (C ₁₀ ~C ₁₃)	1500	mg/kg	50	ND
评论				符合

AfPS GS 2019:01 PAK-多环芳香烃

检测方法: 参考AfPS GS 2019:01 PAK 检测, 采用 GC-MS 进行分析。

检测项目	CAS NO.	单位	MDL	003
萘 (NAP)	91-20-3	mg/kg	0.1	ND
菲 (PHE)	85-01-8	mg/kg	0.1	ND
蒽 (ANT)	120-12-7	mg/kg	0.1	ND
荧蒽 (FLT)	206-44-0	mg/kg	0.1	ND
芘 (PYR)	129-00-0	mg/kg	0.1	ND
苯并(a)蒽 (BaA)	56-55-3	mg/kg	0.1	ND
蒽 (CHR)	218-01-9	mg/kg	0.1	ND
苯并(b)荧蒽 (BbF)	205-99-2	mg/kg	0.1	ND
苯并(j)荧蒽 (BjF)	205-82-3	mg/kg	0.1	ND
苯并(k)荧蒽 (BkF)	207-08-9	mg/kg	0.1	ND
苯并(a)芘 (BaP)	50-32-8	mg/kg	0.1	ND
苯并(e)芘 (BeP)	192-97-2	mg/kg	0.1	ND
茚并(1,2,3-c,d)芘 (IPY)	193-39-5	mg/kg	0.1	ND
二苯并(a,h)蒽 (DBA)	53-70-3	mg/kg	0.1	ND
苯并(g,h,i)芘(二苯并(a,h)芘) (BPE)	191-24-2	mg/kg	0.1	ND
4项多环芳香烃总和(菲 (PHE), 芘 (PYR), 蒽 (ANT), 荧蒽 (FLT))	-	mg/kg	-	ND
15项多环芳香烃总和	-	mg/kg	-	ND



Unless otherwise agreed in writing, this document is issued by the Company subject to its General Conditions of Service printed overleaf, available on request or accessible at <http://www.sgs.com/en/Terms-and-Conditions.aspx> and, for electronic format documents, subject to Terms and Conditions for Electronic Documents at <http://www.sgs.com/en/Terms-and-Conditions/Terms-e-DocumentL.aspx>. Attention is drawn to the limitation of liability, indemnification and jurisdiction issues defined therein. Any holder of this document is advised that information contained hereon reflects the Company's findings at the time of its intervention only and within the limits of Client's instructions, if any. The Company's sole responsibility is to its Client and this document does not exonerate parties to a transaction from exercising all their rights and obligations under the transaction documents. This document cannot be reproduced except in full, without prior written approval of the Company. Any unauthorized alteration, forgery or falsification of the content or appearance of this document is unlawful and offenders may be prosecuted to the fullest extent of the law. Unless otherwise stated the results shown in this test report refer only to the sample(s) tested.

Attention: To check the authenticity of testing /inspection report & certificate, please contact us at telephone: (86-755) 8307 1443, or email: CN.Doccheck@sgs.com

AfPS (德国产品安全委员会): 多环芳香烃的要求

参数 (mg/kg)	1类	2类		3类	
	设计意图为放入口中的材料, 或与皮肤长期接触(超过30秒)的材料用于 -2009/48/EC定义的玩具, 或 -供3岁以下儿童 ^{a,b} 使用。	不属于第1类, 设计意图或可预见 ^d 与皮肤长期接触(超过30秒)或短期重复接触 ^e 的材料		不属于第1和2类, 设计意图或可预见与皮肤短期接触(不超过30秒)材料	
		a.供儿童使用的产品	b.其他产品	a.供儿童使用的产品	b.其他产品
苯并(a)芘 (BaP)	< 0.2	< 0.2	< 0.5	< 0.5	< 1
苯并(e)芘 (BeP)	< 0.2	< 0.2	< 0.5	< 0.5	< 1
苯并(a)蒽 (BaA)	< 0.2	< 0.2	< 0.5	< 0.5	< 1
苯并(b)荧蒽 (BbF)	< 0.2	< 0.2	< 0.5	< 0.5	< 1
苯并(j)荧蒽 (BjF)	< 0.2	< 0.2	< 0.5	< 0.5	< 1
苯并(k)荧蒽 (BkF)	< 0.2	< 0.2	< 0.5	< 0.5	< 1
蒽 (CHR)	< 0.2	< 0.2	< 0.5	< 0.5	< 1
二苯并(a,h)蒽 (DBA)	< 0.2	< 0.2	< 0.5	< 0.5	< 1
苯并(g,h,i)芘(二苯并(a,h)芘) (BPE)	< 0.2	< 0.2	< 0.5	< 0.5	< 1
茚并(1,2,3-c,d)芘 (IPY)	< 0.2	< 0.2	< 0.5	< 0.5	< 1
菲 (PHE), 芘 (PYR), 蒽 (ANT), 荧蒽 (FLT)	< 1 (总和)	< 5 (总和)	< 10 (总和)	< 20 (总和)	< 50 (总和)
萘 (NAP)	< 1	< 2		< 10	
15 PAH之和	<1	< 5	< 10	< 20	< 50

注释:

^a 儿童是指法定年龄未满 14 周岁的人。

^b 供儿童使用包括儿童的主动接触或被动接触。

^c “短期重复接触”的定义摘自 REACH 附录 XVII 第 50 条修正案 ((EC) No. 1272/2013)。

^d 根据德国产品安全法 (ProdSG) (第一章第 2 条第 28 款) 的定义, “可预见的使用”是指将产品投放市场的人无意但可以合理预见的方式使用产品。

备注:

德国产品安全委员会 (AfPS) 于 2020 年 4 月 10 日发布了关于多环芳香烃 (PAHs) 的新文件 (AfPS GS 2019:01 PAK), 该文件将于 2020 年 7 月 1 日起用于 GS-MARK 认证。

多氯联苯(PCBs)

检测方法: SGS内部方法 (GZTC CHEM-TOP-032-01, 参考EPA 8082A:2007), 采用 GC-ECD/GC-MS 进行分析。



Unless otherwise agreed in writing, this document is issued by the Company subject to its General Conditions of Service printed overleaf, available on request or accessible at <http://www.sgs.com/en/Terms-and-Conditions.aspx> and, for electronic format documents, subject to Terms and Conditions for Electronic Documents at <http://www.sgs.com/en/Terms-and-Conditions/Terms-e-Documents.aspx>. Attention is drawn to the limitation of liability, indemnification and jurisdiction issues defined therein. Any holder of this document is advised that information contained hereon reflects the Company's findings at the time of its intervention only and within the limits of Client's instructions, if any. The Company's sole responsibility is to its Client and this document does not exonerate parties to a transaction from exercising all their rights and obligations under the transaction documents. This document cannot be reproduced except in full, without prior written approval of the Company. Any unauthorized alteration, forgery or falsification of the content or appearance of this document is unlawful and offenders may be prosecuted to the fullest extent of the law. Unless otherwise stated the results shown in this test report refer only to the sample(s) tested.

Attention: To check the authenticity of testing /inspection report & certificate, please contact us at telephone: (86-755) 8307 1443, or email: CN.Doccheck@sgs.com

检测报告

编号: CANEC2202185402

日期: 2022年03月08日 第12页,共26页

检测项目	CAS NO.	单位	MDL	003
2,4,4'-三氯联苯 (PCB 28)	7012-37-5	mg/kg	0.5	ND
2,2',5,5'-四氯联苯 (PCB 52)	35693-99-3	mg/kg	0.5	ND
2,2',4,5,5'-五氯联苯(PCB 101)	37680-73-2	mg/kg	0.5	ND
2,3',4,4',5-五氯联苯(PCB 118)	31508-00-6	mg/kg	0.5	ND
2,2',3,4,4',5'-六氯联苯 (PCB 138)	35065-28-2	mg/kg	0.5	ND
2,2',4,4',5,5'-六氯联苯 (PCB 153)	35065-27-1	mg/kg	0.5	ND
2,2',3,4,4',5,5'-七氯联苯 (PCB 180)	35065-29-3	mg/kg	0.5	ND

苯并三唑类紫外吸收剂

检测方法: SGS内部方法 (GZTC CHEM-TOP-102, 参考EPA 3550C:2007), 采用 GC-MS 进行分析。

检测项目	CAS NO.	单位	MDL	003
2-(2'-羟基-3',5'-二叔丁基苯基)-苯并三唑	3846-71-7	mg/kg	5	ND
2-(2'-羟基-3',5'-二叔丁基苯基)-5-氯代苯并三唑	3864-99-1	mg/kg	5	ND
2-(2'-羟基-3',5'-二叔戊基苯基)苯并三唑	25973-55-1	mg/kg	5	ND
2-(2'-羟基-3'-异丁基-5'-叔丁基苯基)苯并三唑	36437-37-3	mg/kg	5	ND

除非另有说明, 此报告结果仅对检测的样品负责。本报告未经本公司书面许可, 不可部分复制。检测报告仅用于客户科研、教学、内部质量控制、产品研发等目的, 仅供内部参考。



Unless otherwise agreed in writing, this document is issued by the Company subject to its General Conditions of Service printed overleaf, available on request or accessible at <http://www.sgs.com/en/Terms-and-Conditions.aspx> and, for electronic format documents, subject to Terms and Conditions for Electronic Documents at <http://www.sgs.com/en/Terms-and-Conditions/Terms-e-Documents.aspx>. Attention is drawn to the limitation of liability, indemnification and jurisdiction issues defined therein. Any holder of this document is advised that information contained hereon reflects the Company's findings at the time of its intervention only and within the limits of Client's instructions, if any. The Company's sole responsibility is to its Client and this document does not exonerate parties to a transaction from exercising all their rights and obligations under the transaction documents. This document cannot be reproduced except in full, without prior written approval of the Company. Any unauthorized alteration, forgery or falsification of the content or appearance of this document is unlawful and offenders may be prosecuted to the fullest extent of the law. Unless otherwise stated the results shown in this test report refer only to the sample(s) tested.

Attention: To check the authenticity of testing (inspection report & certificate), please contact us at telephone: (86-755) 8307 1443, or email: CN.Doccheck@sgs.com

附件

Pb/Cd/Hg/Cr⁶⁺ 检测流程图

1) 样品按照下述流程被完全消解（六价铬检测除外）。

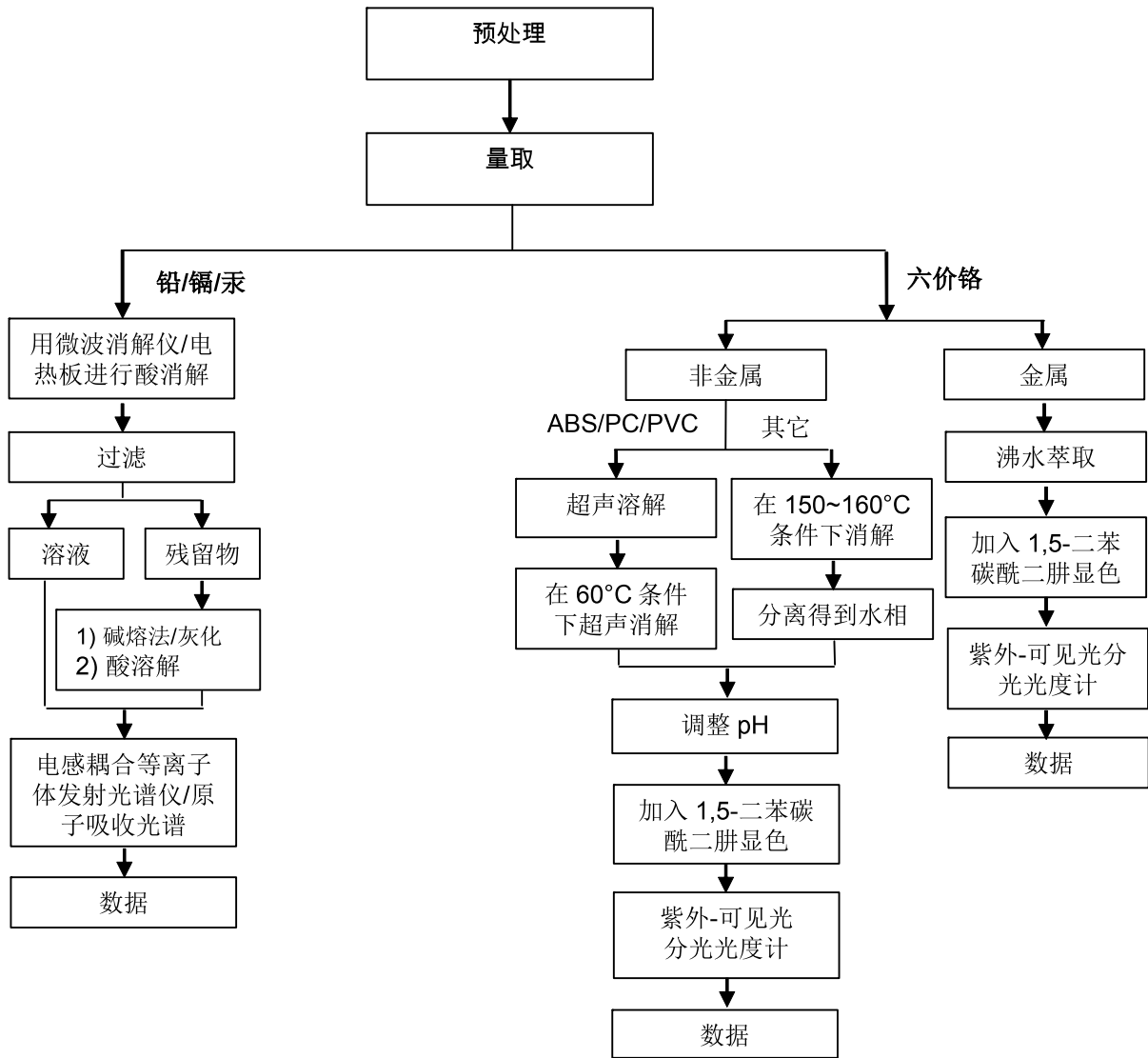

附件

Phthalates 检测流程图

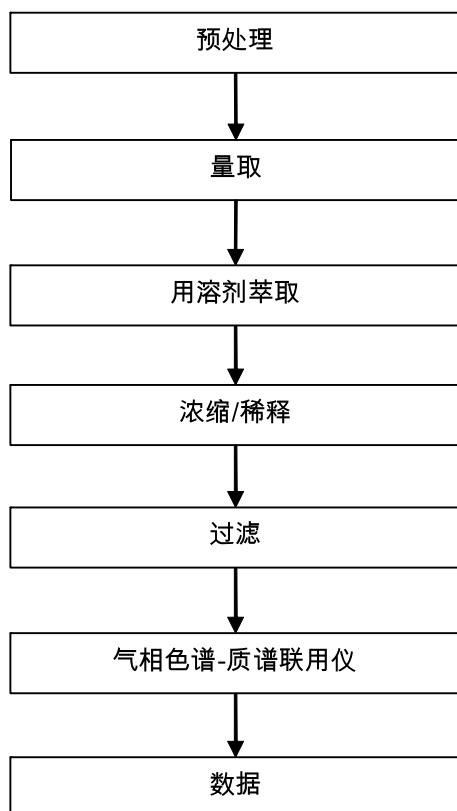

Unless otherwise agreed in writing, this document is issued by the Company subject to its General Conditions of Service printed overleaf, available on request or accessible at <http://www.sgs.com/en/Terms-and-Conditions.aspx> and, for electronic format documents, subject to Terms and Conditions for Electronic Documents at <http://www.sgs.com/en/Terms-and-Conditions/Terms-e-Document.aspx>. Attention is drawn to the limitation of liability, indemnification and jurisdiction issues defined therein. Any holder of this document is advised that information contained hereon reflects the Company's findings at the time of its intervention only and within the limits of Client's instructions, if any. The Company's sole responsibility is to its Client and this document does not exonerate parties to a transaction from exercising all their rights and obligations under the transaction documents. This document cannot be reproduced except in full, without prior written approval of the Company. Any unauthorized alteration, forgery or falsification of the content or appearance of this document is unlawful and offenders may be prosecuted to the fullest extent of the law. Unless otherwise stated the results shown in this test report refer only to the sample(s) tested.

Attention: To check the authenticity of testing /inspection report & certificate, please contact us at telephone: (86-755) 8307 1443, or email: CN.Doccheck@sgs.com

附件

Halogen 检测流程图

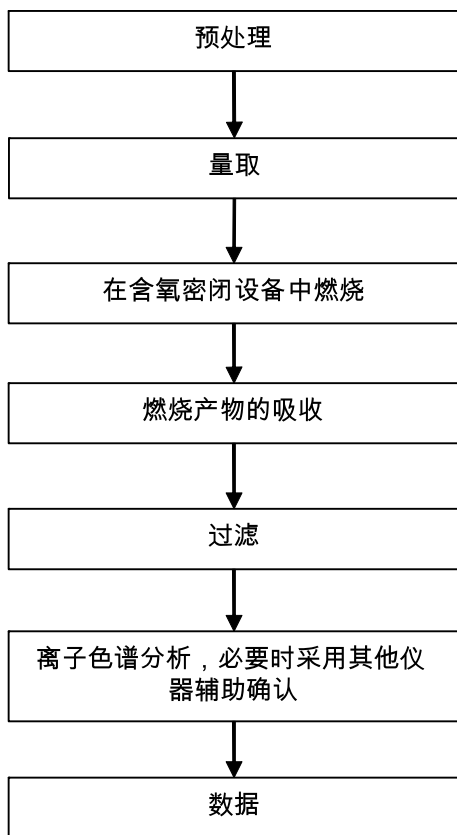

Unless otherwise agreed in writing, this document is issued by the Company subject to its General Conditions of Service printed overleaf, available on request or accessible at <http://www.sgs.com/en/Terms-and-Conditions.aspx> and, for electronic format documents, subject to Terms and Conditions for Electronic Documents at <http://www.sgs.com/en/Terms-and-Conditions/Terms-e-Document.aspx>. Attention is drawn to the limitation of liability, indemnification and jurisdiction issues defined therein. Any holder of this document is advised that information contained hereon reflects the Company's findings at the time of its intervention only and within the limits of Client's instructions, if any. The Company's sole responsibility is to its Client and this document does not exonerate parties to a transaction from exercising all their rights and obligations under the transaction documents. This document cannot be reproduced except in full, without prior written approval of the Company. Any unauthorized alteration, forgery or falsification of the content or appearance of this document is unlawful and offenders may be prosecuted to the fullest extent of the law. Unless otherwise stated the results shown in this test report refer only to the sample(s) tested.

Attention: To check the authenticity of testing /inspection report & certificate, please contact us at telephone: (86-755) 8307 1443, or email: CN.Doccheck@sgs.com

附件

HBCDD 检测流程图

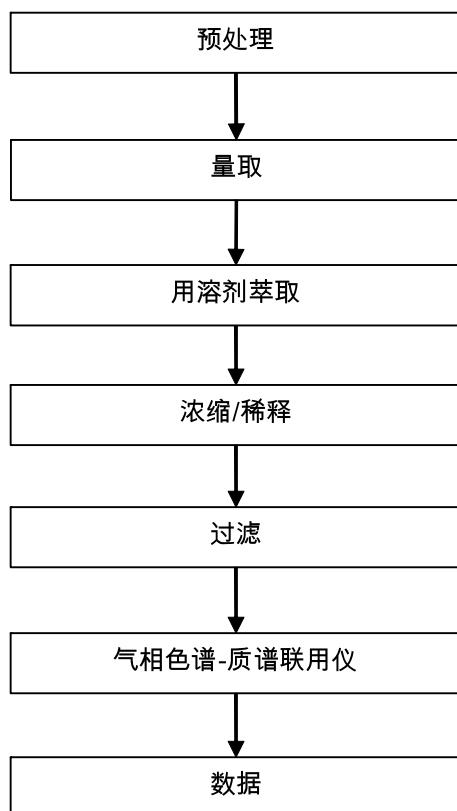

Unless otherwise agreed in writing, this document is issued by the Company subject to its General Conditions of Service printed overleaf, available on request or accessible at <http://www.sgs.com/en/Terms-and-Conditions.aspx> and, for electronic format documents, subject to Terms and Conditions for Electronic Documents at <http://www.sgs.com/en/Terms-and-Conditions/Terms-e-Documents.aspx>. Attention is drawn to the limitation of liability, indemnification and jurisdiction issues defined therein. Any holder of this document is advised that information contained hereon reflects the Company's findings at the time of its intervention only and within the limits of Client's instructions, if any. The Company's sole responsibility is to its Client and this document does not exonerate parties to a transaction from exercising all their rights and obligations under the transaction documents. This document cannot be reproduced except in full, without prior written approval of the Company. Any unauthorized alteration, forgery or falsification of the content or appearance of this document is unlawful and offenders may be prosecuted to the fullest extent of the law. Unless otherwise stated the results shown in this test report refer only to the sample(s) tested.

Attention: To check the authenticity of testing / inspection report & certificate, please contact us at telephone: (86-755) 8307 1443, or email: CN.Doccheck@sgs.com

附件

PAHs 检测流程图

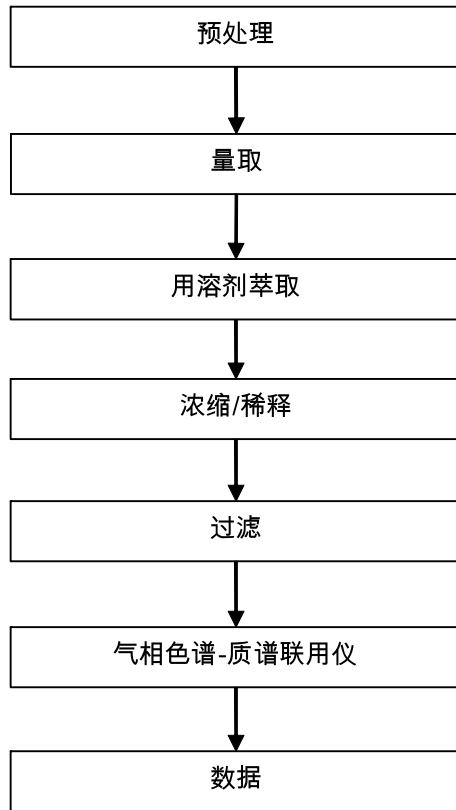

Unless otherwise agreed in writing, this document is issued by the Company subject to its General Conditions of Service printed overleaf, available on request or accessible at <http://www.sgs.com/en/Terms-and-Conditions.aspx> and, for electronic format documents, subject to Terms and Conditions for Electronic Documents at <http://www.sgs.com/en/Terms-and-Conditions/Terms-e-Documents.aspx>. Attention is drawn to the limitation of liability, indemnification and jurisdiction issues defined therein. Any holder of this document is advised that information contained hereon reflects the Company's findings at the time of its intervention only and within the limits of Client's instructions, if any. The Company's sole responsibility is to its Client and this document does not exonerate parties to a transaction from exercising all their rights and obligations under the transaction documents. This document cannot be reproduced except in full, without prior written approval of the Company. Any unauthorized alteration, forgery or falsification of the content or appearance of this document is unlawful and offenders may be prosecuted to the fullest extent of the law. Unless otherwise stated the results shown in this test report refer only to the sample(s) tested.

附件

PFOA / PFOS 检测流程图

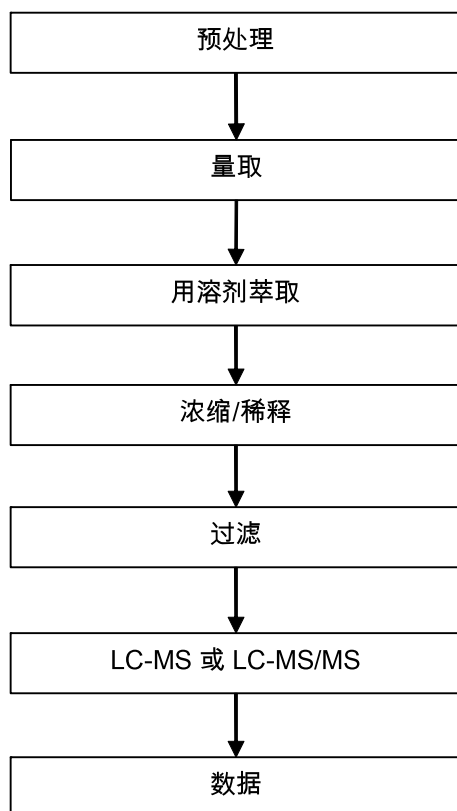

Unless otherwise agreed in writing, this document is issued by the Company subject to its General Conditions of Service printed overleaf, available on request or accessible at <http://www.sgs.com/en/Terms-and-Conditions.aspx> and, for electronic format documents, subject to Terms and Conditions for Electronic Documents at <http://www.sgs.com/en/Terms-and-Conditions/Terms-e-Documents.aspx>. Attention is drawn to the limitation of liability, indemnification and jurisdiction issues defined therein. Any holder of this document is advised that information contained hereon reflects the Company's findings at the time of its intervention only and within the limits of Client's instructions, if any. The Company's sole responsibility is to its Client and this document does not exonerate parties to a transaction from exercising all their rights and obligations under the transaction documents. This document cannot be reproduced except in full, without prior written approval of the Company. Any unauthorized alteration, forgery or falsification of the content or appearance of this document is unlawful and offenders may be prosecuted to the fullest extent of the law. Unless otherwise stated the results shown in this test report refer only to the sample(s) tested.

Attention: To check the authenticity of testing / inspection report & certificate, please contact us at telephone: (86-755) 8307 1443, or email: CN.Doccheck@sgs.com

附件

BPA 检测流程图

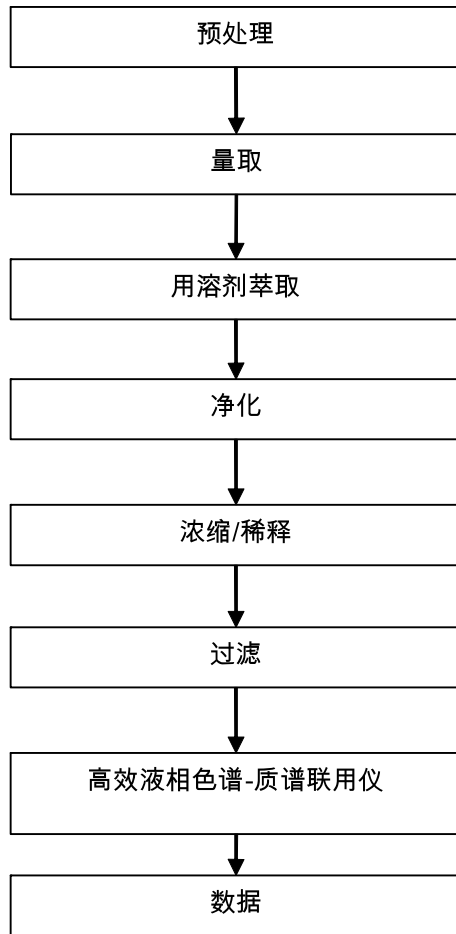

附件

元素检测流程图

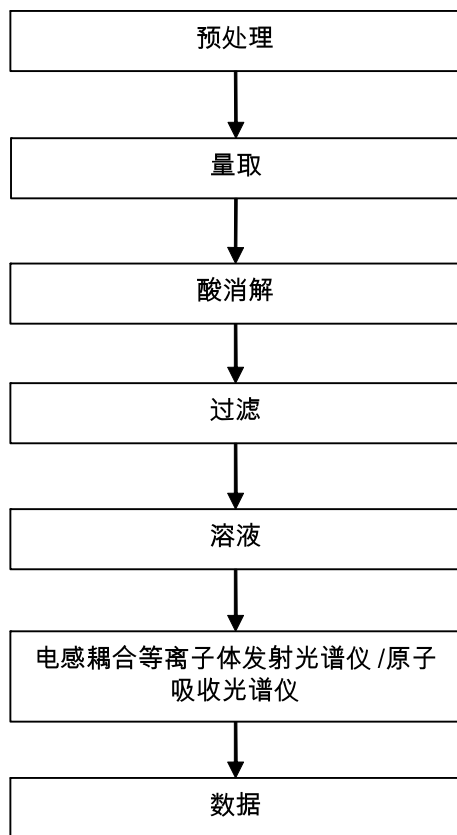

Unless otherwise agreed in writing, this document is issued by the Company subject to its General Conditions of Service printed overleaf, available on request or accessible at <http://www.sgs.com/en/Terms-and-Conditions.aspx> and, for electronic format documents, subject to Terms and Conditions for Electronic Documents at <http://www.sgs.com/en/Terms-and-Conditions/Terms-e-Document.aspx>. Attention is drawn to the limitation of liability, indemnification and jurisdiction issues defined therein. Any holder of this document is advised that information contained hereon reflects the Company's findings at the time of its intervention only and within the limits of Client's instructions, if any. The Company's sole responsibility is to its Client and this document does not exonerate parties to a transaction from exercising all their rights and obligations under the transaction documents. This document cannot be reproduced except in full, without prior written approval of the Company. Any unauthorized alteration, forgery or falsification of the content or appearance of this document is unlawful and offenders may be prosecuted to the fullest extent of the law. Unless otherwise stated the results shown in this test report refer only to the sample(s) tested.

Attention: To check the authenticity of testing / inspection report & certificate, please contact us at telephone: (86-755) 8307 1443, or email: CN.Doccheck@sgs.com

附件

SCCP/MCCP/LCCP 检测流程图

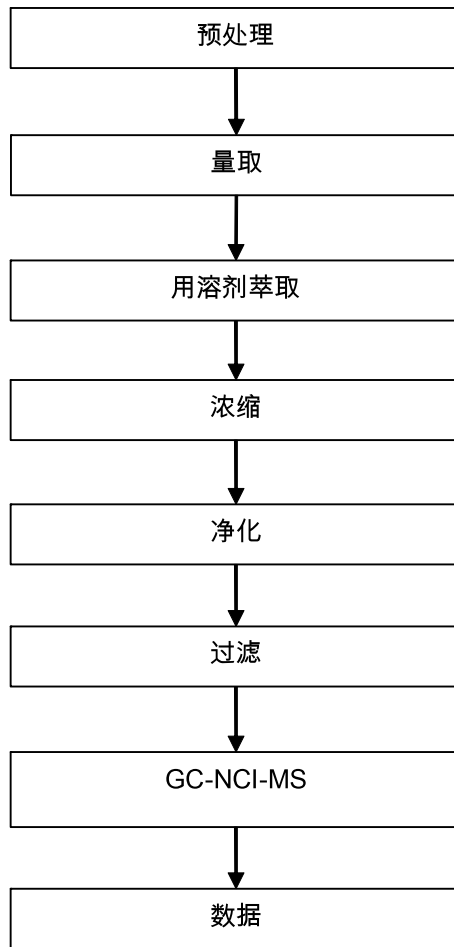

附件

红磷检测流程图

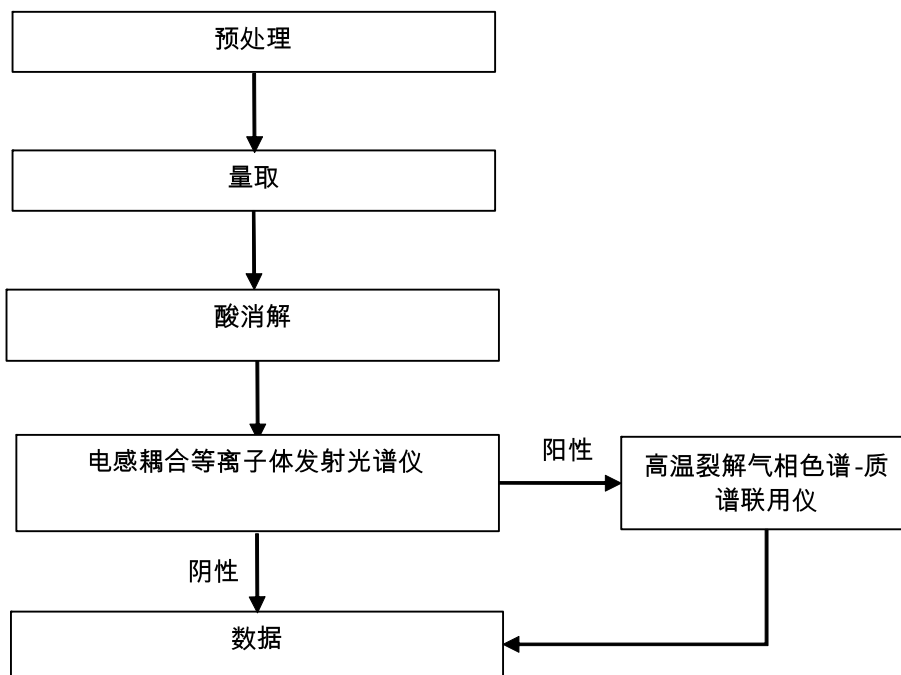

Unless otherwise agreed in writing, this document is issued by the Company subject to its General Conditions of Service printed overleaf, available on request or accessible at <http://www.sgs.com/en/Terms-and-Conditions.aspx> and, for electronic format documents, subject to Terms and Conditions for Electronic Documents at <http://www.sgs.com/en/Terms-and-Conditions/Terms-e-Documents.aspx>. Attention is drawn to the limitation of liability, indemnification and jurisdiction issues defined therein. Any holder of this document is advised that information contained hereon reflects the Company's findings at the time of its intervention only and within the limits of Client's instructions, if any. The Company's sole responsibility is to its Client and this document does not exonerate parties to a transaction from exercising all their rights and obligations under the transaction documents. This document cannot be reproduced except in full, without prior written approval of the Company. Any unauthorized alteration, forgery or falsification of the content or appearance of this document is unlawful and offenders may be prosecuted to the fullest extent of the law. Unless otherwise stated the results shown in this test report refer only to the sample(s) tested.

Attention: To check the authenticity of testing /inspection report & certificate, please contact us at telephone: (86-755) 8307 1443, or email: CN.Doccheck@sgs.com

附件

持久性、生物累积性和毒性 (PBT) 化学物质检测流程图

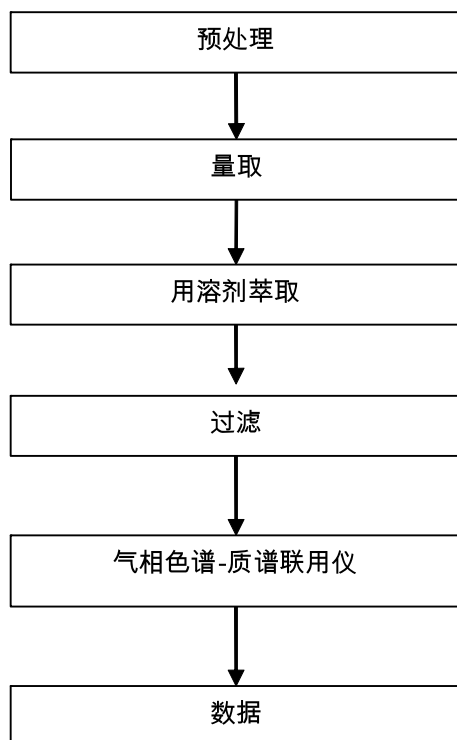

Unless otherwise agreed in writing, this document is issued by the Company subject to its General Conditions of Service printed overleaf, available on request or accessible at <http://www.sgs.com/en/Terms-and-Conditions.aspx> and, for electronic format documents, subject to Terms and Conditions for Electronic Documents at <http://www.sgs.com/en/Terms-and-Conditions/Terms-e-Documents.aspx>. Attention is drawn to the limitation of liability, indemnification and jurisdiction issues defined therein. Any holder of this document is advised that information contained hereon reflects the Company's findings at the time of its intervention only and within the limits of Client's instructions, if any. The Company's sole responsibility is to its Client and this document does not exonerate parties to a transaction from exercising all their rights and obligations under the transaction documents. This document cannot be reproduced except in full, without prior written approval of the Company. Any unauthorized alteration, forgery or falsification of the content or appearance of this document is unlawful and offenders may be prosecuted to the fullest extent of the law. Unless otherwise stated the results shown in this test report refer only to the sample(s) tested.

Attention: To check the authenticity of testing /inspection report & certificate, please contact us at telephone: (86-755) 8307 1443, or email: CN.Doccheck@sgs.com

附件

PVC 检测流程图

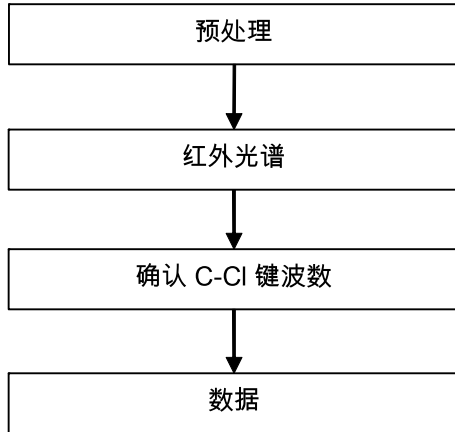

附件

TBBP-A 检测流程图

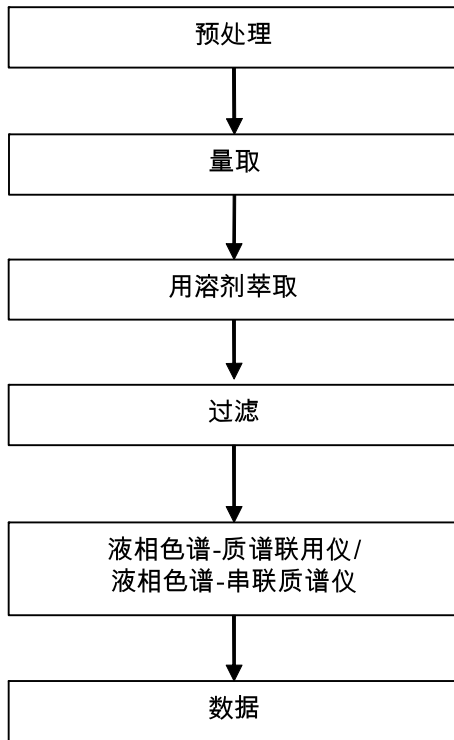

检测报告

编号: CANEC2202185402

日期: 2022年03月08日 第26页,共26页

样品照片:



此照片仅限于随SGS正本报告使用

*** 报告完 ***





检测报告 Test Report

报告编号 A2220186128101ER1
Report No. A2220186128101ER1

第 1 页 共 10 页
Page 1 of 10

报告抬头公司名称 无锡市明星精密线材有限公司
Company Name WUXI CITY MINGXING PRECISION CO.,LTD
shown on Report
地 址 江苏省无锡市鹅湖镇甘露甘厚路工业集中区
Address GANHOU ROAD, INDUSTRIAL FOCUS AREAS, GANLU E'HU TOWN, WUXI CITY, JIANGSU PROVINCE

以下测试之样品及样品信息由申请者提供并确认

The following sample(s) and sample information was/were submitted and identified by/on the behalf of the applicant

样品名称 镀锡铜线
Sample Name TINNDE COPPER WIRE
样品接收日期 2022.05.13
Sample Received Date May 13, 2022
样品检测日期 2022.05.13-2022.05.17
Testing Period May 13, 2022 to May 17, 2022

检测要求 根据客户要求, 对所提交样品中的铅(Pb), 镉(Cd), 汞(Hg), 六价铬(Cr(VI)), 多溴联苯(PBBs), 多溴二苯醚(PBDEs), 邻苯二甲酸酯(DBP, BBP, DEHP, DIBP)进行测试。

Test Requested As specified by client, to test Lead (Pb), Cadmium (Cd), Mercury (Hg), Hexavalent Chromium (Cr(VI)), Polybrominated Biphenyls (PBBs), Polybrominated Diphenyl Ethers (PBDEs), Phthalates (DBP, BBP, DEHP, DIBP) in the submitted sample(s).

检测依据/检测结果 请参见下页。

Test Method/Test Result(s) Please refer to the following page(s).

主 检 廖红月
Tested by

审 核 方理松
Reviewed by

批 准 刘琳慧
Approved by

日 期 2022.05.17
Date

刘琳慧
授权签字人 Lab Authorized Signatory

No. R530011260

华测检测集团股份有限公司
Centre Testing International Group Co.,Ltd.

广东省深圳市宝安区新安街道兴东社区华测检测大楼

CTI Building, Xing Dong Community, Xin'an Sub-district, Bao'an District, Shenzhen City, Guangdong Province, P.R. China

检测报告

Test Report

报告编号 A2220186128101ER1
Report No. A2220186128101ER1

第 2 页 共 10 页
Page 2 of 10

检测依据 Test Method

测试项目 Tested Item(s)	测试方法 Test Method	测试仪器 Measured Equipment(s)
铅 Lead (Pb)	IEC 62321-5:2013	ICP-OES
镉 Cadmium (Cd)	IEC 62321-5:2013	ICP-OES
	参考 IEC 62321-5:2013 Refer to IEC 62321-5:2013	
汞 Mercury (Hg)	IEC 62321-4:2013+AMD1:2017 CSV	ICP-OES
	参考 IEC 62321-4:2013+AMD1:2017 CSV Refer to IEC 62321-4:2013+AMD1:2017 CSV	
六价铬 Hexavalent Chromium (Cr(VI))	IEC 62321-7-1:2015	UV-Vis
多溴联苯 Polybrominated Biphenyls (PBBs)	IEC 62321-6:2015	GC-MS
多溴二苯醚 Polybrominated Diphenyl Ethers (PBDEs)	IEC 62321-6:2015	GC-MS
邻苯二甲酸酯 Phthalates (DBP, BBP, DEHP, DIBP)	IEC 62321-8:2017	GC-MS

检测报告 Test Report

报告编号 A2220186128101ER1
Report No. A2220186128101ER1

第3页 共10页
Page 3 of 10

检测结果 Test Result(s)

测试项目 Tested Item(s)	结果 Result		方法检出限 MDL
	001	002	
铅 Lead (Pb)	N.D.	41 mg/kg	2 mg/kg
镉 Cadmium (Cd)	N.D.	N.D.	2 mg/kg
汞 Mercury (Hg)	N.D.	N.D.	2 mg/kg
六价铬 Hexavalent Chromium (Cr(VI))	N.D. ▼	N.D. ▼	0.10 µg/cm ² (LOQ)

测试项目 Tested Item(s)	结果 Result		方法检出限 MDL
	001		
多溴联苯 Polybrominated Biphenyls (PBBs)			
一溴联苯 Monobromobiphenyl	N.D.		5 mg/kg
二溴联苯 Dibromobiphenyl	N.D.		5 mg/kg
三溴联苯 Tribromobiphenyl	N.D.		5 mg/kg
四溴联苯 Tetrabromobiphenyl	N.D.		5 mg/kg
五溴联苯 Pentabromobiphenyl	N.D.		5 mg/kg
六溴联苯 Hexabromobiphenyl	N.D.		5 mg/kg
七溴联苯 Heptabromobiphenyl	N.D.		5 mg/kg
八溴联苯 Octabromobiphenyl	N.D.		5 mg/kg
九溴联苯 Nonabromobiphenyl	N.D.		5 mg/kg
十溴联苯 Decabromobiphenyl	N.D.		5 mg/kg

测试项目 Tested Item(s)	结果 Result		方法检出限 MDL
	002		
多溴联苯 Polybrominated Biphenyls (PBBs)			
一溴联苯 Monobromobiphenyl	N.D.		5 mg/kg
二溴联苯 Dibromobiphenyl	N.D.		5 mg/kg
三溴联苯 Tribromobiphenyl	N.D.		5 mg/kg
四溴联苯 Tetrabromobiphenyl	N.D.		5 mg/kg
五溴联苯 Pentabromobiphenyl	N.D.		5 mg/kg
六溴联苯 Hexabromobiphenyl	N.D.		5 mg/kg
七溴联苯 Heptabromobiphenyl	N.D.		5 mg/kg
八溴联苯 Octabromobiphenyl	N.D.		5 mg/kg
九溴联苯 Nonabromobiphenyl	N.D.		5 mg/kg
十溴联苯 Decabromobiphenyl	N.D.		5 mg/kg

检测报告

Test Report

报告编号 A2220186128101ER1
Report No. A2220186128101ER1

第 4 页 共 10 页
Page 4 of 10

测试项目 Tested Item(s)	结果 Result	方法检出限 MDL
	001	
多溴二苯醚 Polybrominated Diphenyl Ethers (PBDEs)		
一溴二苯醚 Monobromodiphenyl ether	N.D.	5 mg/kg
二溴二苯醚 Dibromodiphenyl ether	N.D.	5 mg/kg
三溴二苯醚 Tribromodiphenyl ether	N.D.	5 mg/kg
四溴二苯醚 Tetrabromodiphenyl ether	N.D.	5 mg/kg
五溴二苯醚 Pentabromodiphenyl ether	N.D.	5 mg/kg
六溴二苯醚 Hexabromodiphenyl ether	N.D.	5 mg/kg
七溴二苯醚 Heptabromodiphenyl ether	N.D.	5 mg/kg
八溴二苯醚 Octabromodiphenyl ether	N.D.	5 mg/kg
九溴二苯醚 Nonabromodiphenyl ether	N.D.	5 mg/kg
十溴二苯醚 Decabromodiphenyl ether	N.D.	5 mg/kg

测试项目 Tested Item(s)	结果 Result	方法检出限 MDL
	002	
多溴二苯醚 Polybrominated Diphenyl Ethers (PBDEs)		
一溴二苯醚 Monobromodiphenyl ether	N.D.	5 mg/kg
二溴二苯醚 Dibromodiphenyl ether	N.D.	5 mg/kg
三溴二苯醚 Tribromodiphenyl ether	N.D.	5 mg/kg
四溴二苯醚 Tetrabromodiphenyl ether	N.D.	5 mg/kg
五溴二苯醚 Pentabromodiphenyl ether	N.D.	5 mg/kg
六溴二苯醚 Hexabromodiphenyl ether	N.D.	5 mg/kg
七溴二苯醚 Heptabromodiphenyl ether	N.D.	5 mg/kg
八溴二苯醚 Octabromodiphenyl ether	N.D.	5 mg/kg
九溴二苯醚 Nonabromodiphenyl ether	N.D.	5 mg/kg
十溴二苯醚 Decabromodiphenyl ether	N.D.	5 mg/kg

检测报告 Test Report

报告编号 A2220186128101ER1
Report No. A2220186128101ER1

第 5 页 共 10 页
Page 5 of 10

测试项目 Tested Item(s)	结果 Result	方法检出限 MDL
	001	
邻苯二甲酸酯 Phthalates (DBP, BBP, DEHP, DIBP)		
邻苯二甲酸二丁酯 Dibutyl phthalate (DBP) CAS#:84-74-2	N.D.	50 mg/kg
邻苯二甲酸丁基苄基酯 Butyl benzyl phthalate (BBP) CAS#:85-68-7	N.D.	50 mg/kg
邻苯二甲酸二(2-乙基)己酯 Di-(2-ethylhexyl) phthalate (DEHP) CAS#:117-81-7	N.D.	50 mg/kg
邻苯二甲酸二异丁酯 Diisobutyl phthalate (DIBP) CAS#:84-69-5	N.D.	50 mg/kg

测试项目 Tested Item(s)	结果 Result	方法检出限 MDL
	002	
邻苯二甲酸酯 Phthalates (DBP, BBP, DEHP, DIBP)		
邻苯二甲酸二丁酯 Dibutyl phthalate (DBP) CAS#:84-74-2	N.D.	50 mg/kg
邻苯二甲酸丁基苄基酯 Butyl benzyl phthalate (BBP) CAS#:85-68-7	N.D.	50 mg/kg
邻苯二甲酸二(2-乙基)己酯 Di-(2-ethylhexyl) phthalate (DEHP) CAS#:117-81-7	N.D.	50 mg/kg
邻苯二甲酸二异丁酯 Diisobutyl phthalate (DIBP) CAS#:84-69-5	N.D.	50 mg/kg

检测报告 Test Report

报告编号 A2220186128101ER1
Report No. A2220186128101ER1

第 6 页 共 10 页
Page 6 of 10

样品/部位描述 Sample/Part Description

- 001 金属基材 Metal base
- 002 银白色镀层 Silver-white plating

备注: 对于检测铅, 镉, 汞之样品已消解完全。
-N.D. = 未检出 (小于方法检出限或定量限)
-mg/kg = ppm = 百万分之一
-LOQ = 定量限, 六价铬的定量限为 0.10 $\mu\text{g}/\text{cm}^2$
-▼六价铬浓度小于 0.10 $\mu\text{g}/\text{cm}^2$, 样品未检出六价铬。

Remark: The sample(s) had been dissolved totally tested for Lead, Cadmium, Mercury.

-MDL = Method Detection Limit

-N.D. = Not Detected (<MDL or LOQ)

-mg/kg = ppm = parts per million

-LOQ = Limit of Quantification, The LOQ of Hexavalent chromium is 0.10 $\mu\text{g}/\text{cm}^2$

-▼The sample is negative for Cr(VI) – The Cr(VI) concentration is below 0.10 $\mu\text{g}/\text{cm}^2$. The coating is considered a non-Cr(VI) based coating.

注释: -本报告中的数据结果供科研、教学、企业内部质量控制、企业产品研发等目的用。
-本报告于原报告(报告编号 A2220186128101E)基础上修改了样品 002 铅结果的表述方式和修改了“样品检测日期”。本报告替换原报告 A2220186128101E, 自本报告签发之日起, 原报告 A2220186128101E 作废。

Note: -The testing data and result(s) in this report is(are) just for scientific research, education, internal quality control and product development etc.

-This testing report revised the test result expression of Lead(Pb) of sample 002 and revised “Testing Period ” based on the original report of No.A2220186128101E. This testing report displaces the original one which was invalid since the date of this testing report released.

检测报告 Test Report

报告编号 A2220186128101ER1
Report No. A2220186128101ER1

第 7 页 共 10 页
Page 7 of 10

检测流程 Test Process

1. 铅 Lead (Pb), 镉 Cadmium (Cd)

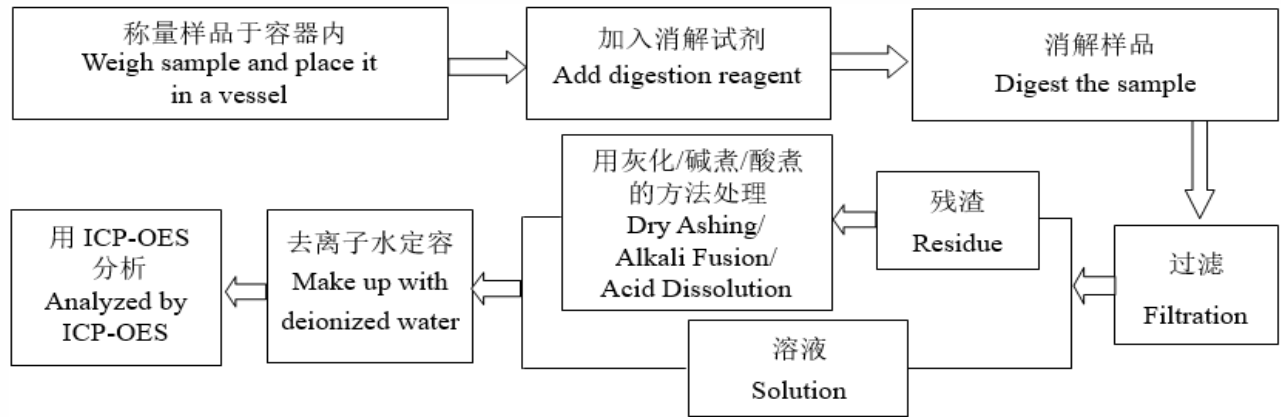

2. 镉 Cadmium (Cd)

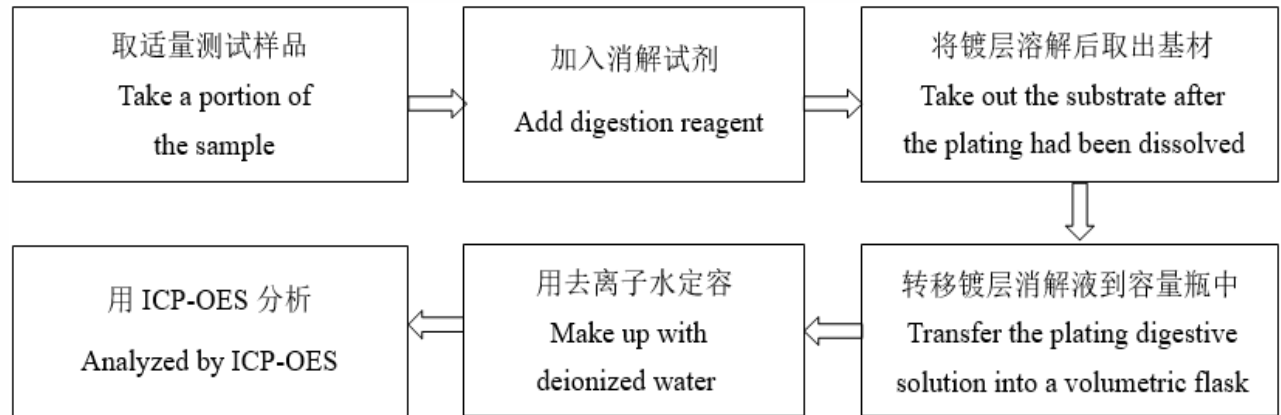

3. 汞 Mercury (Hg)

(1) IEC 62321-4:2013+AMD1:2017 CSV

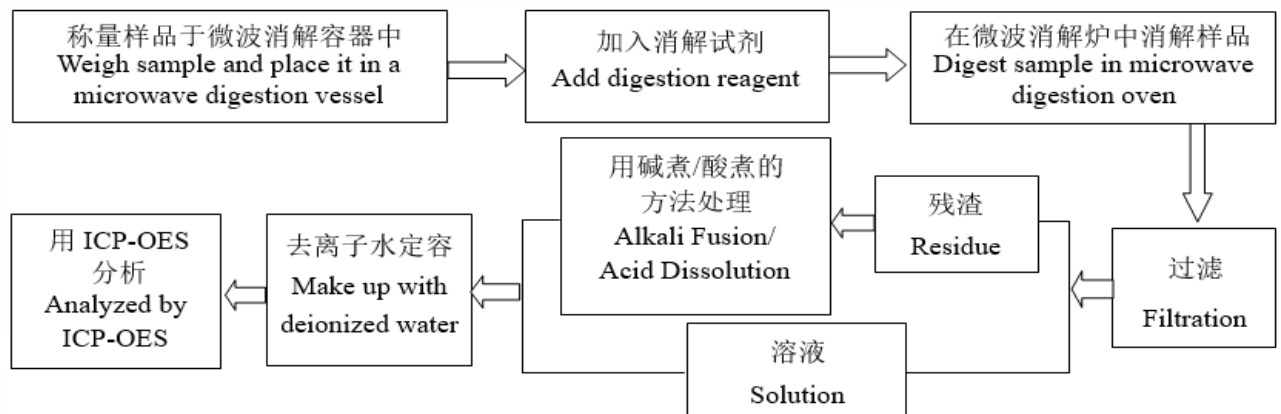

检测报告 Test Report

报告编号 A2220186128101ER1
Report No. A2220186128101ER1

第 8 页 共 10 页
Page 8 of 10

(2) 参考 IEC 62321-4:2013+AMD1:2017 CSV Refer to IEC 62321-4:2013+AMD1:2017 CSV

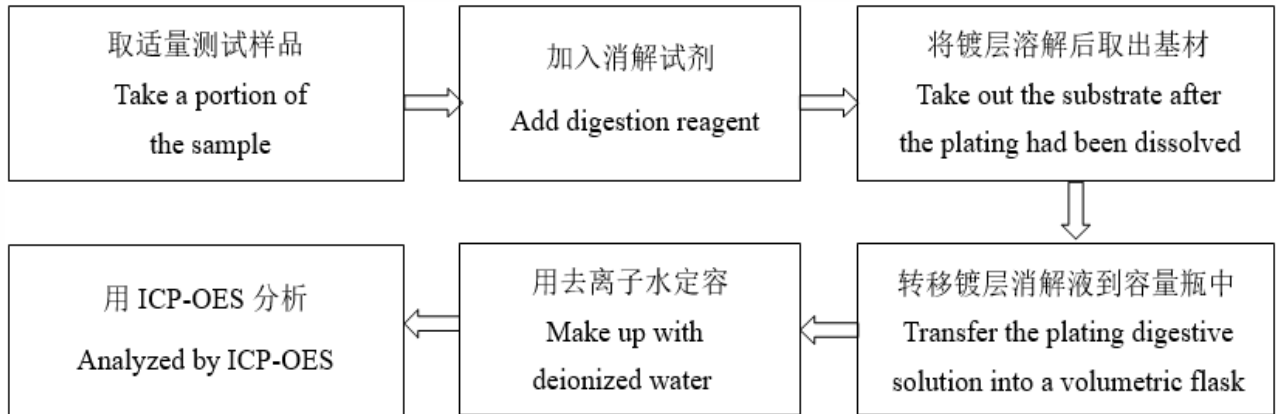

4. 六价铬 Hexavalent Chromium (Cr(VI))

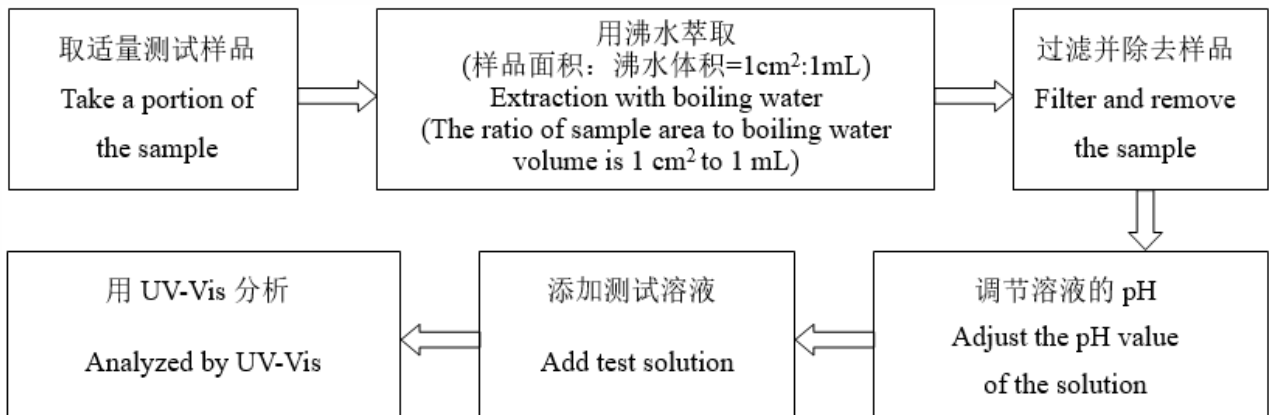

5. 多溴联苯 Polybrominated Biphenyls (PBBs), 多溴二苯醚 Polybrominated Diphenyl Ethers (PBDEs)

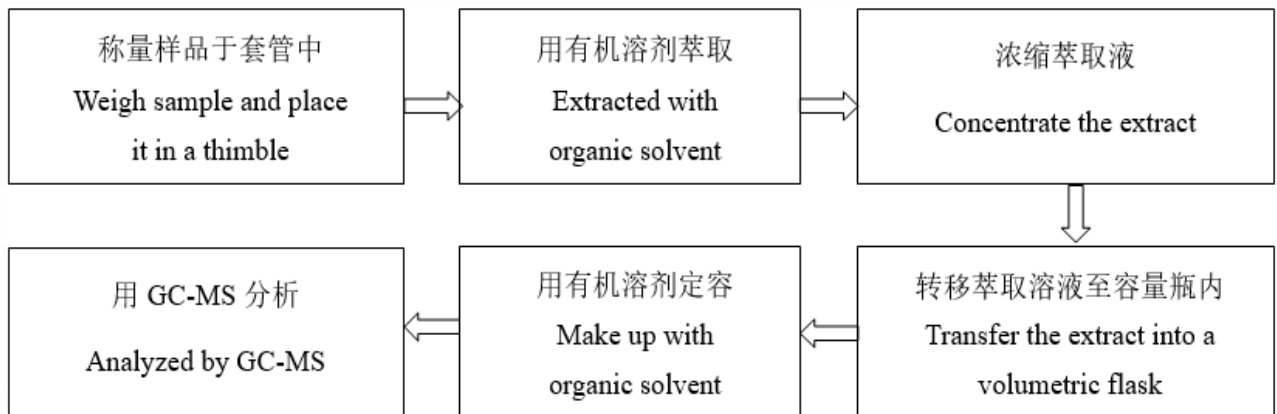

检测报告 Test Report

报告编号 A2220186128101ER1
Report No. A2220186128101ER1

第 9 页 共 10 页
Page 9 of 10

6. 邻苯二甲酸酯 Phthalates (DBP, BBP, DEHP, DIBP)

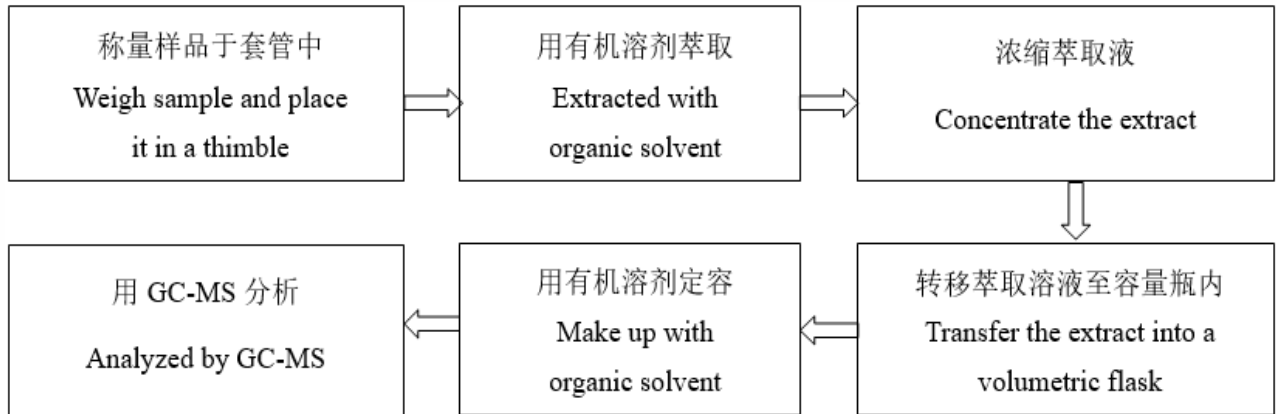

检测报告 Test Report

报告编号 A2220186128101ER1
Report No. A2220186128101ER1

第 10 页 共 10 页
Page 10 of 10

样品图片

Photo(s) of the sample(s)

001-002

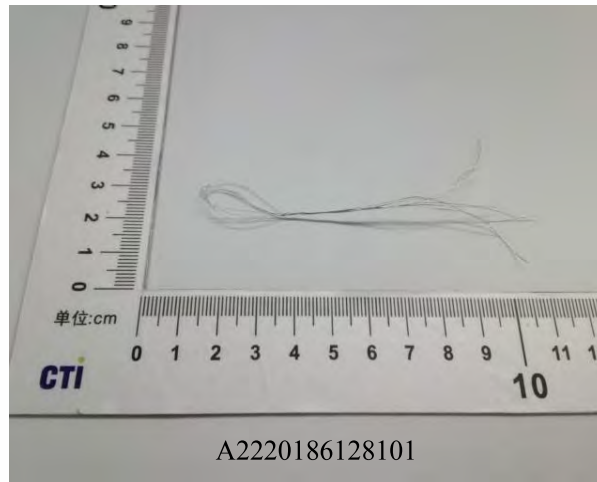

声明 Statement:

1. 检测报告无批准人签字、“专用章”及报告骑缝章无效;

This report is considered invalid without approved signature, special seal and the seal on the perforation;

2. 报告抬头公司名称及地址、样品及样品信息由申请者提供, 申请者应对其真实性负责, CTI 未核实其真实性;

The Company Name shown on Report and Address, the sample(s) and sample information was/were provided by the applicant who should be responsible for the authenticity which CTI hasn't verified;

3. 本报告检测结果仅对受测样品负责;

The result(s) shown in this report refer(s) only to the sample(s) tested;

4. 未经 CTI 书面同意, 不得部分复制本报告;

Without written approval of CTI, this report can't be reproduced except in full;

5. 如检测报告中的英文内容与中文内容有差异, 以中文为准。

In case of any discrepancy between the English version and Chinese version of the testing reports (if generated), the Chinese version shall prevail.

*** 报告结束 ***

*** End of Report ***

Test Report

No. SHAEC2127178503

Date: 21 Dec 2021

Page 1 of 19

DAIKIN FLUORO CHEMICALS(CHINA) CO., LTD.

NO.8 JINYU ROAD(WEST) ADVANCED MATERIALS INDUSTRIAL PARK,CHANGSHU,JIANGSU
215522, CHINA

The following sample(s) was/were submitted and identified on behalf of the clients as : NEOFロン FEP

SGS Job No. : SP21-038470 - SH

Model No. : NP-3180

Date of Sample Received : 13 Dec 2021

Testing Period : 13 Dec 2021 - 21 Dec 2021

Test Requested : Selected test(s) as requested by client.

Test Method : Please refer to next page(s).

Test Results : Please refer to next page(s).

Conclusion : Based on the performed tests on submitted sample(s), the results of Cadmium, Lead, Mercury, Hexavalent chromium, Polybrominated biphenyls (PBBs), Polybrominated diphenyl ethers (PBDEs) and Phthalates such as Bis(2-ethylhexyl) phthalate (DEHP), Butyl benzyl phthalate (BBP), Dibutyl phthalate (DBP) and Diisobutyl phthalate (DIBP) comply with the limits as set by RoHS Directive (EU) 2015/863 amending Annex II to Directive 2011/65/EU.

Signed for and on behalf of
SGS-CSTC Standards Technical Services (Shanghai) Co., Ltd.

Carol Luo

Carol Luo
Approved Signatory

scan to see the report



F93E4497



Unless otherwise agreed in writing, this document is issued by the Company subject to its General Conditions of Service printed overleaf, available on request or accessible at <http://www.sgs.com/en/Terms-and-Conditions.aspx> and, for electronic format documents, subject to Terms and Conditions for Electronic Documents at <http://www.sgs.com/en/Terms-and-Conditions/Terms-e-Documents.aspx>. Attention is drawn to the limitation of liability, indemnification and jurisdiction issues defined therein. Any holder of this document is advised that information contained hereon reflects the Company's findings at the time of its intervention only and within the limits of Client's instructions, if any. The Company's sole responsibility is to its Client and this document does not exonerate parties to a transaction from exercising all their rights and obligations under the transaction documents. This document cannot be reproduced except in full, without prior written approval of the Company. Any unauthorized alteration, forgery or falsification of the content or appearance of this document is unlawful and offenders may be prosecuted to the fullest extent of the law. Unless otherwise stated the results shown in this test report refer only to the sample(s) tested.

Attention: To check the authenticity of testing /inspection report & certificate, please contact us at telephone: (86-755) 8307 1443, or email: CN.Doccheck@sgs.com

3rd Building, No. 889 Yishan Road Xuhui District, Shanghai China 200233 | E&E (86-21) 61402553 | E&E (86-21) 64953679 | www.sgs.com.cn
中国·上海·徐汇区宜山路889号3号楼 邮编: 200233 | TEL (86-21) 61402594 | TEL (86-21) 61156899 | e sgs.china@sgs.com

Test Report

No. SHAEC2127178503

Date: 21 Dec 2021

Page 2 of 19

Test Results :

Test Part Description :

Specimen No.	SGS Sample ID	Description
SN1	SHA21-271785.002	Translucent solid pellet

Remarks :

- (1) 1 mg/kg = 0.0001%
- (2) MDL = Method Detection Limit
- (3) ND = Not Detected (< MDL)
- (4) "-" = Not Regulated

RoHS Directive (EU) 2015/863 amending Annex II to Directive 2011/65/EU

Test Method : With reference to IEC 62321-4:2013+AMD1:2017, IEC62321-5:2013, IEC62321-7-2:2017, IEC 62321-6:2015 and IEC62321-8:2017, analyzed by Hg analyzer, ICP-OES, UV-Vis and GC-MS.

<u>Test Item(s)</u>	<u>Limit</u>	<u>Unit</u>	<u>MDL</u>	<u>002</u>
Cadmium (Cd)	100	mg/kg	2	ND
Lead (Pb)	1000	mg/kg	2	ND
Mercury (Hg)	1000	mg/kg	2	ND
Hexavalent Chromium (Cr(VI))	1000	mg/kg	8	ND
Sum of PBBs	1000	mg/kg	-	ND
Monobromobiphenyl	-	mg/kg	5	ND
Dibromobiphenyl	-	mg/kg	5	ND
Tribromobiphenyl	-	mg/kg	5	ND
Tetrabromobiphenyl	-	mg/kg	5	ND
Pentabromobiphenyl	-	mg/kg	5	ND
Hexabromobiphenyl	-	mg/kg	5	ND
Heptabromobiphenyl	-	mg/kg	5	ND
Octabromobiphenyl	-	mg/kg	5	ND
Nonabromobiphenyl	-	mg/kg	5	ND
Decabromobiphenyl	-	mg/kg	5	ND
Sum of PBDEs	1000	mg/kg	-	ND
Monobromodiphenyl ether	-	mg/kg	5	ND
Dibromodiphenyl ether	-	mg/kg	5	ND
Tribromodiphenyl ether	-	mg/kg	5	ND
Tetrabromodiphenyl ether	-	mg/kg	5	ND



Unless otherwise agreed in writing, this document is issued by the Company subject to its General Conditions of Service printed overleaf, available on request or accessible at <http://www.sgs.com/en/Terms-and-Conditions.aspx> and, for electronic format documents, subject to Terms and Conditions for Electronic Documents at <http://www.sgs.com/en/Terms-and-Conditions/Terms-e-Documents.aspx>. Attention is drawn to the limitation of liability, indemnification and jurisdiction issues defined therein. Any holder of this document is advised that information contained hereon reflects the Company's findings at the time of its intervention only and within the limits of Client's instructions, if any. The Company's sole responsibility is to its Client and this document does not exonerate parties to a transaction from exercising all their rights and obligations under the transaction documents. This document cannot be reproduced except in full, without prior written approval of the Company. Any unauthorized alteration, forgery or falsification of the content or appearance of this document is unlawful and offenders may be prosecuted to the fullest extent of the law. Unless otherwise stated the results shown in this test report refer only to the sample(s) tested.

Attention: To check the authenticity of testing /inspection report & certificate, please contact us at telephone: (86-755) 8307 1443, or email: CN.Doccheck@sgs.com

SGS-CSI (Shanghai) Inspection & Testing Services Co., Ltd. 3rd Building, No. 889 Yishan Road Xuhui District, Shanghai China 200233 1E&E (86-21) 61402553 1E&E (86-21) 64953879 www.sgs.com.cn
 中国·上海·徐汇区宜山路889号3号楼 邮编: 200233 1HL (86-21) 61402594 1HL (86-21) 61156899 e sgs.china@sgs.com

Test Report

No. SHAEC2127178503

Date: 21 Dec 2021

Page 3 of 19

<u>Test Item(s)</u>	<u>Limit</u>	<u>Unit</u>	<u>MDL</u>	<u>002</u>
Pentabromodiphenyl ether	-	mg/kg	5	ND
Hexabromodiphenyl ether	-	mg/kg	5	ND
Heptabromodiphenyl ether	-	mg/kg	5	ND
Octabromodiphenyl ether	-	mg/kg	5	ND
Nonabromodiphenyl ether	-	mg/kg	5	ND
Decabromodiphenyl ether	-	mg/kg	5	ND
Di-butyl Phthalate (DBP)	1000	mg/kg	50	ND
Benzyl Butyl Phthalate (BBP)	1000	mg/kg	50	ND
Di-2-Ethyl Hexyl Phthalate (DEHP)	1000	mg/kg	50	ND
Diisobutyl Phthalates (DIBP)	1000	mg/kg	50	ND

Notes :

- (1) The maximum permissible limit is quoted from RoHS Directive (EU) 2015/863. IEC 62321 series is equivalent to EN 62321 series
https://www.cenelec.eu/dyn/www/f?p=104:30:1742232870351101:::FSP_ORG_ID,FSP_LANG_ID:1258637,25
- (2) The restriction of DEHP, BBP, DBP and DIBP shall apply to medical devices, including in vitro medical devices, and monitoring and control instruments, including industrial monitoring and control instruments, from 22 July 2021.

Halogen

Test Method : With reference to EN 14582: 2016 , analysis was performed by IC.

<u>Test Item(s)</u>	<u>Unit</u>	<u>MDL</u>	<u>002</u>
Fluorine (F)	mg/kg	50	>100000
Chlorine (Cl)	mg/kg	50	ND
Bromine (Br)	mg/kg	50	ND
Iodine (I)	mg/kg	50	ND

Element(s)

Test Method : With reference to US EPA 3052:1996, analysis was performed by ICP-OES.

<u>Test Item(s)</u>	<u>Unit</u>	<u>MDL</u>	<u>002</u>
Phosphorus (P)	mg/kg	20	ND
Beryllium (Be)	mg/kg	5	ND
Cobalt (Co)	mg/kg	5	ND



Unless otherwise agreed in writing, this document is issued by the Company subject to its General Conditions of Service printed overleaf, available on request or accessible at <http://www.sgs.com/en/Terms-and-Conditions.aspx> and, for electronic format documents, subject to Terms and Conditions for Electronic Documents at <http://www.sgs.com/en/Terms-and-Conditions/Terms-e-Documents.aspx>. Attention is drawn to the limitation of liability, indemnification and jurisdiction issues defined therein. Any holder of this document is advised that information contained hereon reflects the Company's findings at the time of its intervention only and within the limits of Client's instructions, if any. The Company's sole responsibility is to its Client and this document does not exonerate parties to a transaction from exercising all their rights and obligations under the transaction documents. This document cannot be reproduced except in full, without prior written approval of the Company. Any unauthorized alteration, forgery or falsification of the content or appearance of this document is unlawful and offenders may be prosecuted to the fullest extent of the law. Unless otherwise stated the results shown in this test report refer only to the sample(s) tested.

Attention: To check the authenticity of testing /inspection report & certificate, please contact us at telephone: (86-755) 8307 1443, or email: CN.Doccheck@sgs.com

3rd Building, No. 889 Yishan Road Xuhui District, Shanghai China 200233 | E&E (86-21) 61402553 | E&E (86-21) 64953879 | www.sgs.com.cn
 中国·上海·徐汇区宜山路889号3号楼 邮编: 200233 | IHL (86-21) 61402594 | IHL (86-21) 61156899 | e sgs.china@sgs.com

Element(s)

Test Method : With reference to ASTM D 4004-06(2017),analysis was performed by ICP-OES.

<u>Test Item(s)</u>	<u>Unit</u>	<u>MDL</u>	<u>002</u>
Antimony (Sb)	mg/kg	50	ND

Alkanes C10-C13, chloro (short-chain chlorinated paraffins) (SCCP)

Test Method : With reference to ISO 18219: 2015, analysis was performed by GC-NCI-MS

<u>Test Item(s)</u>	<u>Unit</u>	<u>MDL</u>	<u>002</u>
Alkanes C10-C13, chloro (short-chain chlorinated paraffins) (SCCP)	mg/kg	50	ND

Hexabromocyclododecane (HBCDD/HBCD)

Test Method : With reference to US EPA 3550C: 2007, analysis was performed by GC-MS.

<u>Test Item(s)</u>	<u>CAS NO.</u>	<u>Unit</u>	<u>MDL</u>	<u>002</u>
Hexabromocyclododecane (HBCDD/HBCD)	25637-99-4/	mg/kg	10	ND
	3194-55-6			

Tetrabromobisphenol A (TBBP-A)

Test Method : With reference to US EPA 3540C: 1996, analysis was performed byGC-MS/LC-MS.

<u>Test Item(s)</u>	<u>Unit</u>	<u>MDL</u>	<u>002</u>
Tetrabromobisphenol A (TBBP-A)	mg/kg	10	ND



Unless otherwise agreed in writing, this document is issued by the Company subject to its General Conditions of Service printed overleaf, available on request or accessible at <http://www.sgs.com/en/Terms-and-Conditions.aspx> and, for electronic format documents, subject to Terms and Conditions for Electronic Documents at <http://www.sgs.com/en/Terms-and-Conditions/Terms-e-Documents.aspx>. Attention is drawn to the limitation of liability, indemnification and jurisdiction issues defined therein. Any holder of this document is advised that information contained hereon reflects the Company's findings at the time of its intervention only and within the limits of Client's instructions, if any. The Company's sole responsibility is to its Client and this document does not exonerate parties to a transaction from exercising all their rights and obligations under the transaction documents. This document cannot be reproduced except in full, without prior written approval of the Company. Any unauthorized alteration, forgery or falsification of the content or appearance of this document is unlawful and offenders may be prosecuted to the fullest extent of the law. Unless otherwise stated the results shown in this test report refer only to the sample(s) tested.

Attention: To check the authenticity of testing /inspection report & certificate, please contact us at telephone: (86-755) 8307 1443, or email: CN.Doccheck@sgs.com

SGS-CSI (Shanghai) Inspection & Testing Services Co., Ltd. 3rd Building, No. 889 Yishan Road Xuhui District, Shanghai China 200233 TEL: (86-21) 61402553 FAX: (86-21) 64953879 www.sgs.com.cn
 中国·上海·徐汇区宜山路889号3号楼 邮编: 200233 TEL: (86-21) 61402594 FAX: (86-21) 61156899 e sgs.china@sgs.com

Phthalates Content

Test Method : With reference to EN 14372:2004, analysis was performed by GC-MS.

<u>Test Item(s)</u>	<u>CAS NO.</u>	<u>Unit</u>	<u>MDL</u>	<u>002</u>
Diisononyl Phthalate (DINP)	28553-12-0 /68515-48-0	%	0.01	ND
Diisodecyl Phthalate (DIDP)	26761-40-0 /68515-49-1	%	0.01	ND
Di-n-octyl Phthalate (DNOP)	117-84-0	%	0.003	ND
Diisooctyl Phthalate (DiOP)	27554-26-3	%	0.01	ND
Dimethyl Phthalate (DMP)	131-11-3	%	0.003	ND
Di-n-pentyl Phthalates (DnPP)	131-18-0	%	0.003	ND
Diethyl Phthalate (DEP)	84-66-2	%	0.003	ND
Dicyclohexyl Phthalate (DCHP)	84-61-7	%	0.003	ND
Dipropyl Phthalate (DPrP)	131-16-8	%	0.003	ND
Dinonyl Phthalate (DNP)	84-76-4	%	0.003	ND
Dibenzyl Phthalate (DBzP)	523-31-9	%	0.003	ND
Diphenyl Phthalate (DPhP)	84-62-8	%	0.003	ND
Di-n-hexyl Phthalate (DnHP)	84-75-3	%	0.003	ND
Bis(2-methoxyethyl) Phthalate (DMEP)	117-82-8	%	0.003	ND
Diisooheptyl phthalate (DIHP)	71888-89-6	%	0.01	ND
1,2-Benzenedicarboxylic acid, di-C7-11-branched and linear alkyl esters (DHNUP)	68515-42-4	%	0.01	ND
Di(2-ethylhexyl)adipate(DEHA)	103-23-1	%	0.003	ND
Diisopentylphthalate (DIPP)	605-50-5	%	0.003	ND

Polycyclic aromatic hydrocarbons (PAHs)

Test Method : With reference to AfPS GS 2019:01 PAK, analysis was performed by GC-MS.

<u>Test Item(s)</u>	<u>Unit</u>	<u>MDL</u>	<u>002</u>
Benzo(a)pyrene(BaP)	mg/kg	0.1	ND
Benzo(e)pyrene(BeP)	mg/kg	0.1	ND
Benzo(a)anthracene(BaA)	mg/kg	0.1	ND
Benzo(b)fluoranthene(BbF)	mg/kg	0.1	ND
Benzo(j)fluoranthene(BjF)	mg/kg	0.1	ND
Benzo(k)fluoranthene(BkF)	mg/kg	0.1	ND
Chrysene(CHR)	mg/kg	0.1	ND



Unless otherwise agreed in writing, this document is issued by the Company subject to its General Conditions of Service printed overleaf, available on request or accessible at <http://www.sgs.com/en/Terms-and-Conditions.aspx> and, for electronic format documents, subject to Terms and Conditions for Electronic Documents at <http://www.sgs.com/en/Terms-and-Conditions/Terms-e-Documents.aspx>. Attention is drawn to the limitation of liability, indemnification and jurisdiction issues defined therein. Any holder of this document is advised that information contained hereon reflects the Company's findings at the time of its intervention only and within the limits of Client's instructions, if any. The Company's sole responsibility is to its Client and this document does not exonerate parties to a transaction from exercising all their rights and obligations under the transaction documents. This document cannot be reproduced except in full, without prior written approval of the Company. Any unauthorized alteration, forgery or falsification of the content or appearance of this document is unlawful and offenders may be prosecuted to the fullest extent of the law. Unless otherwise stated the results shown in this test report refer only to the sample(s) tested.

Attention: To check the authenticity of testing /inspection report & certificate, please contact us at telephone: (86-755) 8307 1443, or email: CN.Doccheck@sgs.com

3rd Building, No. 889 Yishan Road Xuhui District, Shanghai China 200233 1E&E (86-21) 61402553 1E&E (86-21) 64953679 www.sgs.com.cn
 中国·上海·徐汇区宜山路889号3号楼 邮编: 200233 1HL (86-21) 61402594 1HL (86-21) 61156899 e sgs.china@sgs.com

Test Item(s)	Unit	MDL	002
Dibenzo(a,h)anthracene(DBA)	mg/kg	0.1	ND
Benzo(g,h,i)perylene(BPE)	mg/kg	0.1	ND
Indeno(1,2,3-c,d)pyrene(IPY)	mg/kg	0.1	ND
Phenanthrene(PHE)	mg/kg	0.1	ND
Pyrene(PYR)	mg/kg	0.1	ND
Anthracene(ANT)	mg/kg	0.1	ND
Fluoranthene(FLT)	mg/kg	0.1	ND
Sum of Phenanthrene(PHE), Pyrene(PYR), Anthracene(ANT), Fluoranthene(FLT)	mg/kg	-	ND
Naphthalene(NAP)	mg/kg	0.1	ND
Sum of 15 PAHs	mg/kg	-	ND

AfPS (German commission for Product Safety) : PAHs requirements

Parameter Unit : mg/kg	Category 1	Category 2		Category 3	
	Materials intended to be placed in the mouth, or materials coming into long-term contact with skin (more than 30s) during the intended use -in toys according to Directive 2009/48/EC or -for the use by children ^{a,b} up to 3 years of age.	Materials not covered by category 1, coming into long-term contact (more than 30s) or short-term repetitive contact ^c with skin during the intended or foreseeable use ^d .		Materials covered neither by category 1 nor by category 2, coming into short-term contact (up to 30s) with skin during the intended or foreseeable use.	
		a. use by children	b. other consumer products	a. use by children	b. other consumer products
Benzo(a)pyrene (BaP)	< 0.2	< 0.2	< 0.5	< 0.5	< 1
Benzo(e)pyrene (BeP)	< 0.2	< 0.2	< 0.5	< 0.5	< 1
Benzo(a)anthracene (BaA)	< 0.2	< 0.2	< 0.5	< 0.5	< 1
Benzo(b)fluoranthene (BbF)	< 0.2	< 0.2	< 0.5	< 0.5	< 1
Benzo(j)fluoranthene (BjF)	< 0.2	< 0.2	< 0.5	< 0.5	< 1
Benzo(k)fluoranthene (BkF)	< 0.2	< 0.2	< 0.5	< 0.5	< 1
Chrysene (CHR)	< 0.2	< 0.2	< 0.5	< 0.5	< 1
Dibenzo(a,h)anthracene (DBA)	< 0.2	< 0.2	< 0.5	< 0.5	< 1
Benzo(g,h,i)perylene (BPE)	< 0.2	< 0.2	< 0.5	< 0.5	< 1
Indeno(1,2,3-cd)pyrene (IPY)	< 0.2	< 0.2	< 0.5	< 0.5	< 1
Phenanthrene (PHE), pyrene (PYR), anthracene (ANT), fluoranthene (FLT)	< 1 Sum	< 5 Sum	< 10 Sum	< 20 Sum	< 50 Sum
Naphthalene (NAP)	< 1	< 2		< 10	
Sum of 15 PAHs	<1	< 5	< 10	< 20	< 50

Note:

^a A "Child" is legally defined as a person before reaching the age of 14 years.

^b Use by children includes both active and passive contact by children.

^c Definition "short-term repetitive contact" taken from REACH Annex XVII entry 50 amendment (Regulation (EC) No. 1272/2013)

^d According to the definition of the German Product Safety Act (ProdSG) (chapter 1 Article 2 No. 28) "foreseeable use" shall mean the use of a product in a manner that the person placing it on the market, has not intended, but which could be reasonably foreseeable.

Remark: The German committee on Product Safety (AfPS) published a new PAHs document (AfPS GS 2019:01 PAK) on April 10, 2020, which will be binding for the issue of GS mark certificate from July 1, 2020.



Unless otherwise agreed in writing, this document is issued by the Company subject to its General Conditions of Service printed overleaf, available on request or accessible at <http://www.sgs.com/en/Terms-and-Conditions.aspx> and, for electronic format documents, subject to Terms and Conditions for Electronic Documents at <http://www.sgs.com/en/Terms-and-Conditions/Terms-e-Documents.aspx>. Attention is drawn to the limitation of liability, indemnification and jurisdiction issues defined therein. Any holder of this document is advised that information contained hereon reflects the Company's findings at the time of its intervention only and within the limits of Client's instructions, if any. The Company's sole responsibility is to its Client and this document does not exonerate parties to a transaction from exercising all their rights and obligations under the transaction documents. This document cannot be reproduced except in full, without prior written approval of the Company. Any unauthorized alteration, forgery or falsification of the content or appearance of this document is unlawful and offenders may be prosecuted to the fullest extent of the law. Unless otherwise stated the results shown in this test report refer only to the sample(s) tested.

Attention: To check the authenticity of testing /inspection report & certificate, please contact us at telephone: (86-755) 8307 1443, or email: CN.Doccheck@sgs.com

3rd Building, No. 889 Yishan Road Xuhui District, Shanghai China 200233 1E&E (86-21) 61402553 1E&E (86-21) 64953879 www.sgs.com.cn
 中国·上海·徐汇区宜山路889号3号楼 邮编: 200233 1HL (86-21) 61402594 1HL (86-21) 61156899 e sgs.china@sgs.com

Bisphenol-A

Test Method : Extraction by organic solvent, analysis by HPLC-DAD-MS.

<u>Test Item(s)</u>	<u>Unit</u>	<u>MDL</u>	<u>002</u>
Bisphenol-A	mg/kg	1	ND



Unless otherwise agreed in writing, this document is issued by the Company subject to its General Conditions of Service printed overleaf, available on request or accessible at <http://www.sgs.com/en/Terms-and-Conditions.aspx> and, for electronic format documents, subject to Terms and Conditions for Electronic Documents at <http://www.sgs.com/en/Terms-and-Conditions/Terms-e-Document.aspx>. Attention is drawn to the limitation of liability, indemnification and jurisdiction issues defined therein. Any holder of this document is advised that information contained hereon reflects the Company's findings at the time of its intervention only and within the limits of Client's instructions, if any. The Company's sole responsibility is to its Client and this document does not exonerate parties to a transaction from exercising all their rights and obligations under the transaction documents. This document cannot be reproduced except in full, without prior written approval of the Company. Any unauthorized alteration, forgery or falsification of the content or appearance of this document is unlawful and offenders may be prosecuted to the fullest extent of the law. Unless otherwise stated the results shown in this test report refer only to the sample(s) tested.

Attention: To check the authenticity of testing /inspection report & certificate, please contact us at telephone: (86-755) 8307 1443, or email: CN.Doccheck@sgs.com

SGS-CSI (Shanghai) Technical Services (Group) Co., Ltd.
Testing Center, China

3rd Building, No. 889 Yishan Road Xuhui District, Shanghai China 200233
中国·上海·徐汇区宜山路889号3号楼 邮编: 200233

T E & E (86-21) 61402553 | E & E (86-21) 64953879 | www.sgsgroup.com.cn
T HL (86-21) 61402594 | T HL (86-21) 61156899 | sgs.china@sgs.com

ATTACHMENTS

Elements (IEC62321) Testing Flow Chart

1) These samples were dissolved totally by pre-conditioning method according to below flow chart.

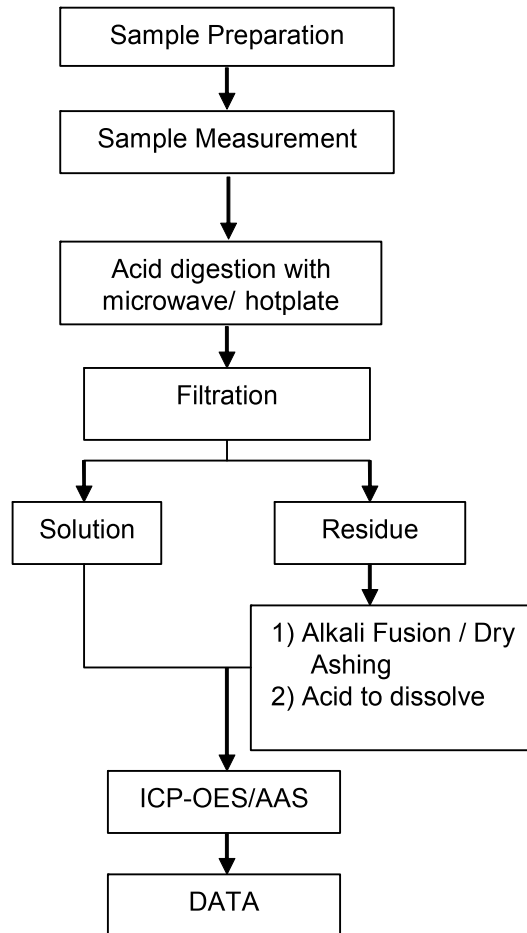

ATTACHMENTS

Hexavalent Chromium (Cr(VI)) Testing Flow Chart

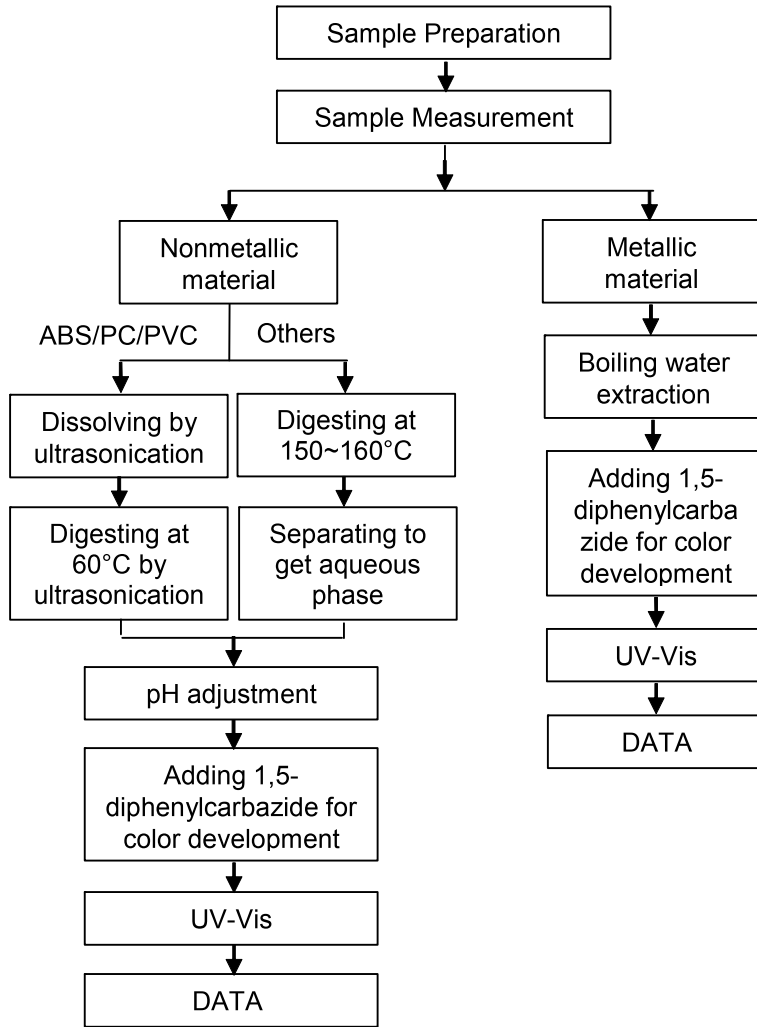

Unless otherwise agreed in writing, this document is issued by the Company subject to its General Conditions of Service printed overleaf, available on request or accessible at <http://www.sgs.com/en/Terms-and-Conditions.aspx> and, for electronic format documents, subject to Terms and Conditions for Electronic Documents at <http://www.sgs.com/en/Terms-and-Conditions/Terms-e-Document.aspx>. Attention is drawn to the limitation of liability, indemnification and jurisdiction issues defined therein. Any holder of this document is advised that information contained hereon reflects the Company's findings at the time of its intervention only and within the limits of Client's instructions, if any. The Company's sole responsibility is to its Client and this document does not exonerate parties to a transaction from exercising all their rights and obligations under the transaction documents. This document cannot be reproduced except in full, without prior written approval of the Company. Any unauthorized alteration, forgery or falsification of the content or appearance of this document is unlawful and offenders may be prosecuted to the fullest extent of the law. Unless otherwise stated the results shown in this test report refer only to the sample(s) tested.

Attention: To check the authenticity of testing /inspection report & certificate, please contact us at telephone: (86-755) 8307 1443, or email: CN.Doccheck@sgs.com

3rd Building, No. 889 Yishan Road Xuhui District, Shanghai China 200233 | E&E (86-21) 61402553 | E&E (86-21) 64953879 | www.sgs.com.cn
 中国·上海·徐汇区宜山路889号3号楼 邮编: 200233 | 1HL (86-21) 61402594 | 1HL (86-21) 61156899 | e sgs.china@sgs.com

ATTACHMENTS

PBBs/PBDEs Testing Flow Chart

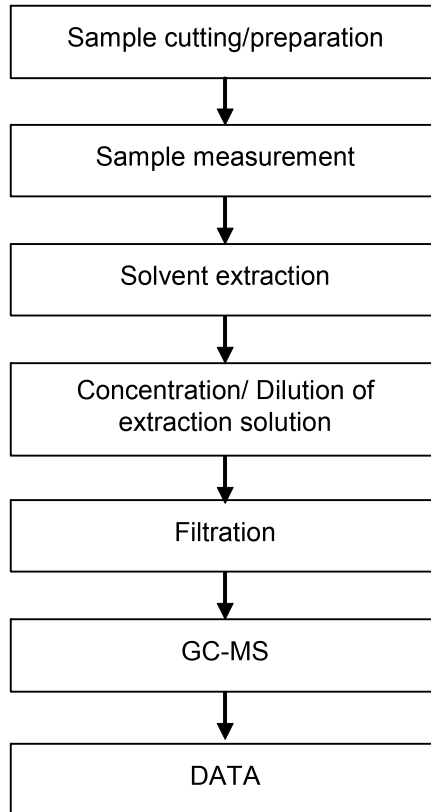

Unless otherwise agreed in writing, this document is issued by the Company subject to its General Conditions of Service printed overleaf, available on request or accessible at <http://www.sgs.com/en/Terms-and-Conditions.aspx> and, for electronic format documents, subject to Terms and Conditions for Electronic Documents at <http://www.sgs.com/en/Terms-and-Conditions/Terms-e-Documents.aspx>. Attention is drawn to the limitation of liability, indemnification and jurisdiction issues defined therein. Any holder of this document is advised that information contained hereon reflects the Company's findings at the time of its intervention only and within the limits of Client's instructions, if any. The Company's sole responsibility is to its Client and this document does not exonerate parties to a transaction from exercising all their rights and obligations under the transaction documents. This document cannot be reproduced except in full, without prior written approval of the Company. Any unauthorized alteration, forgery or falsification of the content or appearance of this document is unlawful and offenders may be prosecuted to the fullest extent of the law. Unless otherwise stated the results shown in this test report refer only to the sample(s) tested.

Attention: To check the authenticity of testing /inspection report & certificate, please contact us at telephone: (86-755) 8307 1443, or email: CN.Doccheck@sgs.com

ATTACHMENTS

Phthalates Testing Flow Chart

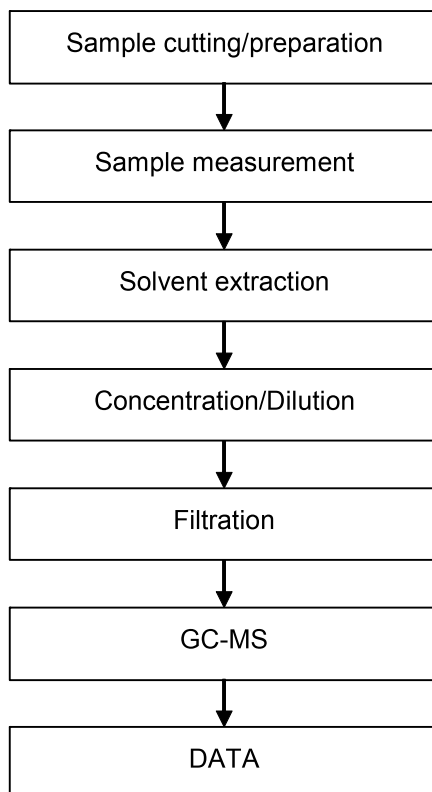

Unless otherwise agreed in writing, this document is issued by the Company subject to its General Conditions of Service printed overleaf, available on request or accessible at <http://www.sgs.com/en/Terms-and-Conditions.aspx> and, for electronic format documents, subject to Terms and Conditions for Electronic Documents at <http://www.sgs.com/en/Terms-and-Conditions/Terms-e-Documents.aspx>. Attention is drawn to the limitation of liability, indemnification and jurisdiction issues defined therein. Any holder of this document is advised that information contained hereon reflects the Company's findings at the time of its intervention only and within the limits of Client's instructions, if any. The Company's sole responsibility is to its Client and this document does not exonerate parties to a transaction from exercising all their rights and obligations under the transaction documents. This document cannot be reproduced except in full, without prior written approval of the Company. Any unauthorized alteration, forgery or falsification of the content or appearance of this document is unlawful and offenders may be prosecuted to the fullest extent of the law. Unless otherwise stated the results shown in this test report refer only to the sample(s) tested.

Attention: To check the authenticity of testing /inspection report & certificate, please contact us at telephone: (86-755) 8307 1443, or email: CN.Doccheck@sgs.com

3rd Building, No. 889 Yishan Road Xuhui District, Shanghai China 200233 | E&E (86-21) 61402553 | E&E (86-21) 64953679 | www.sgs.com.cn
 中国·上海·徐汇区宜山路889号3号楼 邮编: 200233 | 1HL (86-21) 61402594 | 1HL (86-21) 61156899 | sgs.china@sgs.com

ATTACHMENTS

Halogen Testing (oxygen bomb) Flow Chart

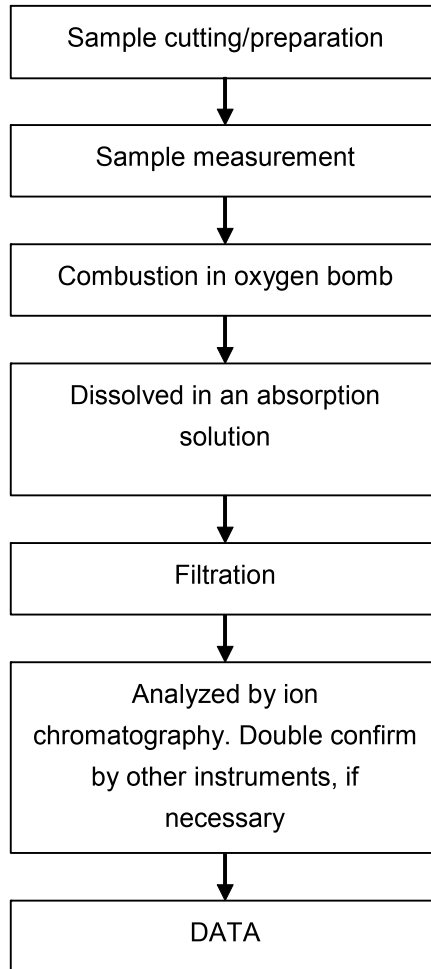

Unless otherwise agreed in writing, this document is issued by the Company subject to its General Conditions of Service printed overleaf, available on request or accessible at <http://www.sgs.com/en/Terms-and-Conditions.aspx> and, for electronic format documents, subject to Terms and Conditions for Electronic Documents at <http://www.sgs.com/en/Terms-and-Conditions/Terms-e-Document.aspx>. Attention is drawn to the limitation of liability, indemnification and jurisdiction issues defined therein. Any holder of this document is advised that information contained hereon reflects the Company's findings at the time of its intervention only and within the limits of Client's instructions, if any. The Company's sole responsibility is to its Client and this document does not exonerate parties to a transaction from exercising all their rights and obligations under the transaction documents. This document cannot be reproduced except in full, without prior written approval of the Company. Any unauthorized alteration, forgery or falsification of the content or appearance of this document is unlawful and offenders may be prosecuted to the fullest extent of the law. Unless otherwise stated the results shown in this test report refer only to the sample(s) tested.

Attention: To check the authenticity of testing /inspection report & certificate, please contact us at telephone: (86-755) 8307 1443, or email: CN.Doccheck@sgs.com

SGS-CSI (Shanghai) Technical Services (Shanghai) Co., Ltd.
Testing Center (China) (Shanghai)

3rd Building, No. 889 Yishan Road Xuhui District, Shanghai China 200233
中国·上海·徐汇区宜山路889号3号楼 邮编: 200233

TEL (86-21) 61402553 | E&E (86-21) 64953679 | www.sgs.com.cn
1HL (86-21) 61402594 | 1HL (86-21) 61156899 | sgs.china@sgs.com

ATTACHMENTS

HBCDD Testing Flow Chart

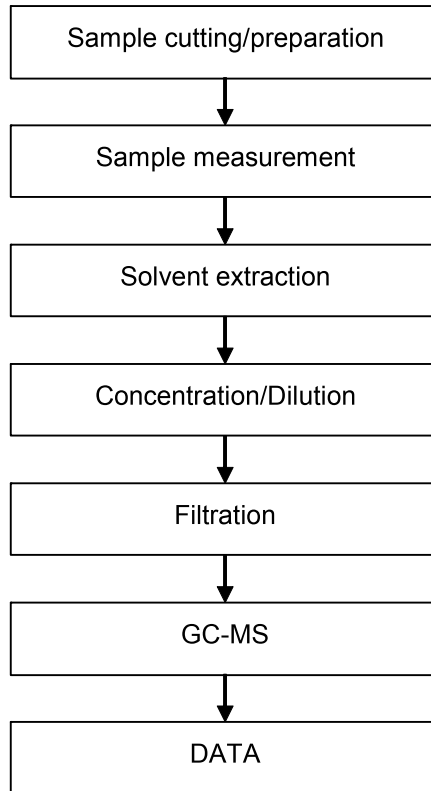

Unless otherwise agreed in writing, this document is issued by the Company subject to its General Conditions of Service printed overleaf, available on request or accessible at <http://www.sgs.com/en/Terms-and-Conditions.aspx> and, for electronic format documents, subject to Terms and Conditions for Electronic Documents at <http://www.sgs.com/en/Terms-and-Conditions/Terms-e-Documents.aspx>. Attention is drawn to the limitation of liability, indemnification and jurisdiction issues defined therein. Any holder of this document is advised that information contained hereon reflects the Company's findings at the time of its intervention only and within the limits of Client's instructions, if any. The Company's sole responsibility is to its Client and this document does not exonerate parties to a transaction from exercising all their rights and obligations under the transaction documents. This document cannot be reproduced except in full, without prior written approval of the Company. Any unauthorized alteration, forgery or falsification of the content or appearance of this document is unlawful and offenders may be prosecuted to the fullest extent of the law. Unless otherwise stated the results shown in this test report refer only to the sample(s) tested.

Attention: To check the authenticity of testing /inspection report & certificate, please contact us at telephone: (86-755) 8307 1443, or email: CN.Doccheck@sgs.com

ATTACHMENTS

PAHs Testing Flow Chart

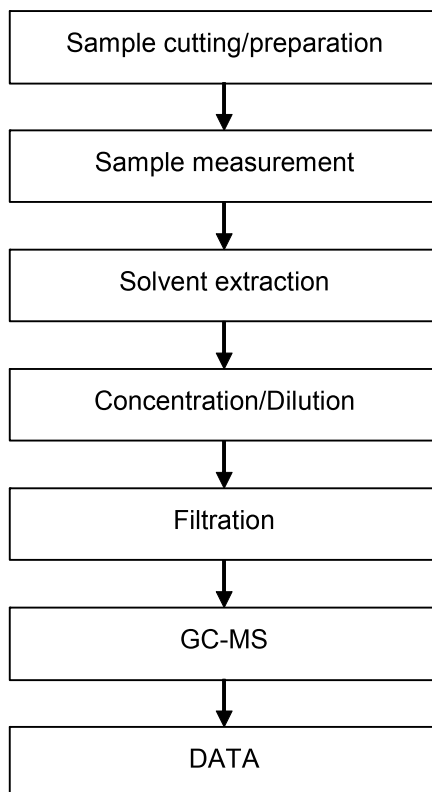

Unless otherwise agreed in writing, this document is issued by the Company subject to its General Conditions of Service printed overleaf, available on request or accessible at <http://www.sgs.com/en/Terms-and-Conditions.aspx> and, for electronic format documents, subject to Terms and Conditions for Electronic Documents at <http://www.sgs.com/en/Terms-and-Conditions/Terms-e-Documents.aspx>. Attention is drawn to the limitation of liability, indemnification and jurisdiction issues defined therein. Any holder of this document is advised that information contained hereon reflects the Company's findings at the time of its intervention only and within the limits of Client's instructions, if any. The Company's sole responsibility is to its Client and this document does not exonerate parties to a transaction from exercising all their rights and obligations under the transaction documents. This document cannot be reproduced except in full, without prior written approval of the Company. Any unauthorized alteration, forgery or falsification of the content or appearance of this document is unlawful and offenders may be prosecuted to the fullest extent of the law. Unless otherwise stated the results shown in this test report refer only to the sample(s) tested.

Attention: To check the authenticity of testing /inspection report & certificate, please contact us at telephone: (86-755) 8307 1443, or email: CN.Doccheck@sgs.com

3rd Building, No. 889 Yishan Road Xuhui District, Shanghai China 200233 1E&E (86-21) 61402553 1E&E (86-21) 64953679 www.sgs.com
 中国·上海·徐汇区宜山路889号3号楼 邮编: 200233 1HL (86-21) 61402594 1HL (86-21) 61156899 sgs.china@sgs.com

ATTACHMENTS

Elements Testing Flow Chart

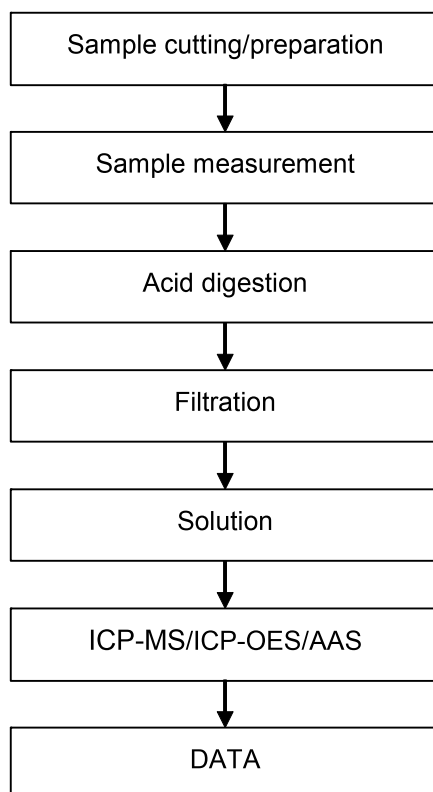

Unless otherwise agreed in writing, this document is issued by the Company subject to its General Conditions of Service printed overleaf, available on request or accessible at <http://www.sgs.com/en/Terms-and-Conditions.aspx> and, for electronic format documents, subject to Terms and Conditions for Electronic Documents at <http://www.sgs.com/en/Terms-and-Conditions/Terms-e-Documents.aspx>. Attention is drawn to the limitation of liability, indemnification and jurisdiction issues defined therein. Any holder of this document is advised that information contained hereon reflects the Company's findings at the time of its intervention only and within the limits of Client's instructions, if any. The Company's sole responsibility is to its Client and this document does not exonerate parties to a transaction from exercising all their rights and obligations under the transaction documents. This document cannot be reproduced except in full, without prior written approval of the Company. Any unauthorized alteration, forgery or falsification of the content or appearance of this document is unlawful and offenders may be prosecuted to the fullest extent of the law. Unless otherwise stated the results shown in this test report refer only to the sample(s) tested.

Attention: To check the authenticity of testing /inspection report & certificate, please contact us at telephone: (86-755) 8307 1443, or email: CN.Doccheck@sgs.com

3rd Building, No. 889 Yishan Road Xuhui District, Shanghai China 200233 1E&E (86-21) 61402553 1E&E (86-21) 64953879 www.sgs.com
 中国·上海·徐汇区宜山路889号3号楼 邮编: 200233 1HL (86-21) 61402594 1HL (86-21) 61156899 sgs.china@sgs.com



ATTACHMENTS

BPA Testing Flow Chart

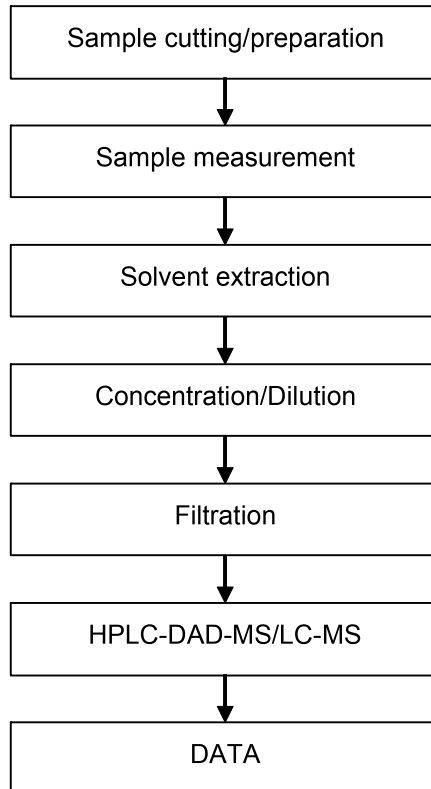

Unless otherwise agreed in writing, this document is issued by the Company subject to its General Conditions of Service printed overleaf, available on request or accessible at <http://www.sgs.com/en/Terms-and-Conditions.aspx> and, for electronic format documents, subject to Terms and Conditions for Electronic Documents at <http://www.sgs.com/en/Terms-and-Conditions/Terms-e-Documents.aspx>. Attention is drawn to the limitation of liability, indemnification and jurisdiction issues defined therein. Any holder of this document is advised that information contained hereon reflects the Company's findings at the time of its intervention only and within the limits of Client's instructions, if any. The Company's sole responsibility is to its Client and this document does not exonerate parties to a transaction from exercising all their rights and obligations under the transaction documents. This document cannot be reproduced except in full, without prior written approval of the Company. Any unauthorized alteration, forgery or falsification of the content or appearance of this document is unlawful and offenders may be prosecuted to the fullest extent of the law. Unless otherwise stated the results shown in this test report refer only to the sample(s) tested.

Attention: To check the authenticity of testing /inspection report & certificate, please contact us at telephone: (86-755) 8307 1443, or email: CN.Doccheck@sgs.com

SGS-CSI (Shanghai) Technical Services Co., Ltd.
Testing Center (China) Co., Ltd.

3rd Building, No. 889 Yishan Road Xuhui District, Shanghai China 200233
中国·上海·徐汇区宜山路889号3号楼 邮编: 200233

TEL (86-21) 61402553 | E&E (86-21) 64953679 | www.sgs.com.cn
1HL (86-21) 61402594 | 1HL (86-21) 61156899 | sgs.china@sgs.com

ATTACHMENTS

Chlorinated Paraffin Testing Flow Chart

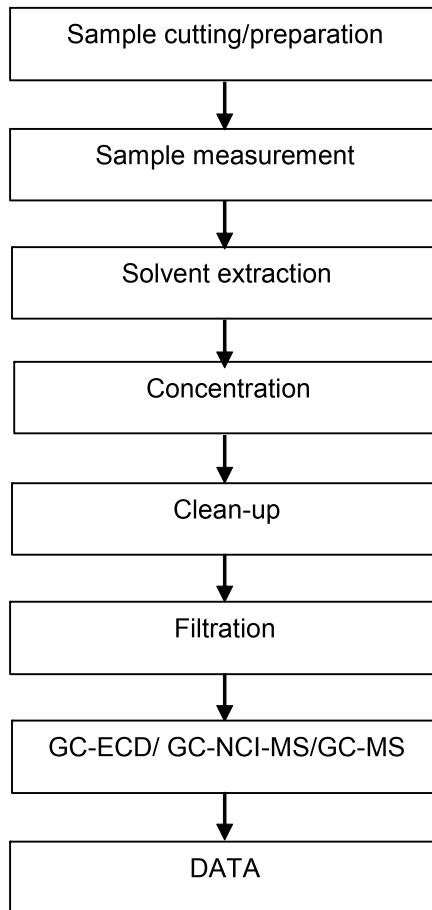

Unless otherwise agreed in writing, this document is issued by the Company subject to its General Conditions of Service printed overleaf, available on request or accessible at <http://www.sgs.com/en/Terms-and-Conditions.aspx> and, for electronic format documents, subject to Terms and Conditions for Electronic Documents at <http://www.sgs.com/en/Terms-and-Conditions/Terms-e-Document.aspx>. Attention is drawn to the limitation of liability, indemnification and jurisdiction issues defined therein. Any holder of this document is advised that information contained hereon reflects the Company's findings at the time of its intervention only and within the limits of Client's instructions, if any. The Company's sole responsibility is to its Client and this document does not exonerate parties to a transaction from exercising all their rights and obligations under the transaction documents. This document cannot be reproduced except in full, without prior written approval of the Company. Any unauthorized alteration, forgery or falsification of the content or appearance of this document is unlawful and offenders may be prosecuted to the fullest extent of the law. Unless otherwise stated the results shown in this test report refer only to the sample(s) tested.

Attention: To check the authenticity of testing /inspection report & certificate, please contact us at telephone: (86-755) 8307 1443, or email: CN.Doccheck@sgs.com

ATTACHMENTS

TBBP-A Testing Flow Chart

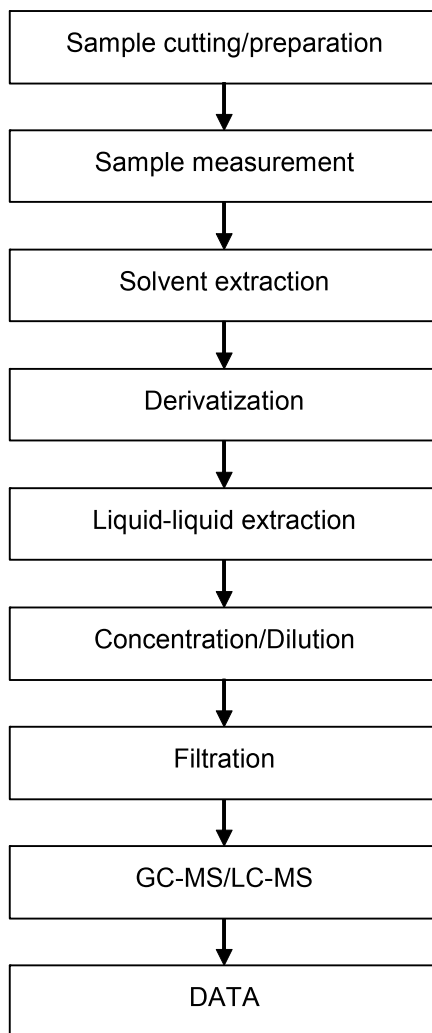

Unless otherwise agreed in writing, this document is issued by the Company subject to its General Conditions of Service printed overleaf, available on request or accessible at <http://www.sgs.com/en/Terms-and-Conditions.aspx> and, for electronic format documents, subject to Terms and Conditions for Electronic Documents at <http://www.sgs.com/en/Terms-and-Conditions/Terms-e-Documents.aspx>. Attention is drawn to the limitation of liability, indemnification and jurisdiction issues defined therein. Any holder of this document is advised that information contained hereon reflects the Company's findings at the time of its intervention only and within the limits of Client's instructions, if any. The Company's sole responsibility is to its Client and this document does not exonerate parties to a transaction from exercising all their rights and obligations under the transaction documents. This document cannot be reproduced except in full, without prior written approval of the Company. Any unauthorized alteration, forgery or falsification of the content or appearance of this document is unlawful and offenders may be prosecuted to the fullest extent of the law. Unless otherwise stated the results shown in this test report refer only to the sample(s) tested.

Attention: To check the authenticity of testing /inspection report & certificate, please contact us at telephone: (86-755) 8307 1443, or email: CN.Doccheck@sgs.com

3rd Building, No. 889 Yishan Road Xuhui District, Shanghai China 200233 | E&E (86-21) 61402553 | E&E (86-21) 64953679 | www.sgsgroup.com.cn
 中国·上海·徐汇区宜山路889号3号楼 邮编: 200233 | 1HL (86-21) 61402594 | 1HL (86-21) 61156899 | sgs.china@sgs.com

Sample photo:



SGS authenticate the photo on original report only

*** End of Report ***



Unless otherwise agreed in writing, this document is issued by the Company subject to its General Conditions of Service printed overleaf, available on request or accessible at <http://www.sgs.com/en/Terms-and-Conditions.aspx> and, for electronic format documents, subject to Terms and Conditions for Electronic Documents at <http://www.sgs.com/en/Terms-and-Conditions/Terms-e-Documents.aspx>. Attention is drawn to the limitation of liability, indemnification and jurisdiction issues defined therein. Any holder of this document is advised that information contained hereon reflects the Company's findings at the time of its intervention only and within the limits of Client's instructions, if any. The Company's sole responsibility is to its Client and this document does not exonerate parties to a transaction from exercising all their rights and obligations under the transaction documents. This document cannot be reproduced except in full, without prior written approval of the Company. Any unauthorized alteration, forgery or falsification of the content or appearance of this document is unlawful and offenders may be prosecuted to the fullest extent of the law. Unless otherwise stated the results shown in this test report refer only to the sample(s) tested.

Attention: To check the authenticity of testing /inspection report & certificate, please contact us at telephone: (86-755) 8307 1443, or email: CN.Doccheck@sgs.com

3rd Building, No. 889 Yishan Road Xuhui District, Shanghai China 200233 | E&E (86-21) 61402553 | E&E (86-21) 64953879 | www.sgs.com
中国·上海·徐汇区宜山路889号3号楼 邮编: 200233 | 1HL (86-21) 61402594 | 1HL (86-21) 61156899 | sgs.china@sgs.com

Test Report

No. SHAEC2203753901

Date: 10 Mar 2022

Page 1 of 8

Client Name : COLORANT CHROMATICS TRADING(SHANGHAI)CO.,LTD

Client Address : 2F,BLOCK C,VI-HUB@JINQIAO,200 JINSU ROAD,PUDONG,SHANGHAI

Sample Name : FEP Colormasterbatch

Lot No. : 6952666

Client Ref. Information : 100.00/102.00/103.00/108.00/113.00/142.00/143.00/152.00/153.00/158.00/190.00/192.00/193.00/198.00/S203.0/S243.0/S245.0/STR1625/STR1962

The above sample(s) and information were provided by the client.

SGS Job No. : SP22-005867 - SH

Date of Sample Received : 04 Mar 2022

Testing Period : 04 Mar 2022 - 10 Mar 2022

Test Requested : Selected test(s) as requested by client.

Test Method : Please refer to next page(s).

Test Results : Please refer to next page(s).

Conclusion : Based on the performed tests on submitted sample(s), the results of Cadmium, Lead, Mercury, Hexavalent chromium, Polybrominated biphenyls (PBBs), Polybrominated diphenyl ethers (PBDEs) and Phthalates such as Bis(2-ethylhexyl) phthalate (DEHP), Butyl benzyl phthalate (BBP), Dibutyl phthalate (DBP) and Diisobutyl phthalate (DIBP) comply with the limits as set by RoHS Directive (EU) 2015/863 amending Annex II to Directive 2011/65/EU.

Signed for and on behalf of
SGS-CSTC Standards Technical Services (Shanghai) Co., Ltd.

Carol Luo

Carol Luo
Approved Signatory

scan to see the report



F836BA57



Unless otherwise agreed in writing, this document is issued by the Company subject to its General Conditions of Service printed overleaf, available on request or accessible at <http://www.sgs.com/en/Terms-and-Conditions.aspx> and, for electronic format documents, subject to Terms and Conditions for Electronic Documents at <http://www.sgs.com/en/Terms-and-Conditions/Terms-e-Documents.aspx>. Attention is drawn to the limitation of liability, indemnification and jurisdiction issues defined therein. Any holder of this document is advised that information contained hereon reflects the Company's findings at the time of its intervention only and within the limits of Client's instructions, if any. The Company's sole responsibility is to its Client and this document does not exonerate parties to a transaction from exercising all their rights and obligations under the transaction documents. This document cannot be reproduced except in full, without prior written approval of the Company. Any unauthorized alteration, forgery or falsification of the content or appearance of this document is unlawful and offenders may be prosecuted to the fullest extent of the law. Unless otherwise stated the results shown in this test report refer only to the sample(s) tested.

Attention: To check the authenticity of testing /inspection report & certificate, please contact us at telephone: (86-755) 8307 1443, or email: CN.Doccheck@sgs.com

3rd Building, No. 889 Yishan Road Xuhui District, Shanghai China 200233 1E&E (86-21) 61402553 1E&E (86-21) 64953679 www.sgsgroup.com.cn
中国·上海·徐汇区宜山路889号3号楼 邮编: 200233 1HL (86-21) 61402594 1HL (86-21) 61156899 e sgs.china@sgs.com

Test Report

No. SHAEC2203753901

Date: 10 Mar 2022

Page 2 of 8

Test Results :

Test Part Description :

Specimen No.	SGS Sample ID	Description
SN1	SHA22-037539.001	Black solid pellet

Remarks :

- (1) 1 mg/kg = 0.0001%
- (2) MDL = Method Detection Limit
- (3) ND = Not Detected (< MDL)
- (4) "-" = Not Regulated

RoHS Directive (EU) 2015/863 amending Annex II to Directive 2011/65/EU

Test Method : With reference to IEC 62321-4:2013+AMD1:2017, IEC62321-5:2013, IEC62321-7-2:2017, IEC 62321-6:2015 and IEC62321-8:2017, analyzed by ICP-OES, UV-Vis and GC-MS.

Test Item(s)	Limit	Unit	MDL	001
Cadmium (Cd)	100	mg/kg	2	ND
Lead (Pb)	1000	mg/kg	2	ND
Mercury (Hg)	1000	mg/kg	2	ND
Hexavalent Chromium (Cr(VI))	1000	mg/kg	8	ND
Sum of PBBs	1000	mg/kg	-	ND
Monobromobiphenyl	-	mg/kg	5	ND
Dibromobiphenyl	-	mg/kg	5	ND
Tribromobiphenyl	-	mg/kg	5	ND
Tetrabromobiphenyl	-	mg/kg	5	ND
Pentabromobiphenyl	-	mg/kg	5	ND
Hexabromobiphenyl	-	mg/kg	5	ND
Heptabromobiphenyl	-	mg/kg	5	ND
Octabromobiphenyl	-	mg/kg	5	ND
Nonabromobiphenyl	-	mg/kg	5	ND
Decabromobiphenyl	-	mg/kg	5	ND
Sum of PBDEs	1000	mg/kg	-	ND
Monobromodiphenyl ether	-	mg/kg	5	ND
Dibromodiphenyl ether	-	mg/kg	5	ND
Tribromodiphenyl ether	-	mg/kg	5	ND
Tetrabromodiphenyl ether	-	mg/kg	5	ND



Unless otherwise agreed in writing, this document is issued by the Company subject to its General Conditions of Service printed overleaf, available on request or accessible at <http://www.sgs.com/en/Terms-and-Conditions.aspx> and, for electronic format documents, subject to Terms and Conditions for Electronic Documents at <http://www.sgs.com/en/Terms-and-Conditions/Terms-e-Documents.aspx>. Attention is drawn to the limitation of liability, indemnification and jurisdiction issues defined therein. Any holder of this document is advised that information contained hereon reflects the Company's findings at the time of its intervention only and within the limits of Client's instructions, if any. The Company's sole responsibility is to its Client and this document does not exonerate parties to a transaction from exercising all their rights and obligations under the transaction documents. This document cannot be reproduced except in full, without prior written approval of the Company. Any unauthorized alteration, forgery or falsification of the content or appearance of this document is unlawful and offenders may be prosecuted to the fullest extent of the law. Unless otherwise stated the results shown in this test report refer only to the sample(s) tested.

Attention: To check the authenticity of testing /inspection report & certificate, please contact us at telephone: (86-755) 8307 1443, or email: CN.Doccheck@sgs.com

SGS-CSI (Shanghai) Inspection & Testing Services Co., Ltd. 3rd Building, No. 889 Yishan Road Xuhui District, Shanghai China 200233 1E&E (86-21) 61402553 1E&E (86-21) 64953879 www.sgsgroup.com.cn
 中国·上海·徐汇区宜山路889号3号楼 邮编: 200233 1HL (86-21) 61402594 1HL (86-21) 61156899 e sgs.china@sgs.com

Test Report

No. SHAEC2203753901

Date: 10 Mar 2022

Page 3 of 8

<u>Test Item(s)</u>	<u>Limit</u>	<u>Unit</u>	<u>MDL</u>	<u>001</u>
Pentabromodiphenyl ether	-	mg/kg	5	ND
Hexabromodiphenyl ether	-	mg/kg	5	ND
Heptabromodiphenyl ether	-	mg/kg	5	ND
Octabromodiphenyl ether	-	mg/kg	5	ND
Nonabromodiphenyl ether	-	mg/kg	5	ND
Decabromodiphenyl ether	-	mg/kg	5	ND
Di-butyl Phthalate (DBP)	1000	mg/kg	50	ND
Benzyl Butyl Phthalate (BBP)	1000	mg/kg	50	ND
Di-2-Ethyl Hexyl Phthalate (DEHP)	1000	mg/kg	50	ND
Diisobutyl Phthalates (DIBP)	1000	mg/kg	50	ND

Notes :

- (1) The maximum permissible limit is quoted from RoHS Directive (EU) 2015/863. IEC 62321 series is equivalent to EN 62321 series
https://www.cenelec.eu/dyn/www/f?p=104:30:1742232870351101:::FSP_ORG_ID,FSP_LANG_ID:1258637,25
- (2) The restriction of DEHP, BBP, DBP and DIBP shall apply to medical devices, including in vitro medical devices, and monitoring and control instruments, including industrial monitoring and control instruments, from 22 July 2021.



Unless otherwise agreed in writing, this document is issued by the Company subject to its General Conditions of Service printed overleaf, available on request or accessible at <http://www.sgs.com/en/Terms-and-Conditions.aspx> and, for electronic format documents, subject to Terms and Conditions for Electronic Documents at <http://www.sgs.com/en/Terms-and-Conditions/Terms-e-Documents.aspx>. Attention is drawn to the limitation of liability, indemnification and jurisdiction issues defined therein. Any holder of this document is advised that information contained hereon reflects the Company's findings at the time of its intervention only and within the limits of Client's instructions, if any. The Company's sole responsibility is to its Client and this document does not exonerate parties to a transaction from exercising all their rights and obligations under the transaction documents. This document cannot be reproduced except in full, without prior written approval of the Company. Any unauthorized alteration, forgery or falsification of the content or appearance of this document is unlawful and offenders may be prosecuted to the fullest extent of the law. Unless otherwise stated the results shown in this test report refer only to the sample(s) tested.

Attention: To check the authenticity of testing /inspection report & certificate, please contact us at telephone: (86-755) 8307 1443, or email: CN.Doccheck@sgs.com

3rd Building, No. 889 Yishan Road Xuhui District, Shanghai China 200233 | E&E (86-21) 61402553 | E&E (86-21) 64953879 | www.sgsgroup.com.cn
 中国·上海·徐汇区宜山路889号3号楼 邮编: 200233 | HL (86-21) 61402594 | HL (86-21) 61156899 | e sgs.china@sgs.com

ATTACHMENTS

Elements (IEC62321) Testing Flow Chart

1) These samples were dissolved totally by pre-conditioning method according to below flow chart.

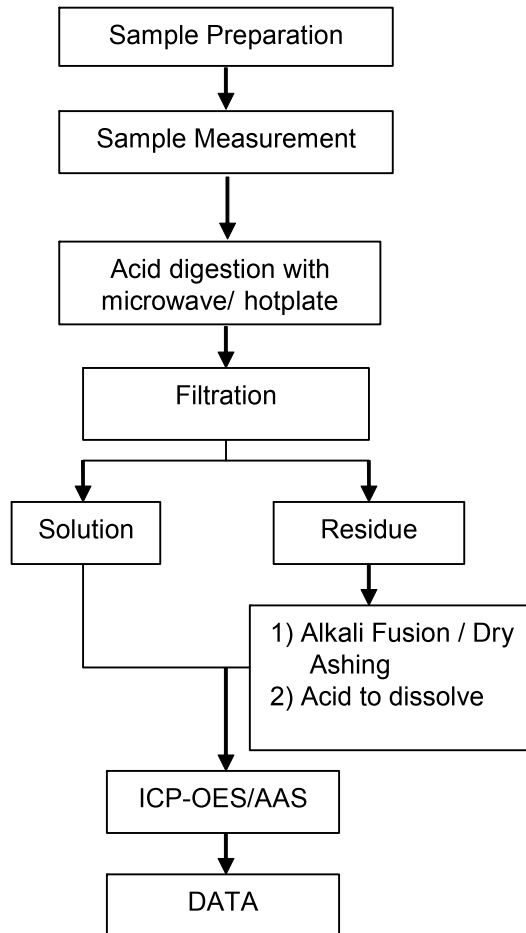

Unless otherwise agreed in writing, this document is issued by the Company subject to its General Conditions of Service printed overleaf, available on request or accessible at <http://www.sgs.com/en/Terms-and-Conditions.aspx> and, for electronic format documents, subject to Terms and Conditions for Electronic Documents at <http://www.sgs.com/en/Terms-and-Conditions/Terms-e-Document.aspx>. Attention is drawn to the limitation of liability, indemnification and jurisdiction issues defined therein. Any holder of this document is advised that information contained hereon reflects the Company's findings at the time of its intervention only and within the limits of Client's instructions, if any. The Company's sole responsibility is to its Client and this document does not exonerate parties to a transaction from exercising all their rights and obligations under the transaction documents. This document cannot be reproduced except in full, without prior written approval of the Company. Any unauthorized alteration, forgery or falsification of the content or appearance of this document is unlawful and offenders may be prosecuted to the fullest extent of the law. Unless otherwise stated the results shown in this test report refer only to the sample(s) tested.

Attention: To check the authenticity of testing /inspection report & certificate, please contact us at telephone: (86-755) 8307 1443, or email: CN.Doccheck@sgs.com

3rd Building, No. 889 Yishan Road Xuhui District, Shanghai China 200233 1E&E (86-21) 61402553 1E&E (86-21) 64953679 www.sgs.com
 中国·上海·徐汇区宜山路889号3号楼 邮编: 200233 1HL (86-21) 61402594 1HL (86-21) 61156899 sgs.china@sgs.com

ATTACHMENTS

Hexavalent Chromium (Cr(VI)) Testing Flow Chart

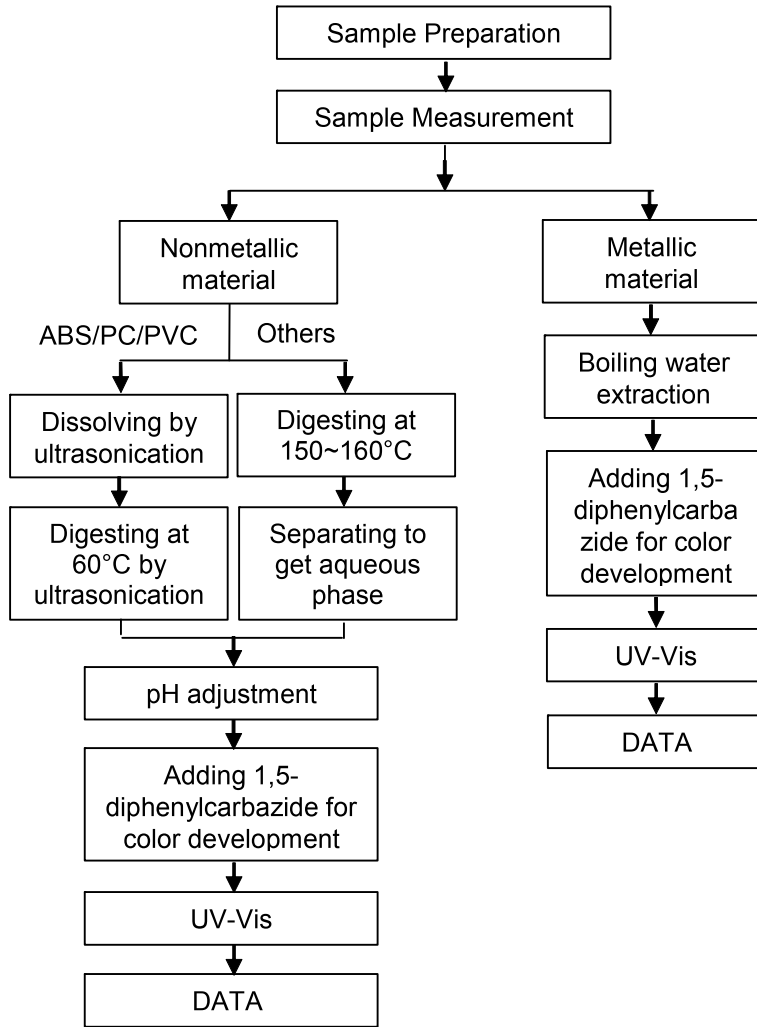

Unless otherwise agreed in writing, this document is issued by the Company subject to its General Conditions of Service printed overleaf, available on request or accessible at <http://www.sgs.com/en/Terms-and-Conditions.aspx> and, for electronic format documents, subject to Terms and Conditions for Electronic Documents at <http://www.sgs.com/en/Terms-and-Conditions/Terms-e-Document.aspx>. Attention is drawn to the limitation of liability, indemnification and jurisdiction issues defined therein. Any holder of this document is advised that information contained hereon reflects the Company's findings at the time of its intervention only and within the limits of Client's instructions, if any. The Company's sole responsibility is to its Client and this document does not exonerate parties to a transaction from exercising all their rights and obligations under the transaction documents. This document cannot be reproduced except in full, without prior written approval of the Company. Any unauthorized alteration, forgery or falsification of the content or appearance of this document is unlawful and offenders may be prosecuted to the fullest extent of the law. Unless otherwise stated the results shown in this test report refer only to the sample(s) tested.

Attention: To check the authenticity of testing /inspection report & certificate, please contact us at telephone: (86-755) 8307 1443, or email: CN.Doccheck@sgs.com

3rd Building, No. 889 Yishan Road Xuhui District, Shanghai China 200233 1E&E (86-21) 61402553 1E&E (86-21) 64953879 www.sgs.com.cn
 中国·上海·徐汇区宜山路889号3号楼 邮编: 200233 1HL (86-21) 61402594 1HL (86-21) 61156899 e sgs.china@sgs.com

ATTACHMENTS

PBBs/PBDEs Testing Flow Chart

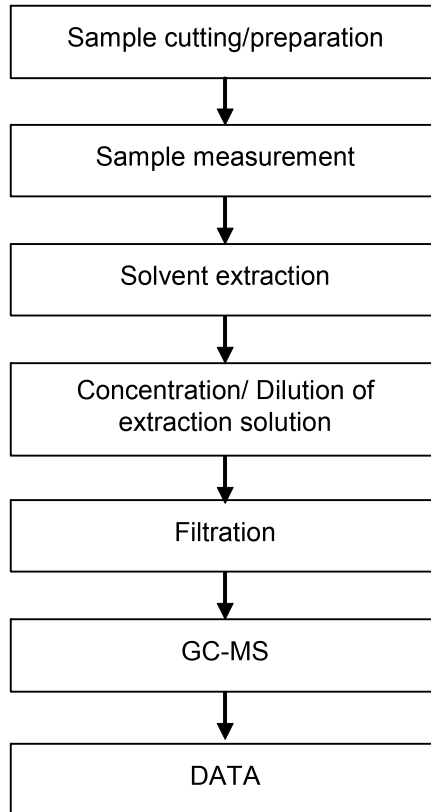

Unless otherwise agreed in writing, this document is issued by the Company subject to its General Conditions of Service printed overleaf, available on request or accessible at <http://www.sgs.com/en/Terms-and-Conditions.aspx> and, for electronic format documents, subject to Terms and Conditions for Electronic Documents at <http://www.sgs.com/en/Terms-and-Conditions/Terms-e-Documents.aspx>. Attention is drawn to the limitation of liability, indemnification and jurisdiction issues defined therein. Any holder of this document is advised that information contained hereon reflects the Company's findings at the time of its intervention only and within the limits of Client's instructions, if any. The Company's sole responsibility is to its Client and this document does not exonerate parties to a transaction from exercising all their rights and obligations under the transaction documents. This document cannot be reproduced except in full, without prior written approval of the Company. Any unauthorized alteration, forgery or falsification of the content or appearance of this document is unlawful and offenders may be prosecuted to the fullest extent of the law. Unless otherwise stated the results shown in this test report refer only to the sample(s) tested.

Attention: To check the authenticity of testing /inspection report & certificate, please contact us at telephone: (86-755) 8307 1443, or email: CN.Doccheck@sgs.com

ATTACHMENTS

Phthalates Testing Flow Chart

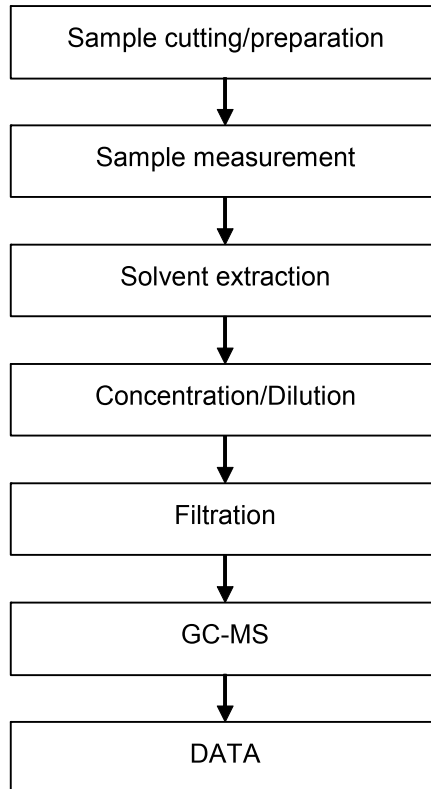

Unless otherwise agreed in writing, this document is issued by the Company subject to its General Conditions of Service printed overleaf, available on request or accessible at <http://www.sgs.com/en/Terms-and-Conditions.aspx> and, for electronic format documents, subject to Terms and Conditions for Electronic Documents at <http://www.sgs.com/en/Terms-and-Conditions/Terms-e-Documents.aspx>. Attention is drawn to the limitation of liability, indemnification and jurisdiction issues defined therein. Any holder of this document is advised that information contained hereon reflects the Company's findings at the time of its intervention only and within the limits of Client's instructions, if any. The Company's sole responsibility is to its Client and this document does not exonerate parties to a transaction from exercising all their rights and obligations under the transaction documents. This document cannot be reproduced except in full, without prior written approval of the Company. Any unauthorized alteration, forgery or falsification of the content or appearance of this document is unlawful and offenders may be prosecuted to the fullest extent of the law. Unless otherwise stated the results shown in this test report refer only to the sample(s) tested.

Attention: To check the authenticity of testing /inspection report & certificate, please contact us at telephone: (86-755) 8307 1443, or email: CN.Doccheck@sgs.com

Sample photo:



SGS authenticate the photo on original report only

*** End of Report ***



Unless otherwise agreed in writing, this document is issued by the Company subject to its General Conditions of Service printed overleaf, available on request or accessible at <http://www.sgs.com/en/Terms-and-Conditions.aspx> and, for electronic format documents, subject to Terms and Conditions for Electronic Documents at <http://www.sgs.com/en/Terms-and-Conditions/Terms-e-Document.aspx>. Attention is drawn to the limitation of liability, indemnification and jurisdiction issues defined therein. Any holder of this document is advised that information contained hereon reflects the Company's findings at the time of its intervention only and within the limits of Client's instructions, if any. The Company's sole responsibility is to its Client and this document does not exonerate parties to a transaction from exercising all their rights and obligations under the transaction documents. This document cannot be reproduced except in full, without prior written approval of the Company. Any unauthorized alteration, forgery or falsification of the content or appearance of this document is unlawful and offenders may be prosecuted to the fullest extent of the law. Unless otherwise stated the results shown in this test report refer only to the sample(s) tested.

Attention: To check the authenticity of testing /inspection report & certificate, please contact us at telephone: (86-755) 8307 1443, or email: CN.Doccheck@sgs.com

3rd Building, No. 889 Yishan Road Xuhui District, Shanghai China 200233 | E&E (86-21) 61402553 | E&E (86-21) 64953879 | www.sgs.com
中国·上海·徐汇区宜山路889号3号楼 邮编: 200233 | HL (86-21) 61402594 | HL (86-21) 61156899 | sgs.china@sgs.com

Test Report

No. TAOEC2200298101

Date: 20 Jan 2022

Page 1 of 8

SHAN DONG TIAN YUAN COPPER INDUSTRIAL CO.,LTD
DONG YING DISTRICT HUANG HE ROAD NO.36 DONG YING , SHAN DONG

The following sample(s) was/were submitted and identified on behalf of the clients as : PHOSPHOR BRONZE SUIP

SGS Job No. : QP22-000227 - QD
Model No. : C5210/QSN8-0.3
Date of Sample Received : 17 Jan 2022
Testing Period : 17 Jan 2022 - 20 Jan 2022
Test Requested : Selected test(s) as requested by client.
Test Method : Please refer to next page(s).
Test Results : Please refer to next page(s).
Conclusion : Based on the performed tests on submitted sample(s), the results of Lead, Mercury, Cadmium, Hexavalent chromium, Polybrominated biphenyls (PBBs), Polybrominated diphenyl ethers (PBDEs) and Phthalates such as Bis(2-ethylhexyl) phthalate (DEHP) , Butyl benzyl phthalate (BBP), Dibutyl phthalate (DBP) , and Diisobutyl phthalate (DIBP) comply with the limits as set by RoHS Directive (EU) 2015/863 amending Annex II to Directive 2011/65/EU.

Signed for and on behalf of
SGS-CSTC Standards Technical Services (Qingdao) Co., Ltd.



Wang Bo, Claire
Approved Signatory

scan to see the report



18297C0C



Unless otherwise agreed in writing, this document is issued by the Company subject to its General Conditions of Service printed overleaf, available on request or accessible at <http://www.sgs.com/en/Terms-and-Conditions.aspx> and, for electronic format documents, subject to Terms and Conditions for Electronic Documents at <http://www.sgs.com/en/Terms-and-Conditions/Terms-e-Documents.aspx>. Attention is drawn to the limitation of liability, indemnification and jurisdiction issues defined therein. Any holder of this document is advised that information contained hereon reflects the Company's findings at the time of its intervention only and within the limits of Client's instructions, if any. The Company's sole responsibility is to its Client and this document does not exonerate parties to a transaction from exercising all their rights and obligations under the transaction documents. This document cannot be reproduced except in full, without prior written approval of the Company. Any unauthorized alteration, forgery or falsification of the content or appearance of this document is unlawful and offenders may be prosecuted to the fullest extent of the law.
Attention: To check the authenticity of testing /inspection report & certificate, please contact us at telephone: (86-755) 8307 1443, or email: CN.Doccheck@sgs.com

Test Report

No. TAOEC2200298101

Date: 20 Jan 2022

Page 2 of 8

Test Results :

Test Part Description :

Specimen No.	SGS Sample ID	Description
SN1	TAO22-002981.001	coppery metal board

Remarks :

- (1) 1 mg/kg = 0.0001%
- (2) MDL = Method Detection Limit
- (3) ND = Not Detected (< MDL)
- (4) "-" = Not Regulated

RoHS Directive (EU) 2015/863 amending Annex II to Directive 2011/65/EU

Test Method : With reference to IEC 62321-5:2013, IEC 62321-4:2013+AMD1:2017, IEC 62321-7-1:2015, IEC 62321-6:2015 and IEC62321-8:2017, analyzed by ICP-OES,AAS, UV-Vis and GC-MS.

Test Item(s)	Limit	Unit	MDL	001
Cadmium (Cd)	100	mg/kg	2	ND
Lead (Pb)	1000	mg/kg	2	ND
Mercury (Hg)	1000	mg/kg	2	ND
Hexavalent Chromium (Cr(VI))▼	-	µg/cm ²	0.10	ND
Sum of PBBs	1000	mg/kg	-	ND
Monobromobiphenyl	-	mg/kg	5	ND
Dibromobiphenyl	-	mg/kg	5	ND
Tribromobiphenyl	-	mg/kg	5	ND
Tetrabromobiphenyl	-	mg/kg	5	ND
Pentabromobiphenyl	-	mg/kg	5	ND
Hexabromobiphenyl	-	mg/kg	5	ND
Heptabromobiphenyl	-	mg/kg	5	ND
Octabromobiphenyl	-	mg/kg	5	ND
Nonabromobiphenyl	-	mg/kg	5	ND
Decabromobiphenyl	-	mg/kg	5	ND
Sum of PBDEs	1000	mg/kg	-	ND
Monobromodiphenyl ether	-	mg/kg	5	ND
Dibromodiphenyl ether	-	mg/kg	5	ND
Tribromodiphenyl ether	-	mg/kg	5	ND
Tetrabromodiphenyl ether	-	mg/kg	5	ND
Pentabromodiphenyl ether	-	mg/kg	5	ND
Hexabromodiphenyl ether	-	mg/kg	5	ND



Unless otherwise agreed in writing, this document is issued by the Company subject to its General Conditions of Service printed overleaf, available on request or accessible at <http://www.sgs.com/en/Terms-and-Conditions.aspx> and, for electronic format documents, subject to Terms and Conditions for Electronic Documents at <http://www.sgs.com/en/Terms-and-Conditions/Terms-e-Documents.aspx>. Attention is drawn to the limitation of liability, indemnification and jurisdiction issues defined therein. Any holder of this document is advised that information contained hereon reflects the Company's findings at the time of its intervention only and within the limits of Client's instructions, if any. The Company's sole responsibility is to its Client and this document does not exonerate parties to a transaction from exercising all their rights and obligations under the transaction documents. This document cannot be reproduced except in full, without prior written approval of the Company. Any unauthorized alteration, forgery or falsification of the content or appearance of this document is unlawful and offenders may be prosecuted to the fullest extent of the law.
Attention: To check the authenticity of testing /inspection report & certificate, please contact us at telephone: (86-755) 8307 1443, or email: CN.Doccheck@sgs.com

Test Report

No. TAOEC2200298101

Date: 20 Jan 2022

Page 3 of 8

<u>Test Item(s)</u>	<u>Limit</u>	<u>Unit</u>	<u>MDL</u>	<u>001</u>
Heptabromodiphenyl ether	-	mg/kg	5	ND
Octabromodiphenyl ether	-	mg/kg	5	ND
Nonabromodiphenyl ether	-	mg/kg	5	ND
Decabromodiphenyl ether	-	mg/kg	5	ND
Dibutyl phthalate (DBP)	1000	mg/kg	50	ND
Butyl benzyl phthalate (BBP)	1000	mg/kg	50	ND
Bis (2-ethylhexyl) phthalate (DEHP)	1000	mg/kg	50	ND
Diisobutyl Phthalates (DIBP)	1000	mg/kg	50	ND

Notes :

- (1) The maximum permissible limit is quoted from RoHS Directive (EU) 2015/863.
- (2) IEC 62321 series is equivalent to EN 62321 series
https://www.cenelec.eu/dyn/www/f?p=104:30:1742232870351101:::FSP_ORG_ID,FSP_LANG_ID:1258637,25
- (3) ▼= a. The sample is positive for CrVI if the CrVI concentration is greater than 0.13 µg/cm². The sample coating is considered to contain CrVI
 b. The sample is negative for CrVI if CrVI is ND (concentration less than 0.10 µg/cm²). The coating is considered a non-CrVI based coating
 c. The result between 0.10 µg/cm² and 0.13 µg/cm² is considered to be inconclusive - unavoidable coating variations may influence the determination

Information on storage conditions and production date of the tested sample is unavailable and thus Cr(VI) results represent status of the sample at the time of testing.

- (4) The restriction of DEHP, BBP, DBP and DIBP shall apply to medical devices, including in vitro medical devices, and monitoring and control instruments, including industrial monitoring and control instruments, from 22 July 2021.



Unless otherwise agreed in writing, this document is issued by the Company subject to its General Conditions of Service printed overleaf, available on request or accessible at <http://www.sgs.com/en/Terms-and-Conditions.aspx> and, for electronic format documents, subject to Terms and Conditions for Electronic Documents at <http://www.sgs.com/en/Terms-and-Conditions/Terms-e-Documents.aspx>. Attention is drawn to the limitation of liability, indemnification and jurisdiction issues defined therein. Any holder of this document is advised that information contained hereon reflects the Company's findings at the time of its intervention only and within the limits of Client's instructions, if any. The Company's sole responsibility is to its Client and this document does not exonerate parties to a transaction from exercising all their rights and obligations under the transaction documents. This document cannot be reproduced except in full, without prior written approval of the Company. Any unauthorized alteration, forgery or falsification of the content or appearance of this document is unlawful and offenders may be prosecuted to the fullest extent of the law.
Attention: To check the authenticity of testing /inspection report & certificate, please contact us at telephone: (86-755) 8307 1443, or email: CN.Doccheck@sgs.com

ATTACHMENTS

PBBs/PBDEs Testing Flow Chart

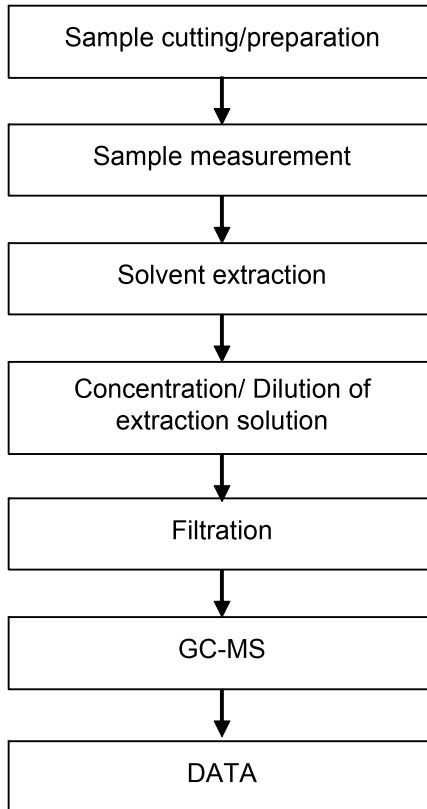

Unless otherwise agreed in writing, this document is issued by the Company subject to its General Conditions of Service printed overleaf, available on request or accessible at <http://www.sgs.com/en/Terms-and-Conditions.aspx> and, for electronic format documents, subject to Terms and Conditions for Electronic Documents at <http://www.sgs.com/en/Terms-and-Conditions/Terms-e-Documents.aspx>. Attention is drawn to the limitation of liability, indemnification and jurisdiction issues defined therein. Any holder of this document is advised that information contained hereon reflects the Company's findings at the time of its intervention only and within the limits of Client's instructions, if any. The Company's sole responsibility is to its Client and this document does not exonerate parties to a transaction from exercising all their rights and obligations under the transaction documents. This document cannot be reproduced except in full, without prior written approval of the Company. Any unauthorized alteration, forgery or falsification of the content or appearance of this document is unlawful and offenders may be prosecuted to the fullest extent of the law.
Attention: To check the authenticity of testing /inspection report & certificate, please contact us at telephone: (86-755) 8307 1443, or email: CN.Doccheck@sgs.com

ATTACHMENTS

Phthalates Testing Flow Chart

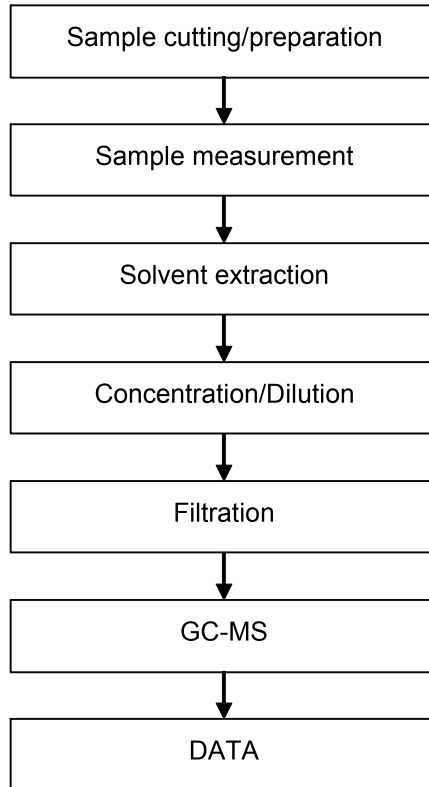

Unless otherwise agreed in writing, this document is issued by the Company subject to its General Conditions of Service printed overleaf, available on request or accessible at <http://www.sgs.com/en/Terms-and-Conditions.aspx> and, for electronic format documents, subject to Terms and Conditions for Electronic Documents at <http://www.sgs.com/en/Terms-and-Conditions/Terms-e-Documents.aspx>. Attention is drawn to the limitation of liability, indemnification and jurisdiction issues defined therein. Any holder of this document is advised that information contained hereon reflects the Company's findings at the time of its intervention only and within the limits of Client's instructions, if any. The Company's sole responsibility is to its Client and this document does not exonerate parties to a transaction from exercising all their rights and obligations under the transaction documents. This document cannot be reproduced except in full, without prior written approval of the Company. Any unauthorized alteration, forgery or falsification of the content or appearance of this document is unlawful and offenders may be prosecuted to the fullest extent of the law.
Attention: To check the authenticity of testing /inspection report & certificate, please contact us at telephone: (86-755) 8307 1443, or email: CN.Doccheck@sgs.com

ATTACHMENTS

Hexavalent Chromium (Cr(VI)) Testing Flow Chart

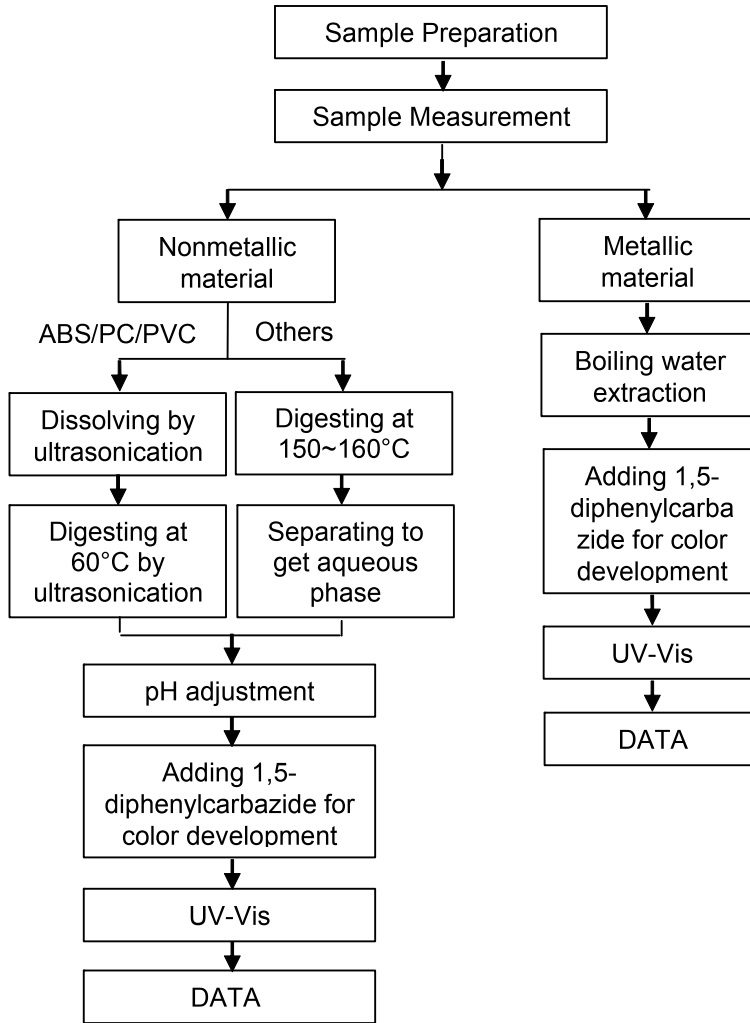

Unless otherwise agreed in writing, this document is issued by the Company subject to its General Conditions of Service printed overleaf, available on request or accessible at <http://www.sgs.com/en/Terms-and-Conditions.aspx> and, for electronic format documents, subject to Terms and Conditions for Electronic Documents at <http://www.sgs.com/en/Terms-and-Conditions/Terms-e-Documents.aspx>. Attention is drawn to the limitation of liability, indemnification and jurisdiction issues defined therein. Any holder of this document is advised that information contained hereon reflects the Company's findings at the time of its intervention only and within the limits of Client's instructions, if any. The Company's sole responsibility is to its Client and this document does not exonerate parties to a transaction from exercising all their rights and obligations under the transaction documents. This document cannot be reproduced except in full, without prior written approval of the Company. Any unauthorized alteration, forgery or falsification of the content or appearance of this document is unlawful and offenders may be prosecuted to the fullest extent of the law.
 Attention: To check the authenticity of testing /inspection report & certificate, please contact us at telephone: (86-755) 8307 1443, or email: CN.Doccheck@sgs.com

ATTACHMENTS

Elements (IEC62321) Testing Flow Chart

1) These samples were dissolved totally by pre-conditioning method according to below flow chart.

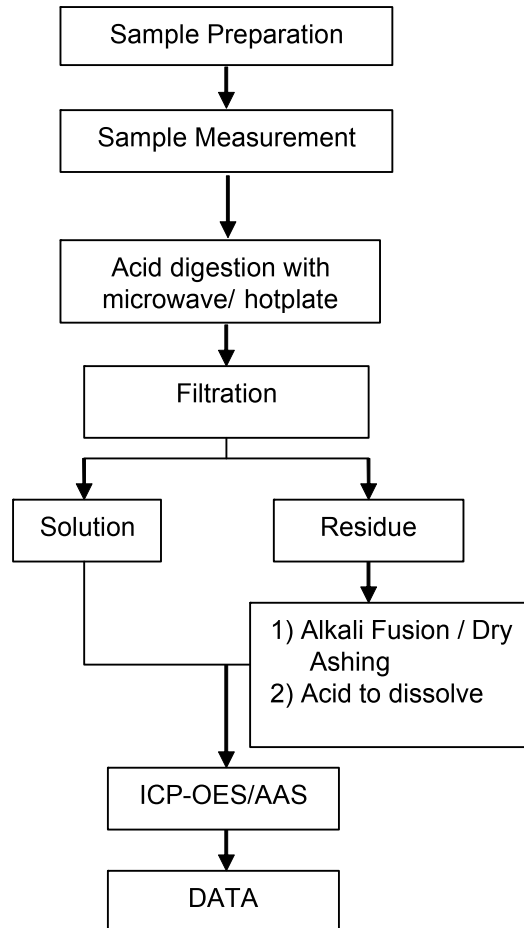

Unless otherwise agreed in writing, this document is issued by the Company subject to its General Conditions of Service printed overleaf, available on request or accessible at <http://www.sgs.com/en/Terms-and-Conditions.aspx> and, for electronic format documents, subject to Terms and Conditions for Electronic Documents at <http://www.sgs.com/en/Terms-and-Conditions/Terms-e-Documents.aspx>. Attention is drawn to the limitation of liability, indemnification and jurisdiction issues defined therein. Any holder of this document is advised that information contained hereon reflects the Company's findings at the time of its intervention only and within the limits of Client's instructions, if any. The Company's sole responsibility is to its Client and this document does not exonerate parties to a transaction from exercising all their rights and obligations under the transaction documents. This document cannot be reproduced except in full, without prior written approval of the Company. Any unauthorized alteration, forgery or falsification of the content or appearance of this document is unlawful and offenders may be prosecuted to the fullest extent of the law.
Attention: To check the authenticity of testing /inspection report & certificate, please contact us at telephone: (86-755) 8307 1443, or email: CN.Doccheck@sgs.com