



**中认信通**  
CHINA CERTIFICATION ICT CO., LTD (DONGGUAN)



# TEST REPORT

**Applicant: UBTECH ROBOTICS CORP LTD**

Address: Room 2201, Building C1 Nanshan Smart Park No. 1001 Xueyuan Avenue  
Changyuan Community Taoyuan Street Nanshan District Shenzhen PRC

**FCC ID: 2AHJX-XCAD101**

**Product Name: CadeBot-L100**

**Standard(s): 47 CFR Part 15, Subpart C(15.247)**

**ANSI C63.10-2013**

**KDB 558074 D01 15.247 Meas Guidance v05r02**

The above equipment has been tested and found compliant with the requirement of the relative standards by China Certification ICT Co., Ltd (Dongguan)

**Report Number: CR230418098-00C**

**Date Of Issue: 2023/6/17**

**Reviewed By: Julie Tan**

*Julie Tan*

Title: RF Engineer

**Approved By: Sun Zhong**

*Sun Zhong*

Title: Manager

**Test Laboratory: China Certification ICT Co., Ltd (Dongguan)**

No. 113, Pingkang Road, Dalang Town, Dongguan,

Guangdong, China

Tel: +86-769-82016888

## Test Facility

The Test site used by China Certification ICT Co., Ltd (Dongguan) to collect test data is located on the No. 113, Pingkang Road, Dalang Town, Dongguan, Guangdong, China.

The lab has been recognized as the FCC accredited lab under the KDB 974614 D01 and is listed in the FCC Public Access Link (PAL) database, FCC Registration No. : 442868, the FCC Designation No. : CN1314.

The lab has been recognized by Innovation, Science and Economic Development Canada to test to Canadian radio equipment requirements, the CAB identifier: CN0123.

## Declarations

China Certification ICT Co., Ltd (Dongguan) is not responsible for the authenticity of any test data provided by the applicant. Data included from the applicant that may affect test results are marked with a triangle symbol “▲”. Customer model name, addresses, names, trademarks etc. are not considered data.

Unless otherwise stated the results shown in this test report refer only to the sample(s) tested.

This report cannot be reproduced except in full, without prior written approval of the Company.

This report is valid only with a valid digital signature. The digital signature may be available only under the Adobe software above version 7.0.

This report may contain data that are not covered by the accreditation scope and shall be marked with an asterisk “★”.

# CONTENTS

<b>TEST FACILITY .....</b>	<b>2</b>
<b>DECLARATIONS.....</b>	<b>2</b>
<b>DOCUMENT REVISION HISTORY .....</b>	<b>5</b>
<b>1. GENERAL INFORMATION .....</b>	<b>6</b>
<b>1.1 PRODUCT DESCRIPTION FOR EQUIPMENT UNDER TEST (EUT) .....</b>	<b>6</b>
<b>1.2 DESCRIPTION OF TEST CONFIGURATION.....</b>	<b>8</b>
1.2.1 EUT Operation Condition: .....	8
1.2.2 Support Equipment List and Details .....	8
1.2.3 Support Cable List and Details .....	8
1.2.4 Block Diagram of Test Setup.....	9
<b>1.3 MEASUREMENT UNCERTAINTY .....</b>	<b>11</b>
<b>2. SUMMARY OF TEST RESULTS .....</b>	<b>12</b>
<b>3. REQUIREMENTS AND TEST PROCEDURES .....</b>	<b>13</b>
<b>3.1 AC LINE CONDUCTED EMISSIONS.....</b>	<b>13</b>
3.1.1 Applicable Standard.....	13
3.1.2 EUT Setup.....	14
3.1.3 EMI Test Receiver Setup .....	14
3.1.4 Test Procedure .....	15
3.1.5 Corrected Amplitude & Margin Calculation.....	15
<b>3.2 RADIATION SPURIOUS EMISSIONS.....</b>	<b>16</b>
3.2.1 Applicable Standard.....	16
3.2.2 EUT Setup.....	16
3.2.3 EMI Test Receiver & Spectrum Analyzer Setup .....	17
3.2.4 Test Procedure .....	17
3.2.5 Corrected Amplitude & Margin Calculation.....	17
<b>3.3 MINIMUM 6 dB EMISSION BANDWIDTH .....</b>	<b>18</b>
3.3.1 Applicable Standard.....	18
3.3.2 EUT Setup.....	18
3.3.3 Test Procedure .....	18
<b>3.4 99% OCCUPIED BANDWIDTH.....</b>	<b>19</b>
3.4.1 EUT Setup.....	19
3.4.2 Test Procedure .....	19
<b>3.5 MAXIMUM CONDUCTED OUTPUT POWER.....</b>	<b>20</b>
3.5.1 Applicable Standard.....	20
3.5.2 EUT Setup.....	20
3.5.3 Test Procedure .....	20
<b>3.6 MAXIMUM POWER SPECTRAL DENSITY .....</b>	<b>21</b>
3.6.1 Applicable Standard.....	21
3.6.2 EUT Setup.....	21
3.6.3 Test Procedure .....	21
<b>3.7 100 KHZ BANDWIDTH OF FREQUENCY BAND EDGE.....</b>	<b>22</b>

3.7.1 Applicable Standard.....	22
3.7.2 EUT Setup.....	22
3.7.3 Test Procedure .....	22
<b>3.8 DUTY CYCLE .....</b>	<b>23</b>
3.8.1 EUT Setup.....	23
3.8.2 Test Procedure .....	23
<b>3.9 ANTENNA REQUIREMENT.....</b>	<b>23</b>
3.9.1 Applicable Standard.....	23
3.9.2 Judgment.....	23
<b>4. Test DATA AND RESULTS .....</b>	<b>24</b>
<b>4.1 AC LINE CONDUCTED EMISSIONS.....</b>	<b>24</b>
<b>4.2 RADIATION SPURIOUS EMISSIONS .....</b>	<b>27</b>
<b>4.3 MINIMUM 6 dB EMISSION BANDWIDTH: .....</b>	<b>35</b>
<b>4.4 99% OCCUPIED BANDWIDTH: .....</b>	<b>39</b>
<b>4.5 MAXIMUM CONDUCTED OUTPUT POWER: .....</b>	<b>43</b>
<b>4.6 MAXIMUM POWER SPECTRAL DENSITY: .....</b>	<b>44</b>
<b>4.7 100 KHZ BANDWIDTH OF FREQUENCY BAND EDGE: .....</b>	<b>48</b>
<b>4.8 DUTY CYCLE:.....</b>	<b>52</b>

---

## DOCUMENT REVISION HISTORY

---

Revision Number	Report Number	Description of Revision	Date of Revision
1.0	CR230418098-00C	Original Report	2023/6/17

## 1. GENERAL INFORMATION

### 1.1 Product Description for Equipment under Test (EUT)

<b>EUT Name:</b>	CadeBot-L100
<b>EUT Model:</b>	XCAD101
<b>Operation Frequency:</b>	2412-2462MHz(802.11b/g/n ht20)
<b>Maximum Average Output Power (Conducted):</b>	17.35dBm(802.11b/g/n)
<b>Modulation Type:</b>	802.11b:DSSS-DBPSK, DQPSK, CCK 802.11g/n:OFDM-BPSK, QPSK, 16QAM, 64QAM
<b>Rated Input Voltage:</b>	DC 25.41V from Battery or DC 29.4V from Adapter/Charger
<b>Serial Number:</b>	24DY-1
<b>EUT Received Date:</b>	2023/4/14
<b>EUT Received Status:</b>	Good

#### Operation Frequency Detail: For 802.11b/g/n ht20:

Channel	Frequency (MHz)	Channel	Frequency (MHz)
1	2412	7	2442
2	2417	8	2447
3	2422	9	2452
4	2427	10	2457
5	2432	11	2462
6	2437	/	/

Per section 15.31(m), the below frequencies were performed the test as below:

Test Channel	Frequency (MHz)
Lowest	2412
Middle	2437
Highest	2462

#### Antenna Information Detail ▲ :

Antenna Manufacturer	Antenna Type	input impedance (Ohm)	Frequency Range	Antenna Gain
DONGGUAN SLEing INTEL-TECH CO.,LTD	FPC	50	2.4~2.5GHz	4.45 dBi

The Method of §15.203 Compliance:

- Antenna must be permanently attached to the unit.
- Antenna must use a unique type of connector to attach to the EUT.
- Unit must be professionally installed, and installer shall be responsible for verifying that the correct antenna is employed with the unit.

**Accessory Information:**

<b>Accessory Description</b>	<b>Manufacturer</b>	<b>Model</b>	<b>Parameters</b>
Adapter	Unknown	AP-PN180CH02940060	Input: 100-240Vac, 50/60Hz, 3.0A Output: 29.4Vdc, 6.0A, 176.4W
Charger	UBTECH	Unknown	Unknown

## 1.2 Description of Test Configuration

### 1.2.1 EUT Operation Condition:

For 802.11b/g/n:

<b>EUT Operation Mode:</b>	The system was configured for testing in Engineering Mode, which was provided by the manufacturer. The device can be charged by Adapter or Charger, Per test for 15B report, the worst is Charged by adapter, therefore only charged by adapter mode was tested for this report.			
<b>Equipment Modifications:</b>	No			
<b>EUT Exercise Software:</b>	CMD			
The software was provided by manufacturer. The maximum power was configured as below, that was provided by the manufacturer ▲:				
Test Modes	Data Rate	Power Level Setting		
		Lowest Channel	Middle Channel	Highest Channel
802.11b	1Mbps	17	17	17
802.11g	6Mbps	15	15	15
802.11n ht20	MCS0	15	15	15
The above are the worst-case data rates, which are determined for each mode based upon investigations by measuring the average power and PSD across all data rates, bandwidths, and modulations.				

### 1.2.2 Support Equipment List and Details

Manufacturer	Description	Model	Serial Number
SanDisk	USB Disk	16 GB	BL201026210Z

### 1.2.3 Support Cable List and Details

Cable Description	Shielding Type	Ferrite Core	Length (m)	From Port	To
DC Cable	YES	No	1.5	Adapter	EUT



### 1.2.4 Block Diagram of Test Setup

AC line conducted emissions:

AC line conducted emissions:

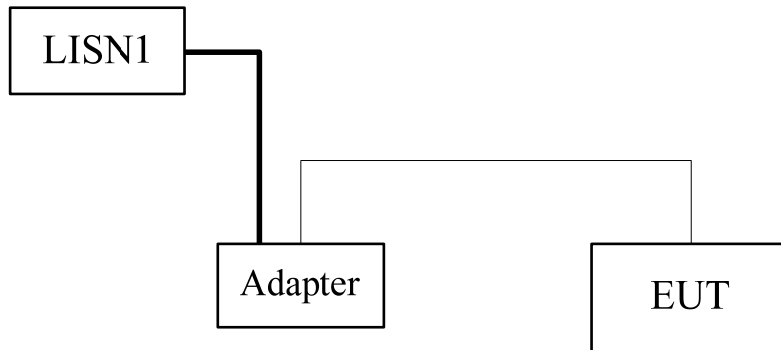

Radiated Spurious Emissions:

Below 1GHz:

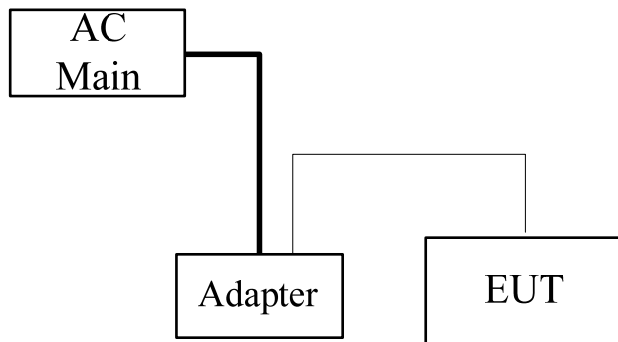

Above 1GHz:

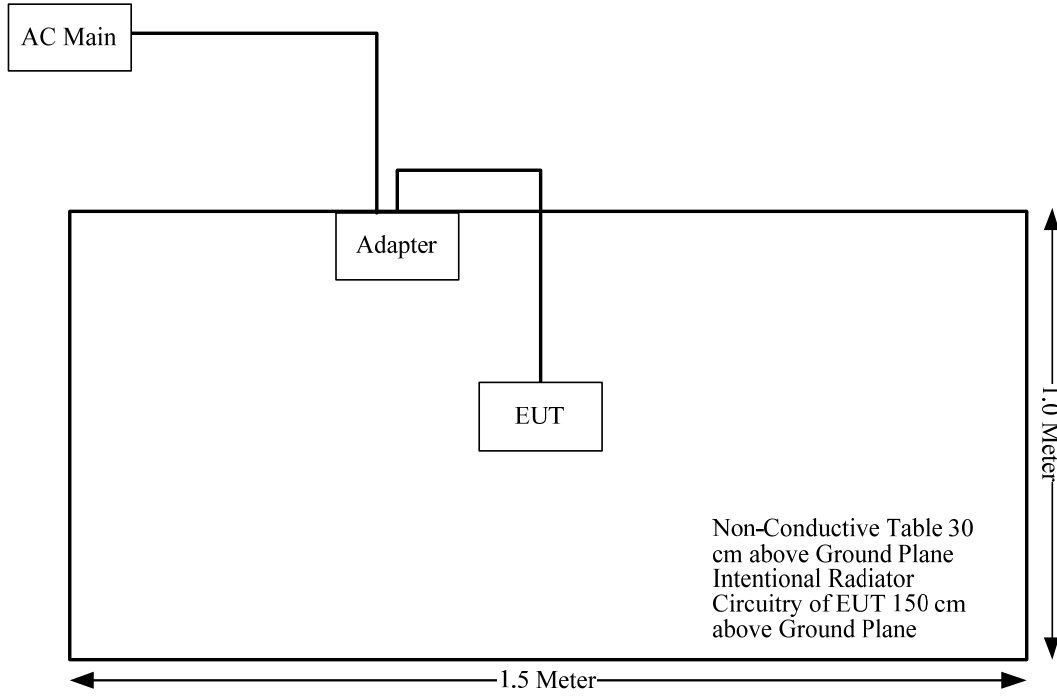

### 1.3 Measurement Uncertainty

Otherwise required by the applicant or Product Regulations, Decision Rule in this report did not consider the uncertainty. The extended uncertainty given in this report is obtained by combining the standard uncertainty times the coverage factor K with the 95% confidence interval.

Parameter	Measurement Uncertainty
Occupied Channel Bandwidth	±5 %
RF output power, conducted	±0.61dB
Power Spectral Density, conducted	±0.61 dB
Unwanted Emissions, radiated	30M~200MHz: 4.15 dB,200M~1GHz: 5.61 dB,1G~6GHz: 5.14 dB, 6G~18GHz: 5.93 dB,18G~26.5G:5.47 dB,26.5G~40G:5.63 dB
Unwanted Emissions, conducted	±1.26 dB
Temperature	±1 °C
Humidity	±5%
DC and low frequency voltages	±0.4%
Duty Cycle	1%
AC Power Lines Conducted Emission	2.8 dB (150 kHz to 30 MHz)

## 2. SUMMARY OF TEST RESULTS

Standard(s) Section	Test Items	Result
§15.207(a)	AC Line Conducted Emissions	Compliant
§15.205, §15.209, §15.247(d)	Spurious Emissions	Compliant
§15.247 (a)(2)	Minimum 6 dB Bandwidth	Compliant
§15.247(b)(3)	Maximum Conducted Output Power	Compliant
§15.247(d)	100 kHz Bandwidth Of Frequency Band Edge	Compliant
§15.247(e)	Power Spectral Density	Compliant
§15.203	Antenna Requirement	Compliant

### 3. REQUIREMENTS AND TEST PROCEDURES

#### 3.1 AC Line Conducted Emissions

##### 3.1.1 Applicable Standard

FCC§15.207(a).

(a) Except as shown in paragraphs (b) and (c) of this section, for an intentional radiator that is designed to be connected to the public utility (AC) power line, the radio frequency voltage that is conducted back onto the AC power line on any frequency or frequencies, within the band 150 kHz to 30 MHz, shall not exceed the limits in the following table, as measured using a 50  $\mu$ H/50 ohms line impedance stabilization network (LISN). Compliance with the provisions of this paragraph shall be based on the measurement of the radio frequency voltage between each power line and ground at the power terminal. The lower limit applies at the boundary between the frequency ranges.

Frequency of emission (MHz)	Conducted limit (dB $\mu$ V)	
	Quasi-peak	Average
0.15-0.5	66 to 56*	56 to 46*
0.5-5	56	46
5-30	60	50

\*Decreases with the logarithm of the frequency.

(b) The limit shown in paragraph (a) of this section shall not apply to carrier current systems operating as intentional radiators on frequencies below 30 MHz. In lieu thereof, these carrier current systems shall be subject to the following standards:

(1) For carrier current system containing their fundamental emission within the frequency band 535-1705 kHz and intended to be received using a standard AM broadcast receiver: no limit on conducted emissions.

(2) For all other carrier current systems: 1000  $\mu$ V within the frequency band 535-1705 kHz, as measured using a 50  $\mu$ H/50 ohms LISN.

(3) Carrier current systems operating below 30 MHz are also subject to the radiated emission limits in §15.205, §15.209, §15.221, §15.223, or §15.227, as appropriate.

(c) Measurements to demonstrate compliance with the conducted limits are not required for devices which only employ battery power for operation and which do not operate from the AC power lines or contain provisions for operation while connected to the AC power lines. Devices that include, or make provisions for, the use of battery chargers which permit operating while charging, AC adapters or battery eliminators or that connect to the AC power lines indirectly, obtaining their power through another device which is connected to the AC power lines, shall be tested to demonstrate compliance with the conducted limits.

### 3.1.2 EUT Setup

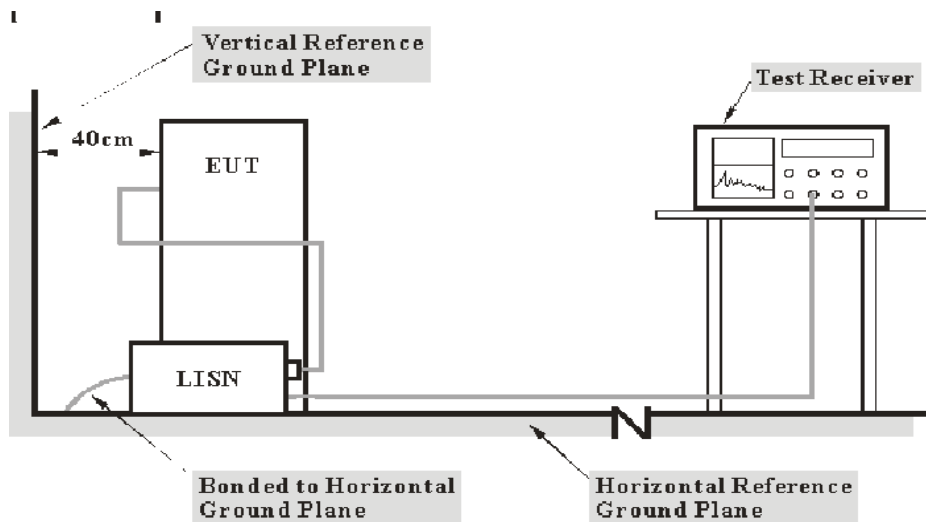

- Note: 1. Support units were connected to second LISN.  
 2. Both of LISNs (AMN) 80 cm from EUT and at the least 80 cm from other units and other metal planes support units.

The setup of EUT is according with per ANSI C63.10-2013 measurement procedure. The specification used was with the FCC Part 15.207 limits.

The spacing between the peripherals was 10 cm.

The adapter or EUT was connected to the main LISN with a 120 V/60 Hz AC power source.

### 3.1.3 EMI Test Receiver Setup

The EMI test receiver was set to investigate the spectrum from 150 kHz to 30 MHz.

During the conducted emission test, the EMI test receiver was set with the following configurations:

Frequency Range	IF B/W
150 kHz – 30 MHz	9 kHz

### 3.1.4 Test Procedure

The frequency and amplitude of the six highest ac power-line conducted emissions relative to the limit, measured over all the current-carrying conductors of the EUT power cords, and the operating frequency or frequency to which the EUT is tuned (if appropriate), should be reported, unless such emissions are more than 20 dB below the limit. AC power-line conducted emissions measurements are to be separately carried out only on each of the phase (“hot”) line(s) and (if used) on the neutral line(s), but not on the ground [protective earth] line(s). If less than six emission frequencies are within 20 dB of the limit, then the noise level of the measuring instrument at representative frequencies should be reported. The specific conductor of the power-line cord for each of the reported emissions should be identified. Measure the six highest emissions with respect to the limit on each current-carrying conductor of each power cord associated with the EUT (but not the power cords of associated or peripheral equipment that are part of the test configuration). Then, report the six highest emissions with respect to the limit from among all the measurements identifying the frequency and specific current-carrying conductor identified with the emission. The six highest emissions should be reported for each of the current-carrying conductors, or the six highest emissions may be reported over all the current-carrying conductors.

### 3.1.5 Corrected Amplitude & Margin Calculation

The basic equation is as follows:

Result = Reading + Factor

Factor = attenuation caused by cable loss + voltage division factor of AMN

The “**Margin**” column of the following data tables indicates the degree of compliance within the applicable limit. The equation for margin calculation is as follows:

Margin = Limit – Result

## 3.2 Radiation Spurious Emissions

### 3.2.1 Applicable Standard

FCC §15.247 (d);

In any 100 kHz bandwidth outside the frequency band in which the spread spectrum or digitally modulated intentional radiator is operating, the radio frequency power that is produced by the intentional radiator shall be at least 20 dB below that in the 100 kHz bandwidth within the band that contains the highest level of the desired power, based on either an RF conducted or a radiated measurement, provided the transmitter demonstrates compliance with the peak conducted power limits. If the transmitter complies with the conducted power limits based on the use of RMS averaging over a time interval, as permitted under paragraph (b)(3) of this section, the attenuation required under this paragraph shall be 30 dB instead of 20 dB. Attenuation below the general limits specified in §15.209(a) is not required. In addition, radiated emissions which fall in the restricted bands, as defined in §15.205(a), must also comply with the radiated emission limits specified in §15.209(a) (see §15.205(c)).

### 3.2.2 EUT Setup

**Below 1GHz:**

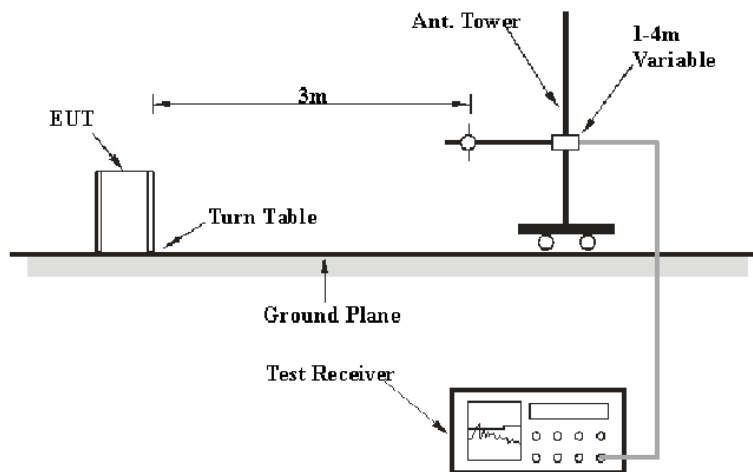

**Above 1GHz:**

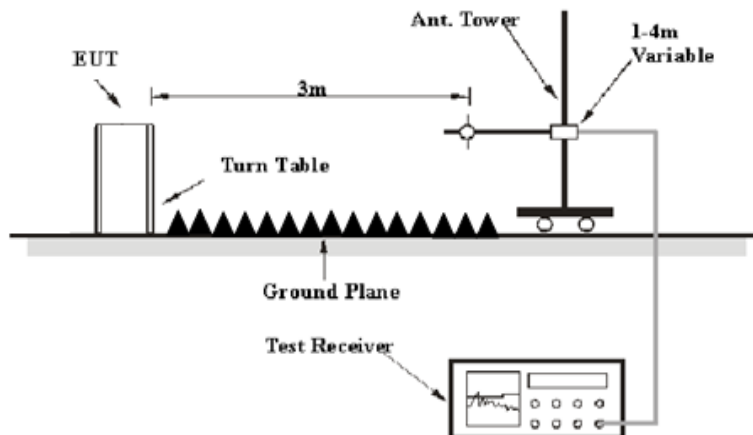



The radiated emissions were performed in the 3 meters distance, using the setup accordance with the ANSI C63.10-2013. The specification used was the FCC 15.209, and FCC 15.247 limits.

The external I/O cables were draped along the test table and formed a bundle 30 to 40 cm long in the middle.

The spacing between the peripherals was 10 cm.

### 3.2.3 EMI Test Receiver & Spectrum Analyzer Setup

The system was investigated from 30 MHz to 25 GHz.

During the radiated emission test, the EMI test receiver & Spectrum Analyzer Setup were set with the following configurations:

30-1000MHz:

Measurement	RBW	Video B/W	IF B/W
QP	120 kHz	300 kHz	120kHz

1GHz- 25GHz:

Measurement	Duty cycle	RBW	Video B/W
PK	Any	1MHz	3 MHz
Ave.	>98%	1MHz	10 Hz
	<98%	1MHz	1/T

Note: T is minimum transmission duration

If the maximized peak measured value complies with under the QP/Average limit more than 6dB, then it is unnecessary to perform an QP/Average measurement.

### 3.2.4 Test Procedure

Maximizing procedure was performed on the highest emissions to ensure that the EUT complied with all installation combinations.

Data was recorded in Quasi-peak detection mode for frequency range of 30 MHz-1 GHz, peak and Average detection modes for frequencies above 1 GHz.

### 3.2.5 Corrected Amplitude & Margin Calculation

The basic equation is as follows:

Result = Reading + Factor

Factor = Antenna Factor + Cable Loss- Amplifier Gain

The “**Margin**” column of the following data tables indicates the degree of compliance within the applicable limit. The equation for margin calculation is as follows:

Margin = Limit – Result

### 3.3 Minimum 6 dB Emission Bandwidth

#### 3.3.1 Applicable Standard

FCC §15.247 (a)(2)

Systems using digital modulation techniques may operate in the 902-928 MHz, 2400-2483.5 MHz, and 5725-5850 MHz bands. The minimum 6 dB bandwidth shall be at least 500 kHz.

#### 3.3.2 EUT Setup

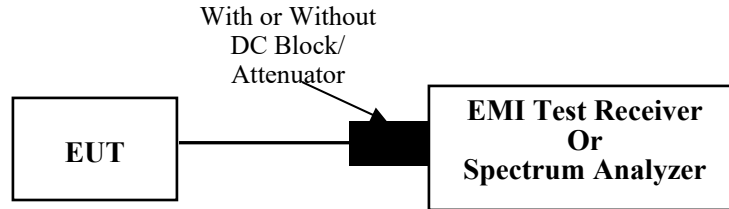

#### 3.3.3 Test Procedure

According to ANSI C63.10-2013 Section 11.8

- a) Set RBW = 100 kHz.
- b) Set the video bandwidth (VBW)  $\geq 3 \times$  RBW.
- c) Detector = Peak.
- d) Trace mode = max hold.
- e) Sweep = auto couple.
- f) Allow the trace to stabilize.
- g) Measure the maximum width of the emission that is constrained by the frequencies associated with the two outermost amplitude points (upper and lower frequencies) that are attenuated by 6 dB relative to the maximum level measured in the fundamental emission.

## 3.4 99% Occupied Bandwidth

### 3.4.1 EUT Setup

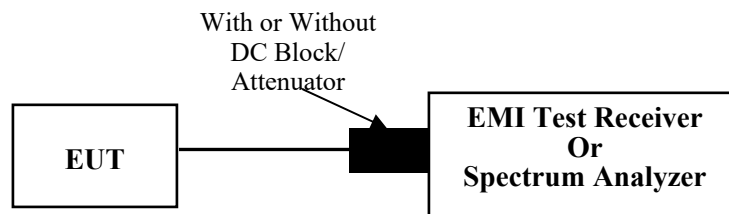

### 3.4.2 Test Procedure

According to ANSI C63.10-2013 Section 6.9.3

The occupied bandwidth is the frequency bandwidth such that, below its lower and above its upper frequency limits, the mean powers are each equal to 0.5% of the total mean power of the given emission. The following procedure shall be used for measuring 99% power bandwidth:

- a) The instrument center frequency is set to the nominal EUT channel center frequency. The frequency span for the spectrum analyzer shall be between 1.5 times and 5.0 times the OBW.
- b) The nominal IF filter bandwidth (3 dB RBW) shall be in the range of 1% to 5% of the OBW, and VBW shall be approximately three times the RBW, unless otherwise specified by the applicable requirement.
- c) Set the reference level of the instrument as required, keeping the signal from exceeding the maximum input mixer level for linear operation. In general, the peak of the spectral envelope shall be more than  $[10 \log (OBW/RBW)]$  below the reference level. Specific guidance is given in 4.1.5.2.
- d) Step a) through step c) might require iteration to adjust within the specified range.
- e) Video averaging is not permitted. Where practical, a sample detection and single sweep mode shall be used. Otherwise, peak detection and max hold mode (until the trace stabilizes) shall be used.
- f) Use the 99% power bandwidth function of the instrument (if available) and report the measured bandwidth.
- g) If the instrument does not have a 99% power bandwidth function, then the trace data points are recovered and directly summed in linear power terms. The recovered amplitude data points, beginning at the lowest frequency, are placed in a running sum until 0.5% of the total is reached; that frequency is recorded as the lower frequency. The process is repeated until 99.5% of the total is reached; that frequency is recorded as the upper frequency. The 99% power bandwidth is the difference between these two frequencies.
- h) The occupied bandwidth shall be reported by providing plot(s) of the measuring instrument display; the plot axes and the scale units per division shall be clearly labeled. Tabular data may be reported in addition to the plot(s).

### 3.5 Maximum Conducted Output Power

#### 3.5.1 Applicable Standard

FCC §15.247 (b)(3)

For systems using digital modulation in the 902-928 MHz, 2400-2483.5 MHz, and 5725-5850 MHz bands: 1 Watt. As an alternative to a peak power measurement, compliance with the one Watt limit can be based on a measurement of the maximum conducted output power. Maximum Conducted Output Power is defined as the total transmit power delivered to all antennas and antenna elements averaged across all symbols in the signaling alphabet when the transmitter is operating at its maximum power control level. Power must be summed across all antennas and antenna elements. The average must not include any time intervals during which the transmitter is off or is transmitting at a reduced power level. If multiple modes of operation are possible (e.g., alternative modulation methods), the maximum conducted output power is the highest total transmit power occurring in any mode.

#### 3.5.2 EUT Setup

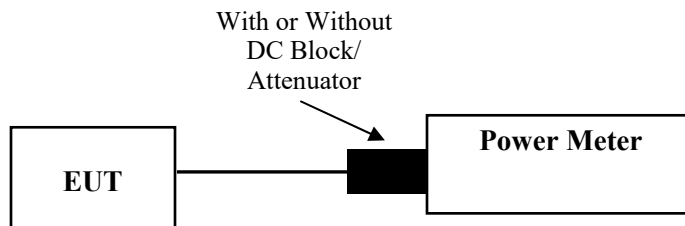

#### 3.5.3 Test Procedure

According to ANSI C63.10-2013 Section 11.9.2.3.2

Method AVGPM-G is a measurement using a gated RF average power meter.

Alternatively, measurements may be performed using a wideband gated RF power meter provided that the gate parameters are adjusted such that the power is measured only when the EUT is transmitting at its maximum power control level. Because the measurement is made only during the ON time of the transmitter, no duty cycle correction factor is required.

### 3.6 Maximum Power Spectral Density

#### 3.6.1 Applicable Standard

FCC §15.247 (e)

For digitally modulated systems, the power spectral density conducted from the intentional radiator to the antenna shall not be greater than 8 dBm in any 3 kHz band during any time interval of continuous transmission. This power spectral density shall be determined in accordance with the provisions of paragraph (b) of this section. The same method of determining the conducted output power shall be used to determine the power spectral density.

#### 3.6.2 EUT Setup

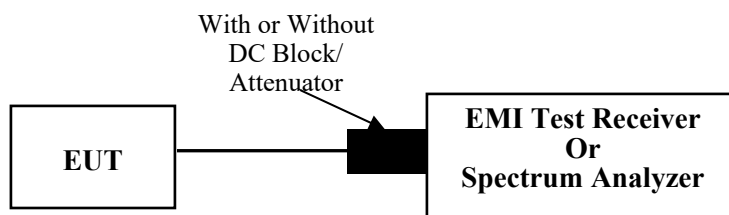

#### 3.6.3 Test Procedure

**Duty cycle  $\geq 98\%$**

According to ANSI C63.10-2013 Section 11.10.3

**Duty cycle  $< 98\%$ , duty cycle variations are less than  $\pm 2\%$**

According to ANSI C63.10-2013 Section 11.10.5

**Duty cycle  $< 98\%$ , duty cycle variations exceed  $\pm 2\%$**

According to ANSI C63.10-2013 Section 11.10.7

### 3.7 100 kHz Bandwidth of Frequency Band Edge

#### 3.7.1 Applicable Standard

FCC §15.247 (d);

In any 100 kHz bandwidth outside the frequency band in which the spread spectrum or digitally modulated intentional radiator is operating, the radio frequency power that is produced by the intentional radiator shall be at least 20 dB below that in the 100 kHz bandwidth within the band that contains the highest level of the desired power, based on either an RF conducted or a radiated measurement, provided the transmitter demonstrates compliance with the peak conducted power limits. If the transmitter complies with the conducted power limits based on the use of RMS averaging over a time interval, as permitted under paragraph (b)(3) of this section, the attenuation required under this paragraph shall be 30 dB instead of 20 dB. Attenuation below the general limits specified in §15.209(a) is not required. In addition, radiated emissions which fall in the restricted bands, as defined in §15.205(a), must also comply with the radiated emission limits specified in §15.209(a) (see §15.205(c)).

#### 3.7.2 EUT Setup

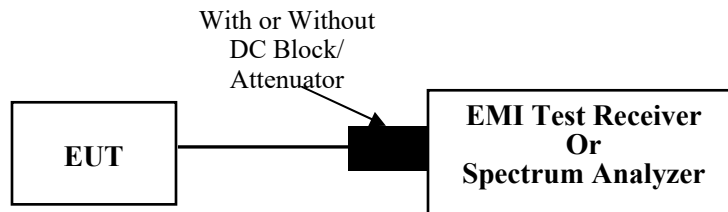

#### 3.7.3 Test Procedure

According to ANSI C63.10-2013 Section 11.11

- a) Set the center frequency and span to encompass frequency range to be measured.
- b) Set the RBW = 100 kHz.
- c) Set the VBW  $\geq [3 \times \text{RBW}]$ .
- d) Detector = peak.
- e) Sweep time = auto couple.
- f) Trace mode = max hold.
- g) Allow trace to fully stabilize.
- h) Use the peak marker function to determine the maximum amplitude level.

Ensure that the amplitude of all unwanted emissions outside of the authorized frequency band (excluding restricted frequency bands) is attenuated by at least the minimum requirements specified in 11.11. Report the three highest emissions relative to the limit.

### 3.8 Duty Cycle

#### 3.8.1 EUT Setup

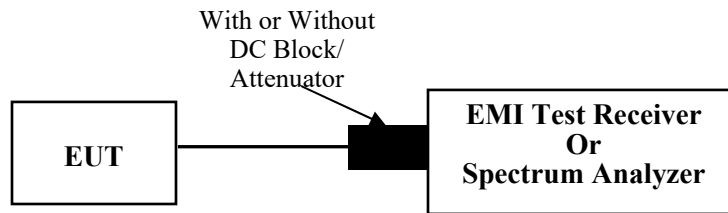

#### 3.8.2 Test Procedure

According to ANSI C63.10-2013 Section 11.6

The zero-span mode on a spectrum analyzer or EMI receiver if the response time and spacing between bins on the sweep are sufficient to permit accurate measurements of the ON and OFF times of the transmitted signal:

- 1) Set the center frequency of the instrument to the center frequency of the transmission.
- 2) Set  $RBW \geq OBW$  if possible; otherwise, set RBW to the largest available value.
- 3) Set  $VBW \geq RBW$ . Set detector = peak or average.
- 4) The zero-span measurement method shall not be used unless both RBW and VBW are  $> 50/T$  and the number of sweep points across duration T exceeds 100. (For example, if VBW and/or RBW are limited to 3 MHz, then the zero-span method of measuring the duty cycle shall not be used if  $T \leq 16.7 \mu s$ .)

### 3.9 Antenna Requirement

#### 3.9.1 Applicable Standard

FCC §15.203

An intentional radiator shall be designed to ensure that no antenna other than that furnished by the responsible party shall be used with the device. The use of a permanently attached antenna or of an antenna that uses a unique coupling to the intentional radiator shall be considered sufficient to comply with the provisions of this section. The manufacturer may design the unit so that a broken antenna can be replaced by the user, but the use of a standard antenna jack or electrical connector is prohibited. This requirement does not apply to carrier current devices or to devices operated under the provisions of §§15.211, 15.213, 15.217, 15.219, 15.221, or §15.236. Further, this requirement does not apply to intentional radiators that must be professionally installed, such as perimeter protection systems and some field disturbance sensors, or to other intentional radiators which, in accordance with §15.31(d), must be measured at the installation site. However, the installer shall be responsible for ensuring that the proper antenna is employed so that the limits in this part are not exceeded.

#### 3.9.2 Judgment

**Compliant.** Please refer to the Antenna Information detail in Section 1.

## 4. Test DATA AND RESULTS

### 4.1 AC Line Conducted Emissions

Serial Number:	24DY-1	Test Date:	2023/05/31
Test Site:	CE	Test Mode:	Transmitting (802.11b mode Middle channel was the worst)
Tester:	David Huang		Pass

#### Environmental Conditions:

Temperature: (°C)	24.8	Relative Humidity: (%)	68	ATM Pressure: (kPa)	101.5
----------------------	------	---------------------------	----	------------------------	-------

#### Test Equipment List and Details:

Manufacturer	Description	Model	Serial Number	Calibration Date	Calibration Due Date
R&S	LISN	ENV216	101134	2023/03/31	2024/03/30
R&S	EMI Test Receiver	ESR3	102726	2022/07/15	2023/07/14
MICRO-COAX	Coaxial Cable	UTIFLEX	C-0200-01	2022/08/07	2023/08/06
Audix	Test Software	E3	190306 (V9)	N/A	N/A

\* Statement of Traceability: China Certification ICT Co., Ltd (Dongguan) attests that all calibrations have been performed, traceable to National Primary Standards and International System of Units (SI).



Test Mode: Transmitting  
 Port: Line  
 Note:

Date: 2023-05-31

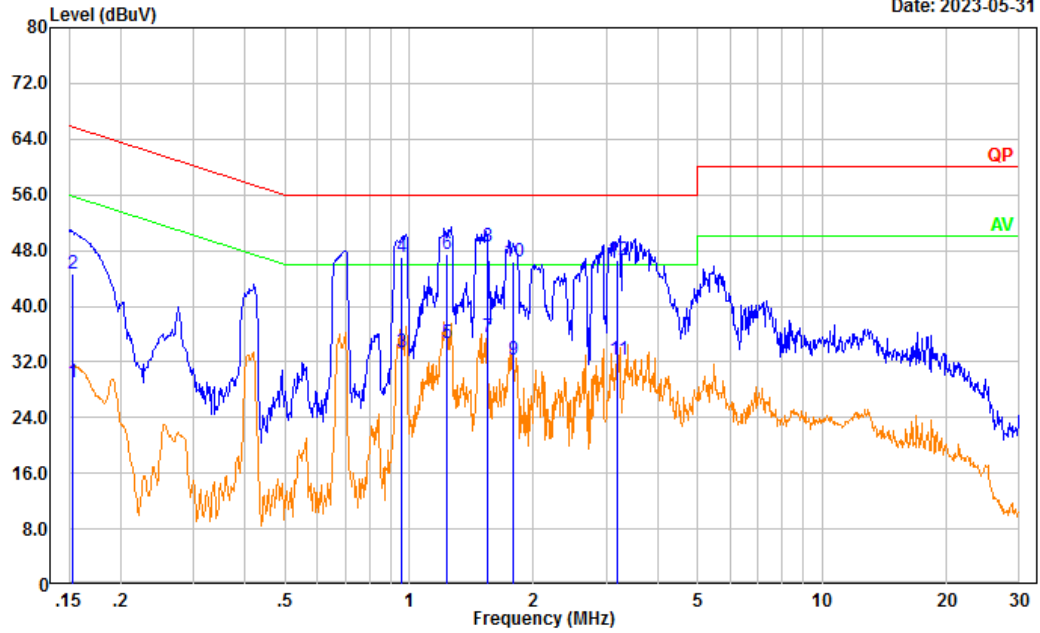

No.	Frequency (MHz)	Reading (dBμV)	Factor (dB)	Result (dBμV)	Limit (dBμV)	Margin (dB)	Detector
1	0.153	19.52	9.61	29.13	55.83	26.70	Average
2	0.153	35.09	9.61	44.70	65.83	21.13	QP
3	0.956	23.77	9.62	33.39	46.00	12.61	Average
4	0.956	37.36	9.62	46.98	56.00	9.02	QP
5	1.229	25.17	9.62	34.79	46.00	11.21	Average
6	1.229	37.95	9.62	47.57	56.00	8.43	QP
7	1.542	25.94	9.63	35.57	46.00	10.43	Average
8	1.542	38.86	9.63	48.49	56.00	7.51	QP
9	1.782	22.75	9.63	32.38	46.00	13.62	Average
10	1.782	36.70	9.63	46.33	56.00	9.67	QP
11	3.203	22.63	9.65	32.28	46.00	13.72	Average
12	3.203	36.90	9.65	46.55	56.00	9.45	QP

Test Mode: Transmitting  
 Port: neutral  
 Note:

Date: 2023-05-31

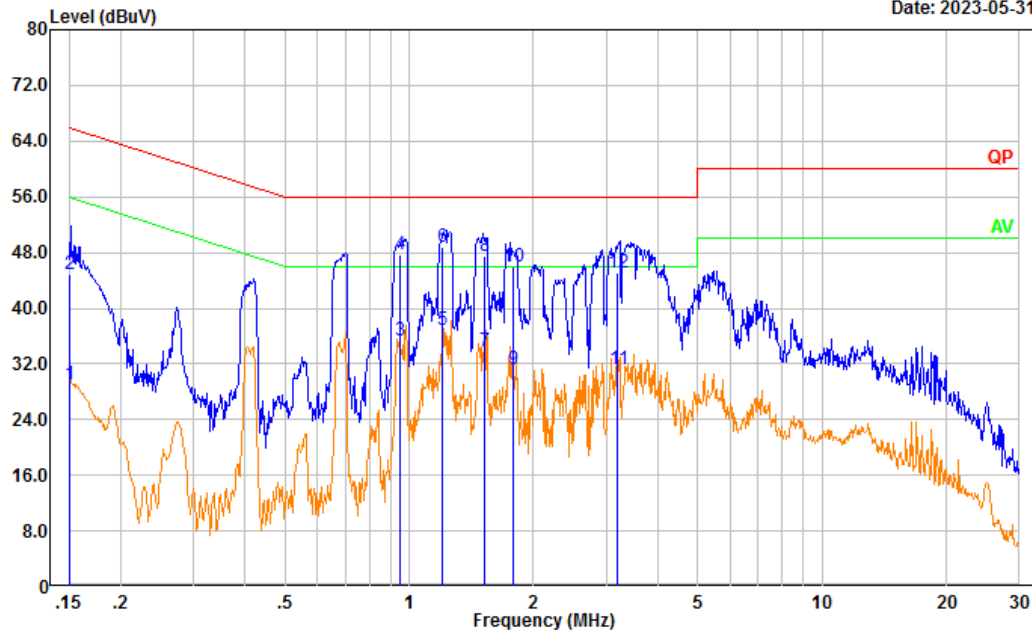

No.	Frequency (MHz)	Reading (dBμV)	Factor (dB)	Result (dBμV)	Limit (dBμV)	Margin (dB)	Detector
1	0.151	19.54	9.61	29.15	55.95	26.80	Average
2	0.151	35.19	9.61	44.80	65.95	21.15	QP
3	0.951	25.69	9.62	35.31	46.00	10.69	Average
4	0.951	38.09	9.62	47.71	56.00	8.29	QP
5	1.203	27.34	9.62	36.96	46.00	9.04	Average
6	1.203	39.14	9.62	48.76	56.00	7.24	QP
7	1.516	24.16	9.63	33.79	46.00	12.21	Average
8	1.516	37.95	9.63	47.58	56.00	8.42	QP
9	1.784	21.52	9.63	31.15	46.00	14.85	Average
10	1.784	36.28	9.63	45.91	56.00	10.09	QP
11	3.198	21.53	9.65	31.18	46.00	14.82	Average
12	3.198	35.55	9.65	45.20	56.00	10.80	QP

## 4.2 Radiation Spurious Emissions

Serial Number:	24DY-1	Test Date:	2023/06/06~2023/06/09
Test Site:	966-1/966-2	Test Mode:	Transmitting
Tester:	Vic Du, Mack Huang	Test Result:	Pass

### Environmental Conditions:

Temperature: (°C)	24.1~27	Relative Humidity: (%)	60~67	ATM Pressure: (kPa)	99.9~100.2
----------------------	---------	------------------------------	-------	------------------------	------------

### Test Equipment List and Details:

Manufacturer	Description	Model	Serial Number	Calibration Date	Calibration Due Date
Sunol Sciences	Antenna	JB6	A082520-5	2020/10/19	2023/10/18
R&S	EMI Test Receiver	ESR3	102724	2022/07/15	2023/07/14
TIMES MICROWAVE	Coaxial Cable	LMR-600-UltraFlex	C-0470-02	2022/07/17	2023/07/16
TIMES MICROWAVE	Coaxial Cable	LMR-600-UltraFlex	C-0780-01	2022/07/17	2023/07/16
Sonoma	Amplifier	310N	186165	2022/07/17	2023/07/16
Audix	Test Software	E3	201021 (V9)	N/A	N/A
ETS-Lindgren	Horn Antenna	3115	9912-5985	2020/10/13	2023/10/12
R&S	Spectrum Analyzer	FSV40	101591	2022/07/15	2023/07/14
MICRO-COAX	Coaxial Cable	UFA210A-1-1200-70U300	217423-008	2022/08/07	2023/08/06
MICRO-COAX	Coaxial Cable	UFA210A-1-2362-300300	235780-001	2022/08/07	2023/08/06
Mini	Pre-amplifier	ZVA-183-S+	5969001149	2022/11/09	2023/11/08
PASTERNAK	Horn Antenna	PE9852/2F-20	112002	2021/02/05	2024/02/04
Quinstar	Preamplifier	QLW-18405536-JO	15964001005	2022/09/16	2023/09/15
MICRO-COAX	Coaxial Cable	UFB142A-1-2362-200200	235772-001	2022/08/07	2023/08/06
E-Microwave	Band Rejection Filter	2400-2483.5MHz	OE01902424	2022/08/07	2023/08/06
Mini Circuits	High Pass Filter	VHF-6010+	31119	2022/08/07	2023/08/06

\* Statement of Traceability: China Certification ICT Co., Ltd (Dongguan) attests that all calibrations have been performed, traceable to National Primary Standards and International System of Units (SI).

### Test Data:

Please refer to the below table and plots.

1) 30MHz-1GHz(802.11b mode Middle channel was the worst)

Test Mode: Transmitting  
 Polarization: horizontal  
 Note:

Date: 2023-06-09

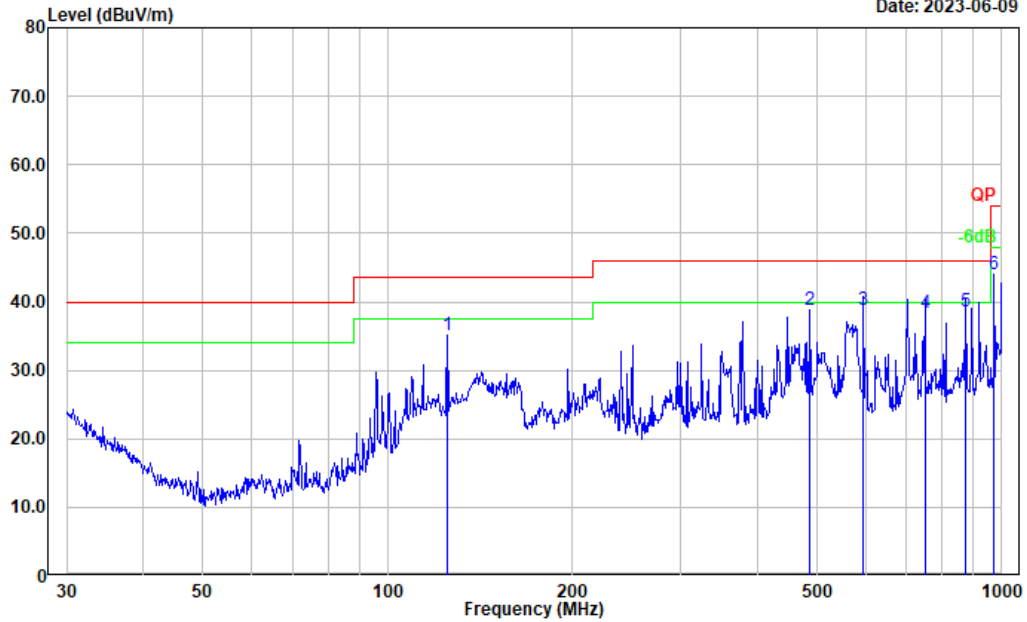

No.	Frequency (MHz)	Reading (dB $\mu$ V)	Factor (dB/m)	Result (dB $\mu$ V/m)	Limit (dB $\mu$ V/m)	Margin (dB)	Detector
1	125.007	46.45	-11.31	35.14	43.50	8.36	Peak
2	487.315	45.09	-6.27	38.82	46.00	7.18	Peak
3	595.133	43.98	-5.15	38.83	46.00	7.17	QP
4	750.108	41.30	-3.00	38.30	46.00	7.70	QP
5	875.247	39.77	-1.18	38.59	46.00	7.41	QP
6	972.337	43.67	0.32	43.99	54.00	10.01	Peak

Test Mode: Transmitting  
 Polarization: vertical  
 Note:

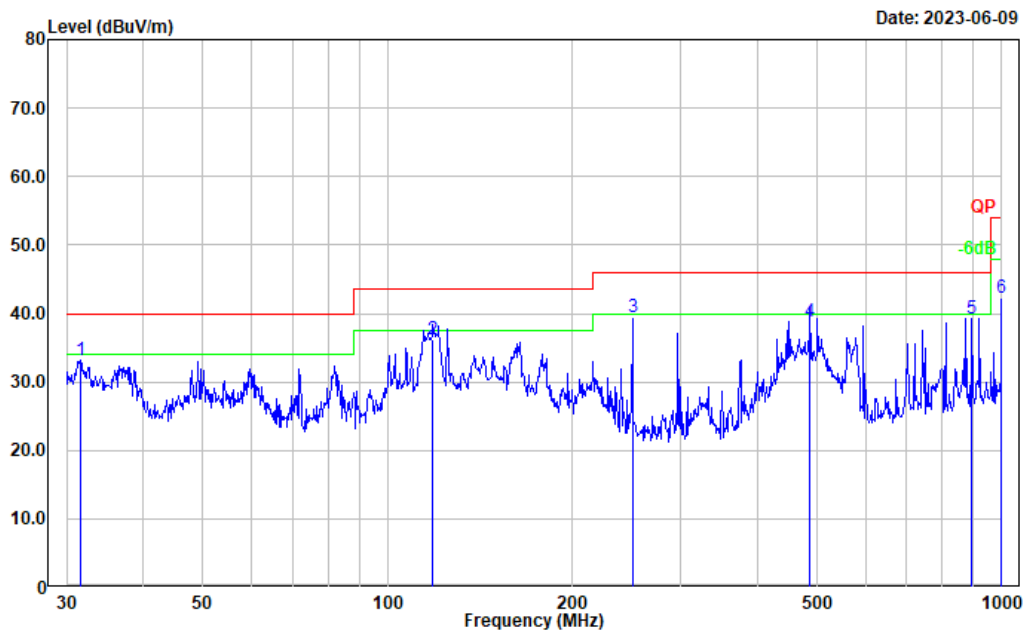

No.	Frequency (MHz)	Reading (dBμV)	Factor (dB/m)	Result (dBμV/m)	Limit (dBμV/m)	Margin (dB)	Detector
1	31.620	38.06	-4.83	33.23	40.00	6.77	Peak
2	118.601	47.87	-11.57	36.30	43.50	7.20	QP
3	250.301	52.43	-13.08	39.35	46.00	6.65	Peak
4	487.315	45.17	-6.27	38.90	46.00	7.10	QP
5	893.857	40.35	-1.09	39.26	46.00	6.74	Peak
6	1000.000	41.35	1.03	42.38	54.00	11.62	Peak

**2) 1-25GHz:  
802.11b Mode:**

Frequency (MHz)	Receiver		Polar (H/V)	Factor (dB/m)	Result (dB $\mu$ V/m)	Limit (dB $\mu$ V/m)	Margin (dB)
	Reading (dB $\mu$ V)	Detector					
Low Channel: 2412 MHz							
2412.000	75.03	PK	H	31.53	106.56	N/A	N/A
2412.000	71.45	AV	H	31.53	102.98	N/A	N/A
2412.000	79.33	PK	V	31.53	110.86	N/A	N/A
2412.000	75.29	AV	V	31.53	106.82	N/A	N/A
2390.000	36.51	PK	V	31.46	67.97	74.00	6.03
2390.000	21.75	AV	V	31.46	53.21	54.00	0.79
4824.000	47.91	PK	V	10.94	58.85	74.00	15.15
4824.000	39.61	AV	V	10.94	50.55	54.00	3.45
7236.000	37.41	PK	V	14.44	51.85	74.00	22.15
7236.000	25.21	AV	V	14.44	39.65	54.00	14.35
Middle Channel: 2437 MHz							
2437.000	75.28	PK	H	31.60	106.88	N/A	N/A
2437.000	71.19	AV	H	31.60	102.79	N/A	N/A
2437.000	78.96	PK	V	31.60	110.56	N/A	N/A
2437.000	74.23	AV	V	31.60	105.83	N/A	N/A
4874.000	47.69	PK	V	11.05	58.74	74.00	15.26
4874.000	39.78	AV	V	11.05	50.83	54.00	3.17
7311.000	36.62	PK	V	14.80	51.42	74.00	22.58
7311.000	24.31	AV	V	14.80	39.11	54.00	14.89
High Channel: 2462MHz							
2462.000	74.16	PK	H	31.63	105.79	N/A	N/A
2462.000	70.02	AV	H	31.63	101.65	N/A	N/A
2462.000	76.87	PK	V	31.63	108.50	N/A	N/A
2462.000	72.16	AV	V	31.63	103.79	N/A	N/A
2483.500	32.79	PK	V	31.64	64.43	74.00	9.57
2483.500	19.75	AV	V	31.64	51.39	54.00	2.61
4924.000	47.72	PK	V	11.18	58.90	74.00	15.10
4924.000	39.36	AV	V	11.18	50.54	54.00	3.46
7386.000	36.47	PK	V	14.89	51.36	74.00	22.64
7386.000	24.24	AV	V	14.89	39.13	54.00	14.87

**802.11g Mode:**

Frequency (MHz)	Receiver		Polar (H/V)	Factor (dB/m)	Result (dB $\mu$ V/m)	Limit (dB $\mu$ V/m)	Margin (dB)
	Reading (dB $\mu$ V)	Detector					
Low Channel: 2412 MHz							
2412.000	72.43	PK	H	31.53	103.96	N/A	N/A
2412.000	60.05	AV	H	31.53	91.58	N/A	N/A
2412.000	75.11	PK	V	31.53	106.64	N/A	N/A
2412.000	63.72	AV	V	31.53	95.25	N/A	N/A
2390.000	39.58	PK	V	31.46	71.04	74.00	2.96
2390.000	22.11	AV	V	31.46	53.57	54.00	0.43
4824.000	39.06	PK	V	10.94	50.00	74.00	24.00
4824.000	27.03	AV	V	10.94	37.97	54.00	16.03
7236.000	34.11	PK	V	14.44	48.55	74.00	25.45
7236.000	22.06	AV	V	14.44	36.50	54.00	17.50
Middle Channel: 2437 MHz							
2437.000	70.01	PK	H	31.60	101.61	N/A	N/A
2437.000	58.42	AV	H	31.60	90.02	N/A	N/A
2437.000	73.66	PK	V	31.60	105.26	N/A	N/A
2437.000	61.42	AV	V	31.60	93.02	N/A	N/A
4874.000	40.56	PK	V	11.05	51.61	74.00	22.39
4874.000	28.28	AV	V	11.05	39.33	54.00	14.67
7311.000	33.56	PK	V	14.80	48.36	74.00	25.64
7311.000	21.28	AV	V	14.80	36.08	54.00	17.92
High Channel: 2462MHz							
2462.000	69.91	PK	H	31.63	101.54	N/A	N/A
2462.000	57.36	AV	H	31.63	88.99	N/A	N/A
2462.000	73.18	PK	V	31.63	104.81	N/A	N/A
2462.000	61.57	AV	V	31.63	93.20	N/A	N/A
2483.500	36.41	PK	V	31.64	68.05	74.00	5.95
2483.500	20.36	AV	V	31.64	52.00	54.00	2.00
4924.000	41.52	PK	V	11.18	52.70	74.00	21.30
4924.000	29.26	AV	V	11.18	40.44	54.00	13.56
7386.000	34.05	PK	V	14.89	48.94	74.00	25.06
7386.000	22.03	AV	V	14.89	36.92	54.00	17.08

**802.11n ht20 Mode:**

Frequency (MHz)	Receiver		Polar (H/V)	Factor (dB/m)	Result (dB $\mu$ V/m)	Limit (dB $\mu$ V/m)	Margin (dB)
	Reading (dB $\mu$ V)	Detector					
Low Channel: 2412 MHz							
2412.000	70.87	PK	H	31.53	102.40	N/A	N/A
2412.000	57.31	AV	H	31.53	88.84	N/A	N/A
2412.000	73.63	PK	V	31.53	105.16	N/A	N/A
2412.000	60.58	AV	V	31.53	92.11	N/A	N/A
2390.000	41.73	PK	V	31.46	73.19	74.00	0.81
2390.000	21.52	AV	V	31.46	52.98	54.00	1.02
4824.000	37.58	PK	V	10.94	48.52	74.00	25.48
4824.000	25.29	AV	V	10.94	36.23	54.00	17.77
7236.000	33.13	PK	V	14.44	47.57	74.00	26.43
7236.000	21.07	AV	V	14.44	35.51	54.00	18.49
Middle Channel: 2437 MHz							
2437.000	71.46	PK	H	31.60	103.06	N/A	N/A
2437.000	58.41	AV	H	31.60	90.01	N/A	N/A
2437.000	73.45	PK	V	31.60	105.05	N/A	N/A
2437.000	60.37	AV	V	31.60	91.97	N/A	N/A
4874.000	39.66	PK	V	11.05	50.71	74.00	23.29
4874.000	27.33	AV	V	11.05	38.38	54.00	15.62
7311.000	34.01	PK	V	14.80	48.81	74.00	25.19
7311.000	22.02	AV	V	14.80	36.82	54.00	17.18
High Channel: 2462MHz							
2462.000	70.11	PK	H	31.63	101.74	N/A	N/A
2462.000	57.34	AV	H	31.63	88.97	N/A	N/A
2462.000	72.81	PK	V	31.63	104.44	N/A	N/A
2462.000	59.89	AV	V	31.63	91.52	N/A	N/A
2483.500	39.84	PK	V	31.64	71.48	74.00	2.52
2483.500	21.10	AV	V	31.64	52.74	54.00	1.26
4924.000	40.22	PK	V	11.18	51.40	74.00	22.60
4924.000	28.11	AV	V	11.18	39.29	54.00	14.71
7386.000	33.24	PK	V	14.89	48.13	74.00	25.87
7386.000	21.12	AV	V	14.89	36.01	54.00	17.99



**Worst Test plots(802.11b mode middle channel was the worst)**

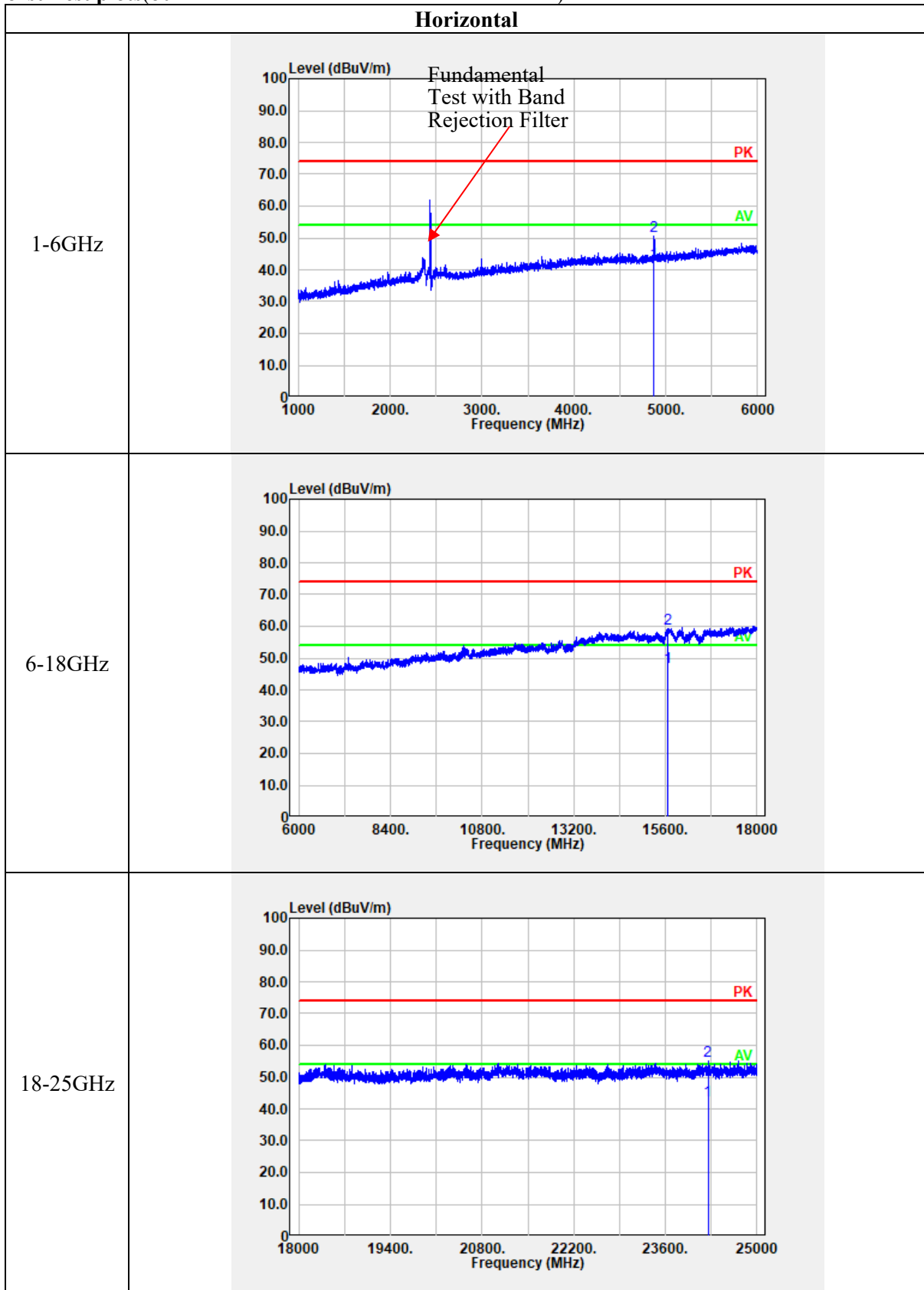

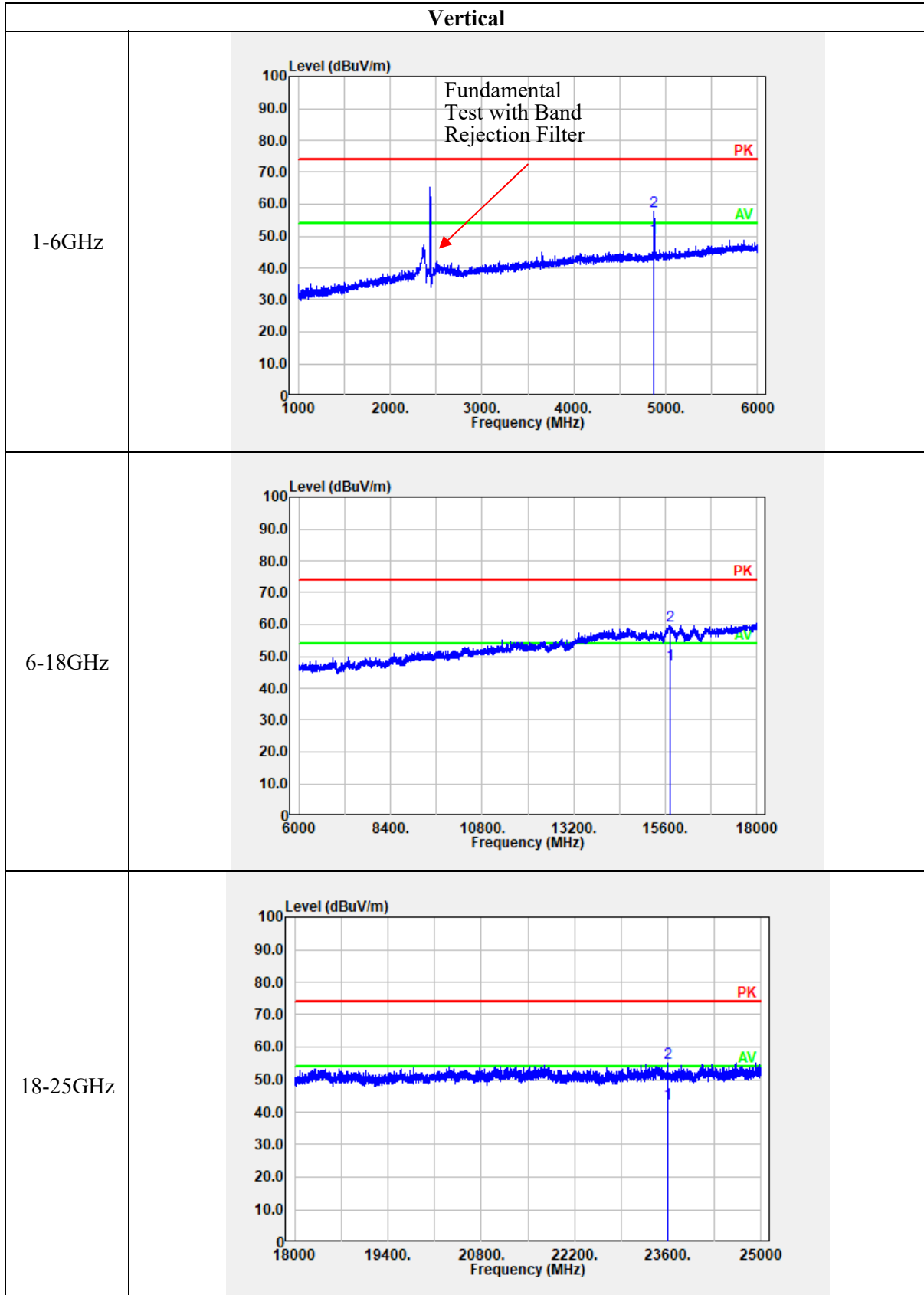

**4.3 Minimum 6 dB Emission Bandwidth:**

Serial Number:	24DY-1	Test Date:	2023/05/12-2023/05/13
Test Site:	RF	Test Mode:	Transmitting
Tester:	Morpheus Shi	Test Result:	Pass

**Environmental Conditions:**

Temperature: (°C)	23.5-24.5	Relative Humidity: (%)	59-64	ATM Pressure: (kPa)	100.8-100.9
----------------------	-----------	------------------------------	-------	------------------------	-------------

**Test Equipment List and Details:**

Manufacturer	Description	Model	Serial Number	Calibration Date	Calibration Due Date
R&S	Spectrum Analyzer	FSV40	101474	2022/07/15	2023/07/14
YINSAIGE	Coaxial Cable	SS402	SJ0100001	Each time	N/A
Mini-Circuits	DC Block	BLK-18-S+	1554403	Each time	N/A

\* Statement of Traceability: China Certification ICT Co., Ltd (Dongguan) attests that all calibrations have been performed, traceable to National Primary Standards and International System of Units (SI).

**Test Data:**

Test Modes	Test Frequency (MHz)	6 dB Bandwidth (MHz)	Limit (MHz)
802.11b	2412	8.64	0.5
	2437	9.12	0.5
	2462	9.04	0.5
802.11g	2412	16.08	0.5
	2437	16.08	0.5
	2462	16.16	0.5
802.11n ht20	2412	17.36	0.5
	2437	17.12	0.5
	2462	17.12	0.5

### 6dB Emission Bandwidth

802.11b  
Lowest Channel

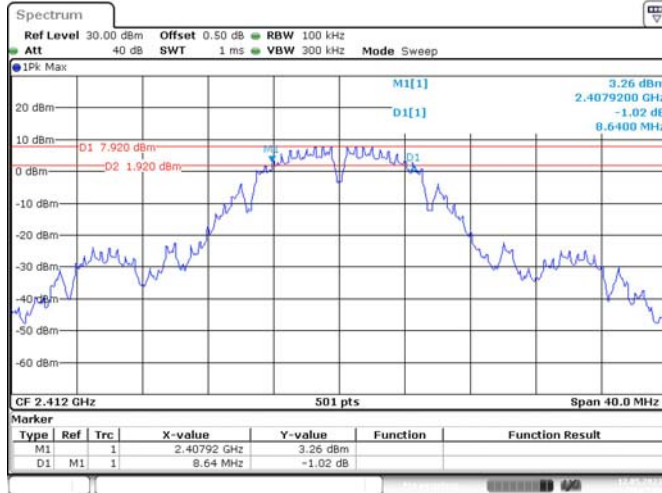

Date: 12.MAY.2023 23:52:31

802.11b  
Middle Channel

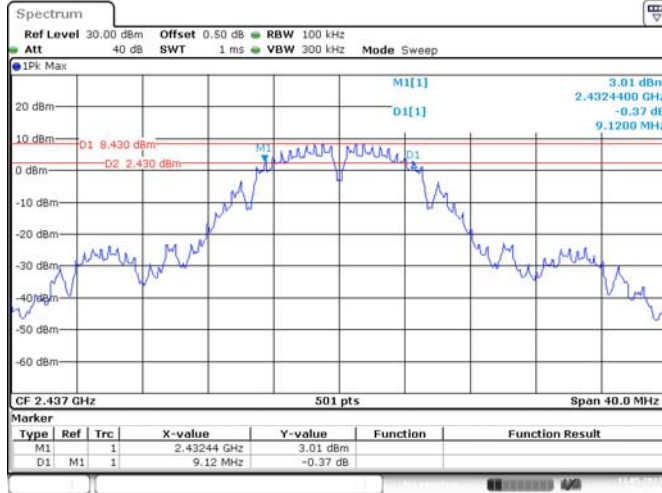

Date: 12.MAY.2023 23:53:59

802.11b  
Highest Channel

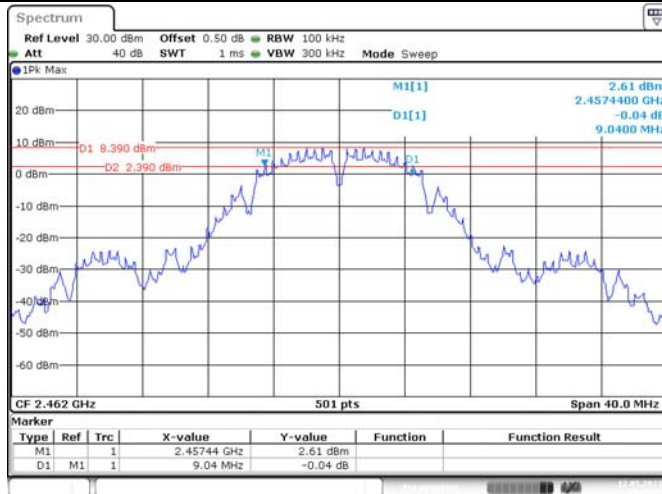

Date: 12.MAY.2023 23:54:51

### 6dB Emission Bandwidth

802.11g  
Lowest Channel

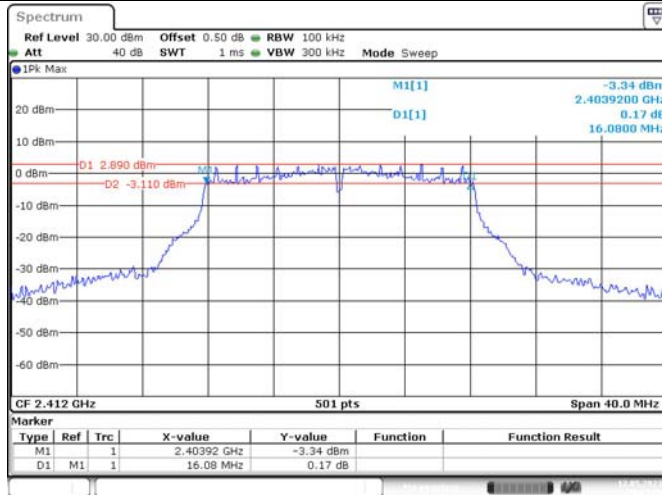

Date: 12.MAY.2023 23:55:42

802.11g  
Middle Channel

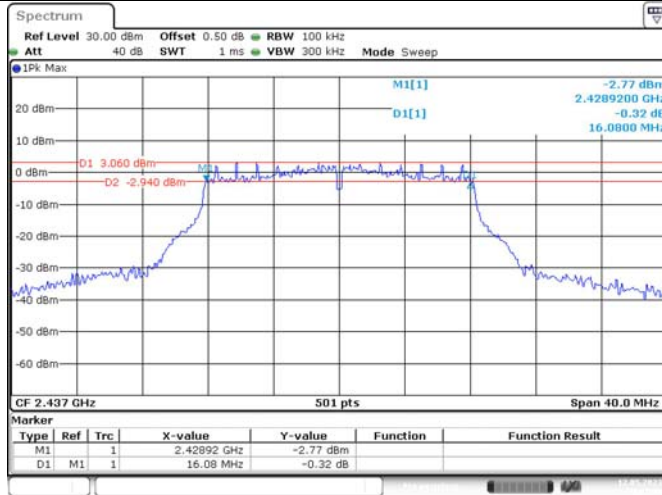

Date: 12.MAY.2023 23:57:26

802.11g  
Highest Channel

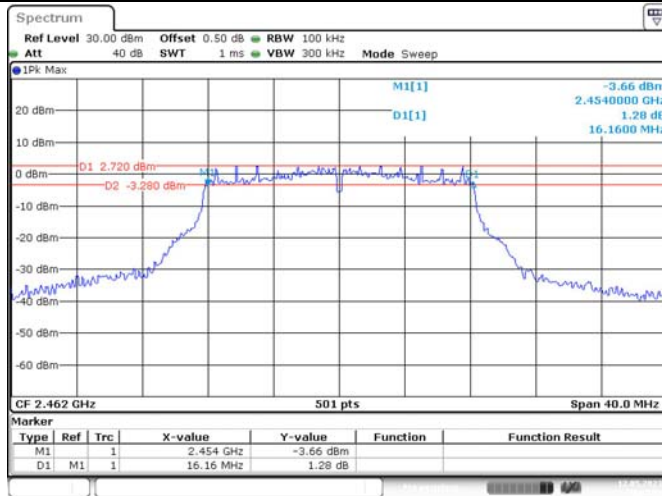

Date: 12.MAY.2023 23:58:14

### 6dB Emission Bandwidth

802.11n ht20  
Lowest Channel

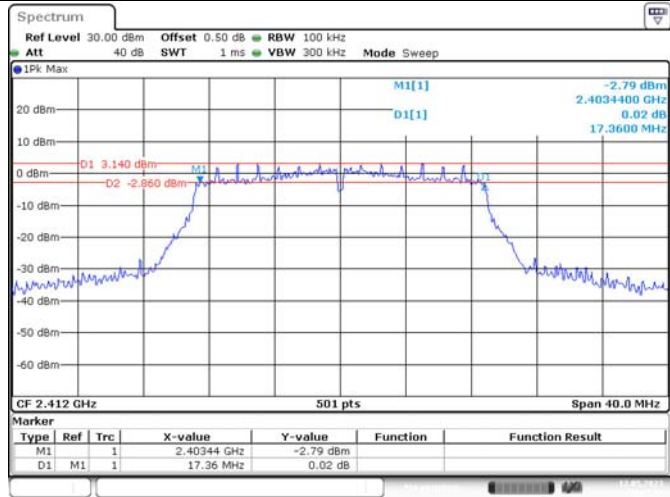

Date: 12.MAY.2023 23:59:14

802.11n ht20  
Middle Channel

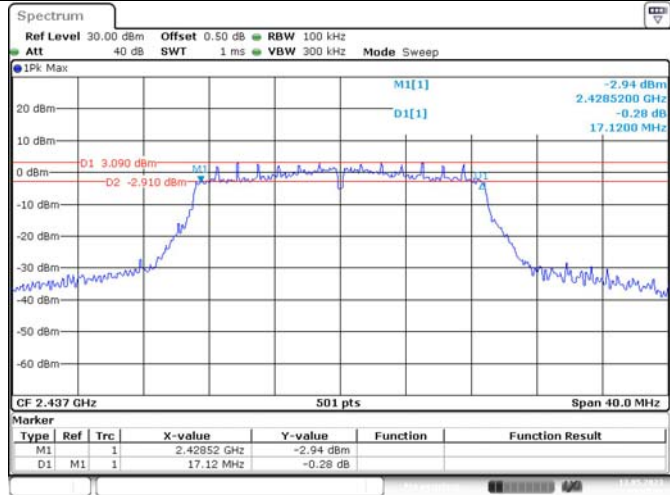

Date: 13.MAY.2023 00:00:16

802.11n ht20  
Highest Channel

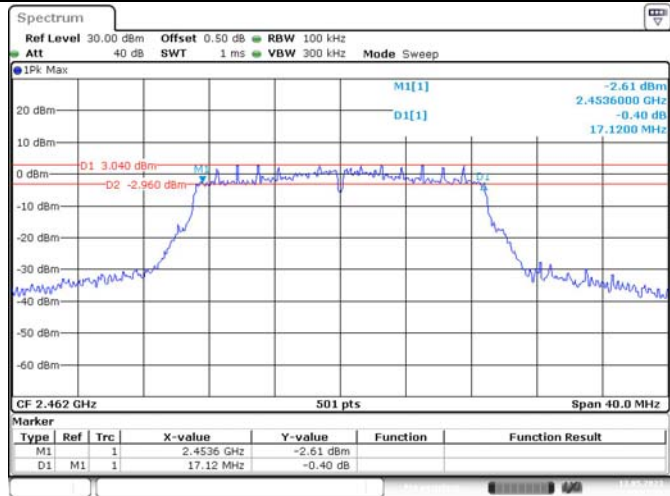

Date: 13.MAY.2023 00:01:11

**4.4 99% Occupied Bandwidth:**

Serial Number:	24DY-1	Test Date:	2023/05/12-2023/05/13
Test Site:	RF	Test Mode:	Transmitting
Tester:	Morpheus Shi	Test Result:	N/A

**Environmental Conditions:**

Temperature: (°C)	23.5-24.5	Relative Humidity: (%)	59-64	ATM Pressure: (kPa)	100.8-100.9
----------------------	-----------	------------------------------	-------	------------------------	-------------

**Test Equipment List and Details:**

Manufacturer	Description	Model	Serial Number	Calibration Date	Calibration Due Date
R&S	Spectrum Analyzer	FSV40	101474	2022/07/15	2023/07/14
YINSAIGE	Coaxial Cable	SS402	SJ0100001	Each time	N/A
Mini-Circuits	DC Block	BLK-18-S+	1554403	Each time	N/A

\* *Statement of Traceability: China Certification ICT Co., Ltd (Dongguan) attests that all calibrations have been performed, traceable to National Primary Standards and International System of Units (SI).*

**Test Data:**

Test Modes	Test Channel	Test Frequency (MHz)	99% Occupied Bandwidth (MHz)
802.11b	Lowest	2412	12.455
	Middle	2437	12.455
	Highest	2462	12.375
802.11g	Lowest	2412	17.086
	Middle	2437	17.086
	Highest	2462	17.006
802.11n ht20	Lowest	2412	18.204
	Middle	2437	18.204
	Highest	2462	18.204

99% Occupied Bandwidth

802.11b  
Lowest Channel

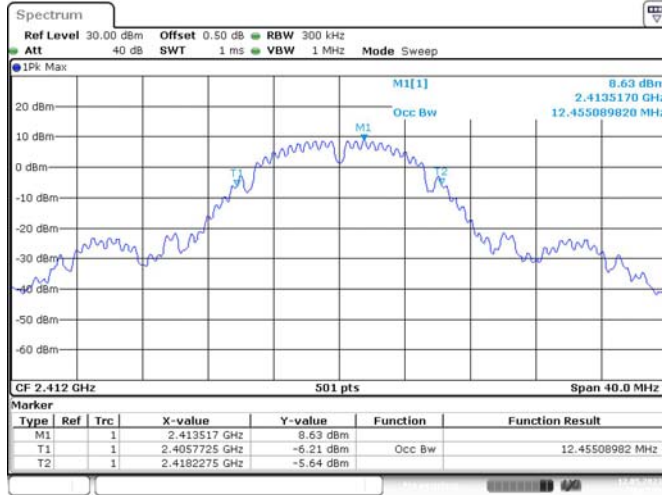

Date: 12.MAY.2023 23:52:41

802.11b  
Middle Channel

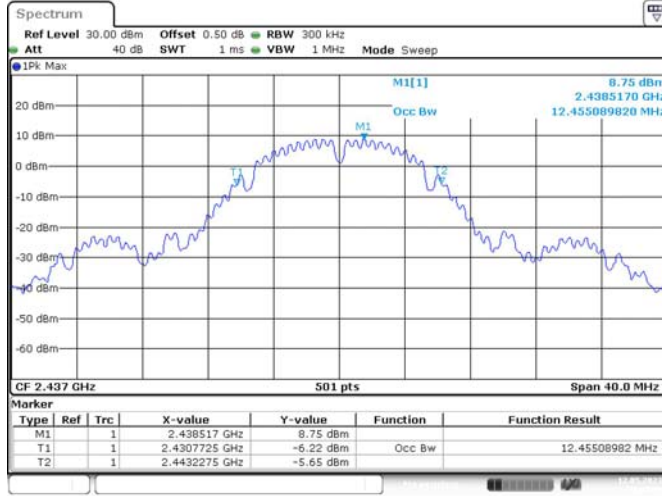

Date: 12.MAY.2023 23:54:10

802.11b  
Highest Channel

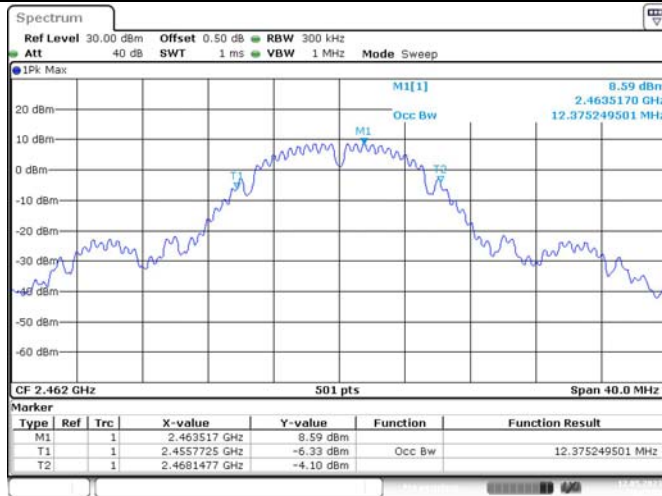

Date: 12.MAY.2023 23:55:02



### 99% Occupied Bandwidth

802.11g  
Lowest Channel

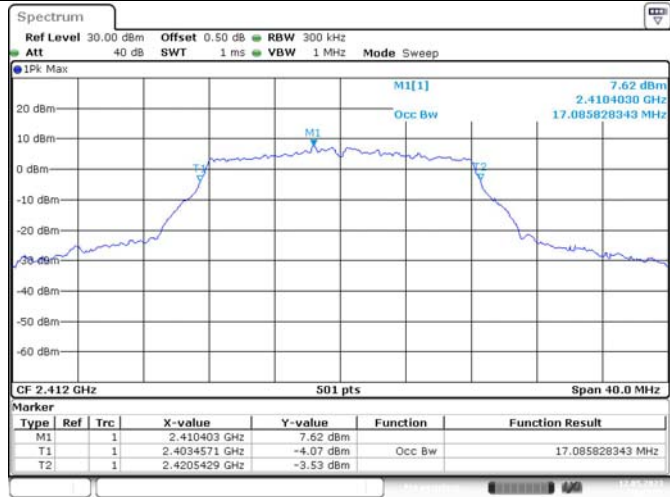

Date: 12.MAY.2023 23:55:55

802.11g  
Middle Channel

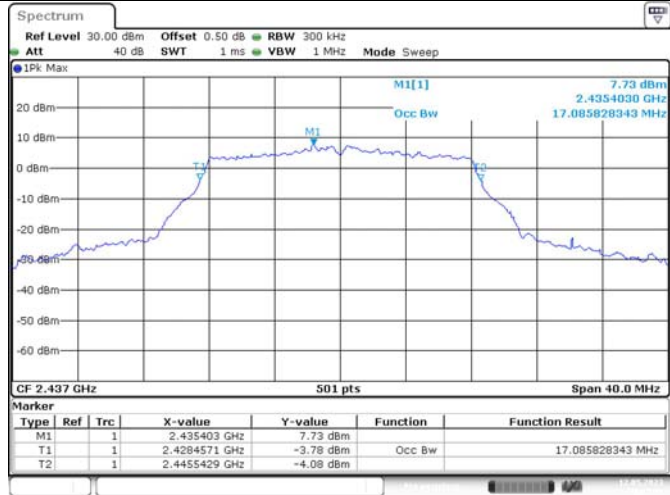

Date: 12.MAY.2023 23:57:43

802.11g  
Highest Channel

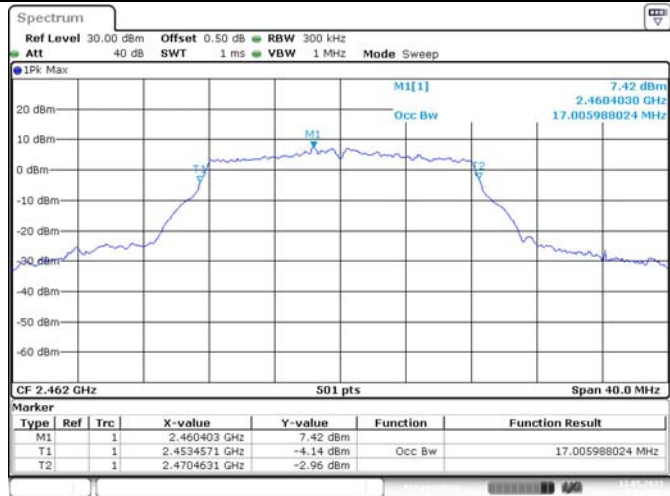

Date: 12.MAY.2023 23:58:28

### 99% Occupied Bandwidth

802.11n ht20  
Lowest Channel

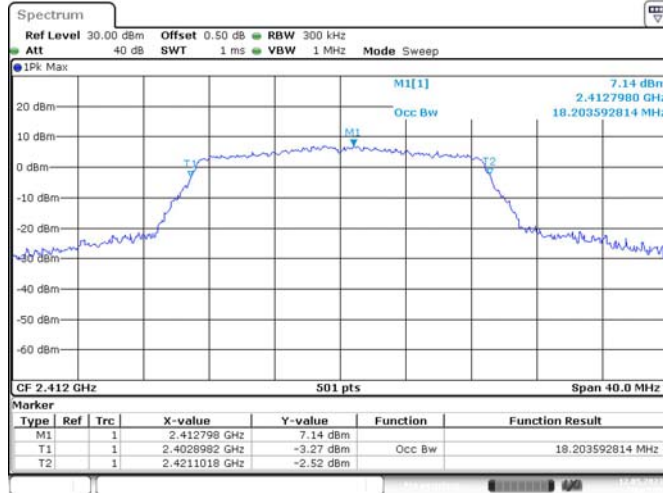

802.11n ht20  
Middle Channel

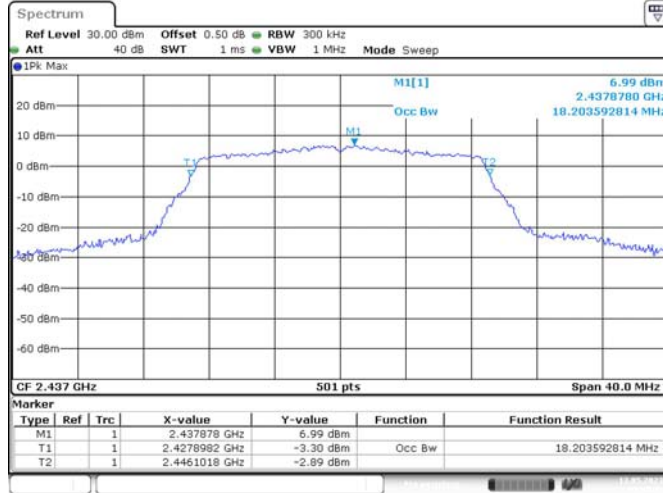

802.11n ht20  
Highest Channel



**4.5 Maximum Conducted Output Power:**

Serial Number:	24DY-1	Test Date:	2023/05/12
Test Site:	RF	Test Mode:	Transmitting
Tester:	Morpheus Shi	Test Result:	Pass

**Environmental Conditions:**

Temperature: (°C)	23.5	Relative Humidity: (%)	59	ATM Pressure: (kPa)	100.9
----------------------	------	------------------------------	----	------------------------	-------

**Test Equipment List and Details:**

Manufacturer	Description	Model	Serial Number	Calibration Date	Calibration Due Date
Agilent	USB Wideband Power Sensor	U2021XA	MY54080015	2022/07/15	2023/07/14
YINSAIGE	Coaxial Cable	SS402	SJ0100001	Each time	N/A
eastsheep	Coaxial Attenuator	2W-SMA-JK-18G	21060301	Each time	N/A

\* Statement of Traceability: China Certification ICT Co., Ltd (Dongguan) attests that all calibrations have been performed, traceable to National Primary Standards and International System of Units (SI).

**Test Data:**

Test Modes	Test Frequency (MHz)	Maximum Conducted Average Output Power (dBm)	Limit (dBm)
802.11b	2412	<b>17.35</b>	30
	2437	16.52	30
	2462	17.23	30
802.11g	2412	15.37	30
	2437	15.22	30
	2462	15.15	30
802.11n ht20	2412	14.96	30
	2437	14.85	30
	2462	14.72	30

**4.6 Maximum Power Spectral Density:**

Serial Number:	24DY-1	Test Date:	2023/05/13
Test Site:	RF	Test Mode:	Transmitting
Tester:	Morpheus Shi	Test Result:	Pass

**Environmental Conditions:**

Temperature: (°C)	24.5	Relative Humidity: (%)	64	ATM Pressure: (kPa)	100.8
----------------------	------	------------------------------	----	------------------------	-------

**Test Equipment List and Details:**

Manufacturer	Description	Model	Serial Number	Calibration Date	Calibration Due Date
R&S	Spectrum Analyzer	FSV40	101474	2022/07/15	2023/07/14
YINSAIGE	Coaxial Cable	SS402	SJ0100001	Each time	N/A
Mini-Circuits	DC Block	BLK-18-S+	1554403	Each time	N/A

\* Statement of Traceability: China Certification ICT Co., Ltd (Dongguan) attests that all calibrations have been performed, traceable to National Primary Standards and International System of Units (SI).

**Test Data:**

Test Channel	Test Frequency (MHz)	Reading (dBm/10kHz)	Duty Cycle Factor (dB)	Power Spectral Density (dBm/10kHz)	Limit (dBm/3kHz)
802.11b	2412	-9.81	/	-9.81	8.00
	2437	-9.75	/	-9.75	8.00
	2462	-9.80	/	-9.80	8.00
802.11g	2412	-10.86	0.21	-10.65	8.00
	2437	-11.34	0.21	-11.13	8.00
	2462	-11.25	0.21	-11.04	8.00
802.11n ht20	2412	-13.05	0.24	-12.81	8.00
	2437	-12.80	0.24	-12.56	8.00
	2462	-12.78	0.24	-12.54	8.00

Note: Duty cycle  $\geq 98\%$ , ANSI C63.10-2013 Section 11.10.3 was used for B mode test.  
Duty cycle  $< 98\%$ , ANSI C63.10-2013 Section 11.10.5 was used for G/N20 mode test.

### Maximum power spectral density

802.11b  
Lowest Channel



Date: 13.MAY.2023 00:29:03

802.11b  
Middle Channel



Date: 13.MAY.2023 00:33:41

802.11b  
Highest Channel



Date: 13.MAY.2023 00:35:41

### Maximum power spectral density

802.11g  
Lowest Channel

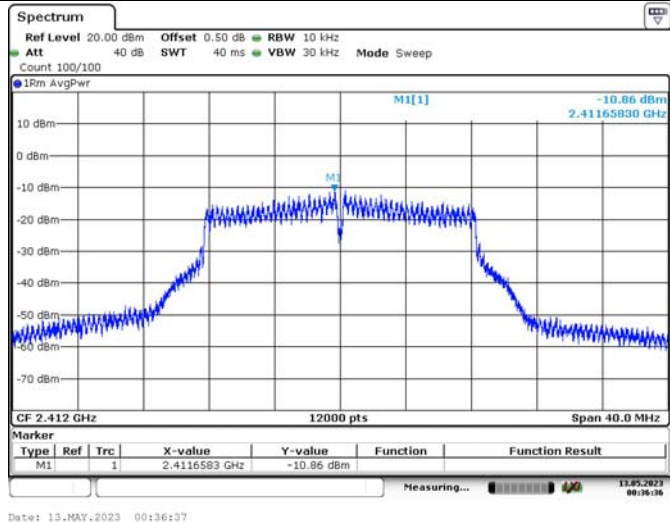

802.11g  
Middle Channel

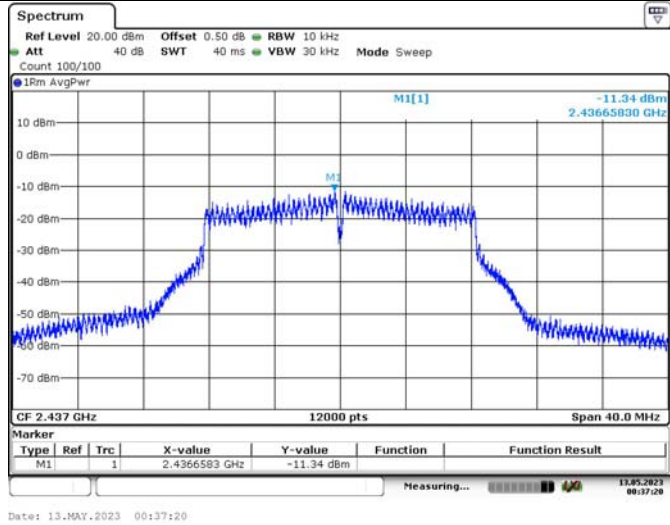

802.11g  
Highest Channel

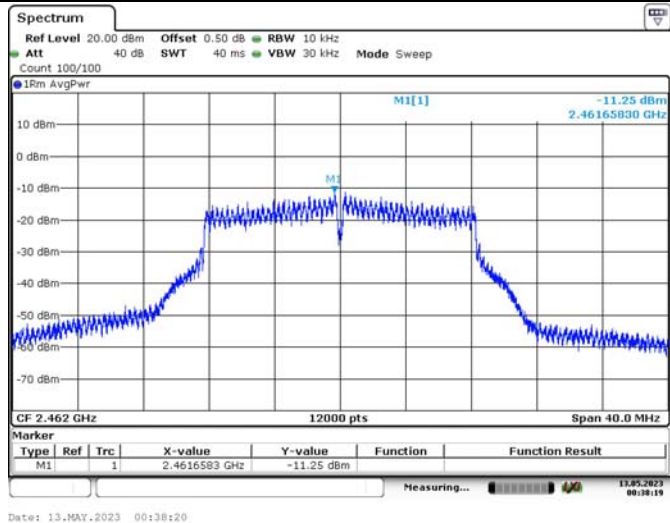

### Maximum power spectral density

802.11n ht20  
Lowest Channel

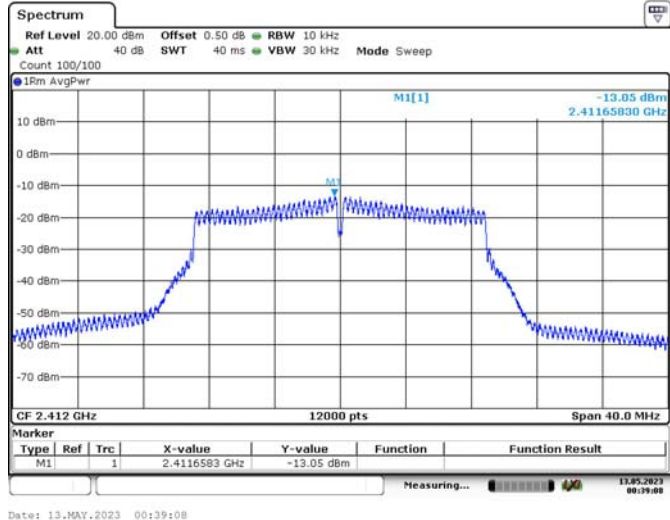

802.11n ht20  
Middle Channel

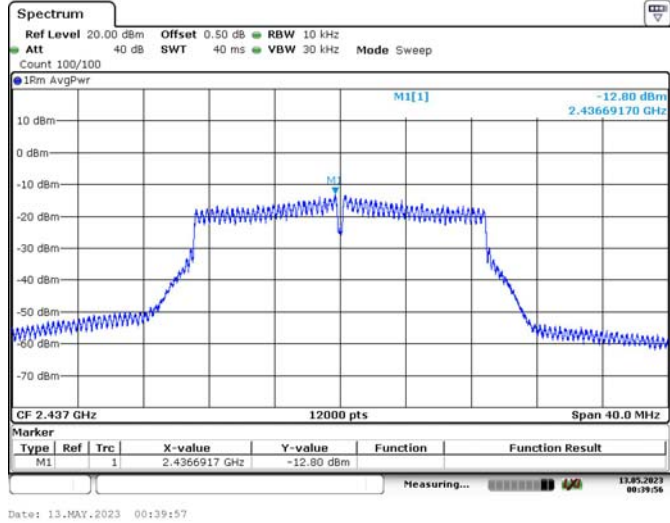

802.11n ht20  
Highest Channel

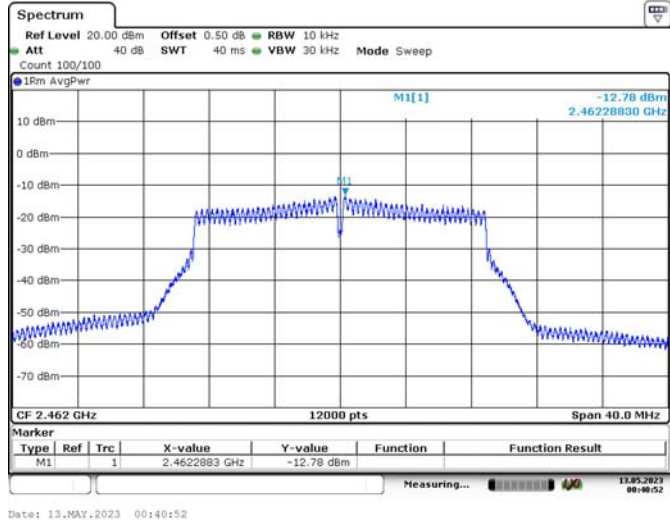

**4.7 100 kHz Bandwidth of Frequency Band Edge:**

Serial Number:	24DY-1	Test Date:	2023/05/13
Test Site:	RF	Test Mode:	Transmitting
Tester:	Morpheus Shi	Test Result:	Pass

**Environmental Conditions:**

Temperature: (°C)	24.5	Relative Humidity: (%)	64	ATM Pressure: (kPa)	100.8
----------------------	------	------------------------------	----	------------------------	-------

**Test Equipment List and Details:**

Manufacturer	Description	Model	Serial Number	Calibration Date	Calibration Due Date
R&S	Spectrum Analyzer	FSV40	101474	2022/07/15	2023/07/14
YINSAIGE	Coaxial Cable	SS402	SJ0100001	Each time	N/A
Mini-Circuits	DC Block	BLK-18-S+	1554403	Each time	N/A

*\* Statement of Traceability: China Certification ICT Co., Ltd (Dongguan) attests that all calibrations have been performed, traceable to National Primary Standards and International System of Units (SI).*

**Test Data:**



### 100 kHz Bandwidth of Frequency Band Edge

802.11b  
Lowest Band edge

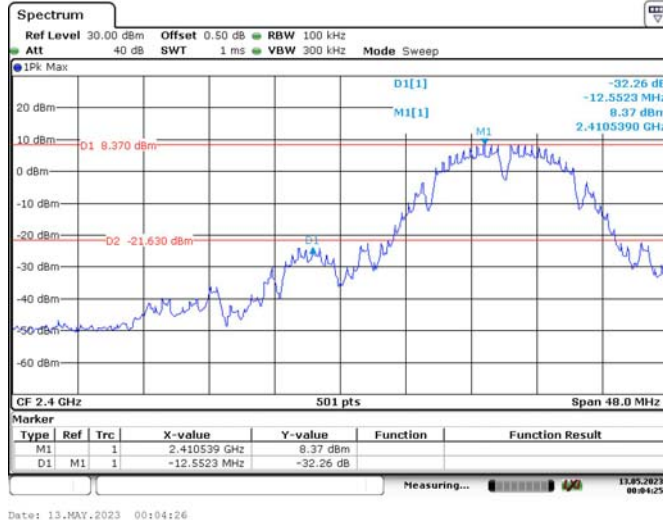

802.11b  
Highest Band edge

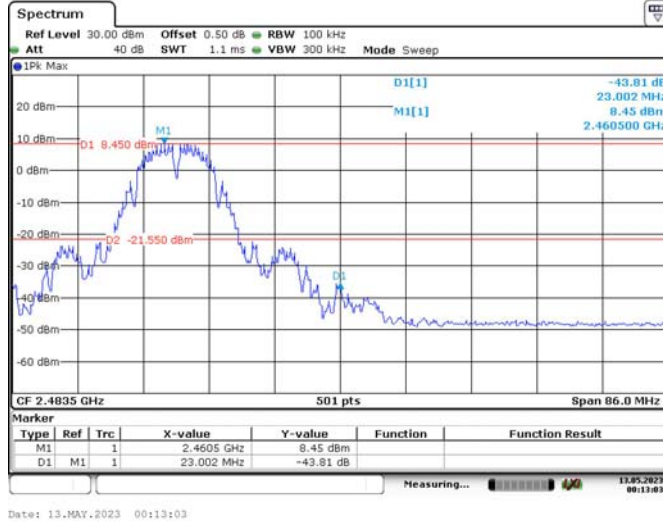

### 100 kHz Bandwidth of Frequency Band Edge

802.11g  
Lowest Band edge

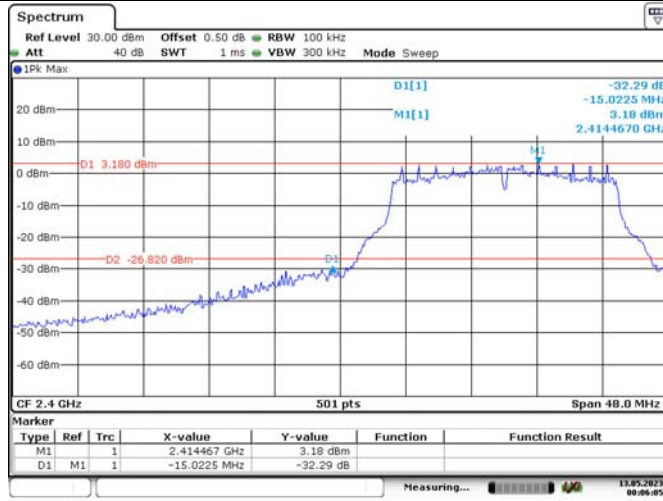

Date: 13.MAY.2023 00:06:06

802.11g  
Highest Band edge

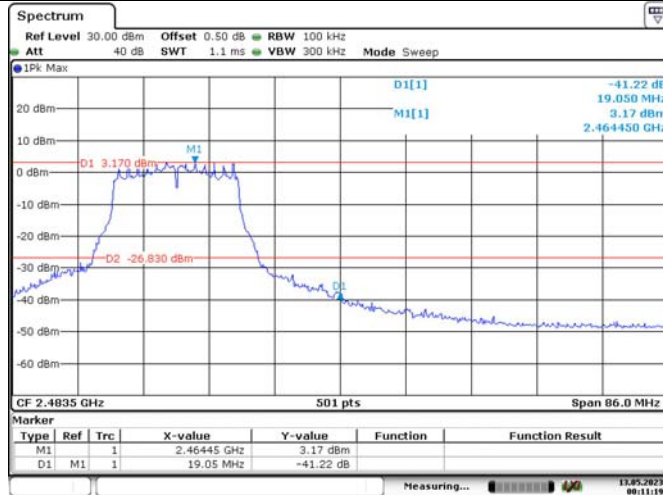

Date: 13.MAY.2023 00:11:19

### 100 kHz Bandwidth of Frequency Band Edge

802.11n ht20  
Lowest Band edge

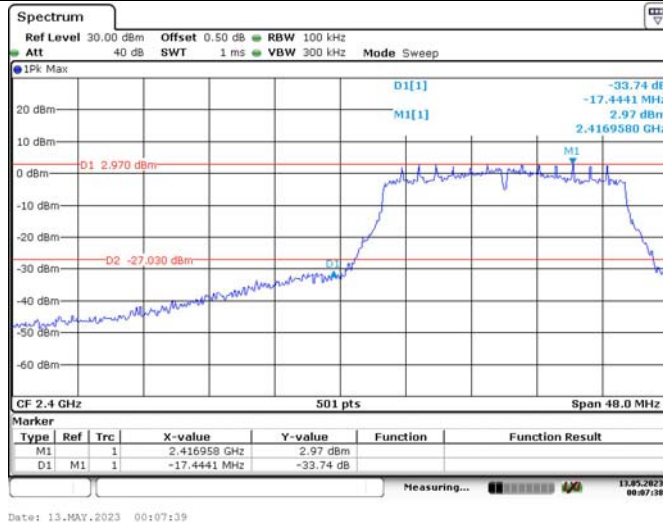

802.11n ht20  
Highest Band edge

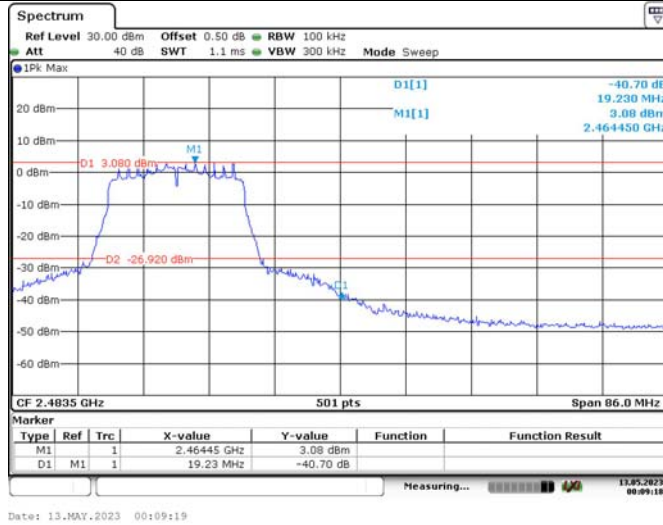

**4.8 Duty Cycle:**

Serial Number:	24DY-1	Test Date:	2023/05/13
Test Site:	RF	Test Mode:	Transmitting
Tester:	Morpheus Shi	Test Result:	N/A

**Environmental Conditions:**

Temperature: (°C)	24.5	Relative Humidity: (%)	64	ATM Pressure: (kPa)	100.8
----------------------	------	------------------------------	----	------------------------	-------

**Test Equipment List and Details:**

Manufacturer	Description	Model	Serial Number	Calibration Date	Calibration Due Date
R&S	Spectrum Analyzer	FSV40	101474	2022/07/15	2023/07/14
YINSAIGE	Coaxial Cable	SS402	SJ0100001	Each time	N/A
Mini-Circuits	DC Block	BLK-18-S+	1554403	Each time	N/A

*\* Statement of Traceability: China Certification ICT Co., Ltd (Dongguan) attests that all calibrations have been performed, traceable to National Primary Standards and International System of Units (SI).*

**Test Data:**

Test Modes	Ton (ms)	Ton+off (ms)	Duty cycle (%)	1/T (Hz)	Duty Cycle Factor (dB)
802.11b	100	100	100.00	/	/
802.11g	1.429	1.499	95.33	700	0.21
802.11n ht20	1.334	1.409	94.68	750	0.24

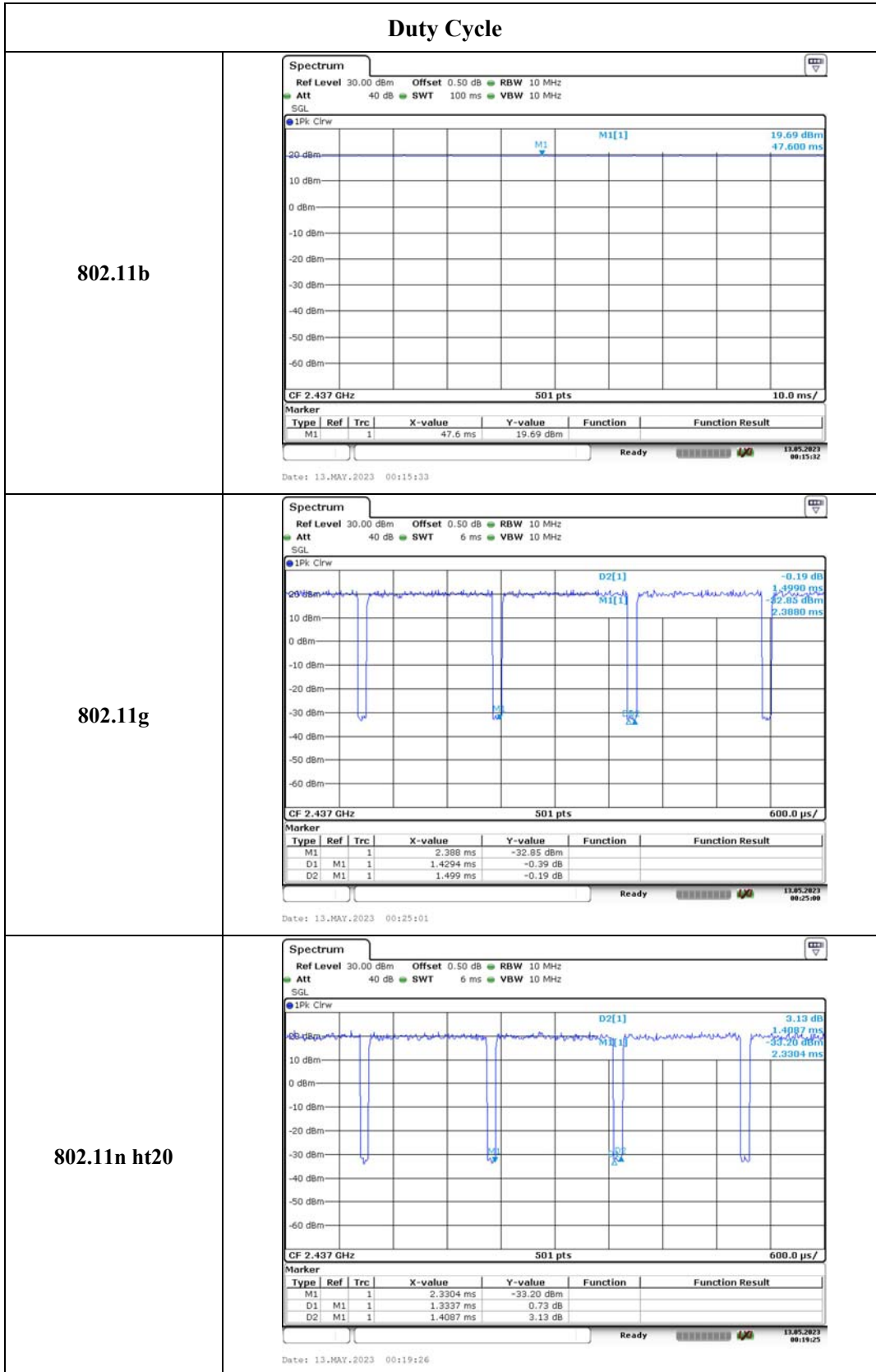

==== END OF REPORT ====