



FCC RADIO TEST REPORT-BLE

FCC ID:2AHJX-JR1601

Product : Jimu Robot

Trade Name : Jimu Robot

Model Name : JR1601

Serial Model : JR0401, JR0402, JR0403, JR0404, JR0405,
JR0406, JR0407, JR0408, JR0409, JR0601,
JR0602, JR0603, JR0604, JR0605, JR0606,
JR0607, JR0608, JR0609, JR0701, JR0702,
JR0703, JR1001, JR1002, JR1003, JR1201,
JR1202, JR1203, JR1602, JR1603, JRS101,
JRP01, JRU01, JRU02, JRS201

Report No. : NTEK-2016NT02224381F1-02

Prepared for

UBTECH ROBOTICS CORP

16th & 22nd Floor, Block C1, Nanshan I Park, No.1001 Xueyuan Road,
Nanshan District, Shenzhen City, PR. CHINA

Prepared by

Shenzhen NTEK Testing Technology Co., Ltd.

1/F, Building E, Fenda Science Park, Sanwei Community, Xixiang Street
Bao'an District, Shenzhen P.R. China

Tel.: +86-0755-61156588 Fax.: +86-0755-61156599

Website:www.ntek.org.cn

TEST RESULT CERTIFICATION

Applicant's name UBTECH ROBOTICS CORP

Address..... 16th & 22nd Floor, Block C1, Nanshan I Park, No.1001 Xueyuan Road,
Nanshan District, Shenzhen City, PR. CHINA

Manufacture's Name.. UBTECH ROBOTICS CORP BAOAN BRANCH

Address..... 1-2/F, Building B, Huilongda Industry Park, Shilongzai, Shiyan Street,
Baoan District, Shenzhen City

Product description

Product name..... Jimu Robot

Model and/or type
reference JR1601

Serial Model JR0401, JR0402, JR0403, JR0404, JR0405,
JR0406, JR0407, JR0408, JR0409, JR0601,
JR0602, JR0603, JR0604, JR0605, JR0606,
JR0607, JR0608, JR0609, JR0701, JR0702,
JR0703, JR1001, JR1002, JR1003, JR1201,
JR1202, JR1203, JR1602, JR1603, JRS101,
JRP01, JRU01, JRU02, JRS201

Standards FCC Part15.247: 01 Oct. 2015

Test procedure ANSI C63.10-2013 and KDB 558074: June 5, 2014

This device described above has been tested by NTEK, and the test results show that the equipment under test (EUT) is in compliance with the FCC requirements. And it is applicable only to the tested sample identified in the report.

This report shall not be reproduced except in full, without the written approval of NTEK, this document may be altered or revised by NTEK, personnel only, and shall be noted in the revision of the document.

Date of Test

Date (s) of performance of tests.....: 05 May. 2016 ~23 May. 2016

Date of Issue: 29 Jul. 2016

Test Result.....: **Pass**

Testing Engineer :



(Eileen Liu)

Technical Manager :

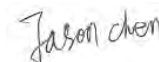

(Jason Chen)

Authorized Signatory :

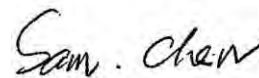

(Sam Chen)

Table of Contents

	Page
1 . SUMMARY OF TEST RESULTS	4
1.1 TEST FACILITY	5
1.2 MEASUREMENT UNCERTAINTY	5
2 . GENERAL INFORMATION	6
2.1 GENERAL DESCRIPTION OF EUT	6
2.2 DESCRIPTION OF TEST MODES	8
2.3 BLOCK DIGRAM SHOWING THE CONFIGURATION OF SYSTEM TESTED	9
2.4 DESCRIPTION OF SUPPORT UNITS(CONDUCTED MODE)	10
2.5 EQUIPMENTS LIST FOR ALL TEST ITEMS	11
3 . EMC EMISSION TEST	12
3.1 CONDUCTED EMISSION MEASUREMENT	12
3.1.1 POWER LINE CONDUCTED EMISSION LIMITS	12
3.1.2 TEST PROCEDURE	13
3.1.3 DEVIATION FROM TEST STANDARD	13
3.1.4 TEST SETUP	13
3.1.5 EUT OPERATING CONDITIONS	13
3.1.6 TEST RESULTS	14
3.2 RADIATED EMISSION MEASUREMENT	22
3.2.1 RADIATED EMISSION LIMITS	22
3.2.2 TEST PROCEDURE	23
3.2.3 DEVIATION FROM TEST STANDARD	23
3.2.4 TEST SETUP	24
3.2.5 EUT OPERATING CONDITIONS	25
3.2.6 TEST RESULTS (BETWEEN 9KHZ – 30 MHZ)	26
3.2.7 TEST RESULTS (BETWEEN 30MHZ – 1GHZ)	27
3.2.8 TEST RESULTS (ABOVE 1000 MHZ)	29
4 . EUT TEST PHOTO	30
APPENDIX-PHOTOGRAPHS OF EUT CONSTRUCTIONAL DETAILS	

1. SUMMARY OF TEST RESULTS

Test procedures according to the technical standards:

FCC Part15 (15.247) , Subpart C			
Standard Section	Test Item	Judgment	Remark
15.207	Conducted Emission	PASS	
15.247 (c)	Radiated Spurious Emission	PASS	

NOTE:

(1) "N/A" denotes test is not applicable in this Test Report

1.1 TEST FACILITY

NTEK Testing Technology Co., Ltd
 Add.:1/F, Building E, Fenda Science Park, Sanwei Community, Xixiang Street, Bao'an District, Shenzhen P.R. China.
 FCC Registration No.:238937; IC Registration No.:9270A-1
 CNAS Registration No.:L5516

1.2 MEASUREMENT UNCERTAINTY

The reported uncertainty of measurement $y \pm U$, where expanded uncertainty U is based on a standard uncertainty multiplied by a coverage factor of $k=2$, providing a level of confidence of approximately **95 %**.

No.	Item	Uncertainty
1	Conducted Emission Test	$\pm 1.38\text{dB}$
2	RF power,conducted	$\pm 0.16\text{dB}$
3	Spurious emissions,conducted	$\pm 0.21\text{dB}$
4	All emissions,radiated(<1G)	$\pm 4.68\text{dB}$
5	All emissions,radiated(>1G)	$\pm 4.89\text{dB}$
6	Temperature	$\pm 0.5^\circ\text{C}$
7	Humidity	$\pm 2\%$

2. GENERAL INFORMATION

2.1 GENERAL DESCRIPTION OF EUT

Equipment	Jimu Robot	
Trade Name	Jimu Robot	
Model Name	JR1601	
Serial Model	JR0401, JR0402, JR0403, JR0404, JR0405, JR0406, JR0407, JR0408, JR0409, JR0601, JR0602, JR0603, JR0604, JR0605, JR0606, JR0607, JR0608, JR0609, JR0701, JR0702, JR0703, JR1001, JR1002, JR1003, JR1201, JR1202, JR1203, JR1602, JR1603, JRS101, JRP01, JRU01, JRU02, JRS201	
Model Difference	All the model are the same circuit and RF module, except the model name.	
Product Description	The EUT is a Jimu Robot	
	Operation Frequency:	2402~2480MHz
	Modulation Type:	GFSK
	Number Of Channel	40CH
	Antenna Designation:	Please see Note 3.
	Antenna Gain (dBi)	1dBi
Channel List	Please refer to the Note 2.	
Ratings	DC 7.4V	
Adapter	Adapter-1: Mode: DSA-20PFE-12 FUS 096200 Input: 100-240V~, 50/60Hz, 0.7A Output: 9.6V $\overline{\text{---}}$, 2A Adapter-2: Mode: PS1012-096HIB 100 Input: 100-240V~, 50/60Hz, 0.4A Output: 9.6V $\overline{\text{---}}$, 1.0A	
Battery	DC 7.4V, 1200mAh	
Connecting I/O Port(s)	Please refer to the User's Manual	

Note:

1. For a more detailed features description, please refer to the manufacturer's specifications or the User's Manual.

2.

Channel	Frequency (MHz)
00	2402
01	2404
.....
.....
...	...
.....
38	2478
39	2480

3.

Table for Filed Antenna

Ant	Brand	Model Name	Antenna Type	Connector	Gain (dBi)	NOTE
A	N/A	N/A	PCB Antenna	N/A	1	BT Antenna

2.2 DESCRIPTION OF TEST MODES

To investigate the maximum EMI emission characteristics generates from EUT, the test system was pre-scanning tested base on the consideration of following EUT operation mode or test configuration mode which possible have effect on EMI emission level. Each of these EUT operation mode(s) or test configuration mode(s) mentioned above was evaluated respectively.

Pretest Mode	Description
Mode 1	CH00
Mode 2	CH19
Mode 3	CH39
Mode 4	Link Mode

For Conducted Emission	
Final Test Mode	Description
Mode 4	Link Mode

For Radiated Emission	
Final Test Mode	Description
Mode 1	CH00
Mode 2	CH19
Mode 3	CH39
Mode 4	Link Mode

Note:

(1) The measurements are performed at the highest, middle, lowest available channels.

2.3 BLOCK DIGRAM SHOWING THE CONFIGURATION OF SYSTEM TESTED

Conducted Emission Test

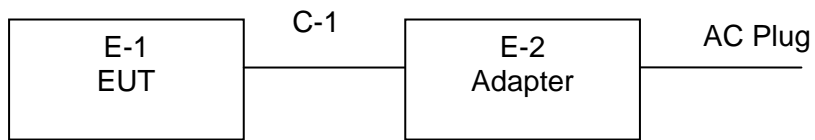

Radiated Spurious Emission Test

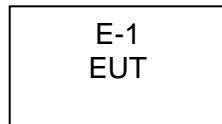

2.4 DESCRIPTION OF SUPPORT UNITS(CONDUCTED MODE)

The EUT has been tested as an independent unit together with other necessary accessories or support units. The following support units or accessories were used to form a representative test configuration during the tests.

Item	Equipment	Brand	Model/Type No.	Series No.	Note
E-1	Jimu Robot	Jimu Robot	JR1601	N/A	EUT
E-2	Adapter-1	N/A	DSA-20PFE-12 FUS 096200	N/A	
E-2	Adapter-2	N/A	PS1012-096HIB 100	N/A	

Item	Shielded Type	Ferrite Core	Length	Note
C-1	Metal wire	NO	1.2m	USB Line

Note:

- (1) The support equipment was authorized by Declaration of Confirmation.
- (2) For detachable type I/O cable should be specified the length in cm in 『Length』 column.

2.5 EQUIPMENTS LIST FOR ALL TEST ITEMS

Radiation Test equipment

Item	Kind of Equipment	Manufacturer	Type No.	Serial No.	Last calibration	Calibrated until	Calibration period
1	Spectrum Analyzer	Agilent	E4407B	MY45108040	2015.07.06	2016.07.05	1 year
2	Test Receiver	R&S	ESPI	101318	2015.06.07	2016.06.06	1 year
3	Bilog Antenna	TESEQ	CBL6111D	31216	2015.07.06	2016.07.05	1 year
4	50Ω Coaxial Switch	Anritsu	MP59B	6200264416	2015.06.07	2016.06.06	1 year
5	Spectrum Analyzer	ADVANTEST	R3132	150900201	2015.06.07	2016.06.06	1 year
6	Horn Antenna	EM	EM-AH-10180	2011071402	2015.07.06	2016.07.05	1 year
7	Horn Ant	Schwarzbeck	BBHA 9170	9170-181	2015.07.06	2016.07.05	1 year
8	Amplifier	EM	EM-30180	060538	2015.12.22	2016.12.21	1 year
9	Loop Antenna	ARA	PLA-1030/B	1029	2015.06.08	2016.06.07	1 year
10	Power Meter	R&S	NRVS	100696	2015.07.06	2016.07.05	1 year
11	Power Sensor	R&S	URV5-Z4	0395.1619.05	2015.07.06	2016.07.05	1 year
12	Test Cable	N/A	R-01	N/A	2015.07.06	2016.07.05	1 year
13	Test Cable	N/A	R-02	N/A	2015.07.06	2016.07.05	1 year

Conduction Test equipment

Item	Kind of Equipment	Manufacturer	Type No.	Serial No.	Last calibration	Calibrated until	Calibration period
1	Test Receiver	R&S	ESCI	101160	2015.06.06	2016.06.05	1 year
2	LISN	R&S	ENV216	101313	2015.08.24	2016.08.23	1 year
3	LISN	EMCO	3816/2	00042990	2015.08.24	2016.08.23	1 year
4	50Ω Coaxial Switch	Anritsu	MP59B	6200264417	2015.06.07	2016.06.06	1 year
5	Passive Voltage Probe	R&S	ESH2-Z3	100196	2015.06.07	2016.06.06	1 year
6	Absorbing clamp	R&S	MOS-21	100423	2015.06.08	2016.06.07	1 year
7	Test Cable	N/A	C01	N/A	2015.06.08	2016.06.07	1 year
8	Test Cable	N/A	C02	N/A	2015.06.08	2016.06.07	1 year
9	Test Cable	N/A	C03	N/A	2015.06.08	2016.06.07	1 year

1	Attenuation	MCE	24-10-34	BN9258	2015.06.08	2016.06.07	1 year
---	-------------	-----	----------	--------	------------	------------	--------

3. EMC EMISSION TEST

3.1 CONDUCTED EMISSION MEASUREMENT

3.1.1 POWER LINE CONDUCTED EMISSION Limits (Frequency Range 150KHz-30MHz)

FREQUENCY (MHz)	Class A (dBuV)		Class B (dBuV)		Standard
	Quasi-peak	Average	Quasi-peak	Average	
0.15 -0.5	79.00	66.00	66 - 56 *	56 - 46 *	CISPR
0.50 -5.0	73.00	60.00	56.00	46.00	CISPR
5.0 -30.0	73.00	60.00	60.00	50.00	CISPR

0.15 -0.5	79.00	66.00	66 - 56 *	56 - 46 *	FCC
0.50 -5.0	73.00	60.00	56.00	46.00	FCC
5.0 -30.0	73.00	60.00	60.00	50.00	FCC

Note:

- (1) The tighter limit applies at the band edges.
- (2) The limit of " * " marked band means the limitation decreases linearly with the logarithm of the frequency in the range.

The following table is the setting of the receiver

Receiver Parameters	Setting
Attenuation	10 dB
Start Frequency	0.15 MHz
Stop Frequency	30 MHz
IF Bandwidth	9 kHz

3.1.2 TEST PROCEDURE

- a. The EUT was placed 0.8 meters from the horizontal ground plane with EUT being connected to the power mains through a line impedance stabilization network (LISN). All other support equipments powered from additional LISN(s). The LISN provide 50 Ohm/ 50uH of coupling impedance for the measuring instrument.
- b. Interconnecting cables that hang closer than 40 cm to the ground plane shall be folded back and forth in the center forming a bundle 30 to 40 cm long.
- c. I/O cables that are not connected to a peripheral shall be bundled in the center. The end of the cable may be terminated, if required, using the correct terminating impedance. The overall length shall not exceed 1 m.
- d. LISN at least 80 cm from nearest part of EUT chassis.
- e. For the actual test configuration, please refer to the related Item –EUT Test Photos.

3.1.3 DEVIATION FROM TEST STANDARD

No deviation

3.1.4 TEST SETUP

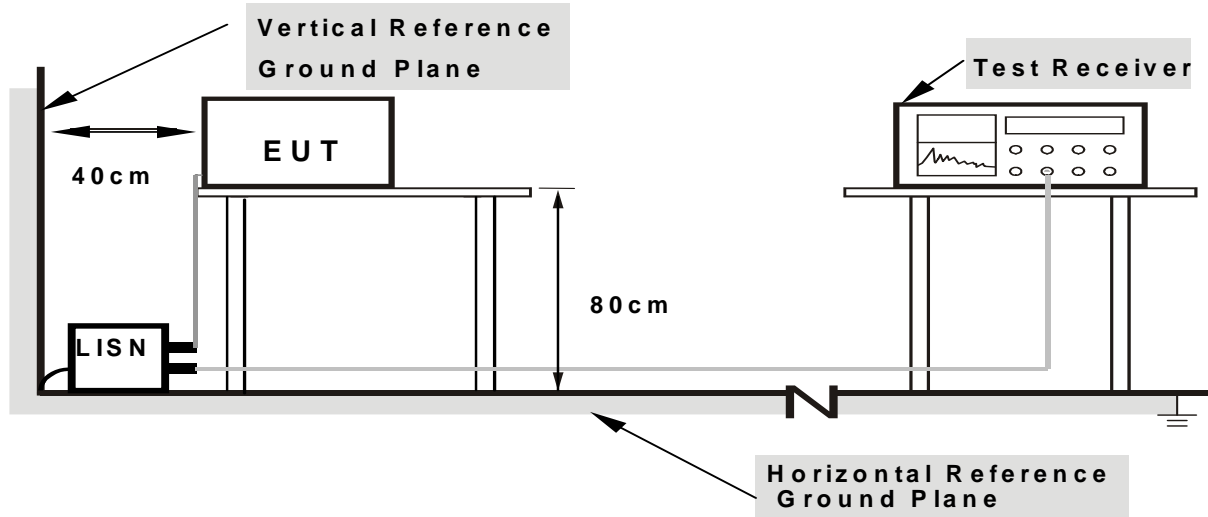

- Note:**
- 1. Support units were connected to second LISN.
 - 2. Both of LISNs (AMN) are 80 cm from EUT and at least 80 from other units and other metal planes

3.1.5 EUT OPERATING CONDITIONS

The EUT was configured for testing in a typical fashion (as a customer would normally use it). The EUT has been programmed to continuously transmit during test. This operating condition was tested and used to collect the included data.

3.1.6 TEST RESULTS

EUT :	Jimu Robot	Model Name. :	JR1601-Adapter-1
Temperature :	26 °C	Relative Humidity :	56%
Pressure :	1010hPa	Phase :	L
Test Voltage :	DC 5.0V form Adapter AC 120V/60Hz	Test Mode :	Mode 4

Frequency (MHz)	Meter Reading (dBμV)	Factor (dB)	Emission Level (dBμV)	Limits (dBμV)	Margin (dB)	Remark
0.3140	39.45	10.13	49.58	59.86	-10.28	QP
0.3140	35.27	10.13	45.40	49.86	-4.46	AVG
0.5620	35.70	9.79	45.49	56.00	-10.51	QP
0.5620	33.47	9.79	43.26	46.00	-2.74	AVG
0.8100	35.21	9.81	45.02	56.00	-10.98	QP
0.8100	30.43	9.81	40.24	46.00	-5.76	AVG
1.4417	35.34	9.80	45.14	56.00	-10.86	QP
1.4417	28.46	9.80	38.26	46.00	-7.74	AVG
2.6339	34.85	9.74	44.59	56.00	-11.41	QP
2.6339	25.91	9.74	35.65	46.00	-10.35	AVG
3.7700	34.17	9.75	43.92	56.00	-12.08	QP
3.7700	22.56	9.75	32.31	46.00	-13.69	AVG

Remark:

1. All readings are Quasi-Peak and Average values.
2. Factor = Insertion Loss + Cable Loss.

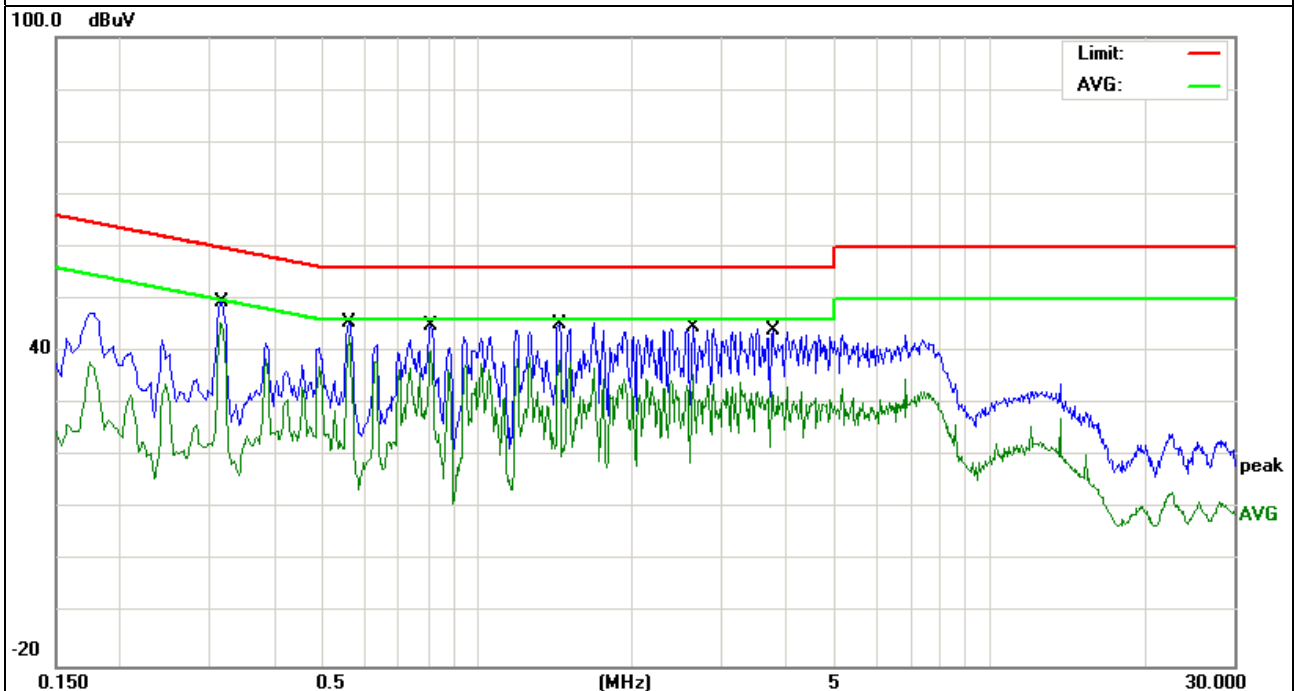

EUT :	Jimu Robot	Model Name. :	JR1601-Adapter-1
Temperature :	26 °C	Relative Humidity :	56%
Pressure :	1010hPa	Phase :	N
Test Voltage :	DC 5.0V form Adapter AC 120V/60Hz	Test Mode :	Mode 4

Frequency (MHz)	Meter Reading (dBμV)	Factor (dB)	Emission Level (dBμV)	Limits (dBμV)	Margin (dB)	Remark
0.3180	39.23	10.12	49.35	59.76	-10.41	QP
0.3180	34.93	10.12	45.05	49.76	-4.71	AVG
0.5620	35.22	9.82	45.04	56.00	-10.96	QP
0.5620	33.22	9.82	43.04	46.00	-2.96	AVG
0.8100	34.88	9.83	44.71	56.00	-11.29	QP
0.8100	30.08	9.83	39.91	46.00	-6.09	AVG
1.4418	35.39	9.82	45.21	56.00	-10.79	QP
1.4418	29.89	9.82	39.71	46.00	-6.29	AVG
2.3980	34.75	9.74	44.49	56.00	-11.51	QP
2.3980	25.97	9.74	35.71	46.00	-10.29	AVG
3.5099	34.22	9.73	43.95	56.00	-12.05	QP
3.5099	23.68	9.73	33.41	46.00	-12.59	AVG

Remark:

1. All readings are Quasi-Peak and Average values.
2. Factor = Insertion Loss + Cable Loss.

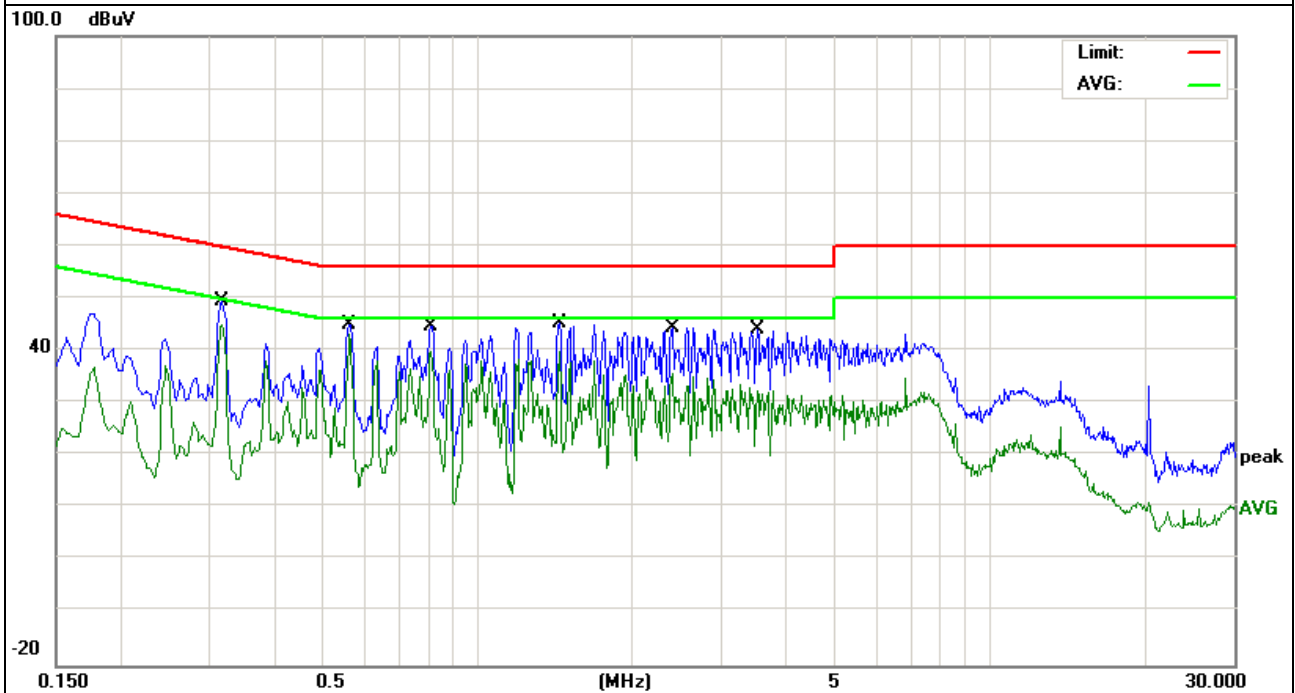

EUT :	Jimu Robot	Model Name. :	JR1601-Adapter-1
Temperature :	26 °C	Relative Humidity :	56%
Pressure :	1010hPa	Phase :	L
Test Voltage :	DC 5.0V form Adapter AC 240V/60Hz	Test Mode :	Mode 4

Frequency (MHz)	Meter Reading (dBμV)	Factor (dB)	Emission Level (dBμV)	Limits (dBμV)	Margin (dB)	Remark
0.2740	41.70	10.14	51.84	60.99	-9.15	QP
0.2740	38.38	10.14	48.52	50.99	-2.47	AVG
0.6018	34.61	9.79	44.40	56.00	-11.60	QP
0.6018	33.82	9.79	43.61	46.00	-2.39	AVG
0.6580	34.66	9.78	44.44	56.00	-11.56	QP
0.6580	33.66	9.78	43.44	46.00	-2.56	AVG
1.4256	36.25	9.80	46.05	56.00	-9.95	QP
1.4256	33.55	9.80	43.35	46.00	-2.65	AVG
3.5619	35.99	9.75	45.74	56.00	-10.26	QP
3.5619	34.37	9.75	44.12	46.00	-1.88	AVG
7.1219	35.38	9.77	45.15	60.00	-14.85	QP
7.1219	32.65	9.77	42.42	50.00	-7.58	AVG

Remark:
 1. All readings are Quasi-Peak and Average values.
 2. Factor = Insertion Loss + Cable Loss.

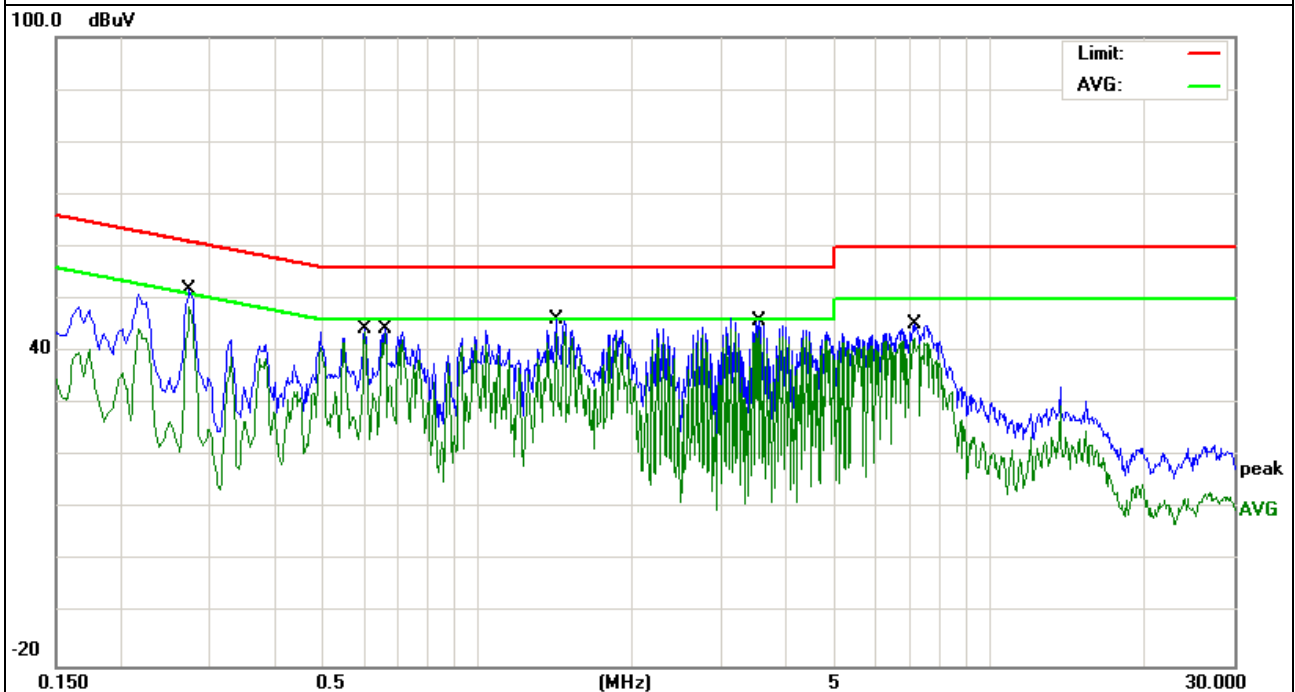

EUT :	Jimu Robot	Model Name. :	JR1601-Adapter-1
Temperature :	26 °C	Relative Humidity :	56%
Pressure :	1010hPa	Phase :	N
Test Voltage :	DC 5.0V form Adapter AC 240V/60Hz	Test Mode :	Mode 4

Frequency (MHz)	Meter Reading (dBμV)	Factor (dB)	Emission Level (dBμV)	Limits (dBμV)	Margin (dB)	Remark
0.2779	42.46	10.11	52.57	60.88	-8.31	QP
0.2779	39.60	10.11	49.71	50.88	-1.17	AVG
0.6380	36.01	9.81	45.82	56.00	-10.18	QP
0.6380	35.18	9.81	44.99	46.00	-1.01	AVG
0.9979	35.53	9.87	45.40	56.00	-10.60	QP
0.9979	33.75	9.87	43.62	46.00	-2.38	AVG
1.4698	35.66	9.81	45.47	56.00	-10.53	QP
1.4698	33.81	9.81	43.62	46.00	-2.38	AVG
2.3460	36.06	9.74	45.80	56.00	-10.20	QP
2.3460	31.62	9.74	41.36	46.00	-4.64	AVG
3.1419	34.82	9.73	44.55	56.00	-11.45	QP
3.1419	31.72	9.73	41.45	46.00	-4.55	AVG

Remark:

1. All readings are Quasi-Peak and Average values.
2. Factor = Insertion Loss + Cable Loss.

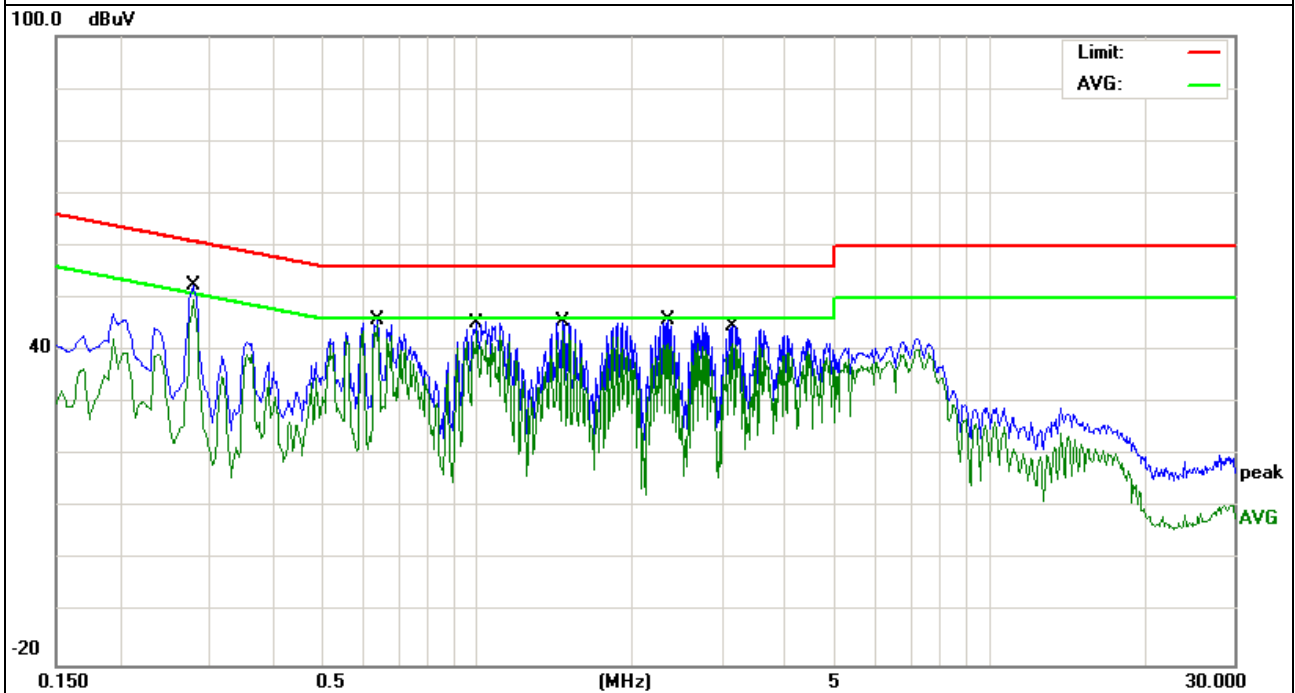

Note: pre-test all of charging mode, this mode is worst case, only provide the worst case in report.

EUT :	Jimu Robot	Model Name. :	JR1601-Adapter-2
Temperature :	26 °C	Relative Humidity :	56%
Pressure :	1010hPa	Phase :	L
Test Voltage :	DC 5.0V form Adapter AC 120V/60Hz	Test Mode :	Mode 4

Frequency (MHz)	Meter Reading (dBμV)	Factor (dB)	Emission Level (dBμV)	Limits (dBμV)	Margin (dB)	Remark
0.1539	32.24	10.12	42.36	65.78	-23.42	QP
0.1539	18.22	10.12	28.34	55.78	-27.44	AVG
0.3059	31.71	10.13	41.84	60.08	-18.24	QP
0.3059	17.54	10.13	27.67	50.08	-22.41	AVG
0.4620	39.84	9.89	49.73	56.66	-6.93	QP
0.4620	27.48	9.89	37.37	46.66	-9.29	AVG
1.7820	38.03	9.76	47.79	56.00	-8.21	QP
1.7820	25.82	9.76	35.58	46.00	-10.42	AVG
15.8377	33.05	9.87	42.92	60.00	-17.08	QP
15.8377	26.39	9.87	36.26	50.00	-13.74	AVG
19.0097	32.23	9.92	42.15	60.00	-17.85	QP
19.0097	19.91	9.92	29.83	50.00	-20.17	AVG

Remark:

1. All readings are Quasi-Peak and Average values.
2. Factor = Insertion Loss + Cable Loss.

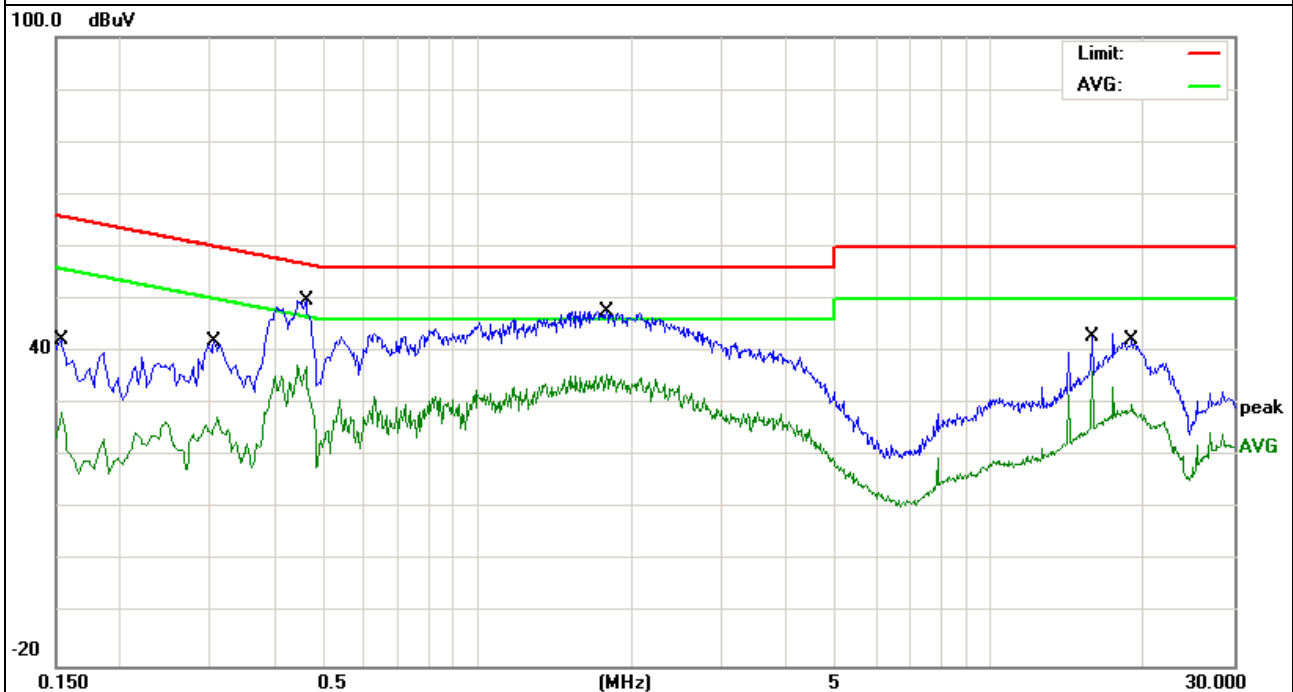

EUT :	Jimu Robot	Model Name. :	JR1601-Adapter-2
Temperature :	26 °C	Relative Humidity :	56%
Pressure :	1010hPa	Phase :	N
Test Voltage :	DC 5.0V form Adapter AC 120V/60Hz	Test Mode :	Mode 4

Frequency (MHz)	Meter Reading (dBμV)	Factor (dB)	Emission Level (dBμV)	Limits (dBμV)	Margin (dB)	Remark
0.2500	32.90	10.14	43.04	61.75	-18.71	QP
0.2500	18.47	10.14	28.61	51.75	-23.14	AVG
0.2977	33.50	10.14	43.64	60.30	-16.66	QP
0.2977	19.91	10.14	30.05	50.30	-20.25	AVG
0.4540	40.79	9.91	50.70	56.80	-6.10	QP
0.4540	27.15	9.91	37.06	46.80	-9.74	AVG
1.7258	38.93	9.76	48.69	56.00	-7.31	QP
1.7258	26.34	9.76	36.10	46.00	-9.90	AVG
15.8377	32.85	9.87	42.72	60.00	-17.28	QP
15.8377	23.64	9.87	33.51	50.00	-16.49	AVG
19.0097	31.52	9.92	41.44	60.00	-18.56	QP
19.0097	16.03	9.92	25.95	50.00	-24.05	AVG

Remark:

1. All readings are Quasi-Peak and Average values.
2. Factor = Insertion Loss + Cable Loss.

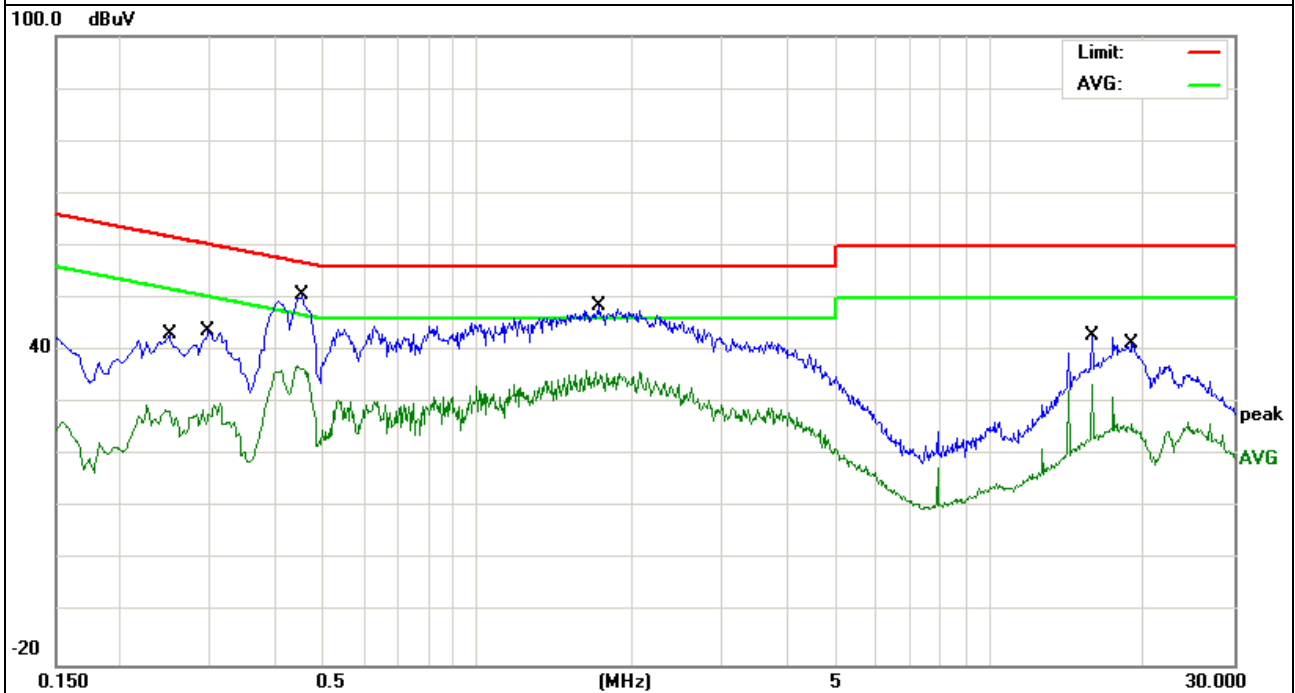

EUT :	Jimu Robot	Model Name. :	JR1601-Adapter-2
Temperature :	26 °C	Relative Humidity :	56%
Pressure :	1010hPa	Phase :	L
Test Voltage :	DC 5.0V form Adapter AC 240V/60Hz	Test Mode :	Mode 4

Frequency (MHz)	Meter Reading (dBμV)	Factor (dB)	Emission Level (dBμV)	Limits (dBμV)	Margin (dB)	Remark
0.2139	33.54	10.13	43.67	63.05	-19.38	QP
0.2139	19.51	10.13	29.64	53.05	-23.41	AVG
0.4580	42.01	9.90	51.91	56.73	-4.82	QP
0.4580	27.35	9.90	37.25	46.73	-9.48	AVG
0.9417	39.34	9.84	49.18	56.00	-6.82	QP
0.9417	25.06	9.84	34.90	46.00	-11.10	AVG
1.6337	41.35	9.77	51.12	56.00	-4.88	QP
1.6337	26.65	9.77	36.42	46.00	-9.58	AVG
1.9417	41.53	9.74	51.27	56.00	-4.73	QP
1.9417	26.10	9.74	35.84	46.00	-10.16	AVG
15.8419	32.76	9.87	42.63	60.00	-17.37	QP
15.8419	24.34	9.87	34.21	50.00	-15.79	AVG

Remark:

1. All readings are Quasi-Peak and Average values.
2. Factor = Insertion Loss + Cable Loss.

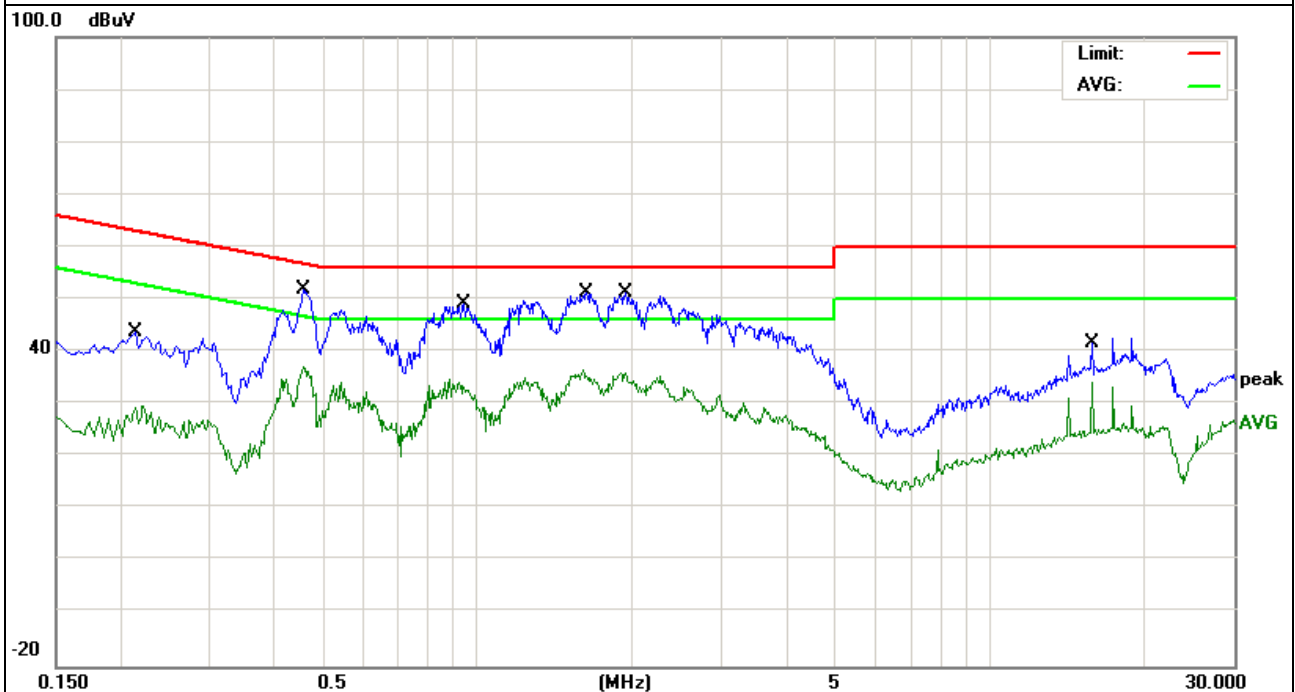

EUT :	Jimu Robot	Model Name. :	JR1601-Adapter-2
Temperature :	26 °C	Relative Humidity :	56%
Pressure :	1010hPa	Phase :	N
Test Voltage :	DC 5.0V form Adapter AC 240V/60Hz	Test Mode :	Mode 4

Frequency (MHz)	Meter Reading (dBμV)	Factor (dB)	Emission Level (dBμV)	Limits (dBμV)	Margin (dB)	Remark
0.2220	37.03	10.13	47.16	62.74	-15.58	QP
0.2220	21.43	10.13	31.56	52.74	-21.18	AVG
0.4660	42.95	9.88	52.83	56.58	-3.75	QP
0.4660	28.07	9.88	37.95	46.58	-8.63	AVG
0.5340	40.09	9.80	49.89	56.00	-6.11	QP
0.5340	25.44	9.80	35.24	46.00	-10.76	AVG
1.2940	40.95	9.81	50.76	56.00	-5.24	QP
1.2940	25.67	9.81	35.48	46.00	-10.52	AVG
1.6657	42.12	9.77	51.89	56.00	-4.11	QP
1.6657	27.10	9.77	36.87	46.00	-9.13	AVG
17.4255	32.23	9.90	42.13	60.00	-17.87	QP
17.4255	20.13	9.90	30.03	50.00	-19.97	AVG

Remark:

1. All readings are Quasi-Peak and Average values.
2. Factor = Insertion Loss + Cable Loss.

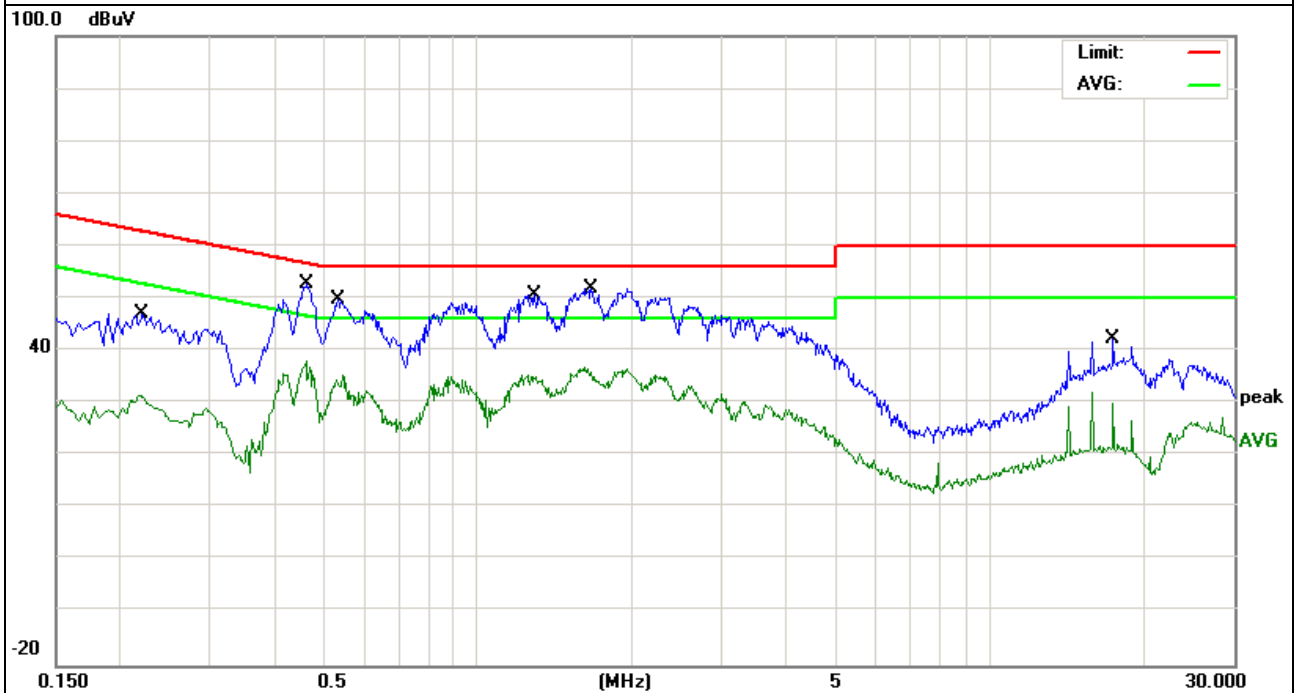

Note: pre-test all of charging mode, this mode is worst case, only provide the worst case in report.

3.2 RADIATED EMISSION MEASUREMENT

3.2.1 RADIATED EMISSION LIMITS (Frequency Range 9kHz-1000MHz)

20dBc in any 100 kHz bandwidth outside the operating frequency band. In case the emission fall within the restricted band specified on 15.205(a), then the 15.209(a) limit in the table below has to be followed.

Frequencies (MHz)	Field Strength (micorvolts/meter)	Measurement Distance (meters)
0.009~0.490	2400/F(KHz)	300
0.490~1.705	24000/F(KHz)	30
1.705~30.0	30	30
30~88	100	3
88~216	150	3
216~960	200	3
Above 960	500	3

LIMITS OF RADIATED EMISSION MEASUREMENT (Above 1000MHz)

FREQUENCY (MHz)	Class B (dBuV/m) (at 3M)	
	PEAK	AVERAGE
Above 1000	74	54

Notes:

- (1) The limit for radiated test was performed according to FCC PART 15C.
- (2) The tighter limit applies at the band edges.
- (3) Emission level (dBuV/m)=20log Emission level (uV/m).

Spectrum Parameter	Setting
Attenuation	Auto
Start Frequency	1000 MHz
Stop Frequency	10th carrier harmonic
RB / VB (emission in restricted band)	1 MHz / 1 MHz for Peak, 1 MHz / 10Hz for Average

Receiver Parameter	Setting
Attenuation	Auto
Start ~ Stop Frequency	9kHz~150kHz / RB 200Hz for QP
Start ~ Stop Frequency	150kHz~30MHz / RB 9kHz for QP
Start ~ Stop Frequency	30MHz~1000MHz / RB 120kHz for QP

3.2.2 TEST PROCEDURE

- a. The measuring distance of at 3 m shall be used for measurements at frequency up to 1GHz. For frequencies above 1GHz, any suitable measuring distance may be used.
- b. The EUT was placed on the top of a rotating table 0.8 m for below 1GHz and 1.5m for above 1GHz the ground at a 3 meter test site. The table was rotated 360 degrees to determine the position of the highest radiation.
- c. The height of the equipment or of the substitution antenna shall be 0.8 m for below 1GHz and 1.5m for above 1GHz; the height of the test antenna shall vary between 1 m to 4 m. Both horizontal and vertical polarizations of the antenna are set to make the measurement.
- d. The initial step in collecting conducted emission data is a spectrum analyzer peak detector mode pre-scanning the measurement frequency range. Significant peaks are then marked and then Quasi Peak detector mode re-measured.
- e. If the Peak Mode measured value compliance with and lower than Quasi Peak Mode Limit, the EUT shall be deemed to meet QP Limits and then no additional QP Mode measurement performed.
- f. For the actual test configuration, please refer to the related Item –EUT Test Photos.

Note:

Both horizontal and vertical antenna polarities were tested and performed pretest to three orthogonal axis. The worst case emissions were reported EUT Pre-scan X/Y/Z orientation, only worst case is presented in the report(Z orientation).

During the radiated emission test, the Spectrum Analyzer was set with the following configurations:

Frequency Band (MHz)	Function	Resolution bandwidth	Video Bandwidth
30 to 1000	QP	120 kHz	300 kHz
Above 1000	Peak	1 MHz	1 MHz
	Peak	1 MHz	10 Hz

3.2.3 DEVIATION FROM TEST STANDARD

No deviation

3.2.4 TEST SETUP

(A) Radiated Emission Test-Up Frequency Below 30MHz

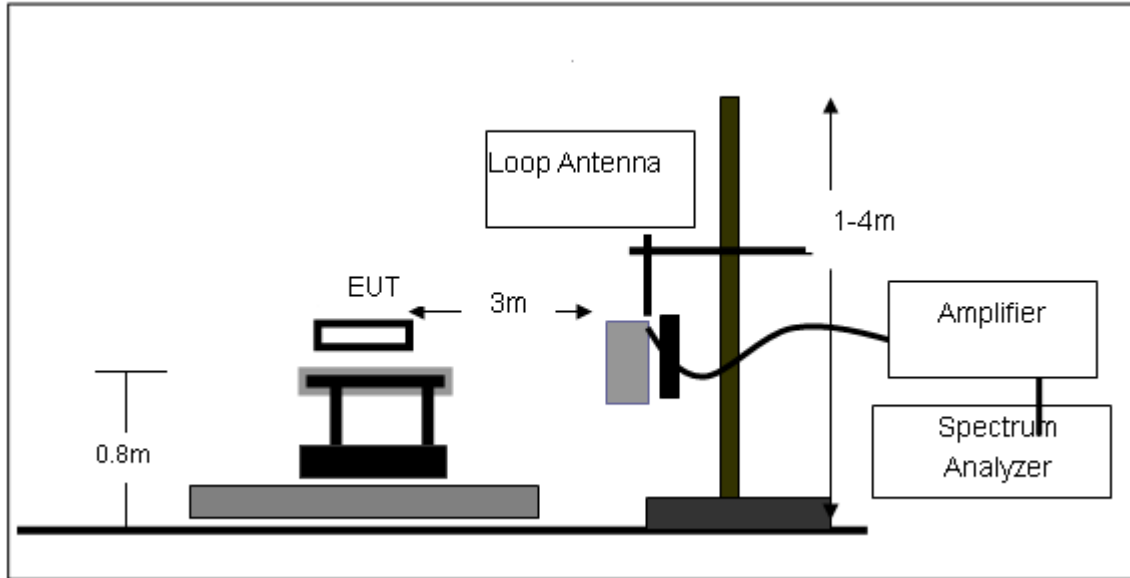

(B) Radiated Emission Test-Up Frequency 30MHz~1GHz

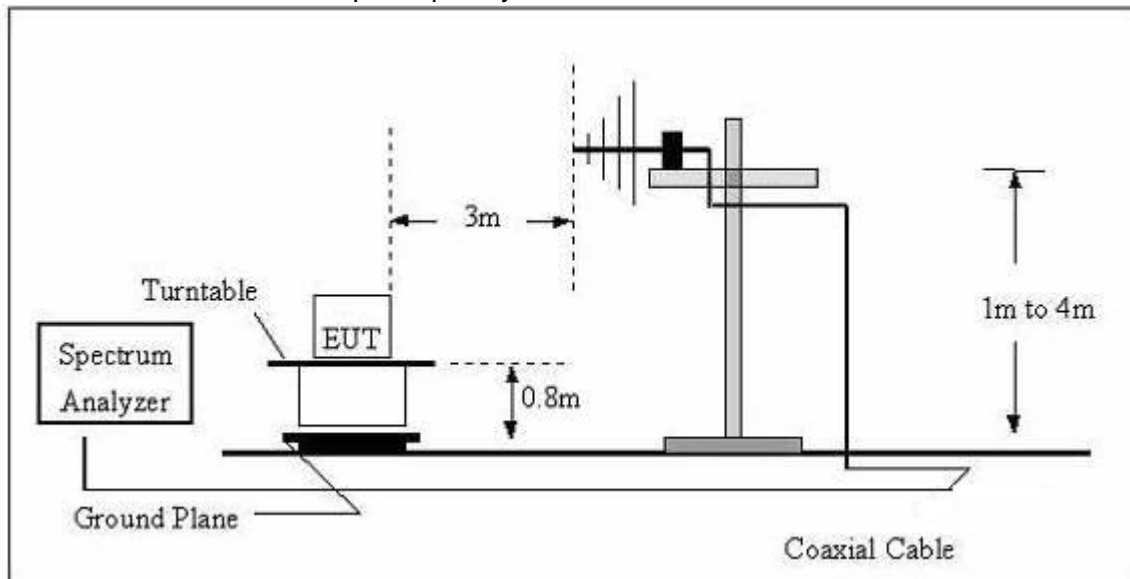

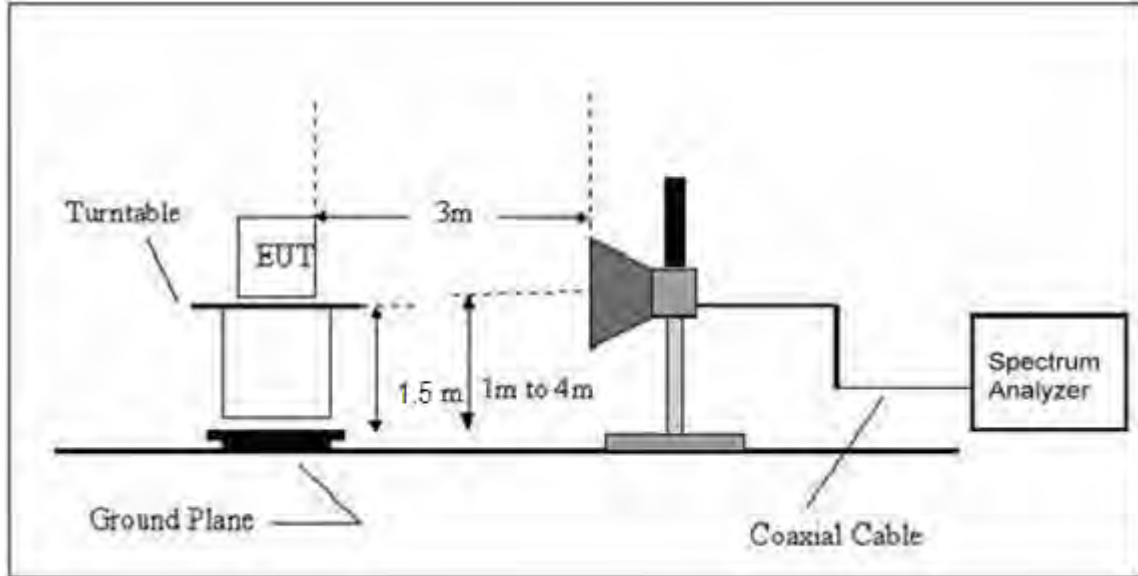
(C) Radiated Emission Test-Up Frequency Above 1GHz**3.2.5 EUT OPERATING CONDITIONS**

The EUT tested system was configured as the statements of 2.4 Unless otherwise a special operating condition is specified in the follows during the testing.

3.2.6 TEST RESULTS (BETWEEN 9KHZ – 30 MHZ)

EUT:	Jimu Robot	Model Name. :	JR1601
Temperature:	20 °C	Relative Humidity:	48%
Pressure:	1010 hPa	Test Voltage :	DC 7.4V
Test Mode :	TX	Polarization :	--

Freq. (MHz)	Reading (dBuV/m)	Limit (dBuV/m)	Margin (dB)	State P/F
--	--	--	--	N/A
--	--	--	--	N/A

NOTE:

The amplitude of spurious emissions which are attenuated by more than 20dB below the permissible value has no need to be reported.

Distance extrapolation factor = $40 \log (\text{specific distance}/\text{test distance})(\text{dB})$;

Limit line = specific limits(dBuv) + distance extrapolation factor.

3.2.7 TEST RESULTS (BETWEEN 30MHZ – 1GHZ)

EUT :	Jimu Robot	Model Name :	JR1601
Temperature :	20 °C	Relative Humidity :	48%
Pressure:	1010 hPa	Test Voltage :	DC 7.4V
Test Mode :	TX		

Polar (H/V)	Frequency	Meter Reading	Factor	Emission Level	Limits	Margin	Remark
	(MHz)	(dBuV)	(dB)	(dBuV/m)	(dBuV/m)	(dB)	
V	77.8653	14.35	9.52	23.87	40.00	-16.13	QP
V	150.5378	23.08	11.72	34.80	43.50	-8.70	QP
V	187.0954	17.03	11.60	28.63	43.50	-14.87	QP
V	334.8589	19.28	13.78	33.06	46.00	-12.94	QP
V	511.8351	21.34	17.18	38.52	46.00	-7.48	QP
V	968.9338	10.10	26.77	36.87	54.00	-17.13	QP

Remark:

Absolute Level= ReadingLevel+ Factor, Margin= Absolute Level - Limit

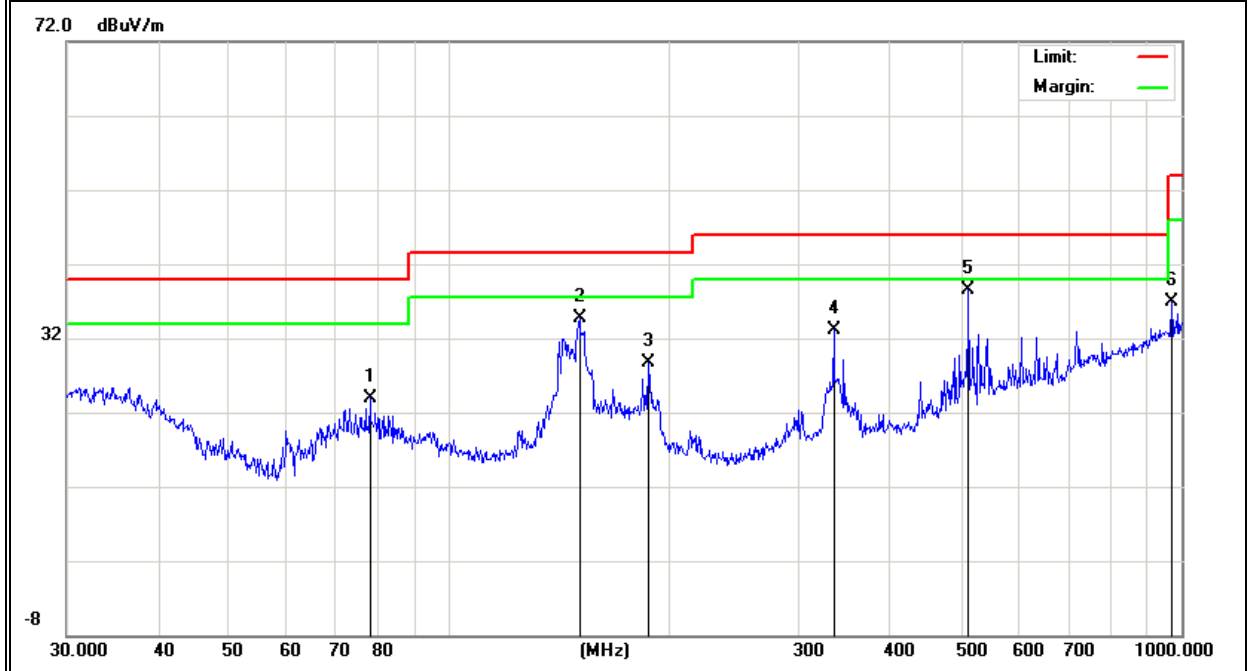

Polar (H/V)	Frequency	Meter Reading	Factor	Emission Level	Limits	Margin	Remark
	(MHz)	(dBuV)	(dB)	(dBuV/m)	(dBuV/m)	(dB)	
H	83.8156	16.30	9.14	25.44	40.00	-14.56	QP
H	149.4857	20.62	11.66	32.28	43.50	-11.22	QP
H	187.7529	25.28	11.52	36.80	43.50	-6.70	QP
H	350.4768	18.54	14.12	32.66	46.00	-13.34	QP
H	508.2581	18.22	17.23	35.45	46.00	-10.55	QP
H	909.6666	15.27	24.50	39.77	46.00	-6.23	QP

Remark:

Absolute Level= ReadingLevel+ Factor, Margin= Absolute Level - Limit

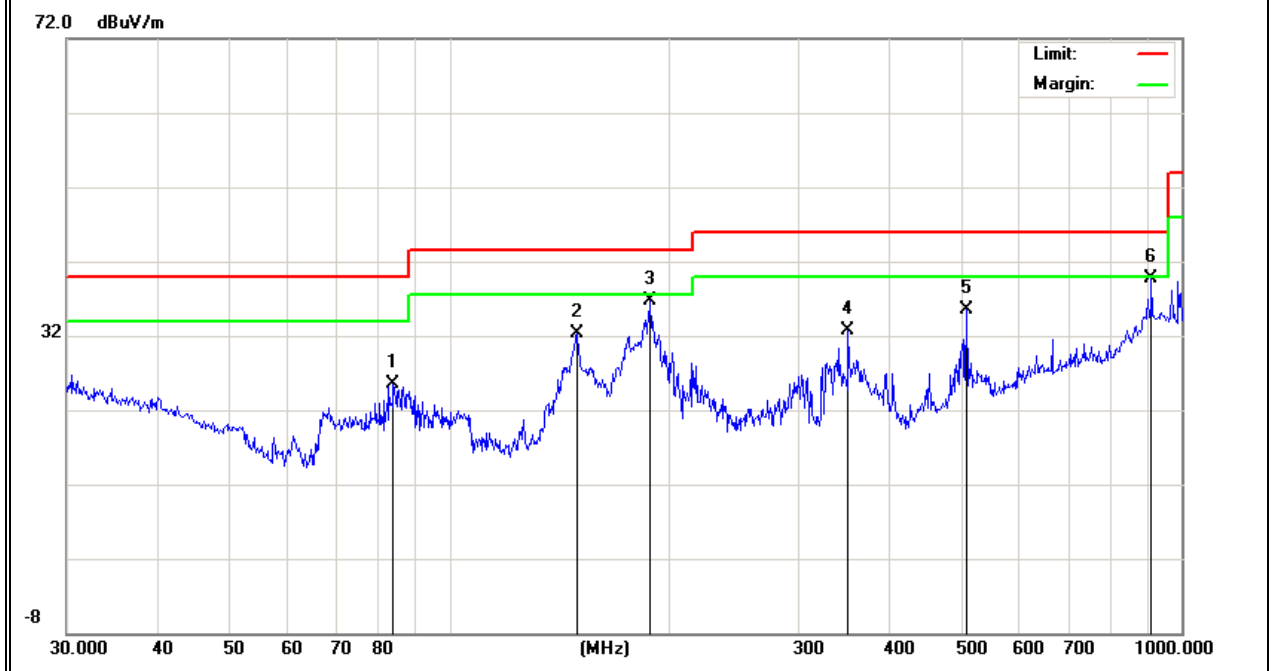

3.2.8 TEST RESULTS (ABOVE 1000 MHZ)

EUT :	Jimu Robot	Model Name :	JR1601
Temperature :	20 °C	Relative Humidity :	48%
Pressure:	1010 hPa	Test Voltage :	DC 7.4V
Test Mode :	TX		

Frequency (MHz)	Reading (dBµV)	Factor (dB)	Corrected Amplitude (dBµV/m)	Limit (dBµV/m)	Margin (dB)	Remark	Polar (H/V)
Low Channel (2402 MHz)-Above 1G							
4804.099	58.05	-3.64	61.69	74.00	-12.31	Pk	Vertical
4804.099	40.36	-3.64	44.00	54.00	-10.00	AV	Vertical
7206.214	58.17	-0.95	59.12	74.00	-14.88	Pk	Vertical
7206.214	36.33	-0.95	37.28	54.00	-16.72	AV	Vertical
4804.036	58.42	-3.64	62.06	74.00	-11.94	Pk	Horizontal
4804.036	41.26	-3.64	44.90	54.00	-9.10	AV	Horizontal
7206.148	56.37	-0.95	57.32	74.00	-16.68	Pk	Horizontal
7206.148	36.19	-0.95	37.14	54.00	-16.86	AV	Horizontal
Mid Channel (2440 MHz)-Above 1G							
4880.085	58.77	-3.68	62.45	74.00	-11.55	Pk	Vertical
4880.085	40.85	-3.68	44.53	54.00	-9.47	AV	Vertical
7320.308	58.16	-0.82	58.98	74.00	-15.02	Pk	Vertical
7320.308	39.36	-0.82	40.18	54.00	-13.82	AV	Vertical
4880.142	60.67	-3.68	64.35	74.00	-9.65	Pk	Horizontal
4880.142	43.86	-3.68	47.54	54.00	-6.46	AV	Horizontal
7320.324	58.12	-0.82	58.94	74.00	-15.06	Pk	Horizontal
7320.324	38.27	-0.82	39.09	54.00	-14.91	AV	Horizontal
High Channel (2480MHz)- Above 1G							
4960.309	58.09	-3.59	61.68	74.00	-12.32	Pk	Vertical
4960.309	40.94	-3.59	44.53	54.00	-9.47	AV	Vertical
7440.148	56.56	-0.68	57.24	74.00	-16.76	Pk	Vertical
7440.148	40.86	-0.68	41.54	54.00	-12.46	AV	Vertical
4960.206	58.32	-3.59	61.91	74.00	-12.09	Pk	Horizontal
4960.206	41.13	-3.59	44.72	54.00	-9.28	AV	Horizontal
7440.125	59.48	-0.68	60.16	74.00	-13.84	Pk	Horizontal
7440.125	38.29	-0.68	38.97	54.00	-15.03	AV	Horizontal

Remark: Absolute Level= ReadingLevel+ Factor, Margin= Absolute Level - Limit

4. EUT TEST PHOTO

Radiated Measurement Photos

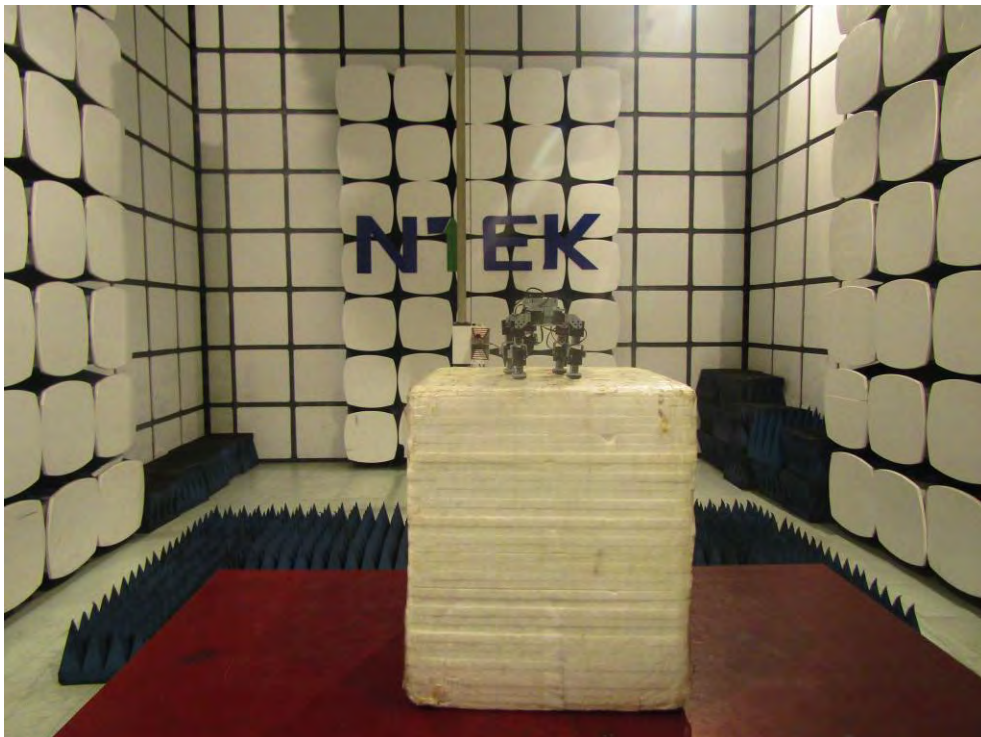
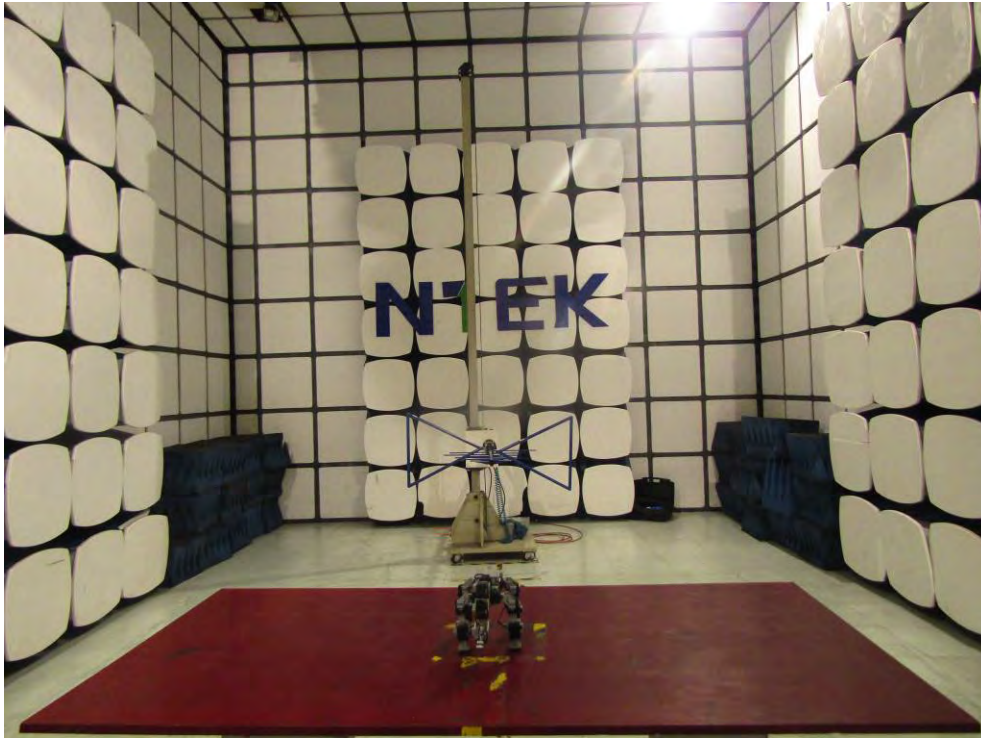

CONDUCTED EMISSION Photos

