



REPORT No. : SZ21100183S02

## Annex C Plots of System Performance Check

### System Check\_835MHz\_HAC\_RF\_E

Communication System: UID 0, CW (0); Frequency: 835 MHz;Duty Cycle: 1:1

Medium: Air Medium parameters used:  $\sigma = 0 \text{ S/m}$ ,  $\epsilon_r = 1$ ;  $\rho = 0 \text{ kg/m}^3$

Ambient Temperature : 23.2 °C;

DASY5 Configuration:

- Probe: ER3DV6 - SN2434; ConvF(1, 1, 1) @ 835 MHz; Calibrated: 2021.03.04;
- Sensor-Surface: (Fix Surface), Sensor-Surface: 0mm (Fix Surface)
- Electronics: DAE4 Sn480; Calibrated: 2021.06.22
- Phantom: HAC Test Arch with AMCC; Type: SD HAC P01 BA;
- Measurement SW: DASY52, Version 52.8 (8); SEMCAD X Version 14.6.10 (7331)

**Hearing Aid Compatibility Test (81x401x1):** Interpolated grid: dx=0.5000 mm, dy=0.5000 mm

Maximum value of Total (interpolated) = 120.64 V/m

Device Reference Point: 0, 0, -6.3 mm

Reference Value = 58.41 V/m; Power Drift = -0.14 dB

Applied MIF = 0.00 dB

RF audio interference level = 41.63 dBV/m

**Emission category: M3**

MIF scaled E-field

Grid 1 <b>M3</b> <b>41.13 dBV/m</b>	Grid 2 <b>M3</b> <b>41.62 dBV/m</b>	Grid 3 <b>M3</b> <b>40.62 dBV/m</b>
Grid 4 <b>M4</b> <b>36.95 dBV/m</b>	Grid 5 <b>M4</b> <b>37.92 dBV/m</b>	Grid 6 <b>M4</b> <b>36.45 dBV/m</b>
Grid 7 <b>M3</b> <b>41.31 dBV/m</b>	Grid 8 <b>M3</b> <b>41.63 dBV/m</b>	Grid 9 <b>M3</b> <b>40.57 dBV/m</b>

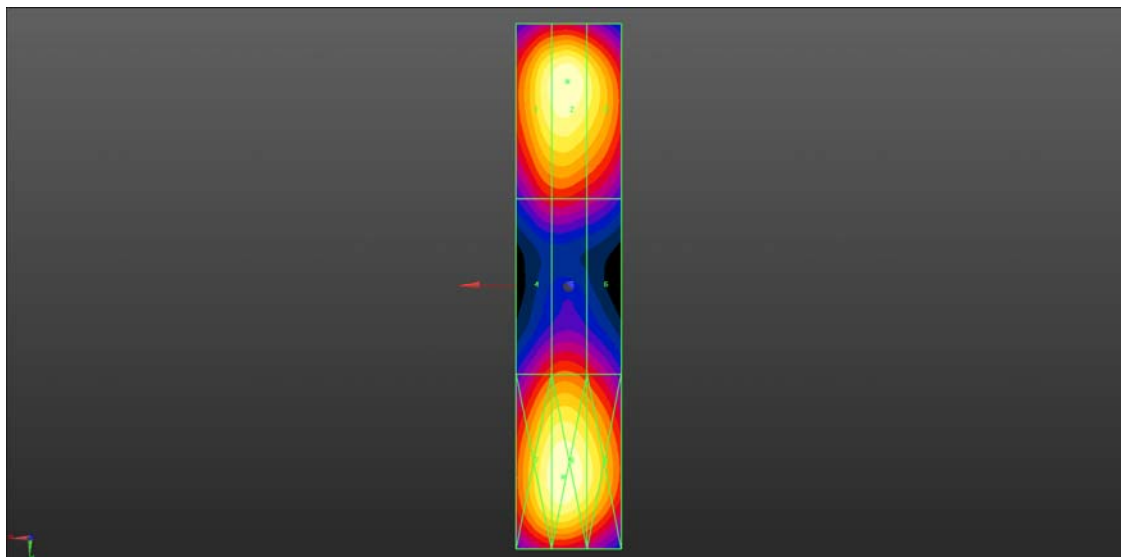
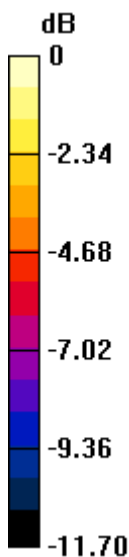

0 dB = 120.64 V/m = 41.63 dBV/m

### System Check\_1880MHz\_HAC\_RF\_E

Communication System: UID 0, CW (0); Frequency: 1880 MHz; Duty Cycle: 1:1

Medium: Air Medium parameters used:  $\sigma = 0 \text{ S/m}$ ,  $\epsilon_r = 1$ ;  $\rho = 0 \text{ kg/m}^3$

Ambient Temperature : 23.3 °C;

DASY5 Configuration:

- Probe: ER3DV6 - SN2434; ConvF(1, 1, 1) @ 1880 MHz; Calibrated: 2021.03.04;
- Sensor-Surface: (Fix Surface), Sensor-Surface: 0mm (Fix Surface)
- Electronics: DAE4 Sn480; Calibrated: 2021.06.22
- Phantom: HAC Test Arch with AMCC; Type: SD HAC P01 BA;
- Measurement SW: DASY52, Version 52.8 (8); SEMCAD X Version 14.6.10 (7331)

**Hearing Aid Compatibility Test (81x321x1):** Interpolated grid: dx=0.5000 mm, dy=0.5000 mm

Maximum value of Total (interpolated) = 97.05 V/m

Device Reference Point: 0, 0, -6.3 mm

Reference Value = 73.68 V/m; Power Drift = -0.11 dB

Applied MIF = 0.00 dB

RF audio interference level = 39.74 dBV/m

**Emission category: M2**

MIF scaled E-field

Grid 1 <b>M2</b> <b>39.24 dBV/m</b>	Grid 2 <b>M2</b> <b>39.62 dBV/m</b>	Grid 3 <b>M2</b> <b>38.56 dBV/m</b>
Grid 4 <b>M2</b> <b>39.04 dBV/m</b>	Grid 5 <b>M2</b> <b>39.56 dBV/m</b>	Grid 6 <b>M2</b> <b>38.72 dBV/m</b>
Grid 7 <b>M2</b> <b>39.33 dBV/m</b>	Grid 8 <b>M2</b> <b>39.74 dBV/m</b>	Grid 9 <b>M2</b> <b>38.81 dBV/m</b>

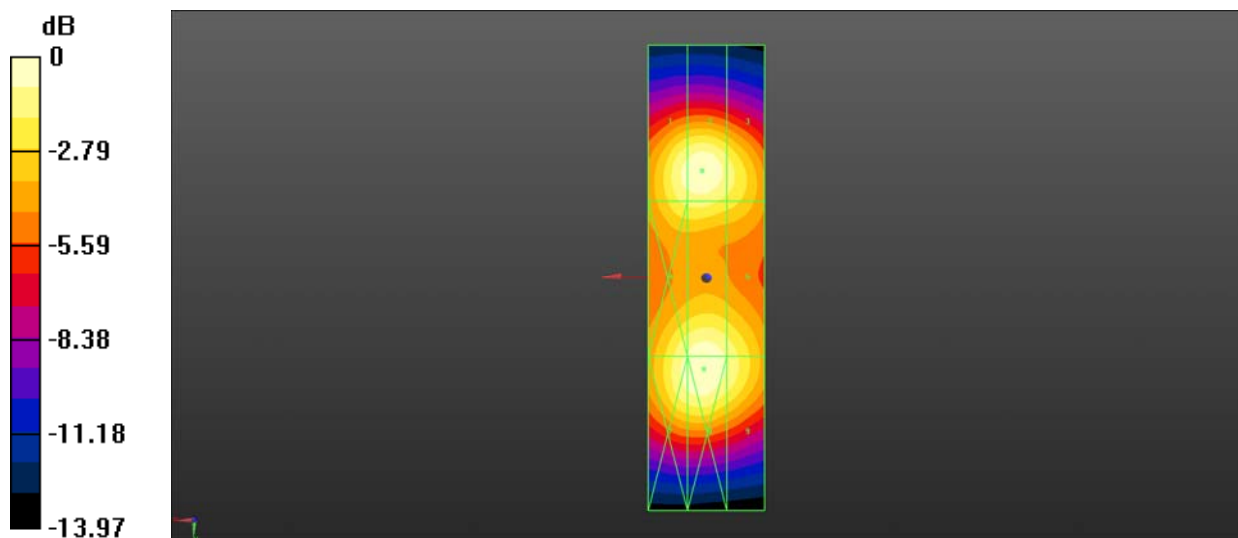

0 dB = 97.05 V/m = 39.74 dBV/m

### System Check\_2600MHz\_HAC\_RF\_E

Communication System: UID 0, CW (0); Frequency: 2600 MHz;Duty Cycle: 1:1

Medium: Air Medium parameters used:  $\sigma = 0$  S/m,  $\epsilon_r = 1$ ;  $\rho = 0$  kg/m<sup>3</sup>

Ambient Temperature : 23.2 °C

DASY5 Configuration:

- Probe: ER3DV6 - SN2434; ConvF(1, 1, 1) @ 2600 MHz; Calibrated: 2021.03.04;
- Sensor-Surface: (Fix Surface), Sensor-Surface: 0mm (Fix Surface)
- Electronics: DAE4 Sn480; Calibrated: 2021.06.22
- Phantom: HAC Test Arch with AMCC; Type: SD HAC P01 BA;
- Measurement SW: DASY52, Version 52.8 (8); SEMCAD X Version 14.6.10 (7331)

**Ch2600/Hearing Aid Compatibility Test (81x321x1):** Interpolated grid: dx=0.5000 mm, dy=0.5000 mm

Maximum value of Total (interpolated) = 96.83 V/m

Device Reference Point: 0, 0, -6.3 mm

Reference Value = 81.72 V/m; Power Drift = -0.12 dB

Applied MIF = 0.00 dB

RF audio interference level = 39.72 dBV/m

**Emission category: M2**

MIF scaled E-field

Grid 1 <b>M2</b> <b>38.95 dBV/m</b>	Grid 2 <b>M2</b> <b>39.27 dBV/m</b>	Grid 3 <b>M2</b> <b>38.13 dBV/m</b>
Grid 4 <b>M2</b> <b>39.26 dBV/m</b>	Grid 5 <b>M2</b> <b>39.72 dBV/m</b>	Grid 6 <b>M2</b> <b>38.74 dBV/m</b>
Grid 7 <b>M2</b> <b>39.13 dBV/m</b>	Grid 8 <b>M2</b> <b>39.51 dBV/m</b>	Grid 9 <b>M2</b> <b>38.39 dBV/m</b>

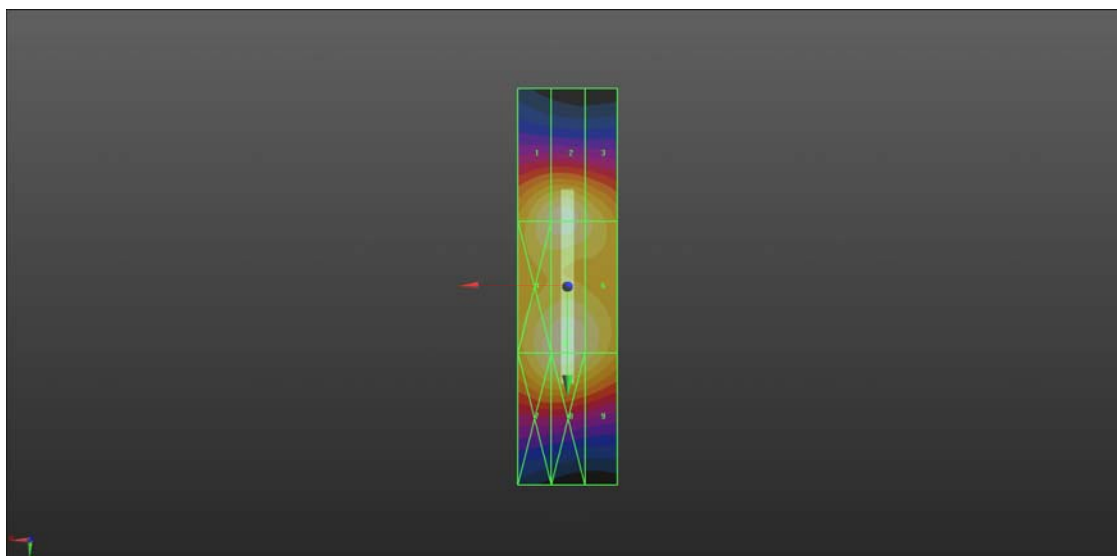
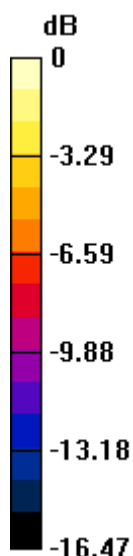

0 dB = 96.83 V/m = 39.72 dBV/m