



# Hearing Aid Compatibility (HAC) RF Emission Test Report

**APPLICANT** : Nubia Technology Co.,Ltd  
**PRODUCT NAME** : LTE Digital Mobile Phone  
**MODEL NAME** : NX627J  
**BRAND NAME** : NUBIA  
**FCC ID** : 2AHJO-NX627J  
**STANDARD(S)** : 47CFR 20.19  
ANSI C63.19-2011  
**RECEIPT DATE** : 2019-08-23  
**TEST DATE** : 2019-09-30 to 2019-10-15  
**ISSUE DATE** : 2019-10-16

Edited by: Liang Yumei  
Liang Yumei (Rapporteur)  
Approved by: Peng Huarui  
Peng Huarui (Supervisor)

**NOTE:** This document is issued by MORLAB, the test report shall not be reproduced except in full without prior written permission of the company. The test results apply only to the particular sample(s) tested and to the specific tests carried out which is available on request for validation and information confirmed at our website.





# DIRECTORY

1. Attestation of Testing Summary .....	5
2. Technical Information.....	6
2.1. Applicant and Manufacturer Information.....	6
2.2. Equipment under Test (EUT) Description.....	6
2.3. Photographs of the EUT.....	8
2.4. Applied Reference Documents .....	8
3. RF Audio Interference Level.....	9
4. Air Interface and Operating Mode .....	10
5. HAC (RF) Measurement System .....	12
5.1. RF Measurement Setup.....	12
5.2. E-Field Probe .....	13
5.3. Data Acquisition Electronics (DAE).....	14
6. RF Measurement Procedure.....	15
6.1. General Guidance .....	15
6.2. RF Test Instructions .....	16
7. Test Equipment List.....	18
8. System Validation .....	19
8.1. Test setup.....	19
8.2. Validation Result.....	20
9. Modulation Interference Factor .....	21
10. Conducted Power .....	23
11. Low-power Exemption .....	29
12. Summary Test Results .....	31
13. Uncertainty Assessment.....	33
<b>Annex A General Information</b>	



REPORT No.: SZ19070123S01

**Annex B Test Setup Photos**  
**Annex C Plots of Performance System Check**  
**Annex D Plots of RF Emission Test Results**  
**Annex E DASY Calibration Certificate**



<b>Change History</b>		
<b>Version</b>	<b>Date</b>	<b>Reason for change</b>
1.0	2019-10-16	First edition



# 1. Attestation of Testing Summary

Air Interface	Frequency Band	E-field M-Rating
GSM CMRS Voice	GSM850	M3
	GSM1900	M3
CDMA	CDMA2000 BC0	M4
	CDMA2000 BC1	M4
LTE	LTE Band 38	M4
	LTE Band 40	M4
	LTE Band 41	M4



## 2. Technical Information

**Note:** Provide by Applicant.

### 2.1. Applicant and Manufacturer Information

<b>Applicant:</b>	Nubia Technology Co.,Ltd
<b>Applicant Address:</b>	10/F, Tower A, Hans Innovation Mansion, North Ring Rd., No.9018, High-Tech Park, Nanshan District, Shenzhen, China
<b>Manufacturer:</b>	Nubia Technology Co.,Ltd
<b>Manufacturer Address:</b>	10/F, Tower A, Hans Innovation Mansion, North Ring Rd., No.9018, High-Tech Park, Nanshan District, Shenzhen, China

### 2.2. Equipment under Test (EUT) Description

<b>EUT Type:</b>	LTE Digital Mobile Phone
<b>Hardware Version:</b>	NX627J_V1MB
<b>Software Version:</b>	NX627J_ENCommon_V1.00
<b>Frequency Bands:</b>	GSM 850: 824.2 MHz ~ 848.8 MHz GSM 1900: 1850.2 MHz ~ 1909.8 MHz WCDMA Band II: 1852.4 MHz ~ 1907.6 MHz WCDMA Band IV: 1710 MHz ~ 1755 MHz WCDMA Band V: 826.4 MHz ~ 846.6 MHz CDMA BC 0: 824.7 MHz ~ 848.31 MHz CDMA BC 1: 1850 MHz ~ 1910 MHz LTE Band 2: 1850 MHz ~ 1910 MHz LTE Band 4: 1710 MHz ~ 1755 MHz LTE Band 5: 824 MHz ~ 849 MHz LTE Band 7: 2500 MHz ~ 2570 MHz LTE Band 12: 699 MHz ~ 716 MHz LTE Band 17: 704 MHz ~ 716 MHz LTE Band 18: 815 MHz ~ 830 MHz LTE Band 19: 830 MHz ~ 845 MHz LTE Band 25: 1850 MHz ~ 1915 MHz LTE Band 26: 814 MHz ~ 849 MHz LTE Band 30: 2305 MHz ~ 2315 MHz LTE Band 38: 2570 MHz ~ 2620MHz LTE Band 40A: 2305 MHz ~ 2315 MHz LTE Band 40B: 2350 MHz ~ 2360 MHz LTE Band 41: 2555 MHz ~ 2655 MHz



	LTE Band 66: 1710 MHz ~ 1780 MHz WLAN 2.4GHz: 2412 MHz ~ 2462 MHz WLAN 5.2GHz: 5180 MHz ~ 5240 MHz WLAN 5.3GHz: 5260 MHz ~ 5320 MHz WLAN 5.5GHz: 5500 MHz ~ 5720 MHz WLAN 5.8GHz: 5745 MHz ~ 5825 MHz Bluetooth: 2402 MHz ~ 2480 MHz
<b>Modulation Mode:</b>	GSM/GPRS: GMSK EDGE: 8PSK WCDMA: QPSK/16QAM 1XRTT: QPSK EV-DO Rev.0/A/B: QPSK LTE: QPSK/16QAM/64QAM 802.11b: DSSS 802.11a/g/n-HT20/HT40/ac-VHT20/ac-VHT40: OFDM BR+EDR: GFSK(1Mbps), $\pi/4$ -DQPSK(2Mbps), 8-DPSK(3Mbps) Bluetooth LE: GFSK(1Mbps), $\pi/4$ -DQPSK(2Mbps)
<b>Antenna type:</b>	WWAN: Fixed Internal WLAN: PIFA Antenna Bluetooth: PIFA Antenna
<b>Battery:</b>	3900mAh/3.82V
<b>SIM cards description:</b>	For dual SIM card version, both the SIM 1 and SIM 2 are the same chipset unit and tested as a single chipset, the SIM 1 was selected for testing.



## 2.3. Photographs of the EUT

**Note:** Please refer to the External Photos for the Photos of the EUT

## 2.4. Applied Reference Documents

Leading reference documents for testing:

No.	Identity	Document Title	Method determination /Remark
1	47 CFR§20.19	Hearing aid-compatible mobile handsets.	No deviation
2	ANSI C63.19-2011	American National Standard Methods of Measurement of Compatibility between Wireless Communications Devices and Hearing Aids	No deviation
3	KDB 285076 D01v05	HAC Guidance	No deviation



### 3. RF Audio Interference Level

FCC wireless hearing aid compatibility rules ensure that consumers with hearing loss are able to access wireless communications services through a wide selection of handsets without experiencing disabling radio frequency (RF) interference or other technical obstacles. To define and measure the hearing aid compatibility of handsets, in CFR47 part 20.19 ANSI C63.19 is referenced.

A handset is considered hearing aid-compatible for acoustic coupling if it meets a rating of at least M3 under ANSI C63.19, and A handset is considered hearing aid compatible for inductive coupling if it meets a rating of at least T3. According to ANSI C63.19 2011 version, for acoustic coupling, the RF electric field emissions of wireless communication devices should be measured and rated according to the emission level as below.

**Table 3.1 WD RF audio Interference level categories in logarithmic units**

Emission Categories	E-field Emissions	
	<960MHz	>960MHz
M1	50 to 55 dB (V/m)	45 to 50 dB (V/m)
M2	45 to 50 dB (V/m)	35 to 40 dB (V/m)
M3	40 to 45 dB (V/m)	30 to 35 dB (V/m)
M4	< 40 dB (V/m)	< 30 dB (V/m)

**Table 3.2 System performance classification table**

System classification	Category sum
	Hearing aid category + telephone category
Usable	Hearing aid category + telephone category = 4
Normal use	Hearing aid category + telephone category = 5
Excellent performance	Hearing aid category + telephone category = ≥6

## 4. Air Interface and Operating Mode

Air Interface	Band	Transport Type	Simultaneous Transmitter	Name of Voice Service	Power Reduction
GSM	GSM850	VO	WLAN&BT	CMRS Voice	Yes
	GSM1900				Yes
	EDGE850	DT	WLAN&BT	N/A	Yes
	EDGE1900				Yes
WCDMA (UMTS)	Band II	VO	WLAN&BT	CMRS Voice	Yes
	Band IV				Yes
	Band V				Yes
CDMA	BC0	VO	WLAN&BT	CMRS Voice	No
	BC1	VO	WLAN&BT	CMRS Voice	Yes
	EVDO	DT	WLAN&BT	N/A	Yes
FDD-LTE	Band 2	VD	WLAN&BT	VoLTE	Yes
	Band 4				Yes
	Band 5				Yes
	Band 7				Yes
	Band 12				Yes
	Band 17				Yes
	Band 18				Yes
	Band 19				Yes
	Band 25				Yes
	Band 26				Yes
	Band 30				Yes
Band 66	Yes				
TDD-LTE	Band 38	VD	WLAN&BT	VoLTE	Yes
	Band 40				Yes
	Band 41				Yes
WiFi	2450	DT	GSM, LTE, CDMA, WCDMA	N/A	No
	5200 (U-NII-1)				No
	5300 (U-NII-2A)				No
	5500 (U-NII-2C)				No
	5800 (U-NII-3)				No
BT	2450	DT	GSM, LTE, CDMA, WCDMA	N/A	No



**Where:**

VO=Voice Only

DT=Digital Transport only

VD=CMRS and IP Voice Service over Digital Transport

BT=Bluetooth

\* Ref Lev in accordance with 7.4.2.1 of ANSI C63.19-2011 and the July 2012 VoLTE interpretation

\*\* Ref Lev -20 dBm0

\*\*\* Ref Lev XYNet established by KDB Inquiry NNNNNN @ -16 dBm0

**Note:**

- 1) Air Interface/Band MHz: List of all air interfaces and bands supported by the handset.
- 2) Type: For each air interface, indicate the type of voice transport mode:
  - i. VO = legacy Cellular Voice Service, from Table 7.1 in 7.4.2.1 of ANSI C63.19-2011;
  - ii. DT = Digital Transport only (no voice); and
  - iii. VD = IP Voice Service over Digital Transport.
- 3) Simultaneous Transmitter: Indicate any air interface/bands that operate in simultaneous or concurrent service transmission mode.
- 4) Name of Voice Service: See Q4 in 285076 D03 HAC FAQ for further clarification.
  - a) Ref Lev in accordance with 7.4.2.1 of ANSI C63.19-2011 and the July 2012 VoLTE interpretation
  - b) \*\* Ref Lev -20 dBm0
  - c) \*\*\* Ref Lev XYNet established by KDB Inquiry NNNNNN @ -16 dBm0
- 5) Power Reduction: If the 1900 MHz band GSM air interface was tested using the option to reduce the power, state in the test report the maximum power in the 1900 MHz band, and the reduced power used for testing compliance to demonstrate compliance to the requirement that power be reduced by no more than 2.5 dB.
- 6) The EUT respectively defined the top and bottom antenna maximum output power in the software and the default antenna including TX & RX is the bottom antenna. The top and bottom antenna will switch automatically according to the receiver signal strength and maximum transmission power level. When power reduction is applied, all of WWAN bands except CDMA 2000 BC0 will reduce power and the reduced power will be used for the top antenna RF Emission testing.

## 5. HAC (RF) Measurement System

### 5.1. RF Measurement Setup

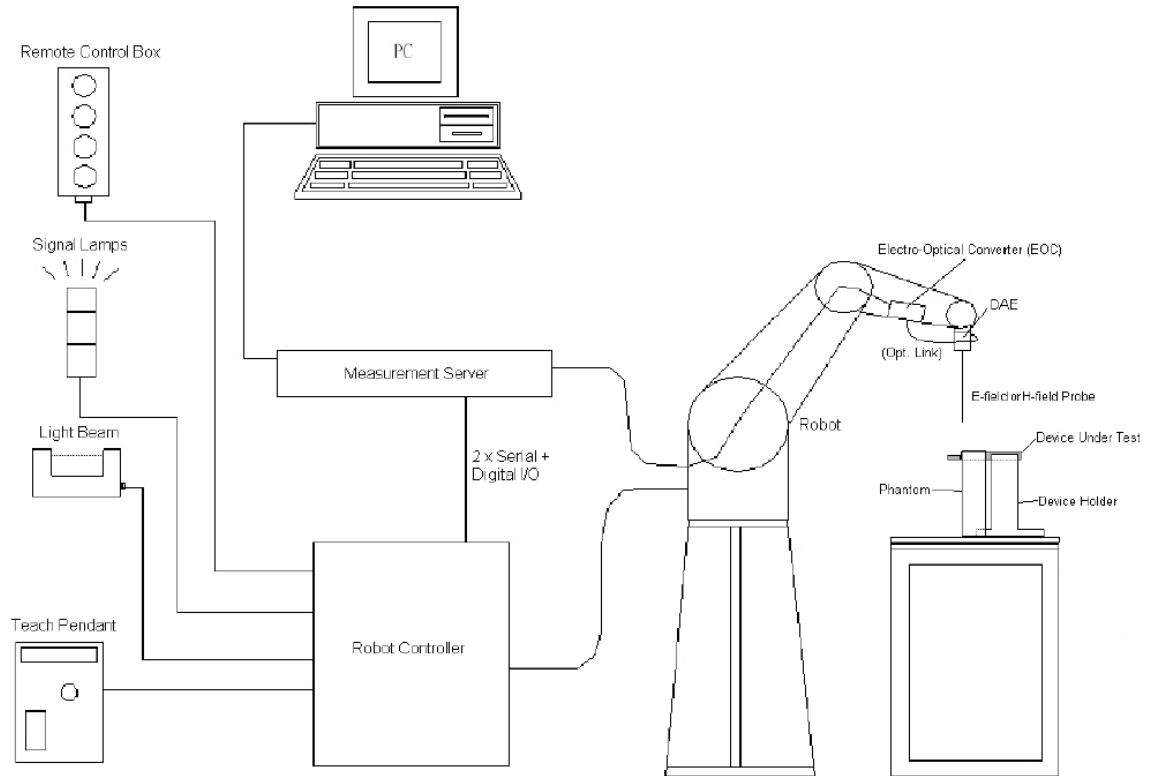



Fig 5.1 SPEAG RF System Configurations

## 5.2. E-Field Probe

The RF measurement is conducted with the dosimetric probe (manufactured by SPEAG). The probe is specially designed and calibrated for use with high permittivity. The dosimetric probe has special calibration at different frequency. This probe has a built in optical surface detection system to prevent from collision with phantom.

### E-Field Probe Specification

#### <ER3DV6>

Construction	One dipole parallel, two dipoles normal to probe axis Built-in shielding against static charges	 <p style="text-align: center;"><b>Fig 5.2 Photo of ER3DV6</b></p>
Calibration	In air from 100 MHz to 3.0 GHz (Absolute accuracy $\pm 6.0\%$ , $k=2$ )	
Frequency	10 MHz to 6 GHz; Linearity: $\pm 0.2$ dB	
Directivity	$\pm 0.2$ dB in HSL (rotation around probe axis) $\pm 0.4$ dB in HSL (rotation normal to probe axis)	
Dynamic Range	2 V/m to 1000 V/m (M3 or better device readings fall well below diode compression point)	
Linearity	$\pm 0.2$ dB	
Dimensions	Overall length: 330 mm (Tip: 16 mm) Tip diameter: 8 mm (Body: 12 mm) Distance from probe tip to dipole centers: 2.5 mm	

#### Probe Tip Description:

HAC field measurements take place in the close near field with high gradients. Increasing the measuring distance from the source will generally decrease the measured field values (in case of the validation dipole approx. 10% per mm).

### 5.3. Data Acquisition Electronics (DAE)

The data acquisition electronics(DAE) consists of a highly sensitive electrometer-grade preamplifier with auto-zeroing, a channel and gain-switching multiplexer, a fast 16 bit AD-converter and a command decoder and control logic unit. Transmission to the measurement server is accomplished through an optical downlink for data and status information as well as an optical uplink for commands and the clock. The input impedance of the DAE is 200 MOhm; the inputs are symmetrical and floating. Common mode rejection is above 80 dB.



Fig 5.3 Photo of DAE

## 6. RF Measurement Procedure

### 6.1. General Guidance

Referenced from ANSI C63.19 -2011 section 5.5.1:

1. Confirm the proper operation of the field probe, probe measurement system, and other instrumentation and the positioning system.
2. Position the WD in its intended test position.
3. Set the WD to transmit a fixed and repeatable combination of signal power and modulation characteristic that is representative of the worst case (highest interference potential) encountered in normal use. Transiently occurring start-up, changeover, or termination conditions, or other operations likely to occur less than 1% of the time during normal operation, may be excluded from consideration. Transiently occurring start-up, changeover, or termination conditions, or other operations likely to occur less than 1% of the time during normal operation, may be excluded from consideration.
4. The center sub-grid shall be centered on the T-Coil mode perpendicular measurement point or the acoustic output, as appropriate. Locate the field probe at the initial test position in the 50 mm by 50 mm grid, which is contained in the measurement plane, refer to illustrated in Figure 8.2. If the field alignment method is used, align the probe for maximum field reception.
5. Record the reading at the output of the measurement system.
6. Scan the entire 50 mm by 50 mm region in equality spaced increments and record the reading at each measurement point, The distance between measurement points shall be sufficient to assure the identification of the maximum reading.
7. Identify the five contiguous sub-grids around the center sub-grid whose maximum reading is the lowest of all available choices. This eliminates the three sub-grids with the maximum readings. Thus, the six areas to be used to determine the WD's highest emissions are identified.
8. Identify the maximum reading within the non-excluded sub-grids identified in step 7).
9. Convert the maximum reading identified in step 8) to RF audio interference level, in, V/m, by taking the square root of the reading and then dividing it by the measurement system transfer function, established in ANSI C63.19 -2011 section 5.5.1.1. Convert the result to dB(V/m) by taking the base-10 logarithm and multiplying it by 20. Expressed as a formula:

$$\text{RF audio interference level in dB(V/m)} = 20 \times \log(R_{\max}^{1/2}/TF),$$

where  $R_{\max}$  is the maximum reading.

10. The RF audio interference level in dB (V/m) is obtained by adding the MIF (in dB) to the maximum steady-state rms field-strength reading, in dB (V/m)
11. Compare this RF audio interference level with the categories in ANSI C63.19-2011 clause 8 and record the resulting WD category rating.

## 6.2. RF Test Instructions

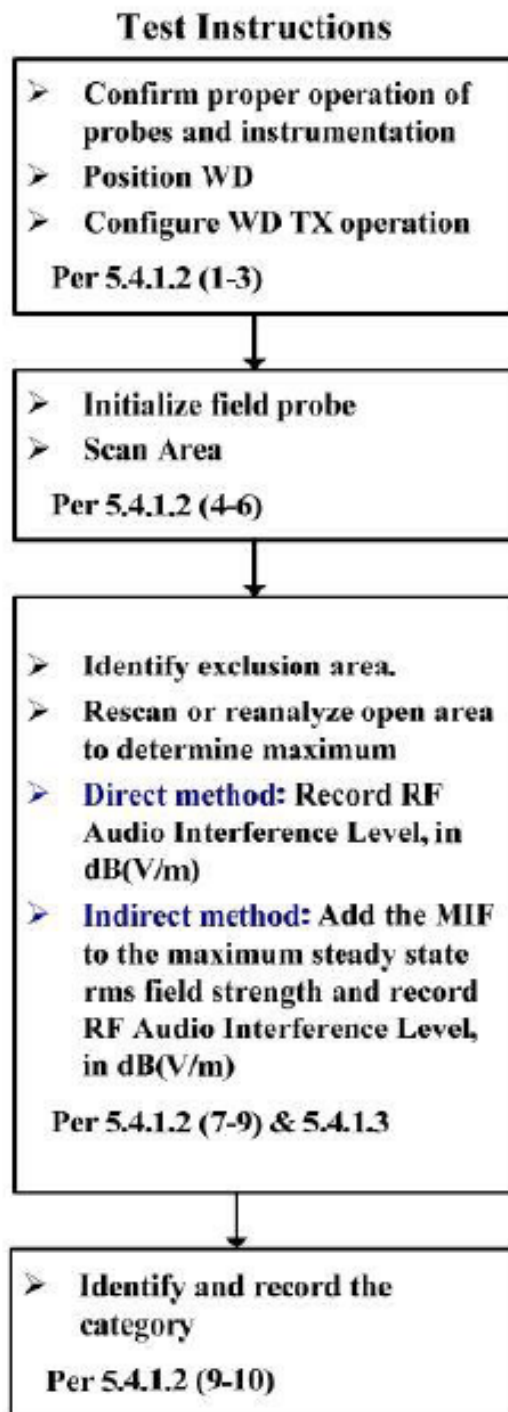

Fig 6.1 WD near-field emission scan flowchart



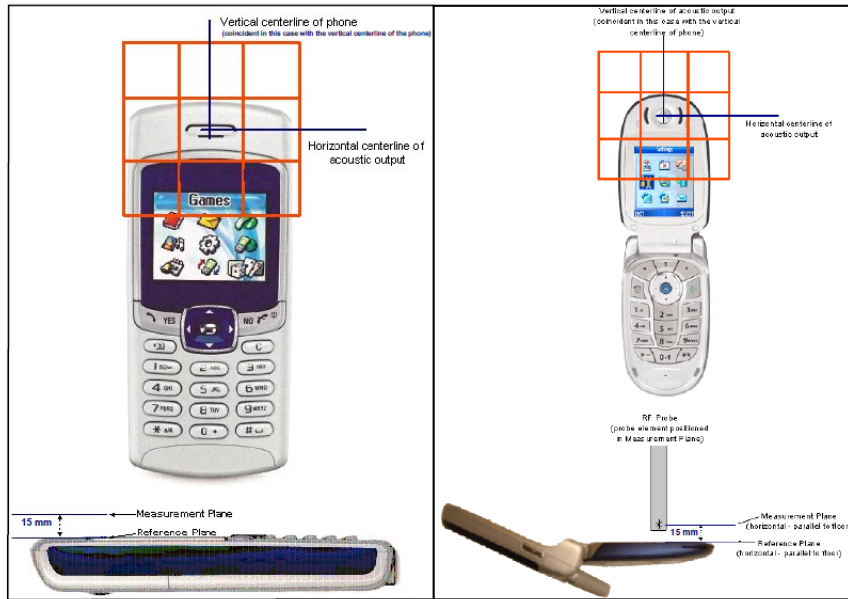

Fig 6.2 WD reference and plane for RF emission measurements

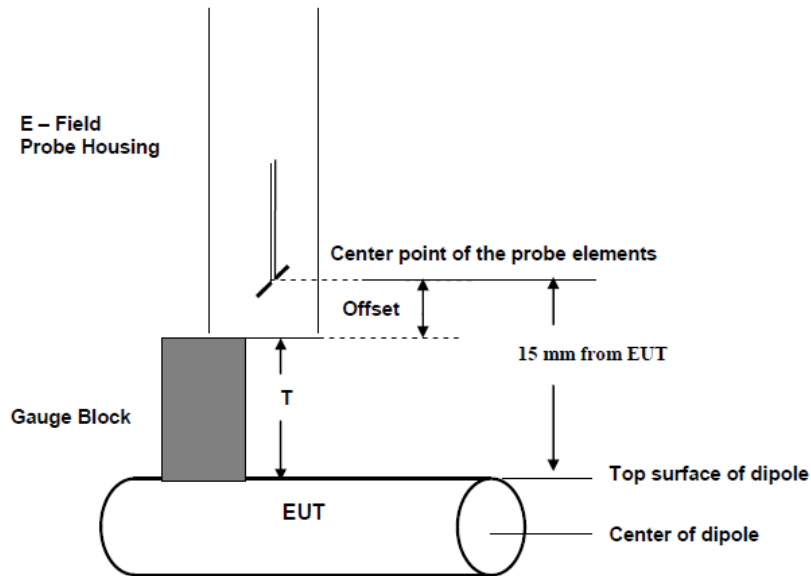

Fig 6.3 Gauge block with E-field probe



## 7. Test Equipment List

Manufacturer	Name of Equipment	Type/Model	Serial Number	Calibration	
				Last Cal.	Due Date
SPEAG	Isotropic E-Field Probe	ER3DV6	2434	2018.10.18	2019.10.17
SPEAG	Audio Holder	N/A	1094	NCR	NCR
SPEAG	835MHz Calibration Dipole	CD835V3	1113	2018.10.23	2019.10.22
SPEAG	1880MHz Calibration Dipole	CD1880V3	1111	2018.10.23	2019.10.22
SPEAG	2450MHz Calibration Dipole	CD2450V3	1074	2018.11.23	2019.11.22
SPEAG	2600MHz Calibration Dipole	CD2600V3	1010	2018.10.23	2019.10.22
SPEAG	Data Acquisition Electronics	DAE4	480	2019.04.11	2020.04.10
R&S	Base Station	CMU200	107082	2019.09.10	2020.09.09
R&S	Network Emulator	CMW500	124534	2019.04.17	2020.04.16
Agilent	Power Meter	E4416A	MY45102093	2019.04.17	2020.04.16
Agilent	Signal Generator	N5182B	MY53050509	2018.11.23	2019.11.22
Anritsu	Power Sensor	MA2411B	N/A	2018.11.23	2019.11.22
Anritsu	Power Meter	NRVD	101066	2018.11.23	2019.11.22
mini-circuits	Amplifier	ZHL-42W+	608501717	NCR	NCR
Agilent	Dual Directional Coupler	778D	50422	NA	NA

## 8. System Validation

According to ANSI C63.19, before hearing aid testing commences, the experimental setup shall be validated. Subclauses 6.3.1 through 6.3.5 include a set of pretest procedures designed to validate the experimental setup to ensure the accuracy of the results. To verify that the hearing aid performs per the manufacturer's specifications, 6.3.5 advises that the hearing aid be pretested per ANSI S3.22.

### 8.1. Test setup

1. In the simplified setup for system evaluation, the EUT is replaced by a calibrated dipole and the power source is replaced by a continuous wave which comes from a signal generator.
2. Position the E-field probe at a 15 mm distance from the top surface of the dipole, which is also fixed in an appropriate fixture.
3. Make sure that the desired measuring channel of the probe is aligned for maximum reception of the E-field generated by the dipole. This may be accomplished by rotating the probe until the maximum value is located. The E-field probe shall have been calibrated over the frequency range to be measured using standard calibration techniques.
4. Adjust the power level (20dBm  $\rightarrow$  100mW) of the signal generator at the initial starting frequency such that the desired E-field strength at the 15 mm distance from the tip of the dipole is achieved. Setting the field strength to be in the range of category M2 is advised.
5. Step the frequency in increments of  $\leq 1\%$ , adjusting the power fed into the dipole such that the desired E-field strength is maintained.

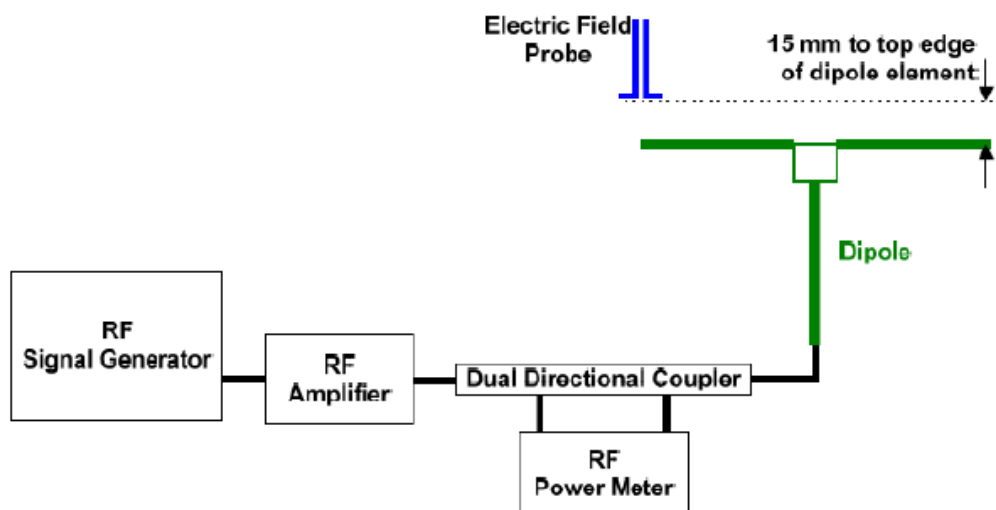

Fig 8.1 WD dipole calibration procedure

## 8.2. Validation Result

After testing, record the frequency and signal generator setting at each frequency for use during the actual immunity test. Comparing to the original E-field value provided by SPEAG, the verification data should be within its specification of 25 %. Table 6.1 shows the target value and measured value. The table below indicates the system performance check can meet the variation criterion and the plots can be referred to appendix A of this report. Deviation = ((Average E-field Value) - (Target value)) / (Target value) \* 100%

Frequency (MHz)	Input Power (mW)	Target Value (V/m)	E-Field above high end (V/m)	E-Field above low end (V/m)	Average Value (V/m)	Deviation (%)	Limit (%)	Date
835	100	110.80	120.78	120.5	120.64	8.88	±12.8	2019.09.30
1880	100	89.50	96.72	95.5	96.11	7.39	±12.8	2019.10.15
2450	100	86.80	94.51	92.26	93.385	7.59	±12.8	2019.09.30
2600	100	86.80	94.62	91.83	93.225	7.40	±12.8	2019.09.30



## 9. Modulation Interference Factor

The HAC Standard ANSI C63.19-2011 defines a new scaling using the Modulation Interference Factor (MIF). For any specific fixed and repeatable modulated signal, a modulation interference factor (MIF, expressed in dB) may be developed that relates its interference potential to its steady-state rms signal level or average power level.

This factor is a function only of the audio-frequency amplitude modulation characteristics of the signal and is the same for field-strength and conducted power measurements. It is important to emphasize that the MIF is valid only for a specific repeatable audio-frequency amplitude modulation characteristic. Any change in modulation characteristic requires determination and application of a new MIF.

The Modulation Interference factor (MIF, in dB) is added to the measured average E-field (in dBV/m) and converts it to the RF Audio Interference level (in dBV/m). This level considers the audible amplitude modulation components in the RF E-field. CW fields without amplitude modulation are assumed to not interfere with the hearing aid electronics. Modulations without time slots and low fluctuations at low frequencies have low MIF values, TDMA modulations with narrow transmission and repetition rates of few 100 Hz have high MIF values and give similar classifications as ANSI C63.19-2011. ER3D, EF3D and EU2D E-field probes have a bandwidth <10 kHz and can therefore not evaluate the RF envelope in the full audio band. DASY52 is therefore using the indirect measurement method according to ANSI C63.19-2011 which is the primary method. These near field probes read the averaged E-field measurement. Especially for the new high peak-to-average (PAR) signal types, the probes shall be linearized by PMR calibration in order to not overestimate the field reading. Probe Modulation Response (PMR) calibration linearizes the probe response over its dynamic range for specific modulations which are characterized by their UID and result in an uncertainty specified in the probe calibration certificate. The MIF is characteristic for a given waveform envelope and can be used as a constant conversion factor if the probe has been PMR calibrated. The evaluation method for the MIF is defined in ANSI C63.19-2011 section D.7. An RMS demodulated RF signal is fed to a spectral filter (similar to an A weighting filter) and forwarded to a temporal filter acting as a quasi-peak detector. The averaged output of these filtering is scaled to a 1 kHz 80% AM signal as reference. MIF measurement requires additional instrumentation and is not well suited for evaluation by the end user with reasonable uncertainty. It may alternatively be determined through analysis and simulation, because it is constant and characteristic for a communication signal. DASY52 uses well-defined signals for PMR calibration. The MIF of these signals has been determined by simulation and it is automatically applied. The MIF measurement uncertainty is estimated as follows, declared by HAC equipment provider SPEAG, for modulation frequencies from slotted waveforms with fundamental frequency and at least 2 harmonics within 10 kHz:



0.2 dB for MIF	0.5 dB for MIF	1 dB for MIF
-7dB to +5 dB	-13dB to +11 dB	> -20 dB

MIF values applied in this test report were provided by the HAC equipment provider of SPEAG, and the worst values for all air interface are listed below to be determine the Low-power Exemption.

UID	Communication System Name	MIF(dB)
10021	GSM-FDD(TDMA,GMSK)	3.63
10025	EDGE-FDD (TDMA, 8PSK, TN 0)	3.75
10460	UMTS-FDD(WCDMA, AMR)	-25.43
10225	UMTS-FDD (HSPA+)	-20.39
10081	CDMA2000 (1xRTT, RC3 Full Rate)	-19.71
10295	CDMA2000 (1xRTT, RC1 SO3, 1/8th Rate 25 fr.)	3.26
10403	CDMA2000 (1xEV-DO)	-17.67
10169	LTE-FDD(SC-FDMA,1RB,20MHz,QPSK)	-15.63
10170	LTE-FDD(SC-FDMA,1RB,20MHz,16-QAM)	-9.76
10179	LTE-FDD(SC-FDMA,1RB,20MHz,64-QAM)	-9.93
10181	LTE-FDD(SC-FDMA,1RB,15MHz,QPSK)	-15.63
10175	LTE-FDD(SC-FDMA,1RB,10MHz,QPSK)	-15.63
10177	LTE-FDD(SC-FDMA,1RB,5MHz,QPSK)	-15.63
10184	LTE-FDD(SC-FDMA,1RB,3MHz,QPSK)	-15.62
10187	LTE-FDD(SC-FDMA,1RB,1.4MHz,QPSK)	-15.62
10172	LTE-TDD (SC-FDMA, 1 RB, 20 MHz, QPSK)	-1.62
10173	LTE-TDD (SC-FDMA, 1 RB, 20 MHz, 16-QAM)	-1.44
10174	LTE-TDD (SC-FDMA, 1 RB, 20 MHz, 64-QAM)	-1.54
10240	LTE-TDD (SC-FDMA, 1 RB, 15 MHz, QPSK)	-1.62
10237	LTE-TDD (SC-FDMA, 1 RB, 10 MHz, QPSK)	-1.62
10234	LTE-TDD (SC-FDMA, 1 RB, 5 MHz, QPSK)	-1.62
10231	LTE-TDD (SC-FDMA, 1 RB, 3 MHz, QPSK)	-1.62
10228	LTE-TDD (SC-FDMA, 1 RB, 1.4 MHz, QPSK)	-1.62
10061	IEEE 802.11b WiFi 2.4 GHz (DSSS, 11 Mbps)	-2.02
10077	IEEE 802.11g WiFi 2.4 GHz (DSSS/OFDM, 54 Mbps)	0.12
10427	IEEE 802.11n (HT Greeneld, 150 Mbps, 64-QAM)	-13.44
10069	IEEE 802.11a/h WiFi 5 GHz (OFDM, 54 Mbps)	-3.15
10616	IEEE 802.11ac WiFi (40MHz, MCS0, 90pc duty cycle)	-5.57

## 10. Conducted Power

### ➤ Full Power

#### <GSM >

GSM850	Burst Average Power (dBm)			Tune-up Limit (dBm)
TX Channel	128	189	251	
Frequency (MHz)	824.2	836.4	848.8	
GSM	33.05	33.17	33.32	33.50

GSM1900	Burst Average Power (dBm)			Tune-up Limit (dBm)
TX Channel	512	661	810	
Frequency (MHz)	1850.2	1880	1909.8	
GSM	27.67	27.55	27.76	28.00

#### <CDMA 2000>

BC0	Burst Average Power (dBm)			Tune-up Limit (dBm)
TX Channel	1013	384	777	
Frequency (MHz)	824.7	836.52	848.31	
1xRTT RC1 SO3,1/8th Rate	23.31	23.34	23.26	23.50

BC1	Burst Average Power (dBm)			Tune-up Limit (dBm)
TX Channel	25	600	1175	
Frequency (MHz)	1851.25	1880	1908.75	
1xRTT RC1 SO3,1/8th Rate	17.36	17.31	17.35	17.50

**<TDD-LTE Band 38>**

BW [MHz]	Modulation	RB Size	RB Offset	Power Low Ch. / Freq.	Power Middle Ch. / Freq.	Power High Ch. / Freq.	Tune-up limit (dBm)
Channel				37850	38000	38150	
Frequency (MHz)				2580	2595	2610	
20	QPSK	1	0	22.79	22.82	22.94	23.50
20	QPSK	1	49	22.78	22.85	22.83	
20	QPSK	1	99	22.74	22.72	22.72	
20	QPSK	50	0	21.98	22.01	22.10	22.50
20	QPSK	50	24	21.94	22.01	22.01	
20	QPSK	50	50	22.01	22.07	22.06	
20	QPSK	100	0	21.98	22.08	22.04	

**<TDD-LTE Band 40A>**

BW [MHz]	Modulation	RB Size	RB Offset	Power Low Ch. / Freq.	Power Middle Ch. / Freq.	Power High Ch. / Freq.	Tune-up limit (dBm)
Channel				38750			
Frequency (MHz)				2310			
10	QPSK	1	0		22.66		23.00
10	QPSK	1	25		22.60		
10	QPSK	1	49		22.42		
10	QPSK	25	0		21.78		22.00
10	QPSK	25	12		21.68		
10	QPSK	25	25		21.69		
10	QPSK	50	0		21.71		



**<TDD-LTE Band 40B>**

BW [MHz]	Modulation	RB Size	RB Offset	Power Low Ch. / Freq.	Power Middle Ch. / Freq.	Power High Ch. / Freq.	Tune-up limit (dBm)
Channel				39200			
Frequency (MHz)				2355			
10	QPSK	1	0	22.62			23.00
10	QPSK	1	25	22.77			
10	QPSK	1	49	22.34			
10	QPSK	25	0	21.79			22.00
10	QPSK	25	12	21.72			
10	QPSK	25	25	21.64			
10	QPSK	50	0	21.82			
10	16QAM	1	0	21.95			22.00

**<TDD-LTE Band 41>**

BW [MHz]	Modulation	RB Size	RB Offset	Power Low Ch. / Freq.	Power Middle Low Ch. / Freq.	Power Middle High Ch. / Freq.	Power High Ch. / Freq.	Tune-up limit (dBm)
Channel				40340	40600	40870	41140	
Frequency (MHz)				2565	2591	2618	2645	
20	QPSK	1	0	22.87	22.67	22.82	22.93	23.50
20	QPSK	1	49	22.87	22.77	22.75	22.61	
20	QPSK	1	99	22.94	22.80	22.68	22.61	
20	QPSK	50	0	22.15	21.87	22.03	22.04	22.50
20	QPSK	50	24	22.09	22.08	21.96	21.89	
20	QPSK	50	50	22.10	22.10	21.93	21.76	
20	QPSK	100	0	22.12	22.04	21.94	21.92	



➤ **Down Power**

**<GSM >**

GSM850	Burst Average Power (dBm)			Tune-up Limit (dBm)
TX Channel	128	189	251	
Frequency (MHz)	824.2	836.4	848.8	
GSM	30.60	30.80	31.00	31.00

GSM1900	Burst Average Power (dBm)			Tune-up Limit (dBm)
TX Channel	512	661	810	
Frequency (MHz)	1850.2	1880	1909.8	
GSM	25.04	25.12	25.05	25.50

**<CDMA 2000>**

BC1	Burst Average Power (dBm)			Tune-up Limit (dBm)
TX Channel	25	600	1175	
Frequency (MHz)	1851.25	1880	1908.75	
1xRTT RC1 SO3,1/8th Rate	15.44	15.39	15.43	15.50

**<TDD-LTE Band 38>**

BW [MHz]	Modulation	RB Size	RB Offset	Power Low Ch. / Freq.	Power Middle Ch. / Freq.	Power High Ch. / Freq.	Tune-up limit (dBm)
Channel				37850	38000	38150	
Frequency (MHz)				2580	2595	2610	
20	QPSK	1	0	19.29	19.38	19.37	20.00
20	QPSK	1	49	19.39	19.31	19.40	
20	QPSK	1	99	19.22	19.25	19.30	
20	QPSK	50	0	18.47	18.47	18.56	19.00
20	QPSK	50	24	18.49	18.53	18.53	
20	QPSK	50	50	18.33	18.43	18.47	
20	QPSK	100	0	18.45	18.58	18.48	

**<TDD-LTE Band 40A>**

BW [MHz]	Modulation	RB Size	RB Offset	Power Low Ch. / Freq.	Power Middle Ch. / Freq.	Power High Ch. / Freq.	Tune-up limit (dBm)
Channel				38750			
Frequency (MHz)				2310			
10	QPSK	1	0	19.66			20.00
10	QPSK	1	25	19.60			
10	QPSK	1	49	19.42			
10	QPSK	25	0	18.78			19.00
10	QPSK	25	12	18.68			
10	QPSK	25	25	18.69			
10	QPSK	50	0	18.71			

<TDD-LTE Band 40B>

BW [MHz]	Modulation	RB Size	RB Offset	Power Low Ch. / Freq.	Power Middle Ch. / Freq.	Power High Ch. / Freq.	Tune-up limit (dBm)
Channel				39200			
Frequency (MHz)				2355			
10	QPSK	1	0	19.62			20.00
10	QPSK	1	25	19.77			
10	QPSK	1	49	19.34			
10	QPSK	25	0	18.79			19.00
10	QPSK	25	12	18.72			
10	QPSK	25	25	18.64			
10	QPSK	50	0	18.82			

<TDD-LTE Band 41>

BW [MHz]	Modulation	RB Size	RB Offset	Power Low Ch. / Freq.	Power Middle Low Ch. / Freq.	Power Middle High Ch. / Freq.	Power High Ch. / Freq.	Tune-up limit (dBm)
Channel				40340	40600	40870	41140	
Frequency (MHz)				2565	2591	2618	2645	
20	QPSK	1	0	19.17	19.32	19.43	19.29	19.50
20	QPSK	1	49	19.27	19.25	19.11	18.97	
20	QPSK	1	99	19.30	19.18	19.11	18.97	
20	QPSK	50	0	18.37	18.53	18.54	18.40	22.50
20	QPSK	50	24	18.58	18.46	18.39	18.25	
20	QPSK	50	50	18.60	18.43	18.26	18.12	
20	QPSK	100	0	18.54	18.44	18.42	18.28	

**Note:**

The EUT respectively defined the top and bottom antenna maximum output power in the software and the default antenna including TX & RX is the bottom antenna. The top and bottom antenna will switch automatically according to the receiver signal strength and maximum transmission power level.

# 11. Low-power Exemption

Air Interface	Max Tune-up Limit (dBm)	Worst Case MIF (dB)	Power + MIF(dB)	C63.19 test required
GSM850	33.50	3.63	37.13	Yes
GSM1900	28.00	3.63	31.63	Yes
WCDMA Band II	20.00	-25.43	-5.43	No
WCDMA Band IV	21.50	-25.43	-3.93	No
WCDMA Band V	23.00	-25.43	-2.43	No
CDMA BC0 Full Rate	24.00	-19.71	4.29	No
CDMA BC0 1/8th Frame Rate	23.50	3.26	26.76	Yes
BC0 EVDO	24.00	-17.67	6.33	No
CDMA BC1 Full Rate	18.00	-19.71	-1.71	No
CDMA BC1 1/8th Frame Rate	17.50	3.26	20.76	Yes
BC1 EVDO	18.00	-17.67	0.33	No
LTE Band 2	20.00	-15.63	4.37	No
LTE Band 4	21.00	-15.63	5.37	No
LTE Band 5	23.00	-15.63	7.37	No
LTE Band 7	23.00	-15.63	7.37	No
LTE Band 12	23.00	-15.63	7.37	No
LTE Band 17	23.00	-15.63	7.37	No
LTE Band 18	23.00	-15.63	7.37	No
LTE Band 19	23.00	-15.63	7.37	No
LTE Band 25	20.50	-15.63	4.87	No
LTE Band 26	23.00	-15.63	7.37	No
LTE Band 30	22.00	-1.62	20.38	No
LTE Band 38	23.50	-15.63	7.87	Yes
LTE Band 40A	23.00	-15.63	7.37	Yes
LTE Band 40B	23.00	-15.63	7.37	Yes
LTE Band 41	23.50	-15.63	7.87	Yes
LTE Band 66	23.00	-15.63	7.37	Yes

**Note:**

1. According to ANSI C63.19 2011-version, for the air interface technology of a device is exempt from testing when its average antenna input power plus its MIF is  $\leq 17$  dBm for any of its operating modes.
2. For all of bands, the worst case of max tune-up limit will be test RF, therefore WCDMA modes is not necessary for testing.
3. HAC RF rating is M4 for the air interface which meets the low power exemption.



4. The power reduction is lower than the full power, so please use the full power for the exemption evaluation.
5. The EUT respectively defined the top and bottom antenna maximum output power in the software and the default antenna including TX & RX is the bottom antenna. The top and bottom antenna will switch automatically according to the receiver signal strength and maximum transmission power level.



## 12. Summary Test Results

**Note:** Full power for bottom antenna.

➤ **Full Power**

Plot No.	Air Interface	Mode	Channel	Average Antenna Input Power (dBm)	MIF	E-Field (dBV/m)	Margin to FCC M3 limit (dB)	E-Field M Rating
1	GSM850	GSM Voice	128	33.05	3.63	31.32	13.68	M4
2	GSM850	GSM Voice	189	33.17	3.63	31.84	13.16	M4
3	GSM850	GSM Voice	251	33.32	3.63	32.78	12.22	M4
4	GSM1900	GSM Voice	512	27.67	3.63	17.22	17.78	M4
5	GSM1900	GSM Voice	661	27.55	3.63	17.13	17.87	M4
6	GSM1900	GSM Voice	810	27.76	3.63	17.26	17.74	M4
7	CDMA BC0	1xRTT, RC1 SO3, 1/8th Rate	1013	23.31	3.26	12.83	32.17	M4
8	CDMA BC0	1xRTT, RC1 SO3, 1/8th Rate	384	23.34	3.26	12.87	32.13	M4
9	CDMA BC0	1xRTT, RC1 SO3, 1/8th Rate	777	23.26	3.26	12.85	32.15	M4
10	CDMA BC1	1xRTT, RC1 SO3, 1/8th Rate	25	17.36	3.26	12.81	22.19	M4
11	CDMA BC1	1xRTT, RC1 SO3, 1/8th Rate	600	17.31	3.26	12.34	22.66	M4
12	CDMA BC1	1xRTT, RC1 SO3, 1/8th Rate	1175	17.35	3.26	12.32	22.68	M4

Plot No.	Air Interface	Mode	Channel	Average Antenna Input Power (dBm)	MIF	E-Field (dBV/m)	Margin to FCC M3 limit (dB)	E-Field M Rating
13	LTE Band 38	QPSK/1RB#0/20MHz	37850	22.79	-1.62	18.38	16.62	M4
14	LTE Band 38	QPSK/1RB#0/20MHz	38000	22.82	-1.62	16.79	18.21	M4
15	LTE Band 38	QPSK/1RB#0/20MHz	38150	22.94	-1.62	15.11	19.89	M4
16	LTE Band 40A	QPSK/1RB#0/10MHz	38750	22.66	-1.62	18.02	16.98	M4
17	LTE Band 40B	QPSK/1RB#25/10MHz	39200	22.77	-1.62	18.83	16.17	M4
18	LTE Band 41	QPSK/1RB#99/20MHz	40340	22.94	-1.62	16.07	18.93	M4
19	LTE Band 41	QPSK/1RB#99/20MHz	40600	22.80	-1.62	17.20	17.80	M4
20	LTE Band 41	QPSK/1RB#99/20MHz	40870	22.68	-1.62	14.50	20.50	M4
21	LTE Band 41	QPSK/1RB#99/20MHz	41140	22.61	-1.62	15.78	19.22	M4



➤ Down Power

Plot No.	Air Interface	Mode	Channel	Average Antenna Input Power (dBm)	MIF	E-Field (dBV/m)	Margin to FCC M3 limit (dB)	E-Field M Rating
1	GSM850	GSM Voice	128	30.60	3.63	42.86	2.14	M3
2	GSM850	GSM Voice	189	30.80	3.63	43.31	1.69	M3
3	GSM850	GSM Voice	251	31.00	3.63	43.07	1.93	M3
4	GSM1900	GSM Voice	512	25.04	3.63	33.94	1.06	M3
5	GSM1900	GSM Voice	661	25.12	3.63	33.54	1.46	M3
6	GSM1900	GSM Voice	810	25.05	3.63	33.53	1.47	M3
10	CDMA BC1	1xRTT, RC1 SO3, 1/8th Rate	25	15.44	3.26	12.10	22.90	M4
11	CDMA BC1	1xRTT, RC1 SO3, 1/8th Rate	600	15.39	3.26	11.88	23.12	M4
12	CDMA BC1	1xRTT, RC1 SO3, 1/8th Rate	1175	15.43	3.26	11.59	23.41	M4

Plot No.	Air Interface	Mode	Channel	Average Antenna Input Power (dBm)	MIF	E-Field (dBV/m)	Margin to FCC M3 limit (dB)	E-Field M Rating
13	LTE Band 38	QPSK/1RB#0/20MHz	37850	19.29	-1.62	25.64	9.36	M4
14	LTE Band 38	QPSK/1RB#0/20MHz	38000	19.38	-1.62	25.38	9.62	M4
15	LTE Band 38	QPSK/1RB#0/20MHz	38150	19.37	-1.62	25.24	9.76	M4
16	LTE Band 40A	QPSK/1RB#0/10MHz	38750	19.66	-1.62	29.43	5.57	M4
17	LTE Band 40B	QPSK/1RB#25/10MHz	39200	19.77	-1.62	28.91	6.09	M4
18	LTE Band 41	QPSK/1RB#99/20MHz	40340	19.30	-1.62	25.60	9.40	M4
19	LTE Band 41	QPSK/1RB#99/20MHz	40600	19.18	-1.62	25.27	9.73	M4
20	LTE Band 41	QPSK/1RB#99/20MHz	40870	19.11	-1.62	25.13	9.87	M4
21	LTE Band 41	QPSK/1RB#99/20MHz	41140	18.97	-1.62	25.06	9.94	M4



## 13. Uncertainty Assessment

The component of uncertainty may generally be categorized according to the methods used to evaluate them. The evaluation of uncertainty by the statistical analysis of a series of observations is termed a Type A evaluation of uncertainty. The evaluation of uncertainty by means other than the statistical analysis of a series of observations is termed a Type B evaluation of uncertainty. Each component of uncertainty, however evaluated, is represented by an estimated standard deviation, termed standard uncertainty, which is determined by the positive square root of the estimated variance.

The combined standard uncertainty of the measurement result represents the estimated standard deviation of the result. It is obtained by combining the individual standard uncertainties of both Type A and Type B evaluation using the usual "root-sum-squares" (RSS) methods of combining standard deviations by taking the positive square root of the estimated variances. Expanded uncertainty is a measure of uncertainty that defines an interval about the measurement result within which the measured value is confidently believed to lie. It is obtained by multiplying the combined standard uncertainty by a coverage factor. For purpose of this document, a coverage factor two is used, which corresponds to confidence interval of about 95 %. The DAS uncertainty Budget is shown in Table 12.1.



## Annex A General Information

### 1. Identification of the Responsible Testing Laboratory

<b>Laboratory Name:</b>	Shenzhen Morlab Communications Technology Co., Ltd. Morlab Laboratory
<b>Laboratory Address:</b>	FL.3, Building A, FeiYang Science Park, No.8 LongChang Road, Block 67, BaoAn District, ShenZhen, GuangDong Province, P. R. China
<b>Telephone:</b>	+86 755 36698555
<b>Facsimile:</b>	+86 755 36698525

### 2. Identification of the Responsible Testing Location

<b>Name:</b>	Shenzhen Morlab Communications Technology Co., Ltd. Morlab Laboratory
<b>Address:</b>	FL.3, Building A, FeiYang Science Park, No.8 LongChang Road, Block 67, BaoAn District, ShenZhen, GuangDong Province, P. R. China



REPORT No. : SZ19070123S01

## Annex C Plots of RF System Check

### System Check\_835MHz\_HAC\_RF\_E

Communication System: UID 0, CW (0); Frequency: 835 MHz;Duty Cycle: 1:1

Medium: Air Medium parameters used:  $\sigma = 0 \text{ S/m}$ ,  $\epsilon_r = 1$ ;  $\rho = 0 \text{ kg/m}^3$

Ambient Temperature : 23.2 °C;

DASY5 Configuration:

- Probe: ER3DV6 - SN2434; ConvF(1, 1, 1); Calibrated: 2018.10.18;
- Sensor-Surface: (Fix Surface), Sensor-Surface: 0mm (Fix Surface)
- Electronics: DAE4 Sn480; Calibrated: 2018.10.29
- Phantom: HAC Test Arch with AMC
- Measurement SW: DASY52, Version 52.8 (8); SEMCAD X Version 14.6.10 (7331)

C; T

**Hearing Aid Compatibility Test (81x401x1):** Interpolated grid: dx=0.5000 mm, dy=0.5000 mm

Maximum value of Total (interpolated) = 120.78 V/m

Device Reference Point: 0, 0, -6.3 mm

Reference Value = 58.41 V/m; Power Drift = -0.10 dB

Applied MIF = 0.00 dB

RF audio interference level = 41.64 dBV/m

**Emission category: M3**

MIF scaled E-field

Grid 1 <b>M3</b> <b>41.13 dBV/m</b>	Grid 2 <b>M3</b> <b>41.64 dBV/m</b>	Grid 3 <b>M3</b> <b>40.61 dBV/m</b>
Grid 4 <b>M4</b> <b>36.92 dBV/m</b>	Grid 5 <b>M4</b> <b>37.90 dBV/m</b>	Grid 6 <b>M4</b> <b>36.43 dBV/m</b>
Grid 7 <b>M3</b> <b>41.33 dBV/m</b>	Grid 8 <b>M3</b> <b>41.62 dBV/m</b>	Grid 9 <b>M3</b> <b>40.55 dBV/m</b>

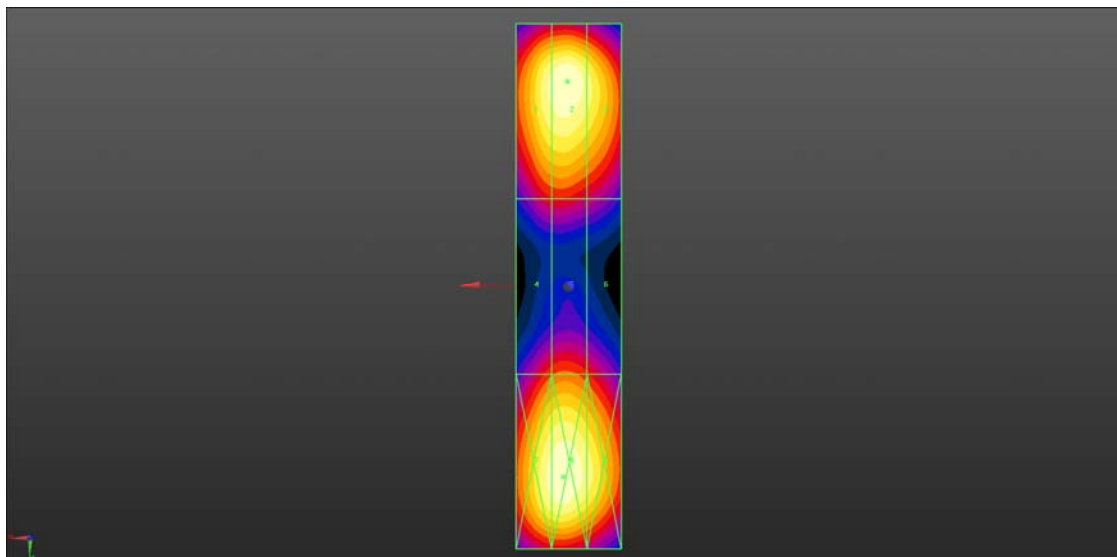
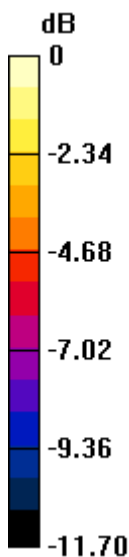

0 dB = 120.78 V/m = 41.64 dBV/m

### System Check\_1880MHz\_HAC\_RF\_E

Communication System: UID 0, CW (0); Frequency: 1880 MHz; Duty Cycle: 1:1

Medium: Air Medium parameters used:  $\sigma = 0 \text{ S/m}$ ,  $\epsilon_r = 1$ ;  $\rho = 0 \text{ kg/m}^3$

Ambient Temperature : 23.2 °C;

DASY5 Configuration:

- Probe: ER3DV6 - SN2434; ConvF(1, 1, 1); Calibrated: 2018.10.18;
- Sensor-Surface: (Fix Surface), Sensor-Surface: 0mm (Fix Surface)
- Electronics: DAE4 Sn480; Calibrated: 2018.10.29
- Phantom: HAC Test Arch with AMCC; Type: SD HAC P01 BA;
- Measurement SW: DASY52, Version 52.8 (8); SEMCAD X Version 14.6.10 (7331)

**Hearing Aid Compatibility Test (81x321x1):** Interpolated grid: dx=0.5000 mm, dy=0.5000 mm

Maximum value of Total (interpolated) = 96.72 V/m

Device Reference Point: 0, 0, -6.3 mm

Reference Value = 73.68 V/m; Power Drift = -0.12 dB

Applied MIF = 0.00 dB

RF audio interference level = 39.71 dBV/m

**Emission category: M2**

MIF scaled E-field

Grid 1 <b>M2</b> <b>39.22 dBV/m</b>	Grid 2 <b>M2</b> <b>39.60 dBV/m</b>	Grid 3 <b>M2</b> <b>38.56 dBV/m</b>
Grid 4 <b>M2</b> <b>39.03 dBV/m</b>	Grid 5 <b>M2</b> <b>39.55 dBV/m</b>	Grid 6 <b>M2</b> <b>38.72 dBV/m</b>
Grid 7 <b>M2</b> <b>39.33 dBV/m</b>	Grid 8 <b>M2</b> <b>39.71 dBV/m</b>	Grid 9 <b>M2</b> <b>38.81 dBV/m</b>

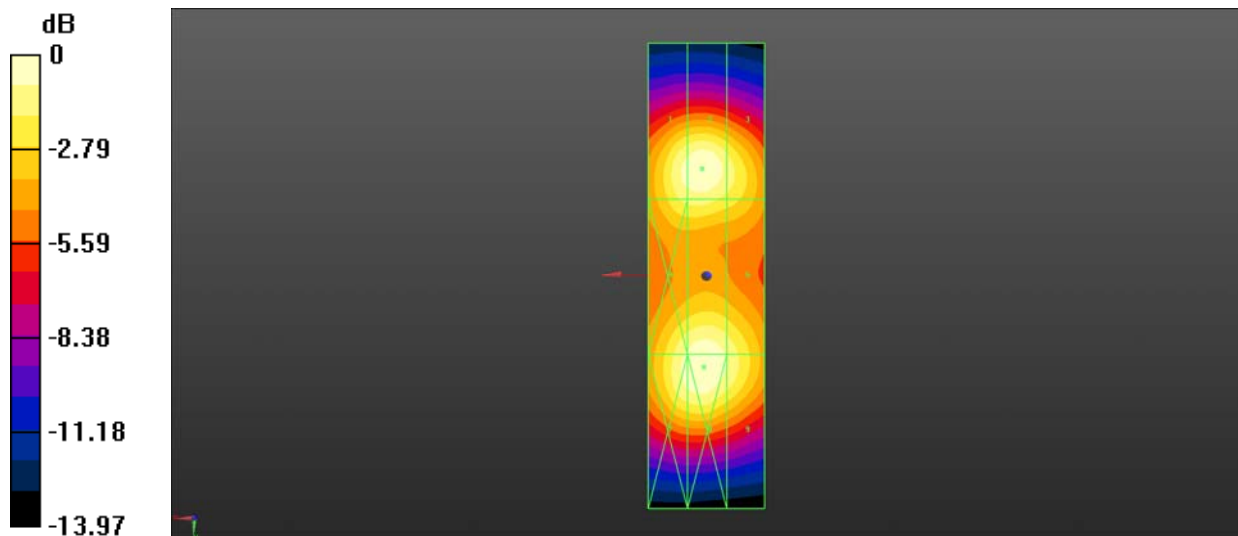

0 dB = 96.71 V/m = 39.71 dBV/m

### System Check\_2450MHz\_HAC\_RF\_E

Communication System: UID 0, CW (0); Frequency: 2450 MHz; Duty Cycle: 1:1

Medium: Air Medium parameters used:  $\sigma = 0 \text{ S/m}$ ,  $\epsilon_r = 1$ ;  $\rho = 0 \text{ kg/m}^3$

Ambient Temperature : 23.2 °C;

DASY5 Configuration:

- Probe: ER3DV6 - SN2434; ConvF(1, 1, 1); Calibrated: 2018.10.18;
- Sensor-Surface: (Fix Surface), Sensor-Surface: 0mm (Fix Surface)
- Electronics: DAE4 Sn480; Calibrated: 2018.10.29
- Phantom: HAC Test Arch with AMCC; Type: SD HAC P01 BA;
- Measurement SW: DASY52, Version 52.8 (8); SEMCAD X Version 14.6.10 (7331)

**Hearing Aid Compatibility Test (81x321x1):** Interpolated grid: dx=0.5000 mm, dy=0.5000 mm

Maximum value of Total (interpolated) = 97.05 V/m

Device Reference Point: 0, 0, -6.3 mm

Reference Value = 81.76 V/m; Power Drift = -0.13 dB

Applied MIF = 0.00 dB

RF audio interference level = 39.74 dBV/m

**Emission category: M2**

MIF scaled E-field

Grid 1 <b>M2</b> <b>38.96 dBV/m</b>	Grid 2 <b>M2</b> <b>39.30 dBV/m</b>	Grid 3 <b>M2</b> <b>38.13 dBV/m</b>
Grid 4 <b>M2</b> <b>39.26 dBV/m</b>	Grid 5 <b>M2</b> <b>39.74 dBV/m</b>	Grid 6 <b>M2</b> <b>38.78 dBV/m</b>
Grid 7 <b>M2</b> <b>39.14 dBV/m</b>	Grid 8 <b>M2</b> <b>39.51 dBV/m</b>	Grid 9 <b>M2</b> <b>38.39 dBV/m</b>

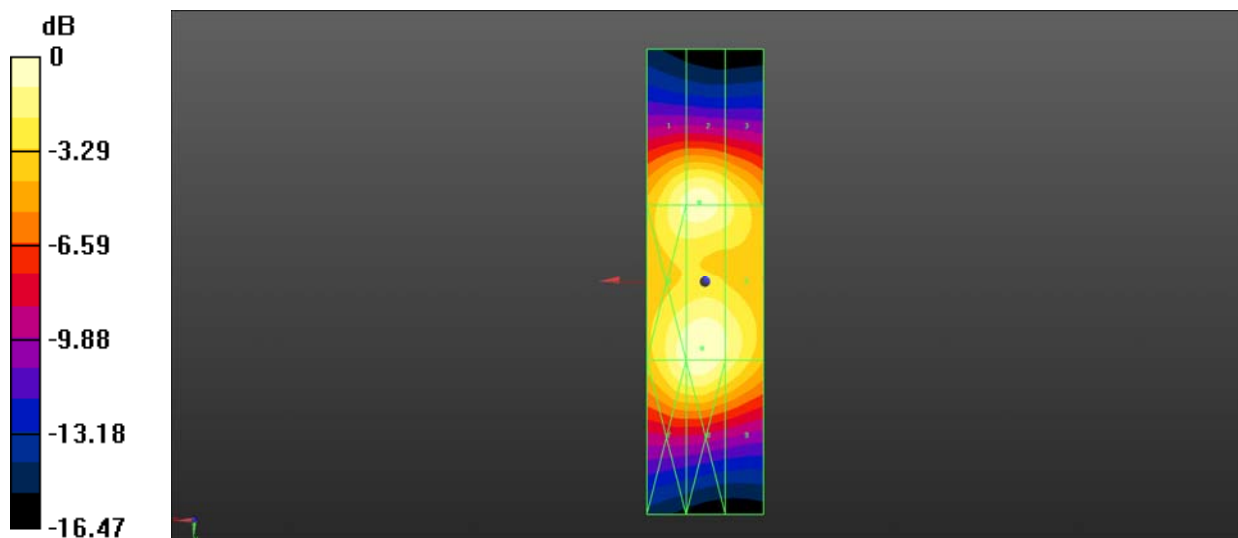

0 dB = 97.05 V/m = 39.74 dBV/m

### System Check\_2600MHz\_HAC\_RF\_E

Communication System: UID 0, CW (0); Frequency: 2450 MHz;Duty Cycle: 1:1

Medium: Air Medium parameters used:  $\sigma = 0 \text{ S/m}$ ,  $\epsilon_r = 1$ ;  $\rho = 0 \text{ kg/m}^3$

Ambient Temperature : 23.2 °C

DASY5 Configuration:

- Probe: ER3DV6 - SN2434; ConvF(1, 1, 1); Calibrated: 2018.10.18;
- Sensor-Surface: (Fix Surface), Sensor-Surface: 0mm (Fix Surface)
- Electronics: DAE4 Sn480; Calibrated: 2018.10.29
- Phantom: HAC Test Arch with AMCC; Type: SD HAC P01 BA;
- Measurement SW: DASY52, Version 52.8 (8); SEMCAD X Version 14.6.10 (7331)

**Ch2600/Hearing Aid Compatibility Test (81x321x1):** Interpolated grid: dx=0.5000 mm, dy=0.5000 mm

Maximum value of Total (interpolated) = 96.49 V/m

Device Reference Point: 0, 0, -6.3 mm

Reference Value = 81.72 V/m; Power Drift = -0.18 dB

Applied MIF = 0.00 dB

RF audio interference level = 39.69 dBV/m

**Emission category: M2**

MIF scaled E-field

Grid 1 <b>M2</b> <b>38.96 dBV/m</b>	Grid 2 <b>M2</b> <b>39.26 dBV/m</b>	Grid 3 <b>M2</b> <b>38.15 dBV/m</b>
Grid 4 <b>M2</b> <b>39.25 dBV/m</b>	Grid 5 <b>M2</b> <b>39.69 dBV/m</b>	Grid 6 <b>M2</b> <b>38.79 dBV/m</b>
Grid 7 <b>M2</b> <b>39.15 dBV/m</b>	Grid 8 <b>M2</b> <b>39.52 dBV/m</b>	Grid 9 <b>M2</b> <b>38.33 dBV/m</b>

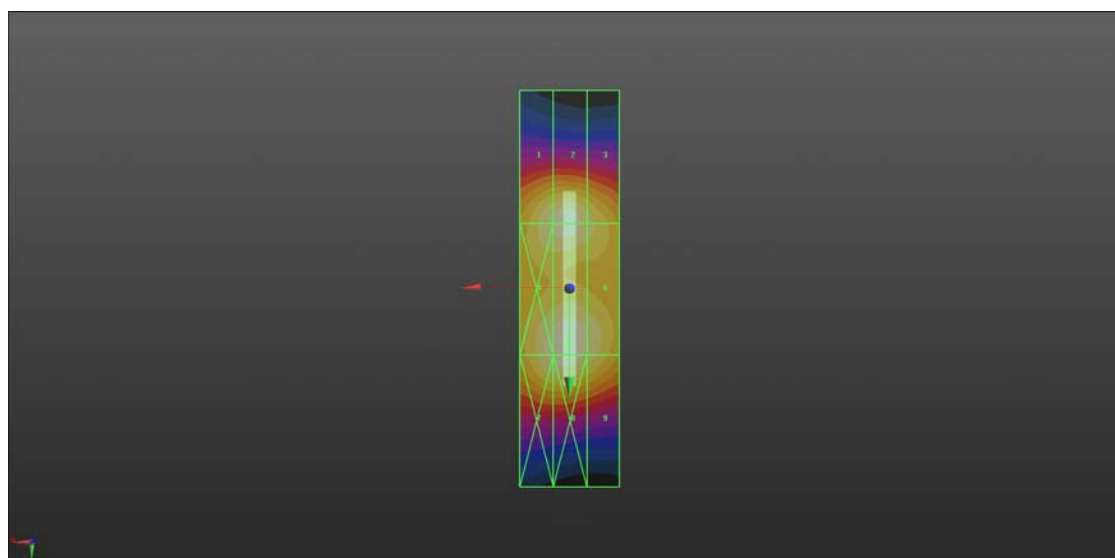
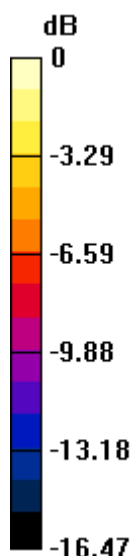

0 dB = 96.49 V/m = 39.69 dBV/m



REPORT No. : SZ19070123S01

## Annex D Plots of RF Test Results



### HAC RF\_GSM850\_GSM Voice\_Ch128\_E

Communication System: UID 10021 - DAB, GSM-FDD (TDMA, GMSK); Frequency: 824.2 MHz; Duty Cycle: 1:8.3

Medium: Air Medium parameters used:  $\sigma = 0$  S/m,  $\epsilon_r = 1$ ;  $\rho = 0$  kg/m<sup>3</sup>

Ambient Temperature : 23.2 °C

**DASY5 Configuration:**

- Probe: ER3DV6 - SN2434; ConvF(1, 1, 1); Calibrated: 2018.10.18;
- Sensor-Surface: (Fix Surface)
- Electronics: DAE4 Sn480; Calibrated: 2019.04.11
- Phantom: HAC Test Arch with AMCC; Type: SD HAC P01 BA;
- Measurement SW: DASY52, Version 52.8 (8); SEMCAD X Version 14.6.10 (7331)

**Device E-Ch128/Hearing Aid Compatibility Test (101x101x1):** Interpolated grid:

dx=0.5000 mm, dy=0.5000 mm

Device Reference Point: 0, 0, -6.3 mm

Reference Value = 26.82 V/m; Power Drift = 0.12 dB

Applied MIF = 3.63 dB

RF audio interference level = 30.24 dBV/m

**Emission category: M4**

MIF scaled E-field

<b>Grid 1 M4</b> <b>27.97 dBV/m</b>	<b>Grid 2 M4</b> <b>29.37 dBV/m</b>	<b>Grid 3 M4</b> <b>29.34 dBV/m</b>
<b>Grid 4 M4</b> <b>29.54 dBV/m</b>	<b>Grid 5 M4</b> <b>30.24 dBV/m</b>	<b>Grid 6 M4</b> <b>30.1 dBV/m</b>
<b>Grid 7 M4</b> <b>31.05 dBV/m</b>	<b>Grid 8 M4</b> <b>31.32 dBV/m</b>	<b>Grid 9 M4</b> <b>30.86 dBV/m</b>

**Cursor:**

Total = 31.32 dBV/m

E Category: M4

Location: 0.5, 25, 8.7 mm

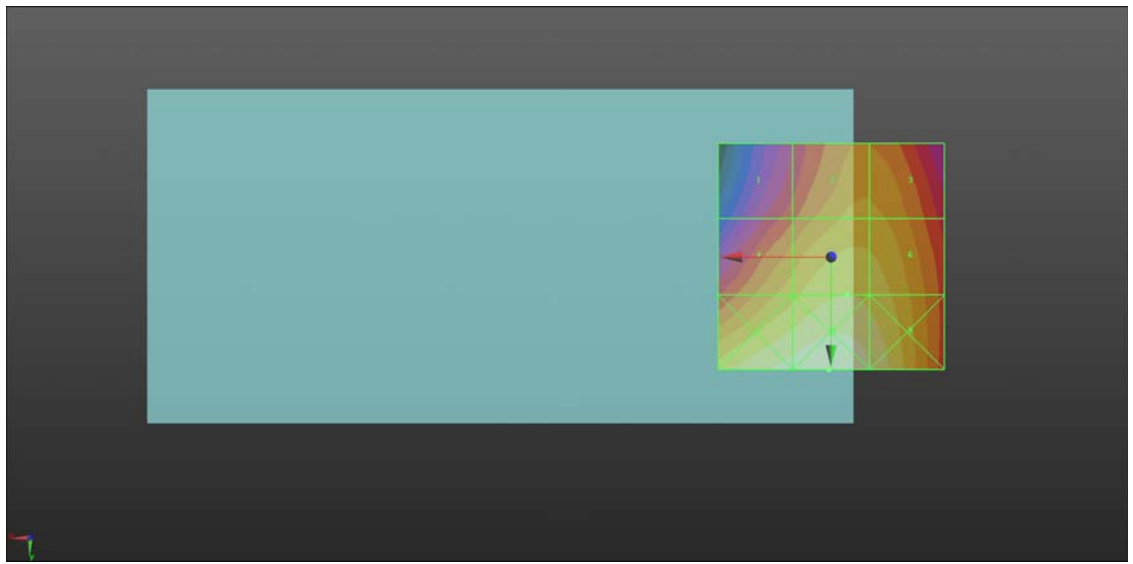
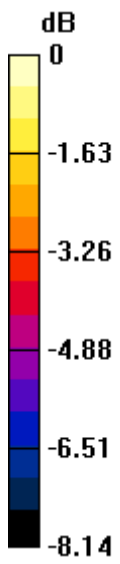

0 dB = 36.80 V/m = 31.32 dBV/m

### HAC RF\_GSM850\_GSM Voice\_Ch189\_E

Communication System: UID 10021 - DAB, GSM-FDD (TDMA, GMSK); Frequency: 836.4 MHz; Duty Cycle: 1:8.3

Medium: Air Medium parameters used:  $\sigma = 0 \text{ S/m}$ ,  $\epsilon_r = 1$ ;  $\rho = 0 \text{ kg/m}^3$

Ambient Temperature : 23.2 °C

**DASY5 Configuration:**

- Probe: ER3DV6 - SN2434; ConvF(1, 1, 1); Calibrated: 2018.10.18;
- Sensor-Surface: (Fix Surface)
- Electronics: DAE4 Sn480; Calibrated: 2019.04.11
- Phantom: HAC Test Arch with AMCC; Type: SD HAC P01 BA;
- Measurement SW: DASY52, Version 52.8 (8); SEMCAD X Version 14.6.10 (7331)

**Device E-Ch189/Hearing Aid Compatibility Test (101x101x1):** Interpolated grid:

dx=0.5000 mm, dy=0.5000 mm

Device Reference Point: 0, 0, -6.3 mm

Reference Value = 27.71 V/m; Power Drift = 0.05 dB

Applied MIF = 3.63 dB

RF audio interference level = 30.40 dBV/m

**Emission category: M4**

MIF scaled E-field

<b>Grid 1 M4</b> <b>27.85 dBV/m</b>	<b>Grid 2 M4</b> <b>28.85 dBV/m</b>	<b>Grid 3 M4</b> <b>28.82 dBV/m</b>
<b>Grid 4 M4</b> <b>29.98 dBV/m</b>	<b>Grid 5 M4</b> <b>30.4 dBV/m</b>	<b>Grid 6 M4</b> <b>29.86 dBV/m</b>
<b>Grid 7 M4</b> <b>31.6 dBV/m</b>	<b>Grid 8 M4</b> <b>31.84 dBV/m</b>	<b>Grid 9 M4</b> <b>31.12 dBV/m</b>

**Cursor:**

Total = 31.84 dBV/m

E Category: M4

Location: 1, 25, 8.7 mm

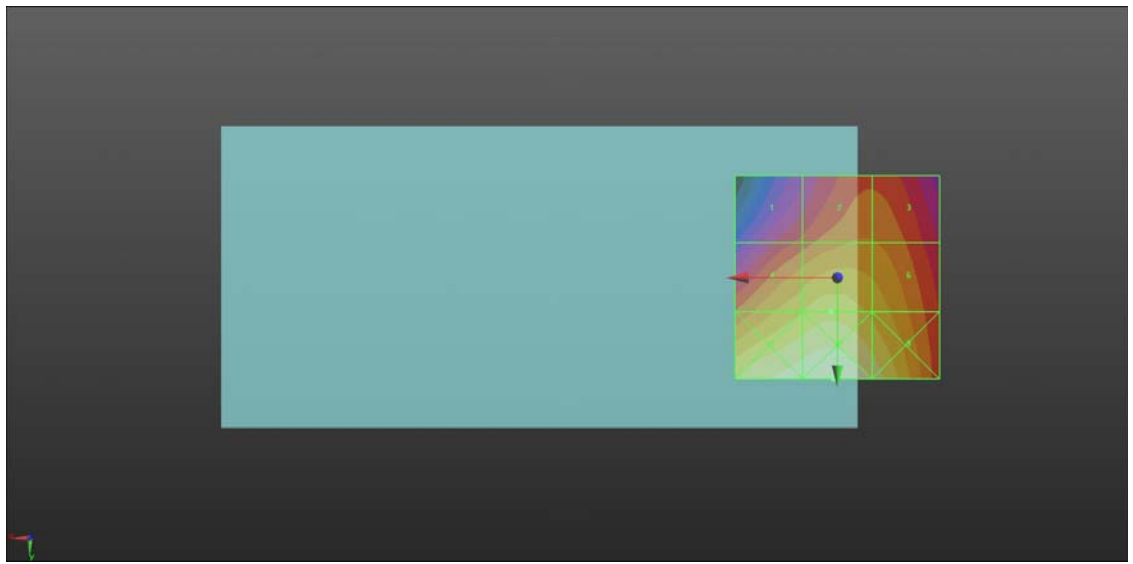
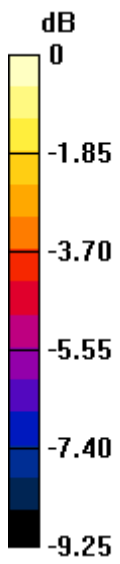

0 dB = 39.10 V/m = 31.84 dBV/m

### HAC RF\_GSM850\_GSM Voice\_Ch251\_E

Communication System: UID 10021 - DAB, GSM-FDD (TDMA, GMSK); Frequency: 848.6 MHz; Duty Cycle: 1:8.3

Medium: Air Medium parameters used:  $\sigma = 0$  S/m,  $\epsilon_r = 1$ ;  $\rho = 0$  kg/m<sup>3</sup>

Ambient Temperature : 23.2 °C

**DASY5 Configuration:**

- Probe: ER3DV6 - SN2434; ConvF(1, 1, 1); Calibrated: 2018.10.18;
- Sensor-Surface: (Fix Surface)
- Electronics: DAE4 Sn480; Calibrated: 2019.04.11
- Phantom: HAC Test Arch with AMCC; Type: SD HAC P01 BA;
- Measurement SW: DASY52, Version 52.8 (8); SEMCAD X Version 14.6.10 (7331)

**Device E-Ch251/Hearing Aid Compatibility Test (101x101x1):** Interpolated grid:

dx=0.5000 mm, dy=0.5000 mm

Device Reference Point: 0, 0, -6.3 mm

Reference Value = 30.16 V/m; Power Drift = -0.01 dB

Applied MIF = 3.63 dB

RF audio interference level = 31.22 dBV/m

**Emission category: M4**

MIF scaled E-field

<b>Grid 1 M4</b> <b>28.32 dBV/m</b>	<b>Grid 2 M4</b> <b>28.73 dBV/m</b>	<b>Grid 3 M4</b> <b>28.39 dBV/m</b>
<b>Grid 4 M4</b> <b>30.93 dBV/m</b>	<b>Grid 5 M4</b> <b>31.22 dBV/m</b>	<b>Grid 6 M4</b> <b>29.99 dBV/m</b>
<b>Grid 7 M4</b> <b>32.58 dBV/m</b>	<b>Grid 8 M4</b> <b>32.78 dBV/m</b>	<b>Grid 9 M4</b> <b>31.83 dBV/m</b>

**Cursor:**

Total = 32.78 dBV/m

E Category: M4

Location: 2, 25, 8.7 mm

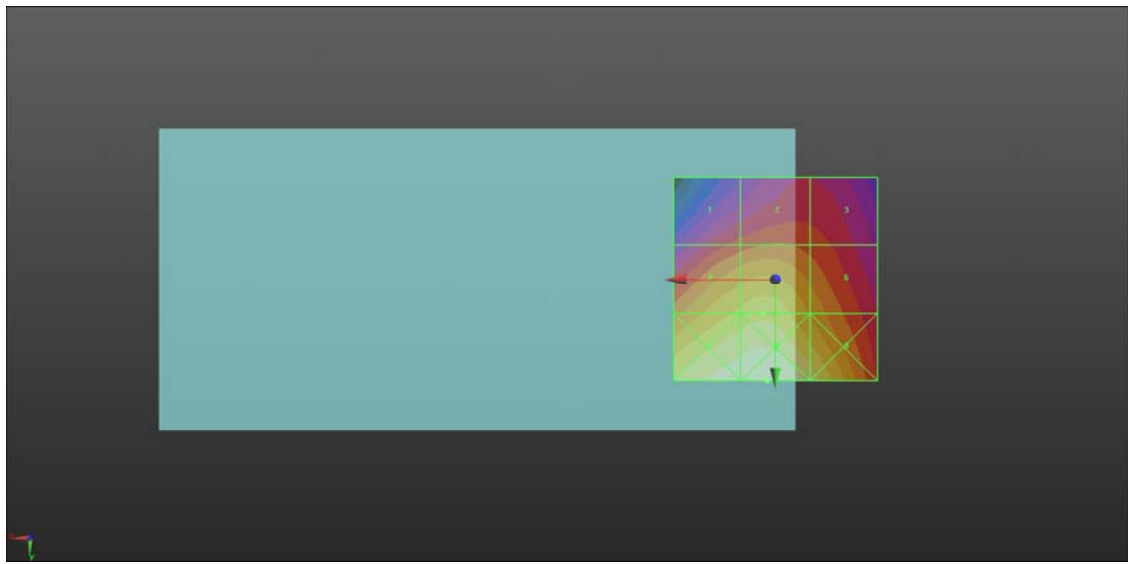
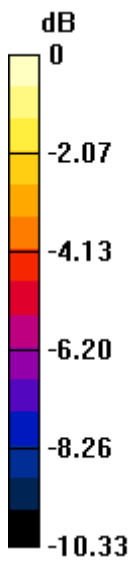

0 dB = 43.56 V/m = 32.78 dBV/m

## HAC RF\_GSM1900\_GSM Voice\_Ch512\_E

Communication System: UID 10021 - DAB, GSM-FDD (TDMA, GMSK); Frequency: 1850.2 MHz; Duty Cycle: 1:8.3

Medium: Air Medium parameters used:  $\sigma = 0$  S/m,  $\epsilon_r = 1$ ;  $\rho = 0$  kg/m<sup>3</sup>

Ambient Temperature : 23.2 °C

### DASY5 Configuration:

- Probe: ER3DV6 - SN2434; ConvF(1, 1, 1); Calibrated: 2018.10.18;
- Sensor-Surface: (Fix Surface)
- Electronics: DAE4 Sn480; Calibrated: 2019.04.11
- Phantom: HAC Test Arch with AMCC; Type: SD HAC P01 BA;
- Measurement SW: DASY52, Version 52.8 (8); SEMCAD X Version 14.6.10 (7331)

### Device E-Ch512/Hearing Aid Compatibility Test (101x101x1): Interpolated grid:

dx=0.5000 mm, dy=0.5000 mm

Device Reference Point: 0, 0, -6.3 mm

Reference Value = 2.999 V/m; Power Drift = -0.15 dB

Applied MIF = 3.63 dB

RF audio interference level = 16.69 dBV/m

**Emission category: M4**

MIF scaled E-field

<b>Grid 1 M4</b> <b>15.54 dBV/m</b>	<b>Grid 2 M4</b> <b>17.22 dBV/m</b>	<b>Grid 3 M4</b> <b>16.97 dBV/m</b>
<b>Grid 4 M4</b> <b>14.03 dBV/m</b>	<b>Grid 5 M4</b> <b>13.86 dBV/m</b>	<b>Grid 6 M4</b> <b>12.47 dBV/m</b>
<b>Grid 7 M4</b> <b>16.63 dBV/m</b>	<b>Grid 8 M4</b> <b>16.69 dBV/m</b>	<b>Grid 9 M4</b> <b>15.59 dBV/m</b>

### Cursor:

Total = 17.22 dBV/m

E Category: M4

Location: -4.5, -25, 8.7 mm

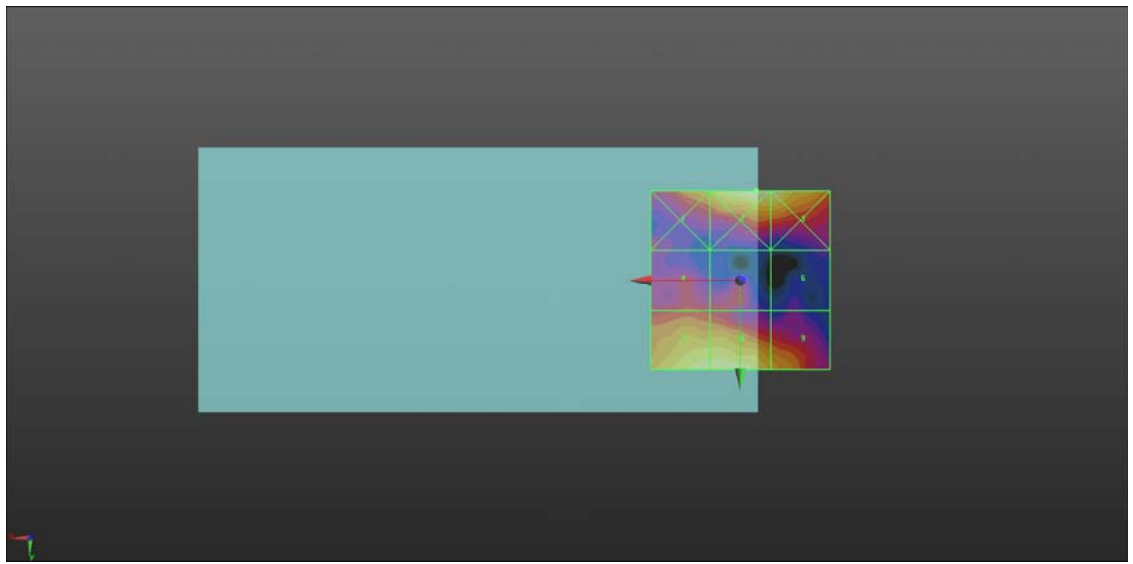
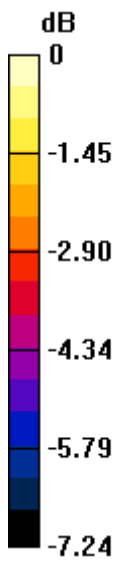

0 dB = 7.258 V/m = 17.22 dBV/m



## HAC RF\_GSM1900\_GSM Voice\_Ch661\_E

Communication System: UID 10021 - DAB, GSM-FDD (TDMA, GMSK); Frequency: 1880 MHz; Duty Cycle: 1:8.3

Medium: Air Medium parameters used:  $\sigma = 0$  S/m,  $\epsilon_r = 1$ ;  $\rho = 0$  kg/m<sup>3</sup>

Ambient Temperature : 23.2 °C

DASY5 Configuration:

- Probe: ER3DV6 - SN2434; ConvF(1, 1, 1); Calibrated: 2018.10.18;
- Sensor-Surface: (Fix Surface)
- Electronics: DAE4 Sn480; Calibrated: 2019.04.11
- Phantom: HAC Test Arch with AMCC; Type: SD HAC P01 BA;
- Measurement SW: DASY52, Version 52.8 (8); SEMCAD X Version 14.6.10 (7331)

**Device E-Ch661/Hearing Aid Compatibility Test (101x101x1):** Interpolated grid:

dx=0.5000 mm, dy=0.5000 mm

Device Reference Point: 0, 0, -6.3 mm

Reference Value = 2.922 V/m; Power Drift = -0.02 dB

Applied MIF = 3.63 dB

RF audio interference level = 15.77 dBV/m

**Emission category: M4**

MIF scaled E-field

<b>Grid 1 M4</b> <b>15 dBV/m</b>	<b>Grid 2 M4</b> <b>17.13 dBV/m</b>	<b>Grid 3 M4</b> <b>17.1 dBV/m</b>
<b>Grid 4 M4</b> <b>13.58 dBV/m</b>	<b>Grid 5 M4</b> <b>13.9 dBV/m</b>	<b>Grid 6 M4</b> <b>13.05 dBV/m</b>
<b>Grid 7 M4</b> <b>15.76 dBV/m</b>	<b>Grid 8 M4</b> <b>15.77 dBV/m</b>	<b>Grid 9 M4</b> <b>14.18 dBV/m</b>

**Cursor:**

Total = 17.13 dBV/m

E Category: M4

Location: -7, -25, 8.7 mm

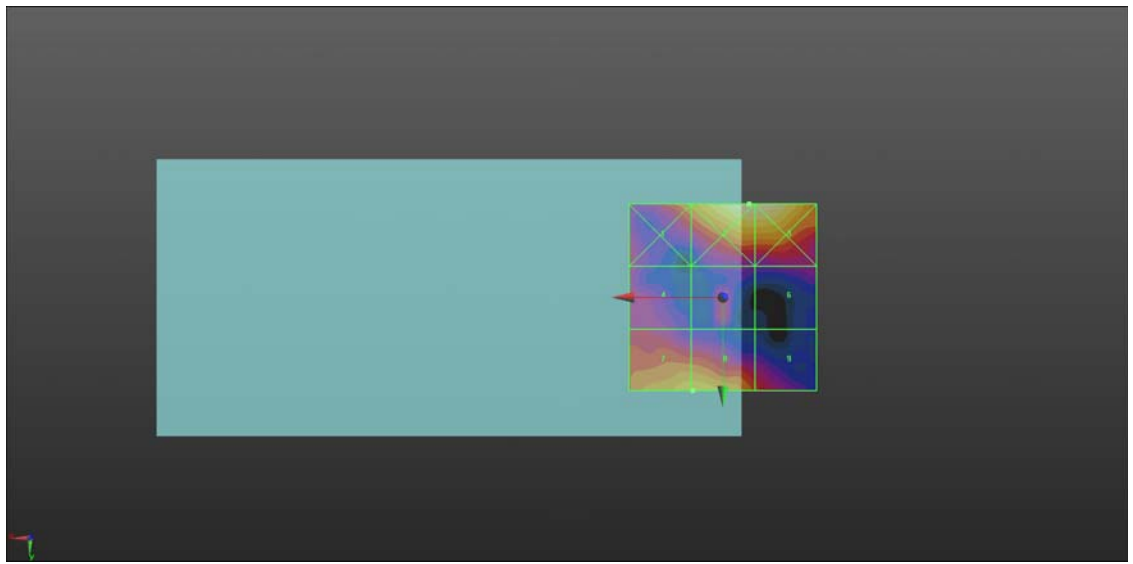
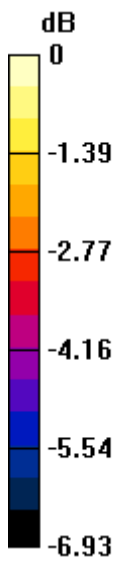

0 dB = 7.186 V/m = 17.13 dBV/m

## HAC RF\_GSM1900\_GSM Voice\_Ch810\_E

Communication System: UID 10021 - DAB, GSM-FDD (TDMA, GMSK); Frequency: 1909.8 MHz; Duty Cycle: 1:8.3

Medium: Air Medium parameters used:  $\sigma = 0$  S/m,  $\epsilon_r = 1$ ;  $\rho = 0$  kg/m<sup>3</sup>

Ambient Temperature : 23.2 °C

### DASY5 Configuration:

- Probe: ER3DV6 - SN2434; ConvF(1, 1, 1); Calibrated: 2018.10.18;
- Sensor-Surface: (Fix Surface)
- Electronics: DAE4 Sn480; Calibrated: 2019.04.11
- Phantom: HAC Test Arch with AMCC; Type: SD HAC P01 BA;
- Measurement SW: DASY52, Version 52.8 (8); SEMCAD X Version 14.6.10 (7331)

### Device E-Ch810/Hearing Aid Compatibility Test (101x101x1): Interpolated grid:

dx=0.5000 mm, dy=0.5000 mm

Device Reference Point: 0, 0, -6.3 mm

Reference Value = 2.939 V/m; Power Drift = 0.11 dB

Applied MIF = 3.63 dB

RF audio interference level = 15.60 dBV/m

**Emission category: M4**

MIF scaled E-field

<b>Grid 1 M4</b> <b>15.1 dBV/m</b>	<b>Grid 2 M4</b> <b>17.26 dBV/m</b>	<b>Grid 3 M4</b> <b>17.19 dBV/m</b>
<b>Grid 4 M4</b> <b>14.08 dBV/m</b>	<b>Grid 5 M4</b> <b>13.92 dBV/m</b>	<b>Grid 6 M4</b> <b>12.82 dBV/m</b>
<b>Grid 7 M4</b> <b>15.58 dBV/m</b>	<b>Grid 8 M4</b> <b>15.6 dBV/m</b>	<b>Grid 9 M4</b> <b>14.45 dBV/m</b>

### Cursor:

Total = 17.26 dBV/m

E Category: M4

Location: -6.5, -25, 8.7 mm

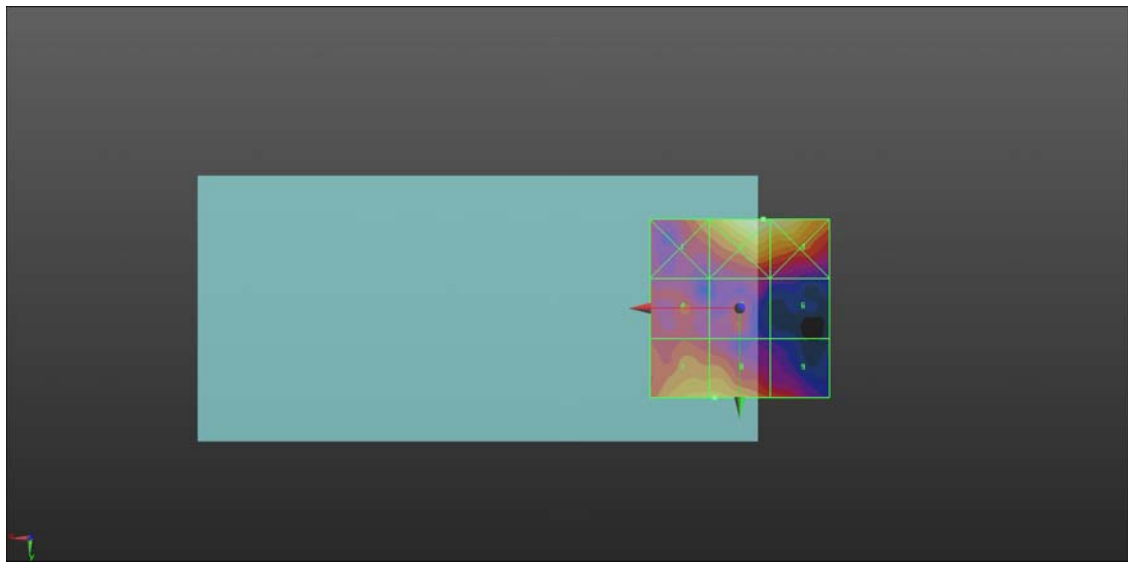
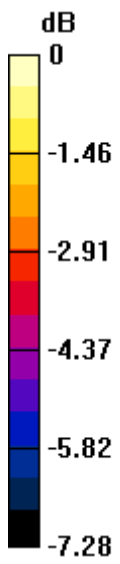

0 dB = 7.296 V/m = 17.26 dBV/m

**HAC RF\_CDMA2000 BC0\_RC1 SO3\_Ch1013\_E**

Communication System: UID 10295 - AAB, CDMA2000, RC1, SO3, 1/8th Rate 25 fr.; Frequency: 815.04 MHz; Duty Cycle: 1:1

Medium: Air Medium parameters used:  $\sigma = 0$  S/m,  $\epsilon_r = 1$ ;  $\rho = 0$  kg/m<sup>3</sup>

Ambient Temperature : 23.2 °C

**DASY5 Configuration:**

- Probe: ER3DV6 - SN2434; ConvF(1, 1, 1); Calibrated: 2018.10.18;
- Sensor-Surface: (Fix Surface)
- Electronics: DAE4 Sn480; Calibrated: 2019.04.11
- Phantom: HAC Test Arch with AMCC; Type: SD HAC P01 BA;
- Measurement SW: DASY52, Version 52.8 (8); SEMCAD X Version 14.6.10 (7331)

**Ch1013/Hearing Aid Compatibility Test (101x101x1):** Interpolated grid: dx=0.5000 mm, dy=0.5000 mm

Device Reference Point: 0, 0, -6.3 mm

Reference Value = 2.494 V/m; Power Drift = 0.07 dB

Applied MIF = 3.26 dB

RF audio interference level = 12.83 dBV/m

**Emission category: M4**

MIF scaled E-field

<b>Grid 1 M4</b> <b>11.84 dBV/m</b>	<b>Grid 2 M4</b> <b>10.47 dBV/m</b>	<b>Grid 3 M4</b> <b>9.86 dBV/m</b>
<b>Grid 4 M4</b> <b>12.71 dBV/m</b>	<b>Grid 5 M4</b> <b>12.83 dBV/m</b>	<b>Grid 6 M4</b> <b>9.7 dBV/m</b>
<b>Grid 7 M4</b> <b>12.09 dBV/m</b>	<b>Grid 8 M4</b> <b>11.03 dBV/m</b>	<b>Grid 9 M4</b> <b>9.6 dBV/m</b>

**Cursor:**

Total = 12.83 dBV/m

E Category: M4

Location: 0, 0.5, 8.7 mm

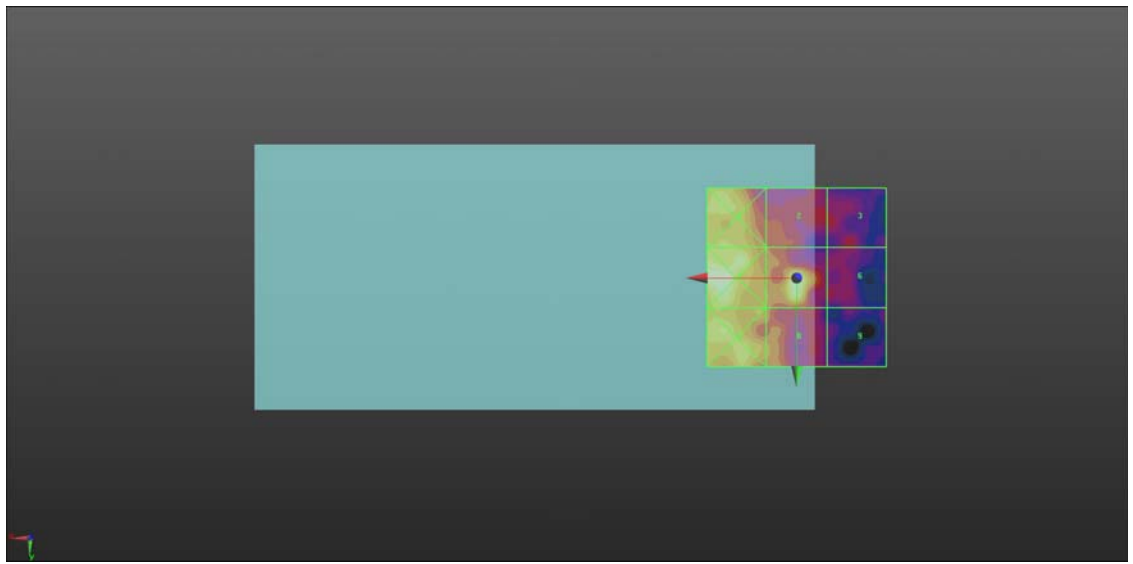
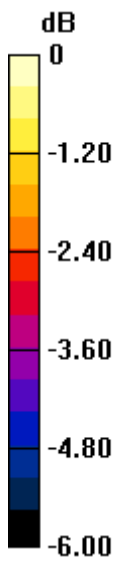

0 dB = 4.378 V/m = 12.83 dBV/m

**HAC RF\_CDMA2000 BC0\_RC1 SO3\_Ch384\_E**

Communication System: UID 10295 - AAB, CDMA2000, RC1, SO3, 1/8th Rate 25 fr.; Frequency: 836.52 MHz; Duty Cycle: 1:1

Medium: Air Medium parameters used:  $\sigma = 0$  S/m,  $\epsilon_r = 1$ ;  $\rho = 0$  kg/m<sup>3</sup>

Ambient Temperature : 23.2 °C; Liquid Temperature : 22.1 °C

**DASY5 Configuration:**

- Probe: ER3DV6 - SN2434; ConvF(1, 1, 1); Calibrated: 2018.10.18;
- Sensor-Surface: (Fix Surface)
- Electronics: DAE4 Sn480; Calibrated: 2019.04.11
- Phantom: HAC Test Arch with AMCC; Type: SD HAC P01 BA;
- Measurement SW: DASY52, Version 52.8 (8); SEMCAD X Version 14.6.10 (7331)

**Ch384/Hearing Aid Compatibility Test (101x101x1):** Interpolated grid: dx=0.5000 mm, dy=0.5000 mm

Device Reference Point: 0, 0, -6.3 mm

Reference Value = 2.508 V/m; Power Drift = 0.07 dB

Applied MIF = 3.26 dB

RF audio interference level = 12.65 dBV/m

**Emission category: M4**

MIF scaled E-field

Grid 1 <b>M4</b> <b>12.24 dBV/m</b>	Grid 2 <b>M4</b> <b>10.29 dBV/m</b>	Grid 3 <b>M4</b> <b>8.42 dBV/m</b>
Grid 4 <b>M4</b> <b>12.68 dBV/m</b>	Grid 5 <b>M4</b> <b>12.65 dBV/m</b>	Grid 6 <b>M4</b> <b>8.31 dBV/m</b>
Grid 7 <b>M4</b> <b>12.87 dBV/m</b>	Grid 8 <b>M4</b> <b>10.34 dBV/m</b>	Grid 9 <b>M4</b> <b>7.64 dBV/m</b>

**Cursor:**

Total = 12.87 dBV/m

E Category: M4

Location: 20.5, 14.5, 8.7 mm

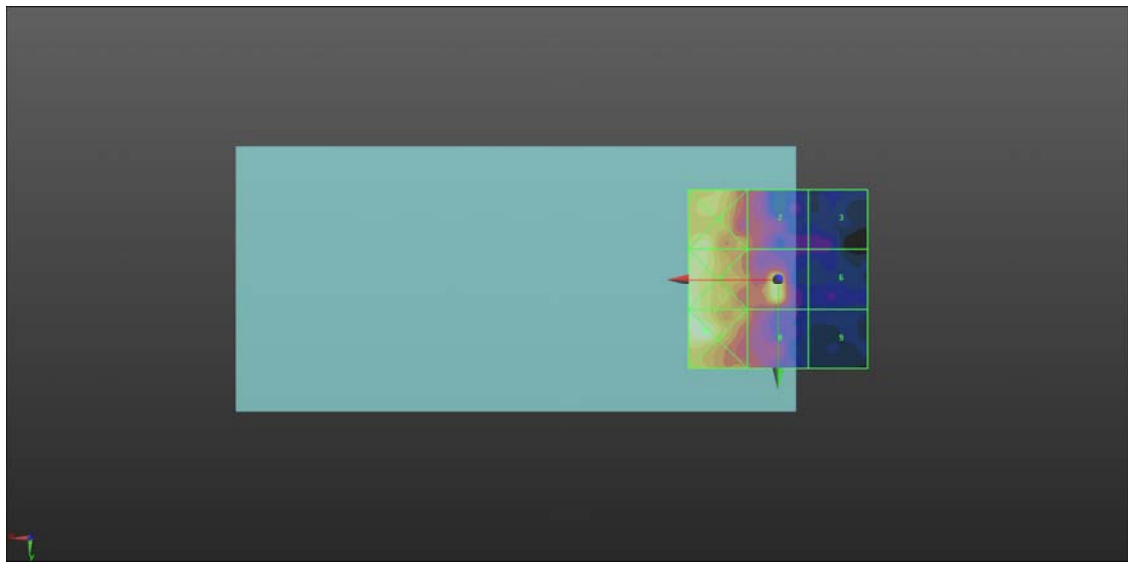
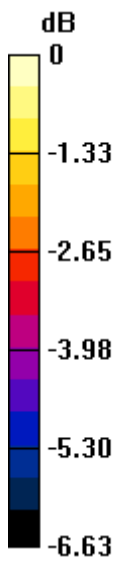

0 dB = 4.400 V/m = 12.87 dBV/m



**HAC RF\_CDMA2000 BC0\_RC1 SO3\_Ch777\_E**

Communication System: UID 10295 - AAB, CDMA2000, RC1, SO3, 1/8th Rate 25 fr.; Frequency: 848.97 MHz; Duty Cycle: 1:1

Medium: Air Medium parameters used:  $\sigma = 0$  S/m,  $\epsilon_r = 1$ ;  $\rho = 0$  kg/m<sup>3</sup>

Ambient Temperature : 23.2 °C

**DASY5 Configuration:**

- Probe: ER3DV6 - SN2434; ConvF(1, 1, 1); Calibrated: 2018.10.18;
- Sensor-Surface: (Fix Surface)
- Electronics: DAE4 Sn480; Calibrated: 2019.04.11
- Phantom: HAC Test Arch with AMCC; Type: SD HAC P01 BA;
- Measurement SW: DASY52, Version 52.8 (8); SEMCAD X Version 14.6.10 (7331)

**Ch777/Hearing Aid Compatibility Test (101x101x1):** Interpolated grid: dx=0.5000 mm, dy=0.5000 mm

Device Reference Point: 0, 0, -6.3 mm

Reference Value = 2.400 V/m; Power Drift = 0.10 dB

Applied MIF = 3.26 dB

RF audio interference level = 12.40 dBV/m

**Emission category: M4**

MIF scaled E-field

<b>Grid 1 M4</b> <b>11.82 dBV/m</b>	<b>Grid 2 M4</b> <b>10.82 dBV/m</b>	<b>Grid 3 M4</b> <b>9.57 dBV/m</b>
<b>Grid 4 M4</b> <b>12.85 dBV/m</b>	<b>Grid 5 M4</b> <b>12.4 dBV/m</b>	<b>Grid 6 M4</b> <b>8.96 dBV/m</b>
<b>Grid 7 M4</b> <b>12.33 dBV/m</b>	<b>Grid 8 M4</b> <b>11.02 dBV/m</b>	<b>Grid 9 M4</b> <b>8.85 dBV/m</b>

**Cursor:**

Total = 12.85 dBV/m

E Category: M4

Location: 21, 0.5, 8.7 mm

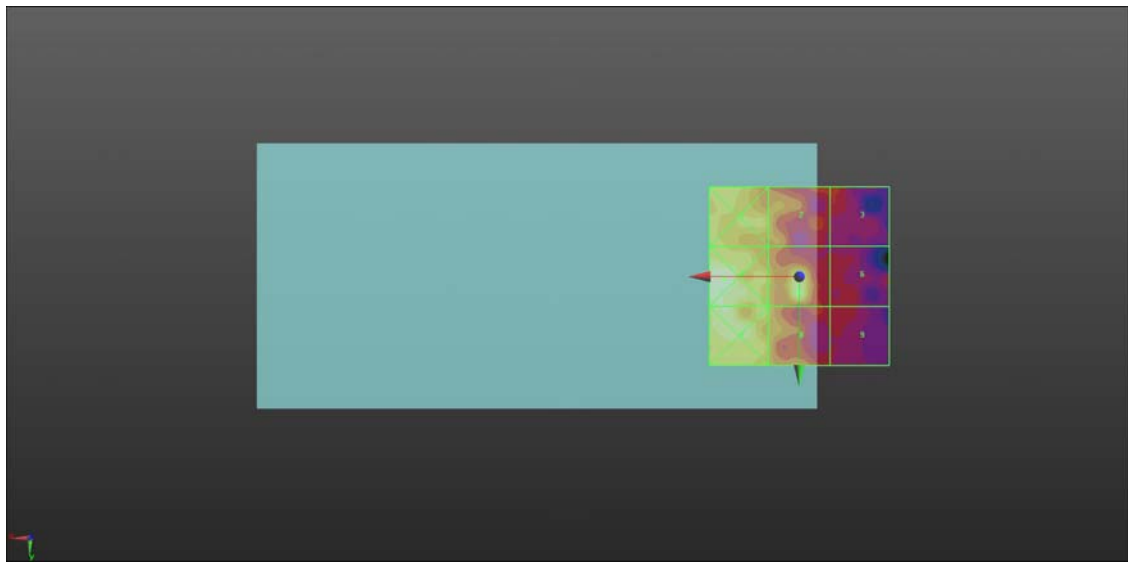
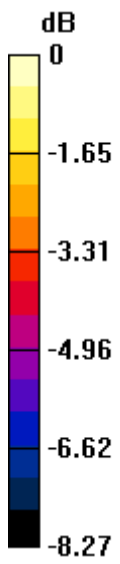

0 dB = 4.388 V/m = 12.85 dBV/m

**HAC RF\_CDMA2000 BC1\_RC1 SO3\_Ch25\_E**

Communication System: UID 10295 - AAB, CDMA2000, RC1, SO3, 1/8th Rate 25 fr.; Frequency: 1851.25 MHz; Duty Cycle: 1:1

Medium: Air Medium parameters used:  $\sigma = 0$  S/m,  $\epsilon_r = 1$ ;  $\rho = 0$  kg/m<sup>3</sup>

Ambient Temperature : 23.2 °C

**DASY5 Configuration:**

- Probe: ER3DV6 - SN2434; ConvF(1, 1, 1); Calibrated: 2018.10.18;
- Sensor-Surface: (Fix Surface)
- Electronics: DAE4 Sn480; Calibrated: 2019.04.11
- Phantom: HAC Test Arch with AMCC; Type: SD HAC P01 BA;
- Measurement SW: DASY52, Version 52.8 (8); SEMCAD X Version 14.6.10 (7331)

**Ch25/Hearing Aid Compatibility Test (101x101x1):** Interpolated grid: dx=0.5000 mm, dy=0.5000 mm

Device Reference Point: 0, 0, -6.3 mm

Reference Value = 2.359 V/m; Power Drift = -0.11 dB

Applied MIF = 3.26 dB

RF audio interference level = 12.81 dBV/m

**Emission category: M4**

MIF scaled E-field

<b>Grid 1 M4</b> <b>11.83 dBV/m</b>	<b>Grid 2 M4</b> <b>10.83 dBV/m</b>	<b>Grid 3 M4</b> <b>9.54 dBV/m</b>
<b>Grid 4 M4</b> <b>12.19 dBV/m</b>	<b>Grid 5 M4</b> <b>12.81 dBV/m</b>	<b>Grid 6 M4</b> <b>9.73 dBV/m</b>
<b>Grid 7 M4</b> <b>11.88 dBV/m</b>	<b>Grid 8 M4</b> <b>11.04 dBV/m</b>	<b>Grid 9 M4</b> <b>9.33 dBV/m</b>

**Cursor:**

Total = 12.81 dBV/m

E Category: M4

Location: 0.5, 0.5, 8.7 mm

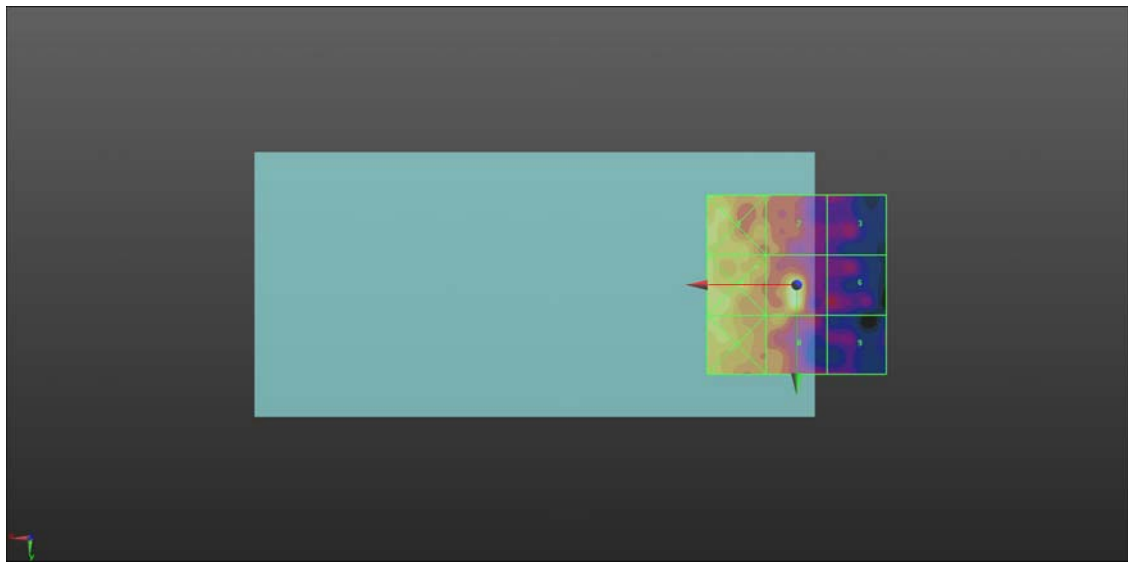
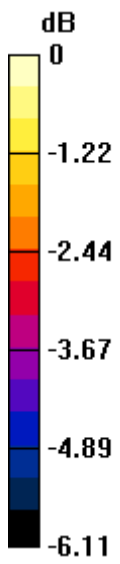

0 dB = 4.368 V/m = 12.81 dBV/m

**HAC RF\_CDMA2000 BC1\_RC1 SO3\_Ch600\_E**

Communication System: UID 10295 - AAB, CDMA2000, RC1, SO3, 1/8th Rate 25 fr.; Frequency: 1880 MHz; Duty Cycle: 1:1

Medium: Air Medium parameters used:  $\sigma = 0$  S/m,  $\epsilon_r = 1$ ;  $\rho = 0$  kg/m<sup>3</sup>

Ambient Temperature : 23.2 °C

**DASY5 Configuration:**

- Probe: ER3DV6 - SN2434; ConvF(1, 1, 1); Calibrated: 2018.10.18;
- Sensor-Surface: (Fix Surface)
- Electronics: DAE4 Sn480; Calibrated: 2019.04.11
- Phantom: HAC Test Arch with AMCC; Type: SD HAC P01 BA;
- Measurement SW: DASY52, Version 52.8 (8); SEMCAD X Version 14.6.10 (7331)

**Ch600/Hearing Aid Compatibility Test (101x101x1):** Interpolated grid: dx=0.5000 mm, dy=0.5000 mm

Device Reference Point: 0, 0, -6.3 mm

Reference Value = 2.223 V/m; Power Drift = 0.02 dB

Applied MIF = 3.26 dB

RF audio interference level = 11.77 dBV/m

**Emission category: M4**

MIF scaled E-field

<b>Grid 1 M4</b> <b>11.47 dBV/m</b>	<b>Grid 2 M4</b> <b>9.92 dBV/m</b>	<b>Grid 3 M4</b> <b>7.97 dBV/m</b>
<b>Grid 4 M4</b> <b>12.34 dBV/m</b>	<b>Grid 5 M4</b> <b>11.77 dBV/m</b>	<b>Grid 6 M4</b> <b>8.16 dBV/m</b>
<b>Grid 7 M4</b> <b>11.25 dBV/m</b>	<b>Grid 8 M4</b> <b>9.82 dBV/m</b>	<b>Grid 9 M4</b> <b>7.61 dBV/m</b>

**Cursor:**

Total = 12.34 dBV/m

E Category: M4

Location: 25, 0, 8.7 mm

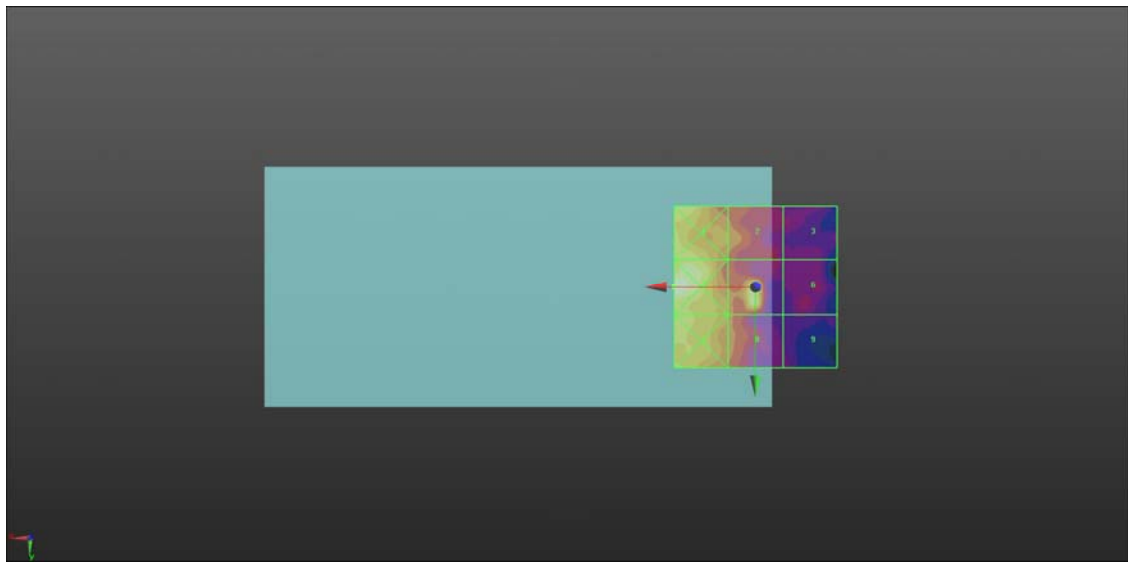
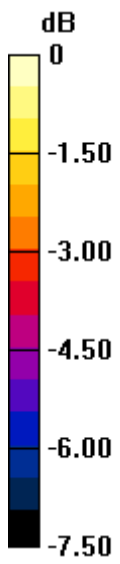

0 dB = 4.141 V/m = 12.34 dBV/m

**HAC RF\_CDMA2000 BC1\_RC1 SO3\_Ch1175\_E**

Communication System: UID 10295 - AAB, CDMA2000, RC1, SO3, 1/8th Rate 25 fr.; Frequency: 1909.95 MHz; Duty Cycle: 1:1

Medium: Air Medium parameters used:  $\sigma = 0$  S/m,  $\epsilon_r = 1$ ;  $\rho = 0$  kg/m<sup>3</sup>

Ambient Temperature : 23.2 °C

**DASY5 Configuration:**

- Probe: ER3DV6 - SN2434; ConvF(1, 1, 1); Calibrated: 2018.10.18;
- Sensor-Surface: (Fix Surface)
- Electronics: DAE4 Sn480; Calibrated: 2019.04.11
- Phantom: HAC Test Arch with AMCC; Type: SD HAC P01 BA;
- Measurement SW: DASY52, Version 52.8 (8); SEMCAD X Version 14.6.10 (7331)

**Ch1175/Hearing Aid Compatibility Test (101x101x1):** Interpolated grid: dx=0.5000 mm, dy=0.5000 mm

Device Reference Point: 0, 0, -6.3 mm

Reference Value = 2.355 V/m; Power Drift = -0.16 dB

Applied MIF = 3.26 dB

RF audio interference level = 12.32 dBV/m

**Emission category: M4**

MIF scaled E-field

Grid 1 <b>M4</b> <b>11.9 dBV/m</b>	Grid 2 <b>M4</b> <b>10.28 dBV/m</b>	Grid 3 <b>M4</b> <b>8.43 dBV/m</b>
Grid 4 <b>M4</b> <b>12.06 dBV/m</b>	Grid 5 <b>M4</b> <b>12.32 dBV/m</b>	Grid 6 <b>M4</b> <b>8.46 dBV/m</b>
Grid 7 <b>M4</b> <b>11.78 dBV/m</b>	Grid 8 <b>M4</b> <b>10.2 dBV/m</b>	Grid 9 <b>M4</b> <b>8.64 dBV/m</b>

**Cursor:**

Total = 12.32 dBV/m

E Category: M4

Location: 0.5, 0.5, 8.7 mm

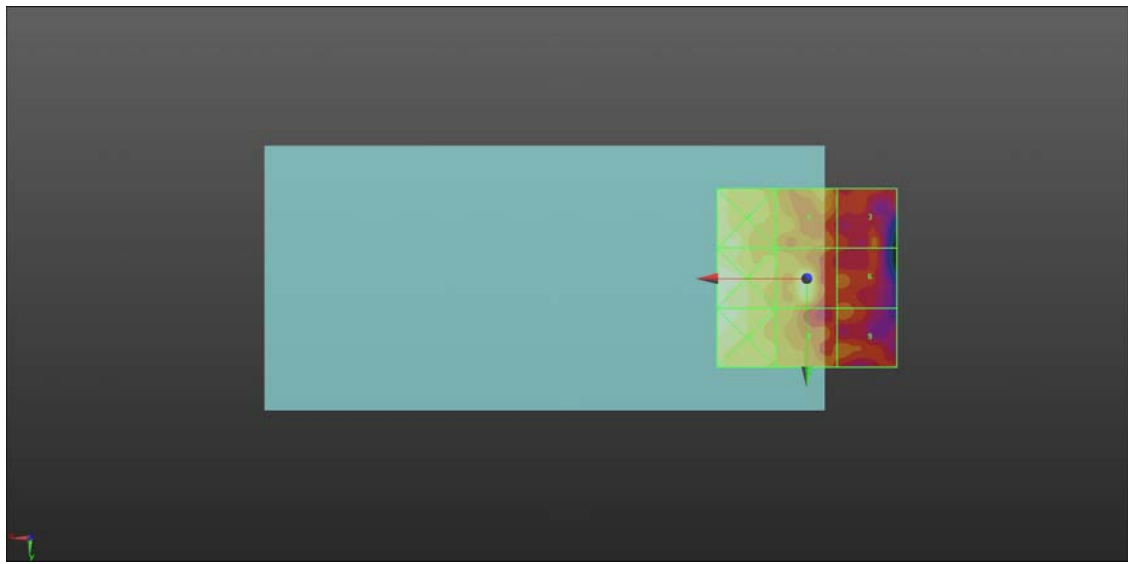
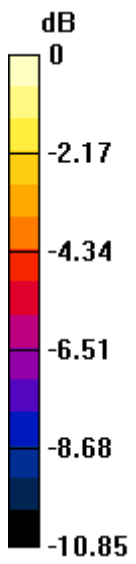

0 dB = 4.129 V/m = 12.32 dBV/m



**HAC RF\_LTE Band 38\_20M\_QPSK\_1RB\_0offset\_12.2Kbps\_Ch37850\_E**

Communication System: UID 10173 - CAB, LTE-TDD (SC-FDMA, 1 RB, 20 MHz, 16-QAM);  
 Frequency: 2580 MHz; Duty Cycle: 1:1.59

Medium: Air Medium parameters used:  $\sigma = 0$  S/m,  $\epsilon_r = 1$ ;  $\rho = 0$  kg/m<sup>3</sup>

Ambient Temperature : 23.2 °C

**DASY5 Configuration:**

- Probe: ER3DV6 - SN2434; ConvF(1, 1, 1); Calibrated: 2018.10.18;
- Sensor-Surface: (Fix Surface)
- Electronics: DAE4 Sn480; Calibrated: 2019.04.11
- Phantom: HAC Test Arch with AMCC; Type: SD HAC P01 BA;
- Measurement SW: DASY52, Version 52.8 (8); SEMCAD X Version 14.6.10 (7331)

**Ch37850/Hearing Aid Compatibility Test (101x101x1):** Interpolated grid: dx=0.5000 mm, dy=0.5000 mm

Device Reference Point: 0, 0, -6.3 mm

Reference Value = 8.249 V/m; Power Drift = 0.03 dB

Applied MIF = -1.44 dB

RF audio interference level = 16.33 dBV/m

**Emission category: M4**

MIF scaled E-field

<b>Grid 1 M4</b> <b>16.54 dBV/m</b>	<b>Grid 2 M4</b> <b>18.35 dBV/m</b>	<b>Grid 3 M4</b> <b>18.38 dBV/m</b>
<b>Grid 4 M4</b> <b>13.19 dBV/m</b>	<b>Grid 5 M4</b> <b>16.33 dBV/m</b>	<b>Grid 6 M4</b> <b>16.15 dBV/m</b>
<b>Grid 7 M4</b> <b>11.47 dBV/m</b>	<b>Grid 8 M4</b> <b>13.11 dBV/m</b>	<b>Grid 9 M4</b> <b>12.83 dBV/m</b>

**Cursor:**

Total = 18.38 dBV/m

E Category: M4

Location: -10, -25, 8.7 mm

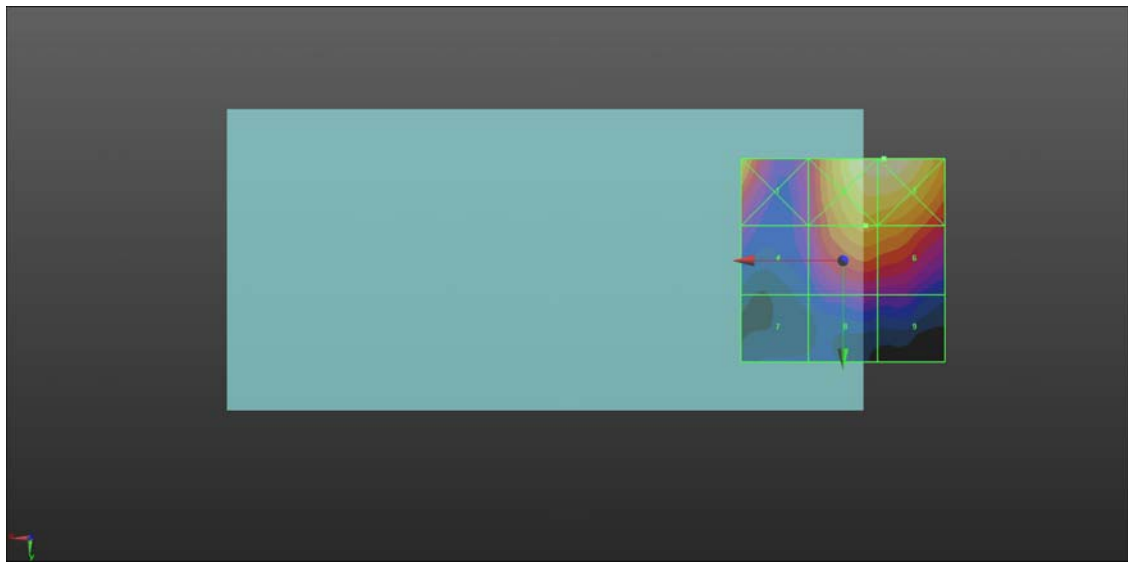
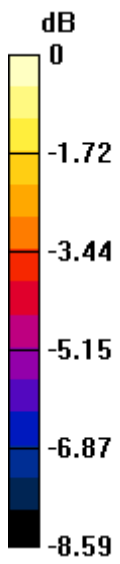

0 dB = 8.298 V/m = 18.38 dBV/m

**HAC RF\_LTE Band 38\_20M\_QPSK\_1RB\_0offset\_12.2Kbps\_Ch38000\_E**

Communication System: UID 10172 - CAB, LTE-TDD (SC-FDMA, 1 RB, 20 MHz, QPSK);  
 Frequency: 2595 MHz; Duty Cycle: 1:1.59

Medium: Air Medium parameters used:  $\sigma = 0$  S/m,  $\epsilon_r = 1$ ;  $\rho = 0$  kg/m<sup>3</sup>

Ambient Temperature : 23.2 °C

**DASY5 Configuration:**

- Probe: ER3DV6 - SN2434; ConvF(1, 1, 1); Calibrated: 2018.10.18;
- Sensor-Surface: (Fix Surface)
- Electronics: DAE4 Sn480; Calibrated: 2019.04.11
- Phantom: HAC Test Arch with AMCC; Type: SD HAC P01 BA;
- Measurement SW: DASY52, Version 52.8 (8); SEMCAD X Version 14.6.10 (7331)

**Ch38000/Hearing Aid Compatibility Test (101x101x1):** Interpolated grid: dx=0.5000 mm, dy=0.5000 mm

Device Reference Point: 0, 0, -6.3 mm

Reference Value = 6.548 V/m; Power Drift = -0.05 dB

Applied MIF = -1.62 dB

RF audio interference level = 16.30 dBV/m

**Emission category: M4**

MIF scaled E-field

<b>Grid 1 M4</b> <b>12.1 dBV/m</b>	<b>Grid 2 M4</b> <b>16.57 dBV/m</b>	<b>Grid 3 M4</b> <b>16.79 dBV/m</b>
<b>Grid 4 M4</b> <b>11.82 dBV/m</b>	<b>Grid 5 M4</b> <b>16.3 dBV/m</b>	<b>Grid 6 M4</b> <b>16.66 dBV/m</b>
<b>Grid 7 M4</b> <b>13.89 dBV/m</b>	<b>Grid 8 M4</b> <b>13.81 dBV/m</b>	<b>Grid 9 M4</b> <b>15.19 dBV/m</b>

**Cursor:**

Total = 16.79 dBV/m

E Category: M4

Location: -14, -13, 8.7 mm

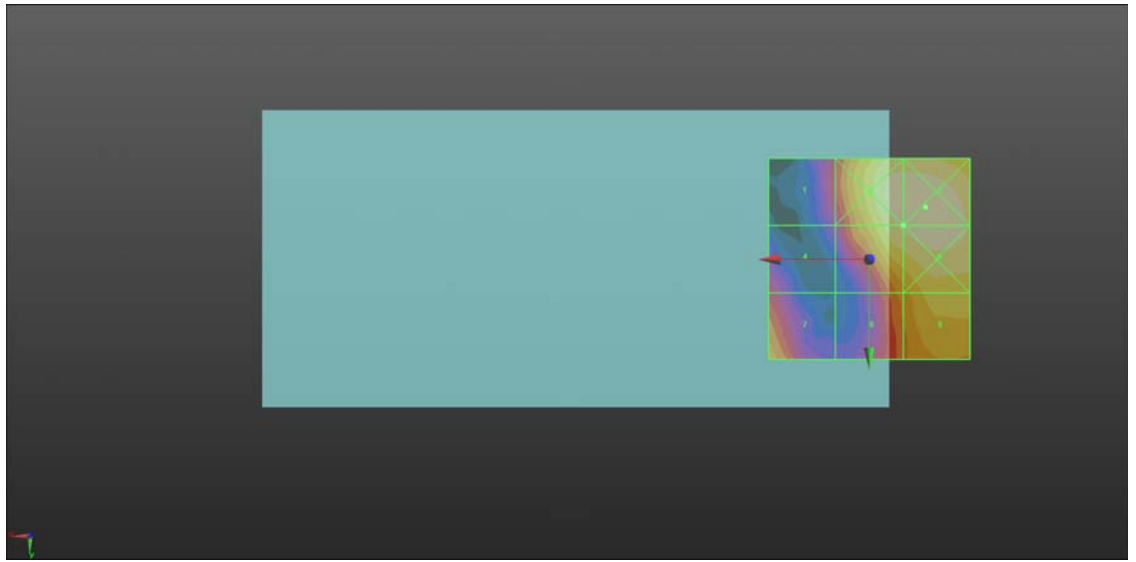
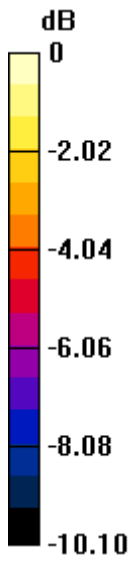

0 dB = 6.908 V/m = 16.79 dBV/m

**HAC RF\_LTE Band 38\_20M\_QPSK\_1RB\_0offset\_12.2Kbps\_Ch38150\_E**

Communication System: UID 10103 - CAB, LTE-TDD (SC-FDMA, 100% RB, 20 MHz, QPSK);  
 Frequency: 2619.9 MHz; Duty Cycle: 1:1.59

Medium: Air Medium parameters used:  $\sigma = 0$  S/m,  $\epsilon_r = 1$ ;  $\rho = 0$  kg/m<sup>3</sup>

Ambient Temperature : 23.2 °C

**DASY5 Configuration:**

- Probe: ER3DV6 - SN2434; ConvF(1, 1, 1); Calibrated: 2018.10.18;
- Sensor-Surface: (Fix Surface)
- Electronics: DAE4 Sn480; Calibrated: 2019.04.11
- Phantom: HAC Test Arch with AMCC; Type: SD HAC P01 BA;
- Measurement SW: DASY52, Version 52.8 (8); SEMCAD X Version 14.6.10 (7331)

**Ch38150/Hearing Aid Compatibility Test (101x101x1):** Interpolated grid: dx=0.5000 mm, dy=0.5000 mm

Device Reference Point: 0, 0, -6.3 mm

Reference Value = 5.449 V/m; Power Drift = 0.05 dB

Applied MIF = -1.64 dB

RF audio interference level = 14.56 dBV/m

**Emission category: M4**

MIF scaled E-field

<b>Grid 1 M4</b> <b>10.31 dBV/m</b>	<b>Grid 2 M4</b> <b>14.85 dBV/m</b>	<b>Grid 3 M4</b> <b>15.11 dBV/m</b>
<b>Grid 4 M4</b> <b>11.53 dBV/m</b>	<b>Grid 5 M4</b> <b>14.56 dBV/m</b>	<b>Grid 6 M4</b> <b>15.01 dBV/m</b>
<b>Grid 7 M4</b> <b>12.78 dBV/m</b>	<b>Grid 8 M4</b> <b>12.2 dBV/m</b>	<b>Grid 9 M4</b> <b>13.92 dBV/m</b>

**Cursor:**

Total = 15.11 dBV/m

E Category: M4

Location: -14, -13.5, 8.7 mm

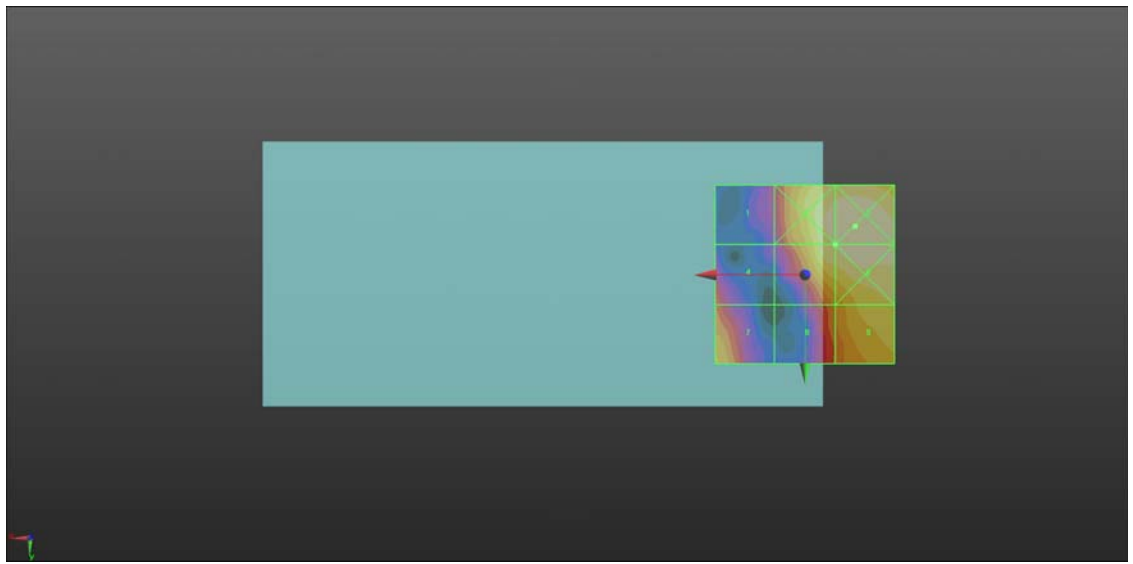
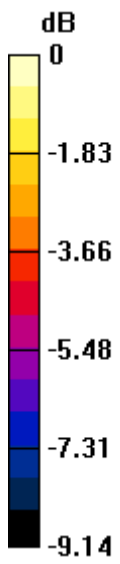

0 dB = 5.692 V/m = 15.11 dBV/m

**HAC RF\_LTE Band 40A\_10M\_QPSK\_1RB\_0offset\_12.2Kbps\_Ch38750\_E**

Communication System: UID 10237 - CAB, LTE-TDD (SC-FDMA, 1 RB, 10 MHz, QPSK);  
 Frequency: 2310 MHz; Duty Cycle: 1:1.59

Medium: Air Medium parameters used:  $\sigma = 0$  S/m,  $\epsilon_r = 1$ ;  $\rho = 0$  kg/m<sup>3</sup>

Ambient Temperature : 23.2 °C

**DASY5 Configuration:**

- Probe: ER3DV6 - SN2434; ConvF(1, 1, 1); Calibrated: 2018.10.18;
- Sensor-Surface: (Fix Surface)
- Electronics: DAE4 Sn480; Calibrated: 2019.04.11
- Phantom: HAC Test Arch with AMCC; Type: SD HAC P01 BA;
- Measurement SW: DASY52, Version 52.8 (8); SEMCAD X Version 14.6.10 (7331)

**Ch38750/Hearing Aid Compatibility Test (101x101x1):** Interpolated grid: dx=0.5000 mm, dy=0.5000 mm

Device Reference Point: 0, 0, -6.3 mm

Reference Value = 8.393 V/m; Power Drift = -0.17 dB

Applied MIF = -1.62 dB

RF audio interference level = 16.14 dBV/m

**Emission category: M4**

MIF scaled E-field

<b>Grid 1 M4</b> <b>16.23 dBV/m</b>	<b>Grid 2 M4</b> <b>18.01 dBV/m</b>	<b>Grid 3 M4</b> <b>18.02 dBV/m</b>
<b>Grid 4 M4</b> <b>13.05 dBV/m</b>	<b>Grid 5 M4</b> <b>16.14 dBV/m</b>	<b>Grid 6 M4</b> <b>16.03 dBV/m</b>
<b>Grid 7 M4</b> <b>11.1 dBV/m</b>	<b>Grid 8 M4</b> <b>12.9 dBV/m</b>	<b>Grid 9 M4</b> <b>12.88 dBV/m</b>

**Cursor:**

Total = 18.02 dBV/m

E Category: M4

Location: -9.5, -25, 8.7 mm

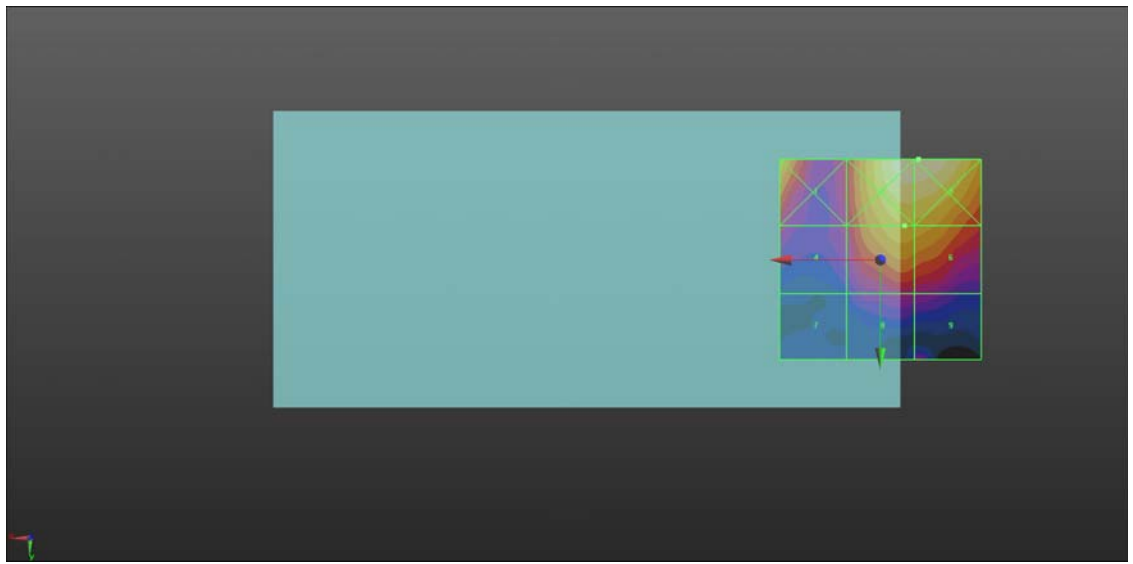
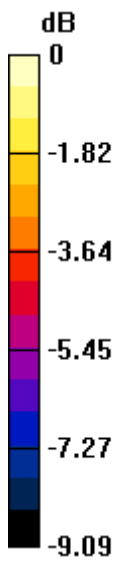

0 dB = 7.957 V/m = 18.01 dBV/m



**HAC RF\_LTE Band 40B\_10M\_QPSK\_1RB\_25offset\_12.2Kbps\_Ch39200\_E**

Communication System: UID 10237 - CAB, LTE-TDD (SC-FDMA, 1 RB, 10 MHz, QPSK);  
 Frequency: 2355 MHz; Duty Cycle: 1:1.59

Medium: Air Medium parameters used:  $\sigma = 0$  S/m,  $\epsilon_r = 1$ ;  $\rho = 0$  kg/m<sup>3</sup>

Ambient Temperature : 23.2 °C

**DASY5 Configuration:**

- Probe: ER3DV6 - SN2434; ConvF(1, 1, 1); Calibrated: 2018.10.18;
- Sensor-Surface: (Fix Surface)
- Electronics: DAE4 Sn480; Calibrated: 2019.04.11
- Phantom: HAC Test Arch with AMCC; Type: SD HAC P01 BA;
- Measurement SW: DASY52, Version 52.8 (8); SEMCAD X Version 14.6.10 (7331)

**Ch39200/Hearing Aid Compatibility Test (101x101x1):** Interpolated grid: dx=0.5000 mm, dy=0.5000 mm

Device Reference Point: 0, 0, -6.3 mm

Reference Value = 7.311 V/m; Power Drift = -0.07 dB

Applied MIF = -1.62 dB

RF audio interference level = 16.37 dBV/m

**Emission category: M4**

MIF scaled E-field

<b>Grid 1 M4</b> <b>15.76 dBV/m</b>	<b>Grid 2 M4</b> <b>18.69 dBV/m</b>	<b>Grid 3 M4</b> <b>18.83 dBV/m</b>
<b>Grid 4 M4</b> <b>12.54 dBV/m</b>	<b>Grid 5 M4</b> <b>16.37 dBV/m</b>	<b>Grid 6 M4</b> <b>16.54 dBV/m</b>
<b>Grid 7 M4</b> <b>11.3 dBV/m</b>	<b>Grid 8 M4</b> <b>12.5 dBV/m</b>	<b>Grid 9 M4</b> <b>12.44 dBV/m</b>

**Cursor:**

Total = 18.83 dBV/m

E Category: M4

Location: -12, -25, 8.7 mm

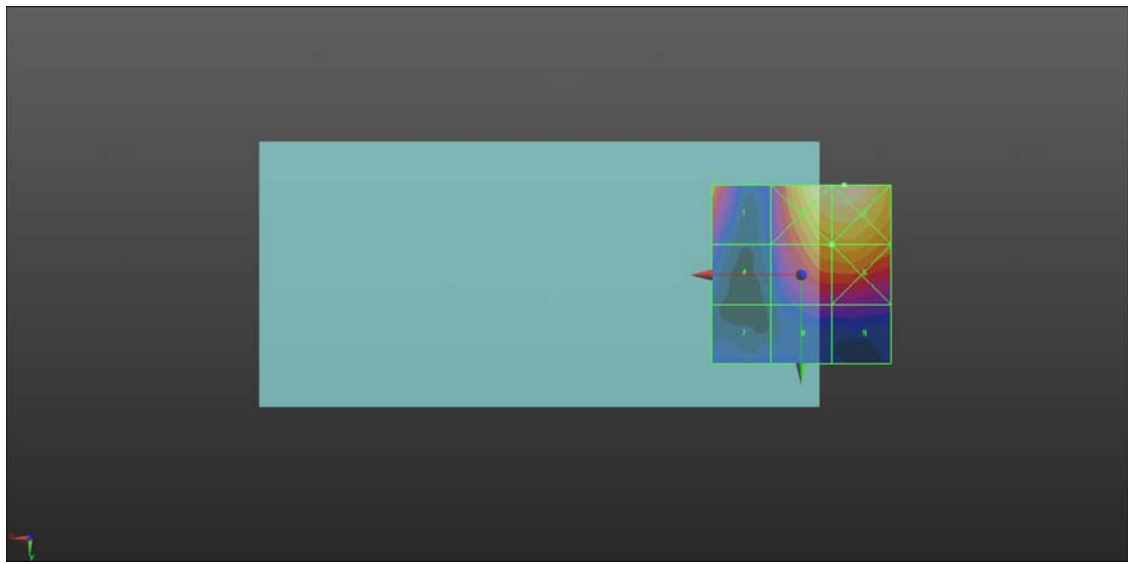
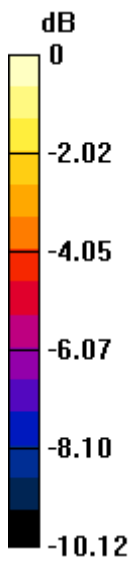

0 dB = 8.744 V/m = 18.83 dBV/m

**HAC RF\_LTE Band 41\_20M\_QPSK\_1RB\_99offset\_12.2Kbps\_Ch40340\_E**

Communication System: UID 10172 - CAB, LTE-TDD (SC-FDMA, 1 RB, 20 MHz, QPSK);  
 Frequency: 2565 MHz; Duty Cycle: 1:1.59

Medium: Air Medium parameters used:  $\sigma = 0$  S/m,  $\epsilon_r = 1$ ;  $\rho = 0$  kg/m<sup>3</sup>

Ambient Temperature : 23.2 °C; Liquid Temperature : 22.1 °C

**DASY5 Configuration:**

- Probe: ER3DV6 - SN2434; ConvF(1, 1, 1); Calibrated: 2018.10.18;
- Sensor-Surface: (Fix Surface)
- Electronics: DAE4 Sn480; Calibrated: 2019.04.11
- Phantom: HAC Test Arch with AMCC; Type: SD HAC P01 BA;
- Measurement SW: DASY52, Version 52.8 (8); SEMCAD X Version 14.6.10 (7331)

**Ch40340/Hearing Aid Compatibility Test (101x101x1):** Interpolated grid: dx=0.5000 mm, dy=0.5000 mm

Device Reference Point: 0, 0, -6.3 mm

Reference Value = 7.435 V/m; Power Drift = -0.02 dB

Applied MIF = -1.62 dB

RF audio interference level = 15.84 dBV/m

**Emission category: M4**

MIF scaled E-field

<b>Grid 1 M4</b> <b>12.08 dBV/m</b>	<b>Grid 2 M4</b> <b>16.03 dBV/m</b>	<b>Grid 3 M4</b> <b>16.07 dBV/m</b>
<b>Grid 4 M4</b> <b>11.84 dBV/m</b>	<b>Grid 5 M4</b> <b>15.84 dBV/m</b>	<b>Grid 6 M4</b> <b>15.93 dBV/m</b>
<b>Grid 7 M4</b> <b>9.2 dBV/m</b>	<b>Grid 8 M4</b> <b>13.67 dBV/m</b>	<b>Grid 9 M4</b> <b>14.1 dBV/m</b>

**Cursor:**

Total = 16.07 dBV/m

E Category: M4

Location: -11, -13.5, 8.7 mm

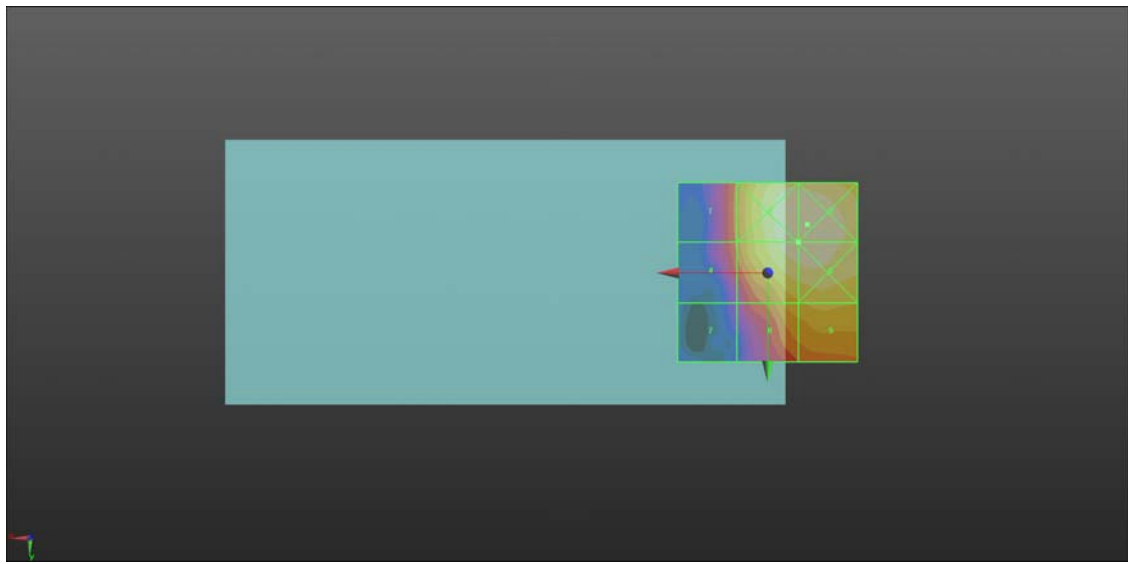
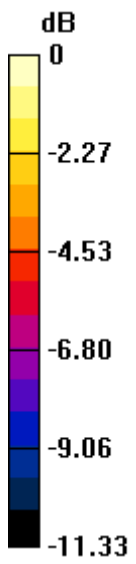

0 dB = 6.362 V/m = 16.07 dBV/m

**HAC RF\_LTE Band 41\_20M\_QPSK\_1RB\_99offset\_12.2Kbps\_Ch40600\_E**

Communication System: UID 10172 - CAB, LTE-TDD (SC-FDMA, 1 RB, 20 MHz, QPSK);  
 Frequency: 2591 MHz; Duty Cycle: 1:1.59

Medium: Air Medium parameters used:  $\sigma = 0$  S/m,  $\epsilon_r = 1$ ;  $\rho = 0$  kg/m<sup>3</sup>

Ambient Temperature : 23.2 °C

**DASY5 Configuration:**

- Probe: ER3DV6 - SN2434; ConvF(1, 1, 1); Calibrated: 2018.10.18;
- Sensor-Surface: (Fix Surface)
- Electronics: DAE4 Sn480; Calibrated: 2019.04.11
- Phantom: HAC Test Arch with AMCC; Type: SD HAC P01 BA;
- Measurement SW: DASY52, Version 52.8 (8); SEMCAD X Version 14.6.10 (7331)

**Ch40600/Hearing Aid Compatibility Test (101x101x1):** Interpolated grid: dx=0.5000 mm, dy=0.5000 mm

Device Reference Point: 0, 0, -6.3 mm

Reference Value = 8.013 V/m; Power Drift = -0.06 dB

Applied MIF = -1.62 dB

RF audio interference level = 16.93 dBV/m

**Emission category: M4**

MIF scaled E-field

<b>Grid 1 M4</b> <b>12.83 dBV/m</b>	<b>Grid 2 M4</b> <b>17.14 dBV/m</b>	<b>Grid 3 M4</b> <b>17.2 dBV/m</b>
<b>Grid 4 M4</b> <b>11.73 dBV/m</b>	<b>Grid 5 M4</b> <b>16.93 dBV/m</b>	<b>Grid 6 M4</b> <b>17.06 dBV/m</b>
<b>Grid 7 M4</b> <b>10.27 dBV/m</b>	<b>Grid 8 M4</b> <b>14.45 dBV/m</b>	<b>Grid 9 M4</b> <b>15.21 dBV/m</b>

**Cursor:**

Total = 17.20 dBV/m

E Category: M4

Location: -11.5, -13, 8.7 mm

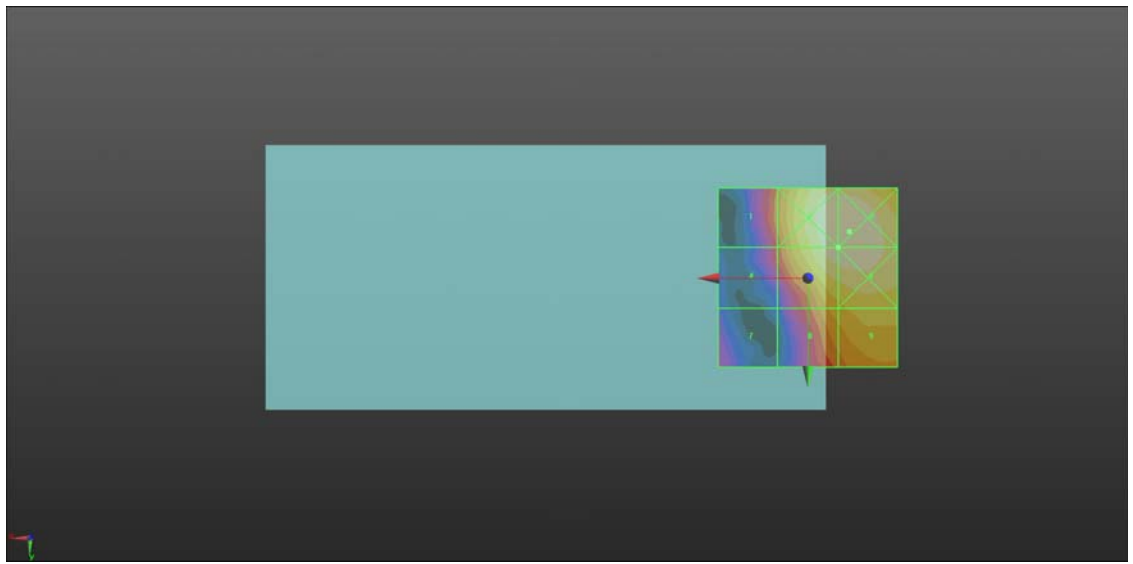
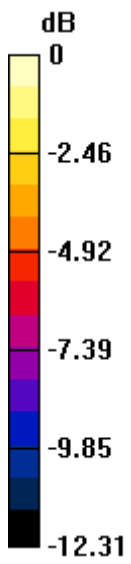

0 dB = 7.241 V/m = 17.20 dBV/m

**HAC RF\_LTE Band 41\_20M\_QPSK\_1RB\_99offset\_12.2Kbps\_Ch40870\_E**

Communication System: UID 10172 - CAB, LTE-TDD (SC-FDMA, 1 RB, 20 MHz, QPSK);  
 Frequency: 2618 MHz; Duty Cycle: 1:1.59

Medium: Air Medium parameters used:  $\sigma = 0$  S/m,  $\epsilon_r = 1$ ;  $\rho = 0$  kg/m<sup>3</sup>

Ambient Temperature : 23.2 °C

**DASY5 Configuration:**

- Probe: ER3DV6 - SN2434; ConvF(1, 1, 1); Calibrated: 2018.10.18;
- Sensor-Surface: (Fix Surface)
- Electronics: DAE4 Sn480; Calibrated: 2019.04.11
- Phantom: HAC Test Arch with AMCC; Type: SD HAC P01 BA;
- Measurement SW: DASY52, Version 52.8 (8); SEMCAD X Version 14.6.10 (7331)

**Ch40870/Hearing Aid Compatibility Test (101x101x1):** Interpolated grid: dx=0.5000 mm, dy=0.5000 mm

Device Reference Point: 0, 0, -6.3 mm

Reference Value = 6.092 V/m; Power Drift = -0.09 dB

Applied MIF = -1.62 dB

RF audio interference level = 14.07 dBV/m

**Emission category: M4**

MIF scaled E-field

<b>Grid 1 M4</b> <b>10.32 dBV/m</b>	<b>Grid 2 M4</b> <b>14.41 dBV/m</b>	<b>Grid 3 M4</b> <b>14.5 dBV/m</b>
<b>Grid 4 M4</b> <b>10.12 dBV/m</b>	<b>Grid 5 M4</b> <b>14.07 dBV/m</b>	<b>Grid 6 M4</b> <b>14.16 dBV/m</b>
<b>Grid 7 M4</b> <b>8.73 dBV/m</b>	<b>Grid 8 M4</b> <b>11.66 dBV/m</b>	<b>Grid 9 M4</b> <b>12.57 dBV/m</b>

**Cursor:**

Total = 14.50 dBV/m

E Category: M4

Location: -10.5, -14.5, 8.7 mm

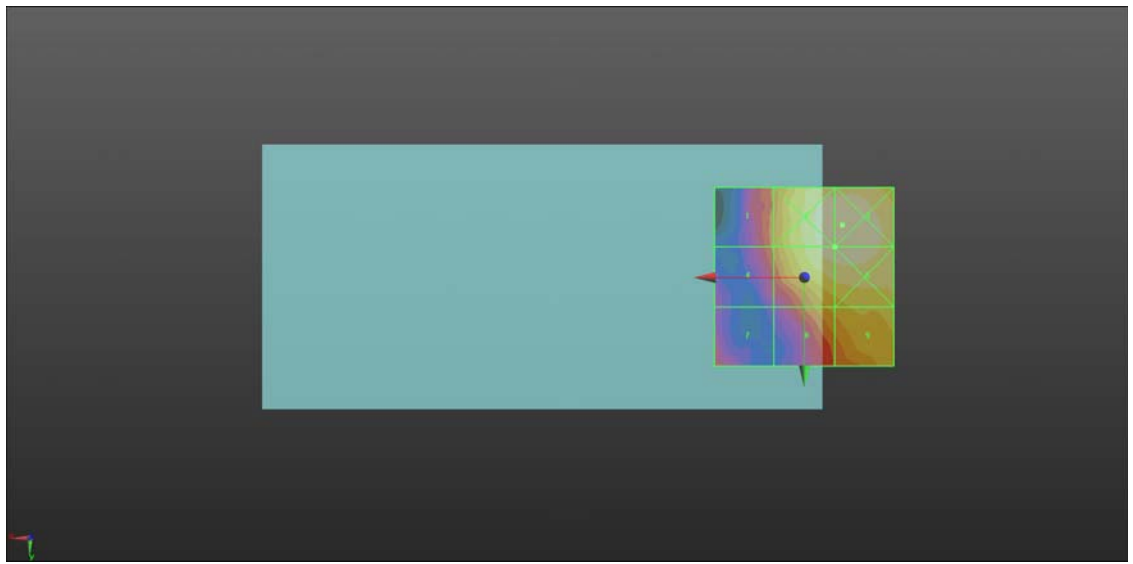
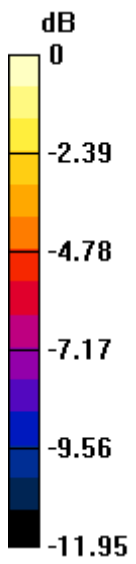

0 dB = 5.308 V/m = 14.50 dBV/m



**HAC RF\_LTE Band 41\_20M\_QPSK\_1RB\_99offset\_12.2Kbps\_Ch41140\_E**

Communication System: UID 10172 - CAB, LTE-TDD (SC-FDMA, 1 RB, 20 MHz, QPSK);  
 Frequency: 2645 MHz; Duty Cycle: 1:1.59

Medium: Air Medium parameters used:  $\sigma = 0$  S/m,  $\epsilon_r = 1$ ;  $\rho = 0$  kg/m<sup>3</sup>

Ambient Temperature : 23.2 °C

**DASY5 Configuration:**

- Probe: ER3DV6 - SN2434; ConvF(1, 1, 1); Calibrated: 2018.10.18;
- Sensor-Surface: (Fix Surface)
- Electronics: DAE4 Sn480; Calibrated: 2019.04.11
- Phantom: HAC Test Arch with AMCC; Type: SD HAC P01 BA;
- Measurement SW: DASY52, Version 52.8 (8); SEMCAD X Version 14.6.10 (7331)

**Ch41140/Hearing Aid Compatibility Test (101x101x1):** Interpolated grid: dx=0.5000 mm, dy=0.5000 mm

Device Reference Point: 0, 0, -6.3 mm

Reference Value = 8.711 V/m; Power Drift = -0.10 dB

Applied MIF = -1.62 dB

RF audio interference level = 15.74 dBV/m

**Emission category: M4**

MIF scaled E-field

<b>Grid 1 M4</b> <b>12.94 dBV/m</b>	<b>Grid 2 M4</b> <b>15.78 dBV/m</b>	<b>Grid 3 M4</b> <b>15.63 dBV/m</b>
<b>Grid 4 M4</b> <b>12.8 dBV/m</b>	<b>Grid 5 M4</b> <b>15.74 dBV/m</b>	<b>Grid 6 M4</b> <b>15.62 dBV/m</b>
<b>Grid 7 M4</b> <b>9.18 dBV/m</b>	<b>Grid 8 M4</b> <b>13.76 dBV/m</b>	<b>Grid 9 M4</b> <b>13.76 dBV/m</b>

**Cursor:**

Total = 15.78 dBV/m

E Category: M4

Location: -5.5, -10.5, 8.7 mm

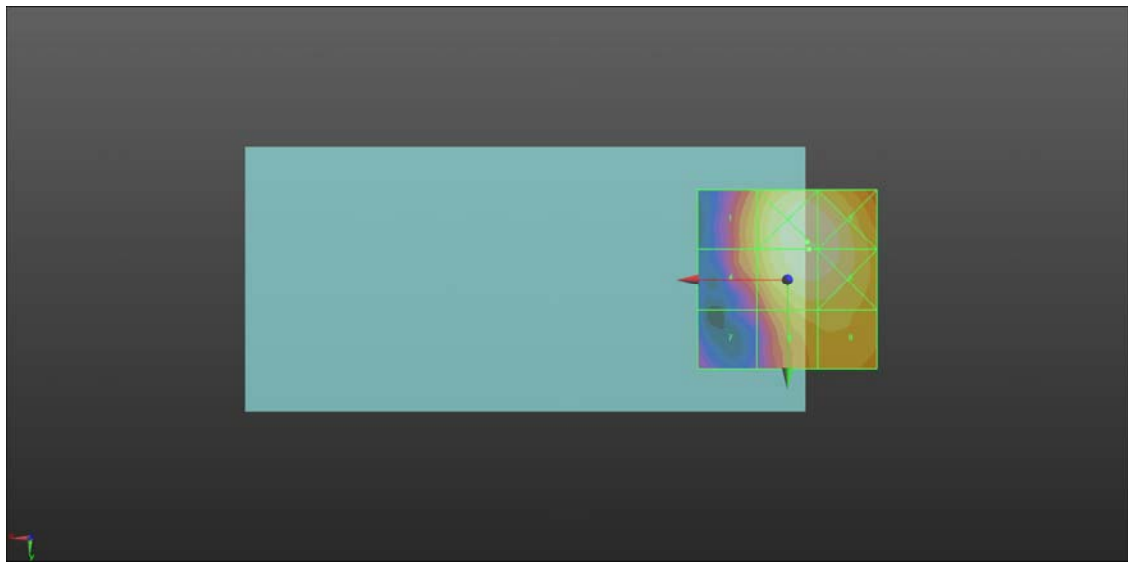
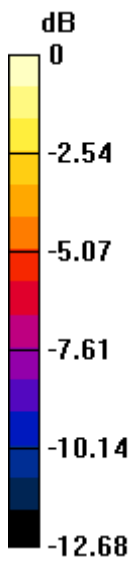

0 dB = 6.155 V/m = 15.78 dBV/m

### HAC RF\_GSM850\_GSM Voice\_Ch128\_E

Communication System: UID 10021 - DAB, GSM-FDD (TDMA, GMSK); Frequency: 824.2 MHz; Duty Cycle: 1:8.3

Medium: Air Medium parameters used:  $\sigma = 0$  S/m,  $\epsilon_r = 1$ ;  $\rho = 0$  kg/m<sup>3</sup>

Ambient Temperature : 23.2 °C

**DASY5 Configuration:**

- Probe: ER3DV6 - SN2434; ConvF(1, 1, 1); Calibrated: 2018.10.18;
- Sensor-Surface: (Fix Surface)
- Electronics: DAE4 Sn480; Calibrated: 2019.04.11
- Phantom: HAC Test Arch with AMCC; Type: SD HAC P01 BA;
- Measurement SW: DASY52, Version 52.8 (8); SEMCAD X Version 14.6.10 (7331)

**Ch128/Hearing Aid Compatibility Test (101x101x1):** Interpolated grid: dx=0.5000 mm, dy=0.5000 mm

Device Reference Point: 0, 0, -6.3 mm

Reference Value = 128.0 V/m; Power Drift = -0.02 dB

Applied MIF = 3.63 dB

RF audio interference level = 42.05 dBV/m

**Emission category: M3**

MIF scaled E-field

<b>Grid 1 M4</b> <b>33.69 dBV/m</b>	<b>Grid 2 M4</b> <b>38.03 dBV/m</b>	<b>Grid 3 M4</b> <b>37.88 dBV/m</b>
<b>Grid 4 M4</b> <b>38.85 dBV/m</b>	<b>Grid 5 M3</b> <b>42.05 dBV/m</b>	<b>Grid 6 M3</b> <b>40.68 dBV/m</b>
<b>Grid 7 M3</b> <b>40.13 dBV/m</b>	<b>Grid 8 M3</b> <b>42.86 dBV/m</b>	<b>Grid 9 M3</b> <b>41.06 dBV/m</b>

**Cursor:**

Total = 42.86 dBV/m

E Category: M3

Location: -1, 19, 8.7 mm

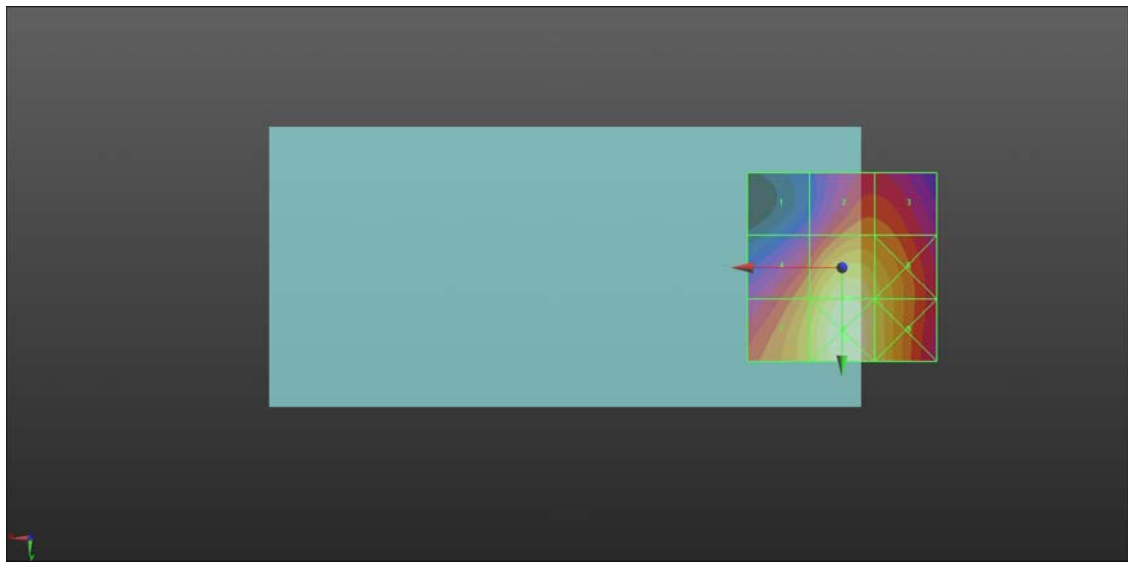
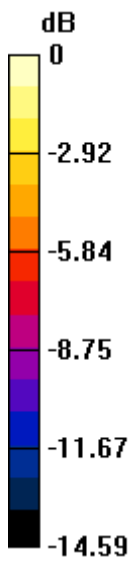

0 dB = 139.0 V/m = 42.86 dBV/m

### HAC RF\_GSM850\_GSM Voice\_Ch189\_E

Communication System: UID 10021 - DAB, GSM-FDD (TDMA, GMSK); Frequency: 836.6 MHz; Duty Cycle: 1:8.3

Medium: Air Medium parameters used:  $\sigma = 0$  S/m,  $\epsilon_r = 1$ ;  $\rho = 0$  kg/m<sup>3</sup>

Ambient Temperature : 23.2 °C

**DASY5 Configuration:**

- Probe: ER3DV6 - SN2434; ConvF(1, 1, 1); Calibrated: 2018.10.18;
- Sensor-Surface: (Fix Surface)
- Electronics: DAE4 Sn480; Calibrated: 2019.04.11
- Phantom: HAC Test Arch with AMCC; Type: SD HAC P01 BA;
- Measurement SW: DASY52, Version 52.8 (8); SEMCAD X Version 14.6.10 (7331)

**Ch189/Hearing Aid Compatibility Test (101x101x1):** Interpolated grid: dx=0.5000 mm, dy=0.5000 mm

Device Reference Point: 0, 0, -6.3 mm

Reference Value = 132.7 V/m; Power Drift = -0.02 dB

Applied MIF = 3.63 dB

RF audio interference level = 42.44 dBV/m

**Emission category: M3**

MIF scaled E-field

<b>Grid 1 M4</b> <b>33.87 dBV/m</b>	<b>Grid 2 M4</b> <b>38.35 dBV/m</b>	<b>Grid 3 M4</b> <b>38.25 dBV/m</b>
<b>Grid 4 M4</b> <b>39.23 dBV/m</b>	<b>Grid 5 M3</b> <b>42.44 dBV/m</b>	<b>Grid 6 M3</b> <b>41.09 dBV/m</b>
<b>Grid 7 M3</b> <b>40.59 dBV/m</b>	<b>Grid 8 M3</b> <b>43.31 dBV/m</b>	<b>Grid 9 M3</b> <b>41.51 dBV/m</b>

**Cursor:**

Total = 43.31 dBV/m

E Category: M3

Location: -1, 19.5, 8.7 mm

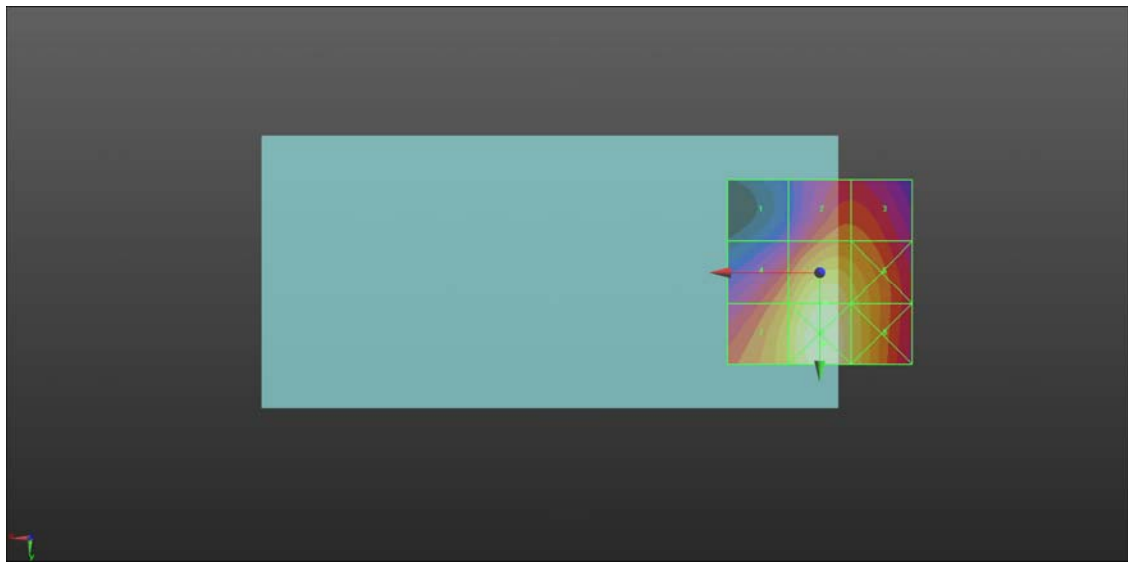
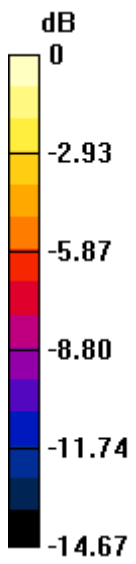

0 dB = 146.3 V/m = 43.30 dBV/m

### HAC RF\_GSM850\_GSM Voice\_Ch251\_E

Communication System: UID 10021 - DAB, GSM-FDD (TDMA, GMSK); Frequency: 848.6 MHz; Duty Cycle: 1:8.3

Medium: Air Medium parameters used:  $\sigma = 0$  S/m,  $\epsilon_r = 1$ ;  $\rho = 0$  kg/m<sup>3</sup>

Ambient Temperature : 23.2 °C

**DASY5 Configuration:**

- Probe: ER3DV6 - SN2434; ConvF(1, 1, 1); Calibrated: 2018.10.18;
- Sensor-Surface: (Fix Surface)
- Electronics: DAE4 Sn480; Calibrated: 2019.04.11
- Phantom: HAC Test Arch with AMCC; Type: SD HAC P01 BA;
- Measurement SW: DASY52, Version 52.8 (8); SEMCAD X Version 14.6.10 (7331)

**Ch251/Hearing Aid Compatibility Test (101x101x1):** Interpolated grid: dx=0.5000 mm, dy=0.5000 mm

Device Reference Point: 0, 0, -6.3 mm

Reference Value = 126.4 V/m; Power Drift = 0.04 dB

Applied MIF = 3.63 dB

RF audio interference level = 42.14 dBV/m

**Emission category: M3**

MIF scaled E-field

<b>Grid 1 M4</b> <b>33.38 dBV/m</b>	<b>Grid 2 M4</b> <b>38.19 dBV/m</b>	<b>Grid 3 M4</b> <b>38.08 dBV/m</b>
<b>Grid 4 M4</b> <b>38.82 dBV/m</b>	<b>Grid 5 M3</b> <b>42.14 dBV/m</b>	<b>Grid 6 M3</b> <b>40.92 dBV/m</b>
<b>Grid 7 M3</b> <b>40.31 dBV/m</b>	<b>Grid 8 M3</b> <b>43.07 dBV/m</b>	<b>Grid 9 M3</b> <b>41.36 dBV/m</b>

**Cursor:**

Total = 43.07 dBV/m

E Category: M3

Location: -1, 19.5, 8.7 mm

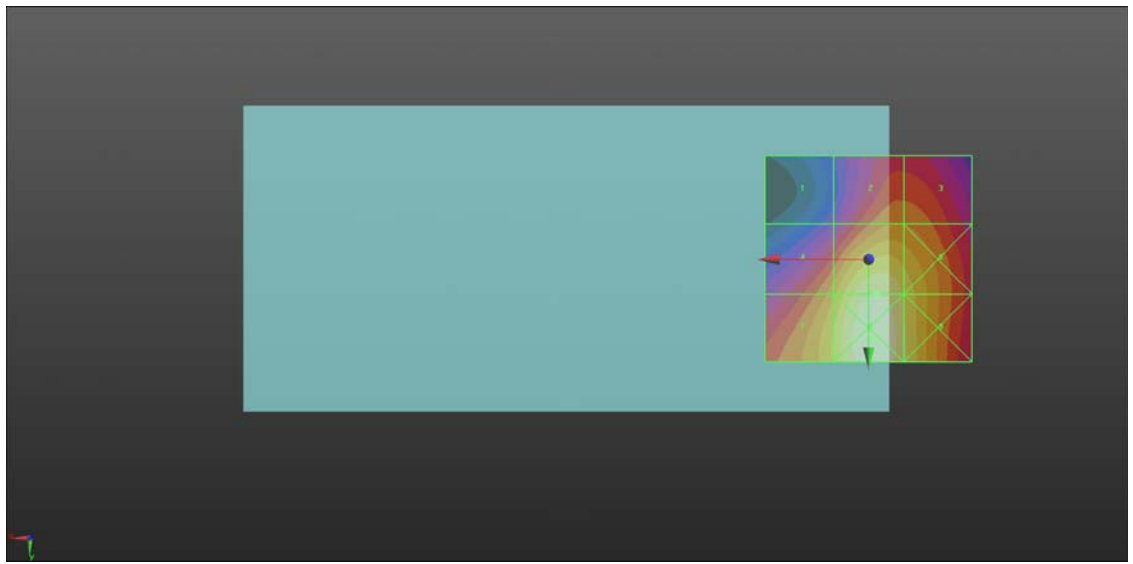
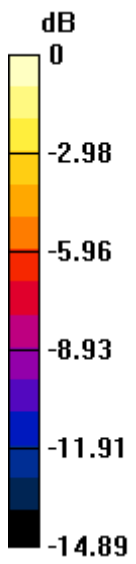

0 dB = 142.3 V/m = 43.07 dBV/m



### HAC RF\_GSM1900\_GSM Voice\_Ch512\_E

Communication System: UID 10021 - DAB, GSM-FDD (TDMA, GMSK); Frequency: 1850.2 MHz; Duty Cycle: 1:8.3

Medium: Air Medium parameters used:  $\sigma = 0$  S/m,  $\epsilon_r = 1$ ;  $\rho = 0$  kg/m<sup>3</sup>

Ambient Temperature : 23.2 °C

**DASY5 Configuration:**

- Probe: ER3DV6 - SN2434; ConvF(1, 1, 1); Calibrated: 2018.10.18;
- Sensor-Surface: (Fix Surface)
- Electronics: DAE4 Sn480; Calibrated: 2019.04.11
- Phantom: HAC Test Arch with AMCC; Type: SD HAC P01 BA;
- Measurement SW: DASY52, Version 52.8 (8); SEMCAD X Version 14.6.10 (7331)

**Ch512/Hearing Aid Compatibility Test (101x101x1):** Interpolated grid: dx=0.5000 mm, dy=0.5000 mm

Device Reference Point: 0, 0, -6.3 mm

Reference Value = 18.92 V/m; Power Drift = -0.03 dB

Applied MIF = 3.63 dB

RF audio interference level = 31.09 dBV/m

**Emission category: M3**

MIF scaled E-field

<b>Grid 1 M3</b> <b>30.84 dBV/m</b>	<b>Grid 2 M3</b> <b>33.94 dBV/m</b>	<b>Grid 3 M3</b> <b>33.16 dBV/m</b>
<b>Grid 4 M4</b> <b>27.96 dBV/m</b>	<b>Grid 5 M3</b> <b>31.09 dBV/m</b>	<b>Grid 6 M3</b> <b>30.93 dBV/m</b>
<b>Grid 7 M4</b> <b>27.68 dBV/m</b>	<b>Grid 8 M3</b> <b>30.29 dBV/m</b>	<b>Grid 9 M4</b> <b>29.81 dBV/m</b>

**Cursor:**

Total = 33.94 dBV/m

E Category: M3

Location: -2, -21, 8.7 mm

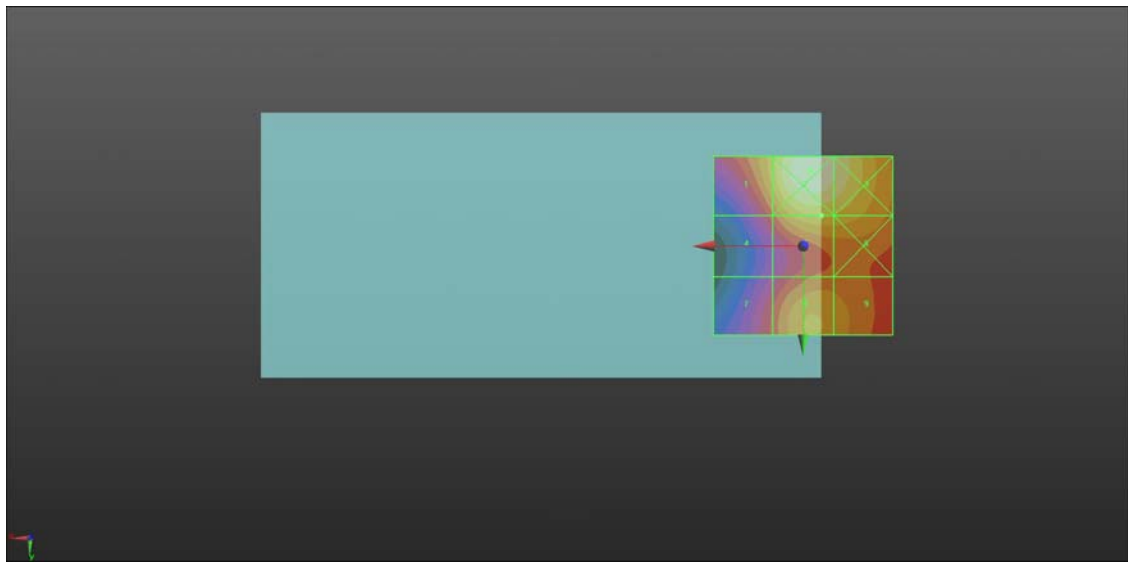
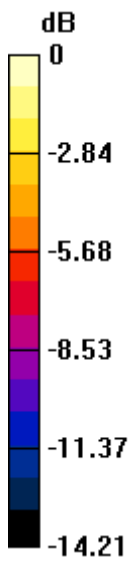

0 dB = 49.75 V/m = 33.94 dBV/m

## HAC RF\_GSM1900\_GSM Voice\_Ch661\_E

Communication System: UID 10021 - DAB, GSM-FDD (TDMA, GMSK); Frequency: 1880 MHz; Duty Cycle: 1:8.3

Medium: Air Medium parameters used:  $\sigma = 0$  S/m,  $\epsilon_r = 1$ ;  $\rho = 0$  kg/m<sup>3</sup>

Ambient Temperature : 23.2 °C

DASY5 Configuration:

- Probe: ER3DV6 - SN2434; ConvF(1, 1, 1); Calibrated: 2018.10.18;
- Sensor-Surface: (Fix Surface)
- Electronics: DAE4 Sn480; Calibrated: 2019.04.11
- Phantom: HAC Test Arch with AMCC; Type: SD HAC P01 BA;
- Measurement SW: DASY52, Version 52.8 (8); SEMCAD X Version 14.6.10 (7331)

**Ch661/Hearing Aid Compatibility Test (101x101x1):** Interpolated grid: dx=0.5000 mm, dy=0.5000 mm

Device Reference Point: 0, 0, -6.3 mm

Reference Value = 17.52 V/m; Power Drift = 0.18 dB

Applied MIF = 3.63 dB

RF audio interference level = 30.71 dBV/m

**Emission category: M3**

MIF scaled E-field

<b>Grid 1 M3</b> <b>30.4 dBV/m</b>	<b>Grid 2 M3</b> <b>33.54 dBV/m</b>	<b>Grid 3 M3</b> <b>32.77 dBV/m</b>
<b>Grid 4 M4</b> <b>27.44 dBV/m</b>	<b>Grid 5 M3</b> <b>30.71 dBV/m</b>	<b>Grid 6 M3</b> <b>30.55 dBV/m</b>
<b>Grid 7 M4</b> <b>27.14 dBV/m</b>	<b>Grid 8 M4</b> <b>29.82 dBV/m</b>	<b>Grid 9 M4</b> <b>29.61 dBV/m</b>

**Cursor:**

Total = 33.54 dBV/m

E Category: M3

Location: -2.5, -21.5, 8.7 mm

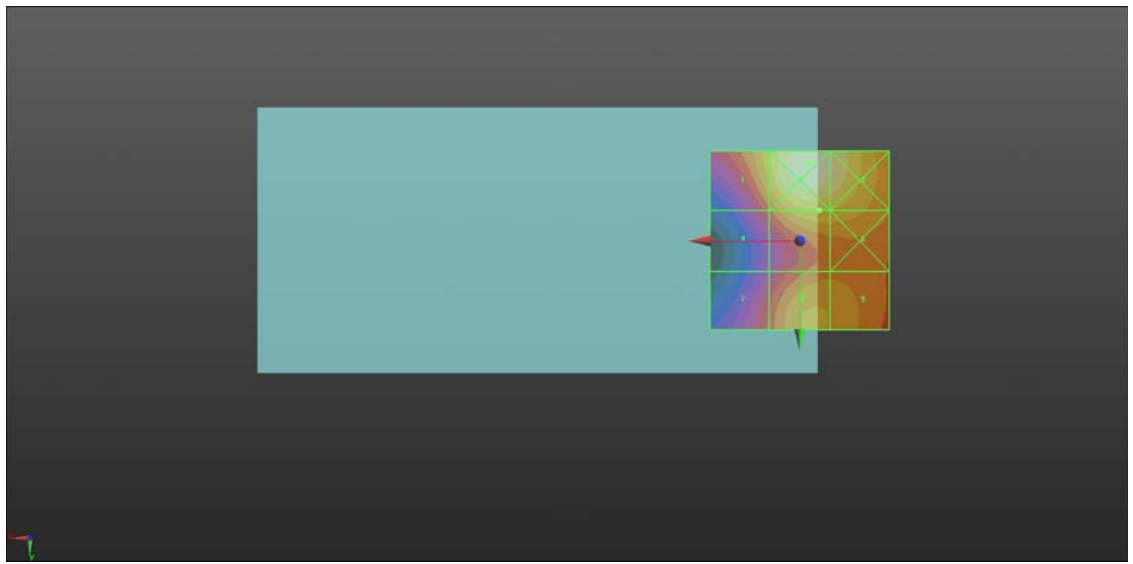
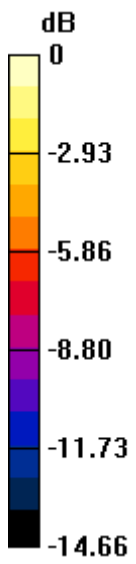

0 dB = 47.54 V/m = 33.54 dBV/m

## HAC RF\_GSM1900\_GSM Voice\_Ch810\_E

Communication System: UID 10021 - DAB, GSM-FDD (TDMA, GMSK); Frequency: 1909.8 MHz; Duty Cycle: 1:8.3

Medium: Air Medium parameters used:  $\sigma = 0$  S/m,  $\epsilon_r = 1$ ;  $\rho = 0$  kg/m<sup>3</sup>

Ambient Temperature : 23.2 °C

DASY5 Configuration:

- Probe: ER3DV6 - SN2434; ConvF(1, 1, 1); Calibrated: 2018.10.18;
- Sensor-Surface: (Fix Surface)
- Electronics: DAE4 Sn480; Calibrated: 2019.04.11
- Phantom: HAC Test Arch with AMCC; Type: SD HAC P01 BA;
- Measurement SW: DASY52, Version 52.8 (8); SEMCAD X Version 14.6.10 (7331)

**Ch810/Hearing Aid Compatibility Test (101x101x1):** Interpolated grid: dx=0.5000 mm, dy=0.5000 mm

Device Reference Point: 0, 0, -6.3 mm

Reference Value = 18.58 V/m; Power Drift = -0.09 dB

Applied MIF = 3.63 dB

RF audio interference level = 30.72 dBV/m

**Emission category: M3**

MIF scaled E-field

<b>Grid 1 M3</b> <b>30.41 dBV/m</b>	<b>Grid 2 M3</b> <b>33.53 dBV/m</b>	<b>Grid 3 M3</b> <b>32.83 dBV/m</b>
<b>Grid 4 M4</b> <b>27.38 dBV/m</b>	<b>Grid 5 M3</b> <b>30.72 dBV/m</b>	<b>Grid 6 M3</b> <b>30.66 dBV/m</b>
<b>Grid 7 M4</b> <b>27.37 dBV/m</b>	<b>Grid 8 M3</b> <b>30.13 dBV/m</b>	<b>Grid 9 M4</b> <b>29.98 dBV/m</b>

**Cursor:**

Total = 33.53 dBV/m

E Category: M3

Location: -2.5, -21.5, 8.7 mm

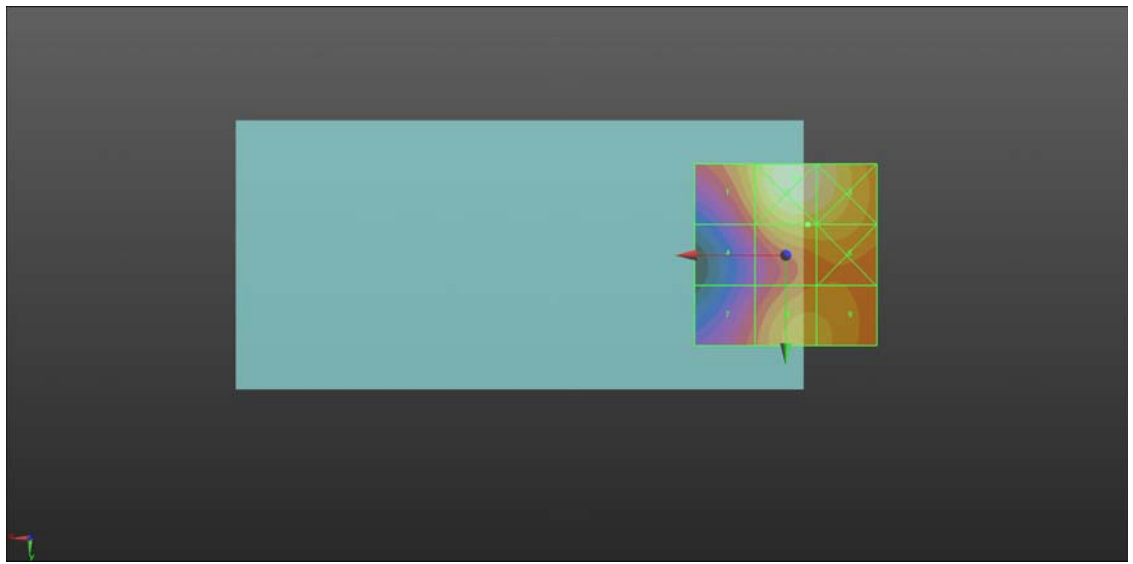
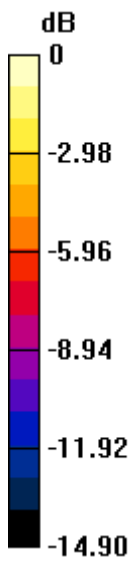

0 dB = 47.47 V/m = 33.53 dBV/m

**HAC RF\_CDMA2000 BC1\_RC1 SO3\_Ch25\_E**

Communication System: UID 10295 - AAB, CDMA2000, RC1, SO3, 1/8th Rate 25 fr.; Frequency: 1851.25 MHz; Duty Cycle: 1:1

Medium: Air Medium parameters used:  $\sigma = 0$  S/m,  $\epsilon_r = 1$ ;  $\rho = 0$  kg/m<sup>3</sup>

Ambient Temperature : 23.2 °C

**DASY5 Configuration:**

- Probe: ER3DV6 - SN2434; ConvF(1, 1, 1); Calibrated: 2018.10.18;
- Sensor-Surface: (Fix Surface)
- Electronics: DAE4 Sn480; Calibrated: 2019.04.11
- Phantom: HAC Test Arch with AMCC; Type: SD HAC P01 BA;
- Measurement SW: DASY52, Version 52.8 (8); SEMCAD X Version 14.6.10 (7331)

**Ch25/Hearing Aid Compatibility Test (101x101x1):** Interpolated grid: dx=0.5000 mm, dy=0.5000 mm

Device Reference Point: 0, 0, -6.3 mm

Reference Value = 2.609 V/m; Power Drift = -0.07 dB

Applied MIF = 3.26 dB

RF audio interference level = 11.32 dBV/m

**Emission category: M4**

MIF scaled E-field

<b>Grid 1 M4</b> <b>10.95 dBV/m</b>	<b>Grid 2 M4</b> <b>12.1 dBV/m</b>	<b>Grid 3 M4</b> <b>11.67 dBV/m</b>
<b>Grid 4 M4</b> <b>10.57 dBV/m</b>	<b>Grid 5 M4</b> <b>11.32 dBV/m</b>	<b>Grid 6 M4</b> <b>11.13 dBV/m</b>
<b>Grid 7 M4</b> <b>10.54 dBV/m</b>	<b>Grid 8 M4</b> <b>10.87 dBV/m</b>	<b>Grid 9 M4</b> <b>11.25 dBV/m</b>

**Cursor:**

Total = 12.10 dBV/m

E Category: M4

Location: -0.5, -20, 8.7 mm

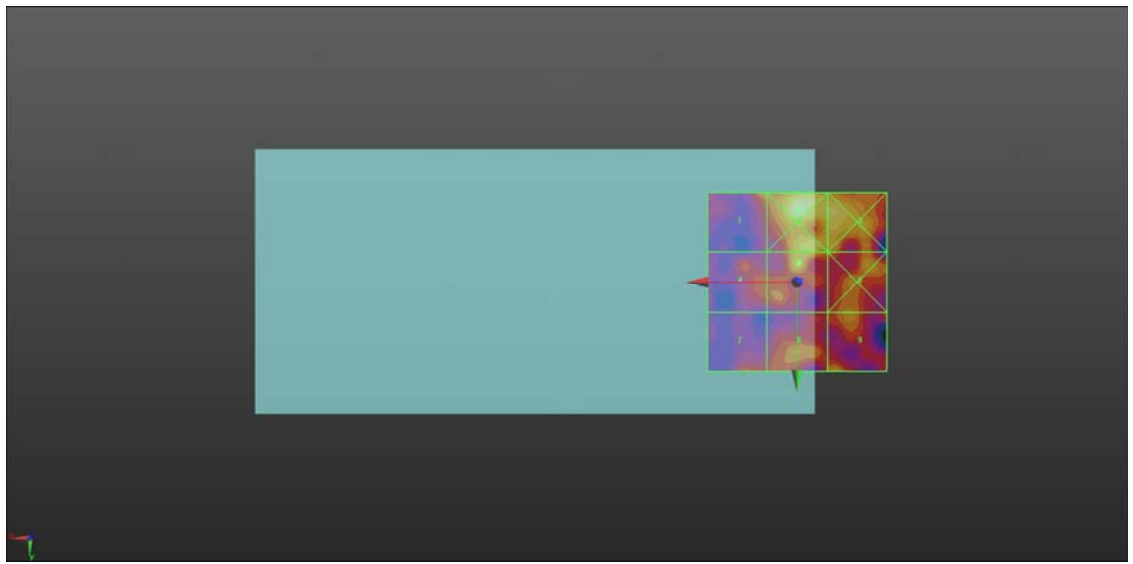
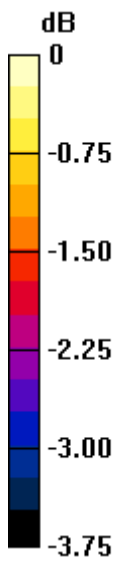

0 dB = 4.025 V/m = 12.10 dBV/m



**HAC RF\_CDMA2000 BC1\_RC1 SO3\_Ch600\_E**

Communication System: UID 10295 - AAB, CDMA2000, RC1, SO3, 1/8th Rate 25 fr.; Frequency: 1880 MHz; Duty Cycle: 1:1

Medium: Air Medium parameters used:  $\sigma = 0$  S/m,  $\epsilon_r = 1$ ;  $\rho = 0$  kg/m<sup>3</sup>

Ambient Temperature : 23.2 °C

**DASY5 Configuration:**

- Probe: ER3DV6 - SN2434; ConvF(1, 1, 1); Calibrated: 2018.10.18;
- Sensor-Surface: (Fix Surface)
- Electronics: DAE4 Sn480; Calibrated: 2019.04.11
- Phantom: HAC Test Arch with AMCC; Type: SD HAC P01 BA;
- Measurement SW: DASY52, Version 52.8 (8); SEMCAD X Version 14.6.10 (7331)

**Ch600/Hearing Aid Compatibility Test (101x101x1):** Interpolated grid: dx=0.5000 mm, dy=0.5000 mm

Device Reference Point: 0, 0, -6.3 mm

Reference Value = 2.668 V/m; Power Drift = -0.06 dB

Applied MIF = 3.26 dB

RF audio interference level = 10.94 dBV/m

**Emission category: M4**

MIF scaled E-field

<b>Grid 1 M4</b> <b>11.38 dBV/m</b>	<b>Grid 2 M4</b> <b>11.88 dBV/m</b>	<b>Grid 3 M4</b> <b>10.47 dBV/m</b>
<b>Grid 4 M4</b> <b>11.32 dBV/m</b>	<b>Grid 5 M4</b> <b>10.94 dBV/m</b>	<b>Grid 6 M4</b> <b>10.1 dBV/m</b>
<b>Grid 7 M4</b> <b>10.88 dBV/m</b>	<b>Grid 8 M4</b> <b>10.78 dBV/m</b>	<b>Grid 9 M4</b> <b>9.99 dBV/m</b>

**Cursor:**

Total = 11.88 dBV/m

E Category: M4

Location: -4, -25, 8.7 mm

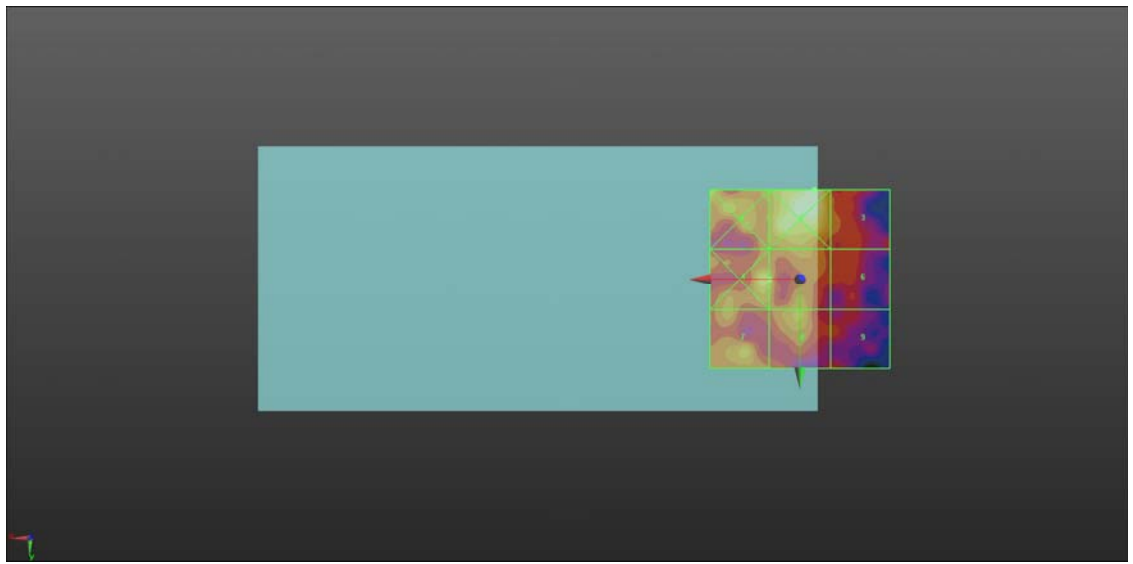
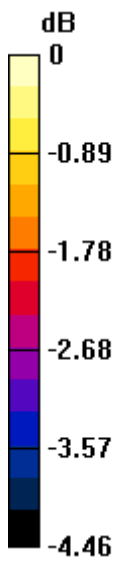

0 dB = 3.926 V/m = 11.88 dBV/m

**HAC RF\_CDMA2000 BC1\_RC1 SO3\_Ch1175\_E**

Communication System: UID 10295 - AAB, CDMA2000, RC1, SO3, 1/8th Rate 25 fr.; Frequency: 1909.95 MHz; Duty Cycle: 1:1

Medium: Air Medium parameters used:  $\sigma = 0$  S/m,  $\epsilon_r = 1$ ;  $\rho = 0$  kg/m<sup>3</sup>

Ambient Temperature : 23.2 °C

**DASY5 Configuration:**

- Probe: ER3DV6 - SN2434; ConvF(1, 1, 1); Calibrated: 2018.10.18;
- Sensor-Surface: (Fix Surface)
- Electronics: DAE4 Sn480; Calibrated: 2019.04.11
- Phantom: HAC Test Arch with AMCC; Type: SD HAC P01 BA;
- Measurement SW: DASY52, Version 52.8 (8); SEMCAD X Version 14.6.10 (7331)

**Ch1175/Hearing Aid Compatibility Test (101x101x1):** Interpolated grid: dx=0.5000 mm, dy=0.5000 mm

Device Reference Point: 0, 0, -6.3 mm

Reference Value = 2.397 V/m; Power Drift = 0.18 dB

Applied MIF = 3.26 dB

RF audio interference level = 11.25 dBV/m

**Emission category: M4**

MIF scaled E-field

<b>Grid 1 M4</b> <b>10.92 dBV/m</b>	<b>Grid 2 M4</b> <b>11.59 dBV/m</b>	<b>Grid 3 M4</b> <b>11.28 dBV/m</b>
<b>Grid 4 M4</b> <b>10.61 dBV/m</b>	<b>Grid 5 M4</b> <b>11.25 dBV/m</b>	<b>Grid 6 M4</b> <b>10.54 dBV/m</b>
<b>Grid 7 M4</b> <b>10.57 dBV/m</b>	<b>Grid 8 M4</b> <b>11.14 dBV/m</b>	<b>Grid 9 M4</b> <b>10.75 dBV/m</b>

**Cursor:**

Total = 11.59 dBV/m

E Category: M4

Location: 4, -15, 8.7 mm

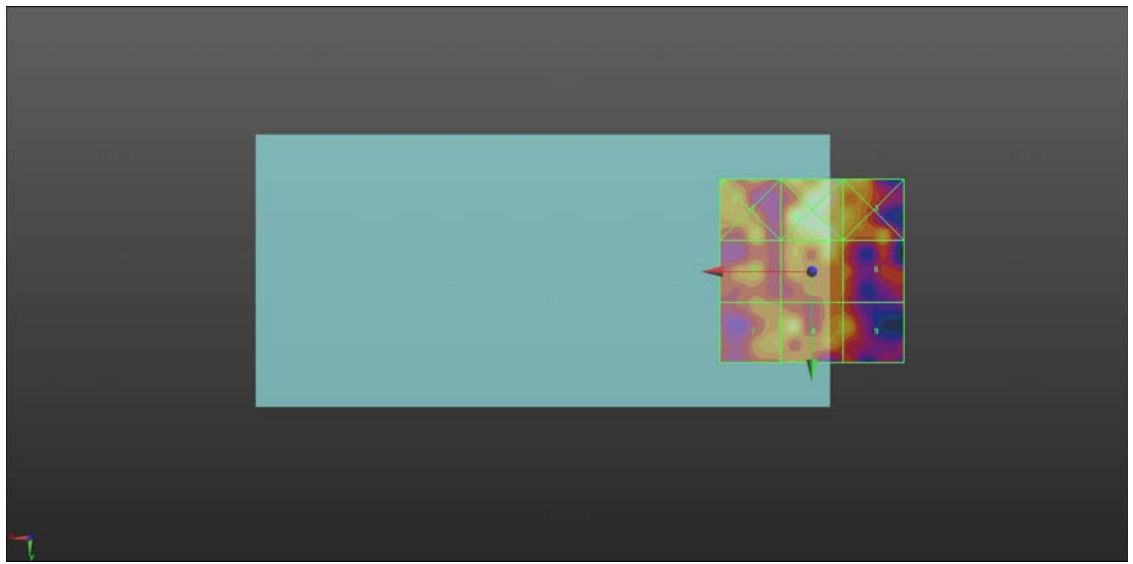
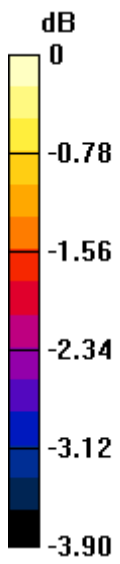

0 dB = 3.800 V/m = 11.60 dBV/m

**HAC RF\_LTE Band 38\_20M\_QPSK\_1RB\_0offset\_12.2Kbps\_Ch37850\_E**

Communication System: UID 10173 - CAB, LTE-TDD (SC-FDMA, 1 RB, 20 MHz, 16-QAM);  
 Frequency: 2580 MHz; Duty Cycle: 1:1.59

Medium: Air Medium parameters used:  $\sigma = 0$  S/m,  $\epsilon_r = 1$ ;  $\rho = 0$  kg/m<sup>3</sup>

Ambient Temperature : 23.2 °C

**DASY5 Configuration:**

- Probe: ER3DV6 - SN2434; ConvF(1, 1, 1); Calibrated: 2018.10.18;
- Sensor-Surface: (Fix Surface)
- Electronics: DAE4 Sn480; Calibrated: 2019.04.11
- Phantom: HAC Test Arch with AMCC; Type: SD HAC P01 BA;
- Measurement SW: DASY52, Version 52.8 (8); SEMCAD X Version 14.6.10 (7331)

**Ch37850/Hearing Aid Compatibility Test (101x101x1):** Interpolated grid: dx=0.5000 mm, dy=0.5000 mm

Device Reference Point: 0, 0, -6.3 mm

Reference Value = 18.47 V/m; Power Drift = -0.07 dB

Applied MIF = -1.44 dB

RF audio interference level = 24.33 dBV/m

**Emission category: M4**

MIF scaled E-field

<b>Grid 1 M4</b> <b>21.4 dBV/m</b>	<b>Grid 2 M4</b> <b>25.64 dBV/m</b>	<b>Grid 3 M4</b> <b>25.31 dBV/m</b>
<b>Grid 4 M4</b> <b>20.66 dBV/m</b>	<b>Grid 5 M4</b> <b>24.33 dBV/m</b>	<b>Grid 6 M4</b> <b>24.35 dBV/m</b>
<b>Grid 7 M4</b> <b>21.23 dBV/m</b>	<b>Grid 8 M4</b> <b>23.46 dBV/m</b>	<b>Grid 9 M4</b> <b>23.47 dBV/m</b>

**Cursor:**

Total = 25.64 dBV/m

E Category: M4

Location: -5.5, -19.5, 8.7 mm

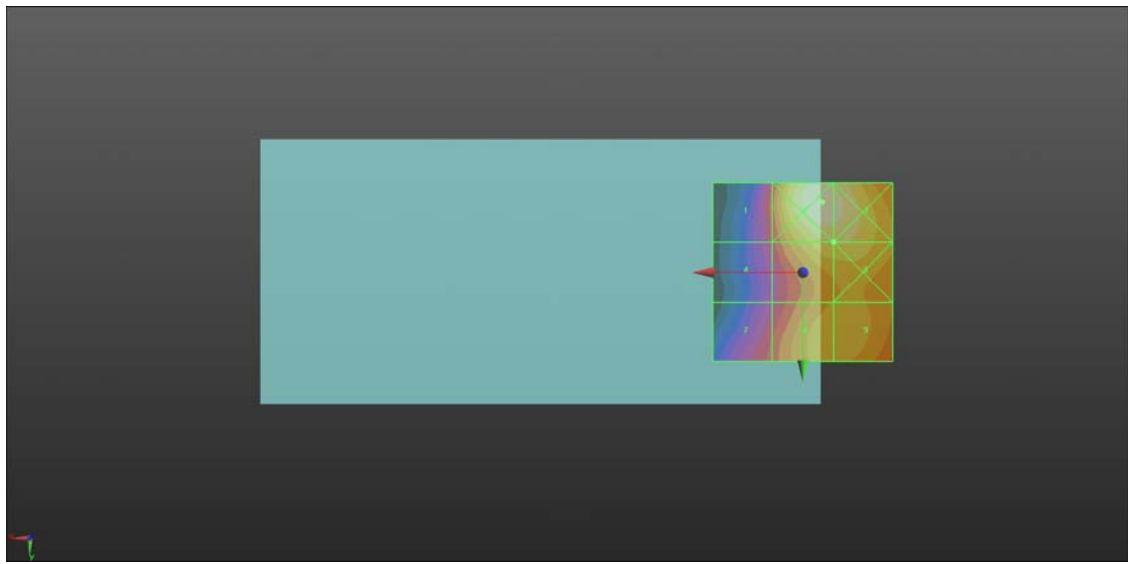
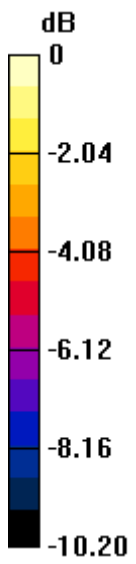

0 dB = 19.13 V/m = 25.63 dBV/m

**HAC RF\_LTE Band 38\_20M\_QPSK\_1RB\_0offset\_12.2Kbps\_Ch38000\_E**

Communication System: UID 10172 - CAB, LTE-TDD (SC-FDMA, 1 RB, 20 MHz, QPSK);  
 Frequency: 2595 MHz; Duty Cycle: 1:1.59

Medium: Air Medium parameters used:  $\sigma = 0$  S/m,  $\epsilon_r = 1$ ;  $\rho = 0$  kg/m<sup>3</sup>

Ambient Temperature : 23.2 °C

**DASY5 Configuration:**

- Probe: ER3DV6 - SN2434; ConvF(1, 1, 1); Calibrated: 2018.10.18;
- Sensor-Surface: (Fix Surface)
- Electronics: DAE4 Sn480; Calibrated: 2019.04.11
- Phantom: HAC Test Arch with AMCC; Type: SD HAC P01 BA;
- Measurement SW: DASY52, Version 52.8 (8); SEMCAD X Version 14.6.10 (7331)

**Ch38000/Hearing Aid Compatibility Test (101x101x1):** Interpolated grid: dx=0.5000 mm, dy=0.5000 mm

Device Reference Point: 0, 0, -6.3 mm

Reference Value = 18.76 V/m; Power Drift = -0.11 dB

Applied MIF = -1.62 dB

RF audio interference level = 24.23 dBV/m

**Emission category: M4**

MIF scaled E-field

<b>Grid 1 M4</b> <b>21.23 dBV/m</b>	<b>Grid 2 M4</b> <b>25.38 dBV/m</b>	<b>Grid 3 M4</b> <b>25.1 dBV/m</b>
<b>Grid 4 M4</b> <b>20.75 dBV/m</b>	<b>Grid 5 M4</b> <b>24.23 dBV/m</b>	<b>Grid 6 M4</b> <b>24.24 dBV/m</b>
<b>Grid 7 M4</b> <b>21.08 dBV/m</b>	<b>Grid 8 M4</b> <b>23.15 dBV/m</b>	<b>Grid 9 M4</b> <b>23.15 dBV/m</b>

**Cursor:**

Total = 25.38 dBV/m

E Category: M4

Location: -5.5, -19.5, 8.7 mm

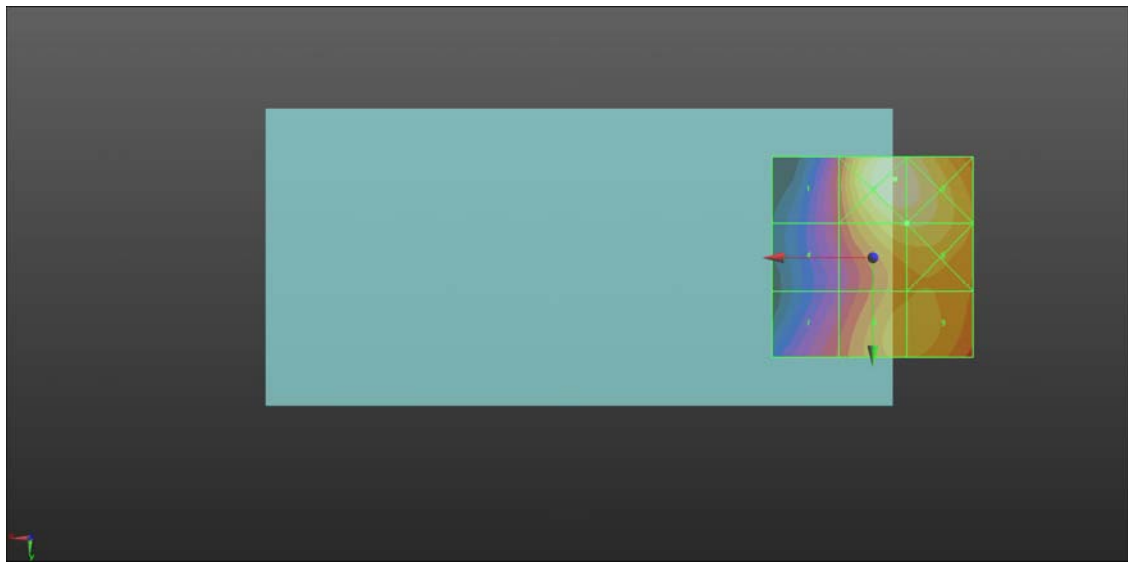
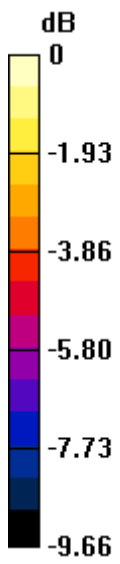

0 dB = 18.58 V/m = 25.38 dBV/m



**HAC RF\_LTE Band 38\_20M\_QPSK\_1RB\_0offset\_12.2Kbps\_Ch38150\_E**

Communication System: UID 10103 - CAB, LTE-TDD (SC-FDMA, 100% RB, 20 MHz, QPSK);  
 Frequency: 2619.9 MHz; Duty Cycle: 1:1.59

Medium: Air Medium parameters used:  $\sigma = 0$  S/m,  $\epsilon_r = 1$ ;  $\rho = 0$  kg/m<sup>3</sup>

Ambient Temperature : 23.2 °C

**DASY5 Configuration:**

- Probe: ER3DV6 - SN2434; ConvF(1, 1, 1); Calibrated: 2018.10.18;
- Sensor-Surface: (Fix Surface)
- Electronics: DAE4 Sn480; Calibrated: 2019.04.11
- Phantom: HAC Test Arch with AMCC; Type: SD HAC P01 BA;
- Measurement SW: DASY52, Version 52.8 (8); SEMCAD X Version 14.6.10 (7331)

**Ch38150/Hearing Aid Compatibility Test (101x101x1):** Interpolated grid: dx=0.5000 mm, dy=0.5000 mm

Device Reference Point: 0, 0, -6.3 mm

Reference Value = 18.97 V/m; Power Drift = -0.05 dB

Applied MIF = -1.64 dB

RF audio interference level = 24.21 dBV/m

**Emission category: M4**

MIF scaled E-field

<b>Grid 1 M4</b> <b>21.03 dBV/m</b>	<b>Grid 2 M4</b> <b>25.24 dBV/m</b>	<b>Grid 3 M4</b> <b>24.95 dBV/m</b>
<b>Grid 4 M4</b> <b>20.64 dBV/m</b>	<b>Grid 5 M4</b> <b>24.21 dBV/m</b>	<b>Grid 6 M4</b> <b>24.22 dBV/m</b>
<b>Grid 7 M4</b> <b>21.19 dBV/m</b>	<b>Grid 8 M4</b> <b>23.15 dBV/m</b>	<b>Grid 9 M4</b> <b>23.15 dBV/m</b>

**Cursor:**

Total = 25.24 dBV/m

E Category: M4

Location: -5.5, -19.5, 8.7 mm

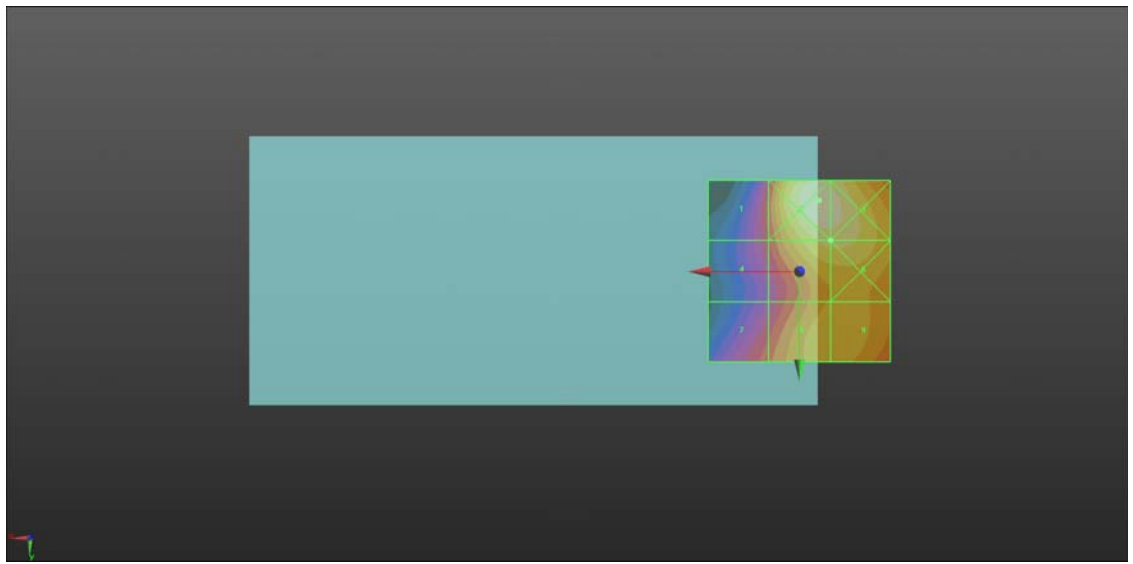
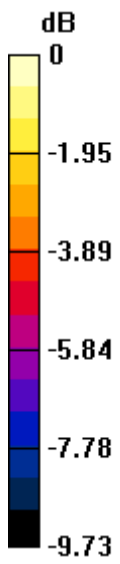

0 dB = 18.27 V/m = 25.23 dBV/m

**HAC RF\_LTE Band 40A\_10M\_QPSK\_1RB\_0offset\_12.2Kbps\_Ch38750\_E**

Communication System: UID 10237 - CAB, LTE-TDD (SC-FDMA, 1 RB, 10 MHz, QPSK);  
 Frequency: 2310 MHz; Duty Cycle: 1:1.59

Medium: Air Medium parameters used:  $\sigma = 0$  S/m,  $\epsilon_r = 1$ ;  $\rho = 0$  kg/m<sup>3</sup>

Ambient Temperature : 23.2 °C

**DASY5 Configuration:**

- Probe: ER3DV6 - SN2434; ConvF(1, 1, 1); Calibrated: 2018.10.18;
- Sensor-Surface: (Fix Surface)
- Electronics: DAE4 Sn480; Calibrated: 2019.04.11
- Phantom: HAC Test Arch with AMCC; Type: SD HAC P01 BA;
- Measurement SW: DASY52, Version 52.8 (8); SEMCAD X Version 14.6.10 (7331)

**Ch38750/Hearing Aid Compatibility Test (101x101x1):** Interpolated grid: dx=0.5000 mm, dy=0.5000 mm

Device Reference Point: 0, 0, -6.3 mm

Reference Value = 29.77 V/m; Power Drift = -0.06 dB

Applied MIF = -1.62 dB

RF audio interference level = 27.65 dBV/m

**Emission category: M4**

MIF scaled E-field

<b>Grid 1 M4</b> <b>25.13 dBV/m</b>	<b>Grid 2 M4</b> <b>29.43 dBV/m</b>	<b>Grid 3 M4</b> <b>28.96 dBV/m</b>
<b>Grid 4 M4</b> <b>24.01 dBV/m</b>	<b>Grid 5 M4</b> <b>27.65 dBV/m</b>	<b>Grid 6 M4</b> <b>27.61 dBV/m</b>
<b>Grid 7 M4</b> <b>23.3 dBV/m</b>	<b>Grid 8 M4</b> <b>26.42 dBV/m</b>	<b>Grid 9 M4</b> <b>26.41 dBV/m</b>

**Cursor:**

Total = 29.43 dBV/m

E Category: M4

Location: -4.5, -20, 8.7 mm

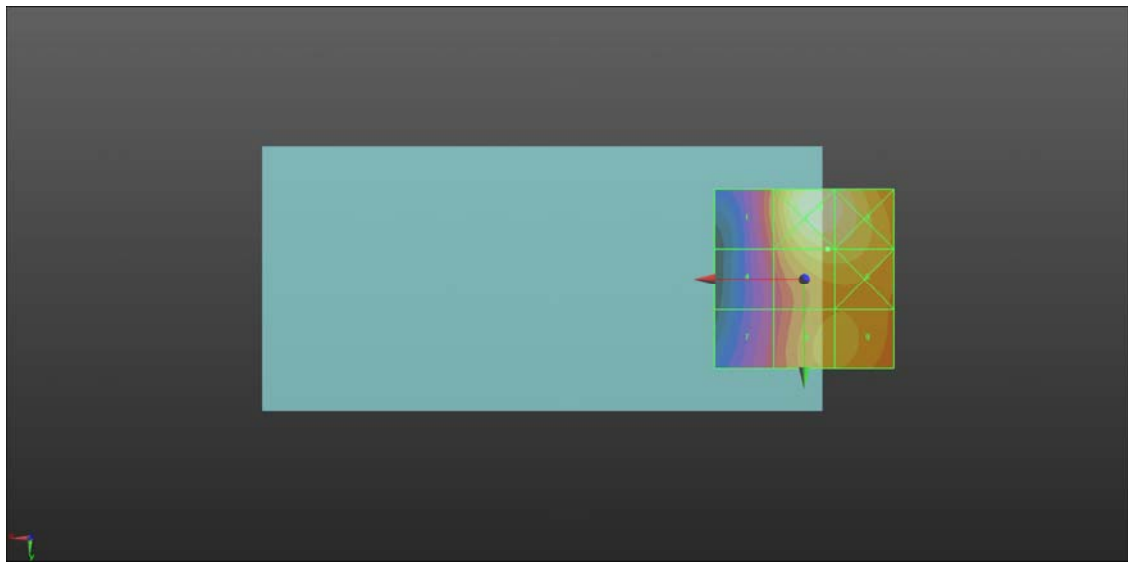
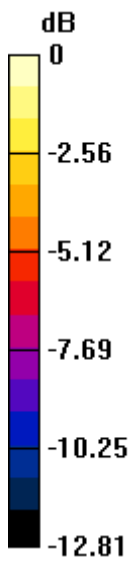

0 dB = 29.63 V/m = 29.43 dBV/m

**HAC RF\_LTE Band 40B\_10M\_QPSK\_1RB\_25offset\_12.2Kbps\_Ch39200\_E**

Communication System: UID 10237 - CAB, LTE-TDD (SC-FDMA, 1 RB, 10 MHz, QPSK);  
 Frequency: 2355 MHz; Duty Cycle: 1:1.59

Medium: Air Medium parameters used:  $\sigma = 0$  S/m,  $\epsilon_r = 1$ ;  $\rho = 0$  kg/m<sup>3</sup>

Ambient Temperature : 23.2 °C

**DASY5 Configuration:**

- Probe: ER3DV6 - SN2434; ConvF(1, 1, 1); Calibrated: 2018.10.18;
- Sensor-Surface: (Fix Surface)
- Electronics: DAE4 Sn480; Calibrated: 2019.04.11
- Phantom: HAC Test Arch with AMCC; Type: SD HAC P01 BA;
- Measurement SW: DASY52, Version 52.8 (8); SEMCAD X Version 14.6.10 (7331)

**Ch39200/Hearing Aid Compatibility Test (101x101x1):** Interpolated grid: dx=0.5000 mm, dy=0.5000 mm

Device Reference Point: 0, 0, -6.3 mm

Reference Value = 27.91 V/m; Power Drift = -0.06 dB

Applied MIF = -1.62 dB

RF audio interference level = 27.16 dBV/m

**Emission category: M4**

MIF scaled E-field

<b>Grid 1 M4</b> <b>24.52 dBV/m</b>	<b>Grid 2 M4</b> <b>28.91 dBV/m</b>	<b>Grid 3 M4</b> <b>28.47 dBV/m</b>
<b>Grid 4 M4</b> <b>23.5 dBV/m</b>	<b>Grid 5 M4</b> <b>27.16 dBV/m</b>	<b>Grid 6 M4</b> <b>27.13 dBV/m</b>
<b>Grid 7 M4</b> <b>22.74 dBV/m</b>	<b>Grid 8 M4</b> <b>25.78 dBV/m</b>	<b>Grid 9 M4</b> <b>25.78 dBV/m</b>

**Cursor:**

Total = 28.91 dBV/m

E Category: M4

Location: -5, -20, 8.7 mm

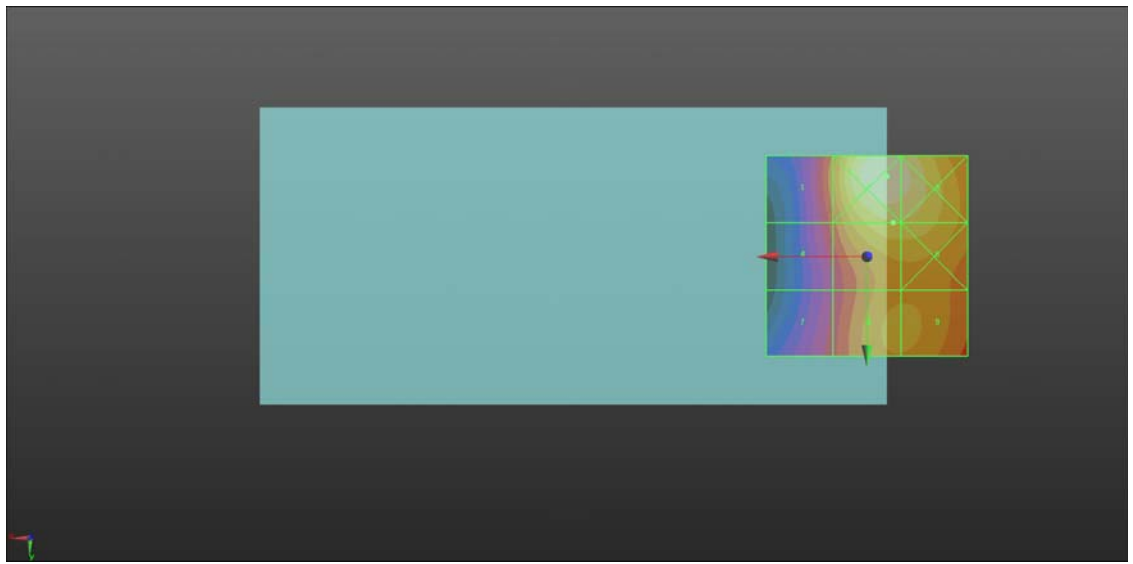
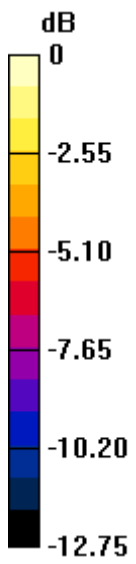

0 dB = 27.91 V/m = 28.92 dBV/m

**HAC RF\_LTE Band 41\_20M\_QPSK\_1RB\_99offset\_12.2Kbps\_Ch40340\_E**

Communication System: UID 10172 - CAB, LTE-TDD (SC-FDMA, 1 RB, 20 MHz, QPSK);  
 Frequency: 2565 MHz; Duty Cycle: 1:1.59

Medium: Air Medium parameters used:  $\sigma = 0$  S/m,  $\epsilon_r = 1$ ;  $\rho = 0$  kg/m<sup>3</sup>

Ambient Temperature : 23.2 °C

**DASY5 Configuration:**

- Probe: ER3DV6 - SN2434; ConvF(1, 1, 1); Calibrated: 2018.10.18;
- Sensor-Surface: (Fix Surface)
- Electronics: DAE4 Sn480; Calibrated: 2019.04.11
- Phantom: HAC Test Arch with AMCC; Type: SD HAC P01 BA;
- Measurement SW: DASY52, Version 52.8 (8); SEMCAD X Version 14.6.10 (7331)

**Ch40340/Hearing Aid Compatibility Test (101x101x1):** Interpolated grid: dx=0.5000 mm, dy=0.5000 mm

Device Reference Point: 0, 0, -6.3 mm

Reference Value = 19.24 V/m; Power Drift = -0.07 dB

Applied MIF = -1.62 dB

RF audio interference level = 24.21 dBV/m

**Emission category: M4**

MIF scaled E-field

<b>Grid 1 M4</b> <b>21.26 dBV/m</b>	<b>Grid 2 M4</b> <b>25.6 dBV/m</b>	<b>Grid 3 M4</b> <b>25.26 dBV/m</b>
<b>Grid 4 M4</b> <b>20.5 dBV/m</b>	<b>Grid 5 M4</b> <b>24.21 dBV/m</b>	<b>Grid 6 M4</b> <b>24.23 dBV/m</b>
<b>Grid 7 M4</b> <b>21.29 dBV/m</b>	<b>Grid 8 M4</b> <b>23.6 dBV/m</b>	<b>Grid 9 M4</b> <b>23.6 dBV/m</b>

**Cursor:**

Total = 25.60 dBV/m

E Category: M4

Location: -5.5, -20, 8.7 mm

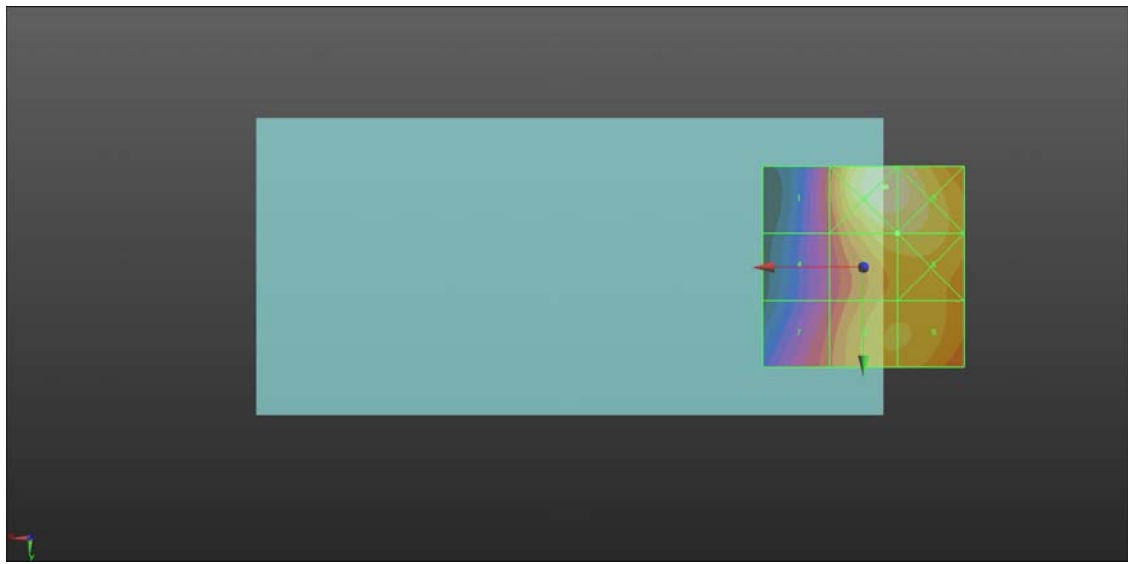
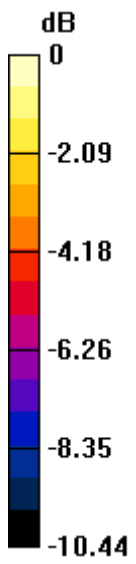

0 dB = 19.05 V/m = 25.60 dBV/m



**HAC RF\_LTE Band 41\_20M\_QPSK\_1RB\_99offset\_12.2Kbps\_Ch40600\_E**

Communication System: UID 10172 - CAB, LTE-TDD (SC-FDMA, 1 RB, 20 MHz, QPSK);  
 Frequency: 2591 MHz; Duty Cycle: 1:1.59

Medium: Air Medium parameters used:  $\sigma = 0$  S/m,  $\epsilon_r = 1$ ;  $\rho = 0$  kg/m<sup>3</sup>

Ambient Temperature : 23.2 °C

**DASY5 Configuration:**

- Probe: ER3DV6 - SN2434; ConvF(1, 1, 1); Calibrated: 2018.10.18;
- Sensor-Surface: (Fix Surface)
- Electronics: DAE4 Sn480; Calibrated: 2019.04.11
- Phantom: HAC Test Arch with AMCC; Type: SD HAC P01 BA;
- Measurement SW: DASY52, Version 52.8 (8); SEMCAD X Version 14.6.10 (7331)

**Ch40600/Hearing Aid Compatibility Test (101x101x1):** Interpolated grid: dx=0.5000 mm, dy=0.5000 mm

Device Reference Point: 0, 0, -6.3 mm

Reference Value = 18.35 V/m; Power Drift = -0.14 dB

Applied MIF = -1.62 dB

RF audio interference level = 24.05 dBV/m

**Emission category: M4**

MIF scaled E-field

<b>Grid 1 M4</b> <b>21.13 dBV/m</b>	<b>Grid 2 M4</b> <b>25.27 dBV/m</b>	<b>Grid 3 M4</b> <b>24.96 dBV/m</b>
<b>Grid 4 M4</b> <b>20.55 dBV/m</b>	<b>Grid 5 M4</b> <b>24.05 dBV/m</b>	<b>Grid 6 M4</b> <b>24.06 dBV/m</b>
<b>Grid 7 M4</b> <b>20.9 dBV/m</b>	<b>Grid 8 M4</b> <b>23 dBV/m</b>	<b>Grid 9 M4</b> <b>23 dBV/m</b>

**Cursor:**

Total = 25.27 dBV/m

E Category: M4

Location: -5.5, -19.5, 8.7 mm

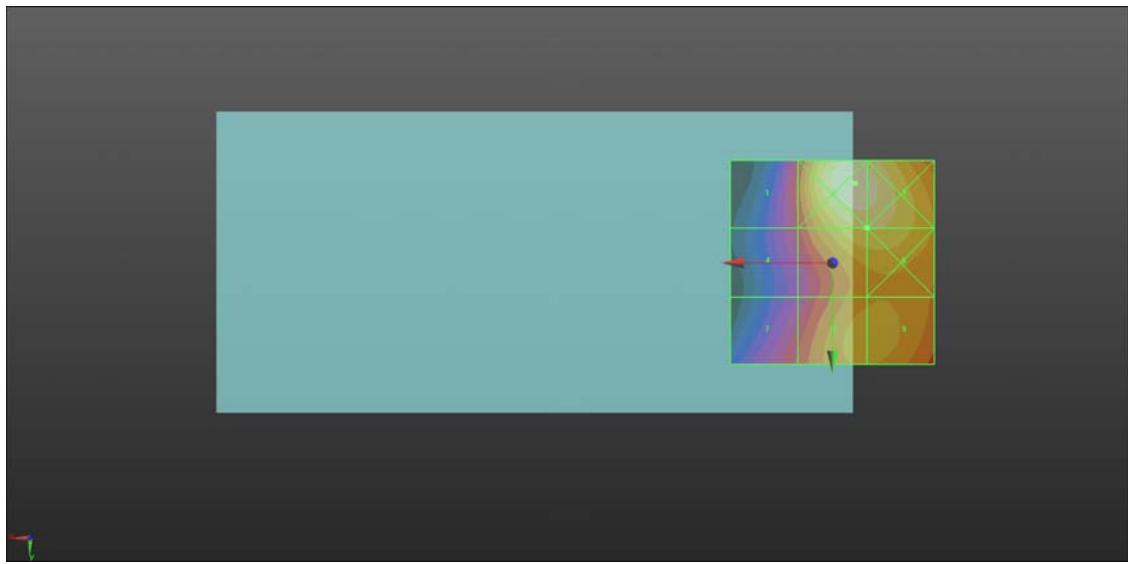
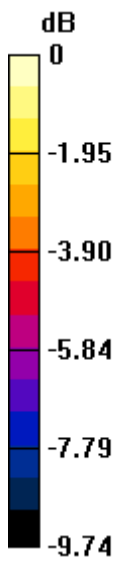

0 dB = 18.35 V/m = 25.27 dBV/m

**HAC RF\_LTE Band 41\_20M\_QPSK\_1RB\_99offset\_12.2Kbps\_Ch40870\_E**

Communication System: UID 10172 - CAB, LTE-TDD (SC-FDMA, 1 RB, 20 MHz, QPSK);  
 Frequency: 2618 MHz; Duty Cycle: 1:1.59

Medium: Air Medium parameters used:  $\sigma = 0$  S/m,  $\epsilon_r = 1$ ;  $\rho = 0$  kg/m<sup>3</sup>

Ambient Temperature : 23.2 °C

**DASY5 Configuration:**

- Probe: ER3DV6 - SN2434; ConvF(1, 1, 1); Calibrated: 2018.10.18;
- Sensor-Surface: (Fix Surface)
- Electronics: DAE4 Sn480; Calibrated: 2019.04.11
- Phantom: HAC Test Arch with AMCC; Type: SD HAC P01 BA;
- Measurement SW: DASY52, Version 52.8 (8); SEMCAD X Version 14.6.10 (7331)

**Ch40870/Hearing Aid Compatibility Test (101x101x1):** Interpolated grid: dx=0.5000 mm, dy=0.5000 mm

Device Reference Point: 0, 0, -6.3 mm

Reference Value = 18.98 V/m; Power Drift = -0.04 dB

Applied MIF = -1.62 dB

RF audio interference level = 24.12 dBV/m

**Emission category: M4**

MIF scaled E-field

<b>Grid 1 M4</b> <b>21.01 dBV/m</b>	<b>Grid 2 M4</b> <b>25.13 dBV/m</b>	<b>Grid 3 M4</b> <b>24.83 dBV/m</b>
<b>Grid 4 M4</b> <b>20.63 dBV/m</b>	<b>Grid 5 M4</b> <b>24.12 dBV/m</b>	<b>Grid 6 M4</b> <b>24.12 dBV/m</b>
<b>Grid 7 M4</b> <b>21.11 dBV/m</b>	<b>Grid 8 M4</b> <b>23.01 dBV/m</b>	<b>Grid 9 M4</b> <b>23.02 dBV/m</b>

**Cursor:**

Total = 25.13 dBV/m

E Category: M4

Location: -5.5, -19, 8.7 mm

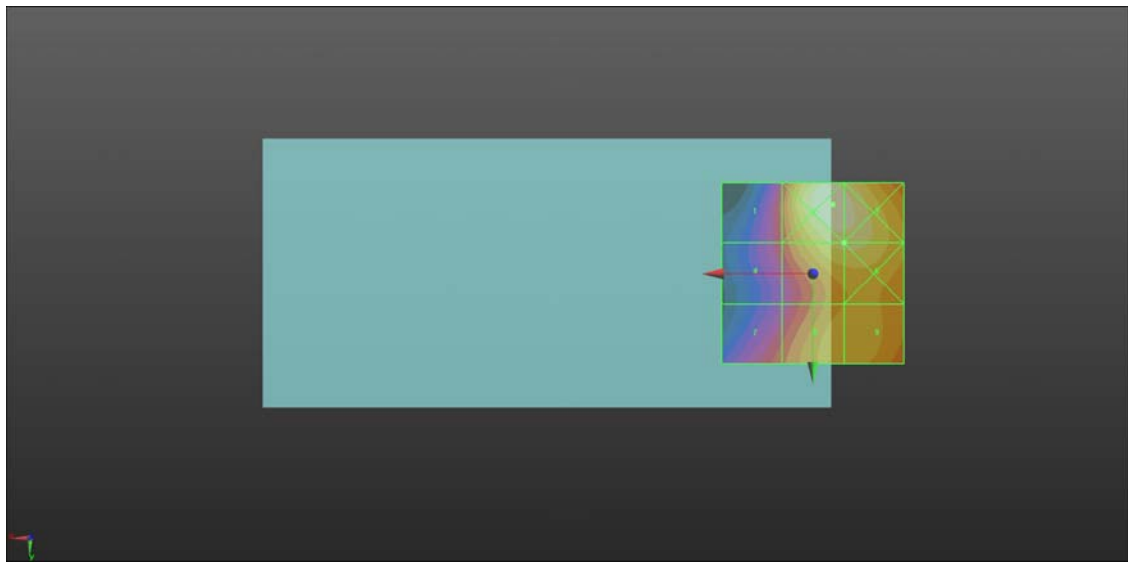
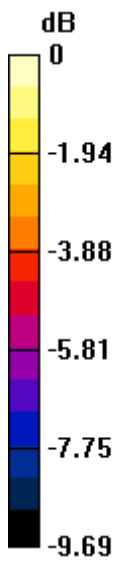

0 dB = 18.04 V/m = 25.12 dBV/m

**HAC RF\_LTE Band 41\_20M\_QPSK\_1RB\_99 offset\_12.2Kbps\_Ch41140\_E**

Communication System: UID 10172 - CAB, LTE-TDD (SC-FDMA, 1 RB, 20 MHz, QPSK);  
 Frequency: 2645 MHz; Duty Cycle: 1:1.59

Medium: Air Medium parameters used:  $\sigma = 0$  S/m,  $\epsilon_r = 1$ ;  $\rho = 0$  kg/m<sup>3</sup>

Ambient Temperature : 23.2 °C

**DASY5 Configuration:**

- Probe: ER3DV6 - SN2434; ConvF(1, 1, 1); Calibrated: 2018.10.18;
- Sensor-Surface: (Fix Surface)
- Electronics: DAE4 Sn480; Calibrated: 2019.04.11
- Phantom: HAC Test Arch with AMCC; Type: SD HAC P01 BA;
- Measurement SW: DASY52, Version 52.8 (8); SEMCAD X Version 14.6.10 (7331)

**Ch41140/Hearing Aid Compatibility Test (101x101x1):** Interpolated grid: dx=0.5000 mm, dy=0.5000 mm

Device Reference Point: 0, 0, -6.3 mm

Reference Value = 20.14 V/m; Power Drift = -0.10 dB

Applied MIF = -1.62 dB

RF audio interference level = 24.17 dBV/m

**Emission category: M4**

MIF scaled E-field

<b>Grid 1 M4</b> <b>21.1 dBV/m</b>	<b>Grid 2 M4</b> <b>25.06 dBV/m</b>	<b>Grid 3 M4</b> <b>24.75 dBV/m</b>
<b>Grid 4 M4</b> <b>20.93 dBV/m</b>	<b>Grid 5 M4</b> <b>24.17 dBV/m</b>	<b>Grid 6 M4</b> <b>24.16 dBV/m</b>
<b>Grid 7 M4</b> <b>20.91 dBV/m</b>	<b>Grid 8 M4</b> <b>22.69 dBV/m</b>	<b>Grid 9 M4</b> <b>22.69 dBV/m</b>

**Cursor:**

Total = 25.06 dBV/m

E Category: M4

Location: -5, -19, 8.7 mm

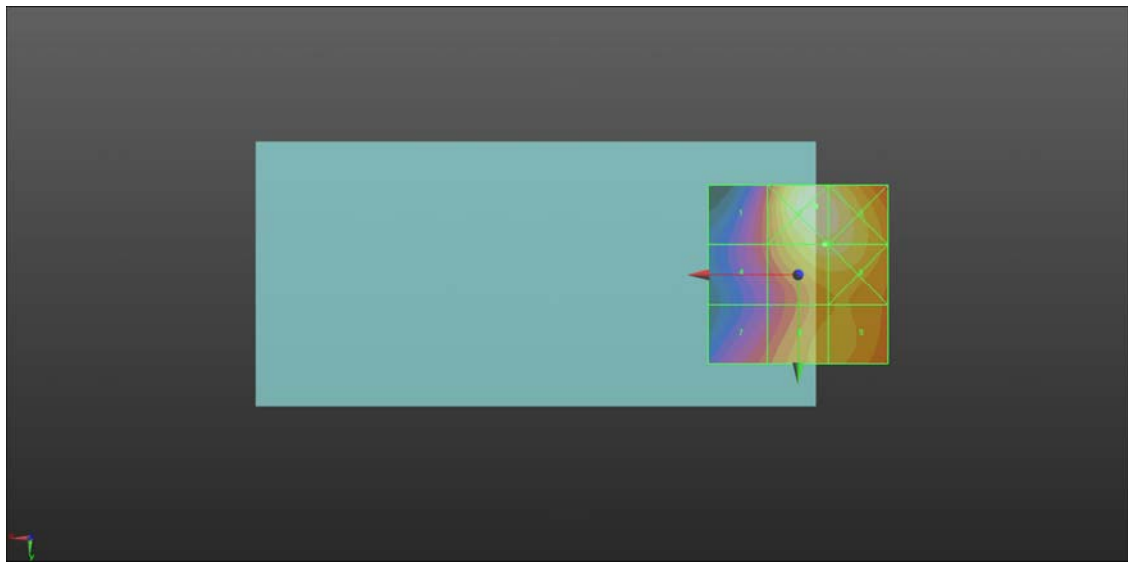
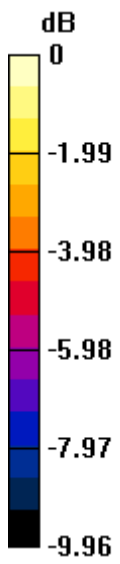

0 dB = 17.90 V/m = 25.06 dBV/m