



TEST REPORT

APPLICANT : Nubia Technology Co.,Ltd
PRODUCT NAME : LTE Digital Mobile Phone
MODEL NAME : NX627J
BRAND NAME : NUBIA
FCC ID : 2AHJO-NX627J
STANDARD(S) : 47CFR 2.1093
IEEE 1528-2013
RECEIPT DATE : 2019-08-21
TEST DATE : 2019-08-29 to 2019-09-17
ISSUE DATE : 2019-09-18

Edited by : Liang Yumei
Liang yumei (Rapporteur)
Approved by: Peng Huarui
Peng Huarui (Supervisor)

NOTE: This document is issued by MORLAB, the test report shall not be reproduced except in full without prior written permission of the company. The test results apply only to the particular sample(s) tested and to the specific tests carried out which is available on request for validation and information confirmed at our website.





DIRECTORY

1. SAR Results Summary.....	6
2. Technical Information.....	8
2.1. Applicant and Manufacturer Information.....	8
2.2. Equipment Under Test (EUT) Description	8
2.3. Environment of Test Site/Conditions	10
3. Specific Absorption Rate (SAR).....	11
3.1. Introduction	11
3.2. SAR Definition	11
4. RF Exposure Limits.....	12
5. Applied Reference Documents	13
6. SAR Measurement System.....	14
6.1. E-Field Probe	15
6.2. Data Acquisition Electronics (DAE).....	16
6.3. Robot	17
6.4. Measurement Server	17
6.5. Light Beam Unit.....	18
6.6. Phantom	18
6.7. Device Holder	19
6.8. Data Storage and Evaluation.....	20
6.9. Test Equipment List.....	23
7. Tissue Simulating Liquids.....	25
8. SAR System Verification.....	28
8.1. Purpose of System Performance check	28
8.2. System Setup	28



8.3. Validation Results 29

9. EUT Testing Position 32

9.1. Handset Reference Points 32

9.2. Positioning for Cheek / Touch 33

9.3. Positioning for Ear / 15° Tilt 34

9.4. SAR Evaluations near the Mouth/Jaw Regions of the SAM Phantom 34

9.5. Body-worn Configurations 35

9.6. Hotspot Mode Exposure Position Conditions 35

10. Measurement Procedures 36

10.1. Spatial Peak SAR Evaluation 37

10.2. Power Reference Measurement 37

10.3. Area Scan Procedures 38

10.4. Zoom Scan Procedures 38

10.5. SAR Averaged Methods 38

10.6. Power Drift Monitoring 39

11. SAR Test Procedure 40

11.1. General scan Requirements 40

11.2. Test procedure 41

11.3. Description of interpolation/extrapolation scheme 41

11.4. Wireless Router 42

12. SAR Test Configuration 43

13. Conducted RF Output Power 55

13.1. Full Power 55

13.2. Down Power 114

14. LTE Carrier Aggregation 161

14.1. LTE Downlink Carrier Aggregation Conducted Power 162

15. Hot-Spot Mode Evaluation Procedure 164

15.1. EUT Antenna Location 164



16. Block diagram of the tests to be performed	166
16.1. Head	166
16.2. Body	167
17. Test Results List	168
17.1. Test Guidance	168
17.2. Head SAR Data	170
17.3. Body-worn SAR Data	187
17.4. Hotspot SAR Data	198
17.5. Repeated SAR Measurement	218
18. Simultaneous Transmission Evaluation	221
19. Uncertainty Assessment	243
Annex A General Information	
Annex B Test Setup Photos	
Annex C Plots of System Performance Check	
Annex D Plots of Maximum SAR Test Results	
Annex E DASY Calibration Certificate	



Changed History		
Version	Date	Reason for change
1.0	2019-09-18	Original

1. SAR Results Summary

The maximum results of Specific Absorption Rate (SAR) found during test as bellows:

<Highest Reported standalone SAR Summary>

Frequency Band		Highest SAR Summary		
		Head (Separation 0mm)	Body-worn (Separation 10mm)	Hotspot (Separation 10mm)
		1g SAR (W/kg)		
GSM	GSM850	0.989	0.468	0.468
	GSM1900	0.973	0.418	0.920
WCDMA	WCDMA Band II	1.040	0.455	0.990
	WCDMA Band IV	0.773	0.498	0.924
	WCDMA Band V	0.667	0.333	0.333
CDMA	CDMA2000 BC0	0.861	0.412	0.475
	CDMA2000 BC1	0.724	0.405	0.624
LTE	LTE Band 2	0.946	0.463	0.940
	LTE Band 4	0.827	0.645	1.029
	LTE Band 5	0.751	0.304	0.304
	LTE Band 7	1.162	0.775	1.154
	LTE Band 12	0.091	0.136	0.151
	LTE Band 17	0.085	0.147	0.157
	LTE Band 18	0.770	0.315	0.315
	LTE Band 19	0.923	0.359	0.359
	LTE Band 25	1.037	0.552	1.074
	LTE Band 26	0.754	0.316	0.316
	LTE Band 30	0.906	0.490	1.083
	LTE Band 38	0.446	0.201	0.291
	LTE Band 40	0.856	0.275	0.581
	LTE Band 41	0.406	0.231	0.283
LTE Band 66	0.890	0.675	1.142	
WLAN	2.4GHz WLAN	0.489	0.076	0.076
	5GHz WLAN	0.556	0.388	N/A
2.4GHz Band	Bluetooth	N/A	0.028	0.028



Max Scaled SAR _{1g} (W/Kg):	Head:	1.162 W/kg	Limit(W/kg): 1.6 W/kg
	Body:	0.775 W/kg	
	Hotspot:	1.154 W/kg	

Highest Simultaneous Transmission SAR _{1g} (W/Kg):	1.594 W/kg	Limit(W/kg): 1.6 W/kg
---	------------	-----------------------

Note:

This device is in compliance with Specific Absorption Rate (SAR) for general population/ uncontrolled exposure limits (1.6W/kg as averaged over any 1 gram of tissue; specified in FCC 47 CFR part 2 (2.1093) and ANSI/IEEE C95.1-1992, and had been tested in accordance with the measurement methods and procedures specified in IEEE 1528-2013 and FCC KDB publications.



2. Technical Information

Note: Provide by applicant.

2.1. Applicant and Manufacturer Information

Applicant:	Nubia Technology Co.,Ltd
Applicant Address:	10/F, Tower A, Hans Innovation Mansion, North Ring Rd., No.9018, High-Tech Park, Nanshan District, Shenzhen, China
Manufacturer:	Nubia Technology Co.,Ltd
Manufacturer Address:	10/F, Tower A, Hans Innovation Mansion, North Ring Rd., No.9018, High-Tech Park, Nanshan District, Shenzhen, China

2.2. Equipment Under Test (EUT) Description

EUT Name:	LTE Digital Mobile Phone
Hardware Version:	NX627J_V1MB
Software Version:	NX627J_ENCommon_V1.00
Frequency Bands:	GSM 850: 824.2 MHz ~ 848.8 MHz GSM 1900: 1850.2 MHz ~ 1909.8 MHz WCDMA Band II: 1852.4 MHz ~ 1907.6 MHz WCDMA Band IV: 1710 MHz ~ 1755 MHz WCDMA Band V: 826.4 MHz ~ 846.6 MHz CDMA BC 0: 824.7 MHz ~ 848.31 MHz CDMA BC 1: 1850 MHz ~ 1910 MHz LTE Band 2: 1850 MHz ~ 1910 MHz LTE Band 4: 1710 MHz ~ 1755 MHz LTE Band 5: 824 MHz ~ 849 MHz LTE Band 7: 2500 MHz ~ 2570 MHz LTE Band 12: 699 MHz ~ 716 MHz LTE Band 17: 704 MHz ~ 716 MHz LTE Band 18: 815 MHz ~ 830 MHz LTE Band 19: 830 MHz ~ 845 MHz LTE Band 25: 1850 MHz ~ 1915 MHz LTE Band 26: 814 MHz ~ 849 MHz LTE Band 30: 2305 MHz ~ 2315 MHz LTE Band 38: 2570 MHz ~ 2620MHz LTE Band 40A: 2305 MHz ~ 2315 MHz LTE Band 40B: 2350 MHz ~ 2360 MHz LTE Band 41: 2555 MHz ~ 2655 MHz



	LTE Band 66: 1710 MHz ~ 1780 MHz WLAN 2.4GHz: 2412 MHz ~ 2462 MHz WLAN 5.2GHz: 5180 MHz ~ 5240 MHz WLAN 5.3GHz: 5260 MHz ~ 5320 MHz WLAN 5.5GHz: 5500 MHz ~ 5720 MHz WLAN 5.8GHz: 5745 MHz ~ 5825 MHz Bluetooth: 2402 MHz ~ 2480 MHz
Modulation Mode:	GSM/GPRS: GMSK EDGE: 8PSK WCDMA: QPSK/16QAM 1XRTT: QPSK EV-DO Rev.0/A/B: QPSK LTE: QPSK/16QAM/64QAM 802.11b: DSSS 802.11a/g/n-HT20/HT40/ac-VHT20/ac-VHT40: OFDM BR+EDR: GFSK(1Mbps), $\pi/4$ -DQPSK(2Mbps), 8-DPSK(3Mbps) Bluetooth LE: GFSK(1Mbps), $\pi/4$ -DQPSK(2Mbps)
Multi-slot Class:	GPRS: Multi-slot Class 33; EDGE: Multi-slot Class 33;
Operation Class:	Class B
Hotspot Mode:	WWAN/2.4GHz WLAN
Antenna Type:	WWAN: Fixed Internal WLAN: PIFA Antenna Bluetooth: PIFA Antenna
Battery:	3900mAh/3.82V
SIM Cards Description:	For dual SIM card version, SIM 1 and SIM 2 are the same chipset unit and tested as a single chipset, the SIM 1 is selected for testing
LTE Carrier Aggregation Combinations	CA Downlink only: 38C, 41C

Note: For a more detailed description, please refer to specification or user manual supplied by the applicant and/or manufacturer.

2.3. Environment of Test Site/Conditions

Normal Temperature (NT):	20 ... 25 °C
Relative Humidity:	30 ... 75 %
Air Pressure:	980 ... 1020 hPa

Test frequency:	GSM 850MHz/1900MHz; WCDMA Band II/IV/V; CDMA BC 0/BC 1; FDD-LTE Band 2/4/5/7/12/17/18/19/25/26/30/66; TDD-LTE Band 38/40/41; WLAN 2.4GHz; WLAN 5GHz;
Operation mode:	Call established
Power Level:	GSM 850 MHz Maximum output power(level 5) GSM 1900MHz Maximum output power(level 0) WCDMA Band II/IV/V (All Up Bits) CDMA BC 0/BC 1(Maximum output power) FDD-LTE Band 2/4/5/7/12/17/18/19/25/26/30/66 (Maximum output power) TDD-LTE Band 38/40/41 (Maximum output power) WLAN 2.4GHz (Power setting=14) WLAN 5GHz (Power setting=15)

During SAR test, EUT is in Traffic Mode (Channel Allocated) at Normal Voltage Condition. A communication link is set up with a System Simulator (SS) by air link, and a call is established.

The EUT shall use its internal transmitter. The antenna(s), battery and accessories shall be those specified by the Factory. The EUT battery must be fully charged and checked periodically during the test to ascertain uniform power output. If a wireless link is used, the antenna connected to the output of the base station simulator shall be placed at least 50 cm away from the handset.

The signal transmitted by the simulator to the antenna feeding point shall be lower than the output power level of the handset by at least 35 dB.

For SAR testing, EUT is in GPRS mode. In GPRS link mode, its crest factor is 2, because EUT is set in GPRS multi-slot class 12 with 4 uplink slots. In WCDMA and WI-FI mode, its crest factor is 1.

3. Specific Absorption Rate (SAR)

3.1. Introduction

SAR is related to the rate at which energy is absorbed per unit mass in an object exposed to a radio field. The SAR distribution in a biological body is complicated and is usually carried out by experimental techniques or numerical modeling. The standard recommends limits for two tiers of groups, occupational/controlled and general population/uncontrolled, based on a person's awareness and ability to exercise control over his or her exposure. In general, occupational/controlled exposure limits are Middle than the limits for general population/uncontrolled.

3.2. SAR Definition

The SAR definition is the time derivative (rate) of the incremental energy (dW) absorbed by(dissipated in) an incremental mass (dm) contained in a volume element (dv) of a given density. (ρ). The equation description is as below:

$$SAR = \frac{d}{dt} \left(\frac{dW}{dm} \right) = \frac{d}{dt} \left(\frac{dW}{\rho dv} \right)$$

SAR is expressed in units of Watts per kilogram (W/kg)

SAR measurement can be either related to the temperature elevation in tissue by,

$$SAR = C \left(\frac{\delta T}{\delta t} \right)$$

Where C is the specific head capacity, δT is the temperature rise and δt the exposure duration, or related to the electrical field in the tissue by

$$SAR = \frac{\sigma |E|^2}{\rho}$$

Where σ is the conductivity of the tissue, ρ is the mass density of the tissue and $|E|$ is the rmselectrical field strength.

However for evaluating SAR of low power transmitter, electrical field measurement is typically applied.



4. RF Exposure Limits

Limits for General Population/Uncontrolled Exposure (W/kg)

Type Exposure	Uncontrolled Environment Limit
Spatial Peak SAR (1g cube tissue for head and trunk)	1.60W/kg
Spatial Peak SAR (10g cube tissue for limbs)	4.00W/kg
Spatial Peak SAR (1g cube tissue for whole body)	0.08W/kg

Note:

1. This limit is according to recommendation 1999/519/EC, Annex II (Basic Restrictions)
2. Occupational/Uncontrolled Environments are defined as locations where there is exposure that may be incurred by people who are aware of the potential for exposure, (i.e. as a result of employment or occupation)

5. Applied Reference Documents

Leading reference documents for testing:

No.	Identity	Document Title	Method determination /Remark
1	47 CFR§2.1093	Radio Frequency Radiation Exposure Evaluation: Portable Devices	No deviation
2	IEEE 1528-2013	IEEE Recommended Practice for Determining the Peak Spatial-Average Specific Absorption Rate (SAR) in the Human Head from Wireless Communications Devices: Measurement Techniques	No deviation
3	KDB 447498 D01v06	General RF Exposure Guidance	No deviation
4	KDB 248227 D01v02r02	SAR Measurement Procedures for 802.11 Transmitters	No deviation
5	KDB 865664 D01v01r04	SAR Measurement 100 MHz to 6 GHz	No deviation
6	KDB 865664 D02v01r02	RF Exposure Reporting	No deviation
7	KDB 648474 D04v01r03	Handset SAR	No deviation
8	KDB 941225 D01v03r01	3G SAR MEAUREMENT PROCEDURES	No deviation
9	KDB 941225 D05v02r05	SAR Evaluation Consideration for LTE Devices	No deviation
10	KDB 941225 D06v02r01	SAR Evaluation Procedures For Portable Devices With Wireless Router Capabilities	No deviation

6. SAR Measurement System

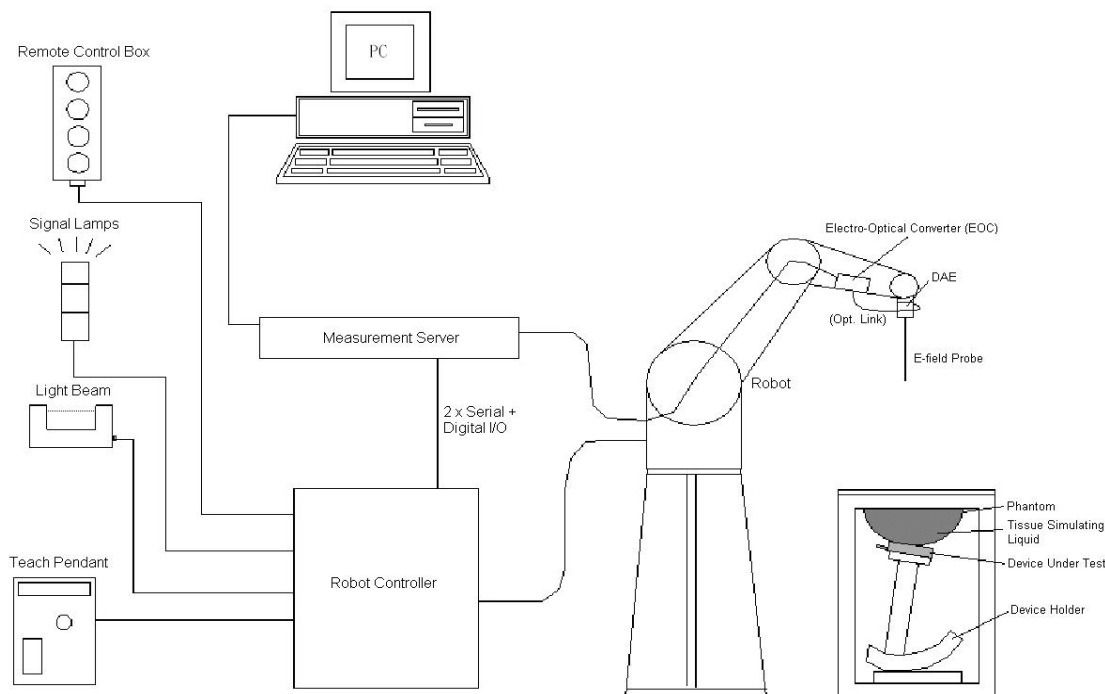

Fig 6.1 SPEAG DASY System Configurations

The DASY system for performance compliance tests is illustrated above graphically. This system consists of the following items:

A standard high precision 6-axis robot with controller, a teach pendant and software

A data acquisition electronic (DAE) attached to the robot arm extension

A dosimetric probe equipped with an optical surface detector system

The electro-optical converter (ECO) performs the conversion between optical and electrical signals

A measurement server performs the time critical tasks such as signal filtering, control of the robot operation and fast movement interrupts.

A probe alignment unit which improves the accuracy of the probe positioning

A computer operating Windows XP

DASY software

Remove control with teach pendant and additional circuitry for robot safety such as warning lamps, etc.

The SAM twin phantom

A device holder

Tissue simulating liquid

Dipole for evaluating the proper functioning of the system

Some of the components are described in details in the following sub-sections.

6.1. E-Field Probe

The SAR measurement is conducted with the dosimetric probe (manufactured by SPEAG). The probe is specially designed and calibrated for use in liquid with high permittivity. The dosimetric probe has special calibration in liquid at different frequency. This probe has a built in optical surface detection system to prevent from collision with phantom.

E-Field Probe Specification <ES3DV3 Probe>

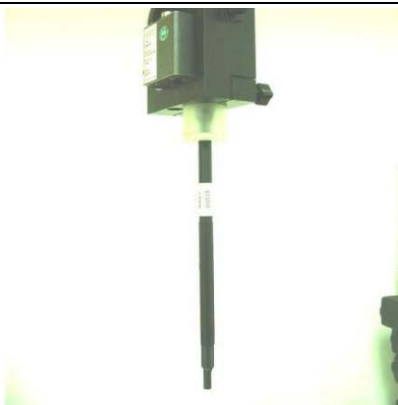
Construction	Symmetrical design with triangular core Built-in optical fiber for surface detection system. Built-in shielding against static charges. PEEK enclosure material (resistant to organic solvents, e.g., DGBE)	
Frequency	10 MHz to 3 GHz; Linearity: ± 0.2 dB	
Directivity	± 0.2 dB in HSL (rotation around probe axis) ± 0.4 dB in HSL (rotation normal to probe axis)	
Dynamic Range	5 μ W/g to 100 mW/g; Linearity: ± 0.2 dB	
Dimensions	Overall length: 330 mm (Tip: 16 mm) Tip diameter: 6.8 mm (Body: 12 mm) Distance from probe tip to dipole centers: 2.7 mm	

<EX3DV4 Probe>

Construction	Symmetrical design with triangular core Built-in shielding against static charges PEEK enclosure material (resistant to organic solvents, e.g., DGBE)	
Frequency	10 MHz to 6 GHz; Linearity: ± 0.2 dB	
Directivity	± 0.3 dB in HSL (rotation around probe axis) ± 0.5 dB in tissue material (rotation normal to probe axis)	
Dynamic Range	10 μ W/g to 100 mW/g; Linearity: ± 0.2 dB	
Dimensions	Overall length: 330 mm (Tip: 20 mm) Tip diameter: 2.5 mm (Body: 12 mm) Typical distance from probe tip to dipole centers: 1 mm	

E-Field Probe Calibration

Each probe needs to be calibrated according to a dosimetric assessment procedure with accuracy better than $\pm 10\%$. The spherical isotropy shall be evaluated and within ± 0.25 dB. The sensitivity parameters (NormX, NormY, and NormZ), the diode compression parameter (DCP) and the conversion factor (ConvF) of the probe are tested. The calibration data can be referred to appendix C of this report.

6.2. Data Acquisition Electronics (DAE)

The data acquisition electronics(DAE) consists of a highly sensitive electrometer-grade preamplifier with auto-zeroing, a channel and gain-switching multiplexer, a fast16 bit AD-converter and a command decoder and control logic unit. AD-converter and a command decoder and control logic unit. Transmission to the measurement server is accomplished through an optical downlink for data and status information as well as an optical uplink for commands and the clock. The input impedance of the DAE is 200M Ω ; the inputs are symmetrical and floating. Common mode rejection is above 80 dB.



Fig 6.4Photo of DAE

6.3. Robot

The SPEAG DASY system uses the high precision robots (DASY4: RX90BL; DASY5: TX90XL) type from Stäubli SA (France). For the 6-axis controller system, the robot controller version (DASY4: CS7MB; DASY5: CS8c) from Stäubli is used. The Stäubli robot series have many features that are important for our application:

High precision (repeatability ± 0.035 mm)

High reliability (industrial design)

Jerk-free straight movements

Low ELF interference (the closed metallic construction shields against motor control fields)



Fig 6.5 Photo of DASY5

6.4. Measurement Server

The measurement server is based on a PC/104 CPU board with CPU (DASY4: 166 MHz, Intel Pentium;

DASY5: 400 MHz, Intel Celeron), chip disk (DASY4: 32 MB; DASY5: 128 MB), RAM (DASY4: 64 MB, DASY5: 128 MB). The necessary circuits for communication with the DAE electronic box, as well as the 16 bit AD converter system for optical detection and digital I/O interface are contained on the DASY I/O board, which is directly connected to the PC/104 bus of the CPU board.

The measurement server performs all the real-time data evaluation for field measurements and surface detection, controls robot movements and handles safety operations.



Fig 6.6 Photo of Server for DASY5

6.5. Light Beam Unit

The light beam switch allows automatic "tooling" of the probe. During the process, the actual position of the probe tip with respect to the robot arm is measured, as well as the probe length and the horizontal probe offset. The software then corrects all movements, such that the robot coordinates are valid for the probe tip.

The repeatability of this process is better than 0.1 mm. If a position has been taught with an aligned probe, the same position will be reached with another aligned probe within 0.1 mm, even if the other probe has different dimensions. During probe rotations, the probe tip will keep its actual position.



Fig. 6.7 Photo of Light Beam

6.6. Phantom

<SAM Twin Phantom>

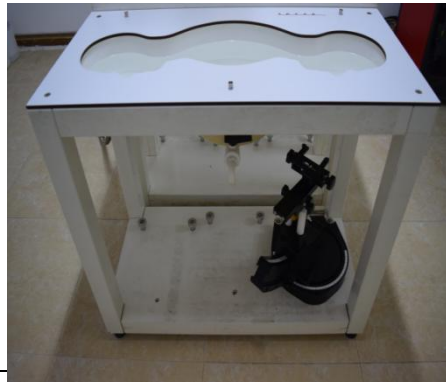
Shell Thickness	2 ± 0.2 mm (sagging: <1%) Center ear point: 6 ± 0.2 mm	
Filling Volume	Approx. 25 liters	
Dimensions	Length: 1000 mm; Width: 500 mm; Height: adjustable feet	
Measurement Areas	Left Hand, Right Hand, Flat Phantom	Fig 6.8 Photo of SAM Phantom

The bottom plate contains three pair of bolts for locking the device holder. The device holder positions are adjusted to the standard measurement positions in the three sections. A white cover is provided to tap the phantom during off-periods to prevent water evaporation and changes in the liquid parameters. On the phantom top, three reference markers are provided to identify the phantom position with respect to the robot.

6.7. Device Holder

<Device Holder for SAM Twin Phantom>

The SAR in the phantom is approximately inversely proportional to the square of the distance between the source and the liquid surface. For a source at 5 mm distance, a positioning uncertainty of ± 0.5 mm would produce a SAR uncertainty of ± 20 %. Accurate device positioning is therefore crucial for accurate and repeatable measurements. The positions in which the devices must be measured are defined by the standards.

The DASY device holder is designed to cope with different positions given in the standard. It has two scales for the device rotation (with respect to the body axis) and the device inclination (with respect to the line between the ear reference points). The rotation center for both scales is the ear reference point (EPR). Thus the device needs no repositioning when changing the angles.

The DASY device holder is constructed of low-loss POM material having the following dielectric parameters: relative permittivity $\epsilon = 3$ and loss tangent $\delta = 0.02$. The amount of dielectric material has been reduced in the closest vicinity of the device, since measurements have suggested that the influence of the clamp on the test results could thus be lowered.



Fig 6.9 Device Holder

<Laptop Extension Kit>

The extension is lightweight and made of POM, acrylic glass and foam. It fits easily on the upper part of the mounting device in place of the phone positioned. The extension is fully compatible with the SAM Twin and ELI phantoms.

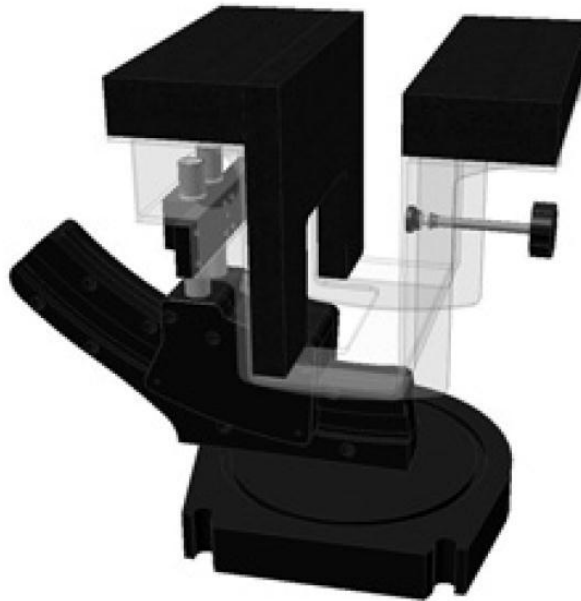

Fig 6.10 Laptop Extension Kit

6.8. Data Storage and Evaluation

Data Storage

The DASy software stores the assessed data from the data acquisition electronics as raw data (in microvolt readings from the probe sensors), together with all the necessary software parameters for the data evaluation (probe calibration data, liquid parameters and device frequency and modulation data) in measurement files. The post-processing software evaluates the desired unit and format for output each time the data is visualized or exported. This allows verification of the complete software setup even after the measurement and allows correction of erroneous parameter settings. For example, if a measurement has been performed with an incorrect crest factor parameter in the device setup, the parameter can be corrected afterwards and the data can be reevaluated.

The measured data can be visualized or exported in different units or formats, depending on the selected probe type (e.g., [V/m], [A/m], [mW/g]). Some of these units are not available in certain situations or give meaningless results, e.g., a SAR-output in a non-loss media, will always be zero. Raw data can also be exported to perform the evaluation with other software packages.

**Data Evaluation**

The DASY post-processing software (SEMCAD) automatically executes the following procedures to calculate the field units from the microvolt readings at the probe connector. The parameters used in the evaluation are stored in the configuration modules of the software.

Probe parameters:	- Sensitivity	Norm _i , a _{i0} , a _{i1} , a _{i2}
	- Conversion factor	ConvF _i
	- Diode compression point	dcp _i
Device parameters:	- Frequency	f
	- Crest factor	cf
Media parameters:	- Conductivity	σ
	- Density	ρ

These parameters must be set correctly in the software. They can be found in the component documents or they can be imported into the software from the configuration files issued for the DASY components. In the direct measuring mode of the multi-meter option, the parameters of the actual system setup are used. In the scan visualization and export modes, the parameters stored in the corresponding document files are used.

The first step of the evaluation is a linearization of the filtered input signal to account for the compression characteristics of the detector diode. The compensation depends on the input signal, the diode type and the DC-transmission factor from the diode to the evaluation electronics. If the exciting field is pulsed, the crest factor of the signal must be known to correctly compensate for peak power.

The formula for each channel can be given as:

$$V_i = U_i + U_i^2 \times \frac{cf}{dcp_i}$$

With
 V_i = compensated signal of channel i , ($i = x, y, z$)
 U_i = input signal of channel i , ($i = x, y, z$)
 cf = crest factor of exciting field (DASY parameter)
 dcp_i = diode compression point (DASY parameter)

From the compensated input signals, the primary field data for each channel can be evaluated:

$$\text{E-field Probes: } E_i = \sqrt{\frac{V_i}{\text{Norm}_i \times \text{ConvF}}}$$

$$\text{H-field Probes: } H_i = \sqrt{V_i} \times \frac{a_{i0} + a_{i1} + a_{i2} f^2}{f}$$



With V_i = compensated signal of channel i , ($i = x, y, z$)
Norm $_i$ = sensor sensitivity of channel i , ($i = x, y, z$), $\mu V/(V/m)^2$ for E-field
Probes ConvF = sensitivity enhancement in solution
 a_{ij} = sensor sensitivity factors for H-field probes
 f = carrier frequency [GHz]
 E_i = electric field strength of channel i in V/m
 H_i = magnetic field strength of channel i in A/m

The RSS value of the field components gives the total field strength (Hermitian magnitude):

$$E_{\text{tot}} = \sqrt{E_x^2 + E_y^2 + E_z^2}$$

The primary field data are used to calculate the derived field units.

$$\text{SAR} = E_{\text{tot}}^2 \times \frac{\sigma}{\rho \times 1000}$$

with SAR = local specific absorption rate in mW/g

E_{tot} = total field strength in V/m

σ = conductivity in [mho/m] or [Siemens/m]

ρ = equivalent tissue density in g/cm^3

Note that the density is set to 1, to account for actual head tissue density rather than the density of the tissue simulating liquid.



6.9. Test Equipment List

Manufacturer	Name of Equipment	Type/Model	Serial Number	Calibration	
				Last Cal.	Due Date
SPEAG	750MHz System Validation Kit	D750V3	1173	2019.06.21	2020.06.20
SPEAG	835MHz System Validation Kit	D835V2	4d227	2019.06.22	2020.06.21
SPEAG	1750MHz System Validation Kit	D1750V2	1160	2019.06.25	2020.06.24
SPEAG	1900MHz System Validation Kit	D1900V2	5d221	2019.06.22	2020.06.21
SPEAG	2300MHz System Validation Kit	D2300V2	1056	2018.09.18	2019.09.17
SPEAG	2450MHz System Validation Kit	D2450V2	805	2018.10.26	2019.10.25
SPEAG	2600MHz System Validation Kit	D2600V2	1139	2019.06.25	2020.06.24
SPEAG	5000MHz System Validation Kit	D5GHzV2	1176	2018.11.06	2019.11.05
SPEAG	Dosimetric E-Field Probe	EX3DV4	3823	2018.11.12	2019.11.11
SPEAG	Dosimetric E-Field Probe	ES3DV3	3154	2019.07.16	2020.07.15
SPEAG	Data Acquisition Electronics	DAE4	480	2019.04.11	2020.04.10
SPEAG	Dielectric Assessment KIT	DAK-3.5	1279	2018.11.03	2019.11.02
SPEAG	SAM Twin Phantom 1	QD 000 P40 CB	TP-1471	NCR	NCR
SPEAG	SAM Twin Phantom 2	QD 000 P40 CB	TP-1464	NCR	NCR
SPEAG	Phone Positioner	N/A	N/A	NCR	NCR
R&S	Network Emulator	CMW500	124534	2019.04.17	2020.04.16
Agilent	Network Analyzer	E5071B	MY42404762	2019.04.15	2020.04.14
mini-circuits	Amplifier	ZHL-42W+	608501717	NCR	NCR
mini-circuits	Amplifier	ZVE-8G+	754401735	NCR	NCR
Agilent	Signal Generator	N5182B	MY53050509	2019.04.17	2020.04.16
Agilent	Power Sensor	N8482A	MY41090849	2018.11.23	2019.11.22
Agilent	Power Meter	E4416A	MY45102093	2018.11.23	2019.11.22
Anritsu	Power Sensor	MA2411B	N/A	2018.11.23	2019.11.22
Anritsu	Power Meter	NRVD	101066	2018.11.23	2019.11.22
Agilent	Dual Directional Coupler	778D	50422	NA	NA
MCL	Attenuation1	351-218-010	N/A	NA	NA
THERMOMETER	Thermo meter	DC-803	N/A	2018.11.22	2019.11.21
N/A	Tissue Simulating Liquids	700-6000MHz	N/A	24H	

Note:

1. The calibration certificate of DASY can be referred to appendix E of this report.
2. The Insertion Loss calibration of Dual Directional Coupler and Attenuator were characterized via the



network analyzer and compensated during system check.

3. The dielectric probe kit was calibrated via the network analyzer, with the specified procedure (calibrated in pure water) and calibration kit (standard) short circuit, before the dielectric measurement. The specific procedure and calibration kit are provided by Speag.
4. In system check we need to monitor the level on the power meter, and adjust the power amplifier level to have precise power level to the dipole; the measured SAR will be normalized to 1W input power according to the ratio of 1W to the input power to the dipole. For system check, the calibration of the power amplifier is deemed not critically required for correct measurement; the power meter is critical and we do have calibration for it
5. Attenuator insertion loss is calibrated by the network Analyzer, which the calibration is valid, before system check.
6. N.C.R means No Calibration Requirement.

7. Tissue Simulating Liquids

For SAR measurement of the field distribution inside the phantom, the phantom must be filled with homogeneous tissue simulating liquid to a depth of at least 15 cm. For head SAR testing, the liquid height from the ear reference point (ERP) of the phantom to the liquid top surface is larger than 15 cm. For body SAR testing, the liquid height from the center of the flat phantom to the liquid top surface is larger than 15 cm, which is shown in Fig. 5.1. For body SAR testing, the liquid height from the center of the flat phantom to the liquid top surface is larger than 15 cm, which is shown in Fig. 5.2. The nominal dielectric values of the tissues simulating liquids in the phantom and the tolerance of 5% are listed in below table.

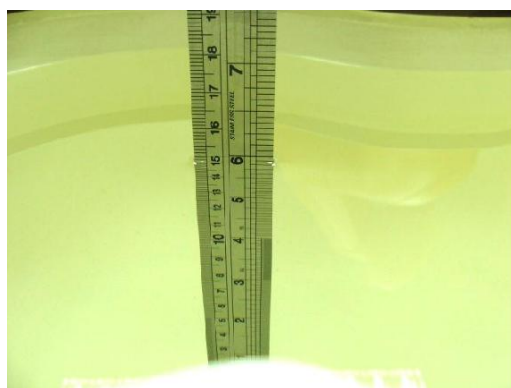

Fig 7.1 Photo of Liquid Height for Head SAR



Fig 7.2 Photo of Liquid Height for Body SAR

The following table gives the recipes for tissue simulating liquids

Frequency (MHz)	Water (%)	Sugar (%)	Cellulose (%)	Salt (%)	Preventol (%)	DGBE (%)	Conductivity (σ)	Permittivity (ϵ_r)
Head								
750	41.1	57.0	0.2	1.4	0.2	0	0.89	41.9
835	40.3	57.9	0.2	1.4	0.2	0	0.90	41.5
1800, 1900, 2000	55.2	0	0	0.3	0	44.5	1.40	40.0
2450	55.0	0	0	0	0	45.0	1.80	39.2
2600	54.8	0	0	0.1	0	45.1	1.96	39.0
Body								
750	51.7	47.2	0	0.9	0.1	0	0.96	55.5
835	50.8	48.2	0	0.9	0.1	0	0.97	55.2
1800, 1900, 2000	70.2	0	0	0.4	0	29.4	1.52	53.3
2450	68.6	0	0	0	0	31.4	1.95	52.7
2600	68.1	0	0	0.1	0	31.8	2.16	52.5

Simulating Liquid for 5GHz, Manufactured by SPEAG

Ingredients	(% by weight)
Water	64~78%
Mineral oil	11~18%
Emulsifiers	9~15%
Additives and Salt	2~3%

Note: Please refer to the validation results for dielectric parameters of each frequency band.

The dielectric properties of the tissue simulating liquids were verified prior to the SAR evaluation



using an Agilent 85033E Dielectric Probe Kit and an Agilent Network Analyzer.

Table 1: Dielectric Performance of Tissue Simulating Liquid

<HSL>

Frequency (MHz)	Tissue Type	Liquid Temp. (°C)	Conductivity (σ)	Conductivity Target (σ)	Delta (σ) (%)	Limit (%)	Date
750	HSL	22.6	0.882	0.89	-0.90	±5	2019.09.02
835	HSL	22.7	0.923	0.90	2.56	±5	2019.08.29
1750	HSL	22.6	1.380	1.37	0.73	±5	2019.08.31
1900	HSL	22.4	1.397	1.40	-0.21	±5	2019.09.14
2300	HSL	22.4	1.680	1.67	0.60	±5	2019.09.03
2450	HSL	22.6	1.751	1.80	-2.72	±5	2019.09.03
2600	HSL	22.5	2.011	1.96	2.60	±5	2019.09.01
5250	HSL	22.3	4.699	4.71	-0.23	±5	2019.09.09
5600	HSL	22.3	5.125	5.07	1.08	±5	2019.09.09
5750	HSL	22.3	5.298	5.22	1.49	±5	2019.09.09
Frequency (MHz)	Tissue Type	Liquid Temp. (°C)	Permittivity (ε _r)	Permittivity Target (ε _r)	Delta (ε _r) (%)	Limit (%)	Date
750	HSL	22.6	41.200	41.90	-1.67	±5	2019.09.02
835	HSL	22.7	42.274	41.50	1.87	±5	2019.08.29
1750	HSL	22.6	40.594	40.10	1.23	±5	2019.08.31
1900	HSL	22.4	39.984	40.00	-0.04	±5	2019.09.14
2300	HSL	22.4	40.616	39.50	2.83	±5	2019.09.03
2450	HSL	22.6	39.883	39.20	1.74	±5	2019.09.03
2600	HSL	22.5	39.957	39.00	2.45	±5	2019.09.01
5250	HSL	22.3	36.146	35.95	0.55	±5	2019.09.09
5600	HSL	22.3	35.435	35.50	-0.18	±5	2019.09.09
5750	HSL	22.3	35.158	35.35	-0.54	±5	2019.09.09



<MSL>

Frequency (MHz)	Tissue Type	Liquid Temp. (°C)	Conductivity (σ)	Conductivity Target (σ)	Delta (σ) (%)	Limit (%)	Date
750	MSL	22.4	0.960	0.96	0.00	±5	2019.09.07
835	MSL	22.4	0.981	0.97	1.13	±5	2019.09.04
1750	MSL	22.3	1.499	1.49	0.60	±5	2019.09.06
1900	MSL	22.7	1.519	1.52	-0.07	±5	2019.09.17
2300	MSL	22.4	1.779	1.81	-1.71	±5	2019.09.08
2450	MSL	22.2	1.897	1.95	-2.72	±5	2019.09.10
2600	MSL	22.4	2.171	2.16	0.51	±5	2019.09.08
5250	MSL	22.2	5.400	5.36	0.75	±5	2019.09.10
5600	MSL	22.2	5.789	5.77	0.33	±5	2019.09.10
5750	MSL	22.2	6.062	5.94	2.05	±5	2019.09.10

Frequency (MHz)	Tissue Type	Liquid Temp. (°C)	Permittivity (ϵ_r)	Permittivity Target (ϵ_r)	Delta (ϵ_r) (%)	Limit (%)	Date
750	MSL	22.4	53.900	55.50	-2.88	±5	2019.09.07
835	MSL	22.4	55.748	55.20	0.99	±5	2019.09.04
1750	MSL	22.3	53.911	53.40	0.96	±5	2019.09.06
1900	MSL	22.7	54.555	53.30	2.35	±5	2019.09.17
2300	MSL	22.4	53.478	52.90	1.09	±5	2019.09.08
2450	MSL	22.2	53.047	52.70	0.66	±5	2019.09.10
2600	MSL	22.4	52.512	52.50	0.02	±5	2019.09.08
5250	MSL	22.2	48.920	48.95	-0.06	±5	2019.09.10
5600	MSL	22.2	47.929	48.50	-1.18	±5	2019.09.10
5750	MSL	22.2	47.473	48.28	-1.67	±5	2019.09.10

8. SAR System Verification

Each DASY system is equipped with one or more system validation kits. These units, together with the predefined measurement procedures within the DASY software, enable the user to conduct the system performance check and system validation. System validation kit includes a dipole, tripod holder to fix it underneath the flat phantom and a corresponding distance holder.

8.1. Purpose of System Performance check

The system performance check verifies that the system operates within its specifications. System and operator errors can be detected and corrected. It is recommended that the system performance check be performed prior to any usage of the system in order to guarantee reproducible results. The system performance check uses normal SAR measurements in a simplified setup with a well characterized source. This setup was selected to give a high sensitivity to all parameters that might fail or vary over time. The system check does not intend to replace the calibration of the components, but indicates situations where the system uncertainty is exceeded due to drift or failure.

8.2. System Setup

The output power on dipole port must be calibrated to 24 dBm (250 mW) before dipole is connected. In the simplified setup for system evaluation, the DUT is replaced by a calibrated dipole and the power source is replaced by a continuous wave which comes from a signal generator. The calibrated dipole must be placed beneath the flat phantom section of the SAM twin phantom with the correct distance holder. The distance holder should touch the phantom surface with a light pressure at the reference marking and be oriented parallel to the long side of the phantom. The system check verifies that the system operates within its specifications. It is performed daily or before every SAR measurement. The system check uses normal SAR measurements in the flat section of the phantom with a matched dipole at a specified distance. The system verification setup is shown as below.



Fig 8.1 Photo of Dipole Setup

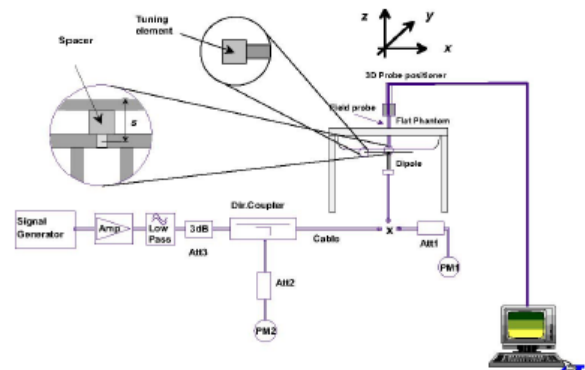

Fig 8.2 System Setup for System Evaluation



8.3. Validation Results

After system check testing, the SAR result will be normalized to 1W forward input power and compared with the reference SAR value derived from validation dipole certificate report. The deviation of system check should be within 10 %.

<Validation Setup>

Frequency (MHz) ²	Tissue Type	Input Power (mW)	Dipole S/N	Probe S/N	DAE S/N
750	HSL	250	D750V3-1173	3154	480
835	HSL	250	D835V2-4d227	3823	480
1750	HSL	250	D1750V2-1160	3823	480
1900	HSL	250	D1900V2_5d221	3823	480
2300	HSL	250	D2300V2_1056	3823	480
2450	HSL	250	D2450V2-805	3823	480
2600	HSL	250	D2600V2-1139	3823	480
5250	HSL	100	D5GHzV2-1176-5250	3823	480
5600	HSL	100	D5GHzV2-1176-5600	3823	480
5750	HSL	100	D5GHzV2-1176-5750	3823	480
750	MSL	250	D750V3-1173	3154	480
835	MSL	250	D835V2-4d227	3823	480
1750	MSL	250	D1750V2-1160	3823	480
1900	MSL	250	D1900V2_5d221	3823	480
2300	MSL	250	D2300V2_1056	3823	480
2450	MSL	250	D2450V2-805	3823	480
2600	MSL	250	D2600V2-1139	3823	480
5250	MSL	100	D5GHzV2-1176-5250	3823	480
5600	MSL	100	D5GHzV2-1176-5600	3823	480
5750	MSL	100	D5GHzV2-1176-5750	3823	480



<Head>

Date	Frequency (MHz)	Tissue Type	Input Power (mW)	Measured 1g SAR (W/kg)	Targeted 1g SAR (W/kg)	Normalized 1g SAR (W/kg)	Deviation (%)
2019.09.02	750	HSL	250	2.12	8.26	8.48	2.66
2019.08.29	835	HSL	250	2.37	9.34	9.48	1.50
2019.08.31	1750	HSL	250	9.29	37.10	37.16	0.16
2019.09.14	1900	HSL	250	9.58	39.50	38.32	-2.99
2019.09.03	2300	HSL	250	12.40	47.70	49.6	3.98
2019.09.03	2450	HSL	250	13.22	52.00	52.88	1.69
2019.09.01	2600	HSL	250	13.57	54.00	54.28	0.52
2019.09.09	5250	HSL	100	7.67	78.20	76.7	-1.92
2019.09.09	5600	HSL	100	8.31	80.90	83.1	2.72
2019.09.09	5750	HSL	100	7.96	80.00	79.6	-0.50
Date	Frequency (MHz)	Tissue Type	Input Power (mW)	Measured 10g SAR (W/kg)	Targeted 10g SAR (W/kg)	Normalized 10g SAR (W/kg)	Deviation (%)
2019.09.02	750	HSL	250	1.40	5.45	5.6	2.75
2019.08.29	835	HSL	250	1.51	6.07	6.04	-0.49
2019.08.31	1750	HSL	250	4.99	20.00	19.96	-0.20
2019.09.14	1900	HSL	250	5.18	20.60	20.72	0.58
2019.09.03	2300	HSL	250	5.85	23.10	23.4	1.30
2019.09.03	2450	HSL	250	6.10	24.10	24.4	1.24
2019.09.01	2600	HSL	250	6.21	24.50	24.84	1.39
2019.09.09	5250	HSL	100	2.23	22.50	22.3	-0.89
2019.09.09	5600	HSL	100	2.30	23.10	23	-0.43
2019.09.09	5750	HSL	100	2.31	22.60	23.1	2.21



<Body>

Date	Frequency (MHz)	Tissue Type	Input Power (mW)	Measured 1g SAR (W/kg)	Targeted 1g SAR (W/kg)	Normalized 1g SAR (W/kg)	Deviation (%)
2019.09.07	750	MSL	250	2.16	8.65	8.64	-0.12
2019.09.04	835	MSL	250	2.37	9.61	9.48	-1.35
2019.09.06	1750	MSL	250	9.90	37.40	39.6	5.88
2019.09.17	1900	MSL	250	9.79	39.90	39.16	-1.85
2019.09.08	2300	MSL	250	12.10	47.90	48.4	1.04
2019.09.10	2450	MSL	250	12.31	50.50	49.24	-2.50
2019.09.08	2600	MSL	250	13.23	54.00	52.92	-2.00
2019.09.10	5250	MSL	100	7.58	74.60	75.8	1.61
2019.09.10	5600	MSL	100	8.03	77.30	80.3	3.88
2019.09.10	5750	MSL	100	7.85	75.30	78.5	4.25
Date	Frequency (MHz)	Tissue Type	Input Power (mW)	Measured 10g SAR (W/kg)	Targeted 10g SAR (W/kg)	Normalized 10g SAR (W/kg)	Deviation (%)
2019.09.07	750	MSL	250	1.45	5.71	5.8	1.58
2019.09.04	835	MSL	250	1.57	6.31	6.28	-0.48
2019.09.06	1750	MSL	250	4.97	19.90	19.88	-0.10
2019.09.17	1900	MSL	250	5.22	20.70	20.88	0.87
2019.09.08	2300	MSL	250	5.62	23.00	22.48	-2.26
2019.09.10	2450	MSL	250	5.74	23.50	22.96	-2.30
2019.09.08	2600	MSL	250	5.97	24.20	23.88	-1.32
2019.09.10	5250	MSL	100	2.09	21.10	20.9	-0.95
2019.09.10	5600	MSL	100	2.17	21.80	21.7	-0.46
2019.09.10	5750	MSL	100	2.12	21.10	21.2	0.47

Note: System checks the specific test data please see Annex C

9. EUT Testing Position

This EUT was tested in six different positions. They are right cheek/right tilted/left cheek/left tilted for head, Front/Back of the EUT with phantom 10 mm gap, as illustrated below, please refer to Appendix B for the test setup photos.

9.1. Handset Reference Points

The vertical centre line passes through two points on the front side of the handset – the midpoint of the width w_t of the handset at the level of the acoustic output, and the midpoint of the width w_b of the bottom of the handset.

The horizontal line is perpendicular to the vertical centre line and passes the center of the acoustic output. The horizontal line is also tangential to the handset at point A.

The two lines intersect at point A. Note that for many handsets, point A coincides with the center of the acoustic output; however, the acoustic output may be located elsewhere on the horizontal line. Also note that the vertical centre line is not necessarily parallel to the front face of the handset, especially for clamshell handsets, handsets with flip covers, and other irregularly shaped handsets.



Fig. 9.1 Illustration for Cheek Position

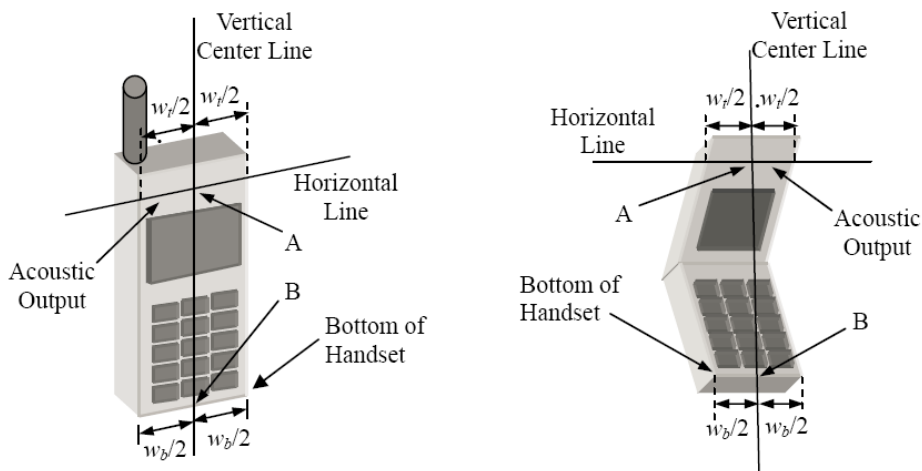

Fig. 9.2 Illustration for Handset Vertical and Horizontal Reference Lines

9.2. Positioning for Cheek / Touch

To position the device with the vertical center line of the body of the device and the horizontal line crossing the center piece in a plane parallel to the sagittal plane of the phantom. While maintaining the device in this plane, align the vertical center line with the reference plane containing the three ear and mouth reference point (M: Mouth, RE: Right Ear and LE: Left Ear) and align the center of the ear piece with the line RE-LE.

To move the device towards the phantom with the ear piece aligned with the line LE-RE until the phone touched the ear. While maintaining the device in the reference plane and maintaining the phone contact with the ear, move the bottom of the phone until any point on the front side is in contact with the cheek of the phantom or until contact with the ear is lost (see below figure)

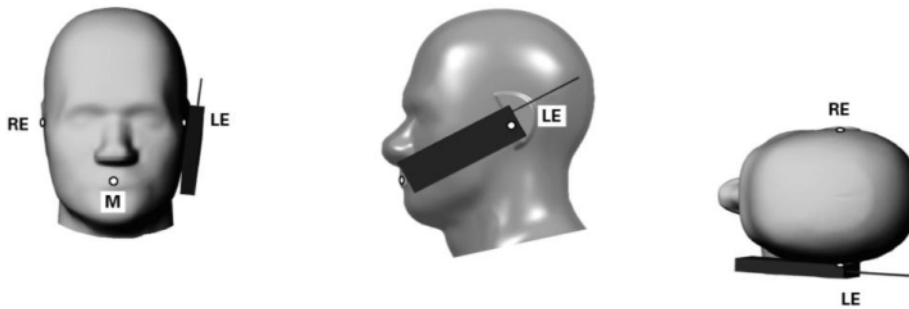

Fig 9.3 Illustration for Cheek Position

9.3. Positioning for Ear / 15° Tilt

To position the device in the “cheek” position described above.

While maintaining the device the reference plane described above and pivoting against the ear, moves it outward away from the mouth by an angle of 15 degrees or until contact with the ear is lost (see figure below).

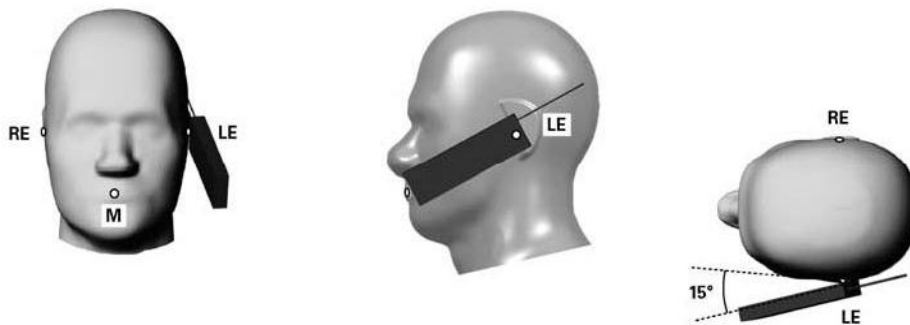

Fig 9.4 Illustration for Tilted Position

9.4. SAR Evaluations near the Mouth/Jaw Regions of the SAM Phantom

Antennas located near the bottom of a phone may require SAR measurements around the mouth and jaw regions of the SAM head phantom. This typically applies to clam-shell style phones that are generally longer in the unfolded normal use positions or to certain older style long rectangular phones.

Under these circumstances, the following procedures apply, adopted from the FCC guidance on SAR handsets document FCC KDB Publication 648474 D04v01r03. The SAR required in these regions of SAM should be measured using a flat phantom. The phone should be positioned with a separation distance of 4 mm between the ear reference point (ERP) and the outer surface of the flat phantom shell. While maintaining this distance at the ERP location, the low (bottom) edge of the phone should be lowered from the phantom to establish the same separation distance between the peak SAR locations identified by the truncated partial SAR distribution measured with the SAM phantom. The distance from the peak SAR location to the phone is determined by the straight line passing perpendicularly through the phantom surface. When it is not feasible to maintain 4 mm separation at the ERP while also establishing the required separation at the peak SAR location, the top edge of the phone will be allowed to touch the phantom with a separation < 4 mm at the ERP. The phone should not be tilted to the left or right while placed in this inclined position to the flat phantom.

9.5. Body-worn Configurations

The body-worn configurations shall be tested with the supplied accessories (belt-clips, holsters, etc.) attached to the device in normal use configuration.

For body-worn and other configurations a flat phantom shall be used which is comprised of material with electrical properties similar to the corresponding tissues.

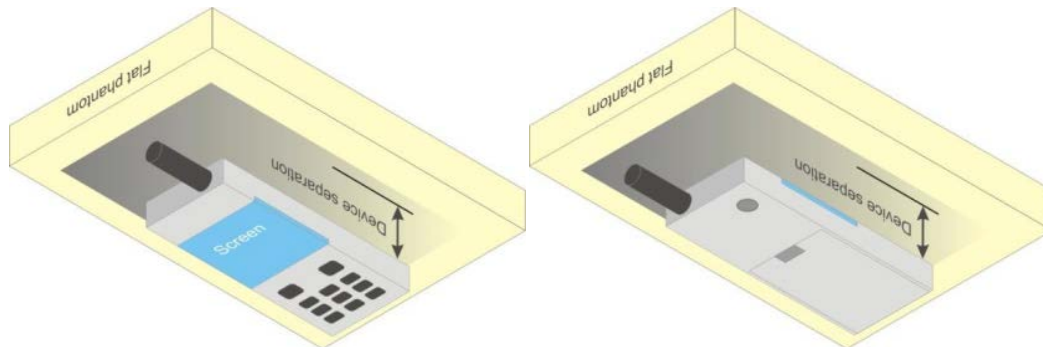

Fig 9.5 Illustration for Body Worn Position

9.6. Hotspot Mode Exposure Position Conditions

For handsets that support hotspot mode operations, with wireless router capabilities and various web browsing functions, the relevant hand and body exposure conditions are tested according to the hotspot SAR procedures in KDB 941225. A test separation distance of 10 mm is required between the phantom and all surfaces and edges with a transmitting antenna located within 25 mm from that surface or edge. When the form factor of a handset is smaller than 9 cm x 5 cm, a test separation distance of 5 mm (instead of 10 mm) is required for testing hotspot mode. When the separation distance required for body-worn accessory testing is larger than or equal to that tested for hotspot mode, in the same wireless mode and for the same surface of the phone, the hotspot mode SAR data may be used to support body-worn accessory SAR compliance for that particular configuration (surface).

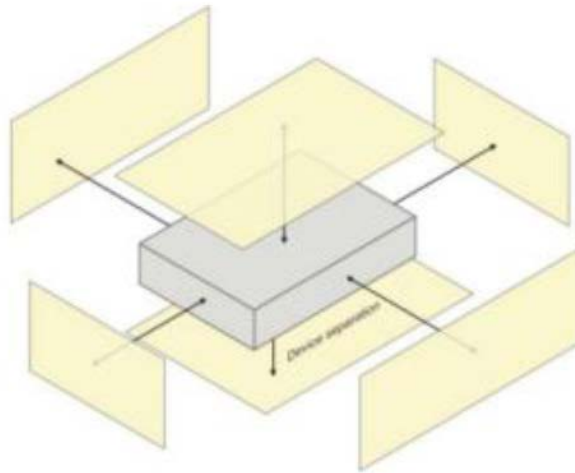

Fig 9.6 Illustration for Hotspot Position

10. Measurement Procedures

The measurement procedures are as follows:

<Conducted power measurement>

- (a) For WWAN power measurement, use base station simulator to configure EUT WWAN transmission in conducted connection with RF cable, at maximum power in each supported wireless interface and frequency band.
- (b) Read the WWAN RF power level from the base station simulator.
- (c) For WLAN/BT power measurement, use engineering software to configure EUT WLAN/BT continuously transmission, at maximum RF power in each supported wireless interface and frequency band
- (d) Connect EUT RF port through RF cable to the power meter, and measure WLAN/BT output power

<SAR measurement>

- (a) Use base station simulator to configure EUT WWAN transmission in radiated connection, and engineering software to configure EUT WLAN/BT continuously transmission, at maximum RF power, in the highest power channel
- (b) Place the EUT in the positions as Appendix D demonstrates.
- (c) Set scan area, grid size and other setting on the DASY software.
- (d) Measure SAR results for the highest power channel on each testing position.
- (e) Find out the largest SAR result on these testing positions of each band
- (f) Measure SAR results for other channels in worst SAR testing position if the reported SAR of highest power channel is larger than 0.8 W/kg



According to the test standard, the recommended procedure for assessing the peak spatial-average SAR value consists of the following steps:

- (a) Power reference measurement
- (b) Area scan
- (c) Zoom scan
- (d) Power drift measurement

10.1. Spatial Peak SAR Evaluation

The procedure for spatial peak SAR evaluation has been implemented according to the test standard. It can be conducted for 1g and 10g, as well as for user-specific masses. The DASY software includes all numerical procedures necessary to evaluate the spatial peak SAR value. The base for the evaluation is a "cube" measurement. The measured volume must include the 1g and 10g cubes with the highest averaged SAR values. For that purpose, the center of the measured volume is aligned to the interpolated peak SAR value of a previously performed area scan.

The entire evaluation of the spatial peak values is performed within the post-processing engine (SEMCAD). The system always gives the maximum values for the 1g and 10g cubes. The algorithm to find the cube with highest averaged SAR is divided into the following stages:

- (a) Extraction of the measured data (grid and values) from the Zoom Scan
- (b) Calculation of the SAR value at every measurement point based on all stored data (A/D values and measurement parameters)
- (c) Generation of a high-resolution mesh within the measured volume
- (d) Interpolation of all measured values from the measurement grid to the high-resolution grid
- (e) Extrapolation of the entire 3-D field distribution to the phantom surface over the distance from sensor to surface
- (f) Calculation of the averaged SAR within masses of 1g and 10g

10.2. Power Reference Measurement

The Power Reference Measurement and Power Drift Measurements are for monitoring the power drift of the device under test in the batch process. The minimum distance of probe sensors to surface determines the closest measurement point to phantom surface. This distance cannot be smaller than the distance of sensor calibration points to probe tip as defined in the probe properties.



10.3. Area Scan Procedures

Area scans are defined prior to the measurement process being executed with a user defined variable spacing between each measurement point (integral) allowing low uncertainty measurements to be conducted. Scans defined for FCC applications utilize a 10mm^2 step integral, with 1mm interpolation used to locate the peak SAR area used for zoom scan assessments.

When an Area Scan has measured all reachable points, it computes the field maxima founding the scanned area, within a range of the global maximum. The range (in dB) is specified in the standards for compliance testing. For example, a 2 dB range is required in IEEE1528-2003, EN 50361 and IEC 62209 standards, whereby 3 dB is a requirement when compliance is assessed in accordance with the ARIB standard (Japan).

10.4. Zoom Scan Procedures

Zoom Scans are used to assess the peak spatial SAR values within a cubic averaging volume containing 1 g and 10 g of simulated tissue. A density of 1000 kg/m^3 is used to represent the head and body tissue density and not the phantom liquid density, in order to be consistent with the definition of the liquid dielectric properties, i.e. the side length of the 1g cube is 10mm, with the side length of the 10 g cube 21,5mm. The zoom scan integer steps can be user defined so as to reduce uncertainty, but normal practice for typical test applications utilize a physical step of $5\text{x}5\text{x}7$ (8mmx8mmx5mm) providing a volume of 32mm in the X & Y axis, and 30mm in the Z axis.

10.5. SAR Averaged Methods

In DASy, the interpolation and extrapolation are both based on the modified Quadratic Sheppard's method. The interpolation scheme combines a least-square fitted function method and a weighted average method which are the two basic types of computational interpolation and approximation.

Extrapolation routines are used to obtain SAR values between the lowest measurement points and the inner phantom surface. The extrapolation distance is determined by the surface detection distance and the probe sensor offset. The uncertainty increases with the extrapolation distance. To keep the uncertainty within 1% for the 1 g and 10 g cubes, the extrapolation distance should not be larger than 5 mm.



10.6. Power Drift Monitoring

All SAR testing is under the DUT install full charged battery and transmit maximum output power. In DASY measurement software, the power reference measurement and power drift measurement procedures are used for monitoring the power drift of DUT during SAR test. Both these procedures measure the field at a specified reference position before and after the SAR testing. The software will calculate the field difference in dB. If the power drift more than 5%, the SAR will be retested.

11. SAR Test Procedure

11.1. General scan Requirements

Probe boundary effect error compensation is required for measurements with the probe tip closer than half a probe tip diameter to the phantom surface. Both the probe tip diameter and sensor offset distance must satisfy measurement protocols; to ensure probe boundary effect errors are minimized and the higher fields closest to the phantom surface can be correctly measured and extrapolated to the phantom surface for computing 1-g SAR. Tolerances of the post-processing algorithms must be verified by the test laboratory for the scan resolutions used in the SAR measurements, according to the reference distribution functions specified in IEEE Std 1528-2013.

		≤ 3 GHz	> 3 GHz	
Maximum distance from closest measurement point (geometric center of probe sensors) to phantom surface		5 mm \pm 1 mm	$\frac{1}{4} \cdot \delta \cdot \ln(2)$ mm \pm 0.5 mm	
Maximum probe angle from probe axis to phantom surface normal at the measurement location		30° \pm 1°	20° \pm 1°	
Maximum area scan spatial resolution: Δx_{Area} , Δy_{Area}		≤ 2 GHz: ≤ 15 mm 2 – 3 GHz: ≤ 12 mm	3 – 4 GHz: ≤ 12 mm 4 – 6 GHz: ≤ 10 mm	
		When the x or y dimension of the test device, in the measurement plane orientation, is smaller than the above, the measurement resolution must be \leq the corresponding x or y dimension of the test device with at least one measurement point on the test device.		
Maximum zoom scan spatial resolution: Δx_{Zoom} , Δy_{Zoom}		≤ 2 GHz: ≤ 8 mm 2 – 3 GHz: ≤ 5 mm*	3 – 4 GHz: ≤ 5 mm* 4 – 6 GHz: ≤ 4 mm*	
Maximum zoom scan spatial resolution, normal to phantom surface	uniform grid: $\Delta z_{Zoom}(n)$	≤ 5 mm	3 – 4 GHz: ≤ 4 mm 4 – 5 GHz: ≤ 3 mm 5 – 6 GHz: ≤ 2 mm	
	graded grid	$\Delta z_{Zoom}(1)$: between 1 st two points closest to phantom surface	≤ 4 mm	3 – 4 GHz: ≤ 3 mm 4 – 5 GHz: ≤ 2.5 mm 5 – 6 GHz: ≤ 2 mm
		$\Delta z_{Zoom}(n>1)$: between subsequent points	$\leq 1.5 \cdot \Delta z_{Zoom}(n-1)$ mm	
Minimum zoom scan volume	x, y, z	≥ 30 mm	3 – 4 GHz: ≥ 28 mm 4 – 5 GHz: ≥ 25 mm 5 – 6 GHz: ≥ 22 mm	
Note: δ is the penetration depth of a plane-wave at normal incidence to the tissue medium; see IEEE Std 1528-2013 for details. * When zoom scan is required and the reported SAR from the area scan based 1-g SAR estimation procedures of KDB Publication 447498 is ≤ 1.4 W/kg, ≤ 8 mm, ≤ 7 mm and ≤ 5 mm zoom scan resolution may be applied, respectively, for 2 GHz to 3 GHz, 3 GHz to 4 GHz and 4 GHz to 6 GHz.				

11.2. Test procedure

The Following steps are used for each test position

1. Establish a call with the maximum output power with a base station simulator. The connection between the mobile and the base station simulator is established via air interface.
2. Measurement of the local E-field value at a fixed location. This value serves as a reference value for calculating a possible power drift.
3. Measurement of the SAR distribution with a grid of 8 to 16mm * 8 to 16 mm and a constant distance to the inner surface of the phantom. Since the sensors cannot directly measure at the inner phantom surface, the values between the sensors and the inner phantom surface are extrapolated. With these values the area of the maximum SAR is calculated by an interpolation scheme.
4. Around this point, a cube of 30 * 30 * 30 mm or 32 * 32 * 32 mm is assessed by measuring 5 or 8 * 5 or 8*4 or 5 mm. With these data, the peak spatial-average SAR value can be calculated.

11.3. Description of interpolation/extrapolation scheme

The local SAR inside the phantom is measured using small dipole sensing elements inside a probe body. The probe tip must not be in contact with the phantom surface in order to minimize measurements errors, but the highest local SAR will occur at the surface of the phantom.

An extrapolation is using to determinate this highest local SAR values. The extrapolation is based on a fourth-order least-square polynomial fit of measured data. The local SAR value is then extrapolated from the liquid surface with a 1mm step.

The measurements have to be performed over a limited time (due to the duration of the battery) so the step of measurement is high. It could vary between 5 and 8 mm. To obtain an accurate assessment of the maximum SAR averaged over 10 grams and 1 gram requires a very fine resolution in the three dimensional scanned data array.



11.4. Wireless Router

Some battery-operated handsets have the capability to transmit and receive user through simultaneous transmission of WIFI simultaneously with a separate licensed transmitter. The FCC has provided guidance in FCC KDB Publication 941225 D06 v02r01 where SAR test considerations for handsets ($L \times W \geq 9 \text{ cm} \times 5 \text{ cm}$) are based on a composite test separation distance of 10 from the front, back and edges of the device containing transmitting antennas within 2.5cm of their edges, determined from general mixed use conditions for this type of devices. Since the hotspot SAR results may overlap with the body-worn accessory SAR requirements, the more conservative configurations can be considered, thus excluding some body-worn accessory SAR tests.

When the user enables the personal wireless router functions for the handset, actual operations include simultaneous transmission of both the WIFI transmitter and another licensed transmitter. Both transmitters often do not transmit at the same transmitting frequency and thus cannot be evaluated for SAR under actual use conditions due to the limitations of the SAR assessment probes. Therefore, SAR must be evaluated for each frequency transmission and mode separately and spatially summed with the WIFI transmitter according to FCC KDB Publication 447498 D01v06 publication procedures. The "Portable Hotspot" feature on the handset was NOT activated during SAR assessments, to ensure the SAR measurements were evaluated for a single transmission frequency RF signal at a time.



12. SAR Test Configuration

<GSM Mode>

A summary of these settings are illustrated below:

For GSM850 frequency band, the power control is set to 5 for GSM/GPRS mode (GSMK-CS1) and set to 8 for EDGE mode (MCS5); For GSM1900 frequency band, the power control is set to 0 for GSM/GPRS mode (GSMK-CS1) and set to 2 for EDGE mode (MCS5)

1. Per KDB 447498 D01v06, the maximum output power channel is used for SAR testing and for further SAR test reduction.
2. Per KDB 941225 D01v03r01, SAR test reduction for GSM / GPRS / EDGE modes is determined by the source-based time-averaged output power including tune-up tolerance. The mode with highest specified time-averaged output power should be tested for SAR compliance in the applicable exposure conditions. For modes with the same specified maximum output power and tolerance, the higher number time-slot configuration should be tested. Therefore, the GPRS (4Tx slots) for GSM850/GSM1900 is considered as the primary mode.
3. Other configurations of GSM / GPRS / EDGE are considered as secondary modes.

Timeslot consignations:

Remark:

1. The frame-averaged power is linearly reported the maximum burst averaged power over 8 time slots. The calculated method are shown as below:

The duty cycle "x" of different time slots as below:

1 TX slot is 1/8, 2 TX slots is 2/8, 3 TX slots is 3/8 and 4 TX slots is 4/8

Based on the calculation formula:

Frame-averaged power = Burst averaged power + 10 log (x)

So,

Frame-averaged power (1 TX slot) = Burst averaged power (1 TX slot) – 9.03

Frame-averaged power (2 TX slots) = Burst averaged power (2 TX slots) – 6.02

Frame-averaged power (3 TX slots) = Burst averaged power (3 TX slots) – 4.26

Frame-averaged power (4 TX slots) = Burst averaged power (4 TX slots) – 3.01

2. CS1 coding scheme was used in GPRS conducted power measurements and SAR testing, MCS5 coding scheme was used in EGPRS conducted power measurements and SAR testing (if necessary).

No. of Slots:	Slot 1	Slot 2	Slot 3	Slot 4
Slot Consignation:	1Up4Down	2Up3Down	3Up2Down	4Up1Down
Duty Cycle:	1:8.3	1:4.15	1:2.77	1:2.08
Correct Factor:	-9.03dB	-6.02dB	-4.26dB	-3.01dB



<WCDMA Mode>

Summary of UMTS conducted power measurement:

1. The 3G SAR test reduction procedure is applied, when the maximum output power and tune-up tolerance specified for production units in a secondary mode is $\leq \frac{1}{4}$ dB higher than the primary mode, SAR measurement is not required for the secondary mode.
2. The following tests were conducted according to the test requirements outlines in 3GPP TS 34.121 specification.
3. The procedures in KDB 941225 D01v03r01 are applied for 3GPP Rel. 6 HSPA to configure the device in the required sub-test mode(s) to determine SAR test exclusion.
4. For HSPA+ devices supporting 16 QAM in the uplink, power measurements procedure is according to the configurations in Table C.11.1.4 of 3GPP TS 34.121-1.
5. Per KDB 941225 D01v03r01, RMC 12.2kbps setting is used to evaluate SAR. The maximum output power and tune-up tolerance specified for production units in HSDPA / HSUPA / DC-HSDPA / HSPA+ is $\leq \frac{1}{4}$ dB higher than RMC 12.2Kbps or when the highest reported SAR of the RMC12.2Kbps is scaled by the ratio of specified maximum output power and tune-up tolerance of HSDPA / HSUPA / DC-HSDPA / HSPA+ to RMC12.2Kbps and the adjusted SAR is ≤ 1.2 W/kg, SAR measurement is not required for HSDPA / HSUPA / DC-HSDPA / HSPA+, and according to the following RF output power, the output power results of the secondary modes (HSDPA / HSUPA / DC-HSDPA / HSPA+) are less than $\frac{1}{4}$ dB higher than the primary modes; therefore, SAR measurement is not required for HSDPA / HSUPA / DC-HSDPA / HSPA+.
6. A fixed level power reduction is applied for WCDMA Band II when handset open Hotspot mode, the power reduction triggered.

HSDPA Setup Configuration:

Sub-test	β_c	β_d	β_d (SF)	β_c/β_d	$\beta_{hs}^{(1)}$	CM (dB) ⁽²⁾
1	2/15	15/15	64	2/15	4/15	0.0
2	12/15 ⁽³⁾	15/15 ⁽³⁾	64	12/15 ⁽³⁾	24/15	1.0
3	15/15	8/15	64	15/8	30/15	1.5
4	15/15	4/15	64	15/4	30/15	1.5

Note 1: $\Delta_{ACK}, \Delta_{NACK}$ and $\Delta_{CQI} = 8 \Leftrightarrow A_{hs} = \beta_{hs}/\beta_c = 30/15 \Leftrightarrow \beta_{hs} = 30/15 * \beta_c$
 Note 2: CM = 1 for $\beta_c/\beta_d = 12/15, \beta_{hs}/\beta_c = 24/15$.
 Note 3: For subtest 2 the β_c/β_d ratio of 12/15 for the TFC during the measurement period (TF1, TF0) is achieved by setting the signaled gain factors for the reference TFC (TF1, TF1) to $\beta_c = 11/15$ and $\beta_d = 15/15$.

HSUPA Setup Configuration:

Sub-test	β_c	β_d	β_d (SF)	β_c/β_d	$\beta_{hs}^{(1)}$	β_{ec}	β_{ed}	β_{ed} (SF)	β_{ed} (codes)	CM ⁽²⁾ (dB)	MPR (dB)	AG ⁽⁴⁾ Index	E-TFCI
1	11/15 ⁽³⁾	15/15 ⁽³⁾	64	11/15 ⁽³⁾	22/15	209/225	1039/225	4	1	1.0	0.0	20	75
2	6/15	15/15	64	6/15	12/15	12/15	94/75	4	1	3.0	2.0	12	67
3	15/15	9/15	64	15/9	30/15	30/15	$\beta_{ed1}: 47/15$ $\beta_{ed2}: 47/15$	4	2	2.0	1.0	15	92
4	2/15	15/15	64	2/15	4/15	2/15	56/75	4	1	3.0	2.0	17	71
5	15/15 ⁽⁴⁾	15/15 ⁽⁴⁾	64	15/15 ⁽⁴⁾	30/15	24/15	134/15	4	1	1.0	0.0	21	81

Note 1: $\Delta_{ACK}, \Delta_{NACK}$ and $\Delta_{CQI} = 8 \Leftrightarrow A_{hs} = \beta_{hs}/\beta_c = 30/15 \Leftrightarrow \beta_{hs} = 30/15 * \beta_c$.

Note 2: CM = 1 for $\beta_c/\beta_d = 12/15, \beta_{hs}/\beta_c = 24/15$. For all other combinations of DPDCH, DPCCH, HS-DPCCH, E-DPDCH and E-DPCCH the MPR is based on the relative CM difference.

Note 3: For subtest 1 the β_c/β_d ratio of 11/15 for the TFC during the measurement period (TF1, TF0) is achieved by setting the signaled gain factors for the reference TFC (TF1, TF1) to $\beta_c = 10/15$ and $\beta_d = 15/15$.

Note 4: For subtest 5 the β_c/β_d ratio of 15/15 for the TFC during the measurement period (TF1, TF0) is achieved by setting the signaled gain factors for the reference TFC (TF1, TF1) to $\beta_c = 14/15$ and $\beta_d = 15/15$.

Note 5: Testing UE using E-DPDCH Physical Layer category 1 Sub-test 3 is not required according to TS 25.306 Table 5.1g.

Note 6: β_{ed} cannot be set directly; it is set by Absolute Grant Value.

HSPA+ 3GPP release 7 (uplink category 7) 16QAM, Setup Configuration:
Table C.11.1.4: β values for transmitter characteristics tests with HS-DPCCH and E-DCH with 16QAM

Sub-test	β_c (Note 3)	β_d	β_{hs} (Note 1)	β_{ec}	β_{ed} (2xSF2) (Note 4)	β_{ed} (2xSF4) (Note 4)	CM (dB) (Note 2)	MPR (dB) (Note 2)	AG Index (Note 4)	E-TFCI (Note 5)	E-TFCI (boost)
1	1	0	30/15	30/15	$\beta_{ed1}: 30/15$ $\beta_{ed2}: 30/15$	$\beta_{ed3}: 24/15$ $\beta_{ed4}: 24/15$	3.5	2.5	14	105	105

Note 1: $\Delta_{ACK}, \Delta_{NACK}$ and $\Delta_{CQI} = 30/15$ with $\beta_{hs} = 30/15 * \beta_c$.

Note 2: CM = 3.5 and the MPR is based on the relative CM difference, MPR = MAX(CM-1,0).

Note 3: DPDCH is not configured, therefore the β_c is set to 1 and $\beta_d = 0$ by default.

Note 4: β_{ed} can not be set directly; it is set by Absolute Grant Value.

Note 5: All the sub-tests require the UE to transmit 2SF2+2SF4 16QAM EDCH and they apply for UE using E-DPDCH category 7. E-DCH TTI is set to 2ms TTI and E-DCH table index = 2. To support these E-DCH configurations DPDCH is not allocated. The UE is signaled to use the extrapolation algorithm.

DC-HSDPA Setup Configuration:

The following tests were completed according to procedures in section 7.3.13 of 3GPP TS34.108 v9.5.0. A summary of these settings are illustrated below:

Downlink Physical Channels are set as per 3GPP TS34.121-1 v9.0.0 E.5.

Table E.5.0: Levels for HSDPA connection setup

Parameter During Connection setup	Unit	Value
P-CPICH_Ec/lor	dB	-10
P-CCPCH and SCH_Ec/lor	dB	-12
PICH_Ec/lor	dB	-15
HS-PDSCH	dB	off
HS-SCCH_1	dB	off
DPCH_Ec/lor	dB	-5
OCNS_Ec/lor	dB	-3.1

Call is set up as per 3GPP TS34.108 v9.5.0 sub clause 7.3.13

The configurations of the fixed reference channels for HSDPA RF tests are described in 3GPP TS 34.121, annex C for FDD and 3GPP TS 34.122.

Table C.8.1.12: Fixed Reference Channel H-Set 12

Parameter	Unit	Value
Nominal Avg. Inf. Bit Rate	kbps	60
Inter-TTI Distance	TTI's	1
Number of HARQ Processes	Processes	6
Information Bit Payload (N_{INF})	Bits	120
Number Code Blocks	Blocks	1
Binary Channel Bits Per TTI	Bits	960
Total Available SML's in UE	SML's	19200
Number of SML's per HARQ Proc.	SML's	3200
Coding Rate		0.15
Number of Physical Channel Codes	Codes	1
Modulation		QPSK
Note 1: The RMC is intended to be used for DC-HSDPA mode and both cells shall transmit with identical parameters as listed in the table. Note 2: Maximum number of transmission is limited to 1, i.e., retransmission is not allowed. The redundancy and constellation version 0 shall be used.		



CCC

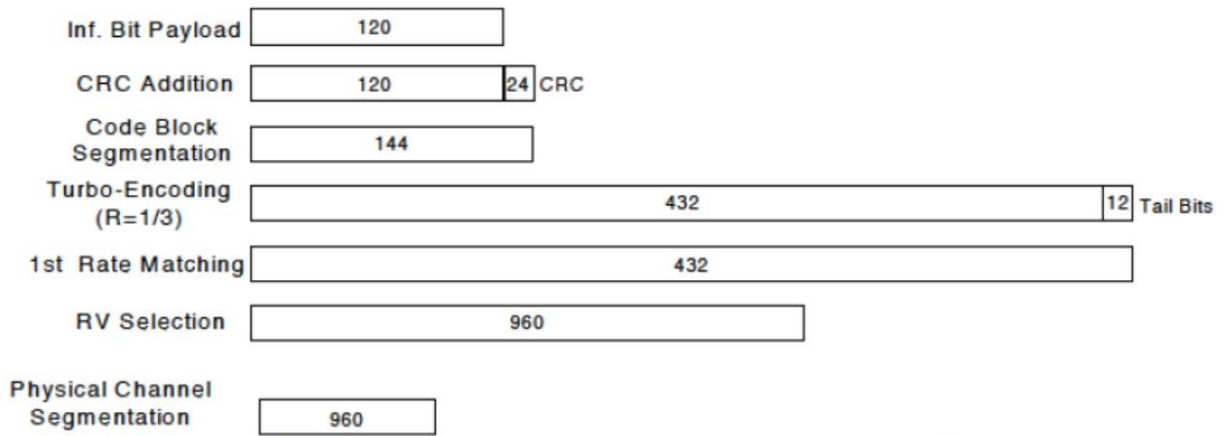

Figure C.8.19: Coding rate for Fixed reference Channel H-Set 12 (QPSK)



<CDMA Mode>

1xEV-DO Rev. B

Call box setup procedure

1xEV-DO Release B

1> CMW 500 Signal Generator > 1xEV-DO Taskbar Enable

2> CMW 500 1xEV-DO Signaling Configuration Window >

3> 1xEV-DO Signaling On Window:

Under Access Network Control:

Band Class: BC0: US Cellular

RF Channel: 31

1xEV-DO Power: -70 dBm

4> 1xEV-DO Signaling Configuration Window

Under RF Frequency Band / Channel: Enter Ch. Frequency

- Under Carrier Configuration: RF Frequency
For Two Carriers: Low Channel (1013)

	<u>RF Channel</u>	<u>RF Channel Offset</u>
Carrier [0]	31	0
Carrier [1]	1013	982

- Under Carrier Configuration: RF Pilot
- | | <u>Carrier Sector</u> | <u>Active on AN</u> | <u>Assigned to AT</u> |
|-----------|-----------------------|---------------------|-----------------------|
| Pilot [0] | C0/S0 | ✓ | ✓ |
| | CA/S1 | ✓ | ✓ |

For Three Carriers: Low Channel (1013)

	<u>RF Channel</u>	<u>RF Channel Offset</u>
Carrier [0]	72	0
Carrier [1]	31	-41
Carrier [2]	1013	941

- Under Carrier Configuration: RF Pilot
- | | <u>Carrier Sector</u> | <u>Active on AN</u> | <u>Assigned to AT</u> |
|-----------|-----------------------|---------------------|-----------------------|
| Pilot [0] | C0/S0 | ✓ | ✓ |
| Pilot [1] | C1/S1 | ✓ | ✓ |
| Pilot [2] | C2/S2 | ✓ | ✓ |



<LTE Mode>

LTE Target MPR level

The device implements maximum power reduction per 3GPP 36.101 requirements where the MPR target is as below table. The MPR settings are implemented configured into firmware and cannot be disabled by the end user or LTE carrier network.

Modulation	Channel bandwidth / Transmission bandwidth configuration [RB]						MPR	3GPP
	1.4	3.0	5	10	15	20	Target	MPR
	MHz	MHz	MHz	MHz	MHz	MHz	(dB)	(dB)
QPSK	> 5	> 4	> 8	> 12	> 16	> 18	1	≤ 1
16 QAM	≤ 5	≤ 4	≤ 8	≤ 12	≤ 16	≤ 18	1	≤ 1
64 QAM	> 5	> 4	> 8	> 12	> 16	> 18	2	≤ 2

Note: The measurement result showed some difference from the target MPR level, due to expected 0.5dB measurement tolerance

LTE Bands

LTE Bands	Channel bandwidth / Transmission bandwidth configuration [RB]					
	1.4	3.0	5	10	15	20
	MHz	MHz	MHz	MHz	MHz	MHz
2	v	v	v	v	v	v
4	v	v	v	v	v	v
5	v	v	v	v	N/A	N/A
7	N/A	N/A	v	v	v	v
12	v	v	v	v	N/A	N/A
17	N/A	N/A	v	v	N/A	N/A
18	N/A	v	v	v	v	N/A
19	N/A	v	v	v	v	N/A
25	v	v	v	v	v	v
26	v	v	v	v	v	N/A
30	N/A	N/A	v	v	N/A	N/A
38	N/A	N/A	v	v	v	v
40	N/A	N/A	v	v	v	v
41	N/A	N/A	v	v	v	v
66	v	v	v	v	v	v

Note:

- Per KDB 941225 D05v02r05, when a properly configured base station simulator is used for the SAR and power measurements, spectrum plots for each RB allocation and offset configuration is not required.



2. Per KDB 941225 D05v02r05, start with the largest channel bandwidth and measure SAR for QPSK with 1 RB allocation, using the RB offset and required test channel combination with the highest maximum output power for RB offsets at the upper edge, middle and lower edge of each required test channel.
3. Per KDB 941225 D05v02r05, 50% RB allocation for QPSK SAR testing follows 1RB QPSK allocation procedure.
4. Per KDB 941225 D05v02r05, for QPSK with 100% RB allocation, SAR is not required when the highest maximum output power for 100 % RB allocation is less than the highest maximum output power in 50% and 1 RB allocations and the highest reported SAR for 1 RB and 50% RB allocation are ≤ 0.8 W/kg. Otherwise, SAR is measured for the highest output power channel; and if the reported SAR is > 1.45 W/kg, the remaining required test channels must also be tested.
5. Per KDB 941225 D05v02r05, 16QAM/64QAM output power for each RB allocation configuration is $>$ not $\frac{1}{2}$ dB higher than the same configuration in QPSK and the reported SAR for the QPSK configuration is ≤ 1.45 W/kg; Per KDB941225 D05v02r05, 16QAM/64QAM SAR testing is not required.
6. Per KDB 941225 D05v02r05, smaller bandwidth output power for each RB allocation configuration is $>$ not $\frac{1}{2}$ Db higher than the same configuration in the largest supported bandwidth, and the reported SAR for the largest supported band width is ≤ 1.45 W/kg; Per KDB 941225 D05v02r05, smaller bandwidth SAR testing is not required.
7. For LTE B4 / B5 / B7 / B17 the maximum bandwidth does not support three non-overlapping channels, per KDB941225 D05v02r05, when a device supports overlapping channel assignment in a channel bandwidth configuration, the middle channel of the group of overlapping channels should be selected for testing.
8. LTE band 2 / 12 SAR test was covered by Band 25 / 17; according to April 2015 TCB workshop, SAR test for overlapping LTE bands can be reduced if
 - a. the maximum output power, including tolerance, for the smaller band is \leq the larger band to qualify for the SAR test exclusion.
 - b. the channel bandwidth and other operating parameters for the smaller band are fully supported by the larger band.
9. According to 2017 TCB workshop, for 64 QAM and 16 QAM should be verified by checking the signal constellation with a call box to avoid incorrect maximum power levels due to MPR and other requirements associated with signal modulation, and the following figure is taken from the "Fundamental Measurement >> Modulation Analysis >>constellation" mode of the device connect to the CMW500 base station, therefore, the device 64QAM and 16QAMsignal modulation are correct. Identify if Maximum Power Reduction (MPR) is optional or mandatory, i.e. built-in by design: only mandatory MPR may be considered during SAR testing, when the maximum output power is permanently limited by the MPR implemented within the UE; and only for the applicable RB (resource block) configurations specified in LTE standards: b)



A-MPR (additional MPR) must be disabled.

10. Per KDB 447498 D01v06, the reported SAR is the measured SAR value adjusted for maximum tune-up tolerance.
 - a. Tune-up scaling Factor = tune-up limit power (mW) / EUT RF power (mW), where tune-up limit is the maximum rated power among all production units.
 - b. For SAR testing of WLAN signal with non-100% duty cycle, the measured SAR is scaled-up by the duty cycle scaling factor which is equal to "1/(duty cycle)"
 - c. For WWAN: Reported SAR(W/kg)= Measured SAR(W/kg)*Tune-up Scaling Factor
 - d. For WLAN/Bluetooth: Reported SAR(W/kg)= Measured SAR(W/kg)* Duty Cycle scaling factor * Tune-up scaling factor
 - e. For TDD LTE SAR measurement, the duty cycle 1:1.59 (62.9 %) was used perform testing and considering the theoretical duty cycle of 63.3% for extended cyclic prefix in the uplink, and the theoretical duty cycle of 62.9% for normal cyclic prefix in uplink, a scaling factor of extended cyclic prefix $63.3\%/62.9\% = 1.006$ is applied to scale-up the measured SAR result. The Reported TDD LTE SAR = measured SAR (W/kg)* Tune-up Scaling Factor* scaling factor for extended cyclic prefix.
11. Per KDB 447498 D01v06, for each exposure position, testing of other required channels within the operating mode of a frequency band is not required when the reported 1-g or 10-g SAR for the mid-band or highest output power channel is: ≤ 0.8 W/kg or 2.0 W/kg, for 1-g or 10-g respectively, when the transmission band is ≤ 100 MHz ≤ 0.6 W/kg or 1.5 W/kg, for 1-g or 10-g respectively, when the transmission band is between 100 MHz and 200 MHz ≤ 0.4 W/kg or 1.0 W/kg, for 1-g or 10-g respectively, when the transmission band is ≥ 200 MHz
12. Per KDB 865664 D01v01r04, for each frequency band, repeated SAR measurement is required only when the measured SAR is ≥ 0.8 W/kg.
13. Per KDB 648474 D04v01r03, when the reported SAR for a body-worn accessory measured without a headset connected to the handset is ≤ 1.2 W/kg, SAR testing with a headset connected to the handset is not required.

<WLAN 2.4GHz>

1. SAR is measured for 2.4 GHz 802.11b DSSS using either the fixed test position or, when applicable, the initial test position procedure. SAR test reduction is determined according to the following:
 - 1) When the reported SAR of the highest measured maximum output power channel for the exposure configuration is ≤ 0.8 W/kg, no further SAR testing is required for 802.11b DSSS in that exposure configuration.
 - 2) When the reported SAR is > 0.8 W/kg, SAR is required for that position using the next highest measured output power channel. When any reported SAR is > 1.2 W/kg, SAR is required for the third channel; i.e., all channels require testing.
2. 2.4 GHz 802.11 g/n OFDM are additionally evaluated for SAR if the highest reported SAR for 802.11b, adjusted by the ratio of the OFDM to DSSS specified maximum output power, is > 1.2



W/kg. When SAR is required for OFDM modes in 2.4 GHz band, the Initial Test Configuration Procedures should be followed.

3. For held-to-ear and hotspot operations, the initial test position procedures were applied. The test position with the highest extrapolated peak SAR will be used as the initial test position. When reported SAR for the initial test position is ≤ 0.4 W/kg, no additional testing for the remaining test positions was required. Otherwise, SAR is evaluated at the subsequent highest peak SAR positions until the reported SAR result is ≤ 0.8 W/kg or all test positions are measured.
4. Justification for test configurations for WLAN per KDB Publication 248227 D02DR02-41929 for 2.4 GHz WI-FI single transmission chain operations, the highest measured maximum output power channel for DSSS was selected for SAR measurement. SAR for OFDM modes (2.4 GHz 802.11g/n) was not required due to the maximum allowed powers and the highest reported DSSS SAR.
5. A fixed level power reduction is applied for WiFi when handset operates "held to the body" condition or "held to the ear" condition, the power reduction triggered by audio receiver detection and call establish status.
6. Per KDB 248227 D01v02r02, In the 2.4 GHz band, separate SAR procedures are applied to DSSS and OFDM configurations to simplify DSSS test requirements. SAR is not required for the following 2.4 GHz OFDM conditions:
 - 1) When KDB Publication 447498 SAR test exclusion applies to the OFDM configuration.
 - 2) When the highest reported SAR for DSSS is adjusted by the ratio of OFDM to DSSS specified maximum output power and the adjusted SAR is ≤ 1.2 W/kg.

<WLAN 5GHz>

A) U-NII-1 and U-NII-2A Bands

For devices that operate in only one of the U-NII-1 and U-NII-2A bands, the normally required SAR procedures for OFDM configurations are applied. For devices that operate in both U-NII bands using the same transmitter and antenna(s), SAR test reduction is determined according to the following:

- 1) When the same maximum output power is specified for both bands, begin SAR measurement in U-NII-2A band by applying the OFDM SAR requirements. If the highest reported SAR for a test configuration is ≤ 1.2 W/kg, SAR is not required for U-NII-1 band for that configuration (802.11 mode and exposure condition); otherwise, both bands are tested independently for SAR.
- 2) When different maximum output power is specified for the bands, begin SAR measurement in the band with higher specified maximum output power. The highest reported SAR for the tested configuration is adjusted by the ratio of lower to higher specified maximum output power for the two bands. When the adjusted SAR is ≤ 1.2 W/kg, SAR is not required for the band with lower maximum output power in that test configuration; otherwise, both bands are tested independently for SAR.
- 3) The two U-NII bands may be aggregated to support a 160 MHz channel on channel number 50.



Without additional testing, the maximum output power for this is limited to the lower of the maximum output power certified for the two bands. When SAR measurement is required for at least one of the bands and the highest reported SAR adjusted by the ratio of specified maximum output power of aggregated to standalone band is > 1.2 W/kg, SAR is required for the 160 MHz channel. This procedure does not apply to an aggregated band with maximum output higher than the standalone band(s); the aggregated band must be tested independently for SAR. SAR is not required when the 160 MHz channel is operating at a reduced maximum power and also qualifies for SAR test exclusion.

B)U-NII-2C and U-NII-3 Bands

The frequency range covered by these bands is 380 MHz (5.47 – 5.85 GHz), which requires a minimum of at least two SAR probe calibration frequency points to support SAR measurements. when Terminal Doppler Weather Radar (TDWR) restriction applies, all channels that operate at 5.60 – 5.65 GHz must be included to apply the SAR test reduction and measurement procedures. When the same transmitter and antenna(s) are used for U-NII-2C band and U-NII-3 band or 5.8 GHz band of §15.247, the bands may be aggregated to enable additional channels with 20, 40 or 80 MHz bandwidth to span across the band gap, as illustrated in Appendix B. The maximum output power for the additional band gap channels is limited to the lower of those certified for the bands. Unless band gap channels are permanently disabled, they must be considered for SAR testing. The frequency range covered by these bands is 380 MHz (5.47 – 5.85 GHz), which requires a minimum of at least two SAR probe calibration frequency points to support SAR measurements. To maintain SAR measurement accuracy and to facilitate test reduction, the channels in U-NII-2C band above 5.65 GHz may be grouped with the 5.8 GHz channels in U-NII-3 or §15.247 band to enable two SAR probe calibration frequency points to cover the bands, including the band gap channels. When band gap channels are supported and the bands are not aggregated for SAR testing, band gap channels must be considered independently in each band according to the normally required OFDM SAR measurement and probe calibration frequency points requirements.

C)OFDM Transmission Mode SAR Test Configuration and Channel Selection Requirements

The initial test configuration for 5 GHz OFDM transmission modes is determined by the 802.11 configuration with the highest maximum output power specified for production units, including tune-up tolerance, in each standalone and aggregated frequency band. SAR for the initial test configuration is measured using the highest maximum output power channel determined by the default power measurement procedures. When multiple configurations in a frequency band have the same specified maximum output power, the initial test configuration is determined according to the following steps applied sequentially.

- 1)The largest channel bandwidth configuration is selected among the multiple configurations with the same specified maximum output power.
- 2)If multiple configurations have the same specified maximum output power and largest channel bandwidth, the lowest order modulation among the largest channel bandwidth configurations is selected.



3) If multiple configurations have the same specified maximum output power, largest channel bandwidth and lowest order modulation, the lowest data rate configuration among these configurations is selected.

4) When multiple transmission modes (802.11a/g/n/ac) have the same specified maximum output power, largest channel bandwidth, lowest order modulation and lowest data rate, the lowest order 802.11 mode is selected; i.e., 802.11a is chosen over 802.11n then 802.11ac or 802.11g is chosen over 802.11n. After an initial test configuration is determined, if multiple test channels have the same measured maximum output power, the channel chosen for SAR measurement is determined according to the following. These channel selection procedures apply to both the initial test configuration and subsequent test configuration(s), with respect to the default power measurement procedures or additional power measurements required for further SAR test reduction. The same procedures also apply to subsequent highest output power channel(s) selection.

1) The channel closest to mid-band frequency is selected for SAR measurement.

2) For channels with equal separation from mid-band frequency; for example, high and low channels or two mid-band channels, the higher frequency (number) channel is selected for SAR measurement.

D) SAR Test Requirements for OFDM configurations

When SAR measurement is required for 802.11 a/n/ac OFDM configurations, each standalone and frequency aggregated band is considered separately for SAR test reduction. When the same transmitter and antenna(s) are used for U-NII-1 and U-NII-2A bands, additional SAR test reduction V applies. When band gap channels between U-NII-2C band and 5.8 GHz U-NII-3 or §15.247 band are supported, the highest maximum output power transmission mode configuration and maximum output power channel across the bands must be used to determine SAR test reduction, according to the initial test configuration and subsequent test configuration requirements. In applying the initial test configuration and subsequent test configuration procedures, the 802.11 transmission configuration with the highest specified maximum output power and the channel within a test configuration with the highest measured maximum output power should be clearly distinguished to apply the procedures.

13. Conducted RF Output Power

13.1. Full Power

➤ GSM Conducted Power

GSM850	Burst Average Power (dBm)			Tune-up Limit (dBm)	Frame-Average Power (dBm)			Tune-up Limit (dBm)
	TX Channel	128	189		251	128	189	
Frequency (MHz)	824.2	836.4	848.8		824.2	836.4	848.8	
GSM 1 Tx slot	33.05	33.17	33.32	33.50	24.05	24.17	24.32	24.50
GPRS 1 Tx slot	33.07	33.15	33.32	33.50	24.07	24.15	24.32	24.50
GPRS 2 Tx slots	30.34	30.43	30.42	30.50	24.34	24.43	24.42	24.50
GPRS 3 Tx slots	28.59	28.53	28.56	29.00	24.33	24.27	24.30	24.74
GPRS 4 Tx slots	26.64	26.62	26.81	27.00	23.64	23.62	23.81	24.00
EDGE 1 Tx slot	27.39	27.40	27.46	27.50	18.39	18.40	18.46	18.50
EDGE 2 Tx slots	23.76	23.79	23.91	24.00	17.76	17.79	17.91	18.00
EDGE 3 Tx slots	21.58	21.68	21.72	22.00	17.32	17.42	17.46	17.74
EDGE 4 Tx slots	20.51	20.57	20.64	21.00	17.51	17.57	17.64	18.00

GSM1900	Burst Average Power (dBm)			Tune-up Limit (dBm)	Frame-Average Power (dBm)			Tune-up Limit (dBm)
	TX Channel	512	661		810	512	661	
Frequency (MHz)	1850.2	1880	1909.8		1850.2	1880	1909.8	
GSM 1 Tx slot	27.67	27.55	27.76	28.00	18.67	18.55	18.76	19.00
GPRS 1 Tx slot	27.53	27.64	27.79	28.00	18.53	18.64	18.79	19.00
GPRS 2 Tx slots	24.88	25.15	25.02	25.50	18.88	19.15	19.02	19.50
GPRS 3 Tx slots	22.29	22.48	22.41	22.50	18.03	18.22	18.15	18.24
GPRS 4 Tx slots	20.67	20.78	20.75	21.00	17.67	17.78	17.75	18.00
EDGE 1 Tx slot	26.49	26.60	26.80	27.00	17.49	17.60	17.80	18.00
EDGE 2 Tx slots	24.92	24.94	24.97	25.00	18.92	18.94	18.97	19.00
EDGE 3 Tx slots	22.22	22.43	22.17	22.50	17.96	18.17	17.91	18.24
EDGE 4 Tx slots	20.70	20.66	20.65	21.00	17.70	17.66	17.65	18.00

Timeslot consignations:

No. of Slots	Slot 1	Slot 2	Slot 3	Slot 4
Slot Consignation	1Up4Down	2Up3Down	3Up2Down	4Up1Down
Duty Cycle	1:8.3	1:4.15	1:2.77	1:2.08
Correct Factor	-9.03dB	-6.02dB	-4.26dB	-3.01dB



➤ WCDMA Conducted Power

Band		WCDMA II			Tune-up Limit (dBm)
TX Channel		9262	9400	9538	
Rx Channel		9662	9800	9938	
Frequency (MHz)		1852.4	1880	1907.6	
3GPP Rel 99	RMC 12.2Kbps	19.84	19.86	19.83	20.00
3GPP Rel 6	HSDPA Subtest-1	17.19	17.35	17.25	17.50
3GPP Rel 6	HSDPA Subtest-2	17.23	17.32	17.19	17.50
3GPP Rel 6	HSDPA Subtest-3	16.71	16.89	16.63	17.00
3GPP Rel 6	HSDPA Subtest-4	16.73	16.79	16.61	17.00
3GPP Rel 6	HSUPA Subtest-1	17.29	17.31	17.38	17.50
3GPP Rel 6	HSUPA Subtest-2	15.39	15.51	15.39	16.00
3GPP Rel 6	HSUPA Subtest-3	16.42	16.53	16.32	17.00
3GPP Rel 6	HSUPA Subtest-4	15.41	15.54	15.31	16.00
3GPP Rel 6	HSUPA Subtest-5	17.23	17.33	17.36	17.50
3GPP Rel 7	HSPA+ (16QAM) Subtest-1	16.13	16.37	16.51	17.00

Band		WCDMA IV			Tune-up Limit (dBm)
TX Channel		1312	1413	1513	
Rx Channel		1537	1638	1738	
Frequency (MHz)		1712.4	1732.6	1752.6	
3GPP Rel 99	RMC 12.2Kbps	20.87	21.37	21.23	21.50
3GPP Rel 6	HSDPA Subtest-1	18.71	18.86	18.76	19.00
3GPP Rel 6	HSDPA Subtest-2	18.75	18.83	18.70	19.00
3GPP Rel 6	HSDPA Subtest-3	18.23	18.40	18.14	18.50
3GPP Rel 6	HSDPA Subtest-4	18.25	18.30	18.12	18.50
3GPP Rel 6	HSUPA Subtest-1	18.81	18.82	18.89	19.00
3GPP Rel 6	HSUPA Subtest-2	16.91	17.02	16.90	17.50
3GPP Rel 6	HSUPA Subtest-3	17.94	18.04	17.83	18.50
3GPP Rel 6	HSUPA Subtest-4	16.93	17.05	16.82	17.50
3GPP Rel 6	HSUPA Subtest-5	18.75	18.84	18.87	19.00
3GPP Rel 7	HSPA+ (16QAM) Subtest-1	16.13	16.37	16.51	17.00



Band		WCDMA V			Tune-up Limit (dBm)
TX Channel		4132	4183	4233	
Rx Channel		4357	4408	4458	
Frequency (MHz)		826.4	836.6	846.6	
3GPP Rel 99	RMC 12.2Kbps	22.83	22.88	22.74	23.00
3GPP Rel 6	HSDPA Subtest-1	20.21	20.37	20.28	20.50
3GPP Rel 6	HSDPA Subtest-2	20.26	20.38	20.16	20.50
3GPP Rel 6	HSDPA Subtest-3	19.71	19.91	19.66	20.00
3GPP Rel 6	HSDPA Subtest-4	19.74	19.88	19.67	20.00
3GPP Rel 6	HSUPA Subtest-1	20.22	20.35	20.34	20.50
3GPP Rel 6	HSUPA Subtest-2	18.42	18.55	18.34	19.00
3GPP Rel 6	HSUPA Subtest-3	19.41	19.57	19.33	20.00
3GPP Rel 6	HSUPA Subtest-4	18.43	18.57	18.32	19.00
3GPP Rel 6	HSUPA Subtest-5	20.19	20.36	20.33	20.50
3GPP Rel 7	HSPA+ (16QAM) Subtest-1	19.02	19.29	19.26	19.50

➤ **CDMA2000 Conducted Power**

1XRTT Conducted Power:

Band	CDMA 2000 BC0			Tune-up Limit (dBm)
TX Channel	1013	384	777	
Frequency (MHz)	824.7	836.52	848.31	
RC1 SO55	23.66	23.67	23.72	24.00
RC3 SO55	23.81	23.84	23.76	24.00
RC3 SO32 (F+SCH)	23.74	23.78	23.60	24.00
RC3 SO32 (+SCH)	23.73	23.74	23.60	24.00

Band	CDMA 2000 BC1			Tune-up Limit (dBm)
TX Channel	25	600	1175	
Frequency (MHz)	1851.25	1880	1908.75	
RC1 SO55	17.68	17.57	17.39	18.00
RC3 SO55	17.86	17.81	17.85	18.00
RC3 SO32 (F+SCH)	17.69	17.78	17.77	18.00
RC3 SO32 (+SCH)	17.69	17.74	17.75	18.00

**1XEVD0 Conducted Power:**

Band	CDMA 2000 BC0			Tune-up Limit (dBm)
	TX Channel	1013	384	
Frequency (MHz)	824.7	836.52	848.31	24.00
RTAP 153.6Kbps	23.60	23.62	23.58	23.50
RETAP 4096Bits	23.41	23.35	23.40	23.00
RMCTAP 307.2 Kbps	22.84	22.87	22.76	23.00

Band	CDMA 2000 BC1			Tune-up Limit (dBm)
	TX Channel	25	600	
Frequency (MHz)	1851.25	1880	1908.75	18.00
RTAP 153.6Kbps	17.66	17.59	17.08	17.50
RETAP 4096Bits	17.29	17.40	17.03	17.00
RMCTAP 307.2 Kbps	16.75	16.67	16.55	17.00



➤ LTE Conducted Power

<FDD-LTE Band 2>

BW [MHz]	Modulation	RB Size	RB Offset	Power Low Ch. / Freq.	Power Middle Ch. / Freq.	Power High Ch. / Freq.	Tune-up limit (dBm)
Channel				18700	18900	19100	
Frequency (MHz)				1860	1880	1900	
20	QPSK	1	0	19.54	19.56	19.57	20.00
20	QPSK	1	49	19.49	19.52	19.63	
20	QPSK	1	99	19.60	19.76	19.80	
20	QPSK	50	0	18.71	18.73	18.73	19.00
20	QPSK	50	24	18.72	18.77	18.77	
20	QPSK	50	50	18.77	18.88	18.89	
20	QPSK	100	0	18.70	18.79	18.75	
20	16QAM	1	0	18.76	18.76	18.78	19.50
20	16QAM	1	49	19.11	18.90	18.86	
20	16QAM	1	99	18.85	19.01	19.10	
20	16QAM	50	0	18.78	18.75	18.73	19.00
20	16QAM	50	24	18.74	18.79	18.80	
20	16QAM	50	50	18.82	18.79	18.86	
20	16QAM	100	0	18.85	18.86	18.73	
20	64QAM	1	0	18.72	18.91	18.65	19.50
20	64QAM	1	49	18.67	18.85	18.76	
20	64QAM	1	99	19.11	18.95	18.95	
20	64QAM	50	0	17.80	17.72	17.77	18.00
20	64QAM	50	24	17.83	17.77	17.82	
20	64QAM	50	50	17.82	17.83	17.77	
20	64QAM	100	0	17.82	17.79	17.80	
Channel				18675	18900	19125	Tune-up limit (dBm)
Frequency (MHz)				1857.5	1880	1902.5	
15	QPSK	1	0	19.57	19.60	19.51	20.00
15	QPSK	1	37	19.36	19.72	19.60	
15	QPSK	1	74	19.73	19.65	19.73	
15	QPSK	36	0	18.69	18.78	18.77	19.00
15	QPSK	36	20	18.68	18.87	18.84	
15	QPSK	36	39	18.80	18.81	18.78	



15	QPSK	75	0	18.72	18.78	18.74	
15	16QAM	1	0	18.81	18.89	18.83	19.50
15	16QAM	1	37	18.94	18.97	18.83	
15	16QAM	1	74	18.89	19.01	19.01	
15	16QAM	36	0	18.68	18.73	18.76	19.00
15	16QAM	36	20	18.77	18.70	18.83	
15	16QAM	36	39	18.82	18.91	18.88	
15	16QAM	75	0	18.69	18.71	18.80	
15	64QAM	1	0	18.89	18.65	18.71	19.50
15	64QAM	1	37	18.88	18.69	19.11	
15	64QAM	1	74	18.77	18.81	18.96	
15	64QAM	36	0	17.62	17.79	17.67	18.00
15	64QAM	36	20	17.82	17.84	17.74	
15	64QAM	36	39	17.70	17.75	17.84	
15	64QAM	75	0	17.69	17.76	17.75	
Channel				18650	18900	19150	Tune-up limit (dBm)
Frequency (MHz)				1855	1880	1905	
10	QPSK	1	0	19.42	19.41	19.51	20.00
10	QPSK	1	25	19.53	19.63	19.51	
10	QPSK	1	49	19.42	19.50	19.42	
10	QPSK	25	0	18.68	18.69	18.65	19.00
10	QPSK	25	12	18.64	18.76	18.69	
10	QPSK	25	25	18.55	18.68	18.64	
10	QPSK	50	0	18.61	18.70	18.68	
10	16QAM	1	0	19.09	19.02	19.01	19.50
10	16QAM	1	25	18.78	18.74	18.81	
10	16QAM	1	49	18.73	18.81	19.02	
10	16QAM	25	0	17.57	17.61	17.67	18.00
10	16QAM	25	12	17.75	17.71	17.70	
10	16QAM	25	25	17.70	17.66	17.65	
10	16QAM	50	0	17.66	17.59	17.63	
10	64QAM	1	0	18.67	18.72	18.72	19.50
10	64QAM	1	25	18.70	18.75	18.79	
10	64QAM	1	49	18.37	18.50	18.47	
10	64QAM	25	0	17.67	17.71	17.72	18.00
10	64QAM	25	12	17.70	17.68	17.69	
10	64QAM	25	25	17.63	17.41	17.63	



10	64QAM	50	0	17.64	17.64	17.61	
Channel				18625	18900	19175	Tune-up limit (dBm)
Frequency (MHz)				1852.5	1880	1907.5	
5	QPSK	1	0	19.56	19.61	19.55	20.00
5	QPSK	1	12	19.55	19.66	19.53	
5	QPSK	1	24	19.51	19.67	19.60	
5	QPSK	12	0	18.67	18.58	18.65	19.00
5	QPSK	12	7	18.68	18.73	18.65	
5	QPSK	12	13	18.67	18.66	18.69	
5	QPSK	25	0	18.66	18.64	18.66	
5	16QAM	1	0	18.79	18.69	19.07	19.50
5	16QAM	1	12	18.77	18.70	19.07	
5	16QAM	1	24	18.80	18.67	19.06	
5	16QAM	12	0	17.65	17.53	17.63	18.00
5	16QAM	12	7	17.72	17.74	17.68	
5	16QAM	12	13	17.75	17.64	17.59	
5	16QAM	25	0	17.67	17.65	17.63	
5	64QAM	1	0	19.06	18.61	18.66	19.50
5	64QAM	1	12	19.05	18.71	18.82	
5	64QAM	1	24	19.06	18.70	18.72	
5	64QAM	12	0	17.71	17.64	17.63	18.00
5	64QAM	12	7	17.77	17.61	17.61	
5	64QAM	12	13	17.74	17.70	17.68	
5	64QAM	25	0	17.81	17.61	17.68	
Channel				18615	18900	19185	Tune-up limit (dBm)
Frequency (MHz)				1851.5	1880	1908.5	
3	QPSK	1	0	19.61	19.39	19.51	20.00
3	QPSK	1	8	19.54	19.75	19.58	
3	QPSK	1	14	19.73	19.60	19.60	
3	QPSK	8	0	18.67	18.62	18.64	19.00
3	QPSK	8	4	18.73	18.67	18.68	
3	QPSK	8	7	18.73	18.67	18.63	
3	QPSK	15	0	18.65	18.73	18.66	
3	16QAM	1	0	18.81	18.72	18.66	19.50
3	16QAM	1	8	18.85	18.79	18.75	
3	16QAM	1	14	18.78	18.75	19.10	



3	16QAM	8	0	17.71	17.84	17.76	18.00
3	16QAM	8	4	17.78	17.75	17.81	
3	16QAM	8	7	17.68	17.73	17.76	
3	16QAM	15	0	17.71	17.75	17.70	
3	64QAM	1	0	18.74	18.67	18.70	19.50
3	64QAM	1	8	19.16	19.15	18.75	
3	64QAM	1	14	18.77	19.13	18.77	
3	64QAM	8	0	17.69	17.71	17.55	18.00
3	64QAM	8	4	17.79	17.69	17.69	
3	64QAM	8	7	17.89	17.78	17.64	
3	64QAM	15	0	17.74	17.74	17.72	
Channel				18607	18900	19193	Tune-up limit (dBm)
Frequency (MHz)				1850.7	1880	1909.3	
1.4	QPSK	1	0	19.48	19.50	19.46	20.00
1.4	QPSK	1	3	19.58	19.56	19.55	
1.4	QPSK	1	5	19.55	19.53	19.51	
1.4	QPSK	3	0	19.54	19.54	19.50	
1.4	QPSK	3	1	19.58	19.55	19.53	
1.4	QPSK	3	3	19.60	19.64	19.53	
1.4	QPSK	6	0	18.63	18.61	18.60	19.00
1.4	16QAM	1	0	18.66	18.66	18.60	19.50
1.4	16QAM	1	3	18.62	18.82	18.80	
1.4	16QAM	1	5	18.50	18.70	18.38	
1.4	16QAM	3	0	18.52	18.57	18.54	
1.4	16QAM	3	1	18.70	18.52	18.57	
1.4	16QAM	3	3	18.72	18.69	18.43	
1.4	16QAM	6	0	17.77	17.66	17.58	18.00
1.4	64QAM	1	0	18.61	18.53	18.56	19.50
1.4	64QAM	1	3	18.63	18.84	18.72	
1.4	64QAM	1	5	18.61	18.96	18.55	
1.4	64QAM	3	0	18.64	18.70	18.71	
1.4	64QAM	3	1	18.73	18.70	18.44	
1.4	64QAM	3	3	18.65	18.79	18.56	
1.4	64QAM	6	0	17.65	17.66	17.55	18.00



<FDD-LTE Band 4>

BW [MHz]	Modulation	RB Size	RB Offset	Power Low Ch. / Freq.	Power Middle Ch. / Freq.	Power High Ch. / Freq.	Tune-up limit (dBm)
Channel				20050	20175	20300	
Frequency (MHz)				1720	1732.5	1745	
20	QPSK	1	0	20.66	20.64	20.78	21.00
20	QPSK	1	49	20.52	20.60	20.73	
20	QPSK	1	99	20.44	20.57	20.69	
20	QPSK	50	0	19.73	19.84	19.83	20.00
20	QPSK	50	24	19.73	19.81	19.81	
20	QPSK	50	50	19.62	19.73	19.86	
20	QPSK	100	0	19.72	19.76	19.83	
20	16QAM	1	0	19.91	19.99	19.88	20.50
20	16QAM	1	49	20.06	19.83	19.97	
20	16QAM	1	99	19.85	20.07	19.83	
20	16QAM	50	0	18.78	18.83	18.93	19.00
20	16QAM	50	24	18.74	18.85	18.74	
20	16QAM	50	50	18.70	18.71	18.71	
20	16QAM	100	0	18.72	18.80	18.81	
20	64QAM	1	0	19.70	19.81	20.03	20.50
20	64QAM	1	49	19.74	19.67	19.55	
20	64QAM	1	99	20.01	19.58	20.05	
20	64QAM	50	0	18.71	18.80	18.75	19.00
20	64QAM	50	24	18.73	18.84	18.78	
20	64QAM	50	50	18.77	18.72	18.74	
20	64QAM	100	0	18.80	18.78	18.87	
Channel				20025	20175	20325	Tune-up limit (dBm)
Frequency (MHz)				1717.5	1732.5	1747.5	
15	QPSK	1	0	20.53	20.57	20.67	21.00
15	QPSK	1	37	20.57	20.66	20.58	
15	QPSK	1	74	20.44	20.66	20.69	
15	QPSK	36	0	19.67	19.74	19.77	20.00
15	QPSK	36	20	19.71	19.84	19.80	
15	QPSK	36	39	19.76	19.75	19.84	
15	QPSK	75	0	19.71	19.73	19.74	



15	16QAM	1	0	19.79	20.01	19.73	20.50
15	16QAM	1	37	19.87	19.87	19.71	
15	16QAM	1	74	19.73	20.03	19.99	
15	16QAM	36	0	18.74	18.76	18.82	19.00
15	16QAM	36	20	18.69	18.76	18.82	
15	16QAM	36	39	18.65	18.74	18.80	
15	16QAM	75	0	18.76	18.77	18.86	
15	64QAM	1	0	19.57	19.88	19.93	20.50
15	64QAM	1	37	19.99	19.75	19.81	
15	64QAM	1	74	20.03	19.74	19.78	
15	64QAM	36	0	18.68	18.75	18.79	19.00
15	64QAM	36	20	18.74	18.76	18.78	
15	64QAM	36	39	18.77	18.73	18.75	
15	64QAM	75	0	18.70	18.81	18.74	
Channel				20000	20175	20350	Tune-up limit (dBm)
Frequency (MHz)				1715	1732.5	1750	
10	QPSK	1	0	20.45	20.64	20.47	21.00
10	QPSK	1	25	20.43	20.56	20.57	
10	QPSK	1	49	20.51	20.34	20.57	
10	QPSK	25	0	19.50	19.72	19.74	20.00
10	QPSK	25	12	19.62	19.68	19.72	
10	QPSK	25	25	19.51	19.62	19.69	
10	QPSK	50	0	19.57	19.67	19.59	
10	16QAM	1	0	19.70	19.85	19.61	20.50
10	16QAM	1	25	19.97	19.71	20.03	
10	16QAM	1	49	20.04	19.94	19.93	
10	16QAM	25	0	18.70	18.69	18.68	19.00
10	16QAM	25	12	18.62	18.72	18.69	
10	16QAM	25	25	18.58	18.49	18.58	
10	16QAM	50	0	18.52	18.56	18.68	
10	64QAM	1	0	19.62	19.70	19.60	20.50
10	64QAM	1	25	19.69	19.98	20.07	
10	64QAM	1	49	19.67	19.71	19.66	
10	64QAM	25	0	18.51	18.65	18.64	19.00
10	64QAM	25	12	18.60	18.71	18.75	
10	64QAM	25	25	18.48	18.60	18.62	
10	64QAM	50	0	18.54	18.61	18.60	



Channel				19975	20175	20375	Tune-up limit (dBm)
Frequency (MHz)				1712.5	1732.5	1752.5	
5	QPSK	1	0	20.35	20.57	20.62	21.00
5	QPSK	1	12	20.41	20.56	20.53	
5	QPSK	1	24	20.36	20.48	20.47	
5	QPSK	12	0	19.58	19.58	19.62	20.00
5	QPSK	12	7	19.58	19.69	19.66	
5	QPSK	12	13	19.53	19.70	19.62	
5	QPSK	25	0	19.56	19.60	19.66	
5	16QAM	1	0	19.60	20.01	19.69	20.50
5	16QAM	1	12	19.71	20.06	19.65	
5	16QAM	1	24	19.65	20.00	19.60	
5	16QAM	12	0	18.64	18.58	18.61	19.00
5	16QAM	12	7	18.67	18.71	18.69	
5	16QAM	12	13	18.56	18.63	18.67	
5	16QAM	25	0	18.57	18.68	18.61	
5	64QAM	1	0	19.58	20.02	20.00	20.50
5	64QAM	1	12	19.96	19.72	19.99	
5	64QAM	1	24	19.92	19.62	19.69	
5	64QAM	12	0	18.59	18.66	18.68	19.00
5	64QAM	12	7	18.58	18.67	18.73	
5	64QAM	12	13	18.59	18.65	18.64	
5	64QAM	25	0	18.54	18.68	18.59	
Channel				19965	20175	20385	Tune-up limit (dBm)
Frequency (MHz)				1711.5	1732.5	1753.5	
3	QPSK	1	0	20.47	20.48	20.60	21.00
3	QPSK	1	8	20.56	20.70	20.64	
3	QPSK	1	14	20.36	20.55	20.55	
3	QPSK	8	0	19.56	19.62	19.63	20.00
3	QPSK	8	4	19.62	19.70	19.72	
3	QPSK	8	7	19.58	19.68	19.68	
3	QPSK	15	0	19.58	19.64	19.58	
3	16QAM	1	0	19.80	19.89	19.93	20.50
3	16QAM	1	8	20.02	20.02	19.76	
3	16QAM	1	14	19.93	19.71	19.79	
3	16QAM	8	0	18.60	18.73	18.60	19.00



3	16QAM	8	4	18.72	18.82	18.79	
3	16QAM	8	7	18.66	18.74	18.78	
3	16QAM	15	0	18.66	18.64	18.71	
3	64QAM	1	0	19.57	19.66	19.64	20.50
3	64QAM	1	8	19.76	19.64	19.80	
3	64QAM	1	14	19.57	19.64	19.47	
3	64QAM	8	0	18.55	18.59	18.53	19.00
3	64QAM	8	4	18.67	18.65	18.69	
3	64QAM	8	7	18.61	18.68	18.80	
3	64QAM	15	0	18.57	18.65	18.56	
Channel				19957	20175	20393	Tune-up limit (dBm)
Frequency (MHz)				1710.7	1732.5	1754.3	
1.4	QPSK	1	0	20.22	20.43	20.44	21.00
1.4	QPSK	1	3	20.56	20.56	20.60	
1.4	QPSK	1	5	20.42	20.51	20.53	
1.4	QPSK	3	0	20.50	20.47	20.46	
1.4	QPSK	3	1	20.46	20.56	20.61	
1.4	QPSK	3	3	20.45	20.52	20.51	
1.4	QPSK	6	0	19.55	19.64	19.64	20.00
1.4	16QAM	1	0	19.52	19.99	19.65	20.50
1.4	16QAM	1	3	19.65	19.73	19.77	
1.4	16QAM	1	5	19.71	19.87	19.67	
1.4	16QAM	3	0	19.53	19.57	19.48	
1.4	16QAM	3	1	19.54	19.57	19.59	
1.4	16QAM	3	3	19.53	19.65	19.54	
1.4	16QAM	6	0	18.70	18.51	18.64	19.00
1.4	64QAM	1	0	19.46	19.40	19.54	20.50
1.4	64QAM	1	3	19.72	19.70	19.82	
1.4	64QAM	1	5	19.63	19.59	19.43	
1.4	64QAM	3	0	19.54	19.52	19.71	
1.4	64QAM	3	1	19.45	19.60	19.57	
1.4	64QAM	3	3	19.51	19.68	19.56	
1.4	64QAM	6	0	18.50	18.51	18.58	19.00



<FDD-LTE Band 5>

BW [MHz]	Modulation	RB Size	RB Offset	Power Low Ch. / Freq.	Power Middle Ch. / Freq.	Power High Ch. / Freq.	Tune-up limit (dBm)
Channel				20450	20525	20600	
Frequency (MHz)				829	836.5	844	
10	QPSK	1	0	22.75	22.76	22.57	23.00
10	QPSK	1	25	22.61	22.64	22.44	
10	QPSK	1	49	22.53	22.65	22.33	
10	QPSK	25	0	21.84	21.86	21.67	22.00
10	QPSK	25	12	21.81	21.83	21.58	
10	QPSK	25	25	21.81	21.72	21.55	
10	QPSK	50	0	21.74	21.75	21.52	
10	16QAM	1	0	21.91	22.10	21.81	22.50
10	16QAM	1	25	22.14	22.17	21.85	
10	16QAM	1	49	21.76	21.82	21.89	
10	16QAM	25	0	20.85	20.86	20.68	21.00
10	16QAM	25	12	20.79	20.87	20.49	
10	16QAM	25	25	20.82	20.75	20.48	
10	16QAM	50	0	20.83	20.74	20.64	
10	64QAM	1	0	21.92	22.37	21.95	
10	64QAM	1	25	21.93	21.94	21.97	22.50
10	64QAM	1	49	21.94	21.98	22.02	
10	64QAM	25	0	20.76	20.87	20.54	
10	64QAM	25	12	20.75	20.92	20.63	21.00
10	64QAM	25	25	20.87	20.76	20.46	
10	64QAM	50	0	20.83	20.79	20.65	
Channel				20425	20525	20625	
Frequency (MHz)				826.5	836.5	846.5	
5	QPSK	1	0	22.52	22.57	22.34	23.00
5	QPSK	1	12	22.60	22.71	22.21	
5	QPSK	1	24	22.60	22.55	22.27	
5	QPSK	12	0	21.75	21.80	21.48	22.00
5	QPSK	12	7	21.82	21.83	21.56	
5	QPSK	12	13	21.87	21.71	21.44	
5	QPSK	25	0	21.78	21.74	21.50	



5	16QAM	1	0	22.07	22.00	21.76	22.50
5	16QAM	1	12	21.77	21.99	21.75	
5	16QAM	1	24	21.64	21.99	21.82	
5	16QAM	12	0	20.73	20.82	20.51	21.00
5	16QAM	12	7	20.80	20.83	20.51	
5	16QAM	12	13	20.80	20.71	20.36	
5	16QAM	25	0	20.81	20.86	20.47	22.50
5	64QAM	1	0	21.88	21.53	21.87	
5	64QAM	1	12	21.76	21.70	21.84	
5	64QAM	1	24	21.90	21.74	21.43	21.00
5	64QAM	12	0	20.62	20.76	20.36	
5	64QAM	12	7	20.66	20.82	20.60	
5	64QAM	12	13	20.84	20.79	20.36	Tune-up limit (dBm)
5	64QAM	25	0	20.72	20.79	20.40	
Channel				20415	20525	20635	
Frequency (MHz)				825.5	836.5	847.5	
3	QPSK	1	0	22.39	22.70	22.41	23.00
3	QPSK	1	8	22.78	22.66	22.46	
3	QPSK	1	14	22.74	22.64	22.38	
3	QPSK	8	0	21.68	21.81	21.43	22.00
3	QPSK	8	4	21.82	21.88	21.43	
3	QPSK	8	7	21.77	21.79	21.46	
3	QPSK	15	0	21.75	21.81	21.40	22.50
3	16QAM	1	0	21.77	22.15	21.95	
3	16QAM	1	8	22.20	21.96	21.80	
3	16QAM	1	14	22.14	22.01	21.76	21.00
3	16QAM	8	0	20.71	20.80	20.54	
3	16QAM	8	4	20.87	20.98	20.55	
3	16QAM	8	7	20.79	20.85	20.59	22.50
3	16QAM	15	0	20.73	20.75	20.30	
3	64QAM	1	0	21.68	21.56	21.77	
3	64QAM	1	8	21.56	21.80	21.31	21.00
3	64QAM	1	14	21.58	21.76	21.44	
3	64QAM	8	0	20.68	20.78	20.44	
3	64QAM	8	4	20.90	20.74	20.37	
3	64QAM	8	7	20.85	20.77	20.41	
3	64QAM	15	0	20.74	20.84	20.31	



Channel				20407	20525	20643	Tune-up limit (dBm)
Frequency (MHz)				824.7	836.5	848.3	
1.4	QPSK	1	0	22.60	22.67	22.18	23.00
1.4	QPSK	1	3	22.73	22.74	22.30	
1.4	QPSK	1	5	22.62	22.56	22.24	
1.4	QPSK	3	0	22.63	22.69	22.22	
1.4	QPSK	3	1	22.69	22.74	22.38	
1.4	QPSK	3	3	22.70	22.72	22.29	
1.4	QPSK	6	0	21.73	21.72	21.37	22.00
1.4	16QAM	1	0	22.03	21.67	21.50	22.50
1.4	16QAM	1	3	22.24	21.90	21.45	
1.4	16QAM	1	5	22.05	21.73	21.45	
1.4	16QAM	3	0	21.58	21.56	21.36	
1.4	16QAM	3	1	21.61	21.88	21.40	
1.4	16QAM	3	3	21.69	21.80	21.34	
1.4	16QAM	6	0	20.91	20.86	20.39	21.00
1.4	64QAM	1	0	21.54	21.71	21.39	22.50
1.4	64QAM	1	3	21.85	21.86	21.47	
1.4	64QAM	1	5	21.80	21.79	21.33	
1.4	64QAM	3	0	21.46	21.73	21.40	
1.4	64QAM	3	1	21.74	21.68	21.35	
1.4	64QAM	3	3	21.64	21.81	21.51	
1.4	64QAM	6	0	20.72	20.84	20.39	21.00

<FDD-LTE Band 7>

BW [MHz]	Modulation	RB Size	RB Offset	Power Low Ch. / Freq.	Power Middle Ch. / Freq.	Power High Ch. / Freq.	Tune-up limit (dBm)
Channel				20850	21100	21350	
Frequency (MHz)				2510	2535	2560	
20	QPSK	1	0	22.74	22.78	22.81	23.00
20	QPSK	1	49	22.62	22.87	22.76	
20	QPSK	1	99	22.78	22.73	22.78	
20	QPSK	50	0	21.77	21.94	21.81	22.00
20	QPSK	50	24	21.83	21.80	21.70	
20	QPSK	50	50	21.93	21.96	21.93	



20	QPSK	100	0	21.88	21.90	21.87	
20	16QAM	1	0	21.69	21.79	21.97	22.00
20	16QAM	1	49	21.84	21.70	21.98	
20	16QAM	1	99	21.82	21.72	21.89	
20	16QAM	50	0	20.88	20.98	20.91	21.50
20	16QAM	50	24	20.93	20.85	20.96	
20	16QAM	50	50	21.01	21.06	20.89	
20	16QAM	100	0	20.89	21.01	20.99	
20	64QAM	1	0	21.99	22.34	21.56	22.50
20	64QAM	1	49	21.93	21.90	21.95	
20	64QAM	1	99	21.91	21.96	21.87	
20	64QAM	50	0	20.90	20.91	20.96	21.50
20	64QAM	50	24	20.95	20.96	20.96	
20	64QAM	50	50	20.99	21.06	20.91	
20	64QAM	100	0	20.92	20.89	21.01	
Channel				20825	21100	21375	Tune-up limit (dBm)
Frequency (MHz)				2507.5	2535	2562.5	
15	QPSK	1	0	22.71	22.80	22.80	23.00
15	QPSK	1	37	22.81	22.78	22.82	
15	QPSK	1	74	22.75	22.82	22.82	
15	QPSK	36	0	21.86	21.95	21.97	22.50
15	QPSK	36	20	21.94	22.01	21.96	
15	QPSK	36	39	21.97	22.00	22.04	
15	QPSK	75	0	22.03	21.96	21.98	
15	16QAM	1	0	22.19	22.30	22.37	22.50
15	16QAM	1	37	22.01	22.12	22.10	
15	16QAM	1	74	22.05	22.05	22.27	
15	16QAM	36	0	20.89	21.00	21.02	21.00
15	16QAM	36	20	20.96	20.99	20.98	
15	16QAM	36	39	21.02	21.00	20.89	
15	16QAM	75	0	20.97	21.05	20.97	
15	64QAM	1	0	21.89	22.35	21.74	22.50
15	64QAM	1	37	21.79	21.94	22.03	
15	64QAM	1	74	21.78	21.90	21.96	
15	64QAM	36	0	20.88	20.96	20.95	21.50
15	64QAM	36	20	20.99	20.98	21.05	
15	64QAM	36	39	21.03	20.94	20.96	



15	64QAM	75	0	20.88	20.98	20.93	
Channel				20800	21100	21400	Tune-up limit (dBm)
Frequency (MHz)				2505	2535	2565	
10	QPSK	1	0	22.70	22.57	22.60	23.00
10	QPSK	1	25	22.73	22.63	22.65	
10	QPSK	1	49	22.66	22.63	22.65	
10	QPSK	25	0	21.78	21.78	21.77	22.00
10	QPSK	25	12	21.74	21.86	21.91	
10	QPSK	25	25	21.67	21.85	21.85	
10	QPSK	50	0	21.76	21.88	21.87	22.50
10	16QAM	1	0	21.81	21.99	21.84	
10	16QAM	1	25	21.80	21.82	21.87	
10	16QAM	1	49	22.27	22.17	22.08	21.00
10	16QAM	25	0	20.76	20.83	20.91	
10	16QAM	25	12	20.77	20.94	20.87	
10	16QAM	25	25	20.82	20.85	20.77	
10	16QAM	50	0	20.85	20.94	20.79	22.50
10	64QAM	1	0	21.89	21.85	21.83	
10	64QAM	1	25	21.58	21.83	21.66	
10	64QAM	1	49	21.69	21.93	21.74	21.50
10	64QAM	25	0	20.80	20.78	20.82	
10	64QAM	25	12	20.82	20.93	20.86	
10	64QAM	25	25	20.75	20.65	20.64	
10	64QAM	50	0	20.85	20.91	20.83	Tune-up limit (dBm)
Channel				20775	21100	21425	
Frequency (MHz)				2502.5	2535	2567.5	
5	QPSK	1	0	22.53	22.58	22.71	23.00
5	QPSK	1	12	22.62	22.70	22.78	
5	QPSK	1	24	22.71	22.77	22.81	
5	QPSK	12	0	21.74	21.82	21.74	22.00
5	QPSK	12	7	21.81	21.96	21.88	
5	QPSK	12	13	21.83	21.99	21.84	
5	QPSK	25	0	21.84	21.85	21.80	22.00
5	16QAM	1	0	21.82	21.80	21.86	
5	16QAM	1	12	21.87	22.09	21.99	
5	16QAM	1	24	21.93	22.12	21.94	



5	16QAM	12	0	20.79	20.73	20.86	21.00
5	16QAM	12	7	20.88	21.00	20.96	
5	16QAM	12	13	20.98	21.04	20.87	
5	16QAM	25	0	20.85	20.90	20.91	
5	64QAM	1	0	21.81	21.86	21.82	22.50
5	64QAM	1	12	21.86	21.98	21.86	
5	64QAM	1	24	21.90	22.00	21.96	
5	64QAM	12	0	20.86	20.83	20.88	21.50
5	64QAM	12	7	20.95	21.00	20.79	
5	64QAM	12	13	20.90	20.99	20.85	
5	64QAM	25	0	20.85	20.84	20.89	

<FDD-LTE Band 12>

BW [MHz]	Modulation	RB Size	RB Offset	Power Low Ch. / Freq.	Power Middle Ch. / Freq.	Power High Ch. / Freq.	Tune-up limit (dBm)
Channel				23060	23095	23130	
Frequency (MHz)				704	707.5	711	
10	QPSK	1	0	22.47	22.48	22.35	23.00
10	QPSK	1	25	22.25	22.46	22.31	
10	QPSK	1	49	22.25	22.44	22.63	
10	QPSK	25	0	21.50	21.60	21.51	22.00
10	QPSK	25	12	21.59	21.54	21.60	
10	QPSK	25	25	21.52	21.58	21.51	
10	QPSK	50	0	21.53	21.55	21.46	
10	16QAM	1	0	21.90	21.45	21.51	22.50
10	16QAM	1	25	22.05	21.60	21.92	
10	16QAM	1	49	21.74	21.79	21.68	
10	16QAM	25	0	20.52	20.54	20.48	21.00
10	16QAM	25	12	20.56	20.60	20.49	
10	16QAM	25	25	20.61	20.62	20.56	
10	16QAM	50	0	20.51	20.59	20.64	
10	64QAM	1	0	21.44	21.56	21.90	22.00
10	64QAM	1	25	21.88	21.94	21.53	
10	64QAM	1	49	21.90	21.58	21.51	
10	64QAM	25	0	20.52	20.46	20.43	21.00
10	64QAM	25	12	20.57	20.60	20.52	



10	64QAM	25	25	20.62	20.59	20.59	
10	64QAM	50	0	20.54	20.47	20.58	
Channel				23035	23095	23155	Tune-up limit (dBm)
Frequency (MHz)				701.5	707.5	713.5	
5	QPSK	1	0	22.22	22.38	22.33	23.00
5	QPSK	1	12	22.38	22.54	22.38	
5	QPSK	1	24	22.34	22.53	22.39	
5	QPSK	12	0	21.45	21.52	21.51	22.00
5	QPSK	12	7	21.56	21.58	21.55	
5	QPSK	12	13	21.51	21.54	21.51	
5	QPSK	25	0	21.47	21.59	21.55	22.50
5	16QAM	1	0	21.48	21.50	21.52	
5	16QAM	1	12	21.65	21.60	21.61	
5	16QAM	1	24	21.61	21.59	21.55	21.00
5	16QAM	12	0	20.46	20.43	20.46	
5	16QAM	12	7	20.60	20.65	20.49	
5	16QAM	12	13	20.55	20.52	20.57	21.00
5	16QAM	25	0	20.56	20.52	20.54	
5	64QAM	1	0	21.42	21.43	21.48	
5	64QAM	1	12	21.87	21.57	21.50	22.00
5	64QAM	1	24	21.85	21.54	21.59	
5	64QAM	12	0	20.50	20.52	20.47	
5	64QAM	12	7	20.60	20.48	20.54	21.00
5	64QAM	12	13	20.47	20.57	20.62	
5	64QAM	25	0	20.62	20.58	20.55	
Channel				23025	23095	23165	Tune-up limit (dBm)
Frequency (MHz)				700.5	707.5	714.5	
3	QPSK	1	0	22.30	22.39	22.24	23.00
3	QPSK	1	8	22.48	22.47	22.57	
3	QPSK	1	14	22.42	22.53	22.48	
3	QPSK	8	0	21.53	21.51	21.51	22.00
3	QPSK	8	4	21.56	21.59	21.60	
3	QPSK	8	7	21.51	21.59	21.53	
3	QPSK	15	0	21.50	21.58	21.44	22.50
3	16QAM	1	0	21.51	21.87	21.46	
3	16QAM	1	8	21.71	21.69	21.64	



3	16QAM	1	14	21.54	21.59	22.06	
3	16QAM	8	0	20.62	20.51	20.54	21.00
3	16QAM	8	4	20.67	20.64	20.75	
3	16QAM	8	7	20.51	20.54	20.60	
3	16QAM	15	0	20.49	20.42	20.41	
3	64QAM	1	0	21.43	21.77	21.76	
3	64QAM	1	8	22.00	22.00	21.91	22.50
3	64QAM	1	14	21.84	21.50	21.94	
3	64QAM	8	0	20.43	20.51	20.42	
3	64QAM	8	4	20.52	20.56	20.55	21.00
3	64QAM	8	7	20.51	20.43	20.58	
3	64QAM	15	0	20.50	20.52	20.44	
Channel				23017	23095	23173	Tune-up limit (dBm)
Frequency (MHz)				699.7	707.5	715.3	
1.4	QPSK	1	0	22.33	22.37	22.30	23.00
1.4	QPSK	1	3	22.44	22.43	22.45	
1.4	QPSK	1	5	22.33	22.38	22.34	
1.4	QPSK	3	0	22.28	22.41	22.39	
1.4	QPSK	3	1	22.49	22.49	22.50	
1.4	QPSK	3	3	22.44	22.46	22.42	
1.4	QPSK	6	0	21.50	21.47	21.45	22.00
1.4	16QAM	1	0	21.54	21.48	21.17	22.00
1.4	16QAM	1	3	21.35	21.78	21.89	
1.4	16QAM	1	5	21.47	21.48	21.47	
1.4	16QAM	3	0	21.31	21.34	21.35	
1.4	16QAM	3	1	21.47	21.55	21.39	
1.4	16QAM	3	3	21.30	21.44	21.44	
1.4	16QAM	6	0	20.46	20.47	20.49	21.00
1.4	64QAM	1	0	21.27	21.42	21.26	22.00
1.4	64QAM	1	3	21.39	21.90	21.37	
1.4	64QAM	1	5	21.55	21.58	21.54	
1.4	64QAM	3	0	21.45	21.46	21.29	
1.4	64QAM	3	1	21.43	21.67	21.52	
1.4	64QAM	3	3	21.45	21.29	21.45	
1.4	64QAM	6	0	20.52	20.53	20.40	21.00



<FDD-LTE Band 17>

BW [MHz]	Modulation	RB Size	RB Offset	Power Low Ch. / Freq.	Power Middle Ch. / Freq.	Power High Ch. / Freq.	Tune-up limit (dBm)
Channel				23780	23790	23800	
Frequency (MHz)				709	710	711	
10	QPSK	1	0	22.23	22.31	22.17	23.00
10	QPSK	1	25	22.43	22.29	22.42	
10	QPSK	1	49	22.26	22.19	22.35	
10	QPSK	25	0	21.26	21.21	21.22	22.00
10	QPSK	25	12	21.46	21.40	21.38	
10	QPSK	25	25	21.24	21.18	21.19	
10	QPSK	50	0	21.22	21.17	21.30	22.00
10	16QAM	1	0	21.88	21.60	21.59	
10	16QAM	1	25	21.51	21.57	21.49	
10	16QAM	1	49	21.40	21.15	21.21	21.00
10	16QAM	25	0	20.20	20.18	20.18	
10	16QAM	25	12	20.34	20.40	20.44	
10	16QAM	25	25	20.19	20.22	20.31	21.00
10	16QAM	50	0	20.11	20.12	20.20	
10	64QAM	1	0	21.81	21.47	21.50	
10	64QAM	1	25	21.55	21.53	21.22	22.00
10	64QAM	1	49	21.49	21.49	21.50	
10	64QAM	25	0	20.13	20.13	20.21	
10	64QAM	25	12	20.46	20.37	20.45	21.00
10	64QAM	25	25	20.18	20.03	20.07	
10	64QAM	50	0	20.13	20.25	20.19	
Channel				23755	23790	23825	Tune-up limit (dBm)
Frequency (MHz)				706.5	710	713.5	
5	QPSK	1	0	21.93	22.10	22.12	23.00
5	QPSK	1	12	22.37	22.41	22.41	
5	QPSK	1	24	22.25	22.19	22.21	
5	QPSK	12	0	21.36	21.33	21.37	22.00
5	QPSK	12	7	21.47	21.51	21.52	
5	QPSK	12	13	21.44	21.46	21.43	
5	QPSK	25	0	21.45	21.34	21.38	



5	16QAM	1	0	21.36	21.03	21.49	22.00
5	16QAM	1	12	21.94	21.33	21.75	
5	16QAM	1	24	21.74	21.07	21.56	
5	16QAM	12	0	20.32	20.37	20.35	21.00
5	16QAM	12	7	20.47	20.37	20.49	
5	16QAM	12	13	20.43	20.42	20.42	
5	16QAM	25	0	20.44	20.38	20.42	22.00
5	64QAM	1	0	21.03	21.20	21.28	
5	64QAM	1	12	21.82	21.47	21.44	
5	64QAM	1	24	21.69	21.22	21.29	21.00
5	64QAM	12	0	20.21	20.36	20.37	
5	64QAM	12	7	20.46	20.39	20.53	
5	64QAM	12	13	20.44	20.46	20.24	21.00
5	64QAM	25	0	20.40	20.44	20.45	

<FDD-LTE Band 18>

BW [MHz]	Modulation	RB Size	RB Offset	Power Low Ch. / Freq.	Power Middle Ch. / Freq.	Power High Ch. / Freq.	Tune-up limit (dBm)
Channel				23925	23925	23925	
Frequency (MHz)				822.5	822.5	822.5	
15	QPSK	1	0	22.67			23.00
15	QPSK	1	37	22.35			
15	QPSK	1	74	22.42			
15	QPSK	36	0	21.49			22.00
15	QPSK	36	20	21.57			
15	QPSK	36	39	21.37			
15	QPSK	75	0	21.49			22.00
15	16QAM	1	0	21.95			
15	16QAM	1	37	21.35			
15	16QAM	1	74	21.42			21.00
15	16QAM	36	0	20.52			
15	16QAM	36	20	20.54			
15	16QAM	36	39	20.45			21.00
15	16QAM	75	0	20.45			
10	64QAM	1	0	21.63			22.00
10	64QAM	1	25	21.46			



10	64QAM	1	49	21.45			21.00
10	64QAM	25	0	20.47			
10	64QAM	25	12	20.59			
10	64QAM	25	25	20.34			
10	64QAM	50	0	20.47			
Channel				23900	23925	23950	Tune-up limit (dBm)
Frequency (MHz)				820	822.5	825	
10	QPSK	1	0	22.35	22.60	22.61	23.00
10	QPSK	1	25	22.42	22.35	22.22	
10	QPSK	1	49	22.53	22.29	22.17	
10	QPSK	25	0	21.50	21.64	21.46	22.00
10	QPSK	25	12	21.45	21.49	21.55	
10	QPSK	25	25	21.44	21.42	21.43	
10	QPSK	50	0	21.53	21.50	21.49	
10	16QAM	1	0	21.57	21.48	21.63	22.00
10	16QAM	1	25	21.63	21.51	21.50	
10	16QAM	1	49	21.83	21.52	21.52	
10	16QAM	25	0	20.56	20.49	20.53	21.00
10	16QAM	25	12	20.57	20.37	20.60	
10	16QAM	25	25	20.37	20.38	20.33	
10	16QAM	50	0	20.40	20.51	20.56	
10	64QAM	1	0	21.72	21.56	21.83	22.00
10	64QAM	1	25	21.41	21.20	21.25	
10	64QAM	1	49	21.88	21.38	21.44	
10	64QAM	25	0	20.58	20.64	20.45	21.00
10	64QAM	25	12	20.38	20.44	20.43	
10	64QAM	25	25	20.33	20.48	20.39	
10	64QAM	50	0	20.47	20.47	20.45	
Channel				23875	23925	23975	Tune-up limit (dBm)
Frequency (MHz)				817.5	822.5	827.5	
5	QPSK	1	0	22.21	22.32	22.33	23.00
5	QPSK	1	12	22.38	22.42	22.29	
5	QPSK	1	24	22.38	22.42	22.44	
5	QPSK	12	0	21.42	21.46	21.46	22.00
5	QPSK	12	7	21.54	21.50	21.50	
5	QPSK	12	13	21.58	21.52	21.51	



5	QPSK	25	0	21.52	21.49	21.47	
5	16QAM	1	0	21.22	21.56	21.54	22.00
5	16QAM	1	12	21.57	21.53	21.69	
5	16QAM	1	24	21.56	21.53	21.89	
5	16QAM	12	0	20.46	20.42	20.41	21.00
5	16QAM	12	7	20.48	20.43	20.58	
5	16QAM	12	13	20.67	20.47	20.47	
5	16QAM	25	0	20.53	20.54	20.42	
5	64QAM	1	0	21.44	21.46	21.45	22.00
5	64QAM	1	12	21.30	21.53	21.22	
5	64QAM	1	24	21.42	21.67	21.25	
5	64QAM	12	0	20.31	20.38	20.44	21.00
5	64QAM	12	7	20.51	20.50	20.54	
5	64QAM	12	13	20.67	20.58	20.53	
5	64QAM	25	0	20.42	20.49	20.45	

<FDD-LTE Band 19>

BW [MHz]	Modulation	RB Size	RB Offset	Power Low Ch. / Freq.	Power Middle Ch. / Freq.	Power High Ch. / Freq.	Tune-up limit (dBm)
Channel				24075	24075	24075	
Frequency (MHz)				837.5	837.5	837.5	
15	QPSK	1	0	22.65		23.00	
15	QPSK	1	37	22.35			
15	QPSK	1	74	22.51			
15	QPSK	36	0	21.64		22.00	
15	QPSK	36	20	21.62			
15	QPSK	36	39	21.56			
15	QPSK	75	0	21.64			
15	16QAM	1	0	21.62		22.00	
15	16QAM	1	37	21.84			
15	16QAM	1	74	21.53			
15	16QAM	36	0	20.59		21.00	
15	16QAM	36	20	20.61			
15	16QAM	36	39	20.54			
15	16QAM	75	0	21.44			
10	64QAM	1	0	22.02		22.50	



10	64QAM	1	25	21.61			21.00
10	64QAM	1	49	21.54			
10	64QAM	25	0	20.45			
10	64QAM	25	12	20.72			
10	64QAM	25	25	20.53			
10	64QAM	50	0	20.66			
Channel				24050	24075	24100	Tune-up limit (dBm)
Frequency (MHz)				835	837.5	840	
10	QPSK	1	0	22.45	22.49	22.32	23.00
10	QPSK	1	25	22.33	22.44	22.32	
10	QPSK	1	49	22.32	22.14	22.25	
10	QPSK	25	0	21.49	21.51	21.51	22.00
10	QPSK	25	12	21.46	21.56	21.43	
10	QPSK	25	25	21.61	21.43	21.52	
10	QPSK	50	0	21.51	21.53	21.50	
10	16QAM	1	0	21.47	21.58	21.63	22.00
10	16QAM	1	25	21.99	21.42	21.53	
10	16QAM	1	49	21.51	21.48	21.54	
10	16QAM	25	0	20.48	20.62	20.67	21.00
10	16QAM	25	12	20.54	20.42	20.43	
10	16QAM	25	25	20.52	20.46	20.53	
10	16QAM	50	0	20.44	20.55	20.51	
10	64QAM	1	0	21.66	21.48	21.62	
10	64QAM	1	25	21.55	21.29	21.83	22.50
10	64QAM	1	49	21.49	21.77	21.83	
10	64QAM	25	0	20.53	20.57	20.48	21.00
10	64QAM	25	12	20.60	20.44	20.56	
10	64QAM	25	25	20.55	20.47	20.55	
10	64QAM	50	0	20.52	20.57	20.45	
Channel				24025	24075	24125	Tune-up limit (dBm)
Frequency (MHz)				832.5	837.5	842.5	
5	QPSK	1	0	22.34	22.26	22.37	23.00
5	QPSK	1	12	22.43	22.40	22.40	
5	QPSK	1	24	22.49	22.44	22.34	
5	QPSK	12	0	21.40	21.43	21.43	22.00
5	QPSK	12	7	21.55	21.54	21.58	



5	QPSK	12	13	21.54	21.56	21.46	22.00
5	QPSK	25	0	21.48	21.50	21.42	
5	16QAM	1	0	21.35	21.24	21.83	
5	16QAM	1	12	21.55	21.55	21.99	
5	16QAM	1	24	21.50	21.58	21.94	21.00
5	16QAM	12	0	20.38	20.41	20.32	
5	16QAM	12	7	20.57	20.59	20.51	
5	16QAM	12	13	20.52	20.51	20.56	
5	16QAM	25	0	20.41	20.52	20.45	22.50
5	64QAM	1	0	21.74	21.43	21.50	
5	64QAM	1	12	21.64	21.93	21.58	
5	64QAM	1	24	21.67	21.65	21.60	
5	64QAM	12	0	20.36	20.45	20.37	21.00
5	64QAM	12	7	20.50	20.55	20.52	
5	64QAM	12	13	20.59	20.46	20.39	
5	64QAM	25	0	20.47	20.49	20.30	

<FDD-LTE Band 25>

BW [MHz]	Modulation	RB Size	RB Offset	Power Low Ch. / Freq.	Power Middle Ch. / Freq.	Power High Ch. / Freq.	Tune-up limit (dBm)
Channel				26140	26365	26590	
Frequency (MHz)				1860	1882.5	1905	
20	QPSK	1	0	19.93	20.23	19.89	20.50
20	QPSK	1	49	19.98	20.20	19.73	
20	QPSK	1	99	20.21	19.86	20.12	
20	QPSK	50	0	19.03	19.25	19.30	19.50
20	QPSK	50	24	19.20	19.33	19.30	
20	QPSK	50	50	19.32	19.15	19.05	
20	QPSK	100	0	19.13	19.27	18.99	
20	16QAM	1	0	19.14	19.32	19.21	19.50
20	16QAM	1	49	19.00	19.39	19.27	
20	16QAM	1	99	19.69	19.26	19.34	
20	16QAM	50	0	18.06	18.28	17.89	18.50
20	16QAM	50	24	18.28	18.21	17.90	
20	16QAM	50	50	18.28	18.18	18.06	
20	16QAM	100	0	18.22	18.13	17.88	



20	64QAM	1	0	18.97	19.38	19.26	19.50
20	64QAM	1	49	19.22	19.13	19.21	
20	64QAM	1	99	19.17	19.16	19.01	
20	64QAM	50	0	18.10	18.25	17.94	18.50
20	64QAM	50	24	18.13	18.27	17.98	
20	64QAM	50	50	18.35	18.19	17.99	
20	64QAM	100	0	18.26	18.21	17.96	
Channel				26115	26365	26615	Tune-up limit (dBm)
Frequency (MHz)				1857.5	1882.5	1907.5	
15	QPSK	1	0	19.82	20.18	19.82	20.50
15	QPSK	1	37	20.07	20.15	19.76	
15	QPSK	1	74	20.12	20.00	20.07	
15	QPSK	36	0	19.01	19.27	19.37	19.50
15	QPSK	36	20	19.21	19.30	19.19	
15	QPSK	36	39	19.26	19.20	19.06	
15	QPSK	75	0	19.12	19.25	18.98	
15	16QAM	1	0	19.30	19.67	18.99	19.50
15	16QAM	1	37	19.06	19.03	19.15	
15	16QAM	1	74	19.35	19.21	19.32	
15	16QAM	36	0	18.03	18.23	17.83	18.50
15	16QAM	36	20	18.19	18.31	18.07	
15	16QAM	36	39	18.23	18.21	18.22	
15	16QAM	75	0	18.17	18.21	17.94	
15	64QAM	1	0	19.04	19.39	19.25	19.50
15	64QAM	1	37	19.37	19.06	18.96	
15	64QAM	1	74	19.41	19.11	19.11	
15	64QAM	36	0	18.05	18.26	17.84	18.50
15	64QAM	36	20	18.16	18.29	17.90	
15	64QAM	36	39	18.29	18.10	18.06	
15	64QAM	75	0	18.23	18.27	17.99	
Channel				26090	26365	26640	Tune-up limit (dBm)
Frequency (MHz)				1855	1882.5	1910	
10	QPSK	1	0	19.76	19.99	19.62	20.50
10	QPSK	1	25	19.79	20.02	19.70	
10	QPSK	1	49	19.93	19.73	20.15	
10	QPSK	25	0	19.04	19.09	19.16	19.50



10	QPSK	25	12	18.97	19.18	19.17	
10	QPSK	25	25	19.04	19.10	19.06	
10	QPSK	50	0	18.97	19.11	18.95	
10	16QAM	1	0	18.83	19.15	18.87	19.50
10	16QAM	1	25	19.31	19.51	19.27	
10	16QAM	1	49	19.29	19.12	19.47	
10	16QAM	25	0	17.96	18.18	17.79	18.50
10	16QAM	25	12	18.04	18.21	17.85	
10	16QAM	25	25	18.00	18.25	18.01	
10	16QAM	50	0	17.96	18.05	17.81	
10	64QAM	1	0	19.32	19.44	19.08	19.50
10	64QAM	1	25	19.33	19.13	19.00	
10	64QAM	1	49	19.34	19.28	19.40	
10	64QAM	25	0	17.96	18.17	17.78	18.50
10	64QAM	25	12	18.04	18.04	17.81	
10	64QAM	25	25	18.13	17.99	18.02	
10	64QAM	50	0	17.93	18.15	17.98	
Channel				26065	26365	26665	Tune-up limit (dBm)
Frequency (MHz)				1852.5	1882.5	1912.5	
5	QPSK	1	0	19.68	20.06	19.53	20.50
5	QPSK	1	12	19.87	20.03	19.89	
5	QPSK	1	24	19.96	20.13	20.11	
5	QPSK	12	0	18.83	19.06	18.88	19.50
5	QPSK	12	7	18.97	19.13	19.11	
5	QPSK	12	13	19.06	19.14	19.22	
5	QPSK	25	0	18.97	19.14	19.10	19.50
5	16QAM	1	0	19.29	19.55	18.83	
5	16QAM	1	12	18.80	19.58	19.19	
5	16QAM	1	24	19.19	19.56	19.30	18.50
5	16QAM	12	0	17.87	18.15	17.84	
5	16QAM	12	7	18.02	18.17	18.11	
5	16QAM	12	13	18.04	18.13	18.10	
5	16QAM	25	0	17.84	18.16	18.08	19.50
5	64QAM	1	0	18.97	19.24	18.87	
5	64QAM	1	12	19.00	19.25	19.15	
5	64QAM	1	24	19.14	19.31	19.28	
5	64QAM	12	0	17.87	18.13	17.89	18.50



5	64QAM	12	7	18.06	18.07	18.09	
5	64QAM	12	13	17.93	18.15	18.07	
5	64QAM	25	0	18.03	18.21	18.09	
Channel				26055	26365	26675	Tune-up limit (dBm)
Frequency (MHz)				1851.5	1882.5	1913.5	
3	QPSK	1	0	19.59	20.05	19.63	20.50
3	QPSK	1	8	19.88	20.08	20.16	
3	QPSK	1	14	19.84	19.95	20.11	
3	QPSK	8	0	18.78	19.07	18.94	19.50
3	QPSK	8	4	18.87	19.10	19.10	
3	QPSK	8	7	18.88	19.06	19.20	
3	QPSK	15	0	18.91	19.11	19.05	
3	16QAM	1	0	18.57	19.06	18.90	19.50
3	16QAM	1	8	19.38	19.56	19.19	
3	16QAM	1	14	19.25	19.12	19.32	
3	16QAM	8	0	17.87	18.09	18.00	18.50
3	16QAM	8	4	17.94	18.15	18.15	
3	16QAM	8	7	17.97	17.96	18.19	
3	16QAM	15	0	17.78	18.03	18.06	
3	64QAM	1	0	18.82	19.36	18.91	19.50
3	64QAM	1	8	19.35	19.52	19.19	
3	64QAM	1	14	18.77	19.02	19.23	
3	64QAM	8	0	17.84	18.08	18.15	18.50
3	64QAM	8	4	17.96	18.12	18.09	
3	64QAM	8	7	18.12	18.28	18.11	
3	64QAM	15	0	17.85	18.07	18.05	
Channel				26047	26365	26683	Tune-up limit (dBm)
Frequency (MHz)				1850.7	1882.5	1914.3	
1.4	QPSK	1	0	19.66	19.89	19.89	20.50
1.4	QPSK	1	3	19.78	20.09	20.12	
1.4	QPSK	1	5	19.68	20.02	20.13	
1.4	QPSK	3	0	19.65	19.96	20.00	
1.4	QPSK	3	1	19.79	20.02	20.04	
1.4	QPSK	3	3	19.75	20.00	20.14	19.50
1.4	QPSK	6	0	18.79	18.99	19.11	
1.4	16QAM	1	0	19.12	19.16	19.07	19.50



1.4	16QAM	1	3	19.31	19.15	19.59	
1.4	16QAM	1	5	19.10	19.29	19.00	
1.4	16QAM	3	0	18.82	19.00	19.07	
1.4	16QAM	3	1	18.91	19.06	19.13	
1.4	16QAM	3	3	18.83	18.93	19.03	
1.4	16QAM	6	0	17.83	18.05	18.16	18.50
1.4	64QAM	1	0	18.84	19.07	19.05	19.50
1.4	64QAM	1	3	18.96	19.21	19.37	
1.4	64QAM	1	5	18.87	18.86	19.45	
1.4	64QAM	3	0	18.68	19.01	19.09	
1.4	64QAM	3	1	18.84	19.15	19.21	
1.4	64QAM	3	3	18.90	19.07	19.31	
1.4	64QAM	6	0	17.82	18.03	18.10	18.50

<FDD-LTE Band 26>

BW [MHz]	Modulation	RB Size	RB Offset	Power Low Ch. / Freq.	Power Middle Ch. / Freq.	Power High Ch. / Freq.	Tune-up limit (dBm)
Channel				26765	26865	26965	
Frequency (MHz)				821.5	831.5	841.5	
15	QPSK	1	0	22.47	22.41	22.82	
15	QPSK	1	37	22.49	22.46	22.61	23.00
15	QPSK	1	74	22.40	22.56	22.33	
15	QPSK	36	0	21.65	21.77	21.79	
15	QPSK	36	20	21.68	21.74	21.72	22.00
15	QPSK	36	39	21.63	21.68	21.68	
15	QPSK	75	0	21.60	21.71	21.70	
15	16QAM	1	0	21.80	21.83	21.82	22.00
15	16QAM	1	37	21.79	21.75	21.63	
15	16QAM	1	74	21.75	22.05	21.69	
15	16QAM	36	0	20.71	20.66	20.75	21.00
15	16QAM	36	20	20.64	20.81	20.84	
15	16QAM	36	39	20.61	20.64	20.71	
15	16QAM	75	0	20.69	20.71	20.70	
15	64QAM	1	0	21.40	21.69	21.83	22.00
15	64QAM	1	37	21.71	22.10	21.82	
15	64QAM	1	74	21.87	21.70	21.85	



15	64QAM	36	0	20.67	20.73	20.73	21.00
15	64QAM	36	20	20.65	20.66	20.70	
15	64QAM	36	39	20.69	20.72	20.73	
15	64QAM	75	0	20.71	20.79	20.84	
Channel				26740	26865	26990	Tune-up limit (dBm)
Frequency (MHz)				819	831.5	844	
10	QPSK	1	0	22.56	22.68	22.68	23.00
10	QPSK	1	25	22.64	22.37	22.57	
10	QPSK	1	49	22.40	22.58	22.61	
10	QPSK	25	0	21.62	21.70	21.79	22.00
10	QPSK	25	12	21.69	21.68	21.77	
10	QPSK	25	25	21.61	21.77	21.75	
10	QPSK	50	0	21.68	21.65	21.75	
10	16QAM	1	0	21.75	22.11	21.90	22.00
10	16QAM	1	25	21.64	21.96	21.84	
10	16QAM	1	49	21.52	21.73	22.14	
10	16QAM	25	0	20.65	20.77	20.82	21.00
10	16QAM	25	12	20.60	20.71	20.80	
10	16QAM	25	25	20.70	20.67	20.72	
10	16QAM	50	0	20.69	20.73	20.75	
10	64QAM	1	0	21.61	21.80	21.79	22.00
10	64QAM	1	25	21.55	21.81	21.94	
10	64QAM	1	49	21.47	21.56	21.82	
10	64QAM	25	0	20.74	20.80	20.67	21.00
10	64QAM	25	12	20.64	20.70	20.80	
10	64QAM	25	25	20.70	20.81	20.71	
10	64QAM	50	0	20.61	20.72	20.72	
Channel				26715	26865	27015	Tune-up limit (dBm)
Frequency (MHz)				816.5	831.5	846.5	
5	QPSK	1	0	22.22	22.36	22.46	23.00
5	QPSK	1	12	22.52	22.46	22.71	
5	QPSK	1	24	22.49	22.50	22.62	
5	QPSK	12	0	21.41	21.52	21.52	22.00
5	QPSK	12	7	21.52	21.60	21.60	
5	QPSK	12	13	21.59	21.66	21.69	
5	QPSK	25	0	21.47	21.57	21.60	



5	16QAM	1	0	21.95	21.66	21.87	22.00
5	16QAM	1	12	21.65	21.93	21.72	
5	16QAM	1	24	21.65	21.73	21.54	
5	16QAM	12	0	20.41	20.46	20.55	21.00
5	16QAM	12	7	20.63	20.61	20.60	
5	16QAM	12	13	20.59	20.66	20.70	
5	16QAM	25	0	20.56	20.59	20.59	22.00
5	64QAM	1	0	21.52	21.62	21.66	
5	64QAM	1	12	21.56	21.67	21.71	
5	64QAM	1	24	21.38	21.60	21.47	21.00
5	64QAM	12	0	20.51	20.41	20.51	
5	64QAM	12	7	20.59	20.58	20.61	
5	64QAM	12	13	20.59	20.54	20.52	Tune-up limit (dBm)
5	64QAM	25	0	20.49	20.64	20.59	
Channel				26705	26865	27025	
Frequency (MHz)				815.5	831.5	847.5	
3	QPSK	1	0	22.26	22.42	22.47	23.00
3	QPSK	1	8	22.42	22.51	22.47	
3	QPSK	1	14	22.46	22.51	22.56	
3	QPSK	8	0	21.46	21.58	21.61	22.00
3	QPSK	8	4	21.52	21.64	21.68	
3	QPSK	8	7	21.48	21.58	21.62	
3	QPSK	15	0	21.45	21.51	21.52	22.00
3	16QAM	1	0	21.64	21.91	21.98	
3	16QAM	1	8	21.89	21.94	22.05	
3	16QAM	1	14	21.91	21.92	22.00	21.00
3	16QAM	8	0	20.56	20.62	20.50	
3	16QAM	8	4	20.57	20.67	20.62	
3	16QAM	8	7	20.43	20.54	20.63	22.00
3	16QAM	15	0	20.52	20.59	20.57	
3	64QAM	1	0	21.86	21.61	21.92	
3	64QAM	1	8	21.54	21.51	21.94	21.00
3	64QAM	1	14	21.55	21.46	21.94	
3	64QAM	8	0	20.58	20.50	20.62	
3	64QAM	8	4	20.46	20.61	20.54	21.00
3	64QAM	8	7	20.51	20.57	20.61	
3	64QAM	15	0	20.51	20.43	20.60	



Channel				26697	26865	27033	Tune-up limit (dBm)
Frequency (MHz)				814.7	831.5	848.3	
1.4	QPSK	1	0	22.25	22.41	22.46	23.00
1.4	QPSK	1	3	22.41	22.50	22.46	
1.4	QPSK	1	5	22.45	22.50	22.55	
1.4	QPSK	3	0	21.45	21.57	21.60	
1.4	QPSK	3	1	21.51	21.63	21.67	
1.4	QPSK	3	3	21.47	21.57	21.61	
1.4	QPSK	6	0	21.44	21.50	21.51	22.00
1.4	16QAM	1	0	21.73	21.90	21.97	22.00
1.4	16QAM	1	3	21.88	21.93	22.04	
1.4	16QAM	1	5	21.90	21.91	21.99	
1.4	16QAM	3	0	20.55	20.61	20.49	
1.4	16QAM	3	1	20.56	20.66	20.61	
1.4	16QAM	3	3	20.42	20.53	20.62	
1.4	16QAM	6	0	20.51	20.58	20.56	21.00
1.4	64QAM	1	0	21.85	21.70	21.91	22.00
1.4	64QAM	1	3	21.73	21.48	21.86	
1.4	64QAM	1	5	21.74	21.45	21.87	
1.4	64QAM	3	0	20.57	20.49	20.61	
1.4	64QAM	3	1	20.45	20.60	20.53	
1.4	64QAM	3	3	20.50	20.56	20.60	
1.4	64QAM	6	0	20.50	20.42	20.59	21.00

<FDD-LTE Band 30>

BW [MHz]	Modulation	RB Size	RB Offset	Power Low Ch. / Freq.	Power Middle Ch. / Freq.	Power High Ch. / Freq.	Tune-up limit (dBm)
Channel				27710			
Frequency (MHz)				2310			
10	QPSK	1	0	21.57			22.00
10	QPSK	1	25	21.33			
10	QPSK	1	49	21.38			
10	QPSK	25	0	20.55			21.00
10	QPSK	25	12	20.57			
10	QPSK	25	25	20.53			



10	QPSK	50	0	20.62				
10	16QAM	1	0	20.71	21.00			
10	16QAM	1	25	20.93				
10	16QAM	1	49	20.73				
10	16QAM	25	0	19.64	20.00			
10	16QAM	25	12	19.59				
10	16QAM	25	25	19.58				
10	16QAM	50	0	19.62				
10	64QAM	1	0	20.50	21.00			
10	64QAM	1	25	20.99				
10	64QAM	1	49	20.57				
10	64QAM	25	0	19.60	20.00			
10	64QAM	25	12	19.61				
10	64QAM	25	25	19.59				
10	64QAM	50	0	19.56				
Channel				27685	27710	27735	Tune-up limit (dBm)	
Frequency (MHz)				2307.5	2310	2312.5		
5	QPSK	1	0	21.44	21.47	21.51	22.00	
5	QPSK	1	12	21.47	21.48	21.49		
5	QPSK	1	24	21.47	21.43	21.42		
5	QPSK	12	0	20.63	20.64	20.61	21.00	
5	QPSK	12	7	20.68	20.59	20.62		
5	QPSK	12	13	20.61	20.53	20.60		
5	QPSK	25	0	20.63	20.60	20.61		
5	16QAM	1	0	20.93	20.64	21.05	21.50	
5	16QAM	1	12	21.02	20.71	21.06		
5	16QAM	1	24	20.96	20.55	20.90		
5	16QAM	12	0	19.56	19.62	19.65	20.00	
5	16QAM	12	7	19.67	19.64	19.67		
5	16QAM	12	13	19.65	19.56	19.62		
5	16QAM	25	0	19.69	19.55	19.65		
5	64QAM	1	0	20.88	21.07	20.61	21.50	
5	64QAM	1	12	20.51	21.14	20.68		
5	64QAM	1	24	20.40	20.96	20.44		
5	64QAM	12	0	19.50	19.44	19.64	20.00	
5	64QAM	12	7	19.65	19.65	19.63		
5	64QAM	12	13	19.56	19.60	19.62		



5	64QAM	25	0	19.60	19.57	19.68	
---	-------	----	---	-------	-------	-------	--

<TDD-LTE Band 38>

BW [MHz]	Modulation	RB Size	RB Offset	Power Low Ch. / Freq.	Power Middle Ch. / Freq.	Power High Ch. / Freq.	Tune-up limit (dBm)
Channel				37850	38000	38150	
Frequency (MHz)				2580	2595	2610	
20	QPSK	1	0	22.79	22.82	22.94	23.50
20	QPSK	1	49	22.78	22.85	22.83	
20	QPSK	1	99	22.74	22.72	22.72	
20	QPSK	50	0	21.98	22.01	22.10	22.50
20	QPSK	50	24	21.94	22.01	22.01	
20	QPSK	50	50	22.01	22.07	22.06	
20	QPSK	100	0	21.98	22.08	22.04	22.50
20	16QAM	1	0	22.09	22.18	22.09	
20	16QAM	1	49	22.05	22.04	22.18	
20	16QAM	1	99	22.15	22.11	22.07	21.50
20	16QAM	50	0	21.17	21.10	21.05	
20	16QAM	50	24	21.10	21.10	21.10	
20	16QAM	50	50	21.06	21.05	21.06	21.50
20	16QAM	100	0	21.18	21.18	21.19	
20	64QAM	1	0	22.02	22.16	22.01	
20	64QAM	1	49	22.08	22.09	22.01	22.50
20	64QAM	1	99	21.96	22.03	21.99	
20	64QAM	50	0	20.99	21.02	20.98	
20	64QAM	50	24	20.97	21.02	21.03	21.50
20	64QAM	50	50	20.94	21.04	20.89	
20	64QAM	100	0	21.06	21.06	20.98	
Channel				37825	38000	38175	Tune-up limit (dBm)
Frequency (MHz)				2577.5	2595	2612.5	
15	QPSK	1	0	22.81	22.90	22.89	23.50
15	QPSK	1	37	22.91	22.83	22.92	
15	QPSK	1	74	22.74	22.77	22.82	
15	QPSK	36	0	21.99	21.99	21.95	22.50
15	QPSK	36	20	22.01	22.05	22.05	



15	QPSK	36	39	21.85	22.08	21.99	
15	QPSK	75	0	21.97	22.10	22.00	
15	16QAM	1	0	22.09	22.16	22.08	
15	16QAM	1	37	22.19	22.03	22.08	22.50
15	16QAM	1	74	22.05	21.98	22.02	21.50
15	16QAM	36	0	21.09	21.19	21.06	
15	16QAM	36	20	21.03	21.10	21.05	
15	16QAM	36	39	21.08	21.08	21.14	
15	16QAM	75	0	21.03	21.10	21.10	21.50
15	64QAM	1	0	22.02	22.11	22.03	
15	64QAM	1	37	22.11	22.07	22.11	
15	64QAM	1	74	22.15	22.00	22.05	21.00
15	64QAM	36	0	21.02	21.16	21.17	
15	64QAM	36	20	21.04	21.11	21.06	
15	64QAM	36	39	21.14	21.14	21.01	
15	64QAM	75	0	21.07	21.03	21.05	Tune-up limit (dBm)
Channel				37800	38000	38200	
Frequency (MHz)				2575	2595	2615	
10	QPSK	1	0	22.58	22.78	22.62	23.50
10	QPSK	1	25	22.53	22.65	22.63	
10	QPSK	1	49	22.51	22.66	22.64	
10	QPSK	25	0	21.82	21.96	21.83	22.50
10	QPSK	25	12	21.83	21.89	21.83	
10	QPSK	25	25	21.84	21.94	21.87	
10	QPSK	50	0	21.83	21.88	21.84	
10	16QAM	1	0	21.79	21.95	21.92	22.50
10	16QAM	1	25	21.85	22.02	21.89	
10	16QAM	1	49	21.82	21.90	21.94	
10	16QAM	25	0	20.89	20.96	20.94	21.50
10	16QAM	25	12	20.84	20.99	20.95	
10	16QAM	25	25	20.89	20.89	20.88	
10	16QAM	50	0	20.79	20.93	20.94	
10	64QAM	1	0	21.75	21.85	21.91	21.50
10	64QAM	1	25	21.82	21.92	21.93	
10	64QAM	1	49	21.73	21.93	21.80	
10	64QAM	25	0	20.80	20.90	20.77	21.00
10	64QAM	25	12	20.92	20.88	20.83	



10	64QAM	25	25	20.83	20.83	20.86	
10	64QAM	50	0	20.86	20.91	20.92	
Channel				37775	38000	38225	Tune-up limit (dBm)
Frequency (MHz)				2572.5	2595	2617.5	
5	QPSK	1	0	22.43	22.73	22.65	23.50
5	QPSK	1	12	22.60	22.85	22.73	
5	QPSK	1	24	22.67	22.74	22.62	
5	QPSK	12	0	21.78	21.84	21.83	22.50
5	QPSK	12	7	21.87	22.02	21.93	
5	QPSK	12	13	21.83	21.91	21.93	
5	QPSK	25	0	21.90	21.79	21.76	
5	16QAM	1	0	21.86	21.97	21.90	22.50
5	16QAM	1	12	22.01	22.14	21.97	
5	16QAM	1	24	21.95	22.00	21.96	
5	16QAM	12	0	20.90	20.89	20.93	21.50
5	16QAM	12	7	20.95	21.01	21.03	
5	16QAM	12	13	20.94	20.98	20.98	
5	16QAM	25	0	20.89	20.89	20.92	
5	64QAM	1	0	21.73	21.88	21.80	21.50
5	64QAM	1	12	21.92	21.96	21.95	
5	64QAM	1	24	21.98	21.99	21.92	
5	64QAM	12	0	20.78	20.77	20.82	21.00
5	64QAM	12	7	20.84	20.96	20.92	
5	64QAM	12	13	20.88	20.98	20.91	
5	64QAM	25	0	20.86	20.82	20.81	



<TDD-LTE Band 40A>

BW [MHz]	Modulation	RB Size	RB Offset	Power Low Ch. / Freq.	Power Middle Ch. / Freq.	Power High Ch. / Freq.	Tune-up limit (dBm)
Channel				38750			
Frequency (MHz)				2310			
10	QPSK	1	0	22.66			23.00
10	QPSK	1	25	22.60			
10	QPSK	1	49	22.42			
10	QPSK	25	0	21.78			22.00
10	QPSK	25	12	21.68			
10	QPSK	25	25	21.69			
10	QPSK	50	0	21.71			
10	16QAM	1	0	21.91			22.00
10	16QAM	1	25	21.77			
10	16QAM	1	49	21.63			
10	16QAM	25	0	20.84			21.00
10	16QAM	25	12	20.78			
10	16QAM	25	25	20.73			
10	16QAM	50	0	20.78			
10	64QAM	1	0	21.82			21.00
10	64QAM	1	25	21.85			
10	64QAM	1	49	21.69			
10	64QAM	25	0	20.82			20.00
10	64QAM	25	12	20.71			
10	64QAM	25	25	20.65			
10	64QAM	50	0	20.80			
Channel				38725	38750	38775	Tune-up limit (dBm)
Frequency (MHz)				2307.5	2310	2312.5	
5	QPSK	1	0	22.53	22.60	22.62	23.00
5	QPSK	1	12	22.54	22.65	22.53	
5	QPSK	1	24	22.50	22.58	22.57	
5	QPSK	12	0	21.73	21.80	21.77	22.00
5	QPSK	12	7	21.80	21.88	21.94	
5	QPSK	12	13	21.74	21.83	21.89	
5	QPSK	25	0	21.80	21.83	21.86	



5	16QAM	1	0	21.88	22.00	21.92	22.00
5	16QAM	1	12	21.87	21.93	22.00	
5	16QAM	1	24	21.70	21.80	21.81	
5	16QAM	12	0	20.82	20.89	20.88	21.00
5	16QAM	12	7	20.85	20.92	20.89	
5	16QAM	12	13	20.86	20.92	20.93	
5	16QAM	25	0	20.94	20.85	20.93	21.00
5	64QAM	1	0	21.78	21.89	21.93	
5	64QAM	1	12	21.84	21.86	21.89	
5	64QAM	1	24	21.75	21.79	21.81	
5	64QAM	12	0	20.80	20.88	20.88	
5	64QAM	12	7	20.80	20.86	20.85	
5	64QAM	12	13	20.80	20.81	20.79	
5	64QAM	25	0	20.85	20.88	20.86	20.00

<TDD-LTE Band 40B>

BW [MHz]	Modulation	RB Size	RB Offset	Power Low Ch. / Freq.	Power Middle Ch. / Freq.	Power High Ch. / Freq.	Tune-up limit (dBm)
Channel				39200			
Frequency (MHz)				2355			
10	QPSK	1	0	22.62			23.00
10	QPSK	1	25	22.77			
10	QPSK	1	49	22.34			
10	QPSK	25	0	21.79			22.00
10	QPSK	25	12	21.72			
10	QPSK	25	25	21.64			
10	QPSK	50	0	21.82			
10	16QAM	1	0	21.95			22.00
10	16QAM	1	25	21.97			
10	16QAM	1	49	21.85			
10	16QAM	25	0	20.86			21.00
10	16QAM	25	12	20.82			
10	16QAM	25	25	20.82			
10	16QAM	50	0	20.86			
10	64QAM	1	0	21.95			21.00
10	64QAM	1	25	21.88			



10	64QAM	1	49	21.71			20.00
10	64QAM	25	0	20.83			
10	64QAM	25	12	20.82			
10	64QAM	25	25	20.75			
10	64QAM	50	0	20.77			
Channel				39175	39200	39225	Tune-up limit (dBm)
Frequency (MHz)				2352.5	2355	2357.5	
5	QPSK	1	0	22.70	22.67	22.73	23.00
5	QPSK	1	12	22.71	22.62	22.75	
5	QPSK	1	24	22.47	22.63	22.62	
5	QPSK	12	0	21.79	21.92	21.96	22.00
5	QPSK	12	7	21.86	21.84	21.89	
5	QPSK	12	13	21.80	21.81	21.88	
5	QPSK	25	0	21.81	21.82	21.87	
5	16QAM	1	0	21.90	21.92	21.99	22.00
5	16QAM	1	12	21.95	21.93	21.90	
5	16QAM	1	24	21.80	21.86	21.84	
5	16QAM	12	0	20.90	20.90	20.91	21.00
5	16QAM	12	7	20.88	20.93	20.95	
5	16QAM	12	13	20.83	20.90	20.93	
5	16QAM	25	0	20.85	20.76	20.83	
5	64QAM	1	0	21.91	21.93	22.04	21.00
5	64QAM	1	12	21.83	21.85	21.89	
5	64QAM	1	24	21.83	21.73	21.73	
5	64QAM	12	0	20.88	20.79	20.80	20.00
5	64QAM	12	7	20.92	20.82	20.91	
5	64QAM	12	13	20.86	20.90	20.83	
5	64QAM	25	0	20.81	20.79	20.91	



<TDD-LTE Band 41>

BW [MHz]	Modulation	RB Size	RB Offset	Power Low Ch. / Freq.	Power Middle Low Ch. / Freq.	Power Middle High Ch. / Freq.	Power High Ch. / Freq.	Tune-up limit (dBm)
Channel				40340	40600	40870	41140	
Frequency (MHz)				2565	2591	2618	2645	
20	QPSK	1	0	22.87	22.67	22.82	22.93	
20	QPSK	1	49	22.87	22.77	22.75	22.61	
20	QPSK	1	99	22.94	22.80	22.68	22.61	
20	QPSK	50	0	22.15	21.87	22.03	22.04	22.50
20	QPSK	50	24	22.09	22.08	21.96	21.89	
20	QPSK	50	50	22.10	22.10	21.93	21.76	
20	QPSK	100	0	22.12	22.04	21.94	21.92	
20	16QAM	1	0	22.20	21.96	22.09	22.11	22.50
20	16QAM	1	49	22.08	22.15	21.96	21.97	
20	16QAM	1	99	22.04	22.22	21.95	21.70	
20	16QAM	50	0	21.16	21.04	21.07	21.06	21.50
20	16QAM	50	24	21.10	21.09	21.04	20.93	
20	16QAM	50	50	21.03	21.07	21.01	20.75	
20	16QAM	100	0	21.03	21.05	21.04	20.91	
20	64QAM	1	0	22.13	21.86	21.96	22.18	21.50
20	64QAM	1	49	22.06	22.06	21.92	21.79	
20	64QAM	1	99	22.06	22.02	21.93	21.66	
20	64QAM	50	0	21.14	20.91	20.96	20.97	20.50
20	64QAM	50	24	21.08	21.02	21.06	20.97	
20	64QAM	50	50	21.00	21.07	20.89	20.69	
20	64QAM	100	0	21.14	21.13	21.02	20.92	
Channel				40315	40595	40885	41165	Tune-up limit (dBm)
Frequency (MHz)				2562.5	2590.5	2619.5	2647.5	
15	QPSK	1	0	22.87	22.72	22.83	22.90	23.50
15	QPSK	1	37	22.93	22.90	22.72	22.75	
15	QPSK	1	74	22.87	22.90	22.88	22.49	
15	QPSK	36	0	22.08	21.96	21.95	22.04	22.50
15	QPSK	36	20	22.06	21.99	22.06	21.87	
15	QPSK	36	39	21.96	22.12	21.95	21.75	



15	QPSK	75	0	22.09	21.98	21.99	21.86	
15	16QAM	1	0	22.01	21.97	21.99	22.14	22.50
15	16QAM	1	37	22.17	22.13	22.09	21.89	
15	16QAM	1	74	22.12	22.23	21.96	21.74	
15	16QAM	36	0	21.01	20.87	20.97	21.01	21.50
15	16QAM	36	20	21.03	20.98	20.96	20.90	
15	16QAM	36	39	21.01	21.11	20.95	20.74	
15	16QAM	75	0	21.07	21.06	20.97	20.87	
15	64QAM	1	0	22.03	21.88	21.95	22.13	21.50
15	64QAM	1	37	22.15	21.98	21.93	21.75	
15	64QAM	1	74	22.13	22.00	22.01	22.07	
15	64QAM	36	0	21.04	20.91	20.97	21.04	20.50
15	64QAM	36	20	21.02	21.09	20.94	20.88	
15	64QAM	36	39	21.08	21.13	20.93	20.76	
15	64QAM	75	0	21.01	21.05	21.03	20.91	
Channel				40290	40590	40890	41190	Tune-up limit (dBm)
Frequency (MHz)				2560	2590	2620	2650	
10	QPSK	1	0	22.70	22.61	22.65	22.51	23.50
10	QPSK	1	25	22.63	22.81	22.67	22.65	
10	QPSK	1	49	22.71	22.63	22.58	22.54	
10	QPSK	25	0	21.87	21.89	21.88	21.80	22.50
10	QPSK	25	12	21.83	21.90	21.88	21.82	
10	QPSK	25	25	21.85	21.85	21.79	21.68	
10	QPSK	50	0	21.72	21.92	21.86	21.76	
10	16QAM	1	0	21.91	22.03	21.94	21.89	22.50
10	16QAM	1	25	21.86	21.89	22.03	21.97	
10	16QAM	1	49	21.85	21.93	21.91	21.87	
10	16QAM	25	0	21.00	20.98	20.94	20.85	21.50
10	16QAM	25	12	20.91	20.91	20.93	20.81	
10	16QAM	25	25	20.81	20.88	20.88	20.70	
10	16QAM	50	0	20.89	20.97	20.93	20.75	
10	64QAM	1	0	21.80	21.85	21.85	21.90	21.50
10	64QAM	1	25	21.95	21.77	21.94	21.69	
10	64QAM	1	49	21.87	21.86	21.80	21.68	
10	64QAM	25	0	20.94	20.92	20.78	20.75	20.50
10	64QAM	25	12	20.80	20.96	20.76	20.75	
10	64QAM	25	25	20.75	20.88	20.78	20.65	



10	64QAM	50	0	20.81	20.88	20.77	20.83	
Channel				40265	40585	40905	41215	Tune-up limit (dBm)
Frequency (MHz)				2557.5	2589.5	2621.5	2652.5	
5	QPSK	1	0	22.69	22.71	22.72	22.73	23.50
5	QPSK	1	12	22.76	22.79	22.63	22.66	
5	QPSK	1	24	22.73	22.75	22.66	22.57	
5	QPSK	12	0	21.88	21.91	21.90	21.84	22.50
5	QPSK	12	7	21.93	21.96	21.95	21.88	
5	QPSK	12	13	21.87	21.94	21.90	21.83	
5	QPSK	25	0	21.92	21.91	21.89	21.79	22.50
5	16QAM	1	0	22.03	21.98	21.95	21.94	
5	16QAM	1	12	22.07	22.04	21.97	21.91	
5	16QAM	1	24	21.94	22.03	21.92	21.78	21.50
5	16QAM	12	0	20.94	20.92	20.94	20.87	
5	16QAM	12	7	20.98	20.99	20.88	20.88	
5	16QAM	12	13	20.94	20.95	20.94	20.82	21.50
5	16QAM	25	0	21.01	20.89	20.90	20.88	
5	64QAM	1	0	21.90	21.92	21.90	21.90	
5	64QAM	1	12	21.97	22.01	21.95	21.79	21.50
5	64QAM	1	24	21.96	21.93	21.91	21.87	
5	64QAM	12	0	20.89	20.87	20.93	20.77	
5	64QAM	12	7	20.94	20.95	20.92	20.88	21.00
5	64QAM	12	13	20.84	21.01	20.90	20.77	
5	64QAM	25	0	20.90	20.82	20.83	20.77	



<FDD-LTE Band 66>

BW [MHz]	Modulation	RB Size	RB Offset	Power Low Ch. / Freq.	Power Middle Ch. / Freq.	Power High Ch. / Freq.	Tune-up limit (dBm)
Channel				132072	132322	132572	
Frequency (MHz)				1720	1745	1770	
20	QPSK	1	0	22.37	22.31	22.72	23.00
20	QPSK	1	49	22.39	22.36	22.51	
20	QPSK	1	99	22.30	22.46	22.23	
20	QPSK	50	0	21.55	21.67	21.69	22.00
20	QPSK	50	24	21.58	21.64	21.62	
20	QPSK	50	50	21.53	21.58	21.58	
20	QPSK	100	0	21.50	21.61	21.60	
20	16QAM	1	0	21.70	21.73	21.72	22.00
20	16QAM	1	49	21.69	21.65	21.53	
20	16QAM	1	99	21.65	21.95	21.59	
20	16QAM	50	0	20.61	20.56	20.65	21.00
20	16QAM	50	24	20.54	20.71	20.74	
20	16QAM	50	50	20.51	20.54	20.61	
20	16QAM	100	0	20.59	20.61	20.60	
20	64QAM	1	0	21.30	21.59	21.73	22.00
20	64QAM	1	49	21.61	21.70	21.72	
20	64QAM	1	99	21.77	21.60	21.75	
20	64QAM	50	0	20.57	20.63	20.63	21.00
20	64QAM	50	24	20.55	20.56	20.60	
20	64QAM	50	50	20.59	20.62	20.63	
20	64QAM	100	0	20.61	20.69	20.74	
Channel				132047	132322	132597	Tune-up limit (dBm)
Frequency (MHz)				1717.5	1745	1772.5	
15	QPSK	1	0	22.46	22.58	22.58	23.00
15	QPSK	1	37	22.54	22.27	22.47	
15	QPSK	1	74	22.30	22.48	22.51	
15	QPSK	36	0	21.52	21.60	21.69	22.00
15	QPSK	36	20	21.59	21.58	21.67	
15	QPSK	36	39	21.51	21.67	21.65	
15	QPSK	75	0	21.58	21.55	21.65	



15	16QAM	1	0	21.65	22.01	21.80	22.00
15	16QAM	1	37	21.54	21.86	21.74	
15	16QAM	1	74	21.42	21.63	22.04	
15	16QAM	36	0	20.55	20.67	20.72	21.00
15	16QAM	36	20	20.50	20.61	20.70	
15	16QAM	36	39	20.60	20.57	20.62	
15	16QAM	75	0	20.59	20.63	20.65	22.50
15	64QAM	1	0	21.51	21.70	21.49	
15	64QAM	1	37	21.45	21.71	21.54	
15	64QAM	1	74	21.64	21.70	21.57	21.50
15	64QAM	36	0	20.54	20.60	20.70	
15	64QAM	36	20	20.60	20.71	20.61	
15	64QAM	36	39	20.51	20.62	20.62	Tune-up limit (dBm)
15	64QAM	75	0	20.44	20.58	20.57	
Channel				132022	132322	132622	
Frequency (MHz)				1715	1745	1775	
10	QPSK	1	0	22.12	22.26	22.36	23.00
10	QPSK	1	25	22.42	22.36	22.61	
10	QPSK	1	49	22.39	22.40	22.52	
10	QPSK	25	0	21.31	21.42	21.42	22.00
10	QPSK	25	12	21.42	21.50	21.50	
10	QPSK	25	25	21.49	21.56	21.59	
10	QPSK	50	0	21.37	21.47	21.50	22.00
10	16QAM	1	0	21.85	21.56	21.77	
10	16QAM	1	25	21.55	21.83	21.62	
10	16QAM	1	49	21.55	21.43	21.24	21.00
10	16QAM	25	0	20.31	20.36	20.45	
10	16QAM	25	12	20.53	20.51	20.50	
10	16QAM	25	25	20.49	20.56	20.60	21.00
10	16QAM	50	0	20.46	20.49	20.49	
10	64QAM	1	0	21.42	21.52	21.56	
10	64QAM	1	25	21.46	21.57	21.61	21.50
10	64QAM	1	49	21.28	21.50	21.37	
10	64QAM	25	0	20.41	20.31	20.41	
10	64QAM	25	12	20.49	20.48	20.51	21.50
10	64QAM	25	25	20.49	20.44	20.42	
10	64QAM	50	0	20.39	20.54	20.49	



Channel				131997	132322	132647	Tune-up limit (dBm)
Frequency (MHz)				1712.5	1745	1777.5	
5	QPSK	1	0	22.16	22.32	22.37	23.00
5	QPSK	1	12	22.32	22.41	22.37	
5	QPSK	1	24	22.36	22.41	22.46	
5	QPSK	12	0	21.36	21.48	21.51	22.00
5	QPSK	12	7	21.42	21.54	21.58	
5	QPSK	12	13	21.38	21.48	21.52	
5	QPSK	25	0	21.35	21.41	21.42	
5	16QAM	1	0	21.44	21.81	21.88	22.00
5	16QAM	1	12	21.79	21.84	21.95	
5	16QAM	1	24	21.81	21.82	21.90	
5	16QAM	12	0	20.46	20.52	20.40	21.00
5	16QAM	12	7	20.47	20.57	20.52	
5	16QAM	12	13	20.33	20.44	20.53	
5	16QAM	25	0	20.42	20.49	20.47	
5	64QAM	1	0	21.76	21.41	21.82	21.00
5	64QAM	1	12	21.44	21.31	21.84	
5	64QAM	1	24	21.45	21.36	21.84	
5	64QAM	12	0	20.48	20.40	20.52	21.50
5	64QAM	12	7	20.36	20.51	20.44	
5	64QAM	12	13	20.41	20.47	20.51	
5	64QAM	25	0	20.41	20.33	20.50	
Channel				131987	132322	132657	Tune-up limit (dBm)
Frequency (MHz)				1711.5	1745	1778.5	
3	QPSK	1	0	22.14	22.30	22.35	23.00
3	QPSK	1	8	22.30	22.39	22.35	
3	QPSK	1	14	22.34	22.39	22.44	
3	QPSK	8	0	21.34	21.46	21.49	22.00
3	QPSK	8	4	21.40	21.52	21.56	
3	QPSK	8	7	21.36	21.46	21.50	
3	QPSK	15	0	21.33	21.39	21.40	
3	16QAM	1	0	21.42	21.79	21.86	22.00
3	16QAM	1	8	21.77	21.82	21.93	
3	16QAM	1	14	21.79	21.80	21.88	
3	16QAM	8	0	20.44	20.50	20.38	21.00



3	16QAM	8	4	20.45	20.55	20.50	
3	16QAM	8	7	20.31	20.42	20.51	
3	16QAM	15	0	20.40	20.47	20.45	
3	64QAM	1	0	21.74	21.39	21.80	21.00
3	64QAM	1	8	21.42	21.29	21.82	
3	64QAM	1	14	21.43	21.34	21.82	
3	64QAM	8	0	20.46	20.38	20.50	20.00
3	64QAM	8	4	20.34	20.49	20.42	
3	64QAM	8	7	20.39	20.45	20.49	
3	64QAM	15	0	20.39	20.31	20.48	
Channel				131979	132322	132665	Tune-up limit (dBm)
Frequency (MHz)				1710.7	1745	1779.3	
1.4	QPSK	1	0	22.18	22.34	22.39	23.00
1.4	QPSK	1	3	22.34	22.43	22.39	
1.4	QPSK	1	5	22.38	22.43	22.48	
1.4	QPSK	3	0	21.38	21.50	21.53	
1.4	QPSK	3	1	21.44	21.56	21.60	
1.4	QPSK	3	3	21.40	21.50	21.54	
1.4	QPSK	6	0	21.37	21.43	21.44	22.00
1.4	16QAM	1	0	21.46	21.83	21.90	22.00
1.4	16QAM	1	3	21.81	21.86	21.97	
1.4	16QAM	1	5	21.83	21.84	21.92	
1.4	16QAM	3	0	20.48	20.54	20.42	
1.4	16QAM	3	1	20.49	20.59	20.54	
1.4	16QAM	3	3	20.35	20.46	20.55	
1.4	16QAM	6	0	20.44	20.51	20.49	21.00
1.4	64QAM	1	0	21.78	21.43	21.84	21.00
1.4	64QAM	1	3	21.46	21.33	21.86	
1.4	64QAM	1	5	21.47	21.38	21.86	
1.4	64QAM	3	0	20.50	20.42	20.54	
1.4	64QAM	3	1	20.38	20.53	20.46	
1.4	64QAM	3	3	20.43	20.49	20.53	
1.4	64QAM	6	0	20.43	20.35	20.52	20.00

➤ WLAN Conducted Power

<2.4GHz WLAN Ant 0>

	Mode	Channel	Frequency (MHz)	Average power (dBm)	Tune-Up Limit	Duty Cycle %
2.4GHz WLAN ANT 0	802.11b 1Mbps	CH 1	2412	14.67	15.00	99.04
		CH 6	2437	14.17	15.00	
		CH 11	2462	14.49	15.00	
	802.11g 6Mbps	CH 1	2412	13.49	14.00	98.10
		CH 6	2437	13.47	14.00	
		CH 11	2462	13.68	14.00	
	802.11n-HT20 MCS0	CH 1	2412	13.31	14.00	98.21
		CH 6	2437	13.43	14.00	
		CH 11	2462	13.58	14.00	
	802.11n-HT40 MCS0	CH 3	2422	13.74	14.50	95.00
		CH 6	2437	14.05	14.50	
		CH 9	2452	14.20	14.50	

<2.4GHz WLAN Ant 1>

	Mode	Channel	Frequency (MHz)	Average power (dBm)	Tune-Up Limit	Duty Cycle %
2.4GHz WLAN ANT 1	802.11b 1Mbps	CH 1	2412	12.86	14.00	99.04
		CH 6	2437	12.73	14.00	
		CH 11	2462	13.61	14.00	
	802.11g 6Mbps	CH 1	2412	12.26	13.00	98.10
		CH 6	2437	12.59	13.00	
		CH 11	2462	12.85	13.00	
	802.11n-HT20 MCS0	CH 1	2412	12.51	13.00	98.21
		CH 6	2437	12.56	13.00	
		CH 11	2462	12.97	13.00	
	802.11n-HT40 MCS0	CH 3	2422	12.57	13.00	95.00
		CH 6	2437	12.78	13.00	
		CH 9	2452	12.97	13.00	

Note:

- Per KDB 447498 D01v06, the 1-g SAR test exclusion thresholds for 100 MHz to 6 GHz at *test separation distances* ≤ 50 mm are determined by:

$$[(\text{max. power of channel, including tune-up tolerance, mW}) / (\text{min. test separation distance, mm})] \cdot [\sqrt{f(\text{GHz})}] \leq 3.0 \text{ for 1-g SAR, where}$$

- f(GHz) is the RF channel transmit frequency in GHz
- Power and distance are rounded to the nearest mW and mm before calculation
- The result is rounded to one decimal place for comparison

Antenna	Frequency (GHz)	Max. Tune-up Power (dBm)	Max. Power (mW)	Test distance (mm)	Result	exclusion thresholds for 1-g SAR
ANT 0	2.412	15.00	31.62	5	9.82	3.0
ANT 1	2.462	14.00	25.12	5	7.88	3.0

2. Base on the result of note1, RF exposure evaluation of 802.11 b and g mode is required.
3. Per KDB 248227 D01v02r02, choose the highest output power channel to test SAR and determine further SAR exclusion.
4. Per KDB 248227 D01v02r02, In the 2.4 GHz band, separate SAR procedures are applied to DSSS and OFDM configurations to simplify DSSS test requirements. SAR is not required for the following 2.4 GHz OFDM conditions:
 - 1) When KDB Publication 447498 SAR test exclusion applies to the OFDM configuration.
 - 2) When the highest reported SAR for DSSS is adjusted by the ratio of OFDM to DSSS specified maximum output power and the adjusted SAR is ≤ 1.2 W/kg.
5. The output power of all data rate were pre-scan, just the worst case (the lowest data rate) of all mode were shown in report.

<5.2GHz WLAN Ant 0>

	Mode	Channel	Frequency (MHz)	Average power (dBm)	Tune-Up Limit	Duty Cycle %
5.2GHz WLAN ANT 0	802.11a 6Mbps	CH 36	5180	9.92	10.00	98.10
		CH 40	5200	9.72	10.00	
		CH 48	5240	9.38	9.50	
	802.11n-HT20 MCS0	CH 36	5180	9.30	9.50	97.96
		CH 40	5200	9.36	9.50	
		CH 48	5240	9.17	9.50	
	802.11n-HT40 MCS0	CH 38	5190	9.51	10.00	96.34
		CH 46	5230	9.28	9.50	
	802.11ac-VHT20 MCS0	CH 36	5180	9.51	10.00	98.22
		CH 40	5200	9.13	9.50	
		CH 48	5240	9.16	9.50	
	802.11ac-VHT40 MCS0	CH 38	5190	9.53	10.00	96.36
CH 46		5230	9.47	9.50		

<5.2GHz WLAN Ant 1>

	Mode	Channel	Frequency (MHz)	Average power (dBm)	Tune-Up Limit	Duty Cycle %
5.2GHz WLAN ANT 1	802.11a 6Mbps	CH 36	5180	10.28	10.50	98.10
		CH 40	5200	10.10	10.50	
		CH 48	5240	10.06	10.50	
	802.11n-HT20 MCS0	CH 36	5180	10.45	10.50	97.96
		CH 40	5200	10.51	11.00	
		CH 48	5240	10.98	11.00	
	802.11n-HT40 MCS0	CH 38	5190	11.52	12.00	96.34
		CH 46	5230	11.02	11.50	
	802.11ac-VHT20 MCS0	CH 36	5180	11.16	11.50	98.22
		CH 40	5200	11.13	11.50	
		CH 48	5240	11.03	11.50	
	802.11ac-VHT40 MCS0	CH 38	5190	11.41	11.50	96.36
CH 46		5230	11.18	11.50		

Note:

- Per KDB 447498 D01v06, the 1-g SAR test exclusion thresholds for 100 MHz to 6 GHz at *test separation distances* ≤50 mm are determined by:

$[(\text{max. power of channel, including tune-up tolerance, mW}) / (\text{min. test separation distance, mm})] \cdot [\sqrt{f(\text{GHz})}] \leq 3.0$ for 1-g SAR, where

- f(GHz) is the RF channel transmit frequency in GHz
- Power and distance are rounded to the nearest mW and mm before calculation
- The result is rounded to one decimal place for comparison

Antenna	Frequency (GHz)	Max. Tune-up Power (dBm)	Max. Power (mW)	Test distance (mm)	Result	exclusion thresholds for 1-g SAR
ANT 0	5.190	10.00	10.00	5	4.56	3.0
ANT 1	5.190	12.00	15.85	5	7.22	3.0

- Per KDB 248227 D01v02r02, choose the highest output power channel to test SAR and determine further SAR exclusion.
- The output power of all data rate were pre-scan, just the worst case (the lowest data rate) of all mode were shown in report.



<5.3GHz WLAN Ant 0>

5.3GHz WLAN ANT 0	Mode	Channel	Frequency (MHz)	Average power (dBm)	Tune-Up Limit	Duty Cycle %
	802.11a 6Mbps	CH 52	5260	9.37	9.50	98.10
		CH 60	5300	9.54	10.00	
		CH 64	5320	9.54	10.00	
	802.11n-HT20 MCS0	CH 52	5260	9.12	9.50	97.96
		CH 60	5300	9.12	9.50	
		CH 64	5320	9.07	9.50	
	802.11n-HT40 MCS0	CH 54	5270	9.07	9.50	96.34
		CH 62	5310	9.31	9.50	
	802.11ac-VHT20 MCS0	CH 52	5260	9.78	10.00	98.22
CH 60		5300	9.15	9.50		
CH 64		5320	9.34	9.50		
802.11ac-VHT40 MCS0	CH 54	5270	9.12	9.50	96.36	
	CH 62	5310	9.19	9.50		

<5.3GHz WLAN Ant 1>

5.3GHz WLAN ANT 1	Mode	Channel	Frequency (MHz)	Average power (dBm)	Tune-Up Limit	Duty Cycle %
	802.11a 6Mbps	CH 52	5260	10.20	10.50	98.10
		CH 60	5300	10.33	10.50	
		CH 64	5320	10.47	10.50	
	802.11n-HT20 MCS0	CH 52	5260	11.02	11.50	97.96
		CH 60	5300	11.05	11.50	
		CH 64	5320	10.89	11.00	
	802.11n-HT40 MCS0	CH 54	5270	11.01	11.50	96.34
		CH 62	5310	11.84	12.00	
	802.11ac-VHT20 MCS0	CH 52	5260	11.79	12.00	98.22
CH 60		5300	11.13	11.50		
CH 64		5320	11.43	11.50		
802.11ac-VHT40 MCS0	CH 54	5270	11.42	11.50	96.36	
	CH 62	5310	11.82	12.00		



Note:

1. Per KDB 447498 D01v06, the 1-g SAR test exclusion thresholds for 100 MHz to 6 GHz at *test separation distances* ≤50 mm are determined by:

$$[(\text{max. power of channel, including tune-up tolerance, mW}) / (\text{min. test separation distance, mm})] \cdot [\sqrt{f(\text{GHz})}] \leq 3.0 \text{ for 1-g SAR, where}$$

- f(GHz) is the RF channel transmit frequency in GHz
- Power and distance are rounded to the nearest mW and mm before calculation
- The result is rounded to one decimal place for comparison

Antenna	Frequency (GHz)	Max. Tune-up Power (dBm)	Max. Power (mW)	Test distance (mm)	Result	exclusion thresholds for 1-g SAR
ANT 0	5.260	10.00	10.00	5	4.59	3.0
ANT 1	5.310	12.00	15.85	5	7.30	3.0

2. Per KDB 248227 D01v02r02, choose the highest output power channel to test SAR and determine further SAR exclusion.
3. The output power of all data rate were pre-scan, just the worst case (the lowest data rate) of all mode were shown in report.

<5.5GHz WLAN Ant 0>

5.5GHz WLAN ANT 0	Mode	Channel	Frequency (MHz)	Average power (dBm)	Tune-Up Limit	Duty Cycle %
	802.11a 6Mbps		CH 100	5500	9.26	9.50
CH 120			5600	10.23	10.50	
CH 144			5720	11.29	11.50	
802.11n-HT20 MCS0		CH 100	5500	9.24	9.50	97.96
		CH 120	5600	10.51	11.00	
		CH 144	5720	11.47	11.50	
802.11n-HT40 MCS0		CH 102	5510	10.51	11.00	96.34
		CH 126	5630	11.15	11.50	
		CH 142	5710	12.27	12.50	
802.11ac-VHT20 MCS0		CH 100	5500	9.41	9.50	98.22
		CH 120	5600	10.61	11.00	
		CH 144	5720	11.34	11.50	
802.11ac-VHT40 MCS0		CH 102	5510	9.83	10.00	96.36
		CH 126	5630	10.63	11.00	
		CH 142	5710	11.75	12.00	

<5.5GHz WLAN Ant 1>

	Mode	Channel	Frequency (MHz)	Average power (dBm)	Tune-Up Limit	Duty Cycle %
5.5GHz WLAN ANT 1	802.11a 6Mbps	CH 100	5500	10.27	10.50	98.10
		CH 120	5600	11.10	11.50	
		CH 144	5720	11.65	12.00	
	802.11n-HT20 MCS0	CH 100	5500	11.56	12.00	97.96
		CH 120	5600	12.37	12.50	
		CH 144	5720	12.55	13.00	
	802.11n-HT40 MCS0	CH 102	5510	12.59	13.00	96.34
		CH 126	5630	12.91	13.00	
		CH 142	5710	12.88	13.00	
	802.11ac-VHT20 MCS0	CH 100	5500	12.10	12.50	98.22
		CH 120	5600	12.46	12.50	
		CH 144	5720	12.36	12.50	
	802.11ac-VHT40 MCS0	CH 102	5510	12.73	13.00	96.36
		CH 126	5630	13.09	13.50	
		CH 142	5710	12.79	13.00	

Note:

- Per KDB 447498 D01v06, the 1-g SAR test exclusion thresholds for 100 MHz to 6 GHz at *test separation distances* ≤ 50 mm are determined by:

$$[(\text{max. power of channel, including tune-up tolerance, mW}) / (\text{min. test separation distance, mm})] \cdot [\sqrt{f(\text{GHz})}] \leq 3.0$$
 for 1-g SAR, where

- f(GHz) is the RF channel transmit frequency in GHz
- Power and distance are rounded to the nearest mW and mm before calculation
- The result is rounded to one decimal place for comparison

Antenna	Frequency (GHz)	Max. Tune-up Power (dBm)	Max. Power (mW)	Test distance (mm)	Result	exclusion thresholds for 1-g SAR
ANT 0	5.710	12.50	17.78	5	8.50	3.0
ANT 1	5.630	13.50	22.39	5	10.62	3.0

- Per KDB 248227 D01v02r02, choose the highest output power channel to test SAR and determine further SAR exclusion.
- The output power of all data rate were pre-scan, just the worst case (the lowest data rate) of all mode were shown in report.



<5.8GHz WLAN Ant 0>

	Mode	Channel	Frequency (MHz)	Average power (dBm)	Tune-Up Limit	Duty Cycle %
5.8GHz WLAN ANT 0	802.11a MCS0	CH 149	5745	11.27	11.50	98.10
		CH 157	5785	11.50	12.00	
		CH 165	5825	11.43	11.50	
	802.11n-HT20 MCS0	CH 149	5745	11.25	11.50	97.96
		CH 157	5785	11.55	12.00	
		CH 165	5825	11.42	11.50	
	802.11n-HT40 MCS0	CH 151	5755	12.09	12.50	96.34
		CH 159	5795	12.16	12.50	
	802.11ac-VHT20 MCS0	CH 149	5745	11.36	11.50	98.22
		CH 157	5785	11.42	11.50	
		CH 165	5825	11.37	11.50	
	802.11ac-VHT40 MCS0	CH 151	5755	11.62	12.00	96.36
CH 159		5795	11.63	12.00		

<5.8GHz WLAN Ant 1>

	Mode	Channel	Frequency (MHz)	Average power (dBm)	Tune-Up Limit	Duty Cycle %
5.8GHz WLAN ANT 1	802.11a MCS0	CH 149	5745	11.48	11.50	98.10
		CH 157	5785	12.60	13.00	
		CH 165	5825	12.20	12.50	
	802.11n-HT20 MCS0	CH 149	5745	12.51	13.00	97.96
		CH 157	5785	12.29	12.50	
		CH 165	5825	12.07	12.50	
	802.11n-HT40 MCS0	CH 151	5755	12.69	13.00	96.34
		CH 159	5795	12.57	13.00	
	802.11ac-VHT20 MCS0	CH 149	5745	12.27	12.50	98.22
		CH 157	5785	12.36	12.50	
		CH 165	5825	11.80	12.00	
	802.11ac-VHT40 MCS0	CH 151	5755	12.66	13.00	96.36
CH 159		5795	12.48	12.50		



Note:

1. Per KDB 447498 D01v06, the 1-g SAR test exclusion thresholds for 100 MHz to 6 GHz at *test separation distances* ≤50 mm are determined by:

$$[(\text{max. power of channel, including tune-up tolerance, mW}) / (\text{min. test separation distance, mm})] \cdot [\sqrt{f(\text{GHz})}] \leq 3.0$$
 for 1-g SAR, where

- f(GHz) is the RF channel transmit frequency in GHz
- Power and distance are rounded to the nearest mW and mm before calculation
- The result is rounded to one decimal place for comparison

Antenna	Frequency (GHz)	Max. Tune-up Power (dBm)	Max. Power (mW)	Test distance (mm)	Result	exclusion thresholds for 1-g SAR
ANT 0	5.795	12.50	17.78	5	8.56	3.0
ANT 1	5.755	13.00	19.95	5	9.57	3.0

2. Per KDB 248227 D01v02r02, choose the highest output power channel to test SAR and determine further SAR exclusion.
3. The output power of all data rate were pre-scan, just the worst case (the lowest data rate) of all mode were shown in report.



<2.4GHz WLAN Ant 0 + Ant 1>

	Mode	Channel	Frequency (MHz)	Duty Factor	Total Power with Duty Factor	Tune-Up Limit	Duty Cycle %
2.4GHz WLAN	802.11n-HT20 MCS0	CH 1	2412	0.08	16.02	16.50	98.21
		CH 6	2437	0.08	16.11	16.50	
		CH 11	2462	0.08	16.37	16.50	
	802.11n-HT40 MCS0	CH 3	2422	0.22	16.43	16.50	95.00
		CH 6	2437	0.22	16.69	17.00	
		CH 9	2452	0.22	16.86	17.00	

<5.2GHz WLAN Ant 0 + Ant 1>

	Mode	Channel	Frequency (MHz)	Duty Factor	Total Power with Duty Factor (dBm)	Tune-Up Limit	Duty Cycle %
5.2GHz WLAN	802.11n-HT20 MCS0	CH 36	5180	0.09	13.01	13.50	97.96
		CH 40	5200	0.09	13.07	13.50	
		CH 48	5240	0.09	13.27	13.50	
	802.11n-HT40 MCS0	CH 38	5190	0.46	13.80	14.00	96.34
		CH 46	5230	0.46	13.41	13.50	
	802.11ac-VHT20 MCS0	CH 36	5180	0.08	13.50	14.00	98.22
		CH 40	5200	0.08	13.33	13.50	
		CH 48	5240	0.08	13.28	13.50	
	802.11ac-VHT40 MCS0	CH 38	5190	0.16	13.74	14.00	96.36
		CH 46	5230	0.16	13.58	13.00	



<5.3GHz WLAN Ant 0 + Ant 1>

	Mode	Channel	Frequency (MHz)	Duty Factor	Total Power with Duty Factor (dBm)	Tune-Up Limit	Duty Cycle %
5.3GHz WLAN	802.11n-HT20 MCS0	CH 52	5260	0.09	13.27	13.50	97.96
		CH 60	5300	0.09	13.29	13.50	
		CH 64	5320	0.09	13.17	13.50	
	802.11n-HT40 MCS0	CH 54	5270	0.46	13.32	13.50	96.34
		CH 62	5310	0.46	13.93	14.00	
	802.11ac-VHT20 MCS0	CH 52	5260	0.08	13.99	14.00	98.22
		CH 60	5300	0.08	13.34	13.50	
		CH 64	5320	0.08	13.60	14.00	
	802.11ac-VHT40 MCS0	CH 54	5270	0.16	13.59	14.00	96.36
		CH 62	5310	0.16	13.87	14.00	

<5.5GHz WLAN Ant 0 + Ant 1>

	Mode	Channel	Frequency (MHz)	Duty Factor	Total Power with Duty Factor (dBm)	Tune-Up Limit	Duty Cycle %
5.5GHz WLAN	802.11n-HT20 MCS0	CH 100	5500	0.09	13.65	14.00	97.96
		CH 120	5600	0.09	14.64	15.00	
		CH 144	5720	0.09	15.14	15.50	
	802.11n-HT40 MCS0	CH 102	5510	0.46	14.85	15.00	96.34
		CH 126	5630	0.46	15.29	15.50	
		CH 142	5710	0.46	15.76	16.00	
	802.11ac-VHT20 MCS0	CH 100	5500	0.08	14.05	14.50	98.22
		CH 120	5600	0.08	14.72	15.00	
		CH 144	5720	0.08	14.97	15.00	
	802.11ac-VHT40 MCS0	CH 102	5510	0.16	14.69	15.00	96.36
		CH 126	5630	0.16	15.20	15.50	
		CH 142	5710	0.16	15.47	15.50	



<5.8GHz WLAN Ant 0 + Ant 1>

	Mode	Channel	Frequency (MHz)	Duty Factor	Total Power with Duty Factor (dBm)	Tune-Up Limit	Duty Cycle %
5.5GHz WLAN	802.11n-HT20 MCS0	CH 149	5745	0.09	15.03	15.50	97.96
		CH 157	5785	0.09	15.04	15.50	
		CH 165	5825	0.09	14.86	15.00	
	802.11n-HT40 MCS0	CH 151	5755	0.46	15.57	16.00	96.34
		CH 159	5795	0.46	15.54	16.00	
	802.11ac-VHT20 MCS0	CH 149	5745	0.08	14.93	15.00	98.22
		CH 157	5785	0.08	15.00	15.50	
		CH 165	5825	0.08	14.68	15.00	
	802.11ac-VHT40 MCS0	CH 151	5755	0.16	15.34	15.50	96.36
		CH 159	5795	0.16	15.25	15.50	

➤ **Bluetooth Conducted Power**

Mode	Channel	Frequency (MHz)	Average power (dBm)		
			1Mbps	2Mbps	3Mbps
BR / EDR	CH 00	2402	13.25	10.73	10.73
	CH 39	2441	13.05	10.00	10.00
	CH 78	2480	13.25	10.50	10.50
Tune-up Limit (dBm)			13.50	11.00	11.00
Duty Cycle %			77.20	76.80	77.20

Mode	Channel	Frequency (MHz)	Average power (dBm)	
			1Mbps	2Mbps
LE	CH 00	2402	4.69	4.56
	CH 19	2440	4.35	4.54
	CH 39	2480	5.33	4.91
Tune-up Limit (dBm)			5.50	5.50
Duty Cycle %			62.62	32.91

Note:

1. The Bluetooth duty cycle are 77.2 %, 76.80%, 77.20% for BR/EDR, and 62.62%, 62.62% for LE, according to 2016 Oct. TCB workshop for Bluetooth SAR consideration and the theoretical duty cycle is 83.



3%, the refore the actual duty cycle will bescaled up to the theoretical value of Bluetooth reported SAR calculation.

2. Per KDB 447498 D01v06, the 1-g SAR test exclusion thresholds for 100 MHz to 6 GHz at *test separation distances* ≤50 mm are determined by:

$$[(\text{max. power of channel, including tune-up tolerance, mW}) / (\text{min. test separation distance, mm})] \cdot [\sqrt{f(\text{GHz})}] \leq 3.0$$
 for 1-g SAR, where

- f(GHz) is the RF channel transmit frequency in GHz
- Power and distance are rounded to the nearest mW and mm before calculation
- The result is rounded to one decimal place for comparison

Channel	Frequency (GHz)	Max. Tune-up Power (dBm)	Max. Power (mW)	Test distance (mm)	Result	exclusion thresholds for 1-g SAR
CH 00	2.402	13.50	22.39	10.0	3.47	3.0

- Per KDB 248227 D01v02r02, choose the highest output power channel to test SAR and determine further SAR exclusion.
- The output power of all data rate were pre-scan, just the worst case (the lowest data rate) of all mode were shown in report.
- Per KDB 248227 D01V02r02 section 2.2, when the EUT in continuously transmitting mode, the actual duty cycle is 100%, so the duty cycle factor is 1.
- Held-to ear configuration are not applicable to Bluetooth operations and therefore were not considered for simultaneous transmission.

13.2. Down Power

➤ GSM Conducted Power

GSM850	Burst Average Power (dBm)			Tune-up Limit (dBm)	Frame-Average Power (dBm)			Tune-up Limit (dBm)
	TX Channel	128	189		251	128	189	
Frequency (MHz)	824.2	836.4	848.8		824.2	836.4	848.8	
GSM 1 Tx slot	30.60	30.80	31.00	31.00	21.60	21.80	22.00	22.00
GPRS 1 Tx slot	30.70	30.70	30.90	31.00	21.70	21.70	21.90	22.00
GPRS 2 Tx slots	28.30	28.45	28.45	28.50	22.30	22.45	22.45	22.50
GPRS 3 Tx slots	26.90	26.70	26.60	27.00	22.64	22.44	22.34	22.74
GPRS 4 Tx slots	24.80	25.10	25.20	25.50	21.80	22.10	22.20	22.50
EDGE 1 Tx slot	25.80	25.90	25.90	26.00	16.80	16.90	16.90	17.00
EDGE 2 Tx slots	22.20	22.50	22.40	23.00	16.20	16.50	16.40	17.00
EDGE 3 Tx slots	21.58	21.68	21.72	22.00	17.32	17.42	17.46	17.74
EDGE 4 Tx slots	20.51	20.57	20.64	21.00	17.51	17.57	17.64	18.00

Note: It will reduce about 2dBm by the sensor when it uses to the top antenna and be used for top antenna measurement.

GSM1900	Burst Average Power (dBm)			Tune-up Limit (dBm)	Frame-Average Power (dBm)			Tune-up Limit (dBm)
	TX Channel	512	661		810	512	661	
Frequency (MHz)	1850.2	1880	1909.8		1850.2	1880	1909.8	
GSM 1 Tx slot	25.04	25.12	25.05	25.50	16.04	16.12	16.05	16.50
GPRS 1 Tx slot	24.98	25.15	25.08	25.50	15.98	16.15	16.08	16.50
GPRS 2 Tx slots	22.61	22.65	22.63	23.00	16.61	16.65	16.63	17.00
GPRS 3 Tx slots	17.59	17.53	17.56	18.00	13.33	13.27	13.30	13.74
GPRS 4 Tx slots	17.74	17.56	17.81	18.00	14.74	14.56	14.81	15.00
EDGE 1 Tx slot	21.49	21.52	21.47	22.00	12.49	12.52	12.47	13.00
EDGE 2 Tx slots	18.85	18.79	18.81	19.00	12.85	12.79	12.81	13.00
EDGE 3 Tx slots	15.07	15.09	15.14	15.50	10.81	10.83	10.88	11.24
EDGE 4 Tx slots	14.79	14.78	14.74	15.00	11.79	11.78	11.74	12.00

Note: It will reduce about 2.5dBm by the sensor when it uses to the top antenna and be used for top antenna measurement.



➤ **WCDMA Conducted Power**

Band		WCDMA II			Tune-up Limit (dBm)
TX Channel		9262	9400	9538	
Rx Channel		9662	9800	9938	
Frequency (MHz)		1852.4	1880	1907.6	
3GPP Rel 99	RMC 12.2Kbps	16.02	16.04	16.01	16.50
3GPP Rel 6	HSDPA Subtest-1	13.69	13.85	13.75	14.00
3GPP Rel 6	HSDPA Subtest-2	13.73	13.82	13.69	14.00
3GPP Rel 6	HSDPA Subtest-3	13.21	13.39	13.13	13.50
3GPP Rel 6	HSDPA Subtest-4	13.23	13.29	13.11	13.50
3GPP Rel 6	HSUPA Subtest-1	13.79	13.81	13.88	14.00
3GPP Rel 6	HSUPA Subtest-2	11.89	12.01	11.89	12.50
3GPP Rel 6	HSUPA Subtest-3	12.92	13.03	12.82	13.50
3GPP Rel 6	HSUPA Subtest-4	11.91	12.04	11.81	12.50
3GPP Rel 6	HSUPA Subtest-5	13.73	13.83	13.86	14.00
3GPP Rel 7	HSPA+ (16QAM) Subtest-1	12.63	12.87	13.01	13.50

Note: It will reduce about 3.5dBm by the sensor when it uses to the top antenna and be used for top antenna measurement.

Band		WCDMA IV			Tune-up Limit (dBm)
TX Channel		1312	1413	1513	
Rx Channel		1537	1638	1738	
Frequency (MHz)		1712.4	1732.6	1752.6	
3GPP Rel 99	RMC 12.2Kbps	17.37	17.87	17.73	18.00
3GPP Rel 6	HSDPA Subtest-1	15.21	15.36	15.26	15.50
3GPP Rel 6	HSDPA Subtest-2	15.25	15.33	15.20	15.50
3GPP Rel 6	HSDPA Subtest-3	14.73	14.90	14.64	15.00
3GPP Rel 6	HSDPA Subtest-4	14.75	14.80	14.62	15.00
3GPP Rel 6	HSUPA Subtest-1	15.31	15.32	15.39	15.50
3GPP Rel 6	HSUPA Subtest-2	13.41	13.52	13.40	13.50
3GPP Rel 6	HSUPA Subtest-3	14.44	14.54	14.33	15.00
3GPP Rel 6	HSUPA Subtest-4	13.43	13.55	13.32	14.00
3GPP Rel 6	HSUPA Subtest-5	15.25	15.34	15.37	15.50
3GPP Rel 7	HSPA+ (16QAM) Subtest-1	14.15	14.39	14.48	14.50

Note: It will reduce about 3.5dBm by the sensor when it uses to the top antenna and be used for top antenna measurement.



Band		WCDMA V			Tune-up Limit (dBm)
TX Channel		4132	4183	4233	
Rx Channel		4357	4408	4458	
Frequency (MHz)		826.4	836.6	846.6	
3GPP Rel 99	RMC 12.2Kbps	21.83	21.88	21.74	22.00
3GPP Rel 6	HSDPA Subtest-1	19.21	19.37	19.28	19.50
3GPP Rel 6	HSDPA Subtest-2	19.26	19.38	19.16	19.50
3GPP Rel 6	HSDPA Subtest-3	18.71	18.91	18.66	19.00
3GPP Rel 6	HSDPA Subtest-4	18.74	18.88	18.67	19.00
3GPP Rel 6	HSUPA Subtest-1	19.22	19.35	19.34	19.50
3GPP Rel 6	HSUPA Subtest-2	17.42	17.55	17.34	18.00
3GPP Rel 6	HSUPA Subtest-3	18.41	18.57	18.33	18.50
3GPP Rel 6	HSUPA Subtest-4	17.43	17.57	17.32	18.00
3GPP Rel 6	HSUPA Subtest-5	19.19	19.36	19.33	19.50
3GPP Rel 7	HSPA+ (16QAM) Subtest-1	18.02	18.29	18.26	18.50

Note: It will reduce about 1dBm by the sensor when it uses to the top antenna and be used for top antenna measurement.

➤ **CDMA2000 Conducted Power**

1XRTT Conducted Power:

Band	CDMA 2000 BC1			Tune-up Limit (dBm)
TX Channel	25	600	1175	
Frequency (MHz)	1851.25	1880	1908.75	
RC1 SO55	15.26	15.15	14.97	15.50
RC3 SO55	15.44	15.39	15.43	15.50
RC3 SO32 (F+SCH)	15.27	15.36	15.35	15.50
RC3 SO32 (+SCH)	15.27	15.32	15.33	15.50

1XEVD0 Conducted Power:

Band	CDMA 2000 BC1			Tune-up Limit (dBm)
TX Channel	25	600	1175	
Frequency (MHz)	1851.25	1880	1908.75	
RTAP 153.6Kbps	15.24	15.17	14.66	15.50
RETAP 4096Bits	14.87	14.98	14.61	15.00
RMCTAP 307.2 Kbps	14.87	14.98	14.61	15.00

Note: It will reduce about 2.5dBm by the sensor when it uses to the top antenna and be used for top antenna measurement.



➤ LTE Conducted Power

<FDD-LTE Band 2>

BW [MHz]	Modulation	RB Size	RB Offset	Power Low Ch. / Freq.	Power Middle Ch. / Freq.	Power High Ch. / Freq.	Tune-up limit (dBm)
Channel				18700	18900	19100	
Frequency (MHz)				1860	1880	1900	
20	QPSK	1	0	15.11	15.13	15.14	15.50
20	QPSK	1	49	15.06	15.09	15.20	
20	QPSK	1	99	15.17	15.33	15.37	
20	QPSK	50	0	14.28	14.30	14.30	14.50
20	QPSK	50	24	14.29	14.34	14.34	
20	QPSK	50	50	14.34	14.45	14.46	
20	QPSK	100	0	14.27	14.36	14.32	
20	16QAM	1	0	14.33	14.33	14.35	15.00
20	16QAM	1	49	14.68	14.47	14.43	
20	16QAM	1	99	14.42	14.58	14.67	
20	16QAM	50	0	14.35	14.32	14.30	14.50
20	16QAM	50	24	14.31	14.36	14.37	
20	16QAM	50	50	14.39	14.36	14.43	
20	16QAM	100	0	14.42	14.43	14.30	
20	64QAM	1	0	14.29	14.48	14.22	15.00
20	64QAM	1	49	14.24	14.42	14.33	
20	64QAM	1	99	14.68	14.52	14.52	
20	64QAM	50	0	13.37	13.29	13.34	13.50
20	64QAM	50	24	13.40	13.34	13.39	
20	64QAM	50	50	13.39	13.40	13.34	
20	64QAM	100	0	13.39	13.36	13.37	
Channel				18675	18900	19125	Tune-up limit (dBm)
Frequency (MHz)				1857.5	1880	1902.5	
15	QPSK	1	0	15.14	15.17	15.08	15.50
15	QPSK	1	37	14.93	15.29	15.17	
15	QPSK	1	74	15.30	15.22	15.30	
15	QPSK	36	0	14.26	14.35	14.34	14.50
15	QPSK	36	20	14.25	14.44	14.41	
15	QPSK	36	39	14.37	14.38	14.35	



15	QPSK	75	0	14.29	14.35	14.31	
15	16QAM	1	0	14.38	14.46	14.40	15.00
15	16QAM	1	37	14.51	14.54	14.40	
15	16QAM	1	74	14.46	14.58	14.58	
15	16QAM	36	0	14.25	14.30	14.33	14.50
15	16QAM	36	20	14.34	14.27	14.40	
15	16QAM	36	39	14.39	14.48	14.45	
15	16QAM	75	0	14.26	14.28	14.37	
15	64QAM	1	0	14.46	14.22	14.28	15.00
15	64QAM	1	37	14.45	14.26	14.68	
15	64QAM	1	74	14.34	14.38	14.53	
15	64QAM	36	0	13.19	13.36	13.24	13.50
15	64QAM	36	20	13.39	13.41	13.31	
15	64QAM	36	39	13.27	13.32	13.41	
15	64QAM	75	0	13.26	13.33	13.32	
Channel				18650	18900	19150	Tune-up limit (dBm)
Frequency (MHz)				1855	1880	1905	
10	QPSK	1	0	14.99	14.98	15.08	15.50
10	QPSK	1	25	15.10	15.20	15.08	
10	QPSK	1	49	14.99	15.07	14.99	
10	QPSK	25	0	14.25	14.26	14.22	14.50
10	QPSK	25	12	14.21	14.33	14.26	
10	QPSK	25	25	14.12	14.25	14.21	
10	QPSK	50	0	14.18	14.27	14.25	
10	16QAM	1	0	14.66	14.59	14.58	15.00
10	16QAM	1	25	14.35	14.31	14.38	
10	16QAM	1	49	14.30	14.38	14.59	
10	16QAM	25	0	13.14	13.18	13.24	13.50
10	16QAM	25	12	13.32	13.28	13.27	
10	16QAM	25	25	13.27	13.23	13.22	
10	16QAM	50	0	13.23	13.16	13.20	
10	64QAM	1	0	14.24	14.29	14.29	15.00
10	64QAM	1	25	14.27	14.32	14.36	
10	64QAM	1	49	13.94	14.07	14.04	
10	64QAM	25	0	13.24	13.28	13.29	13.50
10	64QAM	25	12	13.27	13.25	13.26	
10	64QAM	25	25	13.20	12.98	13.20	



10	64QAM	50	0	13.21	13.21	13.18	
Channel				18625	18900	19175	Tune-up limit (dBm)
Frequency (MHz)				1852.5	1880	1907.5	
5	QPSK	1	0	15.13	15.18	15.12	15.50
5	QPSK	1	12	15.12	15.23	15.10	
5	QPSK	1	24	15.08	15.24	15.17	
5	QPSK	12	0	14.24	14.15	14.22	14.50
5	QPSK	12	7	14.25	14.30	14.22	
5	QPSK	12	13	14.24	14.23	14.26	
5	QPSK	25	0	14.23	14.21	14.23	
5	16QAM	1	0	14.36	14.26	14.64	15.00
5	16QAM	1	12	14.34	14.27	14.64	
5	16QAM	1	24	14.37	14.24	14.63	
5	16QAM	12	0	13.22	13.10	13.20	13.50
5	16QAM	12	7	13.29	13.31	13.25	
5	16QAM	12	13	13.32	13.21	13.16	
5	16QAM	25	0	13.24	13.22	13.20	
5	64QAM	1	0	14.63	14.18	14.23	15.00
5	64QAM	1	12	14.62	14.28	14.39	
5	64QAM	1	24	14.63	14.27	14.29	
5	64QAM	12	0	13.28	13.21	13.20	13.50
5	64QAM	12	7	13.34	13.18	13.18	
5	64QAM	12	13	13.31	13.27	13.25	
5	64QAM	25	0	13.38	13.18	13.25	
Channel				18615	18900	19185	Tune-up limit (dBm)
Frequency (MHz)				1851.5	1880	1908.5	
3	QPSK	1	0	15.18	14.96	15.08	15.50
3	QPSK	1	8	15.11	15.32	15.15	
3	QPSK	1	14	15.30	15.17	15.17	
3	QPSK	8	0	14.24	14.19	14.21	14.50
3	QPSK	8	4	14.30	14.24	14.25	
3	QPSK	8	7	14.30	14.24	14.20	
3	QPSK	15	0	14.22	14.30	14.23	
3	16QAM	1	0	14.38	14.29	14.23	15.00
3	16QAM	1	8	14.42	14.36	14.32	
3	16QAM	1	14	14.35	14.32	14.67	



3	16QAM	8	0	13.28	13.41	13.33	13.50
3	16QAM	8	4	13.35	13.32	13.38	
3	16QAM	8	7	13.25	13.30	13.33	
3	16QAM	15	0	13.28	13.32	13.27	
3	64QAM	1	0	14.31	14.24	14.27	15.00
3	64QAM	1	8	14.73	14.72	14.32	
3	64QAM	1	14	14.34	14.70	14.34	
3	64QAM	8	0	13.26	13.28	13.12	13.50
3	64QAM	8	4	13.36	13.26	13.26	
3	64QAM	8	7	13.46	13.35	13.21	
3	64QAM	15	0	13.31	13.31	13.29	
Channel				18607	18900	19193	Tune-up limit (dBm)
Frequency (MHz)				1850.7	1880	1909.3	
1.4	QPSK	1	0	15.05	15.07	15.03	15.50
1.4	QPSK	1	3	15.15	15.13	15.12	
1.4	QPSK	1	5	15.12	15.10	15.08	
1.4	QPSK	3	0	15.11	15.11	15.07	
1.4	QPSK	3	1	15.15	15.12	15.10	
1.4	QPSK	3	3	15.17	15.21	15.10	
1.4	QPSK	6	0	14.20	14.18	14.17	14.50
1.4	16QAM	1	0	14.23	14.23	14.17	14.50
1.4	16QAM	1	3	14.19	14.39	14.37	
1.4	16QAM	1	5	14.07	14.27	13.95	
1.4	16QAM	3	0	14.09	14.14	14.11	
1.4	16QAM	3	1	14.27	14.09	14.14	
1.4	16QAM	3	3	14.29	14.26	14.00	
1.4	16QAM	6	0	13.34	13.23	13.15	13.50
1.4	64QAM	1	0	14.18	14.10	14.13	14.50
1.4	64QAM	1	3	14.20	14.41	14.29	
1.4	64QAM	1	5	14.18	14.53	14.12	
1.4	64QAM	3	0	14.21	14.27	14.28	
1.4	64QAM	3	1	14.30	14.27	14.01	
1.4	64QAM	3	3	14.22	14.36	14.13	
1.4	64QAM	6	0	13.22	13.23	13.12	13.50

Note: It will reduce about 4.5dBm by the sensor when it uses to the top antenna and be used for top antenna measurement.



<FDD-LTE Band 4>

BW [MHz]	Modulation	RB Size	RB Offset	Power Low Ch. / Freq.	Power Middle Ch. / Freq.	Power High Ch. / Freq.	Tune-up limit (dBm)
Channel				20050	20175	20300	
Frequency (MHz)				1720	1732.5	1745	
20	QPSK	1	0	16.08	16.06	16.20	16.50
20	QPSK	1	49	15.94	16.02	16.15	
20	QPSK	1	99	15.86	15.99	16.10	
20	QPSK	50	0	15.15	15.26	15.25	15.50
20	QPSK	50	24	15.15	15.23	15.23	
20	QPSK	50	50	15.04	15.15	15.28	
20	QPSK	100	0	15.14	15.18	15.25	
20	16QAM	1	0	15.33	15.41	15.30	15.50
20	16QAM	1	49	15.48	15.25	15.39	
20	16QAM	1	99	15.27	15.49	15.25	
20	16QAM	50	0	14.20	14.25	14.35	14.50
20	16QAM	50	24	14.16	14.27	14.16	
20	16QAM	50	50	14.12	14.13	14.13	
20	16QAM	100	0	14.14	14.22	14.23	
20	64QAM	1	0	15.12	15.23	15.45	15.50
20	64QAM	1	49	15.16	15.09	14.97	
20	64QAM	1	99	15.43	15.00	15.47	
20	64QAM	50	0	14.13	14.22	14.17	14.50
20	64QAM	50	24	14.15	14.26	14.20	
20	64QAM	50	50	14.19	14.14	14.16	
20	64QAM	100	0	14.22	14.20	14.29	
Channel				20025	20175	20325	Tune-up limit (dBm)
Frequency (MHz)				1717.5	1732.5	1747.5	
15	QPSK	1	0	15.95	15.99	16.09	16.50
15	QPSK	1	37	15.99	16.08	16.00	
15	QPSK	1	74	15.86	16.08	16.11	
15	QPSK	36	0	15.09	15.16	15.19	15.50
15	QPSK	36	20	15.13	15.26	15.22	
15	QPSK	36	39	15.18	15.17	15.26	
15	QPSK	75	0	15.13	15.15	15.16	



15	16QAM	1	0	15.21	15.43	15.15	15.50
15	16QAM	1	37	15.29	15.29	15.13	
15	16QAM	1	74	15.15	15.45	15.41	
15	16QAM	36	0	14.16	14.18	14.24	14.50
15	16QAM	36	20	14.11	14.18	14.24	
15	16QAM	36	39	14.07	14.16	14.22	
15	16QAM	75	0	14.18	14.19	14.28	
15	64QAM	1	0	14.99	15.30	15.35	15.50
15	64QAM	1	37	15.41	15.17	15.23	
15	64QAM	1	74	15.45	15.16	15.20	
15	64QAM	36	0	14.10	14.17	14.21	14.50
15	64QAM	36	20	14.16	14.18	14.20	
15	64QAM	36	39	14.19	14.15	14.17	
15	64QAM	75	0	14.12	14.23	14.16	
Channel				20000	20175	20350	Tune-up limit (dBm)
Frequency (MHz)				1715	1732.5	1750	
10	QPSK	1	0	15.87	16.06	15.89	16.50
10	QPSK	1	25	15.85	15.98	15.99	
10	QPSK	1	49	15.93	15.76	15.99	
10	QPSK	25	0	14.92	15.14	15.16	15.50
10	QPSK	25	12	15.04	15.10	15.14	
10	QPSK	25	25	14.93	15.04	15.11	
10	QPSK	50	0	14.99	15.09	15.01	
10	16QAM	1	0	15.12	15.27	15.03	15.50
10	16QAM	1	25	15.39	15.13	15.45	
10	16QAM	1	49	15.46	15.36	15.35	
10	16QAM	25	0	14.12	14.11	14.10	14.50
10	16QAM	25	12	14.04	14.14	14.11	
10	16QAM	25	25	14.00	13.91	14.00	
10	16QAM	50	0	13.94	13.98	14.10	
10	64QAM	1	0	15.04	15.12	15.02	15.50
10	64QAM	1	25	15.11	15.40	15.49	
10	64QAM	1	49	15.09	15.13	15.08	
10	64QAM	25	0	13.93	14.07	14.06	14.50
10	64QAM	25	12	14.02	14.13	14.17	
10	64QAM	25	25	13.90	14.02	14.04	
10	64QAM	50	0	13.96	14.03	14.02	



Channel				19975	20175	20375	Tune-up limit (dBm)
Frequency (MHz)				1712.5	1732.5	1752.5	
5	QPSK	1	0	15.77	15.99	16.04	16.50
5	QPSK	1	12	15.83	15.98	15.95	
5	QPSK	1	24	15.78	15.90	15.89	
5	QPSK	12	0	15.00	15.00	15.04	15.50
5	QPSK	12	7	15.00	15.11	15.08	
5	QPSK	12	13	14.95	15.12	15.04	
5	QPSK	25	0	14.98	15.02	15.08	
5	16QAM	1	0	15.02	15.43	15.11	15.50
5	16QAM	1	12	15.13	15.48	15.07	
5	16QAM	1	24	15.07	15.42	15.02	
5	16QAM	12	0	14.06	14.00	14.03	14.50
5	16QAM	12	7	14.09	14.13	14.11	
5	16QAM	12	13	13.98	14.05	14.09	
5	16QAM	25	0	13.99	14.10	14.03	
5	64QAM	1	0	15.00	15.44	15.42	15.50
5	64QAM	1	12	15.38	15.14	15.41	
5	64QAM	1	24	15.34	15.04	15.11	
5	64QAM	12	0	14.01	14.08	14.10	14.50
5	64QAM	12	7	14.00	14.09	14.15	
5	64QAM	12	13	14.01	14.07	14.06	
5	64QAM	25	0	13.96	14.10	14.01	
Channel				19965	20175	20385	Tune-up limit (dBm)
Frequency (MHz)				1711.5	1732.5	1753.5	
3	QPSK	1	0	15.89	15.90	16.02	16.50
3	QPSK	1	8	15.98	16.12	16.06	
3	QPSK	1	14	15.78	15.97	15.97	
3	QPSK	8	0	14.98	15.04	15.05	15.50
3	QPSK	8	4	15.04	15.12	15.14	
3	QPSK	8	7	15.00	15.10	15.10	
3	QPSK	15	0	15.00	15.06	15.00	
3	16QAM	1	0	15.22	15.31	15.35	15.50
3	16QAM	1	8	15.44	15.44	15.18	
3	16QAM	1	14	15.35	15.13	15.21	
3	16QAM	8	0	14.02	14.15	14.02	14.50



3	16QAM	8	4	14.14	14.24	14.21	
3	16QAM	8	7	14.08	14.16	14.20	
3	16QAM	15	0	14.08	14.06	14.13	
3	64QAM	1	0	14.99	15.08	15.06	15.50
3	64QAM	1	8	15.18	15.06	15.22	
3	64QAM	1	14	14.99	15.06	14.89	
3	64QAM	8	0	13.97	14.01	13.95	14.50
3	64QAM	8	4	14.09	14.07	14.11	
3	64QAM	8	7	14.03	14.10	14.22	
3	64QAM	15	0	13.99	14.07	13.98	
Channel				19957	20175	20393	Tune-up limit (dBm)
Frequency (MHz)				1710.7	1732.5	1754.3	
1.4	QPSK	1	0	15.64	15.85	15.86	16.50
1.4	QPSK	1	3	15.98	15.98	16.02	
1.4	QPSK	1	5	15.84	15.93	15.95	
1.4	QPSK	3	0	15.92	15.89	15.88	
1.4	QPSK	3	1	15.88	15.98	16.03	
1.4	QPSK	3	3	15.87	15.94	15.93	
1.4	QPSK	6	0	14.97	15.06	15.06	15.50
1.4	16QAM	1	0	14.94	15.41	15.07	15.50
1.4	16QAM	1	3	15.07	15.15	15.19	
1.4	16QAM	1	5	15.13	15.29	15.09	
1.4	16QAM	3	0	14.95	14.99	14.90	
1.4	16QAM	3	1	14.96	14.99	15.01	
1.4	16QAM	3	3	14.95	15.07	14.96	
1.4	16QAM	6	0	14.12	13.93	14.06	14.50
1.4	64QAM	1	0	14.88	14.82	14.96	15.40
1.4	64QAM	1	3	15.14	15.12	15.24	
1.4	64QAM	1	5	15.05	15.01	14.85	
1.4	64QAM	3	0	14.96	14.94	15.13	
1.4	64QAM	3	1	14.87	15.02	14.99	
1.4	64QAM	3	3	14.93	15.10	14.98	
1.4	64QAM	6	0	13.92	13.93	14.00	14.50

Note: It will reduce about 4.5dBm by the sensor when it uses to the top antenna and be used for top antenna measurement.



<FDD-LTE Band 5>

BW [MHz]	Modulation	RB Size	RB Offset	Power Low Ch. / Freq.	Power Middle Ch. / Freq.	Power High Ch. / Freq.	Tune-up limit (dBm)
Channel				20450	20525	20600	
Frequency (MHz)				829	836.5	844	
10	QPSK	1	0	22.22	22.23	22.04	22.50
10	QPSK	1	25	22.08	22.11	21.91	
10	QPSK	1	49	22.00	22.12	21.80	
10	QPSK	25	0	21.31	21.33	21.14	21.50
10	QPSK	25	12	21.28	21.30	21.05	
10	QPSK	25	25	21.28	21.19	21.02	
10	QPSK	50	0	21.21	21.22	20.99	
10	16QAM	1	0	21.38	21.57	21.28	22.00
10	16QAM	1	25	21.61	21.64	21.32	
10	16QAM	1	49	21.23	21.29	21.36	
10	16QAM	25	0	20.32	20.33	20.15	20.50
10	16QAM	25	12	20.26	20.34	19.96	
10	16QAM	25	25	20.29	20.22	19.95	
10	16QAM	50	0	20.30	20.21	20.11	
10	64QAM	1	0	21.39	21.84	21.42	22.00
10	64QAM	1	25	21.40	21.41	21.44	
10	64QAM	1	49	21.41	21.45	21.49	
10	64QAM	25	0	20.23	20.34	20.01	20.50
10	64QAM	25	12	20.22	20.39	20.10	
10	64QAM	25	25	20.34	20.23	19.93	
10	64QAM	50	0	20.30	20.26	20.12	
Channel				20425	20525	20625	Tune-up limit (dBm)
Frequency (MHz)				826.5	836.5	846.5	
5	QPSK	1	0	21.99	22.04	21.81	22.50
5	QPSK	1	12	22.07	22.18	21.68	
5	QPSK	1	24	22.07	22.02	21.74	
5	QPSK	12	0	21.22	21.27	20.95	21.50
5	QPSK	12	7	21.29	21.30	21.03	
5	QPSK	12	13	21.34	21.18	20.91	
5	QPSK	25	0	21.25	21.21	20.97	



5	16QAM	1	0	21.54	21.47	21.23	22.00
5	16QAM	1	12	21.24	21.46	21.22	
5	16QAM	1	24	21.11	21.46	21.29	
5	16QAM	12	0	20.20	20.29	19.98	20.50
5	16QAM	12	7	20.27	20.30	19.98	
5	16QAM	12	13	20.27	20.18	19.83	
5	16QAM	25	0	20.28	20.33	19.94	
5	64QAM	1	0	21.35	21.00	21.34	22.00
5	64QAM	1	12	21.23	21.17	21.31	
5	64QAM	1	24	21.37	21.21	20.90	
5	64QAM	12	0	20.09	20.23	19.83	20.50
5	64QAM	12	7	20.13	20.29	20.07	
5	64QAM	12	13	20.31	20.26	19.83	
5	64QAM	25	0	20.19	20.26	19.87	
Channel				20415	20525	20635	Tune-up limit (dBm)
Frequency (MHz)				825.5	836.5	847.5	
3	QPSK	1	0	21.86	22.17	21.88	22.50
3	QPSK	1	8	22.25	22.13	21.93	
3	QPSK	1	14	22.21	22.11	21.85	
3	QPSK	8	0	21.15	21.28	20.90	21.50
3	QPSK	8	4	21.29	21.35	20.90	
3	QPSK	8	7	21.24	21.26	20.93	
3	QPSK	15	0	21.22	21.28	20.87	
3	16QAM	1	0	21.24	21.62	21.42	22.00
3	16QAM	1	8	21.67	21.43	21.27	
3	16QAM	1	14	21.61	21.48	21.23	
3	16QAM	8	0	20.18	20.27	20.01	20.50
3	16QAM	8	4	20.34	20.45	20.02	
3	16QAM	8	7	20.26	20.32	20.06	
3	16QAM	15	0	20.20	20.22	19.77	
3	64QAM	1	0	21.15	21.03	21.24	22.00
3	64QAM	1	8	21.03	21.27	20.78	
3	64QAM	1	14	21.05	21.23	20.91	
3	64QAM	8	0	20.15	20.25	19.91	20.50
3	64QAM	8	4	20.37	20.21	19.84	
3	64QAM	8	7	20.32	20.24	19.88	
3	64QAM	15	0	20.21	20.31	19.78	



Channel				20407	20525	20643	Tune-up limit (dBm)
Frequency (MHz)				824.7	836.5	848.3	
1.4	QPSK	1	0	22.07	22.14	21.65	22.50
1.4	QPSK	1	3	22.20	22.21	21.77	
1.4	QPSK	1	5	22.09	22.03	21.71	
1.4	QPSK	3	0	22.10	22.16	21.69	
1.4	QPSK	3	1	22.16	22.21	21.85	
1.4	QPSK	3	3	22.17	22.19	21.76	
1.4	QPSK	6	0	21.20	21.19	20.84	21.50
1.4	16QAM	1	0	21.50	21.14	20.97	22.00
1.4	16QAM	1	3	21.71	21.37	20.92	
1.4	16QAM	1	5	21.52	21.20	20.92	
1.4	16QAM	3	0	21.05	21.03	20.83	
1.4	16QAM	3	1	21.08	21.35	20.87	
1.4	16QAM	3	3	21.16	21.27	20.81	
1.4	16QAM	6	0	20.38	20.33	19.86	20.50
1.4	64QAM	1	0	21.01	21.18	20.86	22.00
1.4	64QAM	1	3	21.32	21.33	20.94	
1.4	64QAM	1	5	21.27	21.26	20.80	
1.4	64QAM	3	0	20.93	21.20	20.87	
1.4	64QAM	3	1	21.21	21.15	20.82	
1.4	64QAM	3	3	21.11	21.28	20.98	
1.4	64QAM	6	0	20.19	20.31	19.86	20.50

Note: It will reduce about 0.5dBm by the sensor when it uses to the top antenna and be used for top antenna measurement.



<FDD-LTE Band 7>

BW [MHz]	Modulation	RB Size	RB Offset	Power Low Ch. / Freq.	Power Middle Ch. / Freq.	Power High Ch. / Freq.	Tune-up limit (dBm)
Channel				20850	21100	21350	
Frequency (MHz)				2510	2535	2560	
20	QPSK	1	0	19.29	19.33	19.36	19.50
20	QPSK	1	49	19.14	19.42	19.31	
20	QPSK	1	99	19.33	19.28	19.33	
20	QPSK	50	0	18.72	18.73	18.71	19.00
20	QPSK	50	24	18.58	18.55	18.45	
20	QPSK	50	50	18.68	18.70	18.68	
20	QPSK	100	0	18.63	18.65	18.62	
20	16QAM	1	0	18.24	18.34	18.52	19.00
20	16QAM	1	49	18.39	18.25	18.53	
20	16QAM	1	99	18.37	18.27	18.44	
20	16QAM	50	0	17.43	17.53	17.46	18.00
20	16QAM	50	24	17.48	17.40	17.51	
20	16QAM	50	50	17.56	17.61	17.44	
20	16QAM	100	0	17.44	17.56	17.54	
20	64QAM	1	0	18.54	18.89	18.11	19.00
20	64QAM	1	49	18.48	18.45	18.50	
20	64QAM	1	99	18.46	18.51	18.42	
20	64QAM	50	0	17.45	17.46	17.51	18.00
20	64QAM	50	24	17.50	17.51	17.51	
20	64QAM	50	50	17.54	17.61	17.46	
20	64QAM	100	0	17.47	17.44	17.56	
Channel				20825	21100	21375	Tune-up limit (dBm)
Frequency (MHz)				2507.5	2535	2562.5	
15	QPSK	1	0	19.26	19.35	19.35	19.50
15	QPSK	1	37	19.36	19.33	19.37	
15	QPSK	1	74	19.30	19.37	19.37	
15	QPSK	36	0	18.61	18.70	18.72	19.00
15	QPSK	36	20	18.69	18.76	18.71	
15	QPSK	36	39	18.72	18.75	18.79	
15	QPSK	75	0	18.78	18.71	18.73	



15	16QAM	1	0	18.74	18.85	18.92	19.00
15	16QAM	1	37	18.56	18.67	18.65	
15	16QAM	1	74	18.60	18.60	18.82	
15	16QAM	36	0	17.44	17.55	17.57	18.00
15	16QAM	36	20	17.51	17.54	17.53	
15	16QAM	36	39	17.57	17.55	17.44	
15	16QAM	75	0	17.52	17.60	17.52	
15	64QAM	1	0	18.44	18.90	18.29	19.00
15	64QAM	1	37	18.34	18.49	18.58	
15	64QAM	1	74	18.33	18.45	18.51	
15	64QAM	36	0	17.43	17.51	17.50	18.00
15	64QAM	36	20	17.54	17.53	17.60	
15	64QAM	36	39	17.58	17.49	17.51	
15	64QAM	75	0	17.43	17.53	17.48	
Channel				20800	21100	21400	Tune-up limit (dBm)
Frequency (MHz)				2505	2535	2565	
10	QPSK	1	0	19.25	19.12	19.15	19.50
10	QPSK	1	25	19.28	19.18	19.20	
10	QPSK	1	49	19.21	19.18	19.20	
10	QPSK	25	0	18.53	18.53	18.52	19.00
10	QPSK	25	12	18.49	18.61	18.66	
10	QPSK	25	25	18.42	18.60	18.60	
10	QPSK	50	0	18.51	18.63	18.62	
10	16QAM	1	0	18.36	18.54	18.39	19.00
10	16QAM	1	25	18.35	18.37	18.42	
10	16QAM	1	49	18.82	18.72	18.63	
10	16QAM	25	0	17.31	17.38	17.46	18.00
10	16QAM	25	12	17.32	17.49	17.42	
10	16QAM	25	25	17.37	17.40	17.32	
10	16QAM	50	0	17.40	17.49	17.34	
10	64QAM	1	0	18.44	18.40	18.38	19.00
10	64QAM	1	25	18.13	18.38	18.21	
10	64QAM	1	49	18.24	18.48	18.29	
10	64QAM	25	0	17.35	17.33	17.37	18.00
10	64QAM	25	12	17.37	17.48	17.41	
10	64QAM	25	25	17.30	17.20	17.19	
10	64QAM	50	0	17.40	17.46	17.38	



Channel				20775	21100	21425	Tune-up limit (dBm)
Frequency (MHz)				2502.5	2535	2567.5	
5	QPSK	1	0	19.08	19.13	19.26	19.50
5	QPSK	1	12	19.17	19.25	19.33	
5	QPSK	1	24	19.26	19.32	19.36	
5	QPSK	12	0	18.49	18.57	18.49	19.00
5	QPSK	12	7	18.56	18.71	18.63	
5	QPSK	12	13	18.58	18.74	18.59	
5	QPSK	25	0	18.59	18.60	18.55	
5	16QAM	1	0	18.37	18.35	18.41	19.00
5	16QAM	1	12	18.42	18.64	18.54	
5	16QAM	1	24	18.48	18.67	18.49	
5	16QAM	12	0	17.34	17.28	17.41	18.00
5	16QAM	12	7	17.43	17.55	17.51	
5	16QAM	12	13	17.53	17.59	17.42	
5	16QAM	25	0	17.40	17.45	17.46	
5	64QAM	1	0	18.36	18.41	18.37	19.00
5	64QAM	1	12	18.41	18.53	18.41	
5	64QAM	1	24	18.45	18.55	18.51	
5	64QAM	12	0	17.41	17.38	17.43	18.00
5	64QAM	12	7	17.50	17.55	17.34	
5	64QAM	12	13	17.45	17.54	17.40	
5	64QAM	25	0	17.40	17.39	17.44	

Note: It will reduce about 3.5dBm by the sensor when it uses to the top antenna and be used for top antenna measurement.



<FDD-LTE Band 12>

BW [MHz]	Modulation	RB Size	RB Offset	Power Low Ch. / Freq.	Power Middle Ch. / Freq.	Power High Ch. / Freq.	Tune-up limit (dBm)
Channel				23060	23095	23130	
Frequency (MHz)				704	707.5	711	
10	QPSK	1	0	21.91	21.92	21.79	22.50
10	QPSK	1	25	21.69	21.90	21.75	
10	QPSK	1	49	21.69	21.88	22.07	
10	QPSK	25	0	20.94	21.04	20.95	21.50
10	QPSK	25	12	21.03	20.98	21.04	
10	QPSK	25	25	20.96	21.02	20.95	
10	QPSK	50	0	20.97	20.99	20.90	
10	16QAM	1	0	21.34	20.89	20.95	21.50
10	16QAM	1	25	21.49	21.04	21.36	
10	16QAM	1	49	21.18	21.23	21.12	
10	16QAM	25	0	19.96	19.98	19.92	20.50
10	16QAM	25	12	20.00	20.04	19.93	
10	16QAM	25	25	20.05	20.06	20.00	
10	16QAM	50	0	19.95	20.03	20.08	
10	64QAM	1	0	20.88	21.00	21.34	21.50
10	64QAM	1	25	21.32	21.38	20.97	
10	64QAM	1	49	21.34	21.02	20.95	
10	64QAM	25	0	19.96	19.90	19.87	20.50
10	64QAM	25	12	20.01	20.04	19.96	
10	64QAM	25	25	20.06	20.03	20.03	
10	64QAM	50	0	19.98	19.91	20.02	
Channel				23035	23095	23155	Tune-up limit (dBm)
Frequency (MHz)				701.5	707.5	713.5	
5	QPSK	1	0	21.66	21.82	21.77	22.50
5	QPSK	1	12	21.82	21.98	21.82	
5	QPSK	1	24	21.78	21.97	21.83	
5	QPSK	12	0	20.89	20.96	20.95	21.50
5	QPSK	12	7	21.00	21.02	20.99	
5	QPSK	12	13	20.95	20.98	20.95	
5	QPSK	25	0	20.91	21.03	20.99	



5	16QAM	1	0	20.92	20.94	20.96	21.50
5	16QAM	1	12	21.09	21.04	21.05	
5	16QAM	1	24	21.05	21.03	20.99	
5	16QAM	12	0	19.90	19.87	19.90	20.50
5	16QAM	12	7	20.04	20.09	19.93	
5	16QAM	12	13	19.99	19.96	20.01	
5	16QAM	25	0	20.00	19.96	19.98	
5	64QAM	1	0	20.86	20.87	20.92	21.50
5	64QAM	1	12	21.31	21.01	20.94	
5	64QAM	1	24	21.29	20.98	21.03	
5	64QAM	12	0	19.94	19.96	19.91	20.50
5	64QAM	12	7	20.04	19.92	19.98	
5	64QAM	12	13	19.91	20.01	20.06	
5	64QAM	25	0	20.06	20.02	19.99	
Channel				23025	23095	23165	Tune-up limit (dBm)
Frequency (MHz)				700.5	707.5	714.5	
3	QPSK	1	0	21.74	21.83	21.68	22.50
3	QPSK	1	8	21.92	21.91	22.01	
3	QPSK	1	14	21.86	21.97	21.92	
3	QPSK	8	0	20.97	20.95	20.95	21.50
3	QPSK	8	4	21.00	21.03	21.04	
3	QPSK	8	7	20.95	21.03	20.97	
3	QPSK	15	0	20.94	21.02	20.88	
3	16QAM	1	0	20.95	21.31	20.90	21.50
3	16QAM	1	8	21.15	21.13	21.08	
3	16QAM	1	14	20.98	21.03	21.50	
3	16QAM	8	0	20.06	19.95	19.98	20.50
3	16QAM	8	4	20.11	20.08	20.19	
3	16QAM	8	7	19.95	19.98	20.04	
3	16QAM	15	0	19.93	19.86	19.85	
3	64QAM	1	0	20.87	21.21	21.20	21.50
3	64QAM	1	8	21.44	21.44	21.35	
3	64QAM	1	14	21.28	20.94	21.38	
3	64QAM	8	0	19.87	19.95	19.86	20.50
3	64QAM	8	4	19.96	20.00	19.99	
3	64QAM	8	7	19.95	19.87	20.02	
3	64QAM	15	0	19.94	19.96	19.88	



Channel				23017	23095	23173	Tune-up limit (dBm)
Frequency (MHz)				699.7	707.5	715.3	
1.4	QPSK	1	0	21.77	21.81	21.74	22.50
1.4	QPSK	1	3	21.88	21.87	21.89	
1.4	QPSK	1	5	21.77	21.82	21.78	
1.4	QPSK	3	0	21.72	21.85	21.83	
1.4	QPSK	3	1	21.93	21.93	21.94	
1.4	QPSK	3	3	21.88	21.90	21.86	
1.4	QPSK	6	0	20.94	20.91	20.89	21.50
1.4	16QAM	1	0	20.98	20.92	20.61	21.50
1.4	16QAM	1	3	20.79	21.22	21.33	
1.4	16QAM	1	5	20.91	20.92	20.91	
1.4	16QAM	3	0	20.75	20.78	20.79	
1.4	16QAM	3	1	20.91	20.99	20.83	
1.4	16QAM	3	3	20.74	20.88	20.88	
1.4	16QAM	6	0	19.90	19.91	19.93	20.50
1.4	64QAM	1	0	20.71	20.86	20.70	21.50
1.4	64QAM	1	3	20.83	21.34	20.81	
1.4	64QAM	1	5	20.99	21.02	20.98	
1.4	64QAM	3	0	20.89	20.90	20.73	
1.4	64QAM	3	1	20.87	21.11	20.96	
1.4	64QAM	3	3	20.89	20.73	20.89	
1.4	64QAM	6	0	19.96	19.97	19.84	20.50

Note: It will reduce about 0.5dBm by the sensor when it uses to the top antenna and be used for top antenna measurement.



<FDD-LTE Band 17>

BW [MHz]	Modulation	RB Size	RB Offset	Power Low Ch. / Freq.	Power Middle Ch. / Freq.	Power High Ch. / Freq.	Tune-up limit (dBm)
Channel				23780	23790	23800	
Frequency (MHz)				709	710	711	
10	QPSK	1	0	21.72	21.80	21.66	22.00
10	QPSK	1	25	21.92	21.78	21.91	
10	QPSK	1	49	21.75	21.68	21.84	
10	QPSK	25	0	20.75	20.70	20.71	21.00
10	QPSK	25	12	20.95	20.89	20.87	
10	QPSK	25	25	20.73	20.67	20.68	
10	QPSK	50	0	20.71	20.66	20.79	21.50
10	16QAM	1	0	21.37	21.09	21.08	
10	16QAM	1	25	21.00	21.06	20.98	
10	16QAM	1	49	20.89	20.64	20.70	20.00
10	16QAM	25	0	19.69	19.67	19.67	
10	16QAM	25	12	19.83	19.89	19.93	
10	16QAM	25	25	19.68	19.71	19.80	21.50
10	16QAM	50	0	19.60	19.61	19.69	
10	64QAM	1	0	21.30	20.96	20.99	
10	64QAM	1	25	21.04	21.02	20.71	20.00
10	64QAM	1	49	20.98	20.98	20.99	
10	64QAM	25	0	19.62	19.62	19.70	
10	64QAM	25	12	19.95	19.86	19.94	20.00
10	64QAM	25	25	19.67	19.52	19.56	
10	64QAM	50	0	19.62	19.74	19.68	
Channel				23755	23790	23825	Tune-up limit (dBm)
Frequency (MHz)				706.5	710	713.5	
5	QPSK	1	0	21.42	21.59	21.61	22.00
5	QPSK	1	12	21.86	21.90	21.90	
5	QPSK	1	24	21.74	21.68	21.70	
5	QPSK	12	0	20.85	20.82	20.86	21.00
5	QPSK	12	7	20.96	21.00	21.01	
5	QPSK	12	13	20.93	20.95	20.92	
5	QPSK	25	0	20.94	20.83	20.87	



5	16QAM	1	0	20.85	20.52	20.98	21.50
5	16QAM	1	12	21.43	20.82	21.24	
5	16QAM	1	24	21.23	20.56	21.05	
5	16QAM	12	0	19.81	19.86	19.84	20.00
5	16QAM	12	7	19.96	19.86	19.98	
5	16QAM	12	13	19.92	19.91	19.91	
5	16QAM	25	0	19.93	19.87	19.91	21.50
5	64QAM	1	0	20.52	20.69	20.77	
5	64QAM	1	12	21.31	20.96	20.93	
5	64QAM	1	24	21.18	20.71	20.78	20.50
5	64QAM	12	0	19.70	19.85	19.86	
5	64QAM	12	7	19.95	19.88	20.02	
5	64QAM	12	13	19.93	19.95	19.73	20.50
5	64QAM	25	0	19.89	19.93	19.94	

Note: It will reduce about 1dBm by the sensor when it uses to the top antenna and be used for top antenna measurement.

<FDD-LTE Band 18>

BW [MHz]	Modulation	RB Size	RB Offset	Power Low Ch. / Freq.	Power Middle Ch. / Freq.	Power High Ch. / Freq.	Tune-up limit (dBm)
Channel				23925	23925	23925	21.50
Frequency (MHz)				822.5	822.5	822.5	
15	QPSK	1	0	21.02			
15	QPSK	1	37	20.70		20.00	
15	QPSK	1	74	20.77			
15	QPSK	36	0	19.84			
15	QPSK	36	20	19.92		20.50	
15	QPSK	36	39	19.72			
15	QPSK	75	0	19.84			
15	16QAM	1	0	20.30		19.00	
15	16QAM	1	37	19.70			
15	16QAM	1	74	19.77			
15	16QAM	36	0	18.87		19.00	
15	16QAM	36	20	18.89			
15	16QAM	36	39	18.80			
15	16QAM	75	0	18.80			



10	64QAM	1	0	19.98			20.00
10	64QAM	1	25	19.81			
10	64QAM	1	49	19.80			
10	64QAM	25	0	18.82			19.00
10	64QAM	25	12	18.94			
10	64QAM	25	25	18.69			
10	64QAM	50	0	18.82			
Channel				23900	23925	23950	Tune-up limit (dBm)
Frequency (MHz)				820	822.5	825	
10	QPSK	1	0	20.70	20.95	20.96	21.50
10	QPSK	1	25	20.77	20.70	20.57	
10	QPSK	1	49	20.88	20.64	20.52	
10	QPSK	25	0	19.85	19.99	19.81	20.50
10	QPSK	25	12	19.80	19.84	19.90	
10	QPSK	25	25	19.79	19.77	19.78	
10	QPSK	50	0	19.88	19.85	19.84	
10	16QAM	1	0	19.92	19.83	19.98	20.50
10	16QAM	1	25	19.98	19.86	19.85	
10	16QAM	1	49	20.18	19.87	19.87	
10	16QAM	25	0	18.91	18.84	18.88	19.00
10	16QAM	25	12	18.92	18.72	18.95	
10	16QAM	25	25	18.72	18.73	18.68	
10	16QAM	50	0	18.75	18.86	18.91	
10	64QAM	1	0	20.07	19.91	20.18	20.00
10	64QAM	1	25	19.76	19.55	19.60	
10	64QAM	1	49	20.23	19.73	19.79	
10	64QAM	25	0	18.93	18.99	18.80	19.00
10	64QAM	25	12	18.73	18.79	18.78	
10	64QAM	25	25	18.68	18.83	18.74	
10	64QAM	50	0	18.82	18.82	18.80	
Channel				23875	23925	23975	Tune-up limit (dBm)
Frequency (MHz)				817.5	822.5	827.5	
5	QPSK	1	0	20.56	20.67	20.68	21.50
5	QPSK	1	12	20.73	20.77	20.64	
5	QPSK	1	24	20.73	20.77	20.79	
5	QPSK	12	0	19.77	19.81	19.81	20.50



5	QPSK	12	7	19.89	19.85	19.85	
5	QPSK	12	13	19.93	19.87	19.86	
5	QPSK	25	0	19.87	19.84	19.82	
5	16QAM	1	0	19.57	19.91	19.89	20.50
5	16QAM	1	12	19.92	19.88	20.04	
5	16QAM	1	24	19.91	19.88	20.24	
5	16QAM	12	0	18.81	18.77	18.76	19.50
5	16QAM	12	7	18.83	18.78	18.93	
5	16QAM	12	13	19.02	18.82	18.82	
5	16QAM	25	0	18.88	18.89	18.77	
5	64QAM	1	0	19.79	19.81	19.80	20.00
5	64QAM	1	12	19.65	19.88	19.57	
5	64QAM	1	24	19.77	20.02	19.60	
5	64QAM	12	0	18.66	18.73	18.79	19.00
5	64QAM	12	7	18.86	18.85	18.89	
5	64QAM	12	13	19.02	18.93	18.88	
5	64QAM	25	0	18.77	18.84	18.80	

Note: It will reduce about 1.5dBm by the sensor when it uses to the top antenna and be used for top antenna measurement.

<FDD-LTE Band 19>

BW [MHz]	Modulation	RB Size	RB Offset	Power Low Ch. / Freq.	Power Middle Ch. / Freq.	Power High Ch. / Freq.	Tune-up limit (dBm)
Channel				24075	24075	24075	
Frequency (MHz)				837.5	837.5	837.5	
15	QPSK	1	0	21.00			21.50
15	QPSK	1	37	20.70			
15	QPSK	1	74	20.86			
15	QPSK	36	0	19.99			20.50
15	QPSK	36	20	19.97			
15	QPSK	36	39	19.91			
15	QPSK	75	0	19.99			
15	16QAM	1	0	19.97			20.50
15	16QAM	1	37	20.19			
15	16QAM	1	74	19.88			
15	16QAM	36	0	18.94			20.00



15	16QAM	36	20	18.96			
15	16QAM	36	39	18.89			
15	16QAM	75	0	19.79			
10	64QAM	1	0	20.37			20.50
10	64QAM	1	25	19.96			
10	64QAM	1	49	19.89			
10	64QAM	25	0	18.80			19.50
10	64QAM	25	12	19.07			
10	64QAM	25	25	18.88			
10	64QAM	50	0	19.01			
Channel				24050	24075	24100	Tune-up limit (dBm)
Frequency (MHz)				835	837.5	840	
10	QPSK	1	0	20.80	20.84	20.67	21.50
10	QPSK	1	25	20.68	20.79	20.67	
10	QPSK	1	49	20.67	20.49	20.60	
10	QPSK	25	0	19.84	19.86	19.86	20.50
10	QPSK	25	12	19.81	19.91	19.78	
10	QPSK	25	25	19.96	19.78	19.87	
10	QPSK	50	0	19.86	19.88	19.85	
10	16QAM	1	0	19.82	19.93	19.98	20.50
10	16QAM	1	25	20.34	19.77	19.88	
10	16QAM	1	49	19.86	19.83	19.89	
10	16QAM	25	0	18.83	18.97	19.02	19.50
10	16QAM	25	12	18.89	18.77	18.78	
10	16QAM	25	25	18.87	18.81	18.88	
10	16QAM	50	0	18.79	18.90	18.86	
10	64QAM	1	0	20.01	19.83	19.97	20.50
10	64QAM	1	25	19.90	19.64	20.18	
10	64QAM	1	49	19.84	20.12	20.18	
10	64QAM	25	0	18.88	18.92	18.83	19.00
10	64QAM	25	12	18.95	18.79	18.91	
10	64QAM	25	25	18.90	18.82	18.90	
10	64QAM	50	0	18.87	18.92	18.80	
Channel				24025	24075	24125	Tune-up limit (dBm)
Frequency (MHz)				832.5	837.5	842.5	
5	QPSK	1	0	20.69	20.61	20.72	21.50



5	QPSK	1	12	20.78	20.75	20.75	
5	QPSK	1	24	20.84	20.79	20.69	
5	QPSK	12	0	19.75	19.78	19.78	20.50
5	QPSK	12	7	19.90	19.89	19.93	
5	QPSK	12	13	19.89	19.91	19.81	
5	QPSK	25	0	19.83	19.85	19.77	
5	16QAM	1	0	19.70	19.59	20.18	
5	16QAM	1	12	19.90	19.90	20.34	20.50
5	16QAM	1	24	19.85	19.93	20.29	
5	16QAM	12	0	18.73	18.76	18.67	
5	16QAM	12	7	18.92	18.94	18.86	19.50
5	16QAM	12	13	18.87	18.86	18.91	
5	16QAM	25	0	18.76	18.87	18.80	
5	64QAM	1	0	20.09	19.78	19.85	
5	64QAM	1	12	19.99	20.28	19.93	20.50
5	64QAM	1	24	20.02	20.00	19.95	
5	64QAM	12	0	18.71	18.80	18.72	
5	64QAM	12	7	18.85	18.90	18.87	19.00
5	64QAM	12	13	18.94	18.81	18.74	
5	64QAM	25	0	18.82	18.84	18.65	

Note: It will reduce about 1.5dBm by the sensor when it uses to the top antenna and be used for top antenna measurement.

<FDD-LTE Band 25>

BW [MHz]	Modulation	RB Size	RB Offset	Power Low Ch. / Freq.	Power Middle Ch. / Freq.	Power High Ch. / Freq.	Tune-up limit (dBm)
Channel				26140	26365	26590	
Frequency (MHz)				1860	1882.5	1905	
20	QPSK	1	0	14.98	15.28	14.94	15.50
20	QPSK	1	49	15.03	15.25	14.78	
20	QPSK	1	99	15.26	14.91	15.17	
20	QPSK	50	0	14.08	14.30	14.35	14.50
20	QPSK	50	24	14.25	14.38	14.35	
20	QPSK	50	50	14.37	14.20	14.10	
20	QPSK	100	0	14.18	14.32	14.04	
20	16QAM	1	0	14.19	14.37	14.26	14.50



20	16QAM	1	49	14.05	14.44	14.32	
20	16QAM	1	99	14.74	14.31	14.39	
20	16QAM	50	0	13.11	13.33	12.94	
20	16QAM	50	24	13.33	13.26	12.95	13.50
20	16QAM	50	50	13.33	13.23	13.11	
20	16QAM	100	0	13.27	13.18	12.93	
20	64QAM	1	0	14.02	14.43	14.31	14.50
20	64QAM	1	49	14.27	14.18	14.26	
20	64QAM	1	99	14.22	14.21	14.06	
20	64QAM	50	0	13.15	13.30	12.99	13.50
20	64QAM	50	24	13.18	13.32	13.03	
20	64QAM	50	50	13.40	13.24	13.04	
20	64QAM	100	0	13.31	13.26	13.01	
Channel				26115	26365	26615	Tune-up limit (dBm)
Frequency (MHz)				1857.5	1882.5	1907.5	
15	QPSK	1	0	14.87	15.23	14.87	15.50
15	QPSK	1	37	15.12	15.20	14.81	
15	QPSK	1	74	15.17	15.05	15.12	
15	QPSK	36	0	14.06	14.32	14.42	14.50
15	QPSK	36	20	14.26	14.35	14.24	
15	QPSK	36	39	14.31	14.25	14.11	
15	QPSK	75	0	14.17	14.30	14.03	
15	16QAM	1	0	14.35	14.72	14.04	15.00
15	16QAM	1	37	14.11	14.08	14.20	
15	16QAM	1	74	14.40	14.26	14.37	
15	16QAM	36	0	13.08	13.28	12.88	13.50
15	16QAM	36	20	13.24	13.36	13.12	
15	16QAM	36	39	13.28	13.26	13.27	
15	16QAM	75	0	13.22	13.26	12.99	
15	64QAM	1	0	14.09	14.44	14.30	14.50
15	64QAM	1	37	14.42	14.11	14.01	
15	64QAM	1	74	14.46	14.16	14.16	
15	64QAM	36	0	13.10	13.31	12.89	13.50
15	64QAM	36	20	13.21	13.34	12.95	
15	64QAM	36	39	13.34	13.15	13.11	
15	64QAM	75	0	13.28	13.32	13.04	
Channel				26090	26365	26640	Tune-up



Frequency (MHz)				1855	1882.5	1910	limit (dBm)
10	QPSK	1	0	14.81	15.04	14.67	15.50
10	QPSK	1	25	14.84	15.07	14.75	
10	QPSK	1	49	14.98	14.78	15.20	
10	QPSK	25	0	14.09	14.14	14.21	14.50
10	QPSK	25	12	14.02	14.23	14.22	
10	QPSK	25	25	14.09	14.15	14.11	
10	QPSK	50	0	14.02	14.16	14.00	
10	16QAM	1	0	13.88	14.20	13.92	15.00
10	16QAM	1	25	14.36	14.56	14.32	
10	16QAM	1	49	14.34	14.17	14.52	
10	16QAM	25	0	13.01	13.23	12.84	13.50
10	16QAM	25	12	13.09	13.26	12.90	
10	16QAM	25	25	13.05	13.30	13.06	
10	16QAM	50	0	13.01	13.10	12.86	
10	64QAM	1	0	14.37	14.69	14.13	14.50
10	64QAM	1	25	14.38	14.18	14.05	
10	64QAM	1	49	14.39	14.33	14.65	
10	64QAM	25	0	13.01	13.22	12.83	13.50
10	64QAM	25	12	13.09	13.09	12.86	
10	64QAM	25	25	13.18	13.04	13.07	
10	64QAM	50	0	12.98	13.20	13.03	
Channel				26065	26365	26665	Tune-up limit (dBm)
Frequency (MHz)				1852.5	1882.5	1912.5	limit (dBm)
5	QPSK	1	0	14.73	15.11	14.58	15.50
5	QPSK	1	12	14.92	15.08	14.94	
5	QPSK	1	24	15.01	15.18	15.16	
5	QPSK	12	0	13.88	14.11	13.93	14.50
5	QPSK	12	7	14.02	14.18	14.16	
5	QPSK	12	13	14.11	14.19	14.27	
5	QPSK	25	0	14.02	14.19	14.15	
5	16QAM	1	0	14.34	14.60	13.88	14.50
5	16QAM	1	12	13.85	14.63	14.24	
5	16QAM	1	24	14.24	14.61	14.35	
5	16QAM	12	0	12.92	13.20	12.89	13.50
5	16QAM	12	7	13.07	13.22	13.16	



5	16QAM	12	13	13.09	13.18	13.15	
5	16QAM	25	0	12.89	13.21	13.13	
5	64QAM	1	0	14.02	14.29	13.92	14.50
5	64QAM	1	12	14.05	14.30	14.20	
5	64QAM	1	24	14.19	14.36	14.33	
5	64QAM	12	0	12.92	13.18	12.94	13.50
5	64QAM	12	7	13.11	13.12	13.14	
5	64QAM	12	13	12.98	13.20	13.12	
5	64QAM	25	0	13.08	13.26	13.14	
Channel				26055	26365	26675	Tune-up limit (dBm)
Frequency (MHz)				1851.5	1882.5	1913.5	
3	QPSK	1	0	14.64	15.10	14.68	15.50
3	QPSK	1	8	14.93	15.13	15.21	
3	QPSK	1	14	14.89	15.00	15.16	
3	QPSK	8	0	13.83	14.12	13.99	14.50
3	QPSK	8	4	13.92	14.15	14.15	
3	QPSK	8	7	13.93	14.11	14.25	
3	QPSK	15	0	13.96	14.16	14.10	
3	16QAM	1	0	13.62	14.11	13.95	15.00
3	16QAM	1	8	14.43	14.61	14.24	
3	16QAM	1	14	14.30	14.17	14.37	
3	16QAM	8	0	12.92	13.14	13.05	13.50
3	16QAM	8	4	12.99	13.20	13.20	
3	16QAM	8	7	13.02	13.01	13.24	
3	16QAM	15	0	12.83	13.08	13.11	
3	64QAM	1	0	13.87	14.41	13.96	14.50
3	64QAM	1	8	14.40	14.57	14.24	
3	64QAM	1	14	13.82	14.07	14.28	
3	64QAM	8	0	12.89	13.13	13.20	13.50
3	64QAM	8	4	13.01	13.17	13.14	
3	64QAM	8	7	13.17	13.33	13.16	
3	64QAM	15	0	12.90	13.12	13.10	
Channel				26047	26365	26683	Tune-up limit (dBm)
Frequency (MHz)				1850.7	1882.5	1914.3	
1.4	QPSK	1	0	14.71	14.94	14.94	15.50
1.4	QPSK	1	3	14.83	15.14	15.17	



1.4	QPSK	1	5	14.73	15.07	15.18	
1.4	QPSK	3	0	14.70	15.01	15.05	
1.4	QPSK	3	1	14.84	15.07	15.09	
1.4	QPSK	3	3	14.80	15.05	15.19	
1.4	QPSK	6	0	13.84	14.04	14.16	14.50
1.4	16QAM	1	0	14.17	14.21	14.12	15.00
1.4	16QAM	1	3	14.36	14.20	14.64	
1.4	16QAM	1	5	14.15	14.34	14.05	
1.4	16QAM	3	0	13.87	14.05	14.12	
1.4	16QAM	3	1	13.96	14.11	14.18	
1.4	16QAM	3	3	13.88	13.98	14.08	
1.4	16QAM	6	0	12.88	13.10	13.21	13.50
1.4	64QAM	1	0	13.89	14.12	14.10	15.00
1.4	64QAM	1	3	14.01	14.26	14.42	
1.4	64QAM	1	5	13.92	13.91	14.60	
1.4	64QAM	3	0	13.73	14.06	14.14	
1.4	64QAM	3	1	13.89	14.20	14.26	
1.4	64QAM	3	3	13.95	14.12	14.36	
1.4	64QAM	6	0	12.87	13.08	13.15	13.50

Note: It will reduce about 5dBm by the sensor when it uses to the top antenna and be used for top antenna measurement.

<FDD-LTE Band 26>

BW [MHz]	Modulation	RB Size	RB Offset	Power Low Ch. / Freq.	Power Middle Ch. / Freq.	Power High Ch. / Freq.	Tune-up limit (dBm)
Channel				26765	26865	26965	
Frequency (MHz)				821.5	831.5	841.5	
15	QPSK	1	0	21.01	20.95	21.36	21.50
15	QPSK	1	37	21.03	21.00	21.15	
15	QPSK	1	74	20.94	21.10	20.87	
15	QPSK	36	0	20.19	20.31	20.33	20.50
15	QPSK	36	20	20.22	20.28	20.26	
15	QPSK	36	39	20.17	20.22	20.22	
15	QPSK	75	0	20.14	20.25	20.24	
15	16QAM	1	0	20.34	20.37	20.36	20.50
15	16QAM	1	37	20.33	20.29	20.17	



15	16QAM	1	74	20.29	20.59	20.23	
15	16QAM	36	0	19.25	19.20	19.29	20.00
15	16QAM	36	20	19.18	19.35	19.38	
15	16QAM	36	39	19.15	19.18	19.25	
15	16QAM	75	0	19.23	19.25	19.24	
15	64QAM	1	0	19.94	20.23	20.37	20.50
15	64QAM	1	37	20.25	20.64	20.36	
15	64QAM	1	74	20.41	20.24	20.39	
15	64QAM	36	0	19.21	19.27	19.27	19.50
15	64QAM	36	20	19.19	19.20	19.24	
15	64QAM	36	39	19.23	19.26	19.27	
15	64QAM	75	0	19.25	19.33	19.38	
Channel				26740	26865	26990	Tune-up limit (dBm)
Frequency (MHz)				819	831.5	844	
10	QPSK	1	0	21.10	21.22	21.22	21.50
10	QPSK	1	25	21.18	20.91	21.11	
10	QPSK	1	49	20.94	21.12	21.15	
10	QPSK	25	0	20.16	20.24	20.33	20.50
10	QPSK	25	12	20.23	20.22	20.31	
10	QPSK	25	25	20.15	20.31	20.29	
10	QPSK	50	0	20.22	20.19	20.29	
10	16QAM	1	0	20.29	20.65	20.44	20.50
10	16QAM	1	25	20.18	20.50	20.38	
10	16QAM	1	49	20.06	20.27	20.68	
10	16QAM	25	0	19.19	19.31	19.36	19.50
10	16QAM	25	12	19.14	19.25	19.34	
10	16QAM	25	25	19.24	19.21	19.26	
10	16QAM	50	0	19.23	19.27	19.29	
10	64QAM	1	0	20.15	20.34	20.33	20.50
10	64QAM	1	25	20.09	20.35	20.48	
10	64QAM	1	49	20.01	20.10	20.36	
10	64QAM	25	0	19.28	19.34	19.21	19.50
10	64QAM	25	12	19.18	19.24	19.34	
10	64QAM	25	25	19.24	19.35	19.25	
10	64QAM	50	0	19.15	19.26	19.26	
Channel				26715	26865	27015	Tune-up limit
Frequency (MHz)				816.5	831.5	846.5	



							(dBm)
5	QPSK	1	0	20.76	20.90	21.00	21.50
5	QPSK	1	12	21.06	21.00	21.25	
5	QPSK	1	24	21.03	21.04	21.16	
5	QPSK	12	0	19.95	20.06	20.06	20.50
5	QPSK	12	7	20.06	20.14	20.14	
5	QPSK	12	13	20.13	20.20	20.23	
5	QPSK	25	0	20.01	20.11	20.14	
5	16QAM	1	0	20.49	20.20	20.41	20.50
5	16QAM	1	12	20.19	20.47	20.26	
5	16QAM	1	24	20.19	20.27	20.08	
5	16QAM	12	0	18.95	19.00	19.09	19.50
5	16QAM	12	7	19.17	19.15	19.14	
5	16QAM	12	13	19.13	19.20	19.24	
5	16QAM	25	0	19.10	19.13	19.13	
5	64QAM	1	0	20.06	20.16	20.20	20.50
5	64QAM	1	12	20.10	20.21	20.25	
5	64QAM	1	24	19.92	20.14	20.01	
5	64QAM	12	0	19.05	18.95	19.05	19.50
5	64QAM	12	7	19.13	19.12	19.15	
5	64QAM	12	13	19.13	19.08	19.06	
5	64QAM	25	0	19.03	19.18	19.13	
Channel				26705	26865	27025	Tune-up limit (dBm)
Frequency (MHz)				815.5	831.5	847.5	
3	QPSK	1	0	20.80	20.96	21.01	21.50
3	QPSK	1	8	20.96	21.05	21.01	
3	QPSK	1	14	21.00	21.05	21.10	
3	QPSK	8	0	20.00	20.12	20.15	20.50
3	QPSK	8	4	20.06	20.18	20.22	
3	QPSK	8	7	20.02	20.12	20.16	
3	QPSK	15	0	19.99	20.05	20.06	
3	16QAM	1	0	20.18	20.45	20.52	21.00
3	16QAM	1	8	20.43	20.48	20.59	
3	16QAM	1	14	20.45	20.46	20.54	
3	16QAM	8	0	19.10	19.16	19.04	19.50
3	16QAM	8	4	19.11	19.21	19.16	
3	16QAM	8	7	18.97	19.08	19.17	



3	16QAM	15	0	19.06	19.13	19.11	
3	64QAM	1	0	20.40	20.15	20.46	20.50
3	64QAM	1	8	20.08	20.05	20.48	
3	64QAM	1	14	20.09	20.00	20.48	
3	64QAM	8	0	19.12	19.04	19.16	19.50
3	64QAM	8	4	19.00	19.15	19.08	
3	64QAM	8	7	19.05	19.11	19.15	
3	64QAM	15	0	19.05	18.97	19.14	
Channel				26697	26865	27033	Tune-up limit (dBm)
Frequency (MHz)				814.7	831.5	848.3	
1.4	QPSK	1	0	20.79	20.95	21.00	21.50
1.4	QPSK	1	3	20.95	21.04	21.00	
1.4	QPSK	1	5	20.99	21.04	21.09	
1.4	QPSK	3	0	19.99	20.11	20.14	
1.4	QPSK	3	1	20.05	20.17	20.21	
1.4	QPSK	3	3	20.01	20.11	20.15	
1.4	QPSK	6	0	19.98	20.04	20.05	20.50
1.4	16QAM	1	0	20.27	20.44	20.51	21.00
1.4	16QAM	1	3	20.42	20.47	20.58	
1.4	16QAM	1	5	20.44	20.45	20.53	
1.4	16QAM	3	0	19.09	19.15	19.03	
1.4	16QAM	3	1	19.10	19.20	19.15	
1.4	16QAM	3	3	18.96	19.07	19.16	
1.4	16QAM	6	0	19.05	19.12	19.10	19.50
1.4	64QAM	1	0	20.39	20.24	20.45	20.50
1.4	64QAM	1	3	20.27	20.02	20.40	
1.4	64QAM	1	5	20.28	19.99	20.41	
1.4	64QAM	3	0	19.11	19.03	19.15	
1.4	64QAM	3	1	18.99	19.14	19.07	
1.4	64QAM	3	3	19.04	19.10	19.14	
1.4	64QAM	6	0	19.04	18.96	19.13	19.50

Note: It will reduce about 1.5dBm by the sensor when it uses to the top antenna and be used for top antenna measurement.



<FDD-LTE Band 30>

BW [MHz]	Modulation	RB Size	RB Offset	Power Low Ch. / Freq.	Power Middle Ch. / Freq.	Power High Ch. / Freq.	Tune-up limit (dBm)
Channel				27710			
Frequency (MHz)				2310			
10	QPSK	1	0	17.40			17.50
10	QPSK	1	25	17.16			
10	QPSK	1	49	17.21			
10	QPSK	25	0	16.38			16.50
10	QPSK	25	12	16.40			
10	QPSK	25	25	16.36			
10	QPSK	50	0	16.45			
10	16QAM	1	0	16.54			17.00
10	16QAM	1	25	16.76			
10	16QAM	1	49	16.56			
10	16QAM	25	0	15.47			15.50
10	16QAM	25	12	15.42			
10	16QAM	25	25	15.41			
10	16QAM	50	0	15.45			
10	64QAM	1	0	16.33			
10	64QAM	1	25	16.82			17.00
10	64QAM	1	49	16.40			
10	64QAM	25	0	15.43			
10	64QAM	25	12	15.44			16.00
10	64QAM	25	25	15.42			
10	64QAM	50	0	15.39			
Channel				27685	27710	27735	
Frequency (MHz)				2307.5	2310	2312.5	
5	QPSK	1	0	17.27	17.30	17.34	17.50
5	QPSK	1	12	17.30	17.31	17.32	
5	QPSK	1	24	17.30	17.26	17.25	
5	QPSK	12	0	16.46	16.47	16.44	17.00
5	QPSK	12	7	16.51	16.42	16.45	
5	QPSK	12	13	16.44	16.36	16.43	
5	QPSK	25	0	16.46	16.43	16.44	



5	16QAM	1	0	16.76	16.47	16.88	17.00
5	16QAM	1	12	16.85	16.54	16.89	
5	16QAM	1	24	16.79	16.38	16.73	
5	16QAM	12	0	15.39	15.45	15.48	16.00
5	16QAM	12	7	15.50	15.47	15.50	
5	16QAM	12	13	15.48	15.39	15.45	
5	16QAM	25	0	15.52	15.38	15.48	
5	64QAM	1	0	16.71	16.90	16.44	17.00
5	64QAM	1	12	16.34	16.97	16.51	
5	64QAM	1	24	16.23	16.79	16.27	
5	64QAM	12	0	15.33	15.27	15.47	16.00
5	64QAM	12	7	15.48	15.48	15.46	
5	64QAM	12	13	15.39	15.43	15.45	
5	64QAM	25	0	15.43	15.40	15.51	

<TDD-LTE Band 38>

BW [MHz]	Modulation	RB Size	RB Offset	Power Low Ch. / Freq.	Power Middle Ch. / Freq.	Power High Ch. / Freq.	Tune-up limit (dBm)
Channel				37850	38000	38150	
Frequency (MHz)				2580	2595	2610	
20	QPSK	1	0	19.29	19.38	19.37	20.00
20	QPSK	1	49	19.39	19.31	19.40	
20	QPSK	1	99	19.22	19.25	19.30	
20	QPSK	50	0	18.47	18.47	18.56	19.00
20	QPSK	50	24	18.49	18.53	18.53	
20	QPSK	50	50	18.33	18.43	18.47	
20	QPSK	100	0	18.45	18.58	18.48	
20	16QAM	1	0	18.57	18.64	18.56	19.00
20	16QAM	1	49	18.67	18.51	18.56	
20	16QAM	1	99	18.53	18.46	18.50	
20	16QAM	50	0	17.57	17.67	17.54	18.00
20	16QAM	50	24	17.51	17.58	17.53	
20	16QAM	50	50	17.56	17.56	17.62	
20	16QAM	100	0	17.51	17.58	17.58	
20	64QAM	1	0	18.50	18.59	18.51	19.00
20	64QAM	1	49	18.59	18.55	18.59	



20	64QAM	1	99	18.63	18.48	18.53	18.00
20	64QAM	50	0	17.50	17.64	17.65	
20	64QAM	50	24	17.52	17.59	17.54	
20	64QAM	50	50	17.62	17.62	17.49	
20	64QAM	100	0	17.55	17.51	17.53	
Channel				37825	38000	38175	Tune-up limit (dBm)
Frequency (MHz)				2577.5	2595	2612.5	
15	QPSK	1	0	19.29	19.38	19.37	20.00
15	QPSK	1	37	19.39	19.31	19.40	
15	QPSK	1	74	19.22	19.25	19.30	
15	QPSK	36	0	18.47	18.47	18.43	19.00
15	QPSK	36	20	18.49	18.53	18.53	
15	QPSK	36	39	18.33	18.56	18.47	
15	QPSK	75	0	18.45	18.58	18.48	
15	16QAM	1	0	18.57	18.64	18.56	19.00
15	16QAM	1	37	18.67	18.51	18.56	
15	16QAM	1	74	18.53	18.46	18.50	
15	16QAM	36	0	17.57	17.67	17.54	18.00
15	16QAM	36	20	17.51	17.58	17.53	
15	16QAM	36	39	17.56	17.56	17.62	
15	16QAM	75	0	17.51	17.58	17.58	
15	64QAM	1	0	18.50	18.59	18.51	19.00
15	64QAM	1	37	18.59	18.55	18.59	
15	64QAM	1	74	18.63	18.48	18.53	
15	64QAM	36	0	17.50	17.64	17.65	18.00
15	64QAM	36	20	17.52	17.59	17.54	
15	64QAM	36	39	17.62	17.62	17.49	
15	64QAM	75	0	17.55	17.51	17.53	
Channel				37800	38000	38200	Tune-up limit (dBm)
Frequency (MHz)				2575	2595	2615	
10	QPSK	1	0	19.06	19.26	19.10	20.00
10	QPSK	1	25	19.01	19.13	19.11	
10	QPSK	1	49	18.99	19.14	19.12	
10	QPSK	25	0	18.30	18.44	18.31	19.00
10	QPSK	25	12	18.31	18.37	18.31	
10	QPSK	25	25	18.32	18.42	18.35	



10	QPSK	50	0	18.31	18.36	18.32	
10	16QAM	1	0	18.27	18.43	18.40	19.00
10	16QAM	1	25	18.33	18.50	18.37	
10	16QAM	1	49	18.30	18.38	18.42	
10	16QAM	25	0	17.37	17.44	17.42	18.00
10	16QAM	25	12	17.32	17.47	17.43	
10	16QAM	25	25	17.37	17.37	17.36	
10	16QAM	50	0	17.27	17.41	17.42	
10	64QAM	1	0	18.23	18.33	18.39	19.00
10	64QAM	1	25	18.30	18.40	18.41	
10	64QAM	1	49	18.21	18.41	18.28	
10	64QAM	25	0	17.28	17.38	17.25	18.00
10	64QAM	25	12	17.40	17.36	17.31	
10	64QAM	25	25	17.31	17.31	17.34	
10	64QAM	50	0	17.34	17.39	17.40	
Channel				37775	38000	38225	Tune-up limit (dBm)
Frequency (MHz)				2572.5	2595	2617.5	
5	QPSK	1	0	18.91	19.21	19.13	20.00
5	QPSK	1	12	19.08	19.33	19.21	
5	QPSK	1	24	19.15	19.22	19.10	
5	QPSK	12	0	18.26	18.32	18.31	19.00
5	QPSK	12	7	18.35	18.50	18.41	
5	QPSK	12	13	18.31	18.39	18.41	
5	QPSK	25	0	18.38	18.27	18.24	
5	16QAM	1	0	18.34	18.45	18.38	19.00
5	16QAM	1	12	18.49	18.62	18.45	
5	16QAM	1	24	18.43	18.48	18.44	
5	16QAM	12	0	17.38	17.37	17.41	18.00
5	16QAM	12	7	17.43	17.49	17.51	
5	16QAM	12	13	17.42	17.46	17.46	
5	16QAM	25	0	17.37	17.37	17.40	
5	64QAM	1	0	18.21	18.36	18.28	19.00
5	64QAM	1	12	18.40	18.44	18.43	
5	64QAM	1	24	18.46	18.47	18.40	
5	64QAM	12	0	17.26	17.25	17.30	18.00
5	64QAM	12	7	17.32	17.44	17.40	
5	64QAM	12	13	17.36	17.46	17.39	



5	64QAM	25	0	17.34	17.30	17.29	
---	-------	----	---	-------	-------	-------	--

Note: It will reduce about 3.5dBm by the sensor when it uses to the top antenna and be used for top antenna measurement.

<TDD-LTE Band 40A>

BW [MHz]	Modulation	RB Size	RB Offset	Power Low Ch. / Freq.	Power Middle Ch. / Freq.	Power High Ch. / Freq.	Tune-up limit (dBm)
Channel				38750			
Frequency (MHz)				2310			
10	QPSK	1	0	19.66			20.00
10	QPSK	1	25	19.60			
10	QPSK	1	49	19.42			
10	QPSK	25	0	18.78			19.00
10	QPSK	25	12	18.68			
10	QPSK	25	25	18.69			
10	QPSK	50	0	18.71			
10	16QAM	1	0	18.91			19.00
10	16QAM	1	25	18.77			
10	16QAM	1	49	18.63			
10	16QAM	25	0	17.84			18.00
10	16QAM	25	12	17.78			
10	16QAM	25	25	17.73			
10	16QAM	50	0	17.78			
10	64QAM	1	0	18.82			19.00
10	64QAM	1	25	18.85			
10	64QAM	1	49	18.69			
10	64QAM	25	0	17.82			18.00
10	64QAM	25	12	17.71			
10	64QAM	25	25	17.65			
10	64QAM	50	0	17.80			
Channel				38725	38750	38775	Tune-up limit (dBm)
Frequency (MHz)				2307.5	2310	2312.5	
5	QPSK	1	0	19.53	19.60	19.62	20.00
5	QPSK	1	12	19.54	19.65	19.53	
5	QPSK	1	24	19.50	19.58	19.57	



5	QPSK	12	0	18.73	18.80	18.77	19.00
5	QPSK	12	7	18.80	18.88	18.94	
5	QPSK	12	13	18.74	18.83	18.89	
5	QPSK	25	0	18.80	18.83	18.86	
5	16QAM	1	0	18.88	19.00	18.92	19.00
5	16QAM	1	12	18.87	18.93	19.00	
5	16QAM	1	24	18.70	18.80	18.81	
5	16QAM	12	0	17.82	17.89	17.88	18.00
5	16QAM	12	7	17.85	17.92	17.89	
5	16QAM	12	13	17.86	17.92	17.93	
5	16QAM	25	0	17.94	17.85	17.93	
5	64QAM	1	0	18.78	18.89	18.93	19.00
5	64QAM	1	12	18.84	18.86	18.89	
5	64QAM	1	24	18.75	18.79	18.81	
5	64QAM	12	0	17.80	17.88	17.88	18.00
5	64QAM	12	7	17.80	17.86	17.85	
5	64QAM	12	13	17.80	17.81	17.79	
5	64QAM	25	0	17.85	17.88	17.86	

Note: It will reduce about 3dBm by the sensor when it uses to the top antenna and be used for top antenna measurement.

<TDD-LTE Band 40B>

BW [MHz]	Modulation	RB Size	RB Offset	Power Low Ch. / Freq.	Power Middle Ch. / Freq.	Power High Ch. / Freq.	Tune-up limit (dBm)
Channel				39200			
Frequency (MHz)				2355			
10	QPSK	1	0		19.62		20.00
10	QPSK	1	25		19.77		
10	QPSK	1	49		19.34		
10	QPSK	25	0		18.79		19.00
10	QPSK	25	12		18.72		
10	QPSK	25	25		18.64		
10	QPSK	50	0		18.82		
10	16QAM	1	0		18.95		19.00
10	16QAM	1	25		18.97		
10	16QAM	1	49		18.85		



10	16QAM	25	0	17.86			18.00
10	16QAM	25	12	17.82			
10	16QAM	25	25	17.82			
10	16QAM	50	0	17.86			
10	64QAM	1	0	18.95			19.00
10	64QAM	1	25	18.88			
10	64QAM	1	49	18.71			
10	64QAM	25	0	17.83			18.00
10	64QAM	25	12	17.82			
10	64QAM	25	25	17.75			
10	64QAM	50	0	17.77			
Channel				39175	39200	39225	Tune-up limit (dBm)
Frequency (MHz)				2352.5	2355	2357.5	
5	QPSK	1	0	19.70	19.67	19.73	20.00
5	QPSK	1	12	19.71	19.62	19.75	
5	QPSK	1	24	19.47	19.63	19.62	
5	QPSK	12	0	18.79	18.92	18.96	19.00
5	QPSK	12	7	18.86	18.84	18.89	
5	QPSK	12	13	18.80	18.81	18.88	
5	QPSK	25	0	18.81	18.82	18.87	
5	16QAM	1	0	18.90	18.92	18.99	19.00
5	16QAM	1	12	18.95	18.93	18.90	
5	16QAM	1	24	18.80	18.86	18.84	
5	16QAM	12	0	17.90	17.90	17.91	18.00
5	16QAM	12	7	17.88	17.93	17.95	
5	16QAM	12	13	17.83	17.90	17.93	
5	16QAM	25	0	17.85	17.76	17.83	
5	64QAM	1	0	18.91	18.93	19.04	19.00
5	64QAM	1	12	18.83	18.85	18.89	
5	64QAM	1	24	18.83	18.73	18.73	
5	64QAM	12	0	17.88	17.79	17.80	18.00
5	64QAM	12	7	17.92	17.82	17.91	
5	64QAM	12	13	17.86	17.90	17.83	
5	64QAM	25	0	17.81	17.79	17.91	

Note: It will reduce about 3dBm by the sensor when it uses to the top antenna and be used for top antenna measurement.

<TDD-LTE Band 41>

BW [MHz]	Modulation	RB Size	RB Offset	Power Low Ch. / Freq.	Power Middle Low Ch. / Freq.	Power Middle High Ch. / Freq.	Power High Ch. / Freq.	Tune-up limit (dBm)
Channel				40340	40600	40870	41140	
Frequency (MHz)				2565	2591	2618	2645	
20	QPSK	1	0	19.17	19.32	19.43	15.67	
20	QPSK	1	49	19.27	19.25	19.11	15.77	
20	QPSK	1	99	19.30	19.18	19.11	15.80	22.50
20	QPSK	50	0	18.37	18.53	18.54	14.87	
20	QPSK	50	24	18.58	18.46	18.39	15.08	
20	QPSK	50	50	18.60	18.43	18.26	15.10	
20	QPSK	100	0	18.54	18.44	18.42	15.04	
20	16QAM	1	0	18.46	18.59	18.61	14.96	18.50
20	16QAM	1	49	18.65	18.46	18.47	15.15	
20	16QAM	1	99	18.72	18.45	18.20	15.22	
20	16QAM	50	0	17.54	17.57	17.56	14.04	17.50
20	16QAM	50	24	17.59	17.54	17.43	14.09	
20	16QAM	50	50	17.57	17.51	17.25	14.07	
20	16QAM	100	0	17.55	17.54	17.41	14.05	
20	64QAM	1	0	18.36	18.46	18.68	14.86	17.50
20	64QAM	1	49	18.56	18.42	18.29	15.06	
20	64QAM	1	99	18.52	18.43	18.16	15.02	
20	64QAM	50	0	17.41	17.46	17.47	13.91	16.50
20	64QAM	50	24	17.52	17.56	17.47	14.02	
20	64QAM	50	50	17.57	17.39	17.19	14.07	
20	64QAM	100	0	17.63	17.52	17.42	14.13	
Channel				40315	40595	40885	41165	Tune-up limit (dBm)
Frequency (MHz)				2562.5	2590.5	2619.5	2647.5	
15	QPSK	1	0	19.22	19.33	19.40	15.72	19.50
15	QPSK	1	37	19.40	19.22	19.25	15.90	
15	QPSK	1	74	19.40	19.38	18.99	15.90	
15	QPSK	36	0	18.46	18.45	18.54	14.96	22.50
15	QPSK	36	20	18.49	18.56	18.37	14.99	
15	QPSK	36	39	18.62	18.45	18.25	15.12	



15	QPSK	75	0	18.48	18.49	18.36	14.98	
15	16QAM	1	0	18.47	18.49	18.64	14.97	18.50
15	16QAM	1	37	18.63	18.59	18.39	15.13	
15	16QAM	1	74	18.73	18.46	18.24	15.23	
15	16QAM	36	0	17.37	17.47	17.51	13.87	17.50
15	16QAM	36	20	17.48	17.46	17.40	13.98	
15	16QAM	36	39	17.61	17.45	17.24	14.11	
15	16QAM	75	0	17.56	17.47	17.37	14.06	
15	64QAM	1	0	18.38	18.45	18.63	14.88	17.50
15	64QAM	1	37	18.48	18.43	18.25	14.98	
15	64QAM	1	74	18.50	18.51	18.57	15.00	
15	64QAM	36	0	17.41	17.47	17.54	13.91	16.50
15	64QAM	36	20	17.59	17.44	17.38	14.09	
15	64QAM	36	39	17.63	17.43	17.26	14.13	
15	64QAM	75	0	17.55	17.53	17.41	14.05	
Channel				40290	40590	40890	41190	Tune-up limit (dBm)
Frequency (MHz)				2560	2590	2620	2650	
10	QPSK	1	0	19.11	19.15	19.01	15.61	19.50
10	QPSK	1	25	19.31	19.17	19.15	15.81	
10	QPSK	1	49	19.13	19.08	19.04	15.63	
10	QPSK	25	0	18.39	18.38	18.30	14.89	18.50
10	QPSK	25	12	18.40	18.38	18.32	14.90	
10	QPSK	25	25	18.35	18.29	18.18	14.85	
10	QPSK	50	0	18.42	18.36	18.26	14.92	
10	16QAM	1	0	18.53	18.44	18.39	15.03	18.50
10	16QAM	1	25	18.39	18.53	18.47	14.89	
10	16QAM	1	49	18.43	18.41	18.37	14.93	
10	16QAM	25	0	17.48	17.44	17.35	13.98	17.50
10	16QAM	25	12	17.41	17.43	17.31	13.91	
10	16QAM	25	25	17.38	17.38	17.20	13.88	
10	16QAM	50	0	17.47	17.43	17.25	13.97	
10	64QAM	1	0	18.35	18.35	18.40	14.85	17.50
10	64QAM	1	25	18.27	18.44	18.19	14.77	
10	64QAM	1	49	18.36	18.30	18.18	14.86	
10	64QAM	25	0	17.42	17.28	17.25	13.92	16.50
10	64QAM	25	12	17.46	17.26	17.25	13.96	
10	64QAM	25	25	17.38	17.28	17.15	13.88	



10	64QAM	50	0	17.38	17.27	17.33	13.88	
Channel				40265	40585	40905	41215	Tune-up limit (dBm)
Frequency (MHz)				2557.5	2589.5	2621.5	2652.5	
5	QPSK	1	0	19.21	19.22	19.23	15.71	19.50
5	QPSK	1	12	19.29	19.13	19.16	15.79	
5	QPSK	1	24	19.25	19.16	19.07	15.75	
5	QPSK	12	0	18.41	18.40	18.34	14.91	18.50
5	QPSK	12	7	18.46	18.45	18.38	14.96	
5	QPSK	12	13	18.44	18.40	18.33	14.94	
5	QPSK	25	0	18.41	18.39	18.29	14.91	18.50
5	16QAM	1	0	18.48	18.45	18.44	14.98	
5	16QAM	1	12	18.54	18.47	18.41	15.04	
5	16QAM	1	24	18.53	18.42	18.28	15.03	17.50
5	16QAM	12	0	17.42	17.44	17.37	13.92	
5	16QAM	12	7	17.49	17.38	17.38	13.99	
5	16QAM	12	13	17.45	17.44	17.32	13.95	17.50
5	16QAM	25	0	17.39	17.40	17.38	13.89	
5	64QAM	1	0	18.42	18.40	18.40	14.92	
5	64QAM	1	12	18.51	18.45	18.29	15.01	17.50
5	64QAM	1	24	18.43	18.41	18.37	14.93	
5	64QAM	12	0	17.37	17.43	17.27	13.87	
5	64QAM	12	7	17.45	17.42	17.38	13.95	21.00
5	64QAM	12	13	17.51	17.40	17.27	14.01	
5	64QAM	25	0	17.32	17.33	17.27	13.82	

Note: It will reduce about 4dBm by the sensor when it uses to the top antenna and be used for top antenna measurement.



<FDD-LTE Band 66>

BW [MHz]	Modulation	RB Size	RB Offset	Power Low Ch. / Freq.	Power Middle Ch. / Freq.	Power High Ch. / Freq.	Tune-up limit (dBm)
Channel				132072	132322	132572	
Frequency (MHz)				1720	1745	1770	
20	QPSK	1	0	17.51	17.45	17.86	18.00
20	QPSK	1	49	17.53	17.50	17.65	
20	QPSK	1	99	17.44	17.60	17.37	
20	QPSK	50	0	16.69	16.81	16.83	17.00
20	QPSK	50	24	16.72	16.78	16.76	
20	QPSK	50	50	16.67	16.72	16.72	
20	QPSK	100	0	16.64	16.75	16.74	
20	16QAM	1	0	16.84	16.87	16.86	17.00
20	16QAM	1	49	16.83	16.79	16.67	
20	16QAM	1	99	16.79	17.09	16.73	
20	16QAM	50	0	15.75	15.70	15.79	16.00
20	16QAM	50	24	15.68	15.85	15.88	
20	16QAM	50	50	15.65	15.68	15.75	
20	16QAM	100	0	15.73	15.75	15.74	
20	64QAM	1	0	16.44	16.73	16.87	17.00
20	64QAM	1	49	16.75	16.84	16.86	
20	64QAM	1	99	16.91	16.74	16.89	
20	64QAM	50	0	15.71	15.77	15.77	16.00
20	64QAM	50	24	15.69	15.70	15.74	
20	64QAM	50	50	15.73	15.76	15.77	
20	64QAM	100	0	15.75	15.83	15.88	
Channel				132047	132322	132597	Tune-up limit (dBm)
Frequency (MHz)				1717.5	1745	1772.5	
15	QPSK	1	0	17.60	17.72	17.72	18.00
15	QPSK	1	37	17.68	17.41	17.61	
15	QPSK	1	74	17.44	17.62	17.65	
15	QPSK	36	0	16.66	16.74	16.83	17.00
15	QPSK	36	20	16.73	16.72	16.81	
15	QPSK	36	39	16.65	16.81	16.79	
15	QPSK	75	0	16.72	16.69	16.79	



15	16QAM	1	0	16.79	17.15	16.94	17.50
15	16QAM	1	37	16.68	17.00	16.88	
15	16QAM	1	74	16.56	16.77	17.18	
15	16QAM	36	0	15.69	15.81	15.86	16.00
15	16QAM	36	20	15.64	15.75	15.84	
15	16QAM	36	39	15.74	15.71	15.76	
15	16QAM	75	0	15.73	15.77	15.79	
15	64QAM	1	0	16.65	16.84	16.63	17.00
15	64QAM	1	37	16.59	16.85	16.68	
15	64QAM	1	74	16.78	16.84	16.71	
15	64QAM	36	0	15.68	15.74	15.84	16.00
15	64QAM	36	20	15.74	15.85	15.75	
15	64QAM	36	39	15.65	15.76	15.76	
15	64QAM	75	0	15.58	15.72	15.71	
Channel				132022	132322	132622	Tune-up limit (dBm)
Frequency (MHz)				1715	1745	1775	
10	QPSK	1	0	17.26	17.40	17.50	18.00
10	QPSK	1	25	17.56	17.50	17.75	
10	QPSK	1	49	17.53	17.54	17.66	
10	QPSK	25	0	16.45	16.56	16.56	17.00
10	QPSK	25	12	16.56	16.64	16.64	
10	QPSK	25	25	16.63	16.70	16.73	
10	QPSK	50	0	16.51	16.61	16.64	
10	16QAM	1	0	16.99	16.70	16.91	17.00
10	16QAM	1	25	16.69	16.97	16.76	
10	16QAM	1	49	16.69	16.57	16.38	
10	16QAM	25	0	15.45	15.50	15.59	16.00
10	16QAM	25	12	15.67	15.65	15.64	
10	16QAM	25	25	15.63	15.70	15.74	
10	16QAM	50	0	15.60	15.63	15.63	
10	64QAM	1	0	16.56	16.66	16.70	17.00
10	64QAM	1	25	16.60	16.71	16.75	
10	64QAM	1	49	16.42	16.64	16.51	
10	64QAM	25	0	15.55	15.45	15.55	16.00
10	64QAM	25	12	15.63	15.62	15.65	
10	64QAM	25	25	15.63	15.58	15.56	
10	64QAM	50	0	15.53	15.68	15.63	



Channel				131997	132322	132647	Tune-up limit (dBm)
Frequency (MHz)				1712.5	1745	1777.5	
5	QPSK	1	0	17.30	17.46	17.51	18.00
5	QPSK	1	12	17.46	17.55	17.51	
5	QPSK	1	24	17.50	17.55	17.60	
5	QPSK	12	0	16.50	16.62	16.65	17.00
5	QPSK	12	7	16.56	16.68	16.72	
5	QPSK	12	13	16.52	16.62	16.66	
5	QPSK	25	0	16.49	16.55	16.56	
5	16QAM	1	0	16.58	16.95	17.02	17.50
5	16QAM	1	12	16.93	16.98	17.09	
5	16QAM	1	24	16.95	16.96	17.04	
5	16QAM	12	0	15.60	15.66	15.54	16.00
5	16QAM	12	7	15.61	15.71	15.66	
5	16QAM	12	13	15.47	15.58	15.67	
5	16QAM	25	0	15.56	15.63	15.61	
5	64QAM	1	0	16.90	16.55	16.96	17.00
5	64QAM	1	12	16.58	16.45	16.98	
5	64QAM	1	24	16.59	16.50	16.98	
5	64QAM	12	0	15.62	15.54	15.66	16.00
5	64QAM	12	7	15.50	15.65	15.58	
5	64QAM	12	13	15.55	15.61	15.65	
5	64QAM	25	0	15.55	15.47	15.64	
Channel				131987	132322	132657	Tune-up limit (dBm)
Frequency (MHz)				1711.5	1745	1778.5	
3	QPSK	1	0	17.30	17.46	17.51	18.00
3	QPSK	1	8	17.46	17.55	17.51	
3	QPSK	1	14	17.50	17.55	17.60	
3	QPSK	8	0	16.50	16.62	16.65	17.00
3	QPSK	8	4	16.56	16.68	16.72	
3	QPSK	8	7	16.52	16.62	16.66	
3	QPSK	15	0	16.49	16.55	16.56	
3	16QAM	1	0	16.58	16.95	17.02	17.50
3	16QAM	1	8	16.93	16.98	17.09	
3	16QAM	1	14	16.95	16.96	17.04	
3	16QAM	8	0	15.60	15.66	15.54	16.00



3	16QAM	8	4	15.61	15.71	15.66	
3	16QAM	8	7	15.47	15.58	15.67	
3	16QAM	15	0	15.56	15.63	15.61	
3	64QAM	1	0	16.90	16.55	16.96	17.00
3	64QAM	1	8	16.58	16.45	16.98	
3	64QAM	1	14	16.59	16.50	16.98	
3	64QAM	8	0	15.62	15.54	15.66	16.00
3	64QAM	8	4	15.50	15.65	15.58	
3	64QAM	8	7	15.55	15.61	15.65	
3	64QAM	15	0	15.55	15.47	15.64	
Channel				131979	132322	132665	Tune-up limit (dBm)
Frequency (MHz)				1710.7	1745	1779.3	
1.4	QPSK	1	0	17.34	17.50	17.55	18.00
1.4	QPSK	1	3	17.50	17.59	17.55	
1.4	QPSK	1	5	17.54	17.59	17.64	
1.4	QPSK	3	0	16.54	16.66	16.69	
1.4	QPSK	3	1	16.60	16.72	16.76	
1.4	QPSK	3	3	16.56	16.66	16.70	
1.4	QPSK	6	0	16.53	16.59	16.60	17.00
1.4	16QAM	1	0	16.62	16.99	17.06	17.50
1.4	16QAM	1	3	16.97	17.02	17.13	
1.4	16QAM	1	5	16.99	17.00	17.08	
1.4	16QAM	3	0	15.64	15.70	15.58	
1.4	16QAM	3	1	15.65	15.75	15.70	
1.4	16QAM	3	3	15.51	15.62	15.71	
1.4	16QAM	6	0	15.60	15.67	15.65	16.00
1.4	64QAM	1	0	16.94	16.59	17.00	17.50
1.4	64QAM	1	3	16.62	16.49	17.02	
1.4	64QAM	1	5	16.63	16.54	17.02	
1.4	64QAM	3	0	15.66	15.58	15.70	
1.4	64QAM	3	1	15.54	15.69	15.62	
1.4	64QAM	3	3	15.59	15.65	15.69	
1.4	64QAM	6	0	15.59	15.51	15.68	16.00

Note: It will reduce about 5dBm by the sensor when it uses to the top antenna and be used for top antenna measurement.

14. LTE Carrier Aggregation

This device supports Carrier Aggregation on downlink for inter. For the device supports bands and bandwidths and configurations are provided as follow table was according to 3GPP.

E-UTRA CA configuration	Downlink CA configurations (NOTE 3)	Component carriers in order of increasing carrier frequency			Maximum aggregated bandwidth [MHz]	Bandwidth combination set
		Channel bandwidths for carrier [MHz]	Channel bandwidths for carrier [MHz]	Channel bandwidths for carrier [MHz]		
CA_38C	CA_38C	15	15		40	0
		20	20			
CA_41C	CA_41C	10	20		40	0
		15	15, 20			
		20	10,15,20			
		5,10	20		40	1
		15	15, ,20			
		20	5,10,15,20			

14.1. LTE Downlink Carrier Aggregation Conducted Power

1. According to KDB941225 D05A v01r02, Uplink maximum output power measurement with downlink carrier aggregation active should be measured, using the highest output channel measured without downlink carrier aggregation, to confirm that uplink maximum output power with downlink carrier aggregation active remains within the specified tune-up tolerance limits and not more than ¼ dB higher than the maximum output measured without downlink carrier aggregation active.
2. Uplink maximum output power with downlink carrier aggregation active does not show more than ¼ dB higher than the maximum output power without downlink carrier aggregation active, therefore SAR evaluation with downlink carrier aggregation active can be excluded.
3. For power measurement were control and acknowledge data is sent on uplink channels that operate identical to specifications when downlink carrier aggregation is inactive.
4. Selected highest measured power when downlink carrier aggregation is inactive for conducted power comparison with downlink carrier aggregation is active, to confirm that when downlink carrier aggregation is active uplink maximum output power remains within the specified tune-up tolerance limits and not more than ¼ dB higher than the maximum output power measured when downlink carrier aggregation inactive.
5. For non-contiguous intra-band CA, the SCC selected to provide maximum separation from the PCC and must remain fully within the downlink transmission band.
6. For Intra-band, contiguous CA, the downlink channels selected to perform the uplink power measurement must satisfy
7. 3GPP channel spacing (5.4.1A of 3GPP TS 36.521 or equivalent) and channel bandwidth (5.4.2A) requirements.

$$\text{Nominal channel spacing} = \left\lceil \frac{BW_{\text{Channel}(1)} + BW_{\text{Channel}(2)} - 0.1|BW_{\text{Channel}(1)} - BW_{\text{Channel}(2)}|}{0.6} \right\rceil 0.3 \text{ [MHz]}$$



Full Power for Two Carrier power verification:

PCC						SCC1					Power	
Band	BW (MHz)	RB	Offset	UL Channel	UL Freq. (MHz)	BW (MHz)	RB	Offset	DL Channel	DL Freq. (MHz)	Rel.10 Tx. Power	Rel.8 Tx. Power
intra-band CA (2CC)												
LTE Band 38	20	1	0	38150	2610	20	1	0	38150	2610	22.77	22.94
LTE Band 41	20	1	0	40340	2565	20	1	0	40719	2602.9	22.65	22.94

Down Power for Two Carrier power verification:

PCC						SCC1					Power	
Band	BW (MHz)	RB	Offset	UL Channel	UL Freq. (MHz)	BW (MHz)	RB	Offset	DL Channel	DL Freq. (MHz)	Rel.10 Tx. Power	Rel.8 Tx. Power
intra-band CA (2CC)												
LTE Band 38	20	1	0	38150	2610	20	1	0	38150	2610	19.40	19.37
LTE Band 41	20	1	0	40340	2565	20	1	0	40719	2602.9	19.15	19.30

15. Hot-Spot Mode Evaluation Procedure

15.1. EUT Antenna Location

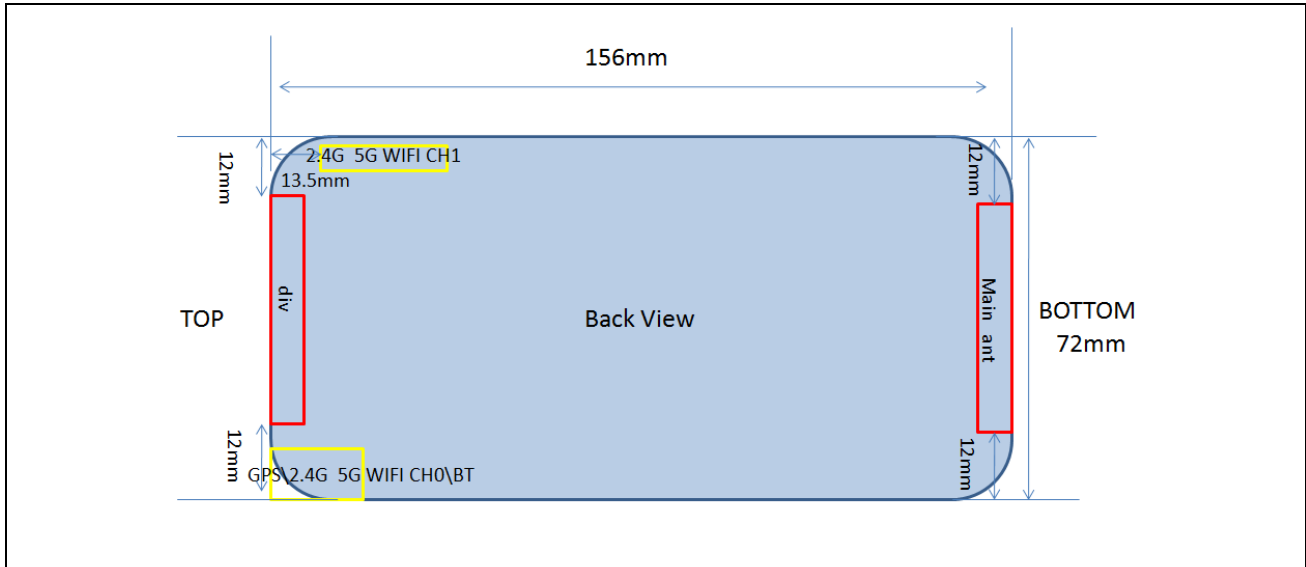

WWAN antenna supported TX bands :
 GSM 850/1900
 UMTS Band II/IV/V
 FDD LTE Band 2/4/5/7/12/17/18/19/25/26/30/66
 TDD LTE Band 38/40/41
 WLAN antenna supported bands : 2.4GHz/5GHz
 BT antenna supported bands: 2.4GHz

EUT Antenna Distance:

Antenna Location	Support Function	Top Side(mm)	Bottom Side(mm)	Left Side(mm)	Right Side(mm)
WWAN Main Antenna	TX/RX	148	\	12	12
WWAN div Antenna	DRX	\	140	12	12
WLAN CH0 Antenna	TX/RX	13.5	123	53	\
WLAN CH1/BT Antenna	TX/RX	\	145	\	53

Hotspot Evaluation:

Assessment	Hotspot side for SAR Test distance: 10mm					
	Back	Front	Top	Bottom	Left	Right
Antennas						
WWAN Main Antenna	Yes	Yes	No	Yes	Yes	Yes
WWAN div Antenna	Yes	Yes	Yes	No	Yes	Yes
WLAN CH0 Antenna	Yes	Yes	Yes	No	No	Yes
WLAN CH1/BT Antenna	Yes	Yes	Yes	No	Yes	No



Note :

1. The SAR evaluation procedures for Portable Devices with Wireless Router function is according to KDB 941225 D06 Hotspot SAR v02r01.
2. Head/Body-worn/Hotspot mode SAR assessments are required.
3. Referring to KDB 941225 D06, when the overall device length and width are $\geq 9\text{cm} \times 5\text{cm}$, the test distance is 10 mm. SAR must be measured for all sides and surfaces with a transmitting antenna located within 25mm from that surface or edge.
4. For Main antenna, SAR measurements at Top side are not required since the distance between DUT and flat phantom $> 25\text{mm}$.
5. For WLAN&BT antenna, SAR measurements Bottom side and Right side are not required since the distance between DUT and flat phantom $> 25\text{mm}$.

16. Block diagram of the tests to be performed

16.1. Head

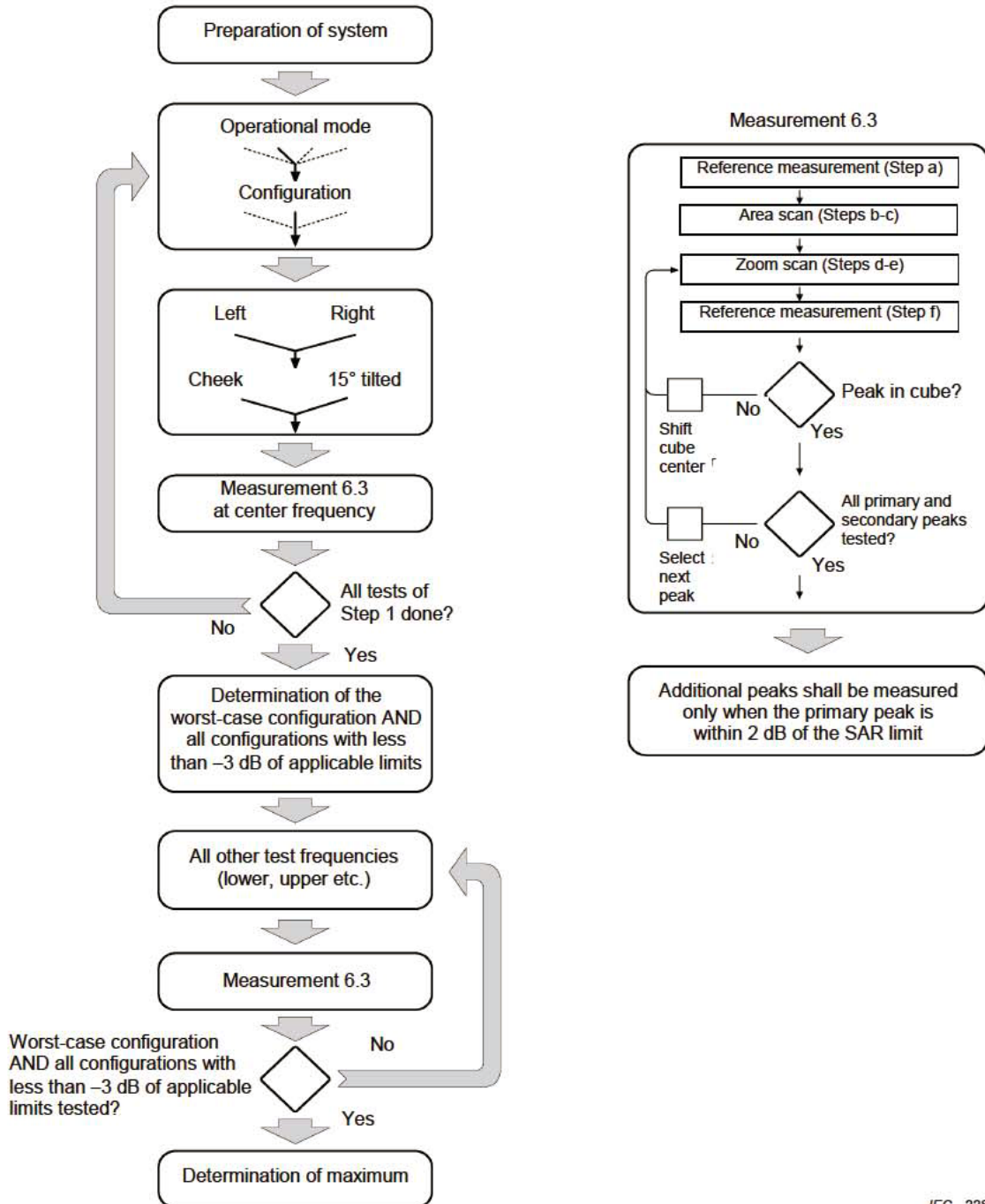

IEC 228/05

16.2. Body

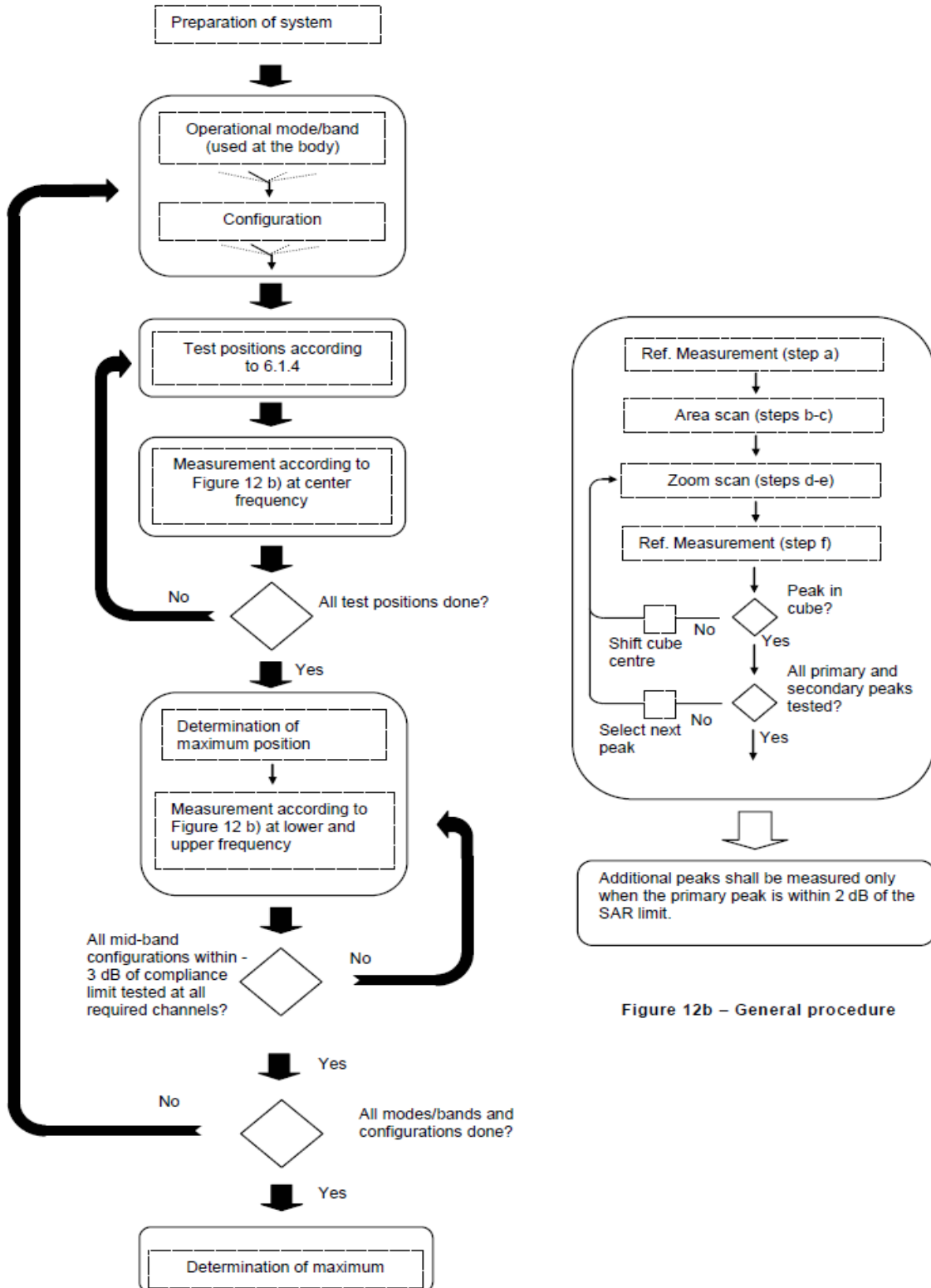

Figure 12b – General procedure

17. Test Results List

17.1. Test Guidance

1. Per KDB 447498 D01v06, the reported SAR is the measured SAR value adjusted for maximum tune-up tolerance.
 - a. Tune-up scaling Factor = tune-up limit power (mW) / EUT RF power (mW), where tune-up limit is the maximum rated power among all production units.
 - b. For SAR testing of WLAN signal with non-100% duty cycle, the measured SAR is scaled-up by the duty cycle scaling factor which is equal to "1/(duty cycle)"
 - c. For WWAN: Reported SAR(W/kg)= Measured SAR(W/kg)*Tune-up Scaling Factor
 - d. For WLAN/Bluetooth: Reported SAR(W/kg)= Measured SAR(W/kg) * Duty Cycle scaling factor * Tune-up scaling factor
2. Per KDB 447498 D01v06, for each exposure position, testing of other required channels within the operating mode of a frequency band is not required when the *reported* 1-g or 10-g SAR for the mid-band or highest output power channel is:
 - ≤ 0.8 W/kg or 2.0 W/kg, for 1-g or 10-g respectively, when the transmission band is ≤ 100 MHz
 - ≤ 0.6 W/kg or 1.5 W/kg, for 1-g or 10-g respectively, when the transmission band is between 100 MHz and 200 MHz
 - ≤ 0.4 W/kg or 1.0 W/kg, for 1-g or 10-g respectively, when the transmission band is ≥ 200 MHz
3. Per KDB 865664 D01v01r04, for each frequency band, repeated SAR measurement is required only when the measured SAR is ≥ 0.8 W/kg.
4. Per KDB 648474 D04v01r03, when the reported SAR for a body-worn accessory measured without a headset connected to the handset is ≤ 1.2 W/kg, SAR testing with a headset connected to the handset is not required.
5. Per KDB648474 D04v01r03, for smart phones with a display diagonal dimension > 15.0 cm or an overall diagonal dimension > 16.0 cm, when hotspot mode applies, 10-g extremity SAR is required only for the surfaces and edges with hotspot mode 1-g reported SAR > 1.2 W/kg, however, when power reduction applies to hotspot mode the measured SAR must be scaled to the maximum output power, including tolerance, allowed for tablet modes to compare with the 1.2 W/kg SAR test reduction threshold.
6. Per KDB248227 D01v02r02,a Wi-Fi device must be configured to transmit continuously at the required data rate, channel bandwidth and signal modulation, using the highest transmission duty factor supported by the test mode tools for SAR measurement. The test frequencies



established using test mode must correspond to the actual channel frequencies required for operations in the U.S. When 802.11 frame gaps are accounted for in the transmission, a maximum transmission duty factor of 92 - 96% is typically achievable in most test mode configurations. A minimum transmission duty factor of 85% is required to avoid certain hardware and device implementation issues related to wide range SAR scaling. In addition, a periodic transmission duty factor is required for current generation SAR systems to measure SAR correctly. Unless it is permitted by specific KDB procedures or continuous transmission is specifically restricted by the device, the reported SAR must be scaled to 100% transmission duty factor to determine compliance at the maximum tune-up tolerance limit. When a device is not capable of sustaining continuous transmission or the output can become nonlinear, and it is limited by hardware design and unable to transmit at higher than 85% duty factor, a periodic duty factor within 15% of the maximum duty factor the device is capable of transmitting should be used. The reported SAR must be scaled to the maximum transmission duty factor to determine compliance. Descriptions of the procedures applied to establish the specific duty factor used for SAR testing are required in SAR reports to support the test results.

7. The full power is used to test the WWAN bottom antenna, the down power is used to test the WWAN top antenna.
8. For TDD-LTE Band 40, the entire band is unable to be used that as per 27.5; only 2 paired block (2305 to 2310MHz, 2350 to 2360MHz) are allowed with regards to "TDD" operation. the channel allocation, and bandwidth covert to test channels shall be re-adjusted; furthermore, as per 27.50, the duty cycle must be adjusted that TDD in this band must not exceed 38%. Before testing, the special combination must be set in the base station before the periodic measurement can be carried out.
9. The EUT respectively defined the top and bottom antenna max power in the software and the default PRX and Tx antenna is the bottom antenna. The top and bottom antenna will switch automatically according to the receiver signal strength and maximum transmission power level.



17.2. Head SAR Data

➤ GSM Head SAR

Plot No.	Band/Mode	Test Position	CH.	Ave. Power (dBm)	Tune-up Limit (dBm)	Tune-up Scaling Factor	Meas. SAR1g (W/kg)	Reported SAR1g (W/kg)
Top Ant.								
	GPRS850/3TX slots	Right Cheek	128	26.90	27.00	1.023	0.893	0.914
	GPRS850/3TX slots	Right Tilt	128	26.90	27.00	1.023	0.694	0.710
	GPRS850/3TX slots	Left Cheek	128	26.90	27.00	1.023	0.664	0.679
	GPRS850/3TX slots	Left Tilt	128	26.90	27.00	1.023	0.543	0.556
1#	GPRS850/3TX slots	Right Cheek	189	26.70	27.00	1.072	0.923	0.989
	GPRS850/3TX slots	Right Cheek	251	26.60	27.00	1.096	0.896	0.982
Bottom Ant.								
	GPRS850/3TX slots	Right Cheek	128	28.59	29.00	1.099	0.158	0.174
	GPRS850/3TX slots	Right Tilt	128	28.59	29.00	1.099	0.059	0.065
	GPRS850/3TX slots	Left Cheek	128	28.59	29.00	1.099	0.096	0.105
	GPRS850/3TX slots	Left Tilt	128	28.59	29.00	1.099	0.055	0.061
Top Ant.								
	GPRS1900/2TX slots	Right Cheek	661	22.65	23.00	1.084	0.736	0.798
	GPRS1900/2TX slots	Right Tilt	661	22.65	23.00	1.084	0.816	0.884
	GPRS1900/2TX slots	Left Cheek	661	22.65	23.00	1.084	0.692	0.750
	GPRS1900/2TX slots	Left Tilt	661	22.65	23.00	1.084	0.812	0.880
2#	GPRS1900/2TX slots	Right Tilt	512	22.61	23.00	1.094	0.889	0.973
	GPRS1900/2TX slots	Right Tilt	810	22.63	23.00	1.089	0.824	0.897
	GPRS1900/2TX slots	Left Tilt	512	22.61	23.00	1.094	0.882	0.965
	GPRS1900/2TX slots	Left Tilt	810	22.63	23.00	1.089	0.814	0.886
Bottom Ant.								
	GPRS1900/2TX slots	Right Cheek	661	25.15	25.50	1.084	0.034	0.037
	GPRS1900/2TX slots	Right Tilt	661	25.15	25.50	1.084	0.027	0.029
	GPRS1900/2TX slots	Left Cheek	661	25.15	25.50	1.084	0.040	0.043
	GPRS1900/2TX slots	Left Tilt	661	25.15	25.50	1.084	0.022	0.024



➤ WCDMA Head SAR

Plot No.	Band/Mode	Test Position	CH.	Ave. Power (dBm)	Tune-up Limit (dBm)	Tune-up Scaling Factor	Meas. SAR1g (W/kg)	Reported SAR1g (W/kg)
Top Ant.								
	Band II/RMC	Right Cheek	9400	16.04	16.50	1.112	0.790	0.878
	Band II/RMC	Right Tilt	9400	16.04	16.50	1.112	0.838	0.932
	Band II/RMC	Left Cheek	9400	16.04	16.50	1.112	0.747	0.830
	Band II/RMC	Left Tilt	9400	16.04	16.50	1.112	0.931	1.035
	Band II/RMC	Right Cheek	9262	16.02	16.50	1.117	0.781	0.872
	Band II/RMC	Right Cheek	9538	16.01	16.50	1.119	0.791	0.885
	Band II/RMC	Right Tilt	9262	16.02	16.50	1.117	0.806	0.900
	Band II/RMC	Right Tilt	9538	16.01	16.50	1.119	0.822	0.920
	Band II/RMC	Left Cheek	9262	16.02	16.50	1.117	0.880	0.983
	Band II/RMC	Left Cheek	9538	16.01	16.50	1.119	0.927	1.038
	Band II/RMC	Left Tilt	9262	16.02	16.50	1.117	0.879	0.982
3#	Band II/RMC	Left Tilt	9538	16.01	16.50	1.119	0.929	1.040
Bottom Ant.								
	Band II/RMC	Right Cheek	9400	19.86	20.00	1.033	0.036	0.037
	Band II/RMC	Right Tilt	9400	19.86	20.00	1.033	0.035	0.037
	Band II/RMC	Left Cheek	9400	19.86	20.00	1.033	0.049	0.050
	Band II/RMC	Left Tilt	9400	19.86	20.00	1.033	0.023	0.024
Top Ant.								
	Band IV/RMC	Right Cheek	1413	17.87	18.00	1.030	0.643	0.663
4#	Band IV/RMC	Right Tilt	1413	17.87	18.00	1.030	0.750	0.773
	Band IV/RMC	Left Cheek	1413	17.87	18.00	1.030	0.604	0.622
	Band IV/RMC	Left Tilt	1413	17.87	18.00	1.030	0.726	0.748
Bottom Ant.								
	Band IV/RMC	Right Cheek	1413	21.37	21.50	1.030	0.042	0.043
	Band IV/RMC	Right Tilt	1413	21.37	21.50	1.030	0.028	0.028
	Band IV/RMC	Left Cheek	1413	21.37	21.50	1.030	0.056	0.058
	Band IV/RMC	Left Tilt	1413	21.37	21.50	1.030	0.030	0.031
Top Ant.								
5#	Band V/RMC	Right Cheek	4183	21.88	22.00	1.028	0.649	0.667
	Band V/RMC	Right Tilt	4183	21.88	22.00	1.028	0.505	0.519
	Band V/RMC	Left Cheek	4183	21.88	22.00	1.028	0.471	0.484
	Band V/RMC	Left Tilt	4183	21.88	22.00	1.028	0.407	0.418



Plot No.	Band/Mode	Test Position	CH.	Ave. Power (dBm)	Tune-up Limit (dBm)	Tune-up Scaling Factor	Meas. SAR1g (W/kg)	Reported SAR1g (W/kg)
Bottom Ant.								
	Band V/RMC	Right Cheek	4183	22.88	23.00	1.028	0.101	0.104
	Band V/RMC	Right Tilt	4183	22.88	23.00	1.028	0.040	0.041
	Band V/RMC	Left Cheek	4183	22.88	23.00	1.028	0.061	0.063
	Band V/RMC	Left Tilt	4183	22.88	23.00	1.028	0.040	0.041

➤ **CDMA Head SAR**

Plot No.	Band/Mode	Test Position	CH.	Ave. Power (dBm)	Tune-up Limit (dBm)	Tune-up Scaling Factor	Meas. SAR1g (W/kg)	Reported SAR1g (W/kg)
Top Ant.								
6#	BC0/RC3 SO55	Right Cheek	384	23.84	24.00	1.038	0.830	0.861
	BC0/RC3 SO55	Right Tilt	384	23.84	24.00	1.038	0.622	0.645
	BC0/RC3 SO55	Left Cheek	384	23.84	24.00	1.038	0.645	0.669
	BC0/RC3 SO55	Left Tilt	384	23.84	24.00	1.038	0.542	0.562
	BC0/RC3 SO55	Right Cheek	1013	23.81	24.00	1.045	0.814	0.850
	BC0/RC3 SO55	Right Cheek	777	23.76	24.00	1.057	0.777	0.821
Bottom Ant.								
	BC0/RC3 SO55	Right Cheek	384	23.84	24.00	1.038	0.123	0.128
	BC0/RC3 SO55	Right Tilt	384	23.84	24.00	1.038	0.049	0.051
	BC0/RC3 SO55	Left Cheek	384	23.84	24.00	1.038	0.095	0.099
	BC0/RC3 SO55	Left Tilt	384	23.84	24.00	1.038	0.057	0.060
Top Ant.								
	BC1/RC3 SO55	Right Cheek	25	15.44	15.50	1.014	0.627	0.636
	BC1/RC3 SO55	Right Tilt	25	15.44	15.50	1.014	0.711	0.721
	BC1/RC3 SO55	Left Cheek	25	15.44	15.50	1.014	0.588	0.596
7#	BC1/RC3 SO55	Left Tilt	25	15.44	15.50	1.014	0.714	0.724
Bottom Ant.								
	BC1/RC3 SO55	Right Cheek	25	17.86	18.00	1.033	0.027	0.028
	BC1/RC3 SO55	Right Tilt	25	17.86	18.00	1.033	0.030	0.031
	BC1/RC3 SO55	Left Cheek	25	17.86	18.00	1.033	0.037	0.038
	BC1/RC3 SO55	Left Tilt	25	17.86	18.00	1.033	0.018	0.019



➤ FDD-LTE QPSK Head SAR

Plot No.	Band/Mode	Test Position	CH.	Ave. Power (dBm)	Tune-up Limit (dBm)	Tune-up Scaling Factor	Meas. SAR1g (W/kg)	Reported SAR1g (W/kg)
Top Ant.								
	LTE Band 2/1RB#99 20M	Right Cheek	19100	15.37	15.50	1.030	0.756	0.779
	LTE Band 2/1RB#99 20M	Right Tilt	19100	15.37	15.50	1.030	0.823	0.848
	LTE Band 2/1RB#99 20M	Left Cheek	19100	15.37	15.50	1.030	0.738	0.760
	LTE Band 2/1RB#99 20M	Left Tilt	19100	15.37	15.50	1.030	0.902	0.929
	LTE Band 2/1RB#99 20M	Right Tilt	18700	15.17	15.50	1.079	0.827	0.892
	LTE Band 2/1RB#99 20M	Right Tilt	18900	15.33	15.50	1.040	0.829	0.862
	LTE Band 2/1RB#99 20M	Left Tilt	18700	15.17	15.50	1.079	0.875	0.944
8#	LTE Band 2/1RB#99 20M	Left Tilt	18900	15.33	15.50	1.040	0.910	0.946
	LTE Band 2/100RB#0 20M	Left Tilt	18900	14.32	14.50	1.042	0.570	0.594
Bottom Ant.								
	LTE Band 2/50RB#50 20M	Right Cheek	19100	14.46	14.50	1.009	0.649	0.655
	LTE Band 2/50RB#50 20M	Right Tilt	19100	14.46	14.50	1.009	0.713	0.720
	LTE Band 2/50RB#50 20M	Left Cheek	19100	14.46	14.50	1.009	0.611	0.617
	LTE Band 2/50RB#50 20M	Left Tilt	19100	14.46	14.50	1.009	0.760	0.767
	LTE Band 2/1RB#99 20M	Right Cheek	19100	19.80	20.00	1.047	0.035	0.037
	LTE Band 2/1RB#99 20M	Right Tilt	19100	19.80	20.00	1.047	0.035	0.036
	LTE Band 2/1RB#99 20M	Left Cheek	19100	19.80	20.00	1.047	0.053	0.056
	LTE Band 2/1RB#99 20M	Left Tilt	19100	19.80	20.00	1.047	0.044	0.046
	LTE Band 2/50RB#50 20M	Right Cheek	19100	18.89	19.00	1.026	0.028	0.029
	LTE Band 2/50RB#50 20M	Right Tilt	19100	18.89	19.00	1.026	0.024	0.025
	LTE Band 2/50RB#50 20M	Left Cheek	19100	18.89	19.00	1.026	0.041	0.042
	LTE Band 2/50RB#50 20M	Left Tilt	19100	18.89	19.00	1.026	0.037	0.038



Plot No.	Band/Mode	Test Position	CH.	Ave. Power (dBm)	Tune-up Limit (dBm)	Tune-up Scaling Factor	Meas. SAR1g (W/kg)	Reported SAR1g (W/kg)
Top Ant.								
	LTE Band 4/1RB#0 20M	Right Cheek	20300	16.20	16.50	1.072	0.663	0.710
9#	LTE Band 4/1RB#0 20M	Right Tilt	20300	16.20	16.50	1.072	0.772	0.827
	LTE Band 4/1RB#0 20M	Left Cheek	20300	16.20	16.50	1.072	0.667	0.715
	LTE Band 4/1RB#0 20M	Left Tilt	20300	16.20	16.50	1.072	0.762	0.816
	LTE Band 4/1RB#0 20M	Right Tilt	20050	16.08	16.50	1.102	0.629	0.693
	LTE Band 4/1RB#0 20M	Right Tilt	20175	16.06	16.50	1.107	0.678	0.750
	LTE Band 4/1RB#0 20M	Left Tilt	20050	16.08	16.50	1.102	0.645	0.710
	LTE Band 4/1RB#0 20M	Left Tilt	20175	16.06	16.50	1.107	0.718	0.795
	LTE Band 4/ 100RB#0 20M	Right Tilt	20300	15.25	15.50	1.059	0.423	0.448
Bottom Ant.								
	LTE Band 4/50RB#50 20M	Right Cheek	20300	15.28	15.50	1.052	0.582	0.612
	LTE Band 4/50RB#50 20M	Right Tilt	20300	15.28	15.50	1.052	0.604	0.635
	LTE Band 4/50RB#50 20M	Left Cheek	20300	15.28	15.50	1.052	0.568	0.598
	LTE Band 4/50RB#50 20M	Left Tilt	20300	15.28	15.50	1.052	0.644	0.677
Top Ant.								
	LTE Band 4/1RB#0 20M	Right Cheek	20300	20.78	21.00	1.052	0.051	0.054
	LTE Band 4/1RB#0 20M	Right Tilt	20300	20.78	21.00	1.052	0.038	0.040
	LTE Band 4/1RB#0 20M	Left Cheek	20300	20.78	21.00	1.052	0.061	0.064
	LTE Band 4/1RB#0 20M	Left Tilt	20300	20.78	21.00	1.052	0.030	0.031
Bottom Ant.								
	LTE Band 4/50RB#50 20M	Right Cheek	20300	19.86	20.00	1.033	0.040	0.041
	LTE Band 4/50RB#50 20M	Right Tilt	20300	19.86	20.00	1.033	0.029	0.030
	LTE Band 4/50RB#50 20M	Left Cheek	20300	19.86	20.00	1.033	0.047	0.049
	LTE Band 4/50RB#50 20M	Left Tilt	20300	19.86	20.00	1.033	0.023	0.024
Top Ant.								
10#	LTE Band 5/1RB#0 10M	Right Cheek	20525	22.23	22.50	1.064	0.706	0.751
	LTE Band 5/1RB#0 10M	Right Tilt	20525	22.23	22.50	1.064	0.544	0.579
	LTE Band 5/1RB#0 10M	Left Cheek	20525	22.23	22.50	1.064	0.503	0.535
	LTE Band 5/1RB#0 10M	Left Tilt	20525	22.23	22.50	1.064	0.422	0.449
Bottom Ant.								
	LTE Band 5/25RB#0 10M	Right Cheek	20525	21.33	21.50	1.040	0.580	0.603
	LTE Band 5/25RB#0 10M	Right Tilt	20525	21.33	21.50	1.040	0.435	0.452
	LTE Band 5/25RB#0 10M	Left Cheek	20525	21.33	21.50	1.040	0.382	0.397
	LTE Band 5/25RB#010M	Left Tilt	20525	21.33	21.50	1.040	0.349	0.363



Plot No.	Band/Mode	Test Position	CH.	Ave. Power (dBm)	Tune-up Limit (dBm)	Tune-up Scaling Factor	Meas. SAR1g (W/kg)	Reported SAR1g (W/kg)
Bottom Ant.								
	LTE Band 5/1RB#0 10M	Right Cheek	20525	22.76	23.00	1.057	0.095	0.100
	LTE Band 5/1RB#0 10M	Right Tilt	20525	22.76	23.00	1.057	0.040	0.042
	LTE Band 5/1RB#0 10M	Left Cheek	20525	22.76	23.00	1.057	0.064	0.068
	LTE Band 5/1RB#0 10M	Left Tilt	20525	22.76	23.00	1.057	0.043	0.045
Top Ant.								
	LTE Band 5/25RB#0 10M	Right Cheek	20525	21.86	22.00	1.033	0.080	0.083
	LTE Band 5/25RB#0 10M	Right Tilt	20525	21.86	22.00	1.033	0.033	0.034
	LTE Band 5/25RB#0 10M	Left Cheek	20525	21.86	22.00	1.033	0.052	0.054
	LTE Band 5/25RB#0 10M	Left Tilt	20525	21.86	22.00	1.033	0.034	0.035
Top Ant.								
	LTE Band 7/1RB#49 20M	Right Cheek	21100	19.42	19.50	1.019	1.000	1.019
	LTE Band 7/1RB#49 20M	Right Tilt	21100	19.42	19.50	1.019	0.932	0.949
	LTE Band 7/1RB#49 20M	Left Cheek	21100	19.42	19.50	1.019	0.643	0.655
	LTE Band 7/1RB#49 20M	Left Tilt	21100	19.42	19.50	1.019	0.710	0.723
11#	LTE Band 7/1RB#49 20M	Right Cheek	20850	19.14	19.50	1.086	1.070	1.162
	LTE Band 7/1RB#49 20M	Right Cheek	21350	19.31	19.50	1.045	0.972	1.015
	LTE Band 7/1RB#49 20M	Right Tilt	20850	19.14	19.50	1.086	1.010	1.097
	LTE Band 7/1RB#49 20M	Right Tilt	21350	19.31	19.50	1.045	0.885	0.925
	LTE Band 7/100RB#0 20M	Right Cheek	20850	18.65	19.00	1.084	0.730	0.791
Top Ant.								
	LTE Band 7/50RB#0 20M	Right Cheek	21100	18.73	19.00	1.064	0.911	0.969
	LTE Band 7/50RB#0 20M	Right Tilt	21100	18.73	19.00	1.064	0.873	0.929
	LTE Band 7/50RB#0 20M	Left Cheek	21100	18.73	19.00	1.064	0.522	0.555
	LTE Band 7/50RB#0 20M	Left Tilt	21100	18.73	19.00	1.064	0.694	0.739
	LTE Band 7/50RB#0 20M	Right Cheek	20850	18.72	19.00	1.067	1.040	1.109
	LTE Band 7/50RB#0 20M	Right Cheek	21350	18.71	19.00	1.069	0.871	0.931
	LTE Band 7/50RB#0 20M	Right Tilt	20850	18.72	19.00	1.067	1.070	1.141
	LTE Band 7/50RB#0 20M	Right Tilt	21350	18.71	19.00	1.069	0.814	0.870



Plot No.	Band/Mode	Test Position	CH.	Ave. Power (dBm)	Tune-up Limit (dBm)	Tune-up Scaling Factor	Meas. SAR1g (W/kg)	Reported SAR1g (W/kg)
Bottom Ant.								
	LTE Band 7/1RB#49 20M	Right Cheek	21100	22.87	23.00	1.030	0.059	0.061
	LTE Band 7/1RB#49 20M	Right Tilt	21100	22.87	23.00	1.030	0.050	0.052
	LTE Band 7/1RB#49 20M	Left Cheek	21100	22.87	23.00	1.030	0.055	0.056
	LTE Band 7/1RB#49 20M	Left Tilt	21100	22.87	23.00	1.030	0.040	0.041
Bottom Ant.								
	LTE Band 7/50RB#0 20M	Right Cheek	21100	21.94	22.00	1.014	0.055	0.056
	LTE Band 7/50RB#0 20M	Right Tilt	21100	21.94	22.00	1.014	0.044	0.045
	LTE Band 7/50RB#0 20M	Left Cheek	21100	21.94	22.00	1.014	0.047	0.048
	LTE Band 7/50RB#0 20M	Left Tilt	21100	21.94	22.00	1.014	0.043	0.044
Top Ant.								
12#	LTE Band 12/1RB#49 10M	Right Cheek	23130	22.07	22.50	1.104	0.082	0.091
	LTE Band 12/1RB#49 10M	Right Tilt	23130	22.07	22.50	1.104	0.062	0.068
	LTE Band 12/1RB#49 10M	Left Cheek	23130	22.07	22.50	1.104	0.065	0.071
	LTE Band 12/1RB#49 10M	Left Tilt	23130	22.07	22.50	1.104	0.049	0.054
Bottom Ant.								
	LTE Band 12/25RB#12 10M	Right Cheek	23130	21.04	21.50	1.112	0.067	0.075
	LTE Band 12/25RB#12 10M	Right Tilt	23130	21.04	21.50	1.112	0.047	0.052
	LTE Band 12/25RB#12 10M	Left Cheek	23130	21.04	21.50	1.112	0.047	0.053
	LTE Band 12/25RB#12 10M	Left Tilt	23130	21.04	21.50	1.112	0.032	0.036
Bottom Ant.								
	LTE Band 12/1RB#49 10M	Right Cheek	23130	22.63	23.00	1.089	0.067	0.073
	LTE Band 12/1RB#49 10M	Right Tilt	23130	22.63	23.00	1.089	0.030	0.032
	LTE Band 12/1RB#49 10M	Left Cheek	23130	22.63	23.00	1.089	0.052	0.057
	LTE Band 12/1RB#49 10M	Left Tilt	23130	22.63	23.00	1.089	0.028	0.031
Bottom Ant.								
	LTE Band 12/25RB#12 10M	Right Cheek	23130	21.60	22.00	1.096	0.058	0.063
	LTE Band 12/25RB#12 10M	Right Tilt	23130	21.60	22.00	1.096	0.025	0.027
	LTE Band 12/25RB#12 10M	Left Cheek	23130	21.60	22.00	1.096	0.043	0.047
	LTE Band 12/25RB#12 10M	Left Tilt	23130	21.60	22.00	1.096	0.024	0.026



Plot No.	Band/Mode	Test Position	CH.	Ave. Power (dBm)	Tune-up Limit (dBm)	Tune-up Scaling Factor	Meas. SAR1g (W/kg)	Reported SAR1g (W/kg)
Top Ant.								
13#	LTE Band 17/1RB#25 10M	Right Cheek	23780	21.92	22.00	1.019	0.084	0.085
	LTE Band 17/1RB#25 10M	Right Tilt	23780	21.92	22.00	1.019	0.057	0.058
	LTE Band 17/1RB#25 10M	Left Cheek	23780	21.92	22.00	1.019	0.055	0.056
	LTE Band 17/1RB#25 10M	Left Tilt	23780	21.92	22.00	1.019	0.048	0.049
	LTE Band 17/25RB#12 10M	Right Cheek	23780	20.95	21.00	1.012	0.060	0.060
	LTE Band 17/25RB#12 10M	Right Tilt	23780	20.95	21.00	1.012	0.047	0.047
	LTE Band 17/25RB#12 10M	Left Cheek	23780	20.95	21.00	1.012	0.044	0.045
	LTE Band 17/25RB#12 10M	Left Tilt	23780	20.95	21.00	1.012	0.042	0.042
Bottom Ant.								
	LTE Band 17/1RB#25 10M	Right Cheek	23780	22.43	23.00	1.140	0.068	0.078
	LTE Band 17/1RB#25 10M	Right Tilt	23780	22.43	23.00	1.140	0.027	0.031
	LTE Band 17/1RB#25 10M	Left Cheek	23780	22.43	23.00	1.140	0.055	0.063
	LTE Band 17/1RB#25 10M	Left Tilt	23780	22.43	23.00	1.140	0.029	0.033
	LTE Band 17/25RB#12 10M	Right Cheek	23780	21.46	22.00	1.132	0.056	0.064
	LTE Band 17/25RB#12 10M	Right Tilt	23780	21.46	22.00	1.132	0.030	0.034
	LTE Band 17/25RB#12 10M	Left Cheek	23780	21.46	22.00	1.132	0.043	0.048
	LTE Band 17/25RB#12 10M	Left Tilt	23780	21.46	22.00	1.132	0.029	0.033
Top Ant.								
14#	LTE Band 18/1RB#0 15M	Right Cheek	23925	21.02	21.50	1.117	0.689	0.770
	LTE Band 18/1RB#0 15M	Right Tilt	23925	21.02	21.50	1.117	0.565	0.631
	LTE Band 18/1RB#0 15M	Left Cheek	23925	21.02	21.50	1.117	0.445	0.497
	LTE Band 18/1RB#0 15M	Left Tilt	23925	21.02	21.50	1.117	0.502	0.561
	LTE Band 18/36RB#20 15M	Right Cheek	23925	19.92	20.00	1.019	0.601	0.612
	LTE Band 18/36RB#20 15M	Right Tilt	23925	19.92	20.00	1.019	0.460	0.469
	LTE Band 18/36RB#20 15M	Left Cheek	23925	19.92	20.00	1.019	0.348	0.354
	LTE Band 18/36RB#20 15M	Left Tilt	23925	19.92	20.00	1.019	0.416	0.424



Plot No.	Band/Mode	Test Position	CH.	Ave. Power (dBm)	Tune-up Limit (dBm)	Tune-up Scaling Factor	Meas. SAR1g (W/kg)	Reported SAR1g (W/kg)
Bottom Ant.								
	LTE Band 18/1RB#0 15M	Right Cheek	23925	22.67	23.00	1.079	0.096	0.103
	LTE Band 18/1RB#0 15M	Right Tilt	23925	22.67	23.00	1.079	0.044	0.048
	LTE Band 18/1RB#0 15M	Left Cheek	23925	22.67	23.00	1.079	0.063	0.068
	LTE Band 18/1RB#0 15M	Left Tilt	23925	22.67	23.00	1.079	0.051	0.055
Bottom Ant.								
	LTE Band 18/36RB#20 15M	Right Cheek	23925	21.57	22.00	1.104	0.083	0.092
	LTE Band 18/36RB#20 15M	Right Tilt	23925	21.57	22.00	1.104	0.038	0.042
	LTE Band 18/36RB#20 15M	Left Cheek	23925	21.57	22.00	1.104	0.055	0.061
	LTE Band 18/36RB#20 15M	Left Tilt	23925	21.57	22.00	1.104	0.044	0.048
Top Ant.								
15#	LTE Band 19/1RB#0 15M	Right Cheek	24075	21.00	21.50	1.122	0.823	0.923
	LTE Band 19/1RB#0 15M	Right Tilt	24075	21.00	21.50	1.122	0.620	0.696
	LTE Band 19/1RB#0 15M	Left Cheek	24075	21.00	21.50	1.122	0.623	0.699
	LTE Band 19/1RB#0 15M	Left Tilt	24075	21.00	21.50	1.122	0.525	0.589
Bottom Ant.								
	LTE Band 19/36RB#0 15M	Right Cheek	24075	19.99	20.00	1.002	0.679	0.681
	LTE Band 19/36RB#0 15M	Right Tilt	24075	19.99	20.00	1.002	0.509	0.510
	LTE Band 19/36RB#0 15M	Left Cheek	24075	19.99	20.00	1.002	0.499	0.500
	LTE Band 19/36RB#0 15M	Left Tilt	24075	19.99	20.00	1.002	0.425	0.426
Bottom Ant.								
	LTE Band 19/1RB#0 15M	Right Cheek	24075	22.65	23.00	1.084	0.117	0.127
	LTE Band 19/1RB#0 15M	Right Tilt	24075	22.65	23.00	1.084	0.052	0.056
	LTE Band 19/1RB#0 15M	Left Cheek	24075	22.65	23.00	1.084	0.075	0.082
	LTE Band 19/1RB#0 15M	Left Tilt	24075	22.65	23.00	1.084	0.059	0.063
Bottom Ant.								
	LTE Band 19/36RB#0 15M	Right Cheek	24075	21.64	22.00	1.086	0.099	0.108
	LTE Band 19/36RB#0 15M	Right Tilt	24075	21.64	22.00	1.086	0.044	0.047
	LTE Band 19/36RB#0 15M	Left Cheek	24075	21.64	22.00	1.086	0.065	0.070
	LTE Band 19/36RB#0 15M	Left Tilt	24075	21.64	22.00	1.086	0.046	0.050



Plot No.	Band/Mode	Test Position	CH.	Ave. Power (dBm)	Tune-up Limit (dBm)	Tune-up Scaling Factor	Meas. SAR1g (W/kg)	Reported SAR1g (W/kg)
Top Ant.								
	LTE Band 25/1RB#0 20M	Right Cheek	26365	15.28	15.50	1.052	0.822	0.865
	LTE Band 25/1RB#0 20M	Right Tilt	26365	15.28	15.50	1.052	0.818	0.861
	LTE Band 25/1RB#0 20M	Left Cheek	26365	15.28	15.50	1.052	0.801	0.843
16#	LTE Band 25/1RB#0 20M	Left Tilt	26365	15.28	15.50	1.052	0.986	1.037
	LTE Band 25/1RB#0 20M	Right Cheek	26140	14.98	15.50	1.127	0.750	0.845
	LTE Band 25/1RB#0 20M	Right Cheek	26590	14.94	15.50	1.138	0.754	0.858
	LTE Band 25/1RB#0 20M	Right Tilt	26140	14.98	15.50	1.127	0.840	0.947
	LTE Band 25/1RB#0 20M	Right Tilt	26590	14.94	15.50	1.138	0.827	0.941
	LTE Band 25/1RB#0 20M	Left Cheek	26140	14.98	15.50	1.127	0.715	0.806
	LTE Band 25/1RB#0 20M	Left Cheek	26590	14.94	15.50	1.138	0.743	0.845
	LTE Band 25/1RB#0 20M	Left Tilt	26140	14.98	15.50	1.127	0.879	0.991
	LTE Band 25/1RB#0 20M	Left Tilt	26590	14.94	15.50	1.138	0.902	1.026
	LTE Band 25/ 100RB#0 20M	Left Tilt	26365	14.32	14.50	1.042	0.575	0.599
Bottom Ant.								
	LTE Band 25/50RB#24 20M	Right Cheek	26365	14.38	14.50	1.028	0.640	0.658
	LTE Band 25/50RB#24 20M	Right Tilt	26365	14.38	14.50	1.028	0.788	0.810
	LTE Band 25/50RB#24 20M	Left Cheek	26365	14.38	14.50	1.028	0.565	0.581
	LTE Band 25/50RB#24 20M	Left Tilt	26365	14.38	14.50	1.028	0.812	0.835
	LTE Band 25/50RB#24 20M	Right Tilt	26140	14.25	14.50	1.059	0.760	0.805
	LTE Band 25/50RB#24 20M	Right Tilt	26590	14.35	14.50	1.035	0.709	0.734
	LTE Band 25/50RB#24 20M	Left Tilt	26140	14.25	14.50	1.059	0.771	0.817
	LTE Band 25/50RB#24 20M	Left Tilt	26590	14.35	14.50	1.035	0.735	0.761
Bottom Ant.								
	LTE Band 25/1RB#0 20M	Right Cheek	26365	20.23	20.50	1.064	0.050	0.053
	LTE Band 25/1RB#0 20M	Right Tilt	26365	20.23	20.50	1.064	0.038	0.040
	LTE Band 25/1RB#0 20M	Left Cheek	26365	20.23	20.50	1.064	0.051	0.054
	LTE Band 25/1RB#0 20M	Left Tilt	26365	20.23	20.50	1.064	0.048	0.051
Bottom Ant.								
	LTE Band 25/50RB#24 20M	Right Cheek	26365	19.33	19.50	1.040	0.038	0.040
	LTE Band 25/50RB#24 20M	Right Tilt	26365	19.33	19.50	1.040	0.028	0.029
	LTE Band 25/50RB#24 20M	Left Cheek	26365	19.33	19.50	1.040	0.040	0.041
	LTE Band 25/50RB#24 20M	Left Tilt	26365	19.33	19.50	1.040	0.037	0.039



Plot No.	Band/Mode	Test Position	CH.	Ave. Power (dBm)	Tune-up Limit (dBm)	Tune-up Scaling Factor	Meas. SAR1g (W/kg)	Reported SAR1g (W/kg)
Top Ant.								
17#	LTE Band 26/1RB#0 15M	Right Cheek	26965	21.36	21.50	1.033	0.730	0.754
	LTE Band 26/1RB#0 15M	Right Tilt	26965	21.36	21.50	1.033	0.547	0.565
	LTE Band 26/1RB#0 15M	Left Cheek	26965	21.36	21.50	1.033	0.544	0.562
	LTE Band 26/1RB#0 15M	Left Tilt	26965	21.36	21.50	1.033	0.446	0.461
Bottom Ant.								
	LTE Band 26/36RB#0 15M	Right Cheek	26965	20.33	20.50	1.040	0.608	0.632
	LTE Band 26/36RB#0 15M	Right Tilt	26965	20.33	20.50	1.040	0.446	0.464
	LTE Band 26/36RB#0 15M	Left Cheek	26965	20.33	20.50	1.040	0.442	0.460
	LTE Band 26/36RB#0 15M	Left Tilt	26965	20.33	20.50	1.040	0.365	0.380
Bottom Ant.								
	LTE Band 26/1RB#0 15M	Right Cheek	26965	22.82	23.00	1.042	0.105	0.109
	LTE Band 26/1RB#0 15M	Right Tilt	26965	22.82	23.00	1.042	0.041	0.043
	LTE Band 26/1RB#0 15M	Left Cheek	26965	22.82	23.00	1.042	0.070	0.073
	LTE Band 26/1RB#0 15M	Left Tilt	26965	22.82	23.00	1.042	0.047	0.049
Bottom Ant.								
	LTE Band 26/36RB#0 15M	Right Cheek	26965	21.79	22.00	1.050	0.087	0.091
	LTE Band 26/36RB#0 15M	Right Tilt	26965	21.79	22.00	1.050	0.034	0.036
	LTE Band 26/36RB#0 15M	Left Cheek	26965	21.79	22.00	1.050	0.058	0.061
	LTE Band 26/36RB#0 15M	Left Tilt	26965	21.79	22.00	1.050	0.040	0.042
Top Ant.								
18#	LTE Band 30/1RB#0 10M	Right Cheek	27710	17.40	17.50	1.023	0.885	0.906
	LTE Band 30/1RB#0 10M	Right Tilt	27710	17.40	17.50	1.023	0.851	0.871
	LTE Band 30/1RB#0 10M	Left Cheek	27710	17.40	17.50	1.023	0.686	0.702
	LTE Band 30/1RB#0 10M	Left Tilt	27710	17.40	17.50	1.023	0.847	0.867
Bottom Ant.								
	LTE Band 30/25RB#12 10M	Right Cheek	27710	16.40	16.50	1.023	0.718	0.735
	LTE Band 30/25RB#12 10M	Right Tilt	27710	16.40	16.50	1.023	0.702	0.718
	LTE Band 30/25RB#12 10M	Left Cheek	27710	16.40	16.50	1.023	0.559	0.572
	LTE Band 30/25RB#12 10M	Left Tilt	27710	16.40	16.50	1.023	0.687	0.703



Plot No.	Band/Mode	Test Position	CH.	Ave. Power (dBm)	Tune-up Limit (dBm)	Tune-up Scaling Factor	Meas. SAR1g (W/kg)	Reported SAR1g (W/kg)
Bottom Ant.								
	LTE Band 30/1RB#0 10M	Right Cheek	27710	21.57	22.00	1.104	0.064	0.070
	LTE Band 30/1RB#0 10M	Right Tilt	27710	21.57	22.00	1.104	0.050	0.055
	LTE Band 30/1RB#0 10M	Left Cheek	27710	21.57	22.00	1.104	0.042	0.046
	LTE Band 30/1RB#0 10M	Left Tilt	27710	21.57	22.00	1.104	0.031	0.034
Bottom Ant.								
	LTE Band 30/25RB#12 10M	Right Cheek	27710	20.57	21.00	1.104	0.042	0.046
	LTE Band 30/25RB#12 10M	Right Tilt	27710	20.57	21.00	1.104	0.036	0.040
	LTE Band 30/25RB#12 10M	Left Cheek	27710	20.57	21.00	1.104	0.035	0.038
	LTE Band 30/25RB#12 10M	Left Tilt	27710	20.57	21.00	1.104	0.028	0.031
Top Ant.								
	LTE Band 66/1RB#0 20M	Right Cheek	132572	17.86	18.00	1.033	0.728	0.752
19#	LTE Band 66/1RB#0 20M	Right Tilt	132572	17.86	18.00	1.033	0.862	0.890
	LTE Band 66/1RB#0 20M	Left Cheek	132572	17.86	18.00	1.033	0.656	0.677
	LTE Band 66/1RB#0 20M	Left Tilt	132572	17.86	18.00	1.033	0.803	0.829
	LTE Band 66/1RB#0 20M	Right Tilt	132072	17.51	18.00	1.119	0.552	0.618
	LTE Band 66/1RB#0 20M	Right Tilt	132322	17.45	18.00	1.135	0.667	0.757
	LTE Band 66/1RB#0 20M	Left Tilt	132072	17.51	18.00	1.119	0.586	0.656
	LTE Band 66/1RB#0 20M	Left Tilt	132322	17.45	18.00	1.135	0.675	0.766
	LTE Band 66/100RB#0 20M	Right Tilt	132572	16.74	17.00	1.062	0.468	0.497
Bottom Ant.								
	LTE Band 66/50RB#0 20M	Right Cheek	132572	16.83	17.00	1.040	0.559	0.581
	LTE Band 66/50RB#0 20M	Right Tilt	132572	16.83	17.00	1.040	0.640	0.666
	LTE Band 66/50RB#0 20M	Left Cheek	132572	16.83	17.00	1.040	0.615	0.640
	LTE Band 66/50RB#0 20M	Left Tilt	132572	16.83	17.00	1.040	0.712	0.740
Bottom Ant.								
	LTE Band 66/1RB#0 20M	Right Cheek	132572	22.72	23.00	1.067	0.052	0.055
	LTE Band 66/1RB#0 20M	Right Tilt	132572	22.72	23.00	1.067	0.046	0.049
	LTE Band 66/1RB#0 20M	Left Cheek	132572	22.72	23.00	1.067	0.063	0.067
	LTE Band 66/1RB#0 20M	Left Tilt	132572	22.72	23.00	1.067	0.047	0.050
Bottom Ant.								
	LTE Band 66/50RB#0 20M	Right Cheek	132572	21.69	22.00	1.074	0.044	0.047
	LTE Band 66/50RB#0 20M	Right Tilt	132572	21.69	22.00	1.074	0.036	0.039
	LTE Band 66/50RB#0 20M	Left Cheek	132572	21.69	22.00	1.074	0.050	0.054
	LTE Band 66/50RB#0 20M	Left Tilt	132572	21.69	22.00	1.074	0.039	0.042



➤ TDD-LTE QPSK Head SAR

Plot No.	Band/Mode	Test Position	CH.	Ave. Power (dBm)	Tune-up Limit (dBm)	Tune-up Scaling Factor	Meas. SAR1g (W/kg)	Reported SAR1g (W/kg)
Top Ant.								
20#	LTE Band 38/1RB#0 20M	Right Cheek	38150	19.37	19.50	1.030	0.430	0.446
	LTE Band 38/1RB#0 20M	Right Tilt	38150	19.37	19.50	1.030	0.404	0.419
	LTE Band 38/1RB#0 20M	Left Cheek	38150	19.37	19.50	1.030	0.251	0.260
	LTE Band 38/1RB#0 20M	Left Tilt	38150	19.37	19.50	1.030	0.268	0.278
Bottom Ant.								
	LTE Band 38/50RB#0 20M	Right Cheek	38150	18.56	19.00	1.107	0.290	0.323
	LTE Band 38/50RB#0 20M	Right Tilt	38150	18.56	19.00	1.107	0.241	0.268
	LTE Band 38/50RB#0 20M	Left Cheek	38150	18.56	19.00	1.107	0.157	0.175
	LTE Band 38/50RB#0 20M	Left Tilt	38150	18.56	19.00	1.107	0.190	0.212
Bottom Ant.								
	LTE Band 38/1RB#0 20M	Right Cheek	38150	22.94	23.50	1.138	0.019	0.022
	LTE Band 38/1RB#0 20M	Right Tilt	38150	22.94	23.50	1.138	0.014	0.015
	LTE Band 38/1RB#0 20M	Left Cheek	38150	22.94	23.50	1.138	0.022	0.025
	LTE Band 38/1RB#0 20M	Left Tilt	38150	22.94	23.50	1.138	0.020	0.023
Bottom Ant.								
	LTE Band 38/50RB#0 20M	Right Cheek	38150	22.10	22.50	1.096	0.017	0.018
	LTE Band 38/50RB#0 20M	Right Tilt	38150	22.10	22.50	1.096	0.010	0.011
	LTE Band 38/50RB#0 20M	Left Cheek	38150	22.10	22.50	1.096	0.020	0.022
	LTE Band 38/50RB#0 20M	Left Tilt	38150	22.10	22.50	1.096	0.016	0.018
Top Ant.								
	LTE Band 40A/1RB#0 10M	Right Cheek	38750	19.66	20.00	1.081	0.665	0.723
21#	LTE Band 40A/1RB#0 10M	Right Tilt	38750	19.66	20.00	1.081	0.787	0.856
	LTE Band 40A/1RB#0 10M	Left Cheek	38750	19.66	20.00	1.081	0.546	0.594
	LTE Band 40A/1RB#0 10M	Left Tilt	38750	19.66	20.00	1.081	0.623	0.678
Bottom Ant.								
	LTE Band 40A/25RB#0 10M	Right Cheek	38750	18.78	19.00	1.052	0.437	0.462
	LTE Band 40A/25RB#0 10M	Right Tilt	38750	18.78	19.00	1.052	0.406	0.430
	LTE Band 40A/25RB#0 10M	Left Cheek	38750	18.78	19.00	1.052	0.327	0.346
	LTE Band 40A/25RB#0 10M	Left Tilt	38750	18.78	19.00	1.052	0.348	0.368



Plot No.	Band/Mode	Test Position	CH.	Ave. Power (dBm)	Tune-up Limit (dBm)	Tune-up Scaling Factor	Meas. SAR1g (W/kg)	Reported SAR1g (W/kg)
Bottom Ant.								
	LTE Band 40A/1RB#0 10M	Right Cheek	38750	22.66	23.00	1.081	0.023	0.025
	LTE Band 40A/1RB#0 10M	Right Tilt	38750	22.66	23.00	1.081	0.032	0.034
	LTE Band 40A/1RB#0 10M	Left Cheek	38750	22.66	23.00	1.081	0.024	0.026
	LTE Band 40A/1RB#0 10M	Left Tilt	38750	22.66	23.00	1.081	0.015	0.017
Bottom Ant.								
	LTE Band 40A/25RB#0 10M	Right Cheek	38750	21.78	22.00	1.052	0.018	0.019
	LTE Band 40A/25RB#0 10M	Right Tilt	38750	21.78	22.00	1.052	0.026	0.028
	LTE Band 40A/25RB#0 10M	Left Cheek	38750	21.78	22.00	1.052	0.021	0.022
	LTE Band 40A/25RB#0 10M	Left Tilt	38750	21.78	22.00	1.052	0.013	0.014
Top Ant.								
	LTE Band 40B/1RB#25 10M	Right Cheek	39200	19.77	20.00	1.054	0.593	0.629
22#	LTE Band 40B/1RB#25 10M	Right Tilt	39200	19.77	20.00	1.054	0.748	0.793
	LTE Band 40B/1RB#25 10M	Left Cheek	39200	19.77	20.00	1.054	0.419	0.444
	LTE Band 40B/1RB#25 10M	Left Tilt	39200	19.77	20.00	1.054	0.563	0.597
Top Ant.								
	LTE Band 40B/25RB#0 10M	Right Cheek	39200	18.79	19.00	1.050	0.419	0.442
	LTE Band 40B/25RB#0 10M	Right Tilt	39200	18.79	19.00	1.050	0.393	0.415
	LTE Band 40B/25RB#0 10M	Left Cheek	39200	18.79	19.00	1.050	0.289	0.305
	LTE Band 40B/25RB#0 10M	Left Tilt	39200	18.79	19.00	1.050	0.393	0.415
Bottom Ant.								
	LTE Band 40B/1RB#25 10M	Right Cheek	39200	22.77	23.00	1.054	0.023	0.025
	LTE Band 40B/1RB#25 10M	Right Tilt	39200	22.77	23.00	1.054	0.026	0.028
	LTE Band 40B/1RB#25 10M	Left Cheek	39200	22.77	23.00	1.054	0.027	0.028
	LTE Band 40B/1RB#25 10M	Left Tilt	39200	22.77	23.00	1.054	0.014	0.014
Bottom Ant.								
	LTE Band 40B/25RB#0 10M	Right Cheek	39200	21.79	22.00	1.050	0.020	0.021
	LTE Band 40B/25RB#0 10M	Right Tilt	39200	21.79	22.00	1.050	0.022	0.023
	LTE Band 40B/25RB#0 10M	Left Cheek	39200	21.79	22.00	1.050	0.021	0.023
	LTE Band 40B/25RB#0 10M	Left Tilt	39200	21.79	22.00	1.050	0.013	0.014



Plot No.	Band/Mode	Test Position	CH.	Ave. Power (dBm)	Tune-up Limit (dBm)	Tune-up Scaling Factor	Meas. SAR1g (W/kg)	Reported SAR1g (W/kg)
Top Ant.								
	LTE Band 41/1RB#99 20M	Right Cheek	40340	19.30	19.50	1.047	0.366	0.386
23#	LTE Band 41/1RB#99 20M	Right Tilt	40340	19.30	19.50	1.047	0.385	0.406
	LTE Band 41/1RB#99 20M	Left Cheek	40340	19.30	19.50	1.047	0.231	0.243
	LTE Band 41/1RB#99 20M	Left Tilt	40340	19.30	19.50	1.047	0.254	0.268
Bottom Ant.								
	LTE Band 41/50RB#0 20M	Right Cheek	40340	18.37	18.50	1.030	0.267	0.277
	LTE Band 41/50RB#0 20M	Right Tilt	40340	18.37	18.50	1.030	0.236	0.245
	LTE Band 41/50RB#0 20M	Left Cheek	40340	18.37	18.50	1.030	0.179	0.186
	LTE Band 41/50RB#0 20M	Left Tilt	40340	18.37	18.50	1.030	0.209	0.217
Bottom Ant.								
	LTE Band 41/1RB#99 20M	Right Cheek	40340	22.94	23.50	1.138	0.021	0.024
	LTE Band 41/1RB#99 20M	Right Tilt	40340	22.94	23.50	1.138	0.028	0.032
	LTE Band 41/1RB#99 20M	Left Cheek	40340	22.94	23.50	1.138	0.019	0.022
	LTE Band 41/1RB#99 20M	Left Tilt	40340	22.94	23.50	1.138	0.020	0.023
Bottom Ant.								
	LTE Band 41/50RB#0 20M	Right Cheek	40340	22.15	22.50	1.084	0.015	0.016
	LTE Band 41/50RB#0 20M	Right Tilt	40340	22.15	22.50	1.084	0.015	0.017
	LTE Band 41/50RB#0 20M	Left Cheek	40340	22.15	22.50	1.084	0.018	0.019
	LTE Band 41/50RB#0 20M	Left Tilt	40340	22.15	22.50	1.084	0.013	0.014

Note: The LTE TDD Reported 1g SAR (W/kg) has been calculated together with the duty cycle scaling factor.



➤ WLAN Head SAR

Plot No.	Band/Mode	Test Position	CH.	Ave. Power (dBm)	Tune-up Limit (dBm)	Tune-up Scaling Factor	Meas. SAR1g (W/kg)	Reported SAR1g (W/kg)
Ant.0								
	WLAN2.4GHz/802.11b	Right Cheek	1	14.67	15.00	1.079	0.230	0.251
	WLAN2.4GHz/802.11b	Right Tilt	1	14.67	15.00	1.079	0.258	0.281
	WLAN2.4GHz/802.11b	Left Cheek	1	14.67	15.00	1.079	0.376	0.410
24#	WLAN2.4GHz/802.11b	Left Tilt	1	14.67	15.00	1.079	0.449	0.489
Ant.1								
	WLAN2.4GHz/802.11b	Right Cheek	11	13.61	14.00	1.094	0.051	0.056
	WLAN2.4GHz/802.11b	Right Tilt	11	13.61	14.00	1.094	0.044	0.049
	WLAN2.4GHz/802.11b	Left Cheek	11	13.61	14.00	1.094	0.029	0.032
	WLAN2.4GHz/802.11b	Left Tilt	11	13.61	14.00	1.094	0.027	0.030
Ant.0								
	WLAN5.2GHz/802.11n-40	Right Cheek	38	9.51	10.00	1.119	0.156	0.178
	WLAN5.2GHz/802.11n-40	Right Tilt	38	9.51	10.00	1.119	0.126	0.144
	WLAN5.2GHz/802.11n-40	Left Cheek	38	9.51	10.00	1.119	0.309	0.352
25#	WLAN5.2GHz/802.11n-40	Left Tilt	38	9.51	10.00	1.119	0.310	0.354
Ant.1								
	WLAN5.2GHz/802.11n-40	Right Cheek	38	11.52	12.00	1.117	0.072	0.083
	WLAN5.2GHz/802.11n-40	Right Tilt	38	11.52	12.00	1.117	0.040	0.047
	WLAN5.2GHz/802.11n-40	Left Cheek	38	11.52	12.00	1.117	0.025	0.029
	WLAN5.2GHz/802.11n-40	Left Tilt	38	11.52	12.00	1.117	0.058	0.067
Ant.0								
	WLAN5.3GHz/802.11ac-20	Right Cheek	52	9.78	10.00	1.052	0.129	0.138
	WLAN5.3GHz/802.11ac-20	Right Tilt	52	9.78	10.00	1.052	0.108	0.116
	WLAN5.3GHz/802.11ac-20	Left Cheek	52	9.78	10.00	1.052	0.360	0.386
26#	WLAN5.3GHz/802.11ac-20	Left Tilt	52	9.78	10.00	1.052	0.361	0.387
Ant.1								
	WLAN5.3GHz/802.11n-40	Right Cheek	62	11.84	12.00	1.038	0.050	0.054
	WLAN5.3GHz/802.11n-40	Right Tilt	62	11.84	12.00	1.038	0.046	0.050
	WLAN5.3GHz/802.11n-40	Left Cheek	62	11.84	12.00	1.038	0.029	0.031
	WLAN5.3GHz/802.11n-40	Left Tilt	62	11.84	12.00	1.038	0.042	0.046



Plot No.	Band/Mode	Test Position	CH.	Ave. Power (dBm)	Tune-up Limit (dBm)	Tune-up Scaling Factor	Meas. SAR1g (W/kg)	Reported SAR1g (W/kg)
Ant.0								
	WLAN5.5GHz/802.11n-40	Right Cheek	142	12.27	12.50	1.054	0.222	0.243
	WLAN5.5GHz/802.11n-40	Right Tilt	142	12.27	12.50	1.054	0.165	0.181
27#	WLAN5.5GHz/802.11n-40	Left Cheek	142	12.27	12.50	1.054	0.508	0.556
	WLAN5.5GHz/802.11n-40	Left Tilt	142	12.27	12.50	1.054	0.434	0.475
Ant.1								
	WLAN5.5GHz/802.11ac-40	Right Cheek	126	13.08	13.50	1.102	0.022	0.025
	WLAN5.5GHz/802.11ac-40	Right Tilt	126	13.08	13.50	1.102	0.061	0.070
	WLAN5.5GHz/802.11ac-40	Left Cheek	126	13.08	13.50	1.102	0.030	0.034
	WLAN5.5GHz/802.11ac-40	Left Tilt	126	13.08	13.50	1.102	0.209	0.239
Ant.0								
	WLAN5.8GHz/802.11n-40	Right Cheek	159	12.16	12.50	1.081	0.196	0.220
	WLAN5.8GHz/802.11n-40	Right Tilt	159	12.16	12.50	1.081	0.230	0.258
28#	WLAN5.8GHz/802.11n-40	Left Cheek	159	12.16	12.50	1.081	0.476	0.534
	WLAN5.8GHz/802.11n-40	Left Tilt	159	12.16	12.50	1.081	0.469	0.526
Ant.1								
	WLAN5.8GHz/802.11n-40	Right Cheek	151	12.69	13.00	1.074	0.019	0.021
	WLAN5.8GHz/802.11n-40	Right Tilt	151	12.69	13.00	1.074	0.061	0.068
	WLAN5.8GHz/802.11n-40	Left Cheek	151	12.69	13.00	1.074	0.027	0.030
	WLAN5.8GHz/802.11n-40	Left Tilt	151	12.69	13.00	1.074	0.025	0.027

Note:

1. Per KDB 447498 D01v06, for each exposure position, if the highest output power channel Reported SAR ≤ 0.8 W/kg, other channels SAR testing is not necessary.
2. Per KDB 865664 D01v01r04, for each frequency band, repeated SAR measurement is required when the measured SAR is ≥ 0.8 W/kg.
3. Per KDB 941225 D05v02r05, 100% RB allocation SAR measurement is not required when the highest reported SAR for 1 RB and 50% RB allocation are ≤ 0.8 W/kg.
4. Per KDB 248227 D01v02r02, for 802.11b DSSS, when the reported SAR of the highest measured maximum output power channel for the exposure configuration is ≤ 0.8 W/kg, no further SAR testing is required in that exposure configuration.
5. Per KDB 248227 D01v02r02, OFDM SAR is not required when the highest reported SAR for DSSS is adjusted by the ratio of OFDM to DSSS specified maximum output power and the adjusted SAR is ≤ 1.2 W/kg.
6. According to KDB 865664 D02v01r02, SAR plot is required for the highest measured SAR in each exposure configuration, wireless mode and frequency band combination.



7. The WLAN Reported 1g SAR (W/kg) has been calculated together with the duty cycle scaling factor.

17.3. Body-worn SAR Data

➤ **GSM Body-worn SAR**

Plot No.	Band/Mode	Test Position	CH.	Ave. Power (dBm)	Tune-up Limit (dBm)	Tune-up Scaling Factor	Meas. SAR1g (W/kg)	Reported SAR1g (W/kg)
Top Ant.								
	GPRS850/3TX slots	Front Side	128	26.90	27.00	1.023	0.233	0.238
	GPRS850/3TX slots	Back Side	128	26.90	27.00	1.023	0.267	0.273
Bottom Ant.								
	GPRS850/3TX slots	Front Side	128	28.59	29.00	1.099	0.285	0.313
29#	GPRS850/3TX slots	Back Side	128	28.59	29.00	1.099	0.426	0.468
Top Ant.								
	GPRS1900/2TX slots	Front Side	661	22.65	23.00	1.084	0.200	0.217
	GPRS1900/2TX slots	Back Side	661	22.65	23.00	1.084	0.276	0.299
Bottom Ant.								
	GPRS1900/2TX slots	Front Side	661	25.15	25.50	1.084	0.273	0.296
30#	GPRS1900/2TX slots	Back Side	661	25.15	25.50	1.084	0.386	0.418

➤ **WCDMA Body-worn SAR**

Plot No.	Band/Mode	Test Position	CH.	Ave. Power (dBm)	Tune-up Limit (dBm)	Tune-up Scaling Factor	Meas. SAR1g (W/kg)	Reported SAR1g (W/kg)
Top Ant.								
	Band II/RMC	Front Side	9400	16.04	16.50	1.112	0.176	0.196
	Band II/RMC	Back Side	9400	16.04	16.50	1.112	0.216	0.240
Bottom Ant.								
	Band II/RMC	Front Side	9400	19.86	20.00	1.033	0.359	0.371
31#	Band II/RMC	Back Side	9400	19.86	20.00	1.033	0.441	0.455
Top Ant.								
	Band IV/RMC	Front Side	1413	17.87	18.00	1.030	0.143	0.147
	Band IV/RMC	Back Side	1413	17.87	18.00	1.030	0.157	0.162
Bottom Ant.								
	Band IV/RMC	Front Side	1413	21.37	21.50	1.030	0.459	0.473
32#	Band IV/RMC	Back Side	1413	21.37	21.50	1.030	0.483	0.498



Plot No.	Band/Mode	Test Position	CH.	Ave. Power (dBm)	Tune-up Limit (dBm)	Tune-up Scaling Factor	Meas. SAR1g (W/kg)	Reported SAR1g (W/kg)
Top Ant.								
	Band V/RMC	Front Side	4183	21.88	22.00	1.028	0.250	0.257
	Band V/RMC	Back Side	4183	21.88	22.00	1.028	0.262	0.269
Bottom Ant.								
	Band V/RMC	Front Side	4183	22.88	23.00	1.028	0.264	0.271
33#	Band V/RMC	Back Side	4183	22.88	23.00	1.028	0.324	0.333

➤ **CDMA Body-worn SAR**

Plot No.	Band/Mode	Test Position	CH.	Ave. Power (dBm)	Tune-up Limit (dBm)	Tune-up Scaling Factor	Meas. SAR1g (W/kg)	Reported SAR1g (W/kg)
Top Ant.								
	BC0/RC3 SO55	Front Side	384	23.84	24.00	1.038	0.343	0.356
	BC0/RC3 SO55	Back Side	384	23.84	24.00	1.038	0.305	0.316
Bottom Ant.								
	BC0/RC3 SO55	Front Side	384	23.84	24.00	1.038	0.313	0.325
34#	BC0/RC3 SO55	Back Side	384	23.84	24.00	1.038	0.397	0.412
Top Ant.								
	BC1/RC3 SO55	Front Side	25	15.44	15.50	1.014	0.134	0.136
	BC1/RC3 SO55	Back Side	25	15.44	15.50	1.014	0.162	0.164
Bottom Ant.								
	BC1/RC3 SO55	Front Side	25	17.86	18.00	1.033	0.282	0.291
35#	BC1/RC3 SO55	Back Side	25	17.86	18.00	1.033	0.392	0.405



➤ FDD-LTE QPSK Body-worn SAR

Plot No.	Band/Mode	Test Position	CH.	Ave. Power (dBm)	Tune-up Limit (dBm)	Tune-up Scaling Factor	Meas. SAR1g (W/kg)	Reported SAR1g (W/kg)
Top Ant.								
	LTE Band 2/1RB#99 20M	Front Side	19100	15.37	15.50	1.030	0.193	0.199
	LTE Band 2/1RB#99 20M	Back Side	19100	15.37	15.50	1.030	0.207	0.213
Bottom Ant.								
	LTE Band 2/50RB#50 20M	Front Side	19100	14.46	14.50	1.009	0.145	0.146
	LTE Band 2/50RB#50 20M	Back Side	19100	14.46	14.50	1.009	0.161	0.162
Bottom Ant.								
	LTE Band 2/1RB#99 20M	Front Side	19100	19.80	20.00	1.047	0.373	0.391
36#	LTE Band 2/1RB#99 20M	Back Side	19100	19.80	20.00	1.047	0.442	0.463
Bottom Ant.								
	LTE Band 2/50RB#50 20M	Front Side	19100	18.89	19.00	1.026	0.284	0.291
	LTE Band 2/50RB#50 20M	Back Side	19100	18.89	19.00	1.026	0.362	0.371
Top Ant.								
	LTE Band 4/1RB#0 20M	Front Side	20300	16.20	16.50	1.072	0.134	0.144
	LTE Band 4/1RB#0 20M	Back Side	20300	16.20	16.50	1.072	0.140	0.150
Bottom Ant.								
	LTE Band 4/50RB#50 20M	Front Side	20300	15.28	15.50	1.052	0.096	0.101
	LTE Band 4/50RB#50 20M	Back Side	20300	15.28	15.50	1.052	0.118	0.124
Bottom Ant.								
	LTE Band 4/1RB#0 20M	Front Side	20300	20.78	21.00	1.052	0.510	0.537
37#	LTE Band 4/1RB#0 20M	Back Side	20300	20.78	21.00	1.052	0.613	0.645
Bottom Ant.								
	LTE Band 4/50RB#50 20M	Front Side	20300	19.86	20.00	1.033	0.408	0.421
	LTE Band 4/50RB#50 20M	Back Side	20300	19.86	20.00	1.033	0.495	0.511
Top Ant.								
	LTE Band 5/1RB#0 10M	Front Side	20525	22.23	22.50	1.064	0.284	0.302
38#	LTE Band 5/1RB#0 10M	Back Side	20525	22.23	22.50	1.064	0.286	0.304
Bottom Ant.								
	LTE Band 5/25RB#0 10M	Front Side	20525	21.33	21.50	1.040	0.234	0.243
	LTE Band 5/25RB#0 10M	Back Side	20525	21.33	21.50	1.040	0.236	0.245



Plot No.	Band/Mode	Test Position	CH.	Ave. Power (dBm)	Tune-up Limit (dBm)	Tune-up Scaling Factor	Meas. SAR1g (W/kg)	Reported SAR1g (W/kg)
Bottom Ant.								
	LTE Band 5/1RB#0 10M	Front Side	20525	22.76	23.00	1.057	0.232	0.245
	LTE Band 5/1RB#0 10M	Back Side	20525	22.76	23.00	1.057	0.280	0.296
Bottom Ant.								
	LTE Band 5/25RB#0 10M	Front Side	20525	21.86	22.00	1.033	0.192	0.198
	LTE Band 5/25RB#0 10M	Back Side	20525	21.86	22.00	1.033	0.233	0.241
Top Ant.								
	LTE Band 7/1RB#49 20M	Front Side	21100	19.42	19.50	1.019	0.192	0.196
	LTE Band 7/1RB#49 20M	Back Side	21100	19.42	19.50	1.019	0.314	0.320
Bottom Ant.								
	LTE Band 7/50RB#0 20M	Front Side	21100	18.73	19.00	1.064	0.161	0.171
	LTE Band 7/50RB#0 20M	Back Side	21100	18.73	19.00	1.064	0.266	0.283
Bottom Ant.								
	LTE Band 7/1RB#49 20M	Front Side	21100	22.87	23.00	1.030	0.511	0.527
39#	LTE Band 7/1RB#49 20M	Back Side	21100	22.87	23.00	1.030	0.752	0.775
Bottom Ant.								
	LTE Band 7/50RB#0 20M	Front Side	21100	21.94	22.00	1.014	0.401	0.407
	LTE Band 7/50RB#0 20M	Back Side	21100	21.94	22.00	1.014	0.685	0.695
Top Ant.								
	LTE Band 12/1RB#49 10M	Front Side	23130	22.07	22.50	1.104	0.019	0.021
	LTE Band 12/1RB#49 10M	Back Side	23130	22.07	22.50	1.104	0.021	0.023
Bottom Ant.								
	LTE Band 12/25RB#12 10M	Front Side	23130	21.04	21.50	1.112	0.013	0.014
	LTE Band 12/25RB#12 10M	Back Side	23130	21.04	21.50	1.112	0.015	0.017
Bottom Ant.								
	LTE Band 12/1RB#49 10M	Front Side	23130	22.63	23.00	1.089	0.109	0.119
40#	LTE Band 12/1RB#49 10M	Back Side	23130	22.63	23.00	1.089	0.125	0.136
Bottom Ant.								
	LTE Band 12/25RB#12 10M	Front Side	23130	21.60	22.00	1.096	0.088	0.097
	LTE Band 12/25RB#12 10M	Back Side	23130	21.60	22.00	1.096	0.105	0.115



Plot No.	Band/Mode	Test Position	CH.	Ave. Power (dBm)	Tune-up Limit (dBm)	Tune-up Scaling Factor	Meas. SAR1g (W/kg)	Reported SAR1g (W/kg)
Top Ant.								
	LTE Band 17/1RB#25 10M	Front Side	23780	21.92	22.00	1.019	0.017	0.017
	LTE Band 17/1RB#25 10M	Back Side	23780	21.92	22.00	1.019	0.019	0.019
Bottom Ant.								
	LTE Band 17/25RB#12 10M	Front Side	23780	20.95	21.00	1.012	0.011	0.011
	LTE Band 17/25RB#12 10M	Back Side	23780	20.95	21.00	1.012	0.013	0.013
Bottom Ant.								
	LTE Band 17/1RB#25 10M	Front Side	23780	22.43	23.00	1.140	0.109	0.124
41#	LTE Band 17/1RB#25 10M	Back Side	23780	22.43	23.00	1.140	0.129	0.147
Bottom Ant.								
	LTE Band 17/25RB#12 10M	Front Side	23780	21.46	22.00	1.132	0.088	0.100
	LTE Band 17/25RB#12 10M	Back Side	23780	21.46	22.00	1.132	0.102	0.116
Top Ant.								
	LTE Band 18/1RB#0 15M	Front Side	23925	21.02	21.50	1.117	0.212	0.237
	LTE Band 18/1RB#0 15M	Back Side	23925	21.02	21.50	1.117	0.215	0.240
Bottom Ant.								
	LTE Band 18/36RB#20 15M	Front Side	23925	19.92	20.00	1.019	0.175	0.178
	LTE Band 18/36RB#20 15M	Back Side	23925	19.92	20.00	1.019	0.192	0.196
Bottom Ant.								
	LTE Band 18/1RB#0 15M	Front Side	23925	22.67	23.00	1.079	0.202	0.218
42#	LTE Band 18/1RB#0 15M	Back Side	23925	22.67	23.00	1.079	0.292	0.315
Bottom Ant.								
	LTE Band 18/36RB#20 15M	Front Side	23925	21.57	22.00	1.104	0.175	0.193
	LTE Band 18/36RB#20 15M	Back Side	23925	21.57	22.00	1.104	0.249	0.275
Top Ant.								
	LTE Band 19/1RB#0 15M	Front Side	24075	21.00	21.50	1.122	0.260	0.292
	LTE Band 19/1RB#0 15M	Back Side	24075	21.00	21.50	1.122	0.276	0.310
Bottom Ant.								
	LTE Band 19/36RB#0 15M	Front Side	24075	19.99	20.00	1.002	0.213	0.213
	LTE Band 19/36RB#0 15M	Back Side	24075	19.99	20.00	1.002	0.229	0.230



Plot No.	Band/Mode	Test Position	CH.	Ave. Power (dBm)	Tune-up Limit (dBm)	Tune-up Scaling Factor	Meas. SAR1g (W/kg)	Reported SAR1g (W/kg)
Bottom Ant.								
	LTE Band 19/1RB#0 15M	Front Side	24075	22.65	23.00	1.084	0.235	0.255
43#	LTE Band 19/1RB#0 15M	Back Side	24075	22.65	23.00	1.084	0.331	0.359
Bottom Ant.								
	LTE Band 19/36RB#0 15M	Front Side	24075	21.64	22.00	1.086	0.200	0.217
	LTE Band 19/36RB#0 15M	Back Side	24075	21.64	22.00	1.086	0.274	0.298
Top Ant.								
	LTE Band 25/1RB#0 20M	Front Side	26365	15.28	15.50	1.052	0.186	0.196
	LTE Band 25/1RB#0 20M	Back Side	26365	15.28	15.50	1.052	0.209	0.220
Bottom Ant.								
	LTE Band 25/50RB#24 20M	Front Side	26365	14.38	14.50	1.028	0.139	0.143
	LTE Band 25/50RB#24 20M	Back Side	26365	14.38	14.50	1.028	0.160	0.164
Bottom Ant.								
	LTE Band 25/1RB#0 20M	Front Side	26365	20.23	20.50	1.064	0.438	0.466
44#	LTE Band 25/1RB#0 20M	Back Side	26365	20.23	20.50	1.064	0.519	0.552
Bottom Ant.								
	LTE Band 25/50RB#24 20M	Front Side	26365	19.33	19.50	1.040	0.363	0.377
	LTE Band 25/50RB#24 20M	Back Side	26365	19.33	19.50	1.040	0.433	0.450
Top Ant.								
	LTE Band 26/1RB#0 15M	Front Side	26965	21.36	21.50	1.033	0.276	0.285
	LTE Band 26/1RB#0 15M	Back Side	26965	21.36	21.50	1.033	0.285	0.294
Bottom Ant.								
	LTE Band 26/36RB#0 15M	Front Side	26965	20.33	20.50	1.040	0.199	0.207
	LTE Band 26/36RB#0 15M	Back Side	26965	20.33	20.50	1.040	0.233	0.242
Bottom Ant.								
	LTE Band 26/1RB#0 15M	Front Side	26965	22.82	23.00	1.042	0.212	0.221
45#	LTE Band 26/1RB#0 15M	Back Side	26965	22.82	23.00	1.042	0.303	0.316
Bottom Ant.								
	LTE Band 26/36RB#0 15M	Front Side	26965	21.79	22.00	1.050	0.179	0.188
	LTE Band 26/36RB#0 15M	Back Side	26965	21.79	22.00	1.050	0.255	0.268



Plot No.	Band/Mode	Test Position	CH.	Ave. Power (dBm)	Tune-up Limit (dBm)	Tune-up Scaling Factor	Meas. SAR1g (W/kg)	Reported SAR1g (W/kg)
Top Ant.								
	LTE Band 30/1RB#0 10M	Front Side	27710	17.40	17.50	1.023	0.274	0.280
	LTE Band 30/1RB#0 10M	Back Side	27710	17.40	17.50	1.023	0.377	0.386
Bottom Ant.								
	LTE Band 30/25RB#12 10M	Front Side	27710	16.40	16.50	1.023	0.218	0.223
	LTE Band 30/25RB#12 10M	Back Side	27710	16.40	16.50	1.023	0.305	0.312
Bottom Ant.								
	LTE Band 30/1RB#0 10M	Front Side	27710	21.57	22.00	1.104	0.317	0.350
46#	LTE Band 30/1RB#0 10M	Back Side	27710	21.57	22.00	1.104	0.444	0.490
Top Ant.								
	LTE Band 30/25RB#12 10M	Front Side	27710	20.57	21.00	1.104	0.259	0.286
	LTE Band 30/25RB#12 10M	Back Side	27710	20.57	21.00	1.104	0.357	0.394
Top Ant.								
	LTE Band 66/1RB#0 20M	Front Side	132572	17.86	18.00	1.033	0.160	0.165
	LTE Band 66/1RB#0 20M	Back Side	132572	17.86	18.00	1.033	0.169	0.175
Bottom Ant.								
	LTE Band 66/50RB#0 20M	Front Side	132572	16.83	17.00	1.040	0.113	0.118
	LTE Band 66/50RB#0 20M	Back Side	132572	16.83	17.00	1.040	0.140	0.146
Bottom Ant.								
	LTE Band 66/1RB#0 20M	Front Side	132572	22.72	23.00	1.067	0.536	0.572
47#	LTE Band 66/1RB#0 20M	Back Side	132572	22.72	23.00	1.067	0.633	0.675
Bottom Ant.								
	LTE Band 66/50RB#0 20M	Front Side	132572	21.69	22.00	1.074	0.437	0.469
	LTE Band 66/50RB#0 20M	Back Side	132572	21.69	22.00	1.074	0.523	0.562



➤ TDD-LTE QPSK Body-worn SAR

Plot No.	Band/Mode	Test Position	CH.	Ave. Power (dBm)	Tune-up Limit (dBm)	Tune-up Scaling Factor	Meas. SAR1g (W/kg)	Reported SAR1g (W/kg)
Top Ant.								
	LTE Band 38/1RB#0 20M	Front Side	38150	19.37	19.50	1.030	0.076	0.079
	LTE Band 38/1RB#0 20M	Back Side	38150	19.37	19.50	1.030	0.105	0.109
	LTE Band 38/50RB#0 20M	Front Side	38150	18.56	19.00	1.107	0.060	0.067
	LTE Band 38/50RB#0 20M	Back Side	38150	18.56	19.00	1.107	0.087	0.097
Bottom Ant.								
	LTE Band 38/1RB#0 20M	Front Side	38150	22.94	23.50	1.138	0.159	0.182
48#	LTE Band 38/1RB#0 20M	Back Side	38150	22.94	23.50	1.138	0.176	0.201
	LTE Band 38/50RB#0 20M	Front Side	38150	22.10	22.50	1.096	0.131	0.145
	LTE Band 38/50RB#0 20M	Back Side	38150	22.10	22.50	1.096	0.154	0.170
Top Ant.								
	LTE Band 40A/1RB#0 10M	Front Side	38750	19.66	20.00	1.081	0.191	0.208
	LTE Band 40A/1RB#0 10M	Back Side	38750	19.66	20.00	1.081	0.216	0.235
	LTE Band 40A/25RB#0 10M	Front Side	38750	18.78	19.00	1.052	0.155	0.164
	LTE Band 40A/25RB#0 10M	Back Side	38750	18.78	19.00	1.052	0.178	0.188
Bottom Ant.								
	LTE Band 40A/1RB#0 10M	Front Side	38750	22.66	23.00	1.081	0.178	0.194
49#	LTE Band 40A/1RB#0 10M	Back Side	38750	22.66	23.00	1.081	0.253	0.275
	LTE Band 40A/25RB#0 10M	Front Side	38750	21.78	22.00	1.052	0.146	0.155
	LTE Band 40A/25RB#0 10M	Back Side	38750	21.78	22.00	1.052	0.210	0.222
Top Ant.								
	LTE Band 40B/1RB#25 10M	Front Side	39200	19.77	20.00	1.054	0.168	0.178
	LTE Band 40B/1RB#25 10M	Back Side	39200	19.77	20.00	1.054	0.193	0.205
	LTE Band 40B/25RB#0 10M	Front Side	39200	18.79	19.00	1.050	0.139	0.147
	LTE Band 40B/25RB#0 10M	Back Side	39200	18.79	19.00	1.050	0.161	0.170



Plot No.	Band/Mode	Test Position	CH.	Ave. Power (dBm)	Tune-up Limit (dBm)	Tune-up Scaling Factor	Meas. SAR1g (W/kg)	Reported SAR1g (W/kg)
Bottom Ant.								
	LTE Band 40B/1RB#25 10M	Front Side	39200	22.77	23.00	1.054	0.178	0.189
50#	LTE Band 40B/1RB#25 10M	Back Side	39200	22.77	23.00	1.054	0.258	0.274
Top Ant.								
	LTE Band 40B/25RB#0 10M	Front Side	39200	21.79	22.00	1.050	0.146	0.154
	LTE Band 40B/25RB#0 10M	Back Side	39200	21.79	22.00	1.050	0.211	0.223
Bottom Ant.								
	LTE Band 41/1RB#99 20M	Front Side	40340	19.30	19.50	1.047	0.067	0.071
	LTE Band 41/1RB#99 20M	Back Side	40340	19.30	19.50	1.047	0.099	0.104
	LTE Band 41/50RB#0 20M	Front Side	40340	18.37	18.50	1.030	0.057	0.059
	LTE Band 41/50RB#0 20M	Back Side	40340	18.37	18.50	1.030	0.084	0.087
Bottom Ant.								
	LTE Band 41/1RB#99 20M	Front Side	40340	22.94	23.50	1.138	0.146	0.167
51#	LTE Band 41/1RB#99 20M	Back Side	40340	22.94	23.50	1.138	0.202	0.231
	LTE Band 41/50RB#0 20M	Front Side	40340	22.15	22.50	1.084	0.121	0.132
	LTE Band 41/50RB#0 20M	Back Side	40340	22.15	22.50	1.084	0.180	0.196

Note: The LTE TDD Reported 1g SAR (W/kg) has been calculated together with the duty cycle scaling factor.



➤ **WLAN Body-worn SAR**

Plot No.	Band/Mode	Test Position	CH.	Ave. Power (dBm)	Tune-up Limit (dBm)	Tune-up Scaling Factor	Meas. SAR1g (W/kg)	Reported SAR1g (W/kg)
Ant.0								
	WLAN2.4GHz/802.11b	Front Side	1	14.67	15.00	1.079	0.064	0.070
52#	WLAN2.4GHz/802.11b	Back Side	1	14.67	15.00	1.079	0.070	0.076
Ant.1								
	WLAN2.4GHz/802.11b	Front Side	11	13.61	14.00	1.094	0.011	0.013
	WLAN2.4GHz/802.11b	Back Side	11	13.61	14.00	1.094	0.036	0.039
Ant.0								
	WLAN5.2GHz/802.11n-40	Front Side	38	9.51	10.00	1.119	0.087	0.101
53#	WLAN5.2GHz/802.11n-40	Back Side	38	9.51	10.00	1.119	0.105	0.122
Ant.1								
	WLAN5.2GHz/802.11n-40	Front Side	38	11.52	12.00	1.117	0.044	0.051
	WLAN5.2GHz/802.11n-40	Back Side	38	11.52	12.00	1.117	0.063	0.073
Ant.0								
	WLAN5.3GHz/802.11ac-20	Front Side	52	9.78	10.00	1.052	0.105	0.112
54#	WLAN5.3GHz/802.11ac-20	Back Side	52	9.78	10.00	1.052	0.157	0.168
Ant.1								
	WLAN5.3GHz/802.11n-40	Front Side	62	11.84	12.00	1.038	0.013	0.014
	WLAN5.3GHz/802.11n-40	Back Side	62	11.84	12.00	1.038	0.094	0.101
Ant.0								
	WLAN5.5GHz/802.11n-40	Front Side	142	12.27	12.50	1.054	0.112	0.123
	WLAN5.5GHz/802.11n-40	Back Side	142	12.27	12.50	1.054	0.208	0.228
Ant.1								
	WLAN5.5GHz/802.11ac-40	Front Side	126	13.08	13.50	1.102	0.030	0.034
55#	WLAN5.5GHz/802.11ac-40	Back Side	126	13.08	13.50	1.102	0.324	0.370
Ant.0								
	WLAN5.8GHz/802.11n-40	Front Side	159	12.16	12.50	1.081	0.126	0.141
	WLAN5.8GHz/802.11n-40	Back Side	159	12.16	12.50	1.081	0.178	0.200
Ant.1								
	WLAN5.8GHz/802.11n-40	Front Side	151	12.69	13.00	1.074	0.019	0.021
56#	WLAN5.8GHz/802.11n-40	Back Side	151	12.69	13.00	1.074	0.348	0.388

Note: The WLAN Reported 1g SAR (W/kg) has been calculated together with the duty cycle scaling factor.



➤ **Bluetooth Body-worn SAR**

Plot No.	Band/Mode	Test Position	CH.	Ave. Power (dBm)	Tune-up Limit (dBm)	Tune-up Scaling Factor	Meas. SAR1g (W/kg)	Reported SAR1g (W/kg)
	Bluetooth/1Mbps	Front Side	0	13.25	13.50	1.059	0.019	0.026
57#	Bluetooth/1Mbps	Back Side	0	13.25	13.50	1.059	0.021	0.028



17.4. Hotspot SAR Data

➤ GSM Hotspot SAR

Plot No.	Band/Mode	Test Position	CH.	Ave. Power (dBm)	Tune-up Limit (dBm)	Tune-up Scaling Factor	Meas. SAR1g (W/kg)	Reported SAR1g (W/kg)
Top Ant.								
	GPRS850/3TX slots	Front Side	128	26.90	27.00	1.023	0.233	0.238
	GPRS850/3TX slots	Back Side	128	26.90	27.00	1.023	0.267	0.273
	GPRS850/3TX slots	Left Side	128	26.90	27.00	1.023	0.031	0.031
	GPRS850/3TX slots	Right Side	128	26.90	27.00	1.023	0.030	0.031
	GPRS850/3TX slots	Top Side	128	26.90	27.00	1.023	0.217	0.222
Bottom Ant.								
	GPRS850/3TX slots	Front Side	128	28.59	29.00	1.099	0.285	0.313
58#	GPRS850/3TX slots	Back Side	128	28.59	29.00	1.099	0.426	0.468
	GPRS850/3TX slots	Left Side	128	28.59	29.00	1.099	0.031	0.034
	GPRS850/3TX slots	Right Side	128	28.59	29.00	1.099	0.122	0.134
	GPRS850/3TX slots	Bottom Side	128	28.59	29.00	1.099	0.247	0.271
Top Ant.								
	GPRS1900/2TX slots	Front Side	661	22.65	23.00	1.084	0.200	0.217
	GPRS1900/2TX slots	Back Side	661	22.65	23.00	1.084	0.276	0.299
	GPRS1900/2TX slots	Left Side	661	22.65	23.00	1.084	0.036	0.039
	GPRS1900/2TX slots	Right Side	661	22.65	23.00	1.084	0.027	0.029
	GPRS1900/2TX slots	Top Side	661	22.65	23.00	1.084	0.434	0.470
Bottom Ant.								
	GPRS1900/2TX slots	Front Side	661	25.15	25.50	1.084	0.273	0.296
	GPRS1900/2TX slots	Back Side	661	25.15	25.50	1.084	0.386	0.418
	GPRS1900/2TX slots	Left Side	661	25.15	25.50	1.084	0.070	0.076
	GPRS1900/2TX slots	Right Side	661	25.15	25.50	1.084	0.043	0.046
	GPRS1900/2TX slots	Bottom Side	661	25.15	25.50	1.084	0.792	0.858
	GPRS1900/2TX slots	Bottom Side	512	24.88	25.50	1.153	0.695	0.802
59#	GPRS1900/2TX slots	Bottom Side	810	25.02	25.50	1.117	0.824	0.920



➤ **WCDMA Hotspot SAR**

Plot No.	Band/Mode	Test Position	CH.	Ave. Power (dBm)	Tune-up Limit (dBm)	Tune-up Scaling Factor	Meas. SAR1g (W/kg)	Reported SAR1g (W/kg)
Top Ant.								
	Band II/RMC	Front Side	9400	16.04	16.50	1.112	0.176	0.196
	Band II/RMC	Back Side	9400	16.04	16.50	1.112	0.216	0.240
	Band II/RMC	Left Side	9400	16.04	16.50	1.112	0.034	0.038
	Band II/RMC	Right Side	9400	16.04	16.50	1.112	0.025	0.028
	Band II/RMC	Top Side	9400	16.04	16.50	1.112	0.395	0.439
Bottom Ant.								
	Band II/RMC	Front Side	9400	19.86	20.00	1.033	0.359	0.371
	Band II/RMC	Back Side	9400	19.86	20.00	1.033	0.441	0.455
	Band II/RMC	Left Side	9400	19.86	20.00	1.033	0.077	0.079
	Band II/RMC	Right Side	9400	19.86	20.00	1.033	0.052	0.053
	Band II/RMC	Bottom Side	9400	19.86	20.00	1.033	0.815	0.842
	Band II/RMC	Bottom Side	9262	19.84	20.00	1.038	0.662	0.687
60#	Band II/RMC	Bottom Side	9538	19.83	20.00	1.040	0.952	0.990
Top Ant.								
	Band IV/RMC	Front Side	1413	17.87	18.00	1.030	0.143	0.147
	Band IV/RMC	Back Side	1413	17.87	18.00	1.030	0.157	0.162
	Band IV/RMC	Left Side	1413	17.87	18.00	1.030	0.026	0.027
	Band IV/RMC	Right Side	1413	17.87	18.00	1.030	0.014	0.014
	Band IV/RMC	Top Side	1413	17.87	18.00	1.030	0.247	0.255
Bottom Ant.								
	Band IV/RMC	Front Side	1413	21.37	21.50	1.030	0.459	0.473
	Band IV/RMC	Back Side	1413	21.37	21.50	1.030	0.483	0.498
	Band IV/RMC	Left Side	1413	21.37	21.50	1.030	0.098	0.101
	Band IV/RMC	Right Side	1413	21.37	21.50	1.030	0.079	0.081
	Band IV/RMC	Bottom Side	1413	21.37	21.50	1.030	0.820	0.845
61#	Band IV/RMC	Bottom Side	1312	20.87	21.50	1.156	0.799	0.924
	Band IV/RMC	Bottom Side	1513	21.23	21.50	1.064	0.847	0.901
Top Ant.								
	Band V/RMC	Front Side	4183	21.88	22.00	1.028	0.250	0.257
	Band V/RMC	Back Side	4183	21.88	22.00	1.028	0.262	0.269
	Band V/RMC	Left Side	4183	21.88	22.00	1.028	0.026	0.027
	Band V/RMC	Right Side	4132	21.88	22.00	1.028	0.088	0.090
	Band V/RMC	Top Side	4132	21.88	22.00	1.028	0.172	0.177



Plot No.	Band/Mode	Test Position	CH.	Ave. Power (dBm)	Tune-up Limit (dBm)	Tune-up Scaling Factor	Meas. SAR1g (W/kg)	Reported SAR1g (W/kg)
Bottom Ant.								
	Band V/RMC	Front Side	4183	22.88	23.00	1.028	0.264	0.271
62#	Band V/RMC	Back Side	4183	22.88	23.00	1.028	0.324	0.333
	Band V/RMC	Left Side	4183	22.88	23.00	1.028	0.026	0.027
	Band V/RMC	Right Side	4132	22.88	23.00	1.028	0.130	0.134
	Band V/RMC	Bottom Side	4132	22.88	23.00	1.028	0.177	0.182

➤ **CDMA Hotspot SAR**

Plot No.	Band/Mode	Test Position	CH.	Ave. Power (dBm)	Tune-up Limit (dBm)	Tune-up Scaling Factor	Meas. SAR1g (W/kg)	Reported SAR1g (W/kg)
Top Ant.								
	BC0/RTAP153.6Kbps	Front Side	384	23.62	24.00	1.091	0.334	0.365
	BC0/RTAP153.6Kbps	Back Side	384	23.62	24.00	1.091	0.315	0.344
	BC0/RTAP153.6Kbps	Left Side	384	23.62	24.00	1.091	0.044	0.048
	BC0/RTAP153.6Kbps	Right Side	384	23.62	24.00	1.091	0.160	0.175
	BC0/RTAP153.6Kbps	Top Side	384	23.62	24.00	1.091	0.235	0.256
Bottom Ant.								
	BC0/RTAP153.6Kbps	Front Side	384	23.62	24.00	1.091	0.350	0.382
63#	BC0/RTAP153.6Kbps	Back Side	384	23.62	24.00	1.091	0.435	0.475
	BC0/RTAP153.6Kbps	Left Side	384	23.62	24.00	1.091	0.034	0.037
	BC0/RTAP153.6Kbps	Right Side	384	23.62	24.00	1.091	0.184	0.201
	BC0/RTAP153.6Kbps	Bottom Side	384	23.62	24.00	1.091	0.261	0.285
Top Ant.								
	BC1/RTAP153.6Kbps	Front Side	25	15.24	15.50	1.062	0.186	0.197
	BC1/RTAP153.6Kbps	Back Side	25	15.24	15.50	1.062	0.202	0.214
	BC1/RTAP153.6Kbps	Left Side	25	15.24	15.50	1.062	0.037	0.039
	BC1/RTAP153.6Kbps	Right Side	25	15.24	15.50	1.062	0.025	0.026
	BC1/RTAP153.6Kbps	Top Side	25	15.24	15.50	1.062	0.379	0.402
Bottom Ant.								
	BC1/RTAP153.6Kbps	Front Side	25	17.66	18.00	1.081	0.289	0.313
	BC1/RTAP153.6Kbps	Back Side	25	17.66	18.00	1.081	0.332	0.359
	BC1/RTAP153.6Kbps	Left Side	25	17.66	18.00	1.081	0.065	0.070
	BC1/RTAP153.6Kbps	Right Side	25	17.66	18.00	1.081	0.040	0.043
64#	BC1/RTAP153.6Kbps	Bottom Side	25	17.66	18.00	1.081	0.577	0.624



➤ FDD-LTE QPSK Hotspot SAR

Plot No.	Band/Mode	Test Position	CH.	Ave. Power (dBm)	Tune-up Limit (dBm)	Tune-up Scaling Factor	Meas. SAR1g (W/kg)	Reported SAR1g (W/kg)
Top Ant.								
	LTE Band 2/1RB#99 20M	Front Side	19100	15.37	15.50	1.030	0.193	0.199
	LTE Band 2/1RB#99 20M	Back Side	19100	15.37	15.50	1.030	0.207	0.213
	LTE Band 2/1RB#99 20M	Left Side	19100	15.37	15.50	1.030	0.036	0.038
	LTE Band 2/1RB#99 20M	Right Side	19100	15.37	15.50	1.030	0.031	0.032
	LTE Band 2/1RB#99 20M	Top Side	19100	15.37	15.50	1.030	0.392	0.404
Bottom Ant.								
	LTE Band 2/50RB#50 20M	Front Side	19100	14.46	14.50	1.009	0.145	0.146
	LTE Band 2/50RB#50 20M	Back Side	19100	14.46	14.50	1.009	0.161	0.162
	LTE Band 2/50RB#50 20M	Left Side	19100	14.46	14.50	1.009	0.034	0.034
	LTE Band 2/50RB#50 20M	Right Side	19100	14.46	14.50	1.009	0.027	0.028
	LTE Band 2/50RB#50 20M	Top Side	19100	14.46	14.50	1.009	0.333	0.336
Bottom Ant.								
	LTE Band 2/1RB#99 20M	Front Side	19100	19.80	20.00	1.047	0.373	0.391
	LTE Band 2/1RB#99 20M	Back Side	19100	19.80	20.00	1.047	0.442	0.463
	LTE Band 2/1RB#99 20M	Left Side	19100	19.80	20.00	1.047	0.071	0.074
	LTE Band 2/1RB#99 20M	Right Side	19100	19.80	20.00	1.047	0.421	0.441
65#	LTE Band 2/1RB#99 20M	Bottom Side	19100	19.80	20.00	1.047	0.898	0.940
	LTE Band 2/1RB#99 20M	Bottom Side	18700	19.60	20.00	1.096	0.702	0.770
	LTE Band 2/1RB#99 20M	Bottom Side	18900	19.76	20.00	1.057	0.777	0.821
	LTE Band 2/100RB#0 20M	Bottom Side	19100	18.75	19.00	1.059	0.430	0.455
Bottom Ant.								
	LTE Band 2/50RB#50 20M	Front Side	19100	18.89	19.00	1.026	0.284	0.291
	LTE Band 2/50RB#50 20M	Back Side	19100	18.89	19.00	1.026	0.362	0.371
	LTE Band 2/50RB#50 20M	Left Side	19100	18.89	19.00	1.026	0.062	0.064
	LTE Band 2/50RB#50 20M	Right Side	19100	18.89	19.00	1.026	0.038	0.039
	LTE Band 2/50RB#50 20M	Bottom Side	19100	18.89	19.00	1.026	0.641	0.657



Plot No.	Band/Mode	Test Position	CH.	Ave. Power (dBm)	Tune-up Limit (dBm)	Tune-up Scaling Factor	Meas. SAR1g (W/kg)	Reported SAR1g (W/kg)
Top Ant.								
	LTE Band 4/1RB#0 20M	Front Side	20300	16.20	16.50	1.072	0.134	0.144
	LTE Band 4/1RB#0 20M	Back Side	20300	16.20	16.50	1.072	0.140	0.150
	LTE Band 4/1RB#0 20M	Left Side	20300	16.20	16.50	1.072	0.021	0.022
	LTE Band 4/1RB#0 20M	Right Side	20300	16.20	16.50	1.072	0.016	0.017
	LTE Band 4/1RB#0 20M	Top Side	20300	16.20	16.50	1.072	0.253	0.271
Bottom Ant.								
	LTE Band 4/50RB#50 20M	Front Side	20300	15.28	15.50	1.052	0.096	0.101
	LTE Band 4/50RB#50 20M	Back Side	20300	15.28	15.50	1.052	0.118	0.124
	LTE Band 4/50RB#50 20M	Left Side	20300	15.28	15.50	1.052	0.019	0.020
	LTE Band 4/50RB#50 20M	Right Side	20300	15.28	15.50	1.052	0.015	0.015
	LTE Band 4/50RB#50 20M	Top Side	20300	15.28	15.50	1.052	0.224	0.236
Bottom Ant.								
	LTE Band 4/1RB#0 20M	Front Side	20300	20.78	21.00	1.052	0.510	0.537
	LTE Band 4/1RB#0 20M	Back Side	20300	20.78	21.00	1.052	0.613	0.645
	LTE Band 4/1RB#0 20M	Left Side	20300	20.78	21.00	1.052	0.124	0.130
	LTE Band 4/1RB#0 20M	Right Side	20300	20.78	21.00	1.052	0.101	0.106
	LTE Band 4/1RB#0 20M	Bottom Side	20300	20.78	21.00	1.052	0.920	0.968
66#	LTE Band 4/1RB#0 20M	Bottom Side	20175	20.64	21.00	1.086	0.947	1.029
	LTE Band 4/1RB#0 20M	Bottom Side	20050	20.66	21.00	1.081	0.930	1.006
	LTE Band 4/ 100RB#0 20M	Bottom Side	20175	19.83	20.00	1.040	0.465	0.484
Bottom Ant.								
	LTE Band 4/50RB#50 20M	Front Side	20300	19.86	20.00	1.033	0.408	0.421
	LTE Band 4/50RB#50 20M	Back Side	20300	19.86	20.00	1.033	0.495	0.511
	LTE Band 4/50RB#50 20M	Left Side	20300	19.86	20.00	1.033	0.101	0.104
	LTE Band 4/50RB#50 20M	Right Side	20300	19.86	20.00	1.033	0.086	0.089
	LTE Band 4/50RB#50 20M	Bottom Side	20300	19.86	20.00	1.033	0.788	0.814



Plot No.	Band/Mode	Test Position	CH.	Ave. Power (dBm)	Tune-up Limit (dBm)	Tune-up Scaling Factor	Meas. SAR1g (W/kg)	Reported SAR1g (W/kg)
Top Ant.								
	LTE Band 5/1RB#0 10M	Front Side	20525	22.23	22.50	1.064	0.284	0.302
67#	LTE Band 5/1RB#0 10M	Back Side	20525	22.23	22.50	1.064	0.286	0.304
	LTE Band 5/1RB#0 10M	Left Side	20525	22.23	22.50	1.064	0.029	0.031
	LTE Band 5/1RB#0 10M	Right Side	20525	22.23	22.50	1.064	0.111	0.118
	LTE Band 5/1RB#0 10M	Top Side	20525	22.23	22.50	1.064	0.188	0.200
Bottom Ant.								
	LTE Band 5/25RB#0 10M	Front Side	20525	21.33	21.50	1.040	0.234	0.243
	LTE Band 5/25RB#0 10M	Back Side	20525	21.33	21.50	1.040	0.236	0.245
	LTE Band 5/25RB#0 10M	Left Side	20525	21.33	21.50	1.040	0.025	0.026
	LTE Band 5/25RB#0 10M	Right Side	20525	21.33	21.50	1.040	0.092	0.095
	LTE Band 5/25RB#010M	Top Side	20525	21.33	21.50	1.040	0.121	0.126
Bottom Ant.								
	LTE Band 5/1RB#0 10M	Front Side	20525	22.76	23.00	1.057	0.232	0.245
	LTE Band 5/1RB#0 10M	Back Side	20525	22.76	23.00	1.057	0.280	0.296
	LTE Band 5/1RB#0 10M	Left Side	20525	22.76	23.00	1.057	0.043	0.045
	LTE Band 5/1RB#0 10M	Right Side	20525	22.76	23.00	1.057	0.113	0.119
	LTE Band 5/1RB#0 10M	Bottom Side	20525	22.76	23.00	1.057	0.196	0.207
Bottom Ant.								
	LTE Band 5/25RB#0 10M	Front Side	20525	21.86	22.00	1.033	0.192	0.198
	LTE Band 5/25RB#0 10M	Back Side	20525	21.86	22.00	1.033	0.233	0.241
	LTE Band 5/25RB#0 10M	Left Side	20525	21.86	22.00	1.033	0.035	0.036
	LTE Band 5/25RB#0 10M	Right Side	20525	21.86	22.00	1.033	0.090	0.093
	LTE Band 5/25RB#0 10M	Bottom Side	20525	21.86	22.00	1.033	0.160	0.165



Plot No.	Band/Mode	Test Position	CH.	Ave. Power (dBm)	Tune-up Limit (dBm)	Tune-up Scaling Factor	Meas. SAR1g (W/kg)	Reported SAR1g (W/kg)
Top Ant.								
	LTE Band 7/1RB#49 20M	Front Side	21100	19.42	19.50	1.019	0.192	0.196
	LTE Band 7/1RB#49 20M	Back Side	21100	19.42	19.50	1.019	0.314	0.320
	LTE Band 7/1RB#49 20M	Left Side	21100	19.42	19.50	1.019	0.060	0.062
	LTE Band 7/1RB#49 20M	Right Side	21100	19.42	19.50	1.019	0.043	0.044
	LTE Band 7/1RB#49 20M	Top Side	21100	19.42	19.50	1.019	0.701	0.714
Bottom Ant.								
	LTE Band 7/50RB#0 20M	Front Side	21100	18.73	19.00	1.064	0.161	0.171
	LTE Band 7/50RB#0 20M	Back Side	21100	18.73	19.00	1.064	0.266	0.283
	LTE Band 7/50RB#0 20M	Left Side	21100	18.73	19.00	1.064	0.052	0.055
	LTE Band 7/50RB#0 20M	Right Side	21100	18.73	19.00	1.064	0.023	0.025
	LTE Band 7/50RB#0 20M	Top Side	21100	18.73	19.00	1.064	0.573	0.610
Bottom Ant.								
	LTE Band 7/1RB#49 20M	Front Side	21100	22.87	23.00	1.030	0.511	0.527
	LTE Band 7/1RB#49 20M	Back Side	21100	22.87	23.00	1.030	0.752	0.775
	LTE Band 7/1RB#49 20M	Left Side	21100	22.87	23.00	1.030	0.220	0.227
	LTE Band 7/1RB#49 20M	Right Side	21100	22.87	23.00	1.030	0.071	0.073
68#	LTE Band 7/1RB#49 20M	Bottom Side	21100	22.87	23.00	1.030	1.120	1.154
	LTE Band 7/1RB#49 20M	Bottom Side	20850	22.62	23.00	1.091	0.880	0.960
	LTE Band 7/1RB#49 20M	Bottom Side	21350	22.76	23.00	1.057	0.973	1.028
	LTE Band 7/100RB#0 20M	Bottom Side	21100	21.90	21.00	0.813	0.597	0.485
Bottom Ant.								
	LTE Band 7/50RB#0 20M	Front Side	21100	21.94	22.00	1.014	0.401	0.407
	LTE Band 7/50RB#0 20M	Back Side	21100	21.94	22.00	1.014	0.685	0.695
	LTE Band 7/50RB#0 20M	Left Side	21100	21.94	22.00	1.014	0.187	0.190
	LTE Band 7/50RB#0 20M	Right Side	21100	21.94	22.00	1.014	0.063	0.064
	LTE Band 7/50RB#0 20M	Bottom Side	21100	21.94	22.00	1.014	0.731	0.741



Plot No.	Band/Mode	Test Position	CH.	Ave. Power (dBm)	Tune-up Limit (dBm)	Tune-up Scaling Factor	Meas. SAR1g (W/kg)	Reported SAR1g (W/kg)
Top Ant.								
	LTE Band 12/1RB#49 10M	Front Side	23130	22.07	22.50	1.104	0.019	0.021
	LTE Band 12/1RB#49 10M	Back Side	23130	22.07	22.50	1.104	0.021	0.023
	LTE Band 12/1RB#49 10M	Left Side	23130	22.07	22.50	1.104	0.022	0.024
	LTE Band 12/1RB#49 10M	Right Side	23130	22.07	22.50	1.104	0.010	0.011
	LTE Band 12/1RB#49 10M	Top Side	23130	22.07	22.50	1.104	0.015	0.017
Bottom Ant.								
	LTE Band 12/25RB#12 10M	Front Side	23130	21.04	21.50	1.112	0.013	0.014
	LTE Band 12/25RB#12 10M	Back Side	23130	21.04	21.50	1.112	0.015	0.017
	LTE Band 12/25RB#12 10M	Left Side	23130	21.04	21.50	1.112	0.002	0.002
	LTE Band 12/25RB#12 10M	Right Side	23130	21.04	21.50	1.112	0.007	0.008
	LTE Band 12/25RB#12 10M	Top Side	23130	21.04	21.50	1.112	0.010	0.012
Bottom Ant.								
	LTE Band 12/1RB#49 10M	Front Side	23130	22.63	23.00	1.089	0.109	0.119
	LTE Band 12/1RB#49 10M	Back Side	23130	22.63	23.00	1.089	0.125	0.136
	LTE Band 12/1RB#49 10M	Left Side	23130	22.63	23.00	1.089	0.056	0.061
69#	LTE Band 12/1RB#49 10M	Right Side	23130	22.63	23.00	1.089	0.139	0.151
	LTE Band 12/1RB#49 10M	Bottom Side	23130	22.63	23.00	1.089	0.080	0.087
Bottom Ant.								
	LTE Band 12/25RB#12 10M	Front Side	23130	21.60	22.00	1.096	0.088	0.097
	LTE Band 12/25RB#12 10M	Back Side	23130	21.60	22.00	1.096	0.105	0.115
	LTE Band 12/25RB#12 10M	Left Side	23130	21.60	22.00	1.096	0.049	0.054
	LTE Band 12/25RB#12 10M	Right Side	23130	21.60	22.00	1.096	0.114	0.125
	LTE Band 12/25RB#12 10M	Bottom Side	23130	21.60	22.00	1.096	0.060	0.066



Plot No.	Band/Mode	Test Position	CH.	Ave. Power (dBm)	Tune-up Limit (dBm)	Tune-up Scaling Factor	Meas. SAR1g (W/kg)	Reported SAR1g (W/kg)
Top Ant.								
	LTE Band 17/1RB#25 10M	Front Side	23780	21.92	22.00	1.019	0.017	0.017
	LTE Band 17/1RB#25 10M	Back Side	23780	21.92	22.00	1.019	0.019	0.019
	LTE Band 17/1RB#25 10M	Left Side	23780	21.92	22.00	1.019	0.002	0.002
	LTE Band 17/1RB#25 10M	Right Side	23780	21.92	22.00	1.019	0.009	0.009
	LTE Band 17/1RB#25 10M	Top Side	23780	21.92	22.00	1.019	0.013	0.014
Bottom Ant.								
	LTE Band 17/25RB#12 10M	Front Side	23780	20.95	21.00	1.012	0.011	0.011
	LTE Band 17/25RB#12 10M	Back Side	23780	20.95	21.00	1.012	0.013	0.013
	LTE Band 17/25RB#12 10M	Left Side	23780	20.95	21.00	1.012	0.002	0.002
	LTE Band 17/25RB#12 10M	Right Side	23780	20.95	21.00	1.012	0.007	0.007
	LTE Band 17/25RB#12 10M	Top Side	23780	20.95	21.00	1.012	0.010	0.010
Bottom Ant.								
	LTE Band 17/1RB#25 10M	Front Side	23780	22.43	23.00	1.140	0.109	0.124
	LTE Band 17/1RB#25 10M	Back Side	23780	22.43	23.00	1.140	0.129	0.147
	LTE Band 17/1RB#25 10M	Left Side	23780	22.43	23.00	1.140	0.059	0.068
70#	LTE Band 17/1RB#25 10M	Right Side	23780	22.43	23.00	1.140	0.138	0.157
	LTE Band 17/1RB#25 10M	Bottom Side	23780	22.43	23.00	1.140	0.084	0.096
Bottom Ant.								
	LTE Band 17/25RB#12 10M	Front Side	23780	21.46	22.00	1.132	0.088	0.100
	LTE Band 17/25RB#12 10M	Back Side	23780	21.46	22.00	1.132	0.102	0.116
	LTE Band 17/25RB#12 10M	Left Side	23780	21.46	22.00	1.132	0.047	0.053
	LTE Band 17/25RB#12 10M	Right Side	23780	21.46	22.00	1.132	0.111	0.126
	LTE Band 17/25RB#12 10M	Bottom Side	23780	21.46	22.00	1.132	0.068	0.077



Plot No.	Band/Mode	Test Position	CH.	Ave. Power (dBm)	Tune-up Limit (dBm)	Tune-up Scaling Factor	Meas. SAR1g (W/kg)	Reported SAR1g (W/kg)
Top Ant.								
	LTE Band 18/1RB#0 15M	Front Side	23925	21.02	21.50	1.117	0.212	0.237
	LTE Band 18/1RB#0 15M	Back Side	23925	21.02	21.50	1.117	0.215	0.240
	LTE Band 18/1RB#0 15M	Left Side	23925	21.02	21.50	1.117	0.038	0.042
	LTE Band 18/1RB#0 15M	Right Side	23925	21.02	21.50	1.117	0.072	0.080
	LTE Band 18/1RB#0 15M	Top Side	23925	21.02	21.50	1.117	0.127	0.142
Bottom Ant.								
	LTE Band 18/36RB#20 15M	Front Side	23925	19.92	20.00	1.019	0.175	0.178
	LTE Band 18/36RB#20 15M	Back Side	23925	19.92	20.00	1.019	0.192	0.196
	LTE Band 18/36RB#20 15M	Left Side	23925	19.92	20.00	1.019	0.022	0.022
	LTE Band 18/36RB#20 15M	Right Side	23925	19.92	20.00	1.019	0.060	0.061
	LTE Band 18/36RB#20 15M	Top Side	23925	19.92	20.00	1.019	0.106	0.108
Bottom Ant.								
	LTE Band 18/1RB#0 15M	Front Side	23925	22.67	23.00	1.079	0.202	0.218
71#	LTE Band 18/1RB#0 15M	Back Side	23925	22.67	23.00	1.079	0.292	0.315
	LTE Band 18/1RB#0 15M	Left Side	23925	22.67	23.00	1.079	0.028	0.030
	LTE Band 18/1RB#0 15M	Right Side	23925	22.67	23.00	1.079	0.020	0.022
	LTE Band 18/1RB#0 15M	Bottom Side	23925	22.67	23.00	1.079	0.159	0.172
Bottom Ant.								
	LTE Band 18/36RB#20 15M	Front Side	23925	21.57	22.00	1.104	0.175	0.193
	LTE Band 18/36RB#20 15M	Back Side	23925	21.57	22.00	1.104	0.249	0.275
	LTE Band 18/36RB#20 15M	Left Side	23925	21.57	22.00	1.104	0.025	0.027
	LTE Band 18/36RB#20 15M	Right Side	23925	21.57	22.00	1.104	0.018	0.020
	LTE Band 18/36RB#20 15M	Bottom Side	23925	21.57	22.00	1.104	0.136	0.150



Plot No.	Band/Mode	Test Position	CH.	Ave. Power (dBm)	Tune-up Limit (dBm)	Tune-up Scaling Factor	Meas. SAR1g (W/kg)	Reported SAR1g (W/kg)
Top Ant.								
	LTE Band 19/1RB#0 15M	Front Side	24075	21.00	21.50	1.122	0.260	0.292
	LTE Band 19/1RB#0 15M	Back Side	24075	21.00	21.50	1.122	0.276	0.310
	LTE Band 19/1RB#0 15M	Left Side	24075	21.00	21.50	1.122	0.048	0.053
	LTE Band 19/1RB#0 15M	Right Side	24075	21.00	21.50	1.122	0.107	0.120
	LTE Band 19/1RB#0 15M	Top Side	24075	21.00	21.50	1.122	0.183	0.205
Bottom Ant.								
	LTE Band 19/36RB#0 15M	Front Side	24075	19.99	20.00	1.002	0.213	0.213
	LTE Band 19/36RB#0 15M	Back Side	24075	19.99	20.00	1.002	0.229	0.230
	LTE Band 19/36RB#0 15M	Left Side	24075	19.99	20.00	1.002	0.026	0.026
	LTE Band 19/36RB#0 15M	Right Side	24075	19.99	20.00	1.002	0.072	0.072
	LTE Band 19/36RB#0 15M	Top Side	24075	19.99	20.00	1.002	0.127	0.127
Bottom Ant.								
	LTE Band 19/1RB#0 15M	Front Side	24075	22.65	23.00	1.084	0.235	0.255
72#	LTE Band 19/1RB#0 15M	Back Side	24075	22.65	23.00	1.084	0.331	0.359
	LTE Band 19/1RB#0 15M	Left Side	24075	22.65	23.00	1.084	0.032	0.034
	LTE Band 19/1RB#0 15M	Right Side	24075	22.65	23.00	1.084	0.022	0.024
	LTE Band 19/1RB#0 15M	Bottom Side	24075	22.65	23.00	1.084	0.114	0.124
Bottom Ant.								
	LTE Band 19/36RB#0 15M	Front Side	24075	21.64	22.00	1.086	0.200	0.217
	LTE Band 19/36RB#0 15M	Back Side	24075	21.64	22.00	1.086	0.274	0.298
	LTE Band 19/36RB#0 15M	Left Side	24075	21.64	22.00	1.086	0.028	0.030
	LTE Band 19/36RB#0 15M	Right Side	24075	21.64	22.00	1.086	0.018	0.020
	LTE Band 19/36RB#0 15M	Bottom Side	24075	21.64	22.00	1.086	0.163	0.177



Plot No.	Band/Mode	Test Position	CH.	Ave. Power (dBm)	Tune-up Limit (dBm)	Tune-up Scaling Factor	Meas. SAR1g (W/kg)	Reported SAR1g (W/kg)
Top Ant.								
	LTE Band 25/1RB#0 20M	Front Side	26365	15.28	15.50	1.052	0.186	0.196
	LTE Band 25/1RB#0 20M	Back Side	26365	15.28	15.50	1.052	0.209	0.220
	LTE Band 25/1RB#0 20M	Left Side	26365	15.28	15.50	1.052	0.040	0.042
	LTE Band 25/1RB#0 20M	Right Side	26365	15.28	15.50	1.052	0.033	0.035
	LTE Band 25/1RB#0 20M	Top Side	26365	15.28	15.50	1.052	0.365	0.384
Bottom Ant.								
	LTE Band 25/50RB#24 20M	Front Side	26365	14.38	14.50	1.028	0.139	0.143
	LTE Band 25/50RB#24 20M	Back Side	26365	14.38	14.50	1.028	0.160	0.164
	LTE Band 25/50RB#24 20M	Left Side	26365	14.38	14.50	1.028	0.033	0.034
	LTE Band 25/50RB#24 20M	Right Side	26365	14.38	14.50	1.028	0.028	0.029
	LTE Band 25/50RB#24 20M	Top Side	26365	14.38	14.50	1.028	0.292	0.300
Bottom Ant.								
	LTE Band 25/1RB#0 20M	Front Side	26365	20.23	20.50	1.064	0.438	0.466
	LTE Band 25/1RB#0 20M	Back Side	26365	20.23	20.50	1.064	0.519	0.552
	LTE Band 25/1RB#0 20M	Left Side	26365	20.23	20.50	1.064	0.104	0.111
	LTE Band 25/1RB#0 20M	Right Side	26365	20.23	20.50	1.064	0.077	0.082
	LTE Band 25/1RB#0 20M	Bottom Side	26365	20.23	20.50	1.064	0.843	0.897
	LTE Band 25/1RB#0 20M	Bottom Side	26140	19.93	20.50	1.140	0.674	0.769
73#	LTE Band 25/1RB#0 20M	Bottom Side	26590	19.89	20.50	1.151	0.933	1.074
	LTE Band 25/100RB#0 20M	Bottom Side	26590	19.27	19.50	1.054	0.423	0.446
Bottom Ant.								
	LTE Band 25/50RB#24 20M	Front Side	26365	19.33	19.50	1.040	0.363	0.377
	LTE Band 25/50RB#24 20M	Back Side	26365	19.33	19.50	1.040	0.433	0.450
	LTE Band 25/50RB#24 20M	Left Side	26365	19.33	19.50	1.040	0.081	0.084
	LTE Band 25/50RB#24 20M	Right Side	26365	19.33	19.50	1.040	0.063	0.066
	LTE Band 25/50RB#24 20M	Bottom Side	26365	19.33	19.50	1.040	0.696	0.724



Plot No.	Band/Mode	Test Position	CH.	Ave. Power (dBm)	Tune-up Limit (dBm)	Tune-up Scaling Factor	Meas. SAR1g (W/kg)	Reported SAR1g (W/kg)
Top Ant.								
	LTE Band 26/1RB#0 15M	Front Side	26965	21.36	21.50	1.033	0.276	0.285
	LTE Band 26/1RB#0 15M	Back Side	26965	21.36	21.50	1.033	0.285	0.294
	LTE Band 26/1RB#0 15M	Left Side	26965	21.36	21.50	1.033	0.048	0.050
	LTE Band 26/1RB#0 15M	Right Side	26965	21.36	21.50	1.033	0.111	0.115
	LTE Band 26/1RB#0 15M	Top Side	26965	21.36	21.50	1.033	0.162	0.167
Bottom Ant.								
	LTE Band 26/36RB#0 15M	Front Side	26965	20.33	20.50	1.040	0.199	0.207
	LTE Band 26/36RB#0 15M	Back Side	26965	20.33	20.50	1.040	0.233	0.242
	LTE Band 26/36RB#0 15M	Left Side	26965	20.33	20.50	1.040	0.030	0.031
	LTE Band 26/36RB#0 15M	Right Side	26965	20.33	20.50	1.040	0.076	0.079
	LTE Band 26/36RB#0 15M	Top Side	26965	20.33	20.50	1.040	0.115	0.120
Bottom Ant.								
	LTE Band 26/1RB#0 15M	Front Side	26965	22.82	23.00	1.042	0.212	0.221
74#	LTE Band 26/1RB#0 15M	Back Side	26965	22.82	23.00	1.042	0.303	0.316
	LTE Band 26/1RB#0 15M	Left Side	26965	22.82	23.00	1.042	0.042	0.044
	LTE Band 26/1RB#0 15M	Right Side	26965	22.82	23.00	1.042	0.100	0.104
	LTE Band 26/1RB#0 15M	Bottom Side	26965	22.82	23.00	1.042	0.183	0.191
Bottom Ant.								
	LTE Band 26/36RB#0 15M	Front Side	26965	21.79	22.00	1.050	0.179	0.188
	LTE Band 26/36RB#0 15M	Back Side	26965	21.79	22.00	1.050	0.255	0.268
	LTE Band 26/36RB#0 15M	Left Side	26965	21.79	22.00	1.050	0.032	0.034
	LTE Band 26/36RB#0 15M	Right Side	26965	21.79	22.00	1.050	0.091	0.096
	LTE Band 26/36RB#0 15M	Bottom Side	26965	21.79	22.00	1.050	0.149	0.156



Plot No.	Band/Mode	Test Position	CH.	Ave. Power (dBm)	Tune-up Limit (dBm)	Tune-up Scaling Factor	Meas. SAR1g (W/kg)	Reported SAR1g (W/kg)
Top Ant.								
	LTE Band 30/1RB#0 10M	Front Side	27710	17.40	17.50	1.023	0.274	0.280
	LTE Band 30/1RB#0 10M	Back Side	27710	17.40	17.50	1.023	0.377	0.386
	LTE Band 30/1RB#0 10M	Left Side	27710	17.40	17.50	1.023	0.047	0.048
	LTE Band 30/1RB#0 10M	Right Side	27710	17.40	17.50	1.023	0.025	0.025
	LTE Band 30/1RB#0 10M	Top Side	27710	17.40	17.50	1.023	0.674	0.690
Bottom Ant.								
	LTE Band 30/25RB#12 10M	Front Side	27710	16.40	16.50	1.023	0.218	0.223
	LTE Band 30/25RB#12 10M	Back Side	27710	16.40	16.50	1.023	0.305	0.312
	LTE Band 30/25RB#12 10M	Left Side	27710	16.40	16.50	1.023	0.040	0.040
	LTE Band 30/25RB#12 10M	Right Side	27710	16.40	16.50	1.023	0.021	0.022
	LTE Band 30/25RB#12 10M	Top Side	27710	16.40	16.50	1.023	0.555	0.568
Bottom Ant.								
	LTE Band 30/1RB#0 10M	Front Side	27710	21.57	22.00	1.104	0.317	0.350
	LTE Band 30/1RB#0 10M	Back Side	27710	21.57	22.00	1.104	0.444	0.490
	LTE Band 30/1RB#0 10M	Left Side	27710	21.57	22.00	1.104	0.133	0.147
	LTE Band 30/1RB#0 10M	Right Side	27710	21.57	22.00	1.104	0.032	0.036
75#	LTE Band 30/1RB#0 10M	Bottom Side	27710	21.57	22.00	1.104	0.981	1.083
Bottom Ant.								
	LTE Band 30/25RB#12 10M	Front Side	27710	20.57	21.00	1.104	0.259	0.286
	LTE Band 30/25RB#12 10M	Back Side	27710	20.57	21.00	1.104	0.357	0.394
	LTE Band 30/25RB#12 10M	Left Side	27710	20.57	21.00	1.104	0.115	0.127
	LTE Band 30/25RB#12 10M	Right Side	27710	20.57	21.00	1.104	0.029	0.032
	LTE Band 30/25RB#12 10M	Bottom Side	27710	20.57	21.00	1.104	0.796	0.879



Plot No.	Band/Mode	Test Position	CH.	Ave. Power (dBm)	Tune-up Limit (dBm)	Tune-up Scaling Factor	Meas. SAR1g (W/kg)	Reported SAR1g (W/kg)
Top Ant.								
	LTE Band 66/1RB#0 20M	Front Side	132572	17.86	18.00	1.033	0.160	0.165
	LTE Band 66/1RB#0 20M	Back Side	132572	17.86	18.00	1.033	0.169	0.175
	LTE Band 66/1RB#0 20M	Left Side	132572	17.86	18.00	1.033	0.025	0.026
	LTE Band 66/1RB#0 20M	Right Side	132572	17.86	18.00	1.033	0.017	0.017
	LTE Band 66/1RB#0 20M	Top Side	132572	17.86	18.00	1.033	0.306	0.316
Bottom Ant.								
	LTE Band 66/50RB#0 20M	Front Side	132572	16.83	17.00	1.040	0.113	0.118
	LTE Band 66/50RB#0 20M	Back Side	132572	16.83	17.00	1.040	0.140	0.146
	LTE Band 66/50RB#0 20M	Left Side	132572	16.83	17.00	1.040	0.022	0.023
	LTE Band 66/50RB#0 20M	Right Side	132572	16.83	17.00	1.040	0.019	0.020
	LTE Band 66/50RB#0 20M	Top Side	132572	16.83	17.00	1.040	0.237	0.246
Bottom Ant.								
	LTE Band 66/1RB#0 20M	Front Side	132572	22.72	23.00	1.067	0.536	0.572
	LTE Band 66/1RB#0 20M	Back Side	132572	22.72	23.00	1.067	0.633	0.675
	LTE Band 66/1RB#0 20M	Left Side	132572	22.72	23.00	1.067	0.140	0.149
	LTE Band 66/1RB#0 20M	Right Side	132572	22.72	23.00	1.067	0.114	0.122
	LTE Band 66/1RB#0 20M	Bottom Side	132572	22.72	23.00	1.067	0.995	1.061
76#	LTE Band 66/1RB#0 20M	Bottom Side	132322	22.31	23.00	1.172	0.974	1.142
	LTE Band 66/1RB#0 20M	Bottom Side	132072	22.37	23.00	1.156	0.950	1.098
	LTE Band 66/100RB#0 20M	Bottom Side	132322	21.60	22.00	1.096	0.516	0.566
Bottom Ant.								
	LTE Band 66/50RB#0 20M	Front Side	132572	21.69	22.00	1.074	0.437	0.469
	LTE Band 66/50RB#0 20M	Back Side	132572	21.69	22.00	1.074	0.523	0.562
	LTE Band 66/50RB#0 20M	Left Side	132572	21.69	22.00	1.074	0.113	0.121
	LTE Band 66/50RB#0 20M	Right Side	132572	21.69	22.00	1.074	0.093	0.100
	LTE Band 66/50RB#0 20M	Bottom Side	132572	21.69	22.00	1.074	0.849	0.912
	LTE Band 66/50RB#0 20M	Bottom Side	132322	21.67	22.00	1.079	0.818	0.883
	LTE Band 66/50RB#0 20M	Bottom Side	132072	21.55	22.00	1.109	0.798	0.885



➤ TDD-LTE QPSK Hotspot SAR

Plot No.	Band/Mode	Test Position	CH.	Ave. Power (dBm)	Tune-up Limit (dBm)	Tune-up Scaling Factor	Meas. SAR1g (W/kg)	Reported SAR1g (W/kg)
Top Ant.								
	LTE Band 38/1RB#0 20M	Front Side	38150	19.37	19.50	1.030	0.076	0.079
	LTE Band 38/1RB#0 20M	Back Side	38150	19.37	19.50	1.030	0.105	0.109
	LTE Band 38/1RB#0 20M	Left Side	38150	19.37	19.50	1.030	0.028	0.029
	LTE Band 38/1RB#0 20M	Right Side	38150	19.37	19.50	1.030	0.019	0.020
	LTE Band 38/1RB#0 20M	Top Side	38150	19.37	19.50	1.030	0.225	0.233
Bottom Ant.								
	LTE Band 38/50RB#0 20M	Front Side	38150	18.56	19.00	1.107	0.060	0.067
	LTE Band 38/50RB#0 20M	Back Side	38150	18.56	19.00	1.107	0.087	0.097
	LTE Band 38/50RB#0 20M	Left Side	38150	18.56	19.00	1.107	0.026	0.028
	LTE Band 38/50RB#0 20M	Right Side	38150	18.56	19.00	1.107	0.012	0.013
	LTE Band 38/50RB#0 20M	Top Side	38150	18.56	19.00	1.107	0.183	0.204
Bottom Ant.								
	LTE Band 38/1RB#0 20M	Front Side	38150	22.94	23.50	1.138	0.159	0.182
	LTE Band 38/1RB#0 20M	Back Side	38150	22.94	23.50	1.138	0.176	0.201
	LTE Band 38/1RB#0 20M	Left Side	38150	22.94	23.50	1.138	0.059	0.068
	LTE Band 38/1RB#0 20M	Right Side	38150	22.94	23.50	1.138	0.030	0.034
77#	LTE Band 38/1RB#0 20M	Bottom Side	38150	22.94	23.50	1.138	0.254	0.291
Bottom Ant.								
	LTE Band 38/50RB#0 20M	Front Side	38150	22.10	22.50	1.096	0.131	0.145
	LTE Band 38/50RB#0 20M	Back Side	38150	22.10	22.50	1.096	0.154	0.170
	LTE Band 38/50RB#0 20M	Left Side	38150	22.10	22.50	1.096	0.049	0.054
	LTE Band 38/50RB#0 20M	Right Side	38150	22.10	22.50	1.096	0.021	0.023
	LTE Band 38/50RB#0 20M	Bottom Side	38150	22.10	22.50	1.096	0.206	0.227



Plot No.	Band/Mode	Test Position	CH.	Ave. Power (dBm)	Tune-up Limit (dBm)	Tune-up Scaling Factor	Meas. SAR1g (W/kg)	Reported SAR1g (W/kg)
Top Ant.								
	LTE Band 40A/1RB#0 10M	Front Side	38750	19.66	20.00	1.081	0.191	0.208
	LTE Band 40A/1RB#0 10M	Back Side	38750	19.66	20.00	1.081	0.216	0.235
	LTE Band 40A/1RB#0 10M	Left Side	38750	19.66	20.00	1.081	0.029	0.031
	LTE Band 40A/1RB#0 10M	Right Side	38750	19.66	20.00	1.081	0.019	0.020
	LTE Band 40A/1RB#0 10M	Top Side	38750	19.66	20.00	1.081	0.522	0.568
Bottom Ant.								
	LTE Band 40A/25RB#0 10M	Front Side	38750	18.78	19.00	1.052	0.155	0.164
	LTE Band 40A/25RB#0 10M	Back Side	38750	18.78	19.00	1.052	0.178	0.188
	LTE Band 40A/25RB#0 10M	Left Side	38750	18.78	19.00	1.052	0.026	0.027
	LTE Band 40A/25RB#0 10M	Right Side	38750	18.78	19.00	1.052	0.016	0.017
	LTE Band 40A/25RB#0 10M	Top Side	38750	18.78	19.00	1.052	0.442	0.468
Bottom Ant.								
	LTE Band 40A/1RB#0 10M	Front Side	38750	22.66	23.00	1.081	0.178	0.194
	LTE Band 40A/1RB#0 10M	Back Side	38750	22.66	23.00	1.081	0.253	0.275
	LTE Band 40A/1RB#0 10M	Left Side	38750	22.66	23.00	1.081	0.073	0.079
	LTE Band 40A/1RB#0 10M	Right Side	38750	22.66	23.00	1.081	0.023	0.025
78#	LTE Band 40A/1RB#0 10M	Bottom Side	38750	22.66	23.00	1.081	0.534	0.581
Bottom Ant.								
	LTE Band 40A/25RB#0 10M	Front Side	38750	21.78	22.00	1.052	0.146	0.155
	LTE Band 40A/25RB#0 10M	Back Side	38750	21.78	22.00	1.052	0.210	0.222
	LTE Band 40A/25RB#0 10M	Left Side	38750	21.78	22.00	1.052	0.061	0.065
	LTE Band 40A/25RB#0 10M	Right Side	38750	21.78	22.00	1.052	0.016	0.017
	LTE Band 40A/25RB#0 10M	Bottom Side	38750	21.78	22.00	1.052	0.413	0.437



Plot No.	Band/Mode	Test Position	CH.	Ave. Power (dBm)	Tune-up Limit (dBm)	Tune-up Scaling Factor	Meas. SAR1g (W/kg)	Reported SAR1g (W/kg)
Top Ant.								
	LTE Band 40B/1RB#25 10M	Front Side	39200	19.77	20.00	1.054	0.168	0.178
	LTE Band 40B/1RB#25 10M	Back Side	39200	19.77	20.00	1.054	0.193	0.205
	LTE Band 40B/1RB#25 10M	Left Side	39200	19.77	20.00	1.054	0.030	0.031
	LTE Band 40B/1RB#25 10M	Right Side	39200	19.77	20.00	1.054	0.020	0.021
	LTE Band 40B/1RB#25 10M	Top Side	39200	19.77	20.00	1.054	0.409	0.434
Bottom Ant.								
	LTE Band 40B/25RB#0 10M	Front Side	39200	18.79	19.00	1.050	0.139	0.147
	LTE Band 40B/25RB#0 10M	Back Side	39200	18.79	19.00	1.050	0.161	0.170
	LTE Band 40B/25RB#0 10M	Left Side	39200	18.79	19.00	1.050	0.025	0.027
	LTE Band 40B/25RB#0 10M	Right Side	39200	18.79	19.00	1.050	0.017	0.018
	LTE Band 40B/25RB#0 10M	Top Side	39200	18.79	19.00	1.050	0.307	0.324
Bottom Ant.								
	LTE Band 40B/1RB#25 10M	Front Side	39200	22.77	23.00	1.054	0.178	0.189
	LTE Band 40B/1RB#25 10M	Back Side	39200	22.77	23.00	1.054	0.258	0.274
	LTE Band 40B/1RB#25 10M	Left Side	39200	22.77	23.00	1.054	0.086	0.091
	LTE Band 40B/1RB#25 10M	Right Side	39200	22.77	23.00	1.054	0.023	0.024
79#	LTE Band 40B/1RB#25 10M	Bottom Side	39200	22.77	23.00	1.054	0.488	0.518
Bottom Ant.								
	LTE Band 40B/25RB#0 10M	Front Side	39200	21.79	22.00	1.050	0.146	0.154
	LTE Band 40B/25RB#0 10M	Back Side	39200	21.79	22.00	1.050	0.211	0.223
	LTE Band 40B/25RB#0 10M	Left Side	39200	21.79	22.00	1.050	0.070	0.074
	LTE Band 40B/25RB#0 10M	Right Side	39200	21.79	22.00	1.050	0.018	0.019
	LTE Band 40B/25RB#0 10M	Bottom Side	39200	21.79	22.00	1.050	0.411	0.434



Plot No.	Band/Mode	Test Position	CH.	Ave. Power (dBm)	Tune-up Limit (dBm)	Tune-up Scaling Factor	Meas. SAR1g (W/kg)	Reported SAR1g (W/kg)
Top Ant.								
	LTE Band 41/1RB#99 20M	Front Side	40340	19.30	19.50	1.047	0.067	0.071
	LTE Band 41/1RB#99 20M	Back Side	40340	19.30	19.50	1.047	0.099	0.104
	LTE Band 41/1RB#99 20M	Left Side	40340	19.30	19.50	1.047	0.028	0.030
	LTE Band 41/1RB#99 20M	Right Side	40340	19.30	19.50	1.047	0.020	0.021
	LTE Band 41/1RB#99 20M	Top Side	40340	19.30	19.50	1.047	0.224	0.236
Bottom Ant.								
	LTE Band 41/50RB#0 20M	Front Side	40340	18.37	18.50	1.030	0.057	0.059
	LTE Band 41/50RB#0 20M	Back Side	40340	18.37	18.50	1.030	0.084	0.087
	LTE Band 41/50RB#0 20M	Left Side	40340	18.37	18.50	1.030	0.025	0.026
	LTE Band 41/50RB#0 20M	Right Side	40340	18.37	18.50	1.030	0.017	0.018
	LTE Band 41/50RB#0 20M	Top Side	40340	18.37	18.50	1.030	0.198	0.205
Bottom Ant.								
	LTE Band 41/1RB#99 20M	Front Side	40340	22.94	23.50	1.138	0.146	0.167
	LTE Band 41/1RB#99 20M	Back Side	40340	22.94	23.50	1.138	0.202	0.231
	LTE Band 41/1RB#99 20M	Left Side	40340	22.94	23.50	1.138	0.062	0.071
	LTE Band 41/1RB#99 20M	Right Side	40340	22.94	23.50	1.138	0.020	0.023
80#	LTE Band 41/1RB#99 20M	Bottom Side	40340	22.94	23.50	1.138	0.247	0.283
Bottom Ant.								
	LTE Band 41/50RB#0 20M	Front Side	40340	22.15	22.50	1.084	0.121	0.132
	LTE Band 41/50RB#0 20M	Back Side	40340	22.15	22.50	1.084	0.180	0.196
	LTE Band 41/50RB#0 20M	Left Side	40340	22.15	22.50	1.084	0.053	0.057
	LTE Band 41/50RB#0 20M	Right Side	40340	22.15	22.50	1.084	0.018	0.020
	LTE Band 41/50RB#0 20M	Bottom Side	40340	22.15	22.50	1.084	0.222	0.242

Note: The LTE TDD Reported 1g SAR (W/kg) has been calculated together with the duty cycle scaling factor.

**WLAN Hotspot SAR**

Plot No.	Band/Mode	Test Position	CH.	Ave. Power (dBm)	Tune-up Limit (dBm)	Tune-up Scaling Factor	Meas. SAR1g (W/kg)	Reported SAR1g (W/kg)
Ant.0								
	WLAN2.4GHz/802.11b	Front Side	1	14.67	15.00	1.079	0.064	0.070
81#	WLAN2.4GHz/802.11b	Back Side	1	14.67	15.00	1.079	0.070	0.076
	WLAN2.4GHz/802.11b	Right Side	1	14.67	15.00	1.079	0.024	0.026
	WLAN2.4GHz/802.11b	Top Side	1	14.67	15.00	1.079	0.043	0.047
Ant.1								
1	WLAN2.4GHz/802.11b	Front Side	11	13.61	14.00	1.094	0.011	0.013
	WLAN2.4GHz/802.11b	Back Side	11	13.61	14.00	1.094	0.036	0.039
	WLAN2.4GHz/802.11b	Left Side	11	13.61	14.00	1.094	0.022	0.024
	WLAN2.4GHz/802.11b	Top Side	11	13.61	14.00	1.094	0.013	0.014

Note: The WLAN Reported 1g SAR (W/kg) has been calculated together with the duty cycle scaling factor.

Bluetooth Hotspot SAR

Plot No.	Band/Mode	Test Position	CH.	Ave. Power (dBm)	Tune-up Limit (dBm)	Tune-up Scaling Factor	Meas. SAR1g (W/kg)	Reported SAR1g (W/kg)
	Bluetooth/1Mbps	Front Side	0	13.25	13.50	1.059	0.019	0.026
82#	Bluetooth/1Mbps	Back Side	0	13.25	13.50	1.059	0.021	0.028
	Bluetooth/1Mbps	Right Side	0	13.25	13.50	1.059	0.011	0.015
	Bluetooth/1Mbps	Top Side	0	13.25	13.50	1.059	0.016	0.021

Note: The Bluetooth Reported 1g SAR (W/kg) has been calculated together with the duty cycle scaling factor.



17.5. Repeated SAR Measurement

In accordance with published RF Exposure KDB procedure 865664 D01 SAR measurement 100 MHz to 6 GHz. These additional measurements are repeated after the completion of all measurements requiring the same head or body tissue-equivalent medium in a frequency band. The test device should be returned to ambient conditions (normal room temperature) with the battery fully charged before it is re-mounted on the device holder for the repeated measurement(s) to minimize any unexpected variations in the repeated results.

- 1) Repeated measurement is not required when the original highest measured SAR is < 0.80 W/kg; steps 2) through 4) do not apply.
- 2) When the original highest measured SAR is ≥ 0.80 W/kg, repeat that measurement once.
- 3) Perform a second repeated measurement only if the ratio of largest to smallest SAR for the original and first repeated measurements is > 1.20 or when the original or repeated measurement is ≥ 1.45 W/kg (~ 10% from the 1-g SAR limit).
- 4) Perform a third repeated measurement only if the original, first or second repeated measurement is ≥ 1.5 W/kg and the ratio of largest to smallest SAR for the original, first and second repeated measurements is > 1.20 .



➤ **Head Repeated SAR**

Plot No.	Band/Mode	Test Position	CH.	Ave. Power (dBm)	Tune-up Limit (dBm)	Tune-up Scaling Factor	Meas. SAR1g (W/kg)	Reported SAR1g (W/kg)
OR	GPRS850/3TX slots	Right Cheek	189	26.70	27.00	1.072	0.923	0.989
	GPRS850/3TX slots	Right Cheek	189	26.70	27.00	1.072	0.920	0.986
OR	GPRS1900/2TX slots	Right Tilt	512	22.61	23.00	1.094	0.889	0.973
	GPRS1900/2TX slots	Right Tilt	512	22.61	23.00	1.094	0.883	0.966
OR	Band II/RMC	Left Tilt	9538	16.01	16.50	1.119	0.929	1.040
	Band II/RMC	Left Tilt	9538	16.01	16.50	1.119	0.925	1.035
OR	BC0/RC3 SO55	Right Cheek	384	23.84	24.00	1.038	0.830	0.861
	BC0/RC3 SO55	Right Cheek	384	23.84	24.00	1.038	0.827	0.858
OR	LTE Band 2/1RB#99 20M	Left Tilt	18900	15.33	15.50	1.040	0.910	0.946
	LTE Band 2/1RB#99 20M	Left Tilt	18900	15.33	15.50	1.040	0.907	0.943
OR	LTE Band 7/1RB#49 20M	Right Cheek	20850	19.14	19.50	1.086	1.070	1.162
	LTE Band 7/1RB#49 20M	Right Cheek	20850	19.14	19.50	1.086	1.008	1.095
OR	LTE Band 19/1RB#0 15M	Right Cheek	24075	21.00	21.50	1.122	0.823	0.923
	LTE Band 19/1RB#0 15M	Right Cheek	24075	21.00	21.50	1.122	0.820	0.920
OR	LTE Band 25/1RB#0 20M	Left Tilt	26365	15.28	15.50	1.052	0.986	1.037
	LTE Band 25/1RB#0 20M	Left Tilt	26365	15.28	15.50	1.052	0.980	1.031
OR	LTE Band 30/1RB#0 10M	Right Cheek	27710	17.40	17.50	1.023	0.885	0.906
	LTE Band 30/1RB#0 10M	Right Cheek	27710	17.40	17.50	1.023	0.880	0.900
OR	LTE Band 66/1RB#0 20M	Right Tilt	132572	17.86	18.00	1.033	0.862	0.890
	LTE Band 66/1RB#0 20M	Right Tilt	132572	17.86	18.00	1.033	0.862	0.890



➤ Hotspot Repeated SAR

Plot No.	Band/Mode	Test Position	CH.	Ave. Power (dBm)	Tune-up Limit (dBm)	Tune-up Scaling Factor	Meas. SAR1g (W/kg)	Reported SAR1g (W/kg)
OR	GPRS1900/2TX slots	Bottom Side	810	25.02	25.50	1.117	0.824	0.920
	GPRS1900/2TX slots	Bottom Side	810	25.02	25.50	1.117	0.822	0.918
OR	Band II/RMC	Bottom Side	9538	19.83	20.00	1.040	0.952	0.990
	Band II/RMC	Bottom Side	9538	19.83	20.00	1.040	0.949	0.987
OR	Band IV/RMC	Bottom Side	1513	21.23	21.50	1.064	0.847	0.901
	Band IV/RMC	Bottom Side	1312	20.87	21.50	1.156	0.796	0.920
OR	LTE Band 2/1RB#99 20M	Bottom Side	19100	19.80	20.00	1.047	0.898	0.940
	LTE Band 2/1RB#99 20M	Bottom Side	19100	19.80	20.00	1.047	0.895	0.937
OR	LTE Band 4/1RB#0 20M	Bottom Side	20175	20.64	21.00	1.086	0.947	1.029
	LTE Band 4/1RB#0 20M	Bottom Side	20175	20.64	21.00	1.086	0.944	1.026
OR	LTE Band 7/1RB#49 20M	Bottom Side	21100	22.87	23.00	1.030	1.120	1.154
	LTE Band 7/1RB#49 20M	Bottom Side	21100	22.87	23.00	1.030	1.115	1.149
OR	LTE Band 25/1RB#0 20M	Bottom Side	26590	19.89	20.50	1.151	0.933	1.074
	LTE Band 25/1RB#0 20M	Bottom Side	26590	19.89	20.50	1.151	0.931	1.071
OR	LTE Band 30/1RB#0 10M	Bottom Side	27710	21.57	22.00	1.104	0.981	1.083
	LTE Band 30/1RB#0 10M	Bottom Side	27710	21.57	22.00	1.104	0.979	1.081
OR	LTE Band 66/1RB#0 20M	Bottom Side	132322	22.31	23.00	1.172	0.974	1.142
	LTE Band 66/1RB#0 20M	Bottom Side	132322	22.31	23.00	1.172	0.970	1.137

18. Simultaneous Transmission Evaluation

➤ Simultaneous Evaluation:

No.	Simultaneous Transmission Consideration	Head	Body-Worn	Hotspot
1	WWAN+WLAN 2.4GHz	Yes	Yes	Yes
2	WWAN+WLAN 5GHz	Yes	Yes	Yes
3	WWAN+Bluetooth	NO	Yes	Yes
4	WLAN 2.4GHz+Bluetooth	NO	Yes	Yes
5	WLAN 5GHz+Bluetooth	NO	Yes	Yes
6	WLAN 2.4GHz Ant 0+WLAN 2.4GHz Ant 1	Yes	Yes	Yes
7	WLAN 5GHz Ant 0+WLAN 5GHz Ant 1	Yes	Yes	Yes
8	WWAN+WLAN 2.4GHz(MIMO)	Yes	Yes	Yes
9	WWAN+WLAN 5GHz(MIMO)	NO	Yes	NO
10	WWAN+WLAN 2.4GHz(MIMO)+Bluetooth	NO	Yes	NO
11	WWAN+WLAN 5GHz(MIMO)+Bluetooth	NO	Yes	NO

Note:

- When the user enables the personal wireless router functions for the handset, actual operations include simultaneous transmission of both the Wi-Fi transmitter and another WWAN transmitter. Both transmitter often do not transmit at the same transmitting frequency and thus cannot be evaluated for SAR under actual use conditions. The "Portable Hotspot" feature on the handset was NOT activated, to ensure the SAR measurements were evaluated for a single transmission frequency RF signal.
- The hotspot SAR result may overlap with the body-worn accessory SAR requirements, per KDB 941225 D06, the more conservative configurations can be considered, thus excluding some unnecessary body-worn accessory SAR tests.
- GSM supports voice and data transmission, though not simultaneously. WCDMA supports voice and data transmission simultaneously.
- Simultaneous Transmission SAR evaluation is not required for BT and Wi-Fi, because the software mechanism have been incorporated to guarantee that the WLAN and Bluetooth transmitters would not simultaneously operate.
- Per KDB 447498D01v06, Simultaneous Transmission SAR Evaluation procedures is as followed:
 Step 1: If sum of 1 g SAR < 1.6 W/kg, Simultaneous SAR measurement is not required.
 Step 2: If sum of 1 g SAR > 1.6 W/kg, ratio of SAR to peak separation distance for pair of transmitters calculated.
 Step 3: If the ratio of SAR to peak separation distance is ≤ 0.04 , Simultaneous SAR measurement is not required.
 Step 4: If the ratio of SAR to peak separation distance is > 0.04 , Simultaneous SAR measurement is required and simultaneous transmission SAR value is calculated.
 (The ratio is determined by: $(SAR1 + SAR2) \wedge 1.5/Ri \leq 0.04$,



Ri is the separation distance between the peak SAR locations for the antenna pair in mm.

6. 2.4G&5G MIMO SAR was combined standalone SAR of antenna 0 and antenna 1.
7. According to the user manual, when the cellphone in the call state, it will intelligently select one of the 5G WIFI antennas to work, therefore simultaneous transmission of WWAN+5GHz WLAN (MIMO) is not required in this report.

➤ **Head Simultaneous Transmission for WWAN+ 2.4GHz/5GHz WLAN**

WWAN Band		Exposure Position	1	2	3	1+2 Summed 1g SAR (W/kg)	1+3 Summed 1g SAR (W/kg)	
			WWAN	2.4GHz WLAN	5GHz WLAN			
			1g SAR (W/kg)	1g SAR (W/kg)	1g SAR (W/kg)			
GSM	GSM850	Right Cheek	0.989	0.251	0.243	1.240	1.232	
		Right Tilt	0.710	0.281	0.258	0.991	0.968	
		Left Cheek	0.679	0.410	0.556	1.089	1.235	
		Left Tilt	0.556	0.489	0.526	1.045	1.082	
	GSM1900	Right Cheek	0.798	0.251	0.243	1.049	1.041	
		Right Tilt	0.973	0.281	0.258	1.254	1.231	
		Left Cheek	0.750	0.410	0.556	1.160	1.306	
		Left Tilt	0.965	0.489	0.526	1.454	1.491	
WCDMA	WCDMA Band II	Right Cheek	0.885	0.251	0.243	1.136	1.128	
		Right Tilt	0.932	0.281	0.258	1.213	1.190	
		Left Cheek	1.038	0.410	0.556	1.448	1.594	
		Left Tilt	1.040	0.489	0.526	1.529	1.566	
	WCDMA Band IV	Right Cheek	0.663	0.251	0.243	0.914	0.906	
		Right Tilt	0.773	0.281	0.258	1.054	1.031	
		Left Cheek	0.622	0.410	0.556	1.032	1.178	
		Left Tilt	0.748	0.489	0.526	1.237	1.274	
	WCDMA Band V	Right Cheek	0.667	0.251	0.243	0.918	0.910	
		Right Tilt	0.519	0.281	0.258	0.800	0.777	
		Left Cheek	0.484	0.410	0.556	0.894	1.040	
		Left Tilt	0.418	0.489	0.526	0.907	0.944	
	CDMA	CDMA200 0 BC0	Right Cheek	0.861	0.251	0.243	1.112	1.104
			Right Tilt	0.645	0.281	0.258	0.926	0.903
			Left Cheek	0.669	0.410	0.556	1.079	1.225
			Left Tilt	0.562	0.489	0.526	1.051	1.088
CDMA200 0 BC1		Right Cheek	0.636	0.251	0.243	0.887	0.879	
		Right Tilt	0.721	0.281	0.258	1.002	0.979	
		Left Cheek	0.596	0.410	0.556	1.006	1.152	



		Left Tilt	0.724	0.489	0.526	1.213	1.250
LTE	LTE Band 2	Right Cheek	0.779	0.251	0.243	1.030	1.022
		Right Tilt	0.892	0.281	0.258	1.173	1.150
		Left Cheek	0.760	0.410	0.556	1.170	1.316
		Left Tilt	0.946	0.489	0.526	1.435	1.472
	LTE Band 4	Right Cheek	0.710	0.251	0.243	0.961	0.953
		Right Tilt	0.827	0.281	0.258	1.108	1.085
		Left Cheek	0.715	0.410	0.556	1.125	1.271
		Left Tilt	0.816	0.489	0.526	1.305	1.342
	LTE Band 5	Right Cheek	0.751	0.251	0.243	1.002	0.994
		Right Tilt	0.579	0.281	0.258	0.860	0.837
		Left Cheek	0.535	0.410	0.556	0.945	1.091
		Left Tilt	0.449	0.489	0.526	0.938	0.975
	LTE Band 7	Right Cheek	1.162	0.251	0.243	1.413	1.405
		Right Tilt	1.141	0.281	0.258	1.422	1.399
		Left Cheek	0.655	0.410	0.556	1.065	1.211
		Left Tilt	0.739	0.489	0.526	1.228	1.265
	LTE Band 12	Right Cheek	0.091	0.251	0.243	0.342	0.334
		Right Tilt	0.068	0.281	0.258	0.349	0.326
		Left Cheek	0.071	0.410	0.556	0.481	0.627
		Left Tilt	0.054	0.489	0.526	0.543	0.580
	LTE Band 17	Right Cheek	0.085	0.251	0.243	0.336	0.328
		Right Tilt	0.058	0.281	0.258	0.339	0.316
		Left Cheek	0.063	0.410	0.556	0.473	0.619
		Left Tilt	0.049	0.489	0.526	0.538	0.575
	LTE Band 18	Right Cheek	0.770	0.251	0.243	1.021	1.013
		Right Tilt	0.631	0.281	0.258	0.912	0.889
		Left Cheek	0.497	0.410	0.556	0.907	1.053
		Left Tilt	0.561	0.489	0.526	1.050	1.087
LTE Band 19	Right Cheek	0.923	0.251	0.243	1.174	1.166	
	Right Tilt	0.696	0.281	0.258	0.977	0.954	
	Left Cheek	0.699	0.410	0.556	1.109	1.255	
	Left Tilt	0.589	0.489	0.526	1.078	1.115	
LTE Band 25	Right Cheek	0.865	0.251	0.243	1.116	1.108	
	Right Tilt	0.947	0.281	0.258	1.228	1.205	
	Left Cheek	0.845	0.410	0.556	1.255	1.401	
	Left Tilt	1.037	0.489	0.526	1.526	1.563	
LTE Band	Right Cheek	0.754	0.251	0.243	1.005	0.997	



	26	Right Tilt	0.565	0.281	0.258	0.846	0.823
		Left Cheek	0.562	0.410	0.556	0.972	1.118
		Left Tilt	0.461	0.489	0.526	0.950	0.987
	LTE Band 30	Right Cheek	0.906	0.251	0.243	1.157	1.149
		Right Tilt	0.871	0.281	0.258	1.152	1.129
		Left Cheek	0.702	0.410	0.556	1.112	1.258
	LTE Band 38	Left Tilt	0.867	0.489	0.526	1.356	1.393
		Right Cheek	0.446	0.251	0.243	0.697	0.689
		Right Tilt	0.419	0.281	0.258	0.700	0.677
	LTE Band 38	Left Cheek	0.260	0.410	0.556	0.670	0.816
		Left Tilt	0.278	0.489	0.526	0.767	0.804
		Right Cheek	0.723	0.251	0.243	0.974	0.966
	LTE Band 40	Right Tilt	0.856	0.281	0.258	1.137	1.114
		Left Cheek	0.594	0.410	0.556	1.004	1.150
		Left Tilt	0.678	0.489	0.526	1.167	1.204
	LTE Band 41	Right Cheek	0.386	0.251	0.243	0.637	0.629
Right Tilt		0.406	0.281	0.258	0.687	0.664	
Left Cheek		0.243	0.410	0.556	0.653	0.799	
LTE Band 41	Left Tilt	0.268	0.489	0.526	0.757	0.794	
	Right Cheek	0.752	0.251	0.243	1.003	0.995	
	Right Tilt	0.890	0.281	0.258	1.171	1.148	
LTE Band 66	Left Cheek	0.677	0.410	0.556	1.087	1.233	
	Left Tilt	0.829	0.489	0.526	1.318	1.355	

➤ **Head Simultaneous Transmission for 2.4GHz/5GHz(MIMO)**

WWAN Band	Exposure Position	1	2	1+2 Summed 1g SAR (W/kg)
		Ant 0	Ant 1	
		1g SAR (W/kg)	1g SAR (W/kg)	
2.4GHz WLAN	Right Cheek	0.251	0.056	0.307
	Right Tilt	0.281	0.049	0.330
	Left Cheek	0.410	0.032	0.442
	Left Tilt	0.489	0.030	0.519
5.2GHz WLAN	Right Cheek	0.178	0.083	0.261
	Right Tilt	0.144	0.047	0.191
	Left Cheek	0.352	0.029	0.381
	Left Tilt	0.354	0.067	0.421
5.3GHz WLAN	Right Cheek	0.138	0.054	0.192



	Right Tilt	0.116	0.050	0.166
	Left Cheek	0.386	0.031	0.417
	Left Tilt	0.387	0.046	0.433
5.5GHz WLAN	Right Cheek	0.243	0.025	0.268
	Right Tilt	0.181	0.070	0.251
	Left Cheek	0.556	0.034	0.590
	Left Tilt	0.475	0.239	0.714
5.8GHz WLAN	Right Cheek	0.220	0.021	0.241
	Right Tilt	0.258	0.068	0.326
	Left Cheek	0.534	0.030	0.564
	Left Tilt	0.526	0.027	0.553

➤ **Head Simultaneous Transmission for WWAN+2.4GHz(MIMO)**

WWAN Band		Exposure Position	1	2	1+2 Summed 1g SAR (W/kg)
			WWAN 1g SAR (W/kg)	2.4GHz WLAN Ant 0+ Ant 1 1g SAR (W/kg)	
GSM	GSM850	Right Cheek	0.989	0.307	1.296
		Right Tilt	0.710	0.330	1.040
		Left Cheek	0.679	0.442	1.121
		Left Tilt	0.556	0.519	1.075
	GSM1900	Right Cheek	0.798	0.307	1.105
		Right Tilt	0.973	0.330	1.303
		Left Cheek	0.750	0.442	1.192
		Left Tilt	0.965	0.519	1.484
WCDMA	WCDMA Band II	Right Cheek	0.885	0.307	1.192
		Right Tilt	0.932	0.330	1.262
		Left Cheek	1.038	0.442	1.480
		Left Tilt	1.040	0.519	1.559
	WCDMA Band IV	Right Cheek	0.663	0.307	0.970
		Right Tilt	0.773	0.330	1.103
		Left Cheek	0.622	0.442	1.064
		Left Tilt	0.748	0.519	1.267
	WCDMA Band V	Right Cheek	0.667	0.307	0.974
		Right Tilt	0.519	0.330	0.849
		Left Cheek	0.484	0.442	0.926
		Left Tilt	0.418	0.519	0.937



CDMA	CDMA2000 BC0	Right Cheek	0.861	0.307	1.168
		Right Tilt	0.645	0.330	0.975
		Left Cheek	0.669	0.442	1.111
		Left Tilt	0.562	0.519	1.081
	CDMA2000 BC1	Right Cheek	0.636	0.307	0.943
		Right Tilt	0.721	0.330	1.051
		Left Cheek	0.596	0.442	1.038
		Left Tilt	0.724	0.519	1.243
LTE	LTE Band 2	Right Cheek	0.779	0.307	1.086
		Right Tilt	0.892	0.330	1.222
		Left Cheek	0.760	0.442	1.202
		Left Tilt	0.946	0.519	1.465
	LTE Band 4	Right Cheek	0.710	0.307	1.017
		Right Tilt	0.827	0.330	1.157
		Left Cheek	0.715	0.442	1.157
		Left Tilt	0.816	0.519	1.335
	LTE Band 5	Right Cheek	0.751	0.307	1.058
		Right Tilt	0.579	0.330	0.909
		Left Cheek	0.535	0.442	0.977
		Left Tilt	0.449	0.519	0.968
	LTE Band 7	Right Cheek	1.162	0.307	1.469
		Right Tilt	1.141	0.330	1.471
		Left Cheek	0.655	0.442	1.097
		Left Tilt	0.739	0.519	1.258
	LTE Band 12	Right Cheek	0.091	0.307	0.398
		Right Tilt	0.068	0.330	0.398
		Left Cheek	0.071	0.442	0.513
		Left Tilt	0.054	0.519	0.573
	LTE Band 17	Right Cheek	0.085	0.307	0.392
		Right Tilt	0.058	0.330	0.388
		Left Cheek	0.063	0.442	0.505
		Left Tilt	0.049	0.519	0.568
	LTE Band 18	Right Cheek	0.770	0.307	1.077
		Right Tilt	0.631	0.330	0.961
		Left Cheek	0.497	0.442	0.939
		Left Tilt	0.561	0.519	1.080
LTE Band 19	Right Cheek	0.923	0.307	1.230	
	Right Tilt	0.696	0.330	1.026	



		Left Cheek	0.699	0.442	1.141
		Left Tilt	0.589	0.519	1.108
	LTE Band 25	Right Cheek	0.865	0.307	1.172
		Right Tilt	0.947	0.330	1.277
		Left Cheek	0.845	0.442	1.287
		Left Tilt	1.037	0.519	1.556
	LTE Band 26	Right Cheek	0.754	0.307	1.061
		Right Tilt	0.565	0.330	0.895
		Left Cheek	0.562	0.442	1.004
		Left Tilt	0.461	0.519	0.980
	LTE Band 30	Right Cheek	0.906	0.307	1.213
		Right Tilt	0.871	0.330	1.201
		Left Cheek	0.702	0.442	1.144
		Left Tilt	0.867	0.519	1.386
	LTE Band 38	Right Cheek	0.446	0.307	0.753
		Right Tilt	0.419	0.330	0.749
		Left Cheek	0.260	0.442	0.702
		Left Tilt	0.278	0.519	0.797
	LTE Band 40	Right Cheek	0.723	0.307	1.030
		Right Tilt	0.856	0.330	1.186
Left Cheek		0.594	0.442	1.036	
Left Tilt		0.678	0.519	1.197	
LTE Band 41	Right Cheek	0.386	0.307	0.693	
	Right Tilt	0.406	0.330	0.736	
	Left Cheek	0.243	0.442	0.685	
	Left Tilt	0.268	0.519	0.787	
LTE Band 66	Right Cheek	0.752	0.307	1.059	
	Right Tilt	0.890	0.330	1.220	
	Left Cheek	0.677	0.442	1.119	
	Left Tilt	0.829	0.519	1.348	



➤ **Body-worn Simultaneous Transmission for WWAN+WLAN/BT**

WWAN Band		Exposure Position	1	2	3	4	1+2+3 Summed 1g SAR (W/kg)	1+3 Summed 1g SAR (W/kg)	1+4 Summed 1g SAR (W/kg)
			WWAN	2.4GHz WLAN Ant 1	5GHz WLAN Ant 1	Bluetooth			
			1g SAR (W/kg)	1g SAR (W/kg)	1g SAR (W/kg)	1g SAR (W/kg)			
GSM	GSM850	Front	0.313	0.070	0.141	0.026	0.383	0.454	0.339
		Back	0.468	0.076	0.388	0.028	0.544	0.856	0.496
	GSM1900	Front	0.296	0.070	0.141	0.026	0.366	0.437	0.322
		Back	0.418	0.076	0.388	0.028	0.494	0.806	0.446
WCDMA	WCDMA Band II	Front	0.371	0.070	0.141	0.026	0.441	0.512	0.397
		Back	0.455	0.076	0.388	0.028	0.531	0.843	0.483
	WCDMA Band IV	Front	0.473	0.070	0.141	0.026	0.543	0.614	0.499
		Back	0.498	0.076	0.388	0.028	0.574	0.886	0.526
	WCDMA Band V	Front	0.271	0.070	0.141	0.026	0.341	0.412	0.297
		Back	0.333	0.076	0.388	0.028	0.409	0.721	0.361
CDMA	CDMA200 0 BC0	Front	0.356	0.070	0.141	0.026	0.426	0.497	0.382
		Back	0.412	0.076	0.388	0.028	0.488	0.800	0.440
	CDMA200 0 BC1	Front	0.291	0.070	0.141	0.026	0.361	0.432	0.317
		Back	0.405	0.076	0.388	0.028	0.481	0.793	0.433
LTE	LTE Band 2	Front	0.391	0.070	0.141	0.026	0.461	0.532	0.417
		Back	0.463	0.076	0.388	0.028	0.539	0.851	0.491
	LTE Band 4	Front	0.537	0.070	0.141	0.026	0.607	0.678	0.563
		Back	0.645	0.076	0.388	0.028	0.721	1.033	0.673
	LTE Band 5	Front	0.302	0.070	0.141	0.026	0.372	0.443	0.328
		Back	0.304	0.076	0.388	0.028	0.380	0.692	0.332
	LTE Band 7	Front	0.527	0.070	0.141	0.026	0.597	0.668	0.553
		Back	0.775	0.076	0.388	0.028	0.851	1.163	0.803
	LTE Band 12	Front	0.119	0.070	0.141	0.026	0.189	0.260	0.145
		Back	0.136	0.076	0.388	0.028	0.212	0.524	0.164
	LTE Band 17	Front	0.124	0.070	0.141	0.026	0.194	0.265	0.150
		Back	0.147	0.076	0.388	0.028	0.223	0.535	0.175
	LTE Band 18	Front	0.237	0.070	0.141	0.026	0.307	0.378	0.263
		Back	0.315	0.076	0.388	0.028	0.391	0.703	0.343
LTE Band	Front	0.292	0.070	0.141	0.026	0.362	0.433	0.318	



	19	Back	0.359	0.076	0.388	0.028	0.435	0.747	0.387
	LTE Band 25	Front	0.466	0.070	0.141	0.026	0.536	0.607	0.492
		Back	0.552	0.076	0.388	0.028	0.628	0.940	0.580
	LTE Band 26	Front	0.285	0.070	0.141	0.026	0.355	0.426	0.311
		Back	0.316	0.076	0.388	0.028	0.392	0.704	0.344
	LTE Band 30	Front	0.350	0.070	0.141	0.026	0.420	0.491	0.376
		Back	0.490	0.076	0.388	0.028	0.566	0.878	0.518
	LTE Band 38	Front	0.182	0.070	0.141	0.026	0.252	0.323	0.208
		Back	0.201	0.076	0.388	0.028	0.277	0.589	0.229
	LTE Band 40	Front	0.208	0.070	0.141	0.026	0.278	0.349	0.234
		Back	0.275	0.076	0.388	0.028	0.351	0.663	0.303
	LTE Band 41	Front	0.167	0.070	0.141	0.026	0.237	0.308	0.193
		Back	0.231	0.076	0.388	0.028	0.307	0.619	0.259
	LTE Band 66	Front	0.572	0.070	0.141	0.026	0.642	0.713	0.598
		Back	0.675	0.076	0.388	0.028	0.751	1.063	0.703

➤ **Body-worn Simultaneous Transmission for 2.4GHz/5GHz WLAN**

WWAN Band	Exposure Position	1	2	1+2 Summed 1g SAR (W/kg)
		Ant 0	Ant 1	
		1g SAR (W/kg)	1g SAR (W/kg)	
2.4GHz WLAN	Front Side	0.070	0.013	0.083
	Back Side	0.076	0.039	0.115
5.2GHz WLAN	Front Side	0.101	0.051	0.152
	Back Side	0.122	0.073	0.195
5.3GHz WLAN	Front Side	0.112	0.014	0.126
	Back Side	0.168	0.101	0.269
5.5GHz WLAN	Front Side	0.123	0.034	0.157
	Back Side	0.228	0.370	0.598
5.8GHz WLAN	Front Side	0.141	0.021	0.162
	Back Side	0.200	0.388	0.588



➤ **Body-worn Simultaneous Transmission for WWAN + 2.4GHz WLAN (MIMO)**

WWAN Band		Exposure Position	1	2	1+2 Summed 1g SAR (W/kg)
			WWAN	2.4GHz WLAN Ant 0+ Ant 1	
			1g SAR (W/kg)	1g SAR (W/kg)	
GSM	GSM850	Front	0.313	0.083	0.396
		Back	0.468	0.115	0.583
	GSM1900	Front	0.296	0.083	0.379
		Back	0.418	0.115	0.533
WCDMA	WCDMA Band II	Front	0.371	0.083	0.454
		Back	0.455	0.115	0.570
	WCDMA Band IV	Front	0.473	0.083	0.556
		Back	0.498	0.115	0.613
	WCDMA Band V	Front	0.271	0.083	0.354
		Back	0.333	0.115	0.448
CDMA	CDMA2000 BC0	Front	0.382	0.083	0.465
		Back	0.475	0.115	0.590
	CDMA2000 BC1	Front	0.313	0.083	0.396
		Back	0.405	0.115	0.520
LTE	LTE Band 2	Front	0.391	0.083	0.474
		Back	0.463	0.115	0.578
	LTE Band 4	Front	0.537	0.083	0.620
		Back	0.645	0.115	0.760
	LTE Band 5	Front	0.302	0.083	0.385
		Back	0.304	0.115	0.419
	LTE Band 7	Front	0.527	0.083	0.610
		Back	0.775	0.115	0.890
	LTE Band 12	Front	0.119	0.083	0.202
		Back	0.136	0.115	0.251
	LTE Band 17	Front	0.124	0.083	0.207
		Back	0.147	0.115	0.262
	LTE Band 18	Front	0.237	0.083	0.320
		Back	0.315	0.115	0.430
	LTE Band 19	Front	0.292	0.083	0.375
		Back	0.359	0.115	0.474
	LTE Band 25	Front	0.466	0.083	0.549
		Back	0.552	0.115	0.667



	LTE Band 26	Front	0.285	0.083	0.368
		Back	0.316	0.115	0.431
	LTE Band 30	Front	0.350	0.083	0.433
		Back	0.490	0.115	0.605
	LTE Band 38	Front	0.182	0.083	0.265
		Back	0.201	0.115	0.316
	LTE Band 40	Front	0.208	0.083	0.291
		Back	0.275	0.115	0.390
	LTE Band 41	Front	0.167	0.083	0.250
		Back	0.231	0.115	0.346
	LTE Band 66	Front	0.572	0.083	0.655
		Back	0.675	0.115	0.790

➤ **Body-worn Simultaneous Transmission for WWAN+5GHz WLAN (MIMO)**

WWAN Band		Exposure Position	1	2	1+2 Summed 1g SAR (W/kg)
			WWAN	5GHz WLAN Ant 0+ Ant 1	
			1g SAR (W/kg)	1g SAR (W/kg)	
GSM	GSM850	Front	0.313	0.162	0.475
		Back	0.468	0.597	1.065
	GSM1900	Front	0.296	0.162	0.458
		Back	0.418	0.597	1.015
WCDMA	WCDMA Band II	Front	0.371	0.162	0.533
		Back	0.455	0.597	1.052
	WCDMA Band IV	Front	0.473	0.162	0.635
		Back	0.498	0.597	1.095
	WCDMA Band V	Front	0.271	0.162	0.433
		Back	0.333	0.597	0.93
CDMA	CDMA2000 BC0	Front	0.382	0.162	0.544
		Back	0.475	0.597	1.072
	CDMA2000 BC1	Front	0.313	0.162	0.475
		Back	0.405	0.597	1.002
LTE	LTE Band 2	Front	0.391	0.162	0.553
		Back	0.463	0.597	1.06
	LTE Band 4	Front	0.537	0.162	0.699
		Back	0.645	0.597	1.242
	LTE Band 5	Front	0.302	0.162	0.464



	LTE Band 7	Back	0.304	0.597	0.901
		Front	0.527	0.162	0.689
	LTE Band 12	Back	0.775	0.597	1.372
		Front	0.119	0.162	0.281
	LTE Band 17	Back	0.136	0.597	0.733
		Front	0.124	0.162	0.286
	LTE Band 18	Back	0.147	0.597	0.744
		Front	0.237	0.162	0.399
	LTE Band 19	Back	0.315	0.597	0.912
		Front	0.292	0.162	0.454
	LTE Band 25	Back	0.359	0.597	0.956
		Front	0.466	0.162	0.628
	LTE Band 26	Back	0.552	0.597	1.149
		Front	0.285	0.162	0.447
	LTE Band 30	Back	0.316	0.597	0.913
		Front	0.350	0.162	0.512
	LTE Band 38	Back	0.490	0.597	1.087
		Front	0.182	0.162	0.344
	LTE Band 40	Back	0.201	0.597	0.798
		Front	0.208	0.162	0.37
LTE Band 41	Back	0.275	0.597	0.872	
	Front	0.167	0.162	0.329	
LTE Band 66	Back	0.231	0.597	0.828	
	Front	0.572	0.162	0.734	
		Back	0.675	0.597	1.272

➤ **Body-worn Simultaneous Transmission for WWAN+2.4GHz WLAN(MIMO)+BT**

WWAN Band		Exposure Position	2			1+2 Summed 1g SAR (W/kg)
			1 WWAN 1g SAR (W/kg)	2.4GHz MIMO 1g SAR (W/kg)	Bluetooth 1g SAR (W/kg)	
GSM	GSM850	Front	0.313	0.083	0.026	0.422
		Back	0.468	0.115	0.028	0.611
	GSM1900	Front	0.296	0.083	0.026	0.405
		Back	0.418	0.115	0.028	0.561
WCDMA	WCDMA Band II	Front	0.371	0.083	0.026	0.48
		Back	0.455	0.115	0.028	0.598



	WCDMA Band IV	Front	0.473	0.083	0.026	0.582
		Back	0.498	0.115	0.028	0.641
	WCDMA Band V	Front	0.271	0.083	0.026	0.38
		Back	0.333	0.115	0.028	0.476
CDMA	CDMA2000 BC0	Front	0.382	0.083	0.026	0.491
		Back	0.475	0.115	0.028	0.618
	CDMA2000 BC1	Front	0.313	0.083	0.026	0.422
		Back	0.405	0.115	0.028	0.548
LTE	LTE Band 2	Front	0.391	0.083	0.026	0.5
		Back	0.463	0.115	0.028	0.606
	LTE Band 4	Front	0.537	0.083	0.026	0.646
		Back	0.645	0.115	0.028	0.788
	LTE Band 5	Front	0.302	0.083	0.026	0.411
		Back	0.304	0.115	0.028	0.447
	LTE Band 7	Front	0.527	0.083	0.026	0.636
		Back	0.775	0.115	0.028	0.918
	LTE Band 12	Front	0.119	0.083	0.026	0.228
		Back	0.136	0.115	0.028	0.279
	LTE Band 17	Front	0.124	0.083	0.026	0.233
		Back	0.147	0.115	0.028	0.29
	LTE Band 18	Front	0.237	0.083	0.026	0.346
		Back	0.315	0.115	0.028	0.458
	LTE Band 19	Front	0.292	0.083	0.026	0.401
		Back	0.359	0.115	0.028	0.502
	LTE Band 25	Front	0.466	0.083	0.026	0.575
		Back	0.552	0.115	0.028	0.695
	LTE Band 26	Front	0.285	0.083	0.026	0.394
		Back	0.316	0.115	0.028	0.459
	LTE Band 30	Front	0.350	0.083	0.026	0.459
		Back	0.490	0.115	0.028	0.633
	LTE Band 38	Front	0.182	0.083	0.026	0.291
		Back	0.201	0.115	0.028	0.344
	LTE Band 40	Front	0.208	0.083	0.026	0.317
		Back	0.275	0.115	0.028	0.418
	LTE Band 41	Front	0.167	0.083	0.026	0.276
		Back	0.231	0.115	0.028	0.374
LTE Band 66	Front	0.572	0.083	0.026	0.681	
	Back	0.675	0.115	0.028	0.818	



➤ **Body-worn Simultaneous Transmission for WWAN+5GHz WLAN(MIMO)+BT**

WWAN Band		Exposure Position	1	2		1+2 Summed 1g SAR (W/kg)
			WWAN	5GHz MIMO	Bluetooth	
			1g SAR (W/kg)	1g SAR (W/kg)	1g SAR (W/kg)	
GSM	GSM850	Front	0.313	0.162	0.026	0.501
		Back	0.468	0.597	0.028	1.093
	GSM1900	Front	0.296	0.162	0.026	0.484
		Back	0.418	0.597	0.028	1.043
WCDMA	WCDMA Band II	Front	0.371	0.162	0.026	0.559
		Back	0.455	0.597	0.028	1.08
	WCDMA Band IV	Front	0.473	0.162	0.026	0.661
		Back	0.498	0.597	0.028	1.123
	WCDMA Band V	Front	0.271	0.162	0.026	0.459
		Back	0.333	0.597	0.028	0.958
CDMA	CDMA2000 BC0	Front	0.382	0.162	0.026	0.57
		Back	0.475	0.597	0.028	1.1
	CDMA2000 BC1	Front	0.313	0.162	0.026	0.501
		Back	0.405	0.597	0.028	1.03
LTE	LTE Band 2	Front	0.391	0.162	0.026	0.579
		Back	0.463	0.597	0.028	1.088
	LTE Band 4	Front	0.537	0.162	0.026	0.725
		Back	0.645	0.597	0.028	1.27
	LTE Band 5	Front	0.302	0.162	0.026	0.49
		Back	0.304	0.597	0.028	0.929
	LTE Band 7	Front	0.527	0.162	0.026	0.715
		Back	0.775	0.597	0.028	1.4
	LTE Band 12	Front	0.119	0.162	0.026	0.307
		Back	0.136	0.597	0.028	0.761
	LTE Band 17	Front	0.124	0.162	0.026	0.312
		Back	0.147	0.597	0.028	0.772
	LTE Band 18	Front	0.237	0.162	0.026	0.425
		Back	0.315	0.597	0.028	0.94
	LTE Band 19	Front	0.292	0.162	0.026	0.48
		Back	0.359	0.597	0.028	0.984
	LTE Band 25	Front	0.466	0.162	0.026	0.654
		Back	0.552	0.597	0.028	1.177



	LTE Band 26	Front	0.285	0.162	0.026	0.473
		Back	0.316	0.597	0.028	0.941
	LTE Band 30	Front	0.350	0.162	0.026	0.538
		Back	0.490	0.597	0.028	1.115
	LTE Band 38	Front	0.182	0.162	0.026	0.37
		Back	0.201	0.597	0.028	0.826
	LTE Band 40	Front	0.208	0.162	0.026	0.396
		Back	0.275	0.597	0.028	0.9
	LTE Band 41	Front	0.167	0.162	0.026	0.355
		Back	0.231	0.597	0.028	0.856
	LTE Band 66	Front	0.572	0.162	0.026	0.76
		Back	0.675	0.597	0.028	1.3

➤ Hotspot Simultaneous Transmission for WWAN+WLAN

WWAN Band	Exposure Position	1	2	3	1+2 Summed 1g SAR (W/kg)	1+3 Summed 1g SAR (W/kg)	
		WWAN	2.4GHz WLAN	Bluetooth			
		1g SAR (W/kg)	1g SAR (W/kg)	1g SAR (W/kg)			
GSM	GSM850	Front	0.313	0.070	0.026	0.383	0.339
		Back	0.468	0.076	0.028	0.544	0.496
		Left side	0.034	0.026		0.060	0.034
		Right side	0.134	0.026	0.015	0.160	0.149
		Top side	0.222	0.047	0.021	0.269	0.243
		Bottom side	0.271			0.271	0.271
	GSM1900	Front	0.296	0.070	0.026	0.366	0.322
		Back	0.418	0.076	0.028	0.494	0.446
		Left side	0.076	0.026		0.102	0.076
		Right side	0.046	0.026	0.015	0.072	0.061
		Top side	0.470	0.047	0.021	0.517	0.491
		Bottom side	0.920			0.920	0.920
WCDMA	WCDMA Band II	Front	0.371	0.070	0.026	0.441	0.397
		Back	0.455	0.076	0.028	0.531	0.483
		Left side	0.079	0.026		0.105	0.079
		Right side	0.053	0.026	0.015	0.079	0.068
		Top side	0.439	0.047	0.021	0.486	0.460
		Bottom side	0.990			0.990	0.990
	WCDMA	Front	0.473	0.070	0.026	0.543	0.499



	Band IV	Back	0.498	0.076	0.028	0.574	0.526
		Left side	0.101	0.026		0.127	0.101
		Right side	0.081	0.026	0.015	0.107	0.096
		Top side	0.255	0.047	0.021	0.302	0.276
		Bottom side	0.924			0.924	0.924
	WCDMA Band V	Front	0.271	0.070	0.026	0.341	0.297
		Back	0.333	0.076	0.028	0.409	0.361
		Left side	0.027	0.026		0.053	0.027
		Right side	0.134	0.026	0.015	0.160	0.149
		Top side	0.177	0.047	0.021	0.224	0.198
		Bottom side	0.182			0.182	0.182
CDMA	CDMA200 0 BC0	Front	0.382	0.070	0.026	0.452	0.408
		Back	0.475	0.076	0.028	0.551	0.503
		Left side	0.048	0.026		0.074	0.048
		Right side	0.201	0.026	0.015	0.227	0.216
		Top side	0.256	0.047	0.021	0.303	0.277
		Bottom side	0.285			0.285	0.285
	CDMA200 0 BC1	Front	0.313	0.070	0.026	0.383	0.339
		Back	0.405	0.076	0.028	0.481	0.433
		Left side	0.070	0.026		0.096	0.070
		Right side	0.043	0.026	0.015	0.069	0.058
		Top side	0.402	0.047	0.021	0.449	0.423
		Bottom side	0.624			0.624	0.624
LTE	LTE Band 2	Front	0.391	0.070	0.026	0.461	0.417
		Back	0.463	0.076	0.028	0.539	0.491
		Left side	0.074	0.026		0.100	0.074
		Right side	0.441	0.026	0.015	0.467	0.456
		Top side	0.404	0.047	0.021	0.451	0.425
		Bottom side	0.940			0.940	0.940
	LTE Band 4	Front	0.537	0.070	0.026	0.607	0.563
		Back	0.645	0.076	0.028	0.721	0.673
		Left side	0.130	0.026		0.156	0.130
		Right side	0.106	0.026	0.015	0.132	0.121
		Top side	0.271	0.047	0.021	0.318	0.292
		Bottom side	1.029			1.029	1.029
	LTE Band 5	Front	0.302	0.070	0.026	0.372	0.328
		Back	0.304	0.076	0.028	0.380	0.332
		Left side	0.045	0.026		0.071	0.045



		Right side	0.119	0.026	0.015	0.145	0.134
		Top side	0.200	0.047	0.021	0.247	0.221
		Bottom side	0.207			0.207	0.207
	LTE Band 7	Front	0.527	0.070	0.026	0.597	0.553
		Back	0.775	0.076	0.028	0.851	0.803
		Left side	0.227	0.026		0.253	0.227
		Right side	0.073	0.026	0.015	0.099	0.088
		Top side	0.714	0.047	0.021	0.761	0.735
		Bottom side	1.154			1.154	1.154
	LTE Band 12	Front	0.119	0.070	0.026	0.189	0.145
		Back	0.136	0.076	0.028	0.212	0.164
		Left side	0.061	0.026		0.087	0.061
		Right side	0.151	0.026	0.015	0.177	0.166
		Top side	0.017	0.047	0.021	0.064	0.038
		Bottom side	0.087			0.087	0.087
	LTE Band 17	Front	0.124	0.070	0.026	0.194	0.150
		Back	0.147	0.076	0.028	0.223	0.175
		Left side	0.068	0.026		0.094	0.068
		Right side	0.157	0.026	0.015	0.183	0.172
		Top side	0.014	0.047	0.021	0.061	0.035
		Bottom side	0.096			0.096	0.096
	LTE Band 18	Front	0.237	0.070	0.026	0.307	0.263
		Back	0.315	0.076	0.028	0.391	0.343
		Left side	0.042	0.026		0.068	0.042
		Right side	0.080	0.026	0.015	0.106	0.095
Top side		0.142	0.047	0.021	0.189	0.163	
Bottom side		0.172			0.172	0.172	
LTE Band 19	Front	0.292	0.070	0.026	0.362	0.318	
	Back	0.359	0.076	0.028	0.435	0.387	
	Left side	0.053	0.026		0.079	0.053	
	Right side	0.120	0.026	0.015	0.146	0.135	
	Top side	0.205	0.047	0.021	0.252	0.226	
	Bottom side	0.177			0.177	0.177	
LTE Band 25	Front	0.466	0.070	0.026	0.536	0.492	
	Back	0.552	0.076	0.028	0.628	0.580	
	Left side	0.111	0.026		0.137	0.111	
	Right side	0.082	0.026	0.015	0.108	0.097	
	Top side	0.384	0.047	0.021	0.431	0.405	



		Bottom side	1.074			1.074	1.074
LTE Band 26		Front	0.285	0.070	0.026	0.355	0.311
		Back	0.316	0.076	0.028	0.392	0.344
		Left side	0.050	0.026		0.076	0.050
		Right side	0.115	0.026	0.015	0.141	0.130
		Top side	0.167	0.047	0.021	0.214	0.188
		Bottom side	0.191			0.191	0.191
LTE Band 30		Front	0.350	0.070	0.026	0.420	0.376
		Back	0.490	0.076	0.028	0.566	0.518
		Left side	0.147	0.026		0.173	0.147
		Right side	0.036	0.026	0.015	0.062	0.051
		Top side	0.690	0.047	0.021	0.737	0.711
		Bottom side	1.083			1.083	1.083
LTE Band 38		Front	0.182	0.070	0.026	0.252	0.208
		Back	0.201	0.076	0.028	0.277	0.229
		Left side	0.068	0.026		0.094	0.068
		Right side	0.034	0.026	0.015	0.060	0.049
		Top side	0.233	0.047	0.021	0.280	0.254
		Bottom side	0.291			0.291	0.291
LTE Band 40		Front	0.208	0.070	0.026	0.278	0.234
		Back	0.275	0.076	0.028	0.351	0.303
		Left side	0.091	0.026		0.117	0.091
		Right side	0.025	0.026	0.015	0.051	0.040
		Top side	0.568	0.047	0.021	0.615	0.589
		Bottom side	0.581			0.581	0.581
LTE Band 41		Front	0.167	0.070	0.026	0.237	0.193
		Back	0.231	0.076	0.028	0.307	0.259
		Left side	0.071	0.026		0.097	0.071
		Right side	0.023	0.026	0.015	0.049	0.038
		Top side	0.236	0.047	0.021	0.283	0.257
		Bottom side	0.283			0.283	0.283
LTE Band 66		Front	0.572	0.070	0.026	0.642	0.598
		Back	0.675	0.076	0.028	0.751	0.703
		Left side	0.149	0.026		0.175	0.149
		Right side	0.122	0.026	0.015	0.148	0.137
		Top side	0.316	0.047	0.021	0.363	0.337
		Bottom side	1.142			1.142	1.142



➤ **Hotspot Simultaneous Transmission for 2.4GHz WLAN(MIMO)**

WWAN Band	Exposure Position	1	2	1+2 Summed 1g SAR (W/kg)
		Ant 0	Ant 1	
		1g SAR (W/kg)	1g SAR (W/kg)	
2.4GHz WLAN	Front Side	0.070	0.013	0.083
	Back Side	0.076	0.039	0.115
	Right Side	0.026	N/A	0.026
	Left Side	N/A	0.024	0.024
	Top Side	0.047	0.014	0.061

➤ **Hotspot Simultaneous Transmission for WWAN + 2.4GHz WLAN(MIMO)**

WWAN Band		Exposure Position	1	2	1+2 Summed 1g SAR (W/kg)
			WWAN	2.4GHz WLAN Ant 0+ Ant 1	
			1g SAR (W/kg)	1g SAR (W/kg)	
GSM	GSM850	Front	0.313	0.083	0.396
		Back	0.468	0.115	0.583
		Left side	0.034	0.026	0.060
		Right side	0.134	0.024	0.158
		Top side	0.222	0.061	0.283
		Bottom side	0.271		0.271
	GSM1900	Front	0.296	0.083	0.379
		Back	0.418	0.115	0.533
		Left side	0.076	0.026	0.102
		Right side	0.046	0.024	0.070
		Top side	0.470	0.061	0.531
		Bottom side	0.920		0.920
WCDMA	WCDMA Band II	Front	0.371	0.083	0.454
		Back	0.455	0.115	0.570
		Left side	0.079	0.026	0.105
		Right side	0.053	0.024	0.077
		Top side	0.439	0.061	0.500
		Bottom side	0.990		0.990
	WCDMA Band IV	Front	0.473	0.083	0.556
		Back	0.498	0.115	0.613
		Left side	0.101	0.026	0.127



		Right side	0.081	0.024	0.105
		Top side	0.255	0.061	0.316
		Bottom side	0.924		0.924
	WCDMA Band V	Front	0.271	0.083	0.354
		Back	0.333	0.115	0.448
		Left side	0.027	0.026	0.053
		Right side	0.134	0.024	0.158
		Top side	0.177	0.061	0.238
		Bottom side	0.182		0.182
CDMA	CDMA2000 BC0	Front	0.382	0.083	0.465
		Back	0.475	0.115	0.590
		Left side	0.048	0.026	0.074
		Right side	0.201	0.024	0.225
		Top side	0.256	0.061	0.317
		Bottom side	0.285		0.285
	CDMA2000 BC1	Front	0.313	0.083	0.396
		Back	0.405	0.115	0.520
		Left side	0.070	0.026	0.096
		Right side	0.043	0.024	0.067
		Top side	0.402	0.061	0.463
		Bottom side	0.624		0.624
LTE	LTE Band 2	Front	0.391	0.083	0.474
		Back	0.463	0.115	0.578
		Left side	0.074	0.026	0.100
		Right side	0.441	0.024	0.465
		Top side	0.404	0.061	0.465
		Bottom side	0.940		0.940
	LTE Band 4	Front	0.537	0.083	0.620
		Back	0.645	0.115	0.760
		Left side	0.130	0.026	0.156
		Right side	0.106	0.024	0.130
		Top side	0.271	0.061	0.332
		Bottom side	1.029		1.029
	LTE Band 5	Front	0.302	0.083	0.385
		Back	0.304	0.115	0.419
		Left side	0.045	0.026	0.071
		Right side	0.119	0.024	0.143
		Top side	0.200	0.061	0.261



		Bottom side	0.207		0.207
	LTE Band 7	Front	0.527	0.083	0.610
		Back	0.775	0.115	0.890
		Left side	0.227	0.026	0.253
		Right side	0.073	0.024	0.097
		Top side	0.714	0.061	0.775
		Bottom side	1.154		1.154
		LTE Band 12	Front	0.119	0.083
	Back		0.136	0.115	0.251
	Left side		0.061	0.026	0.087
	Right side		0.151	0.024	0.175
	Top side		0.017	0.061	0.078
	Bottom side		0.087		0.087
	LTE Band 17	Front	0.124	0.083	0.207
		Back	0.147	0.115	0.262
		Left side	0.068	0.026	0.094
		Right side	0.157	0.024	0.181
		Top side	0.014	0.061	0.075
		Bottom side	0.096		0.096
	LTE Band 18	Front	0.237	0.083	0.320
		Back	0.315	0.115	0.430
		Left side	0.042	0.026	0.068
		Right side	0.080	0.024	0.104
		Top side	0.142	0.061	0.203
		Bottom side	0.172		0.172
	LTE Band 19	Front	0.292	0.083	0.375
		Back	0.359	0.115	0.474
		Left side	0.053	0.026	0.079
		Right side	0.120	0.024	0.144
		Top side	0.205	0.061	0.266
		Bottom side	0.177		0.177
	LTE Band 25	Front	0.466	0.083	0.549
		Back	0.552	0.115	0.667
		Left side	0.111	0.026	0.137
		Right side	0.082	0.024	0.106
		Top side	0.384	0.061	0.445
		Bottom side	1.074		1.074
	LTE Band 26	Front	0.285	0.083	0.368



		Back	0.316	0.115	0.431
		Left side	0.050	0.026	0.076
		Right side	0.115	0.024	0.139
		Top side	0.167	0.061	0.228
		Bottom side	0.191		0.191
	LTE Band 30	Front	0.350	0.083	0.433
		Back	0.490	0.115	0.605
		Left side	0.147	0.026	0.173
		Right side	0.036	0.024	0.060
		Top side	0.690	0.061	0.751
		Bottom side	1.083		1.083
	LTE Band 38	Front	0.182	0.083	0.265
		Back	0.201	0.115	0.316
		Left side	0.068	0.026	0.094
		Right side	0.034	0.024	0.058
		Top side	0.233	0.061	0.294
		Bottom side	0.291		0.291
	LTE Band 40	Front	0.208	0.083	0.291
		Back	0.275	0.115	0.390
		Left side	0.091	0.026	0.117
		Right side	0.025	0.024	0.049
		Top side	0.568	0.061	0.629
		Bottom side	0.581		0.581
	LTE Band 41	Front	0.167	0.083	0.250
Back		0.231	0.115	0.346	
Left side		0.071	0.026	0.097	
Right side		0.023	0.024	0.047	
Top side		0.236	0.061	0.297	
Bottom side		0.283		0.283	
LTE Band 66	Front	0.572	0.083	0.655	
	Back	0.675	0.115	0.790	
	Left side	0.149	0.026	0.175	
	Right side	0.122	0.024	0.146	
	Top side	0.316	0.061	0.377	
	Bottom side	1.142		1.142	

19. Uncertainty Assessment

The component of uncertainty may generally be categorized according to the methods used to evaluate them. The evaluation of uncertainty by the statistical analysis of a series of observations is termed a Type A evaluation of uncertainty. The evaluation of uncertainty by means other than the statistical analysis of a series of observation is termed a Type B evaluation of uncertainty. Each component of uncertainty, however evaluated, is represented by an estimated standard deviation, termed standard uncertainty, which is determined by the positive square root of the estimated variance.

A Type A evaluation of standard uncertainty may be based on any valid statistical method for treating data. This includes calculating the standard deviation of the mean of a series of independent observations; using the method of least squares to fit a curve to the data in order to estimate the parameter of the curve and their standard deviations; or carrying out an analysis of variance in order to identify and quantify random effects in certain kinds of measurement.

A type B evaluation of standard uncertainty is typically based on scientific judgment using all of the relevant information available. These may include previous measurement data, experience, and knowledge of the behavior and properties of relevant materials and instruments, manufacture's specification, data provided in calibration reports and uncertainties assigned to reference data taken from handbooks. Broadly speaking, the uncertainty is either obtained from an outdoor source or obtained from an assumed distribution, such as the normal distribution, rectangular or triangular distributions indicated in table below.

Uncertainty	Normal	Rectangular	Triangular	U-Shape
Multi-plying Factor ^(a)	1/k ^(b)	1/√3	1/√6	1/√2

Table 8.1. Standard Uncertainty for Assumed Distribution

- (a) standard uncertainty is determined as the product of the multiplying factor and the estimated range of variations in the measured quantity
- (b) κ is the coverage factor

The combined standard uncertainty of the measurement result represents the estimated standard deviation of the result. It is obtained by combining the individual standard uncertainties of both Type A and Type B evaluation using the usual "root-sum-squares" (RSS) methods of combining standard deviations by taking the positive square root of the estimated variances.

Expanded uncertainty is a measure of uncertainty that defines an interval about the measurement result within which the measured value is confidently believed to lie. It is obtained by multiplying the combined standard uncertainty by a coverage factor. Typically, the coverage factor ranges from 2 to 3. Using a coverage factor allows the true value of a measured quantity to be specified with a defined probability within the specified uncertainty range. For purpose of this document, a coverage factor two is used, which corresponds to confidence interval of about 95 %. The DASY uncertainty Budget is shown in the following



tables.

Error Description	Uncertainty Value (±%)	Probability	Divisor	(Ci) 1g	(Ci) 10g	Standard Uncertainty (1g) (±%)	Standard Uncertainty (10g) (±%)
Measurement System							
Probe Calibration	6.0	N	1	1	1	6.0	6.0
Axial Isotropy	4.7	R	1.732	0.7	0.7	1.9	1.9
Hemispherical Isotropy	9.6	R	1.732	0.7	0.7	3.9	3.9
Boundary Effects	1.0	R	1.732	1	1	0.6	0.6
Linearity	4.7	R	1.732	1	1	2.7	2.7
System Detection Limits	1.0	R	1.732	1	1	0.6	0.6
Modulation Response	3.2	R	1.732	1	1	1.8	1.8
Readout Electronics	0.3	N	1	1	1	0.3	0.3
Response Time	0.0	R	1.732	1	1	0.0	0.0
Integration Time	2.6	R	1.732	1	1	1.5	1.5
RF Ambient Noise	3.0	R	1.732	1	1	1.7	1.7
RF Ambient Reflections	3.0	R	1.732	1	1	1.7	1.7
Probe Positioner	0.4	R	1.732	1	1	0.2	0.2
Probe Positioning	2.9	R	1.732	1	1	1.7	1.7
Max. SAR Eval.	2.0	R	1.732	1	1	1.2	1.2
Test Sample Related							
Device Positioning	3.0	N	1	1	1	3.0	3.0
Device Holder	3.6	N	1	1	1	0.089	0.089
Power Drift	5.0	R	1.732	1	1	2.9	2.9
Power Scaling	0.0	R	1.732	1	1	0.0	0.0
Phantom and Setup							
Phantom Uncertainty	6.1	R	1.732	1	1	3.5	3.5
SAR correction	0.0	R	1.732	1	0.84	0.0	0.0
Liquid Conductivity Repeatability	0.2	N	1	0.78	0.71	0.1	0.1
Liquid Conductivity (target)	5.0	R	1.732	0.78	0.71	2.3	2.0
Liquid Conductivity (mea.)	2.5	R	1.732	0.78	0.71	1.1	1.0
Temp. unc. - Conductivity	3.4	R	1.732	0.78	0.71	1.5	1.4
Liquid Permittivity Repeatability	0.15	N	1	0.23	0.26	0.0	0.0
Liquid Permittivity (target)	5.0	R	1.732	0.23	0.26	0.7	0.8
Liquid Permittivity (mea.)	2.5	R	1.732	0.23	0.26	0.3	0.4
Temp. unc. - Permittivity	0.83	R	1.732	0.23	0.26	0.1	0.1
Combined Std. Uncertainty						11.4%	11.4%
Coverage Factor for 95 %						K=2	K=2
Expanded STD Uncertainty						22.9%	22.7%



Error Description	Uncertainty Value (±%)	Probability	Divisor	(Ci) 1g	(Ci) 10g	Standard Uncertainty (1g) (±%)	Standard Uncertainty (10g) (±%)
Measurement System							
Probe Calibration	6.55	N	1	1	1	6.0	6.0
Axial Isotropy	4.7	R	1.732	0.7	0.7	1.9	1.9
Hemispherical Isotropy	9.6	R	1.732	0.7	0.7	3.9	3.9
Boundary Effects	2.0	R	1.732	1	1	1.2	1.2
Linearity	4.7	R	1.732	1	1	2.7	2.7
System Detection Limits	1.0	R	1.732	1	1	0.6	0.6
Modulation Response	3.2	R	1.732	1	1	1.8	1.8
Readout Electronics	0.3	N	1	1	1	0.3	0.3
Response Time	0.0	R	1.732	1	1	0.0	0.0
Integration Time	2.6	R	1.732	1	1	1.5	1.5
RF Ambient Noise	3.0	R	1.732	1	1	1.7	1.7
RF Ambient Reflections	3.0	R	1.732	1	1	1.7	1.7
Probe Positioner	0.4	R	1.732	1	1	0.2	0.2
Probe Positioning	6.7	R	1.732	1	1	3.9	3.9
Max. SAR Eval.	4.0	R	1.732	1	1	2.3	2.3
Test Sample Related							
Device Positioning	3.0	N	1	1	1	3.0	3.0
Device Holder	3.6	N	1	1	1	0.089	0.089
Power Drift	5.0	R	1.732	1	1	2.9	2.9
Power Scaling	0.0	R	1.732	1	1	0.0	0.0
Phantom and Setup							
Phantom Uncertainty	6.1	R	1.732	1	1	3.8	3.8
SAR correction	0.0	R	1.732	1	0.84	0.0	0.0
Liquid Conductivity Repeatability	0.2	N	1	0.78	0.71	0.1	0.1
Liquid Conductivity (target)	5.0	R	1.732	0.78	0.71	2.3	2.0
Liquid Conductivity (mea.)	2.5	R	1.732	0.78	0.71	1.1	1.0
Temp. unc. - Conductivity	3.4	R	1.732	0.78	0.71	1.5	1.4
Liquid Permittivity Repeatability	0.15	N	1	0.23	0.26	0.0	0.0
Liquid Permittivity (target)	5.0	R	1.732	0.23	0.26	0.7	0.8
Liquid Permittivity (mea.)	2.5	R	1.732	0.23	0.26	0.3	0.4
Temp. unc. - Permittivity	0.83	R	1.732	0.23	0.26	0.1	0.1
Combined Std. Uncertainty						12.5%	12.5%
Coverage Factor for 95 %						K=2	K=2
Expanded STD Uncertainty						25.1 %	25.1%