



DIRECTORY

- 1. Technical Information 4**
- 1.1. Applicant and Manufacturer Information 4**
- 1.2. Equipment Under Test (EUT) Description 4**
- 1.3. Test Standards and Results 6**
- 1.4. Environmental Conditions 6**
- 2. 47 CFR Part 2, and 27H&L&M Requirements 7**
- 2.1. Transmitter Conducted Output Power 7**
- 2.2. Occupied Bandwidth 9**
- 2.3. Frequency Stability 17**
- 2.4. Peak to Average Ratio 20**
- 2.5. Conducted Spurious Emissions 21**
- 2.6. Band Edge 26**
- 2.7. Transmitter Radiated Power (EIRP/ERP) 31**
- 2.8. Radiated Spurious Emissions 40**
- Annex A Test Uncertainty 68**
- Annex B Testing Laboratory Information 69**



Change History		
Version	Date	Reason for change
1.0	2019-01-22	First edition



1. Technical Information

Note: Provide by applicant.

1.1. Applicant and Manufacturer Information

Applicant:	Nubia Technology Co.,Ltd
Applicant Address:	10/F, Tower A, Hans Innovation Mansion, North Ring Rd., No.9018, High-Tech Park, Nanshan District, Shenzhen, China
Manufacturer:	Nubia Technology Co.,Ltd
Manufacturer Address:	10/F, Tower A, Hans Innovation Mansion, North Ring Rd., No.9018, High-Tech Park, Nanshan District, Shenzhen, China

1.2. Equipment Under Test (EUT) Description

Product Name:	NX619J	
Serial No:	(N/A, marked #1 by test site)	
Hardware Version:	NX619J_V1AMB	
Software Version:	NX619J_ENCommon_V1.07	
Modulation Type:	CDMA2000 1X:QPSK,OQPSK; EVDO 0:QPSK,OQPSK; EVDO A:QPSK,OQPSK; EVDO B:QPSK,OQPSK	
Operation Band:	CDMA 800MHz: (BC 0)	
Frequency Range:	Tx: 824.70 – 848.31 MHz;	
	Rx: 869.70-- 893.31MHz	
Emission Designator:	CDMA 800MHz, BC0:1M28F9W	
Antenna Type:	PIFA Antenna	
Antenna Gain: (Top Antenna)	CDMA 800MHz, BC0:	1.31 dBi
Antenna Gain: (Bottom Antenna)	CDMA 800MHz, BC0:	1.26 dBi
Accessory Information::	Battery	
	Brand Name:	ATL
	Model No.:	Li3937T44P6h886639
	Serial No.:	(N/A, marked #1 by test site)
	Capacity:	3800mAh



	Rated Voltage:	3.85V
	Charge Limit:	4.4V
Accessory Information:	AC Adapter	
	Brand Name:	CHENYANG
	Model No.:	CYNBY090200-A00
	Serial No.:	(N/A, marked #1 by test site)
	Rated Input:	100-240V~ 50/60Hz 0.5A
	Rated Output:	5V=3.0A; 9V=2.0A;12V=1.5A
Accessory Information:	AC Adapter 2	
	Brand Name:	XINSPower
	Model No.:	Q183
	Serial No.:	(N/A, marked #1 by test site)
	Rated Input:	100-240V ~ 50/60Hz 0.5A
	Rated Output:	3.6-6V=3.0A; 6-9V=2.0A;9-12V=1.5A

Note 1: For a more detailed description, please refer to Specification or User's Manual supplied by the applicant and/or manufacturer.



1.3. Test Standards and Results

The objective of the report is to perform testing according to Part 2 and Part 27 for the EUT FCC ID Certification:

No	Identity	Document Title
1	47 CFR Part 2	Frequency Allocations and Radio Treaty Matters; General Rules and Regulations
2	47 CFR Part 22	Public Mobile Services

Test detailed items/section required by FCC rules and results are as below:

Section	Description	Test Date	Test Engineer	Result
2.1046	Transmitter Conducted Output Power	Jan 17, 2019	Gao Mingzhou	PASS
2.1049	Occupied Bandwidth	Dec 21, 2018	Gao Mingzhou	PASS
2.1055,22.355	Frequency Stability	Dec 22, 2018	Gao Mingzhou	PASS
2.1051, 22.917(a)	Conducted Spurious Emissions	Jan 17, 2019	Gao Mingzhou	PASS
2.1051, 22.917(a)	Band Edge	Dec 25, 2018	Gao Mingzhou	PASS
2.1046, 22.913(a)	Equivalent Isotropic Radiated Power	Dec 01, 2018	Wang Dalong	PASS
2.1053, 22.917(a)	Radiated Spurious Emissions	Dec 01&02, 2018	Wang Dalong	PASS

Note: The tests were performed according to the method of measurements prescribed in KDB971168 D01 v03 (Oct 27, 2017) and ANSI/TIA-603-E-2016.

1.4. Environmental Conditions

During the measurement, the environmental conditions were within the listed ranges:

Temperature (°C):	15 - 35
Relative Humidity (%):	30 -60
Atmospheric Pressure (kPa):	86-106

2. 47 CFR Part 2, and 22H Requirements

2.1. Transmitter Conducted Output Power

2.1.1. Requirement

According to FCC section 2.1046(a), for transmitters other than single sideband, independent sideband and controlled carrier radiotelephone, power output shall be measured at the RF output terminals when the transmitter is adjusted in accordance with the tune-up procedure to give the values of current and voltage on the circuit elements specified in FCC section 2.1033(c)(8).

2.1.2. Test Description

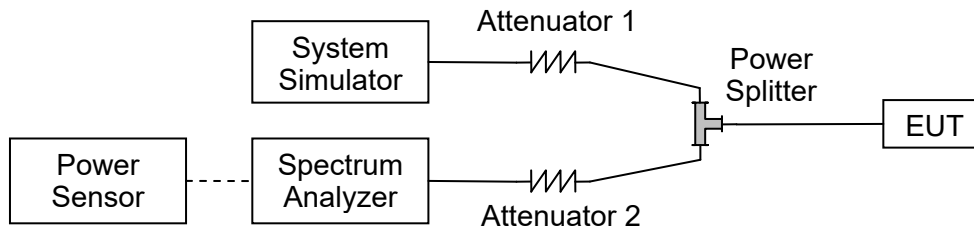

The EUT is coupled to the Spectrum Analyzer (SA) and the System Simulator (SS) with Attenuators through the Power Splitter; the RF load attached to the EUT antenna terminal is 50Ohm; the path loss as the factor is calibrated to correct the reading. The EUT is commanded by the SS to operate at the maximum output power. A call is established between the EUT and the SS.

2.1.3. Test procedure

KDB 971168 D01v03 Section 5.2 and ANSI/TIA-603-E-2016.

2.1.4. Result



Top Antenna(Down Power):

Band	CDMA2000 BC0		
TX Channel	1013	1013	1013
Frequency (MHz)	824.7	836.52	848.31
RC1 SO55	20.96	20.88	20.91
RC3 SO55	21.00	20.80	20.94
RC3 SO32 (F+SCH)	20.97	20.79	20.91
RC3 SO32 (+SCH)	20.98	20.82	20.87
1XEVDO Rev 0	20.84	20.60	20.53
1XEVDO Rev A	20.70	20.57	20.58
1XEVDO Rev B	20.26	20.12	20.13

Bottom Antenna(Down Power):

Band	CDMA2000 BC0		
TX Channel	1013	1013	1013
Frequency (MHz)	824.7	836.52	848.31
RC1 SO55	24.00	23.82	23.85
RC3 SO55	24.03	23.93	23.86
RC3 SO32 (F+SCH)	23.82	23.74	23.75
RC3 SO32 (+SCH)	23.94	23.89	23.90
1XEVDO Rev 0	22.41	22.34	22.40
1XEVDO Rev A	22.40	22.26	22.16
1XEVDO Rev B	22.37	22.19	22.15

2.2. Occupied Bandwidth

2.2.1. Requirement

According to FCC section 2.1049, the occupied bandwidth is the frequency bandwidth such that, below its lower and above its upper frequency limits, the mean powers radiated are each equal to 0.5 percent of the total mean power radiated by a given emission. Occupied bandwidth is also known as the 99% emission bandwidth.

2.2.2. Test Description

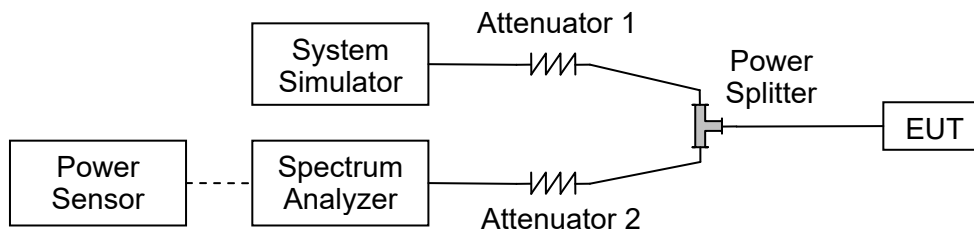

The EUT is coupled to the Spectrum Analyzer (SA) and the System Simulator (SS) with Attenuators through the Power Splitter; the RF load attached to the EUT antenna terminal is 50Ohm; the path loss as the factor is calibrated to correct the reading. The EUT is commanded by the SS to operate at the maximum output power. A call is established between the EUT and the SS.

2.2.3. Test procedure

KDB 971168 D01v03 Section 4.1 and ANSI/TIA-603-E-2016.

2.2.4. Test Result

Band	Channel	Frequency (MHz)	99% Occupied Bandwidth (kHz)	26dB bandwidth (kHz)	Refer to Plot
CDMA (BC0)	1013	824.7	1.272	1.434	Plot A1 to A3
	384	836.52	1.274	1.427	
	777	848.31	1.274	1.433	
1XEVD0 Rev 0 (BC0)	1013	824.7	1.277	1.431	Plot B1 to B3
	384	836.52	1.271	1.430	
	777	848.31	1.273	1.434	
1XEVD0 Rev A	1013	824.7	1.278	1.426	Plot C1 to C3
	384	836.52	1.271	1.425	



Band	Channel	Frequency (MHz)	99% Occupied Bandwidth (kHz)	26dB bandwidth (kHz)	Refer to Plot
(BC0)	777	848.31	1.273	1.422	
1XEVD0 Rev B (BC0)	1013	824.7	1.273	1.432	Plot D1 to D3
	384	836.52	1.273	1.424	
	777	848.31	1.272	1.431	

Test Plots:

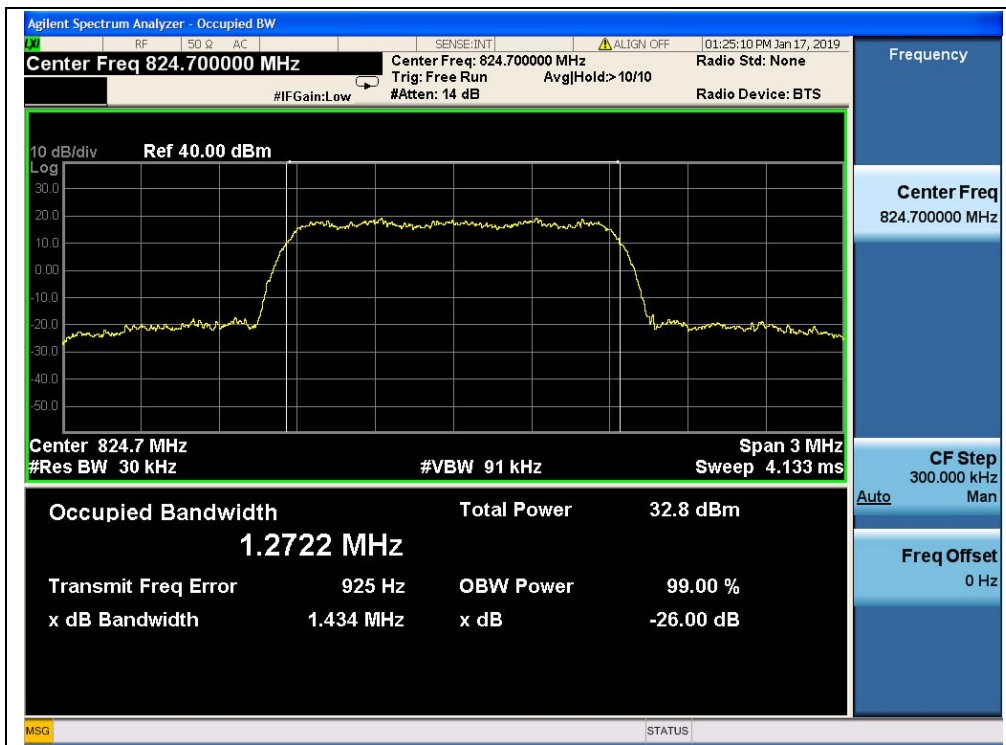

(Plot A1, CDMA BC0, Channel = 1013)

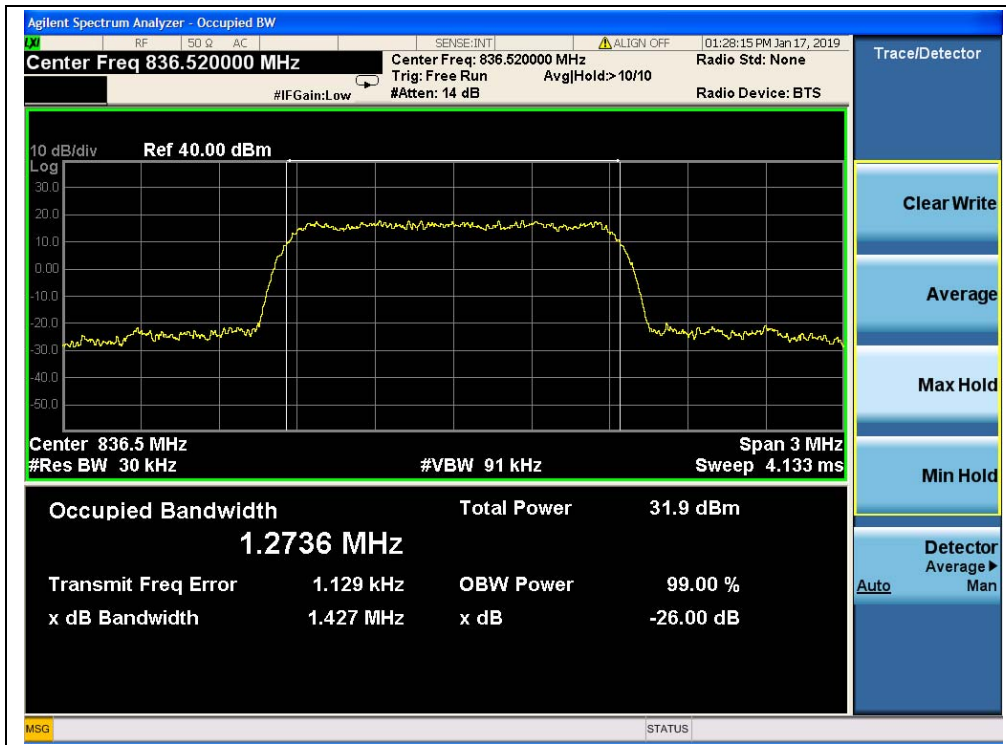

(Plot A2, CDMA BC0, Channel = 384)

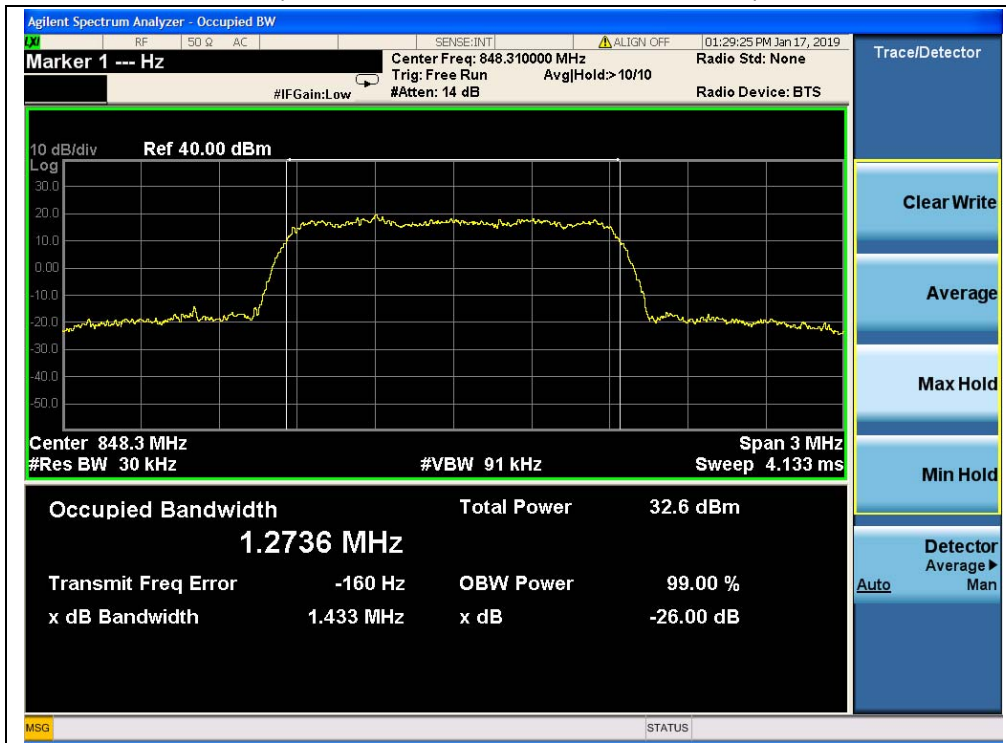

(Plot A3, CDMA BC0, Channel = 777)

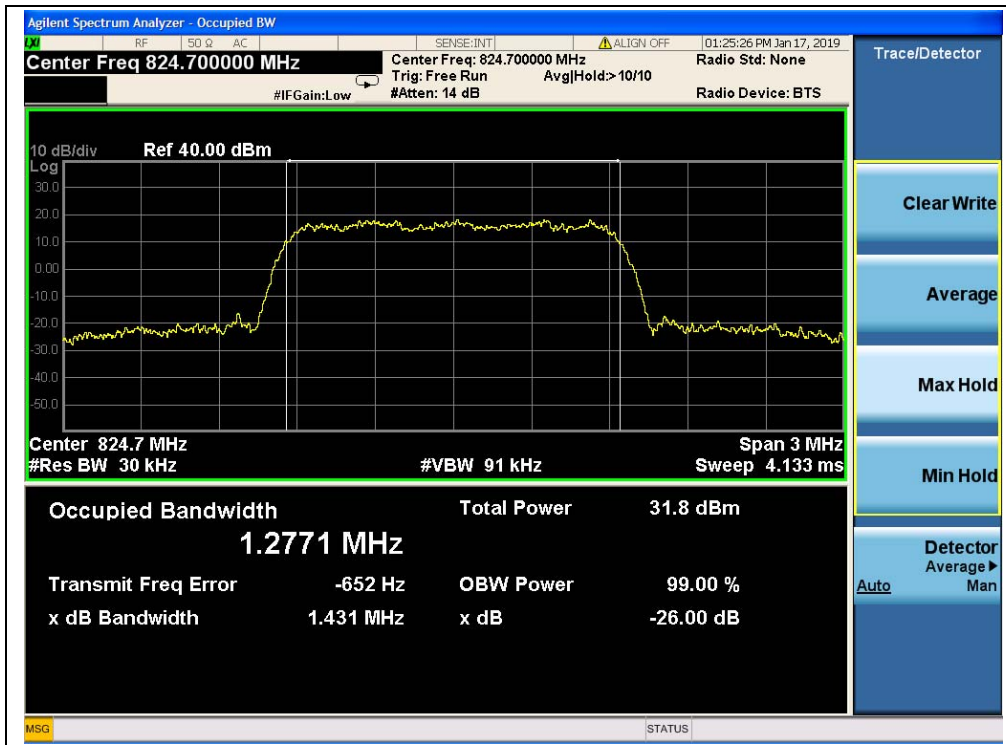

(Plot B1, 1XEVD0 Rev 0 BC0, Channel = 1013)

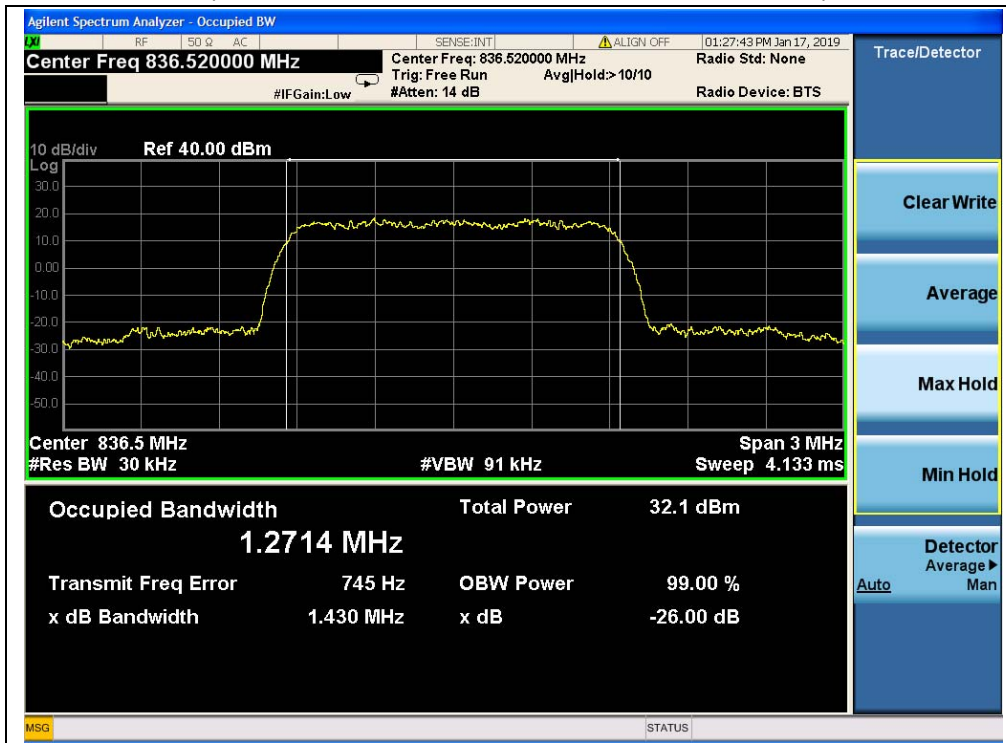

(Plot B2, 1XEVD0 Rev 0 BC0, Channel = 384)

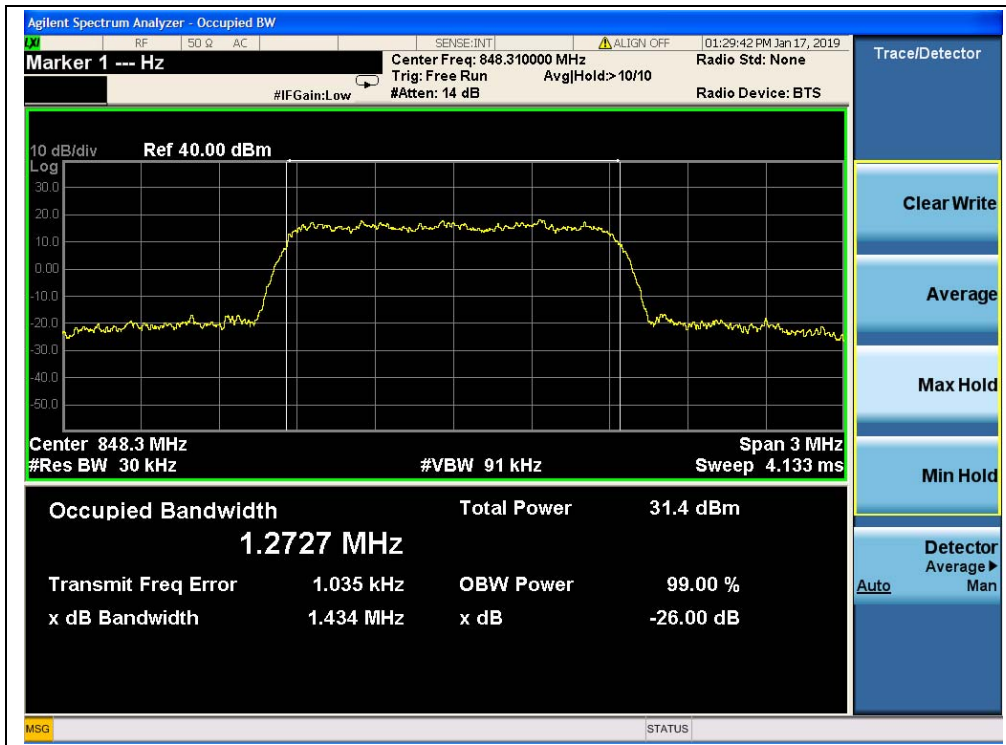

(Plot B3, 1XEVD0 Rev 0 BC0, Channel = 777)

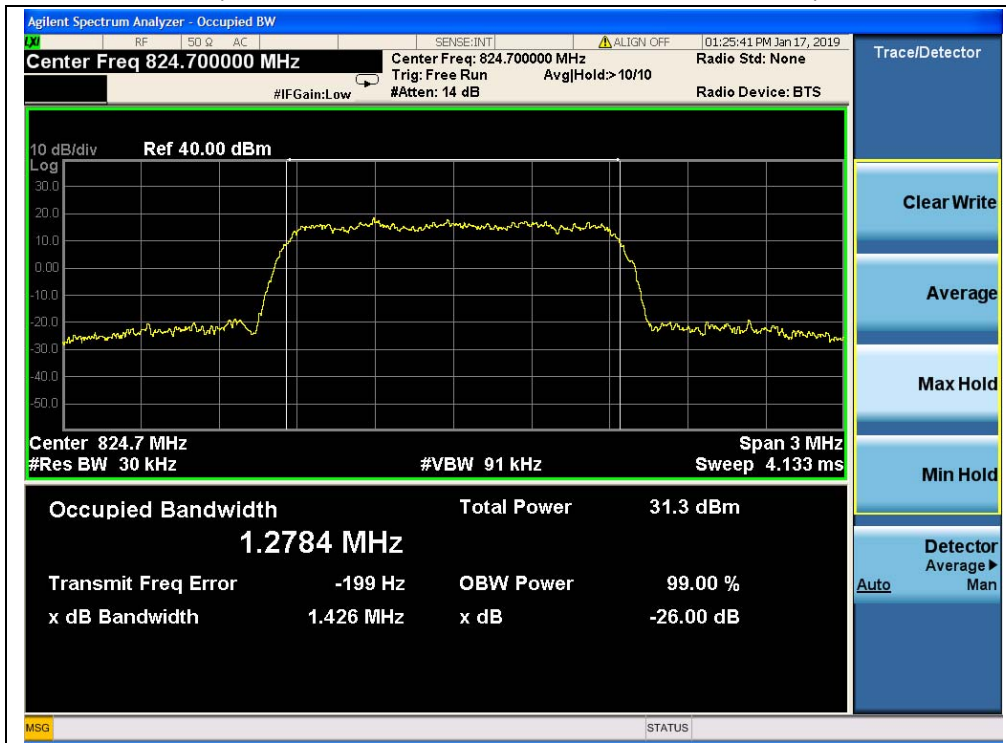

(Plot C1, 1XEVD0 Rev A BC0, Channel = 1013)

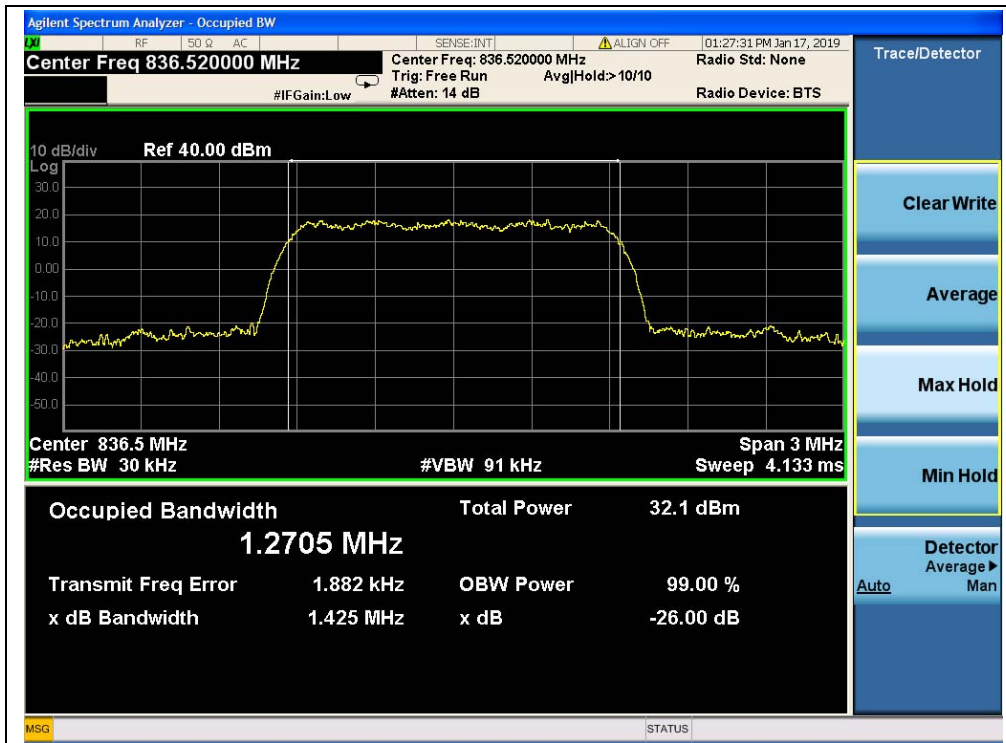

(Plot C2, 1XEVD0 Rev A BC0, Channel = 384)

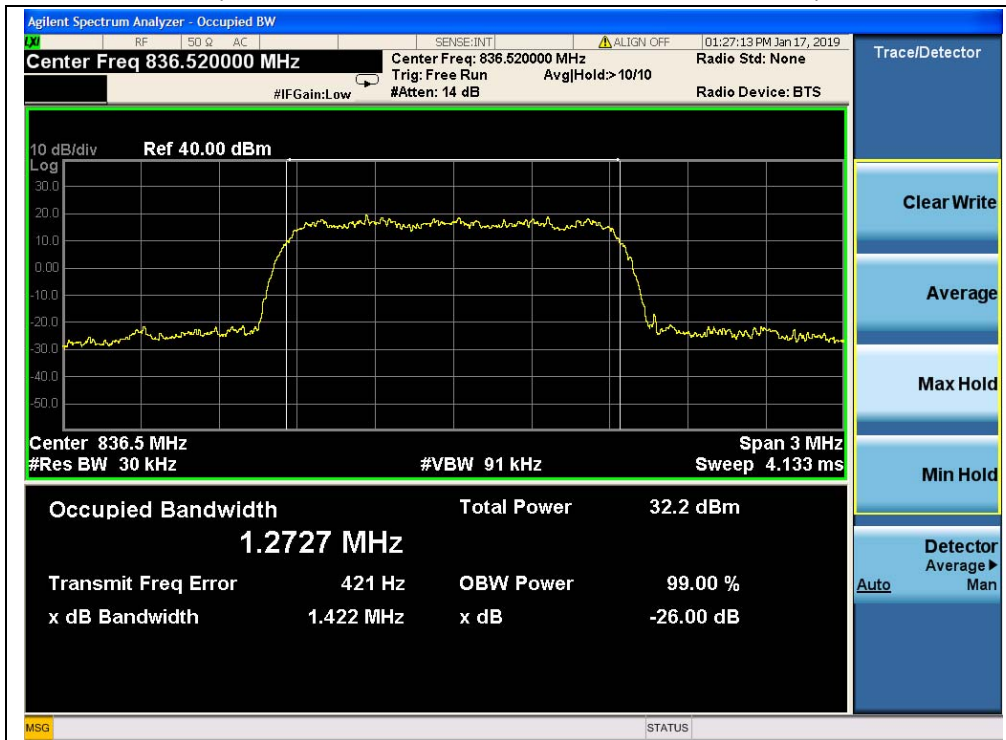

(Plot C3, 1XEVD0 Rev A BC0, Channel = 777)

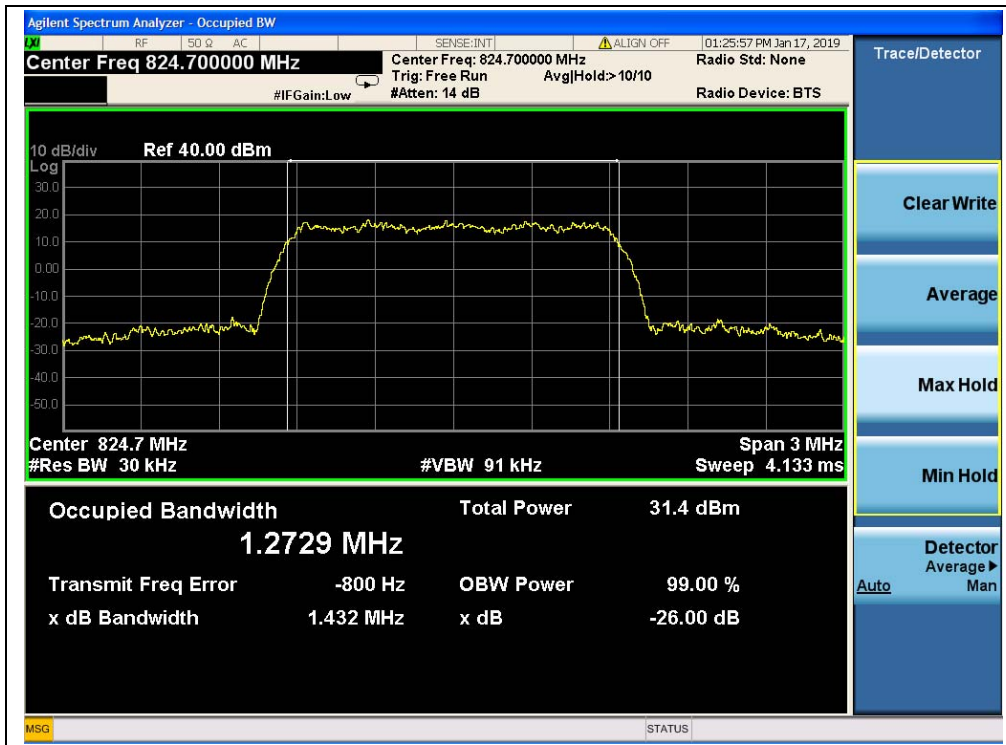

(Plot D1, 1XEVD0 Rev B BC0, Channel = 1013)

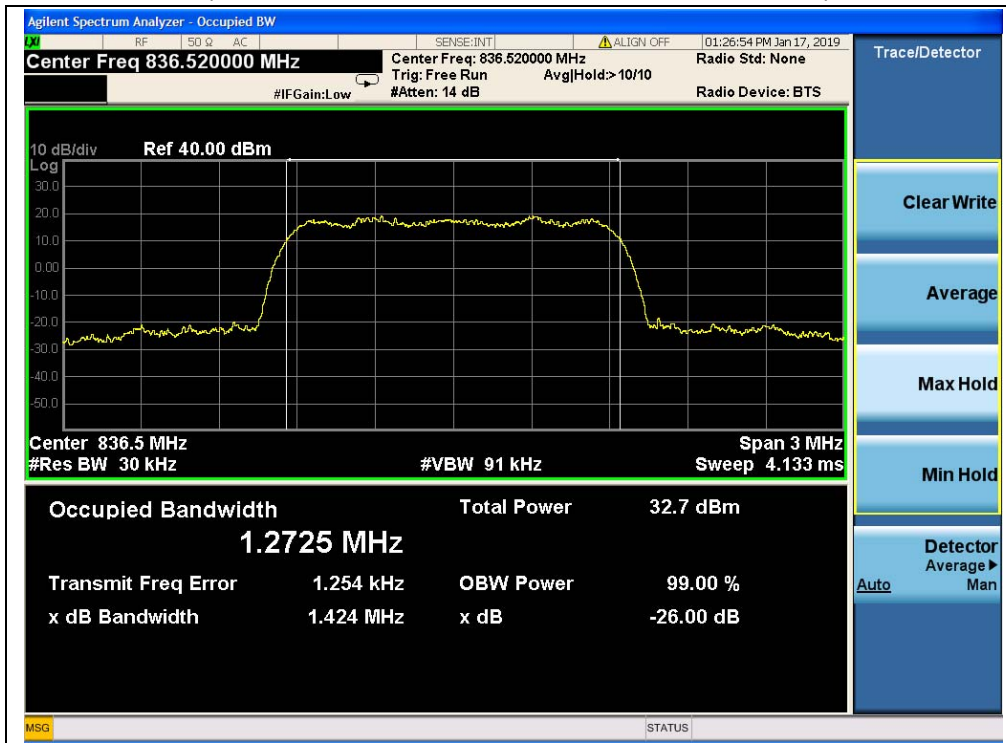

(Plot D2, 1XEVD0 Rev B BC0, Channel = 384)

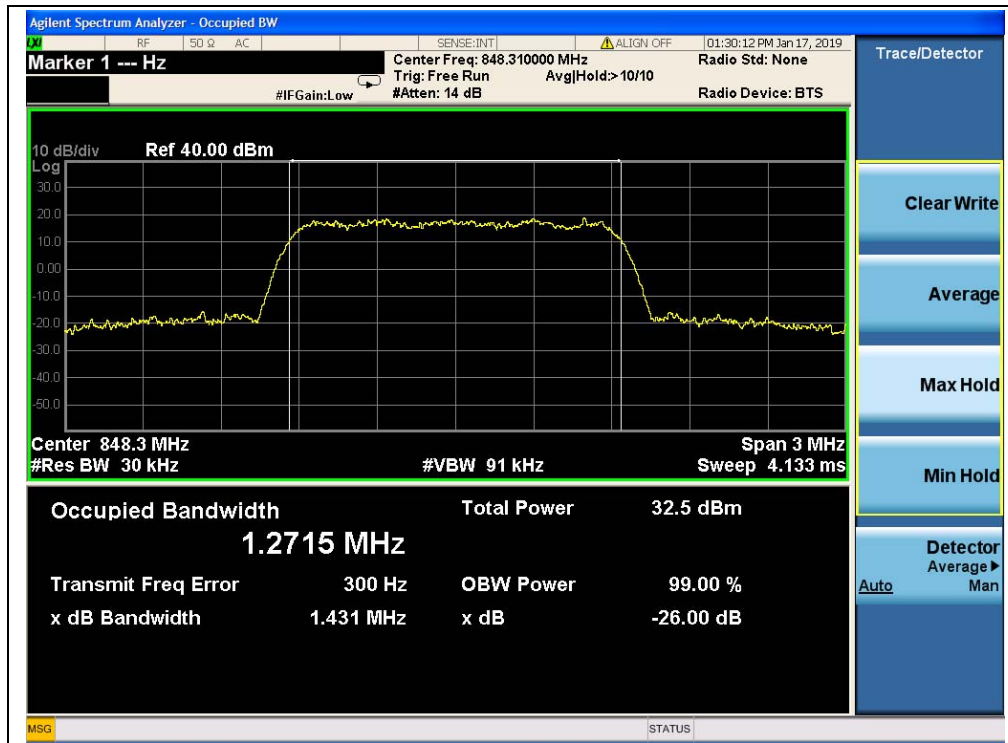

(Plot D3, 1XEVD0 Rev B BC0, Channel = 777)

2.3. Frequency Stability

2.3.1. Requirement

According to FCC section 2.1055 & 22.355&24.235, the frequency stability shall be sufficient to ensure that the fundamental emission stays within the authorized frequency block. According to FCC section 2.1055, the test conditions are:

- (a) The temperature is varied from -30°C to $+50^{\circ}\text{C}$ at intervals of not more than 10°C .
- (b) For hand carried battery powered equipment, the primary supply voltage is reduced to the battery operating end point which shall be specified by the manufacture. The supply voltage shall be measured at the input to the cable normally provided with the equipment, or at the power supply terminals if cables are not normally provided.

2.3.2. Test Description

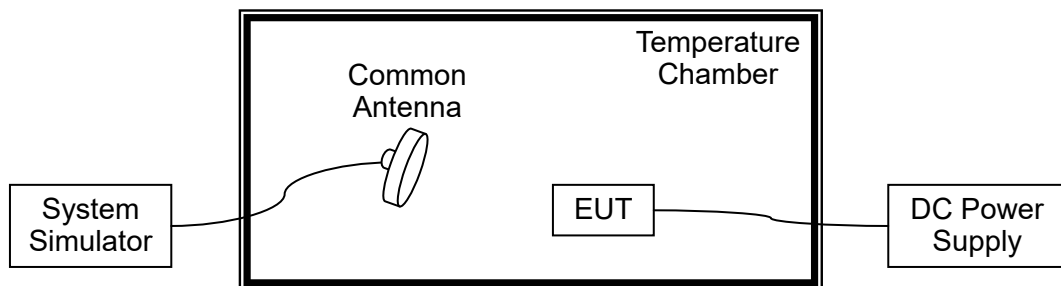

The EUT which is powered by the DC Power Supply directly, is located in the Temperature Chamber. The EUT is commanded by the System Simulator (SS) to operate at the maximum output power. A call is established between the EUT and the SS via a Common Antenna.

2.3.3. Test procedure

KDB 971168 D01v03 Section 9.0 and ANSI/TIA-603-E-2016.

2.3.4. Test Result

The nominal, highest and lowest extreme voltages are separately 3.8VDC, 4.35VDC and 3.5VDC, which are specified by the applicant; the normal temperature here used is 20°C .



CDMA 800MHz BC0, Channel 384, Frequency 836.52MHz					
Limit =±2.5ppm					
Voltage (%)	Power (VDC)	Temp (°C)	Fre. Dev. (Hz)	Deviation (ppm)	Result
100	3.8	+20(Ref)	57	0.068	PASS
100		-30	-11	-0.013	
100		-20	35	0.042	
100		-10	-34	-0.041	
100		0	35	0.042	
100		+10	35	0.042	
100		+20	41	0.049	
100		+30	21	0.025	
100		+40	32	0.038	
100		+50	35	0.042	
115	4.35	+20	29	0.035	
85	3.5	+20	-23	-0.027	

1XEVD0 Rev0 BC0, Channel 384, Frequency 836.52MHz					
Limit =±2.5ppm					
Voltage (%)	Power (VDC)	Temp (°C)	Fre. Dev. (Hz)	Deviation (ppm)	Result
100	3.8	+20(Ref)	50	0.060	PASS
100		-30	85	0.102	
100		-20	-57	-0.068	
100		-10	-53	-0.063	
100		0	48	0.057	
100		+10	-39	-0.047	
100		+20	41	0.049	
100		+30	21	0.025	
100		+40	67	0.080	
100		+50	43	0.051	
115	4.35	+20	-47	-0.056	
85	3.5	+20	-49	-0.059	



1XEVD0 RevA BC0, Channel 384, Frequency 836.52MHz					
Limit =±2.5ppm					
Voltage (%)	Power (VDC)	Temp (°C)	Fre. Dev. (Hz)	Deviation (ppm)	Result
100	3.8	+20(Ref)	33	0.039	PASS
100		-30	54	0.065	
100		-20	48	0.057	
100		-10	-35	-0.042	
100		0	-41	-0.049	
100		+10	-46	-0.055	
100		+20	-56	-0.067	
100		+30	-66	-0.079	
100		+40	53	0.063	
100		+50	43	0.051	
115		4.35	+20	65	
85	3.5	+20	45	0.054	

1XEVD0 RevB BC0, Channel 384, Frequency 836.52MHz					
Limit =±2.5ppm					
Voltage (%)	Power (VDC)	Temp (°C)	Fre. Dev. (Hz)	Deviation (ppm)	Result
100	3.8	+20(Ref)	-46	-0.055	PASS
100		-30	23	0.027	
100		-20	34	0.041	
100		-10	-32	-0.038	
100		0	-47	-0.056	
100		+10	-41	-0.049	
100		+20	-64	-0.077	
100		+30	-53	-0.063	
100		+40	67	0.080	
100		+50	55	0.066	
115		4.35	+20	23	
85	3.5	+20	75	0.090	

2.4. Peak to Average Ratio

2.4.1. Requirement

According to FCC section 27.50(d)(5), the peak to average ratio (PAR) of the transmission may not exceed 13dB.

2.4.2. Test Description

A. Test Set:

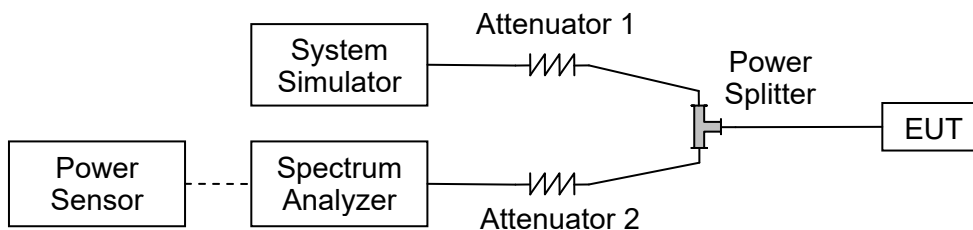

The EUT is coupled to the Spectrum Analyzer (SA) and the System Simulator (SS) with Attenuators through the Power Splitter; the RF load attached to the EUT antenna terminal is 50Ohm; the path loss as the factor is calibrated to correct the reading. The EUT is commanded by the SS to operate at the maximum output power. A call is established between the EUT and the SS.

2.4.3. Test procedure

KDB 971168 D01v03 Section 5.7 and ANSI/TIA-603-E-2016.

2.4.4. Test Result

Record the maximum PAPR level associated with a probability of 0.1%.

Note: This test case no support CDMA BC 0 band

2.5. Conducted Spurious Emissions

2.5.1. Requirement

According to FCC section 2.1051, the power of any emission outside of the authorized operating frequency ranges must be attenuated below the transmitting power (P) by a factor of at least $43+10*\log(P)$ dB. This calculated to be -13dBm.

Additional requirement for LTE Band 7:

The power of any emission outside of the authorized operating frequency ranges must be attenuated below the transmitting power (P) by a factor of at least $55 + 10 \log(P)$ dB. This calculated to be -25dBm.

2.5.2. Test Description

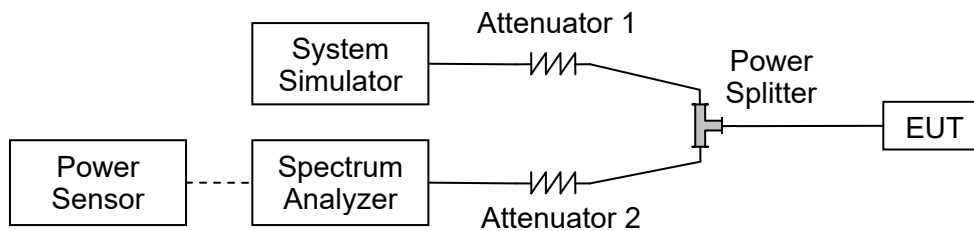

The EUT is coupled to the Spectrum Analyzer (SA) and the System Simulator (SS) with Attenuators through the Power Splitter; the RF load attached to the EUT antenna terminal is 50Ohm; the path loss as the factor is calibrated to correct the reading. The EUT is commanded by the SS to operate at the maximum output power. A call is established between the EUT and the SS.

2.5.3. Test procedure

KDB 971168 D01v03 Section 6.0 and ANSI/TIA-603-E-2016.

2.5.4. Test Result



CDMA BC0, Channel=1013

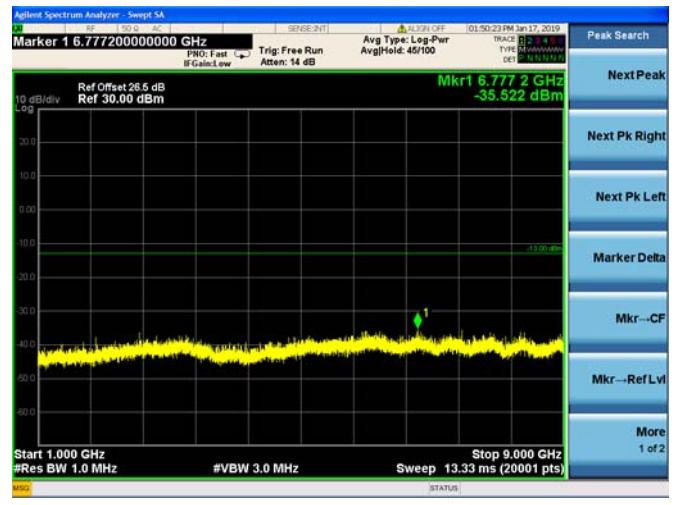
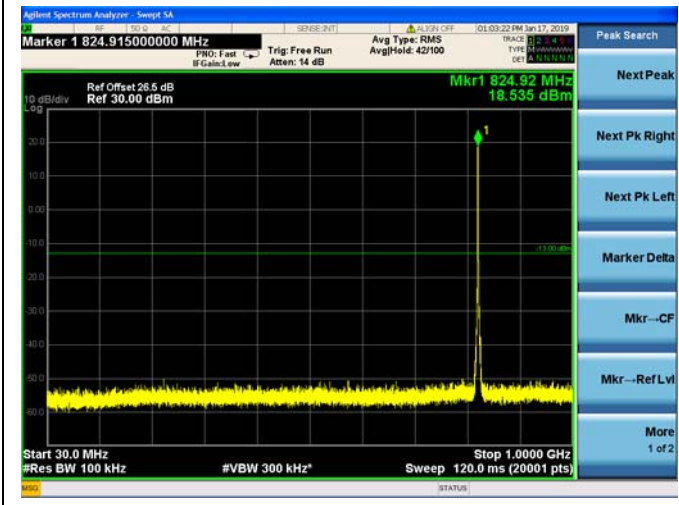

CDMA BC0, Channel=384

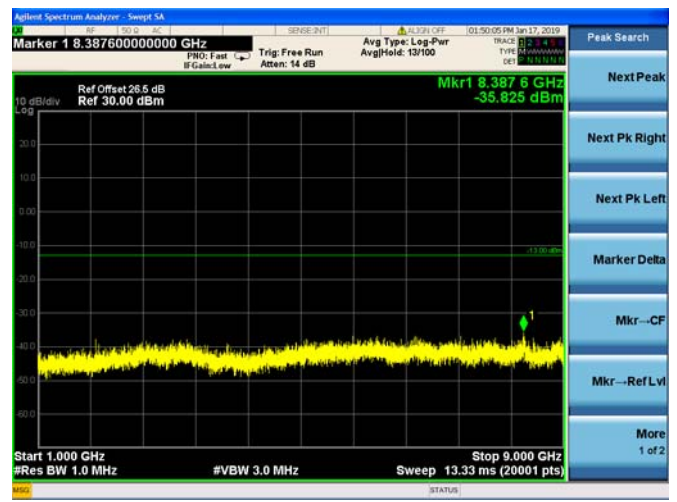
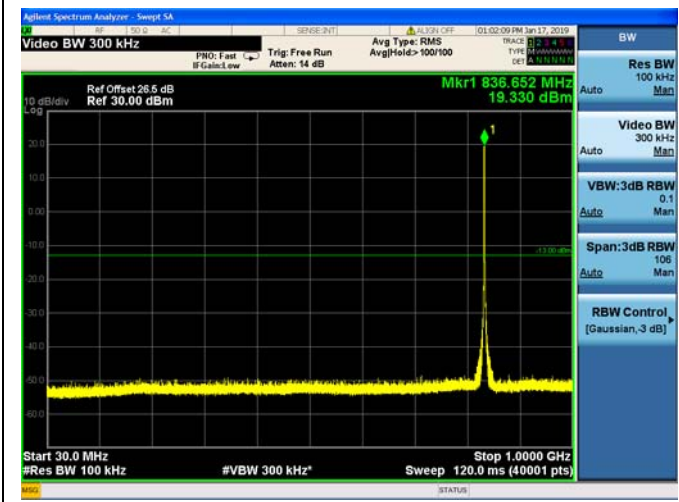

CDMA BC0, Channel=777

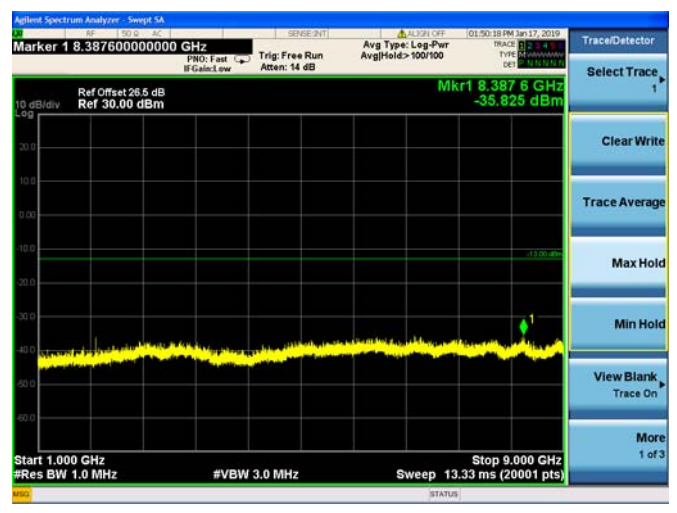
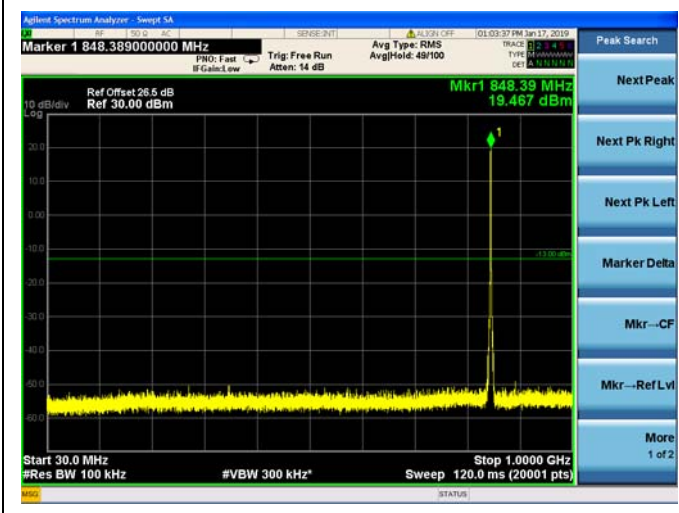



1XEVD0 Rev 0 BC0, Channel=1013

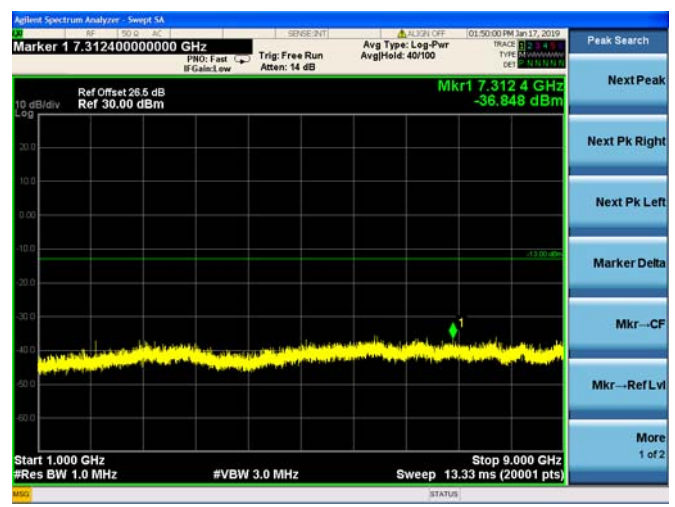
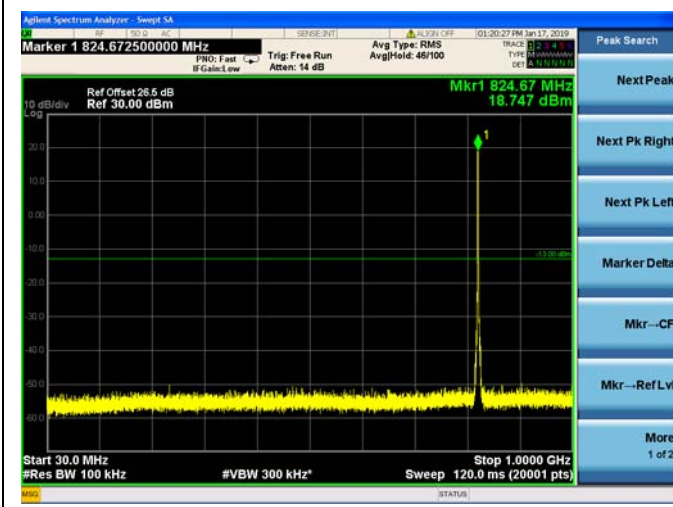

1XEVD0 Rev 0 BC0, Channel=384

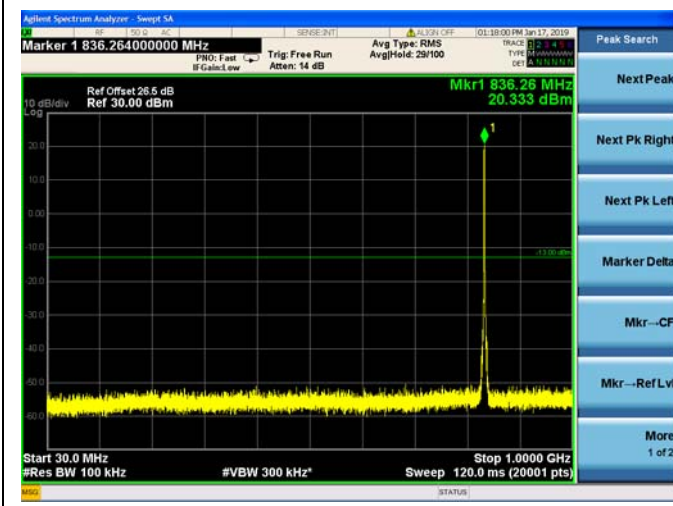



1XEVD0 Rev 0 BC0, Channel=777

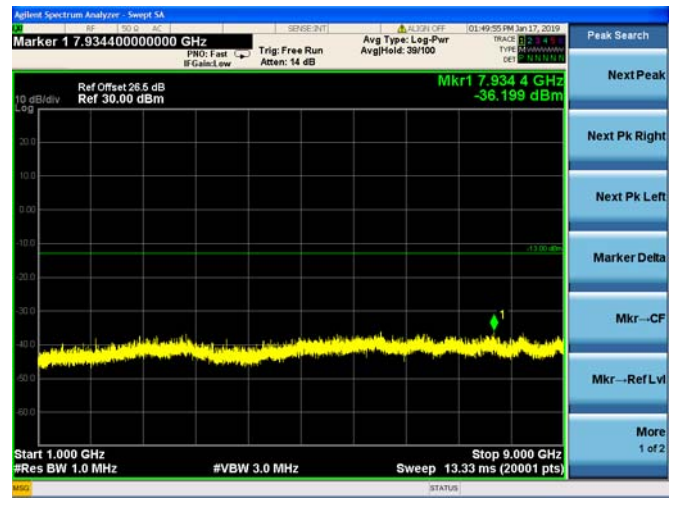
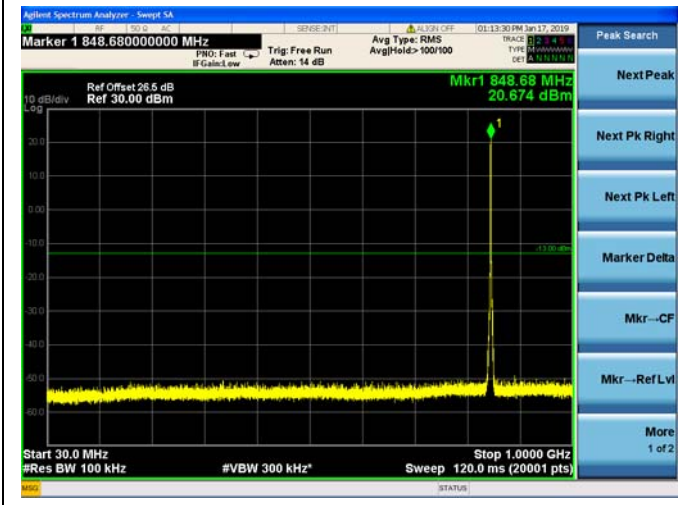

1XEVD0 Rev A BC0, Channel=1013

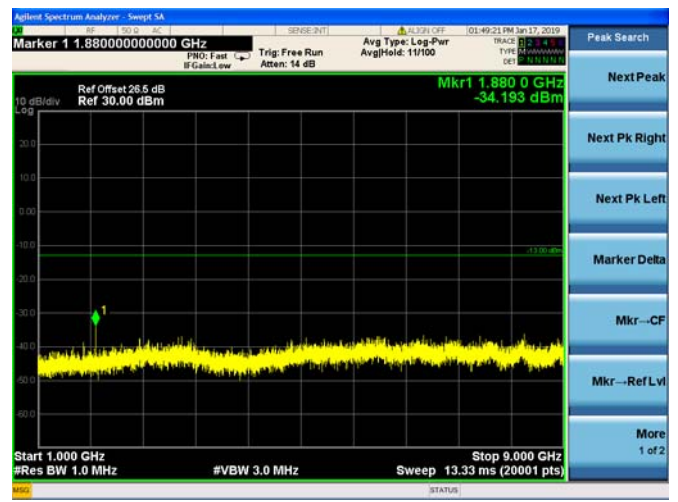
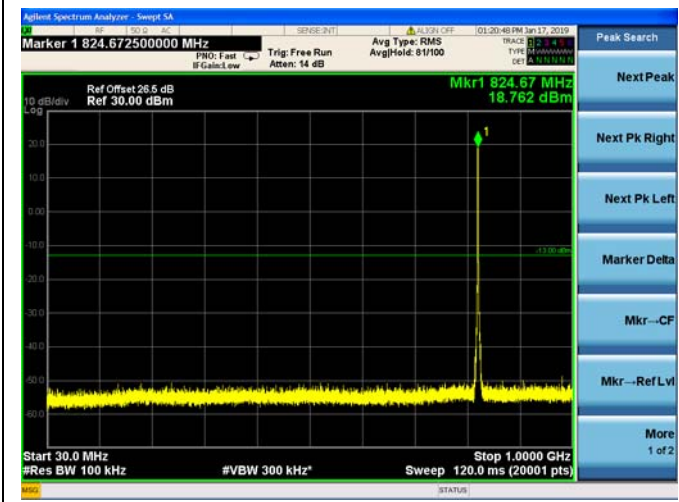

1XEVD0 Rev A BC0, Channel=384

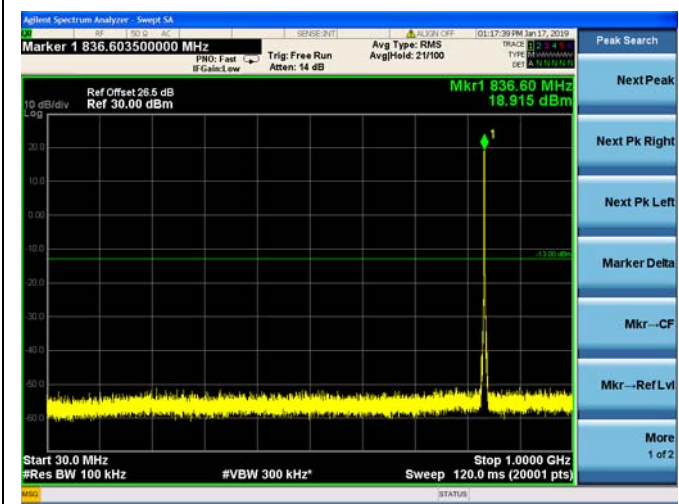



1XEVD0 Rev A BC0, Channel=777

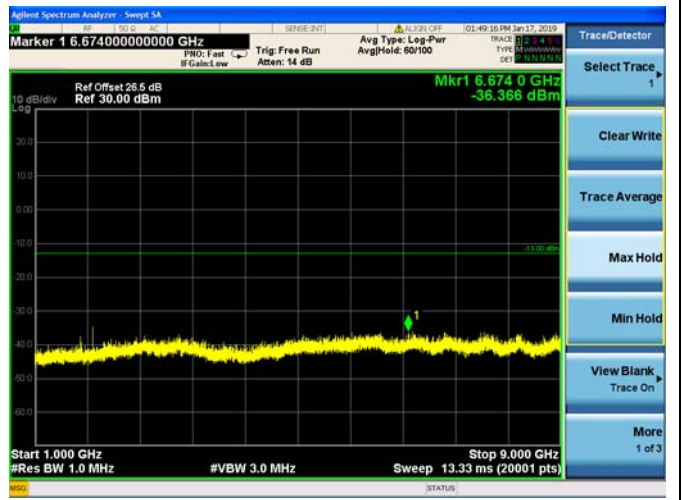
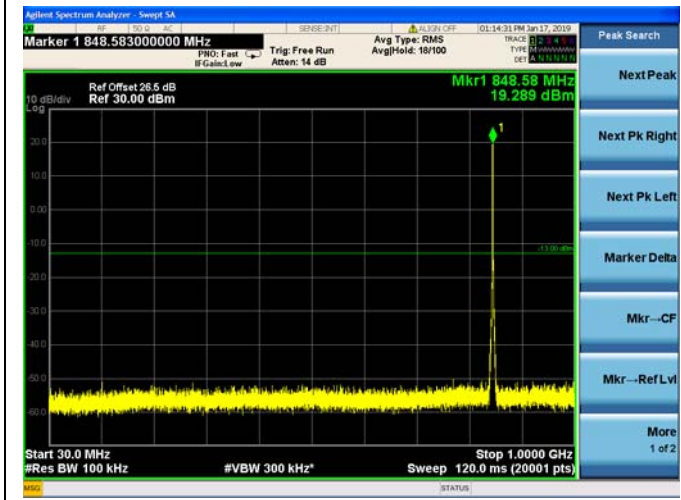

1XEVD0 Rev B BC0, Channel=1013

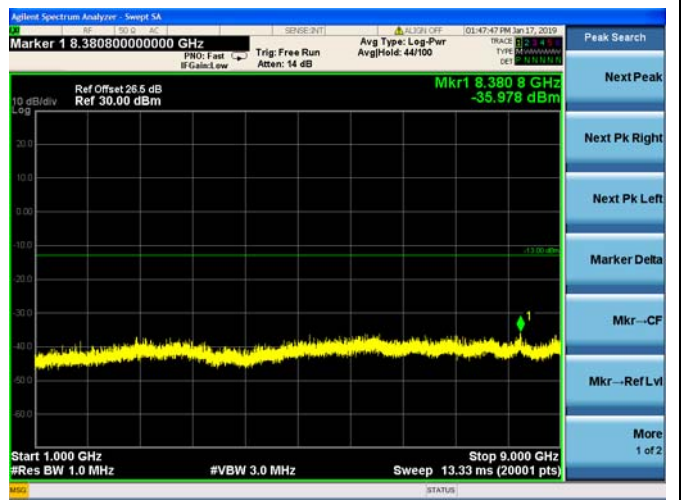
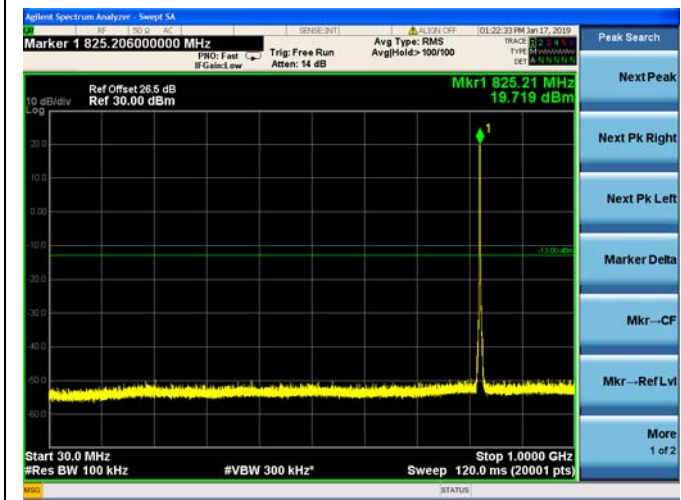

1XEVD0 Rev B BC0, Channel=384

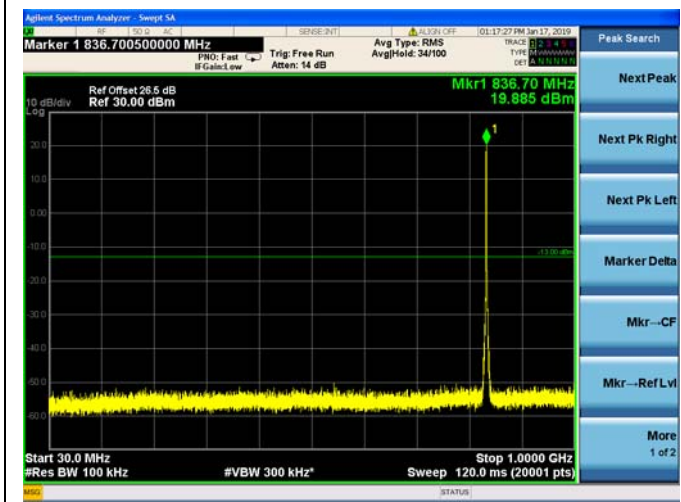



1XEVD0 Rev B BC0, Channel=777

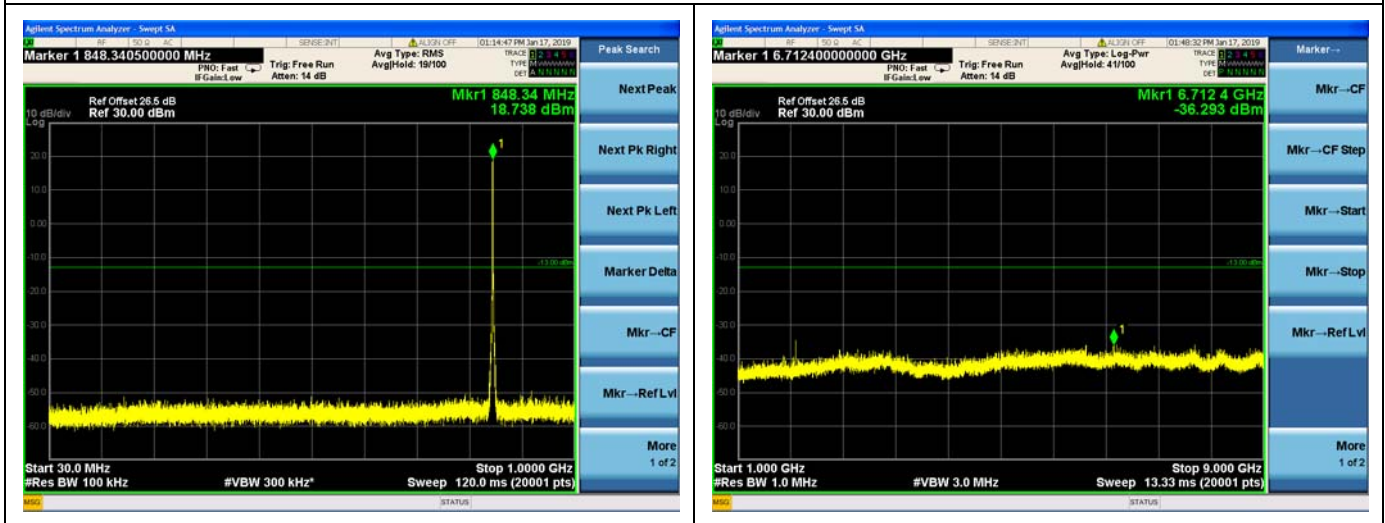

2.6. Band Edge

2.6.1. Requirement

According to FCC section 22.917(a), the power of any emission outside of the authorized operating frequency ranges must be attenuated below the transmitting power (P) by a factor of at least $43 + 10 \log(P)$ dB.

According to FCC section 24.238(a), The power of any emission outside of the authorized operating frequency ranges must be attenuated below the transmitting power (P) by a factor of at least $43 + 10 \log(P)$ dB.

According to FCC section 27.53(g), For operations in the 698–746 MHz band, the power of any emission outside a licensee's frequency band(s) of operation shall be attenuated below the

transmitter power (P) within the licensed band(s) of operation, measured in watts, by at least $43 + 10 \log (P)$ dB. Compliance with this provision is based on the use of measurement instrumentation employing a resolution bandwidth of 100 kilohertz or greater. However, in the 100 kilohertz bands immediately outside and adjacent to a licensee's frequency block, a resolution bandwidth of at least 30 kHz may be employed.

According to FCC section 27.53(h), For operations in the 1710–1755MHz bands, the power of any emission outside a licensee's frequency block shall be attenuated below the transmitter power (P) by at least $43 + 10 \log_{10}(P)$ dB.

According to FCC section 27.53(m) (4), For mobile digital stations, the attenuation factor shall be not less than $40 + 10 \log (P)$ dB on all frequencies between the channel edge and 5 megahertz from the channel edge, $43 + 10 \log (P)$ dB on all frequencies between 5 megahertz and X megahertz from the channel edge, and $55 + 10 \log (P)$ dB on all frequencies more than X megahertz from the channel edge, where X is the greater of 6 megahertz or the actual emission bandwidth as defined in paragraph (m)(6) of this section. In addition, the attenuation factor shall not be less that $43 + 10 \log (P)$ dB on all frequencies between 2490.5 MHz and 2496 MHz and $55 + 10 \log (P)$ dB at or below 2490.5 MHz. Mobile Satellite Service licensees operating on frequencies below 2495 MHz may also submit a documented interference complaint against BRS licensees operating on channel BRS Channel 1 on the same terms and conditions as adjacent channel BRS or EBS licensees.

2.6.2. Test Description

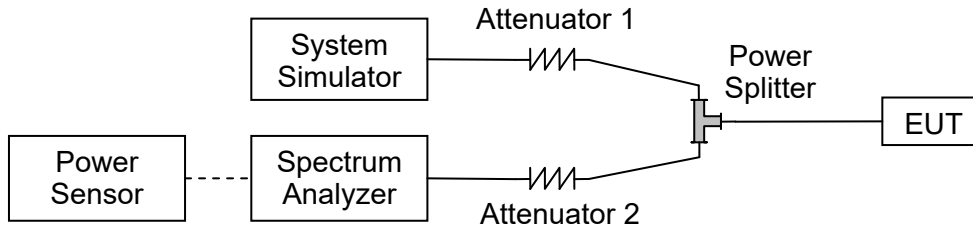

The EUT is coupled to the Spectrum Analyzer (SA) and the System Simulator (SS) with Attenuators through the Power Splitter; the RF load attached to the EUT antenna terminal is 50Ohm; the path loss as the factor is calibrated to correct the reading. The EUT is commanded by the SS to operate at the maximum output power. A call is established between the EUT and the SS.

2.6.3. Test procedure

KDB 971168 D01v03 Section 6.0 and ANSI/TIA-603-E-2016.



2.6.4. Test Result

The center frequency of spectrum is the band edge frequency and span is 2MHz, Record the max trace into the test report.

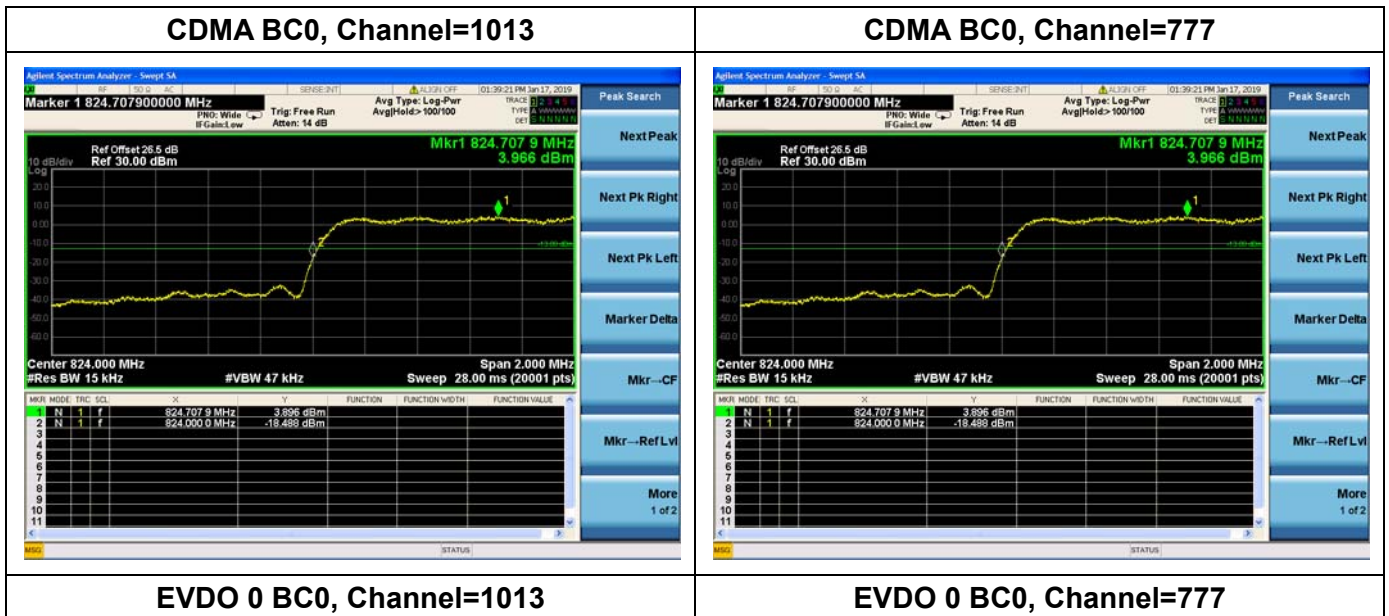



CDMA BC0, Channel=1013

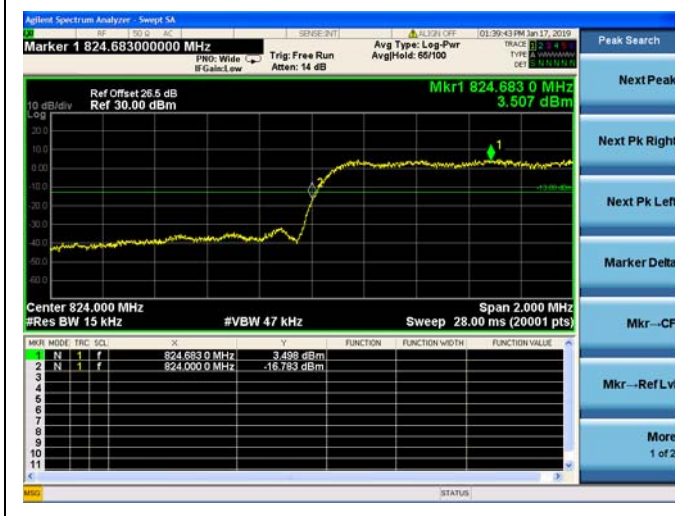

CDMA BC0, Channel=777



EVDO A BC0, Channel=1013

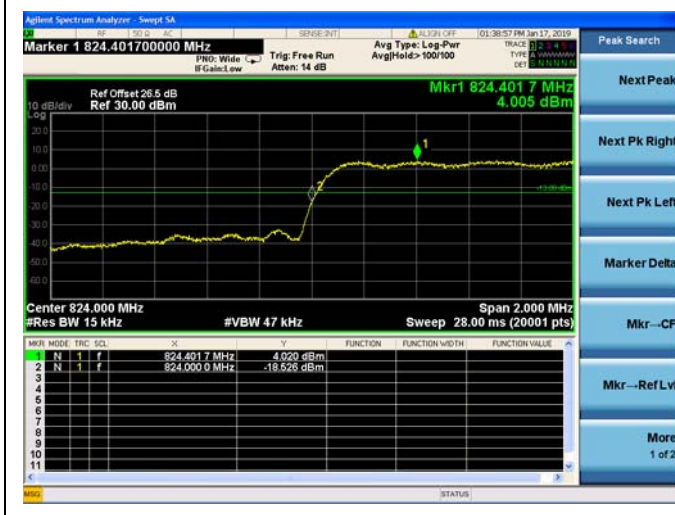

EVDO A BC0, Channel=777





EVDO B BC0, Channel=1013

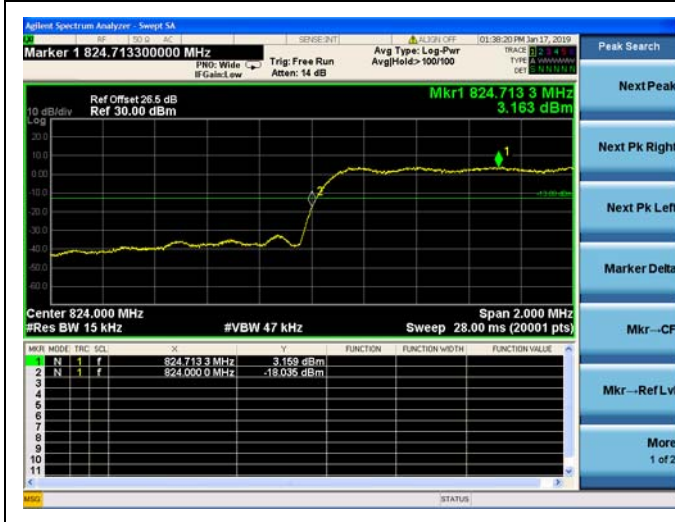

EVDO B BC0, Channel=777



2.7. Transmitter Radiated Power (EIRP/ERP)

2.7.1. Requirement

According to FCC section 24.232 (c) for LTE Band 2, Mobile and portable stations are limited to 2 watts EIRP and the equipment must employ a means for limiting power to the minimum necessary for successful communications.

According to FCC section 27.50 (d) for LTE Band 4, fixed, mobile and portable (hand-held) stations in the 1710-1755MHz band are limited to 1wat EIRP.

According to FCC section22.913 (a.2) for LTE Band 5, the ERP of mobile transmitters and auxiliary test transmitters must not exceed 7 watts.

According to FCC section 27.50 (h) for LTE Band 7, Mobile and other user stations. Mobile stations are limited to 2.0 watts EIRP. All user stations are limited to 2.0 watts transmitter output power.

According to FCC section 27.50 (c) for LTE Band 12/17,66, Portable stations (hand-held devices) operating in the 704-716MHz band are limited to 3watts ERP.

2.7.2. Test Description

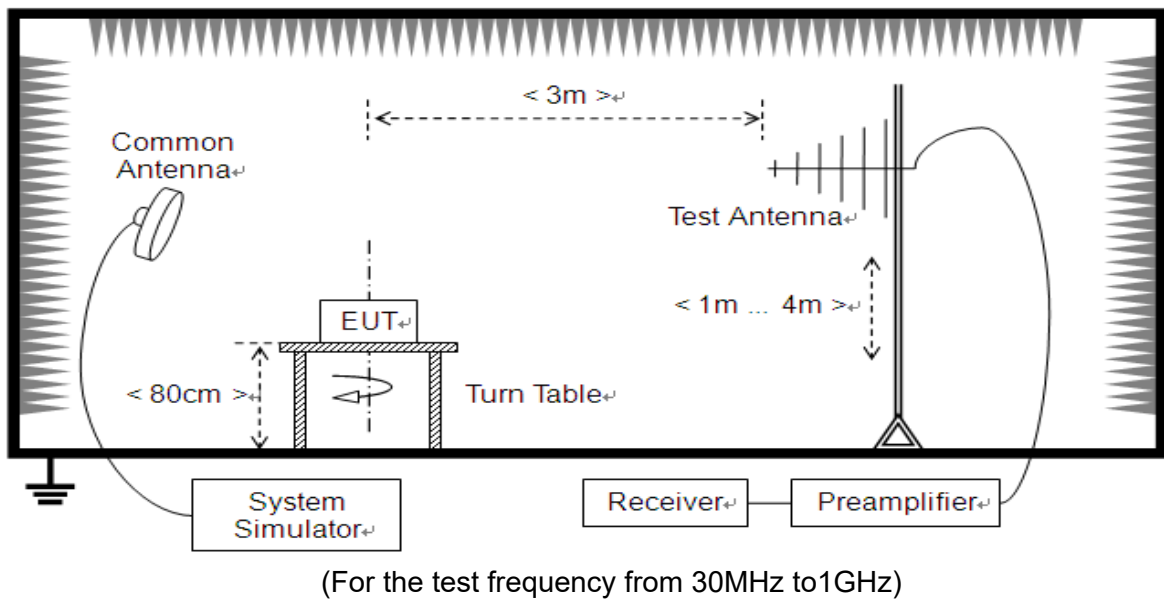

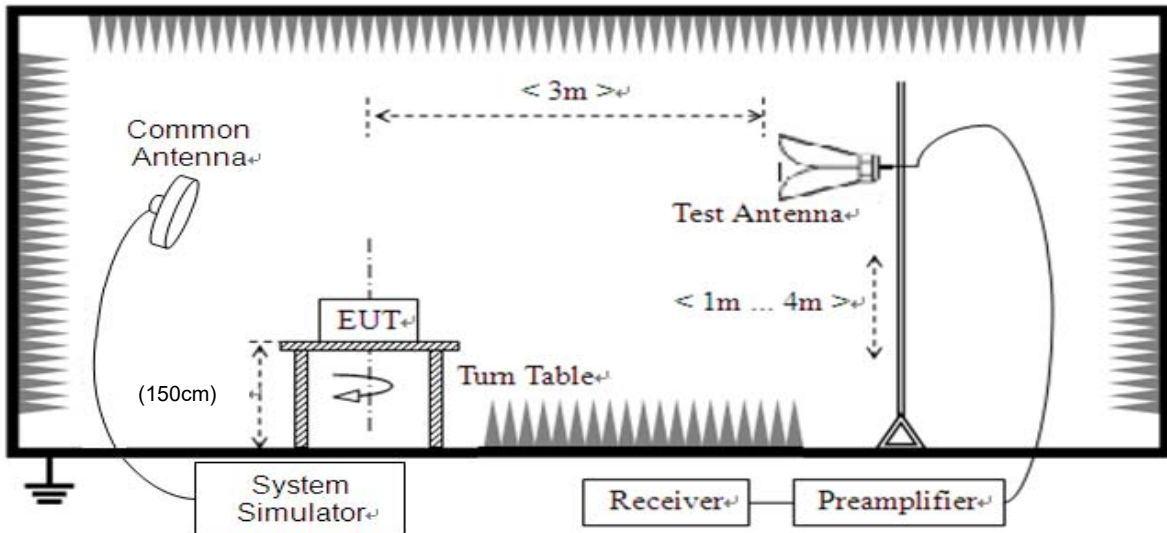

(For the test frequency above 1GHz)

The EUT is located in a 3m Full-Anechoic Chamber, the cable loss, air loss and so on of the site as factors are pre-calibrated using the "Substitution" method, and calculated to correct the reading. A call is established between the EUT and the SS via a Common Antenna. The EUT is commanded by the SS to operate at the maximum and minimum output power, and only the test result of the maximum output power was recorded.

In the frequency range above 30MHz, Bi-Log Test Antenna (30MHz to 1GHz) and Horn Test Antenna (above 1GHz) are used. Test Antenna is 3m away from the EUT. Test Antenna height is varied from 1m to 4m above the ground and the Turn Table is actuated to turn from 0° to 360° to determine the maximum value of the radiated power. The emission levels at both horizontal and vertical polarizations should be tested. The Filters consists of Notch Filters and High Pass Filter.

2.7.3. Test procedure

KDB 971168 D01v03 Section 51&5.2 and ANSI/TIA-603-E-2016.



2.7.4. Test Result

The EUT was verified under all configurations (RB size and offset) and the worst case radiated power reported for each modulation/channel bandwidth.

The Turn Table is actuated to turn from 0° to 360°, and both horizontal and vertical polarizations of the Test Antenna are used to find the maximum radiated power. The lowest, middle and highest channels are tested.

The substitution corrections are obtained as described below:

$$A_{\text{SUBST}} = P_{\text{SUBST_TX}} - P_{\text{SUBST_RX}} - L_{\text{SUBST_CABLES}} + G_{\text{SUBST_TX_ANT}}$$

$$A_{\text{TOT}} = L_{\text{CABLES}} + A_{\text{SUBST}}$$

Where A_{SUBST} is the final substitution correction including receive antenna gain.

$P_{\text{SUBST_TX}}$ is signal generator level,

$P_{\text{SUBST_RX}}$ is receiver level,

$L_{\text{SUBST_CABLES}}$ is cable losses including TX cable,

$G_{\text{SUBST_TX_ANT}}$ is substitution antenna gain.

A_{TOT} is total correction factor including cable loss and substitution correction

During the test, the data of A_{TOT} was added in the Test Spectrum Analyze, so Spectrum Analyze reading is the final values which contain the data of A_{TOT} .

Note: Both horizontal and vertical polarizations of the test antenna are evaluated respectively, only the worst data (horizontal) were recorded in this report.



Top Antenna:

Band	Channel	Frequency (MHz)	Measured ERP			Limit		Verdict
			dBm	W	Refer to Plot	dBm	W	
CDMA (BC0)	1013	824.70	18.403	0.069	Plot A	38.5	7	PASS
	384	836.52	21.115	0.129				PASS
	777	848.31	21.381	0.137				PASS
EVDO 0 (BC0)	1013	824.70	19.035	0.080	Plot B	38.5	7	PASS
	384	836.52	20.284	0.107				PASS
	777	848.31	19.691	0.093				PASS
EVDO A (BC0)	1013	824.70	19.217	0.084	Plot C	38.5	7	PASS
	384	836.52	19.926	0.098				PASS
	777	848.31	19.264	0.084				PASS
EVDO B (BC0)	1013	824.70	19.054	0.080	Plot D	38.5	7	PASS
	384	836.52	20.984	0.125				PASS
	777	848.31	19.620	0.092				PASS

Test Plots:

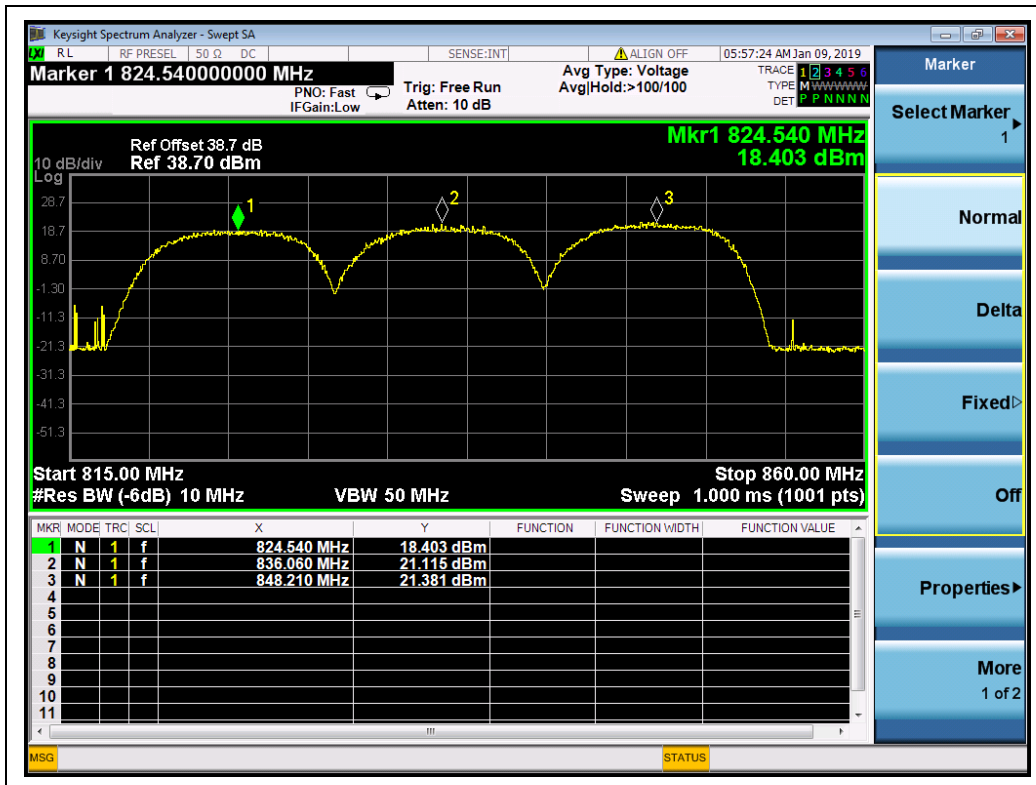

(Plot A, CDMA BC0, Channel = 1013, 384, 777)

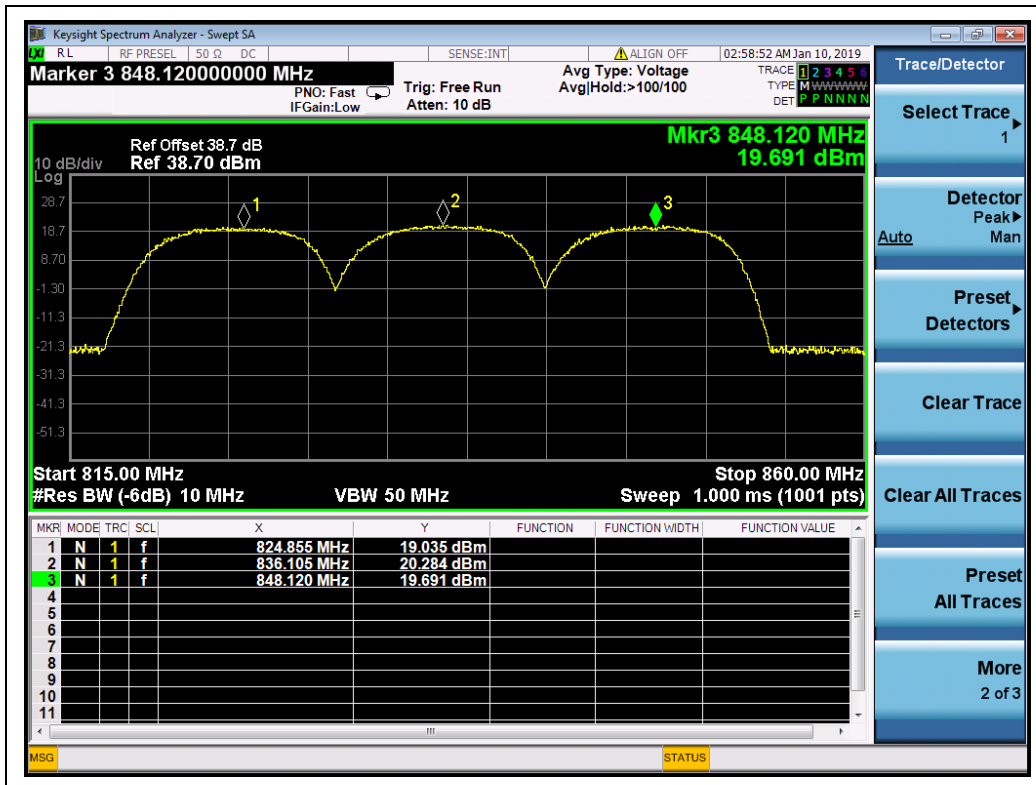

(Plot B, EVDO 0 BC0, Channel = 1013, 384, 777)

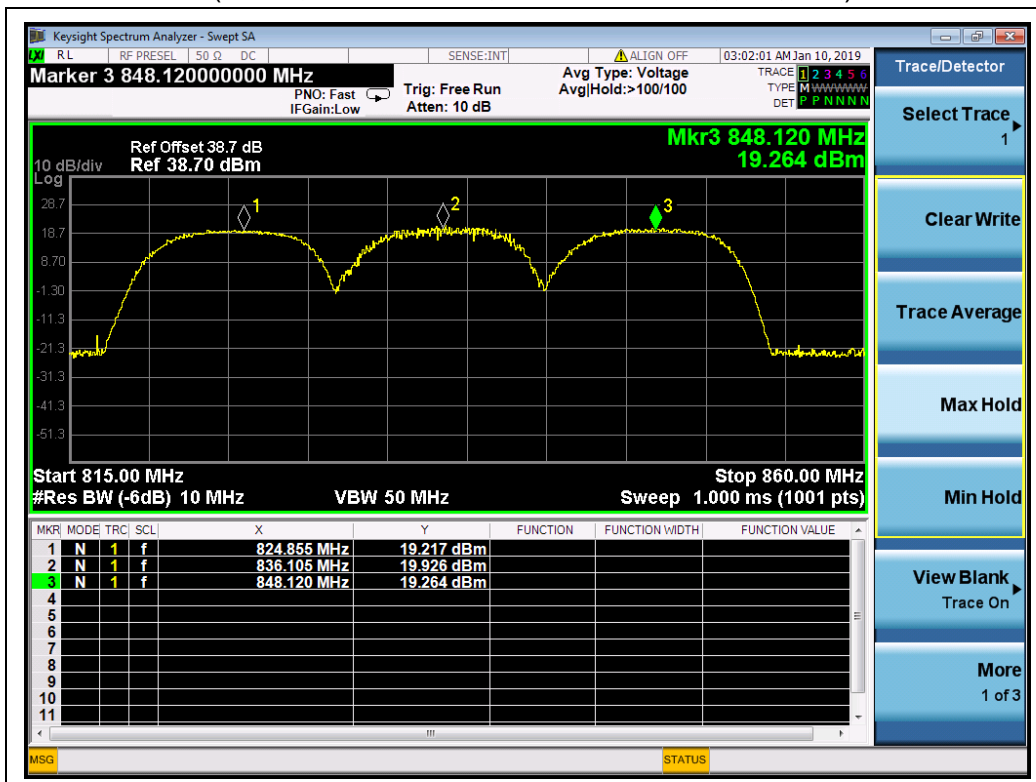

(Plot C, EVDO A BC0, Channel = 1013, 384, 777)

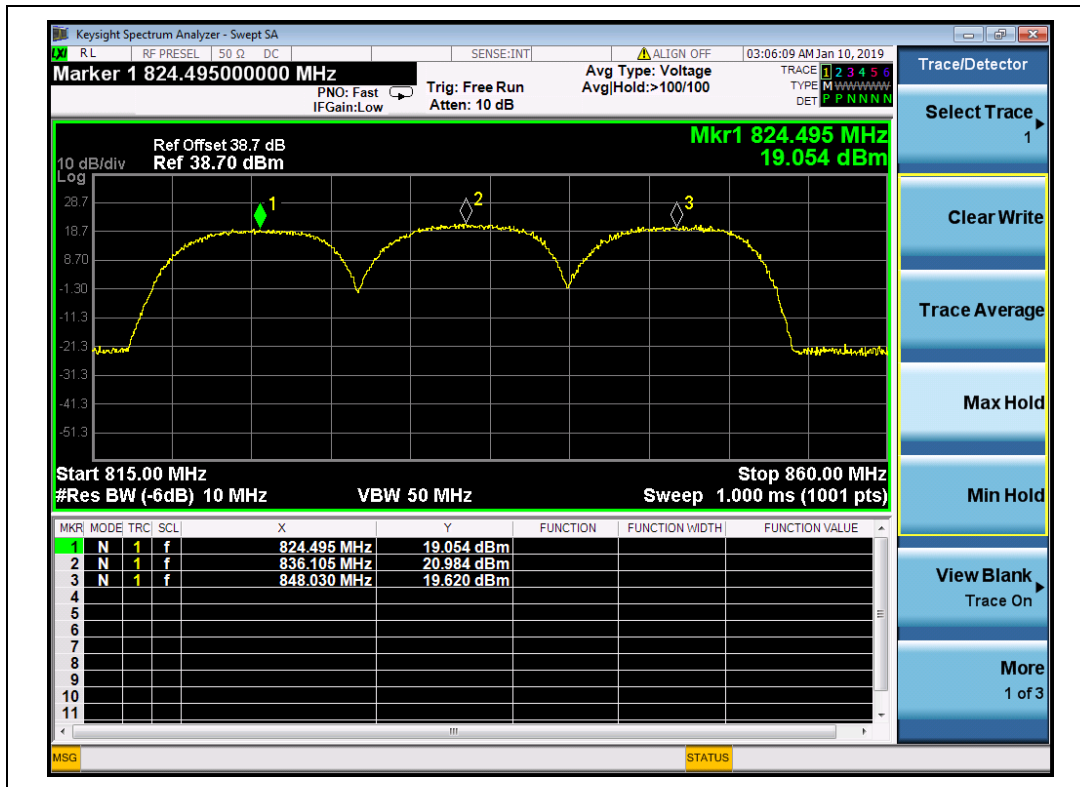

(Plot D, EVDO B BC0, Channel =1013, 384, 777)



Bottom Antenna:

Band	Channel	Frequency (MHz)	Measured ERP			Limit		Verdict
			dBm	W	Refer to Plot	dBm	W	
CDMA (BC0)	1013	824.70	21.083	0.128	Plot E	38.5	7	PASS
	384	836.52	19.459	0.088				PASS
	777	848.31	20.700	0.117				PASS
EVDO 0 (BC0)	1013	824.70	18.796	0.076	PlotF	38.5	7	PASS
	384	836.52	21.123	0.130				PASS
	777	848.31	19.979	0.100				PASS
EVDO A (BC0)	1013	824.70	18.745	0.075	Plot G	38.5	7	PASS
	384	836.52	20.465	0.111				PASS
	777	848.31	19.544	0.090				PASS
EVDO B (BC0)	1013	824.70	19.054	0.080	Plot H	38.5	7	PASS
	384	836.52	21.158	0.131				PASS
	777	848.31	19.810	0.096				PASS

Test Plots:

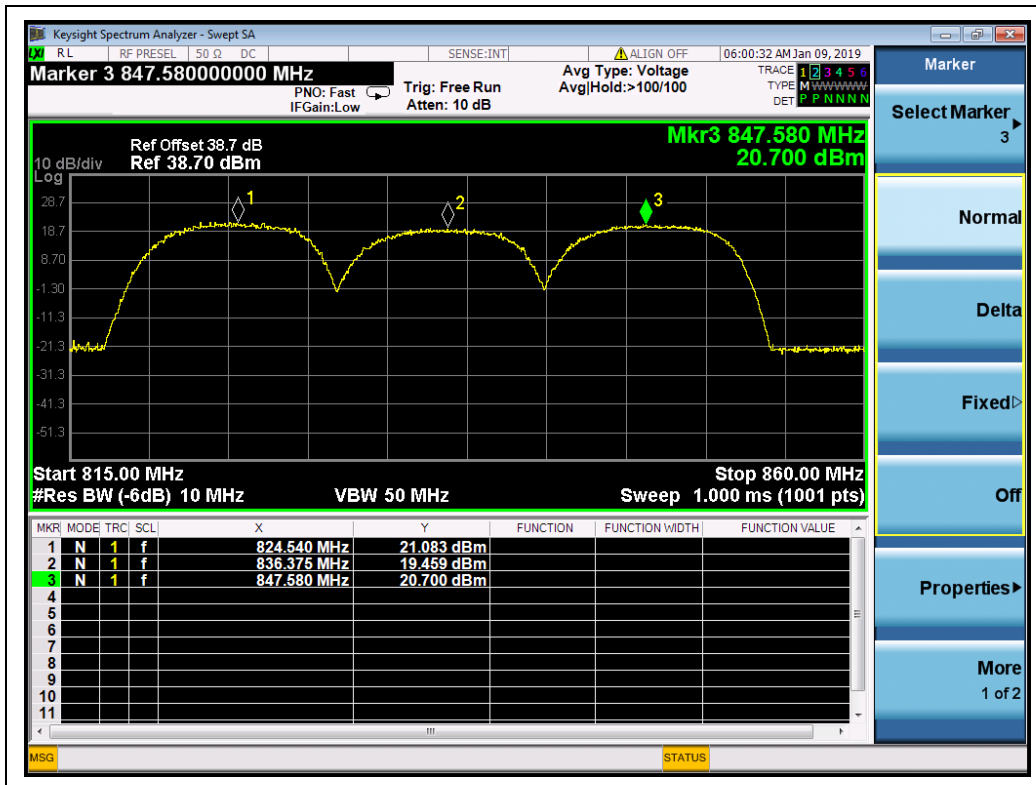

(Plot E, CDMA BC0, Channel = 1013, 384, 777)

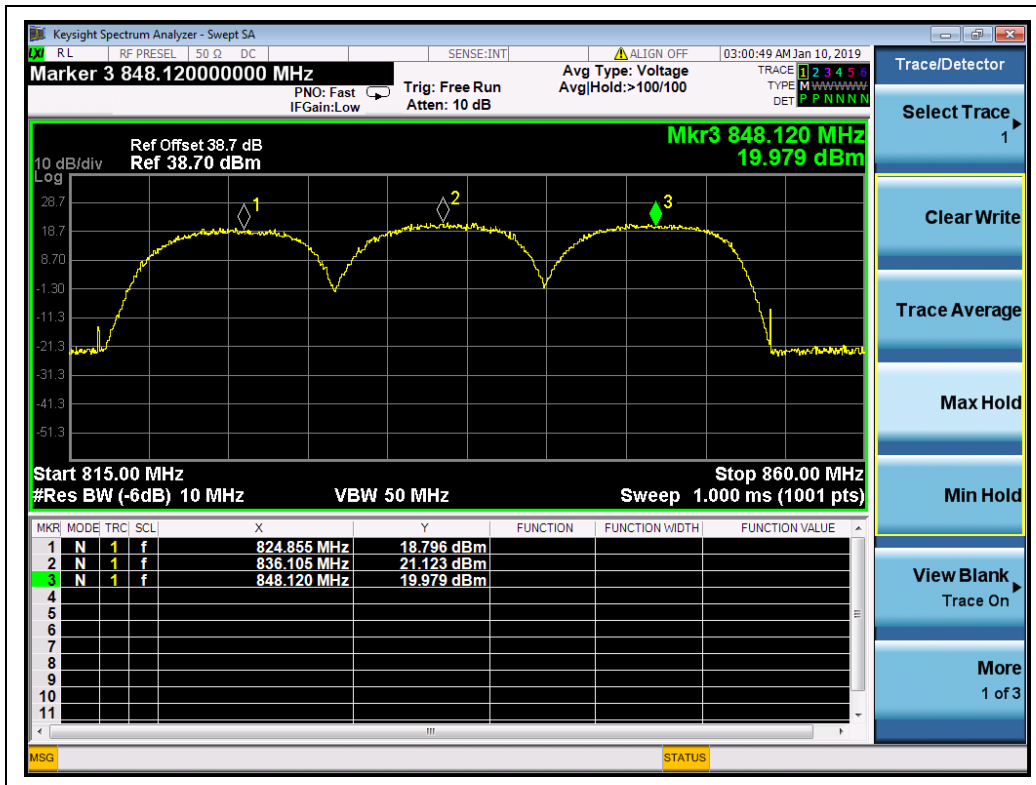

(Plot F, EVDO 0 BC0, Channel = 1013, 384, 777)

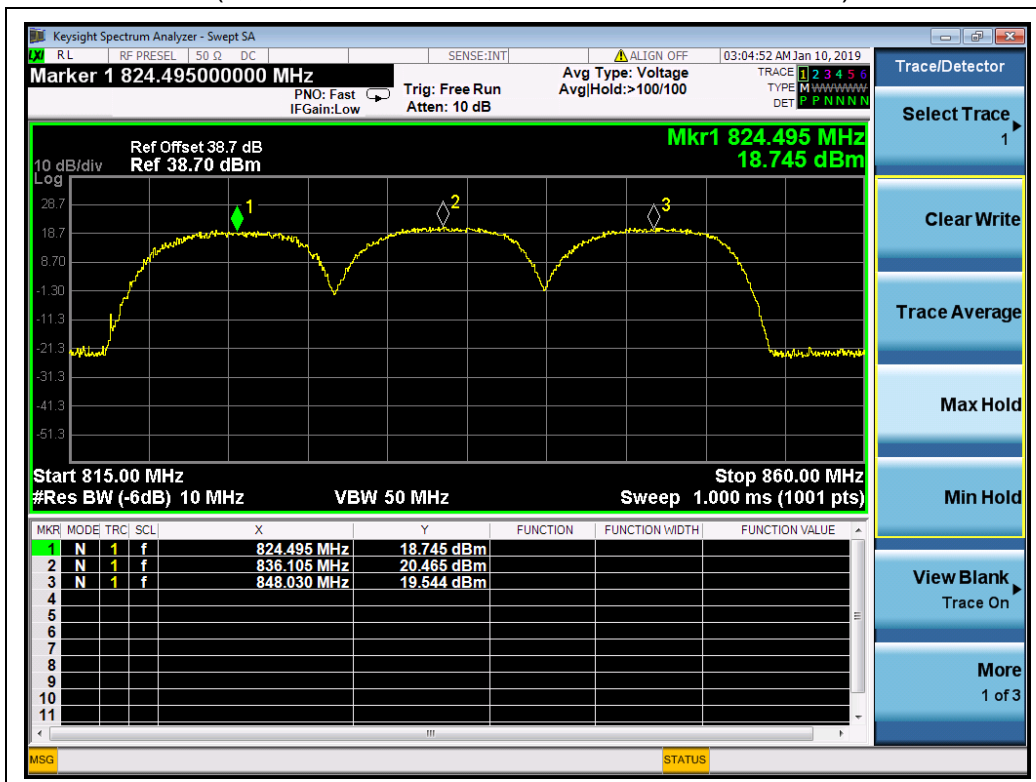

(Plot G, EVDO A BC0, Channel = 1013, 384, 777)

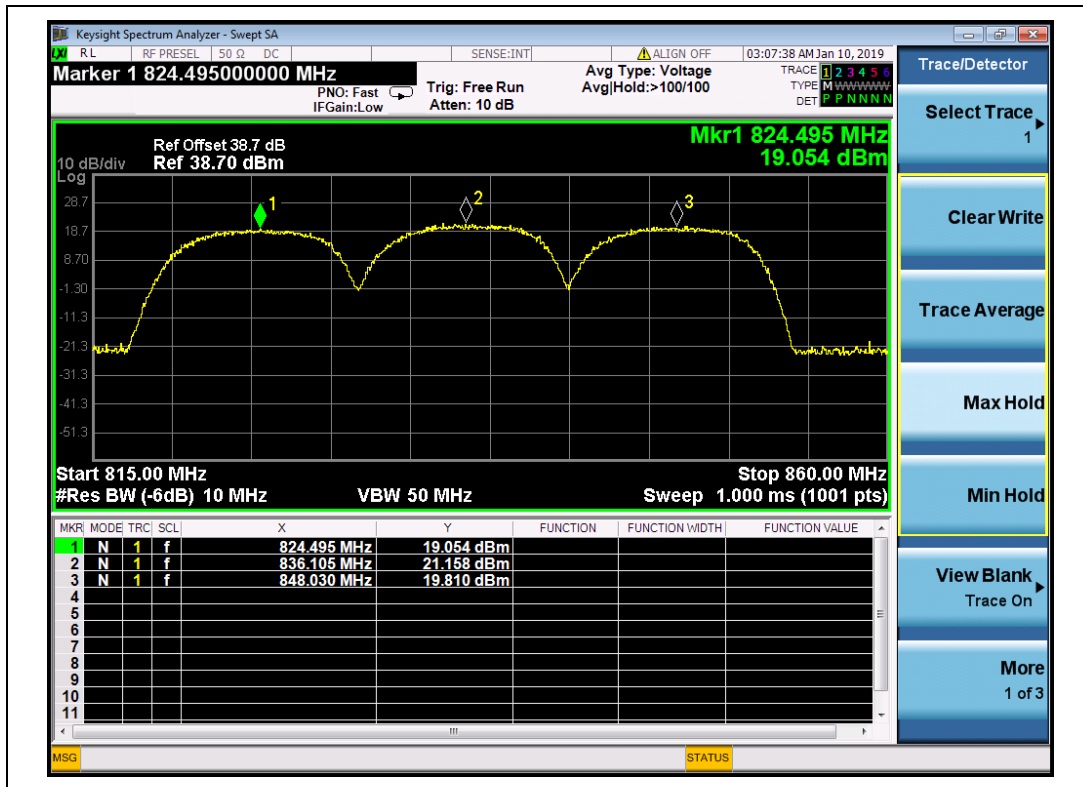

(Plot H, EVDO B BC0, Channel =1013, 384, 777)

2.8. Radiated Spurious Emissions

2.8.1. Requirement

According to FCC section 2.1051, the power of any emission outside of the authorized operating frequency ranges must be attenuated below the transmitting power (P) by a factor of at least $43+10*\log(P)$ dB. This calculated to be -13dBm.

2.8.2. Test Description

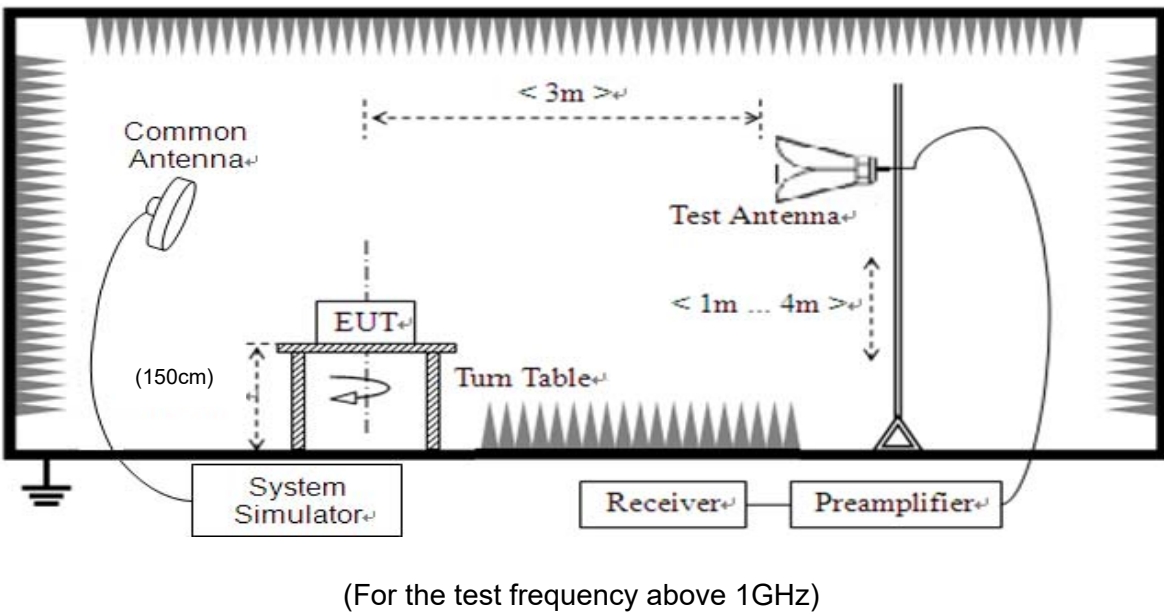
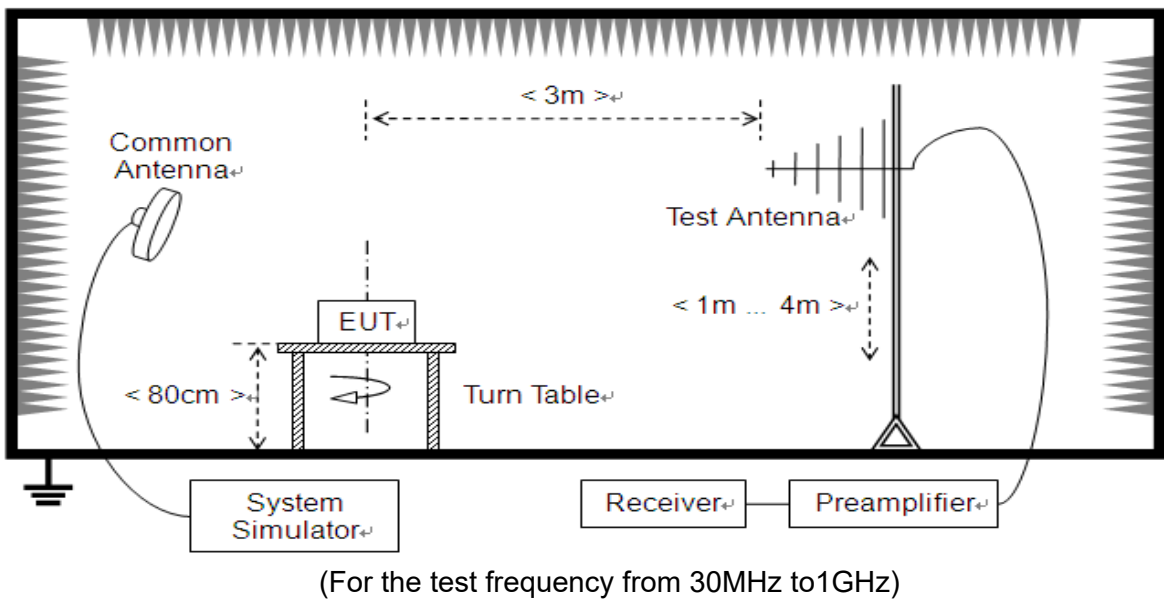



The EUT is located in a 3m Full-Anechoic Chamber, the cable loss, air loss and so on of the site as factors are pre-calibrated using the "Substitution" method, and calculated to correct the reading.

A call is established between the EUT and the SS via a Common Antenna. The EUT is commanded by the SS to operate at the maximum and minimum output power, and only the test result of the maximum output power was recorded.

In the frequency range above 30MHz, Bi-Log Test Antenna (30MHz to 1GHz) and Horn Test Antenna (above 1GHz) are used. Test Antenna is 3m away from the EUT. Test Antenna height is varied from 1m to 4m above the ground and the Turn Table is actuated to turn from 0° to 360° to determine the maximum value of the radiated power. The emission levels at both horizontal and vertical polarizations should be tested. The Filters consists of Notch Filters and High Pass Filter.

Note: when doing measurements above 1GHz, the EUT has been within the 3dB cone width of the horn antenna during horizontal antenna.

2.8.3. Test procedure

KDB 971168 D01v03 Section 5.8 and ANSI/TIA-603-E-2016.

2.8.4. Test Result

The measurement frequency range is from 30MHz to the 10th harmonic of the fundamental frequency. Test Antenna height is varied from 1m to 4m above the ground, and the Turn Table is actuated to turn from 0° to 360°, both horizontal and vertical polarizations of the Test Antenna are used to find the maximum radiated power. Mid channels on all channel bandwidth verified. Only the worst RB size/offset presented.

Note1: The power of the EUT transmitting frequency should be ignored.

Note2: All Spurious Emission tests were performed in X, Y, Z axis direction. And only the worst axis test condition was recorded in this test report.

Note3: All bandwidth and test channel were considered and evaluated respectively by performing full test for each band, only the worst cases were recorded in this test report.



A. Test Verdict:

Top Antenna:

Band	Channel	Frequency (MHz)	Measured Max. Spurious Emission (dBm)		Refer to Plot	Limit (dBm)	Verdict
			Test Antenna Horizontal	Test Antenna Vertical			
CDMA (BC0)	1013	824.7	< -25	< -25	Plot A1/A2	-13	PASS
	384	836.52	< -25	< -25	Plot A3/A4		PASS
	777	848.31	< -25	< -25	Plot A5/A6		PASS
EVDO 0 (BC0)	1013	824.7	< -25	< -25	Plot B1/B2	-13	PASS
	384	836.52	< -25	< -25	Plot B3/B4		PASS
	777	848.31	< -25	< -25	Plot B5/B6		PASS
EVDO A (BC0)	1013	824.7	< -25	< -25	Plot C1/C2	-13	PASS
	384	836.52	< -25	< -25	Plot C3/C4		PASS
	777	848.31	< -25	< -25	Plot C5/C6		PASS
EVDO B (BC0)	1013	824.7	< -25	< -25	Plot D1/D2	-13	PASS
	384	836.52	< -25	< -25	Plot D3/D4		PASS
	777	848.31	< -25	< -25	Plot D5/D6		PASS

B. Test Plots

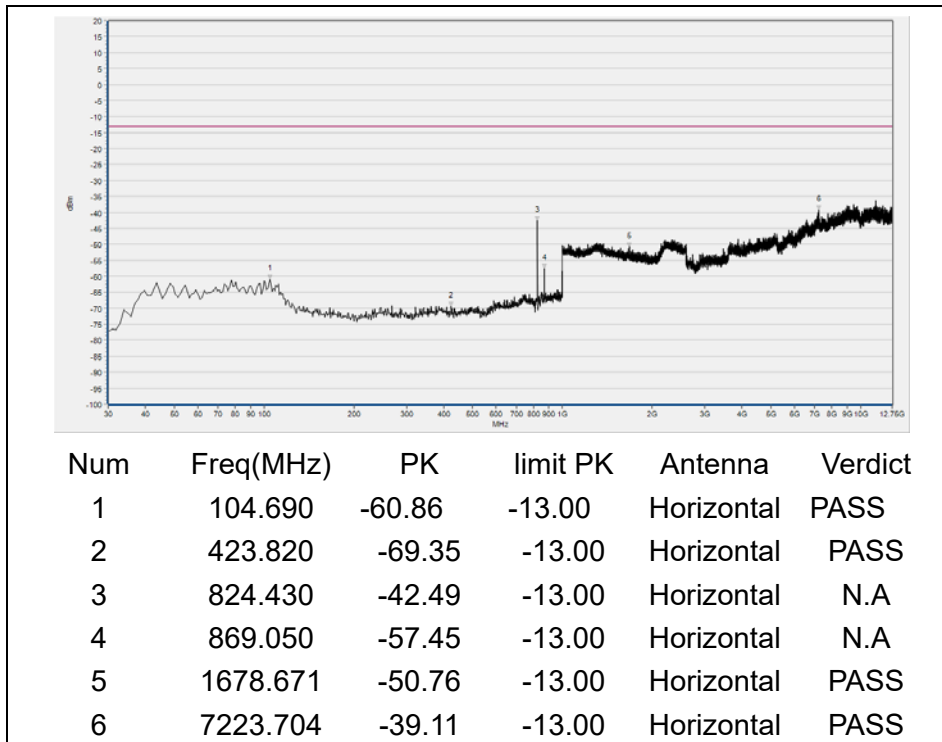

(Plot A1, CDMA BC0, Channel = 1013, Horizontal)

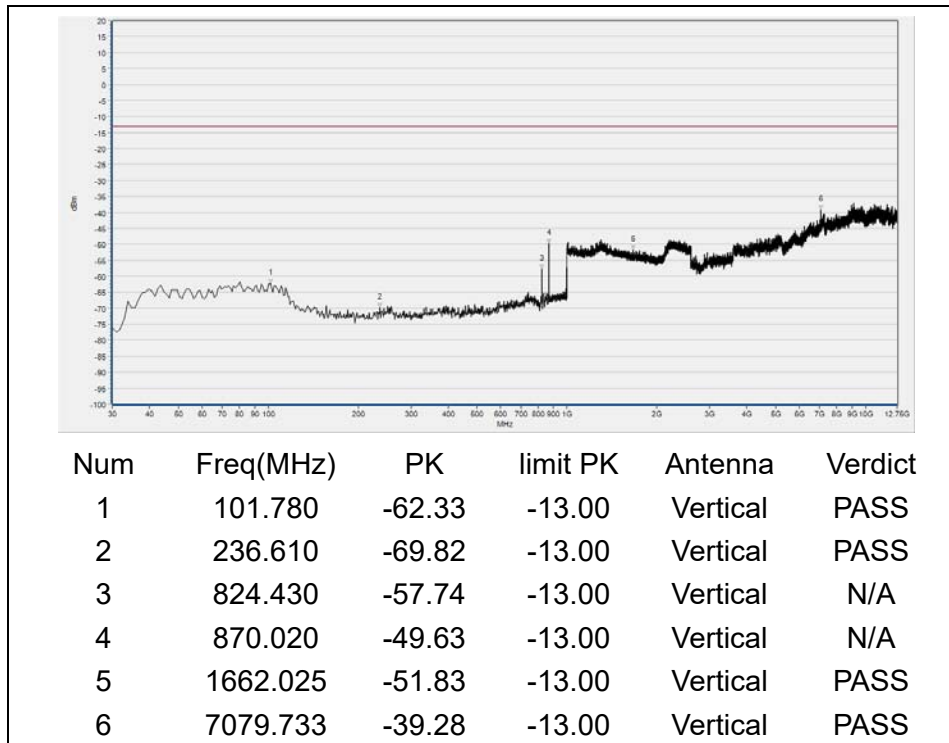

(Plot A2, CDMA BC0, Channel = 1013, Vertical)

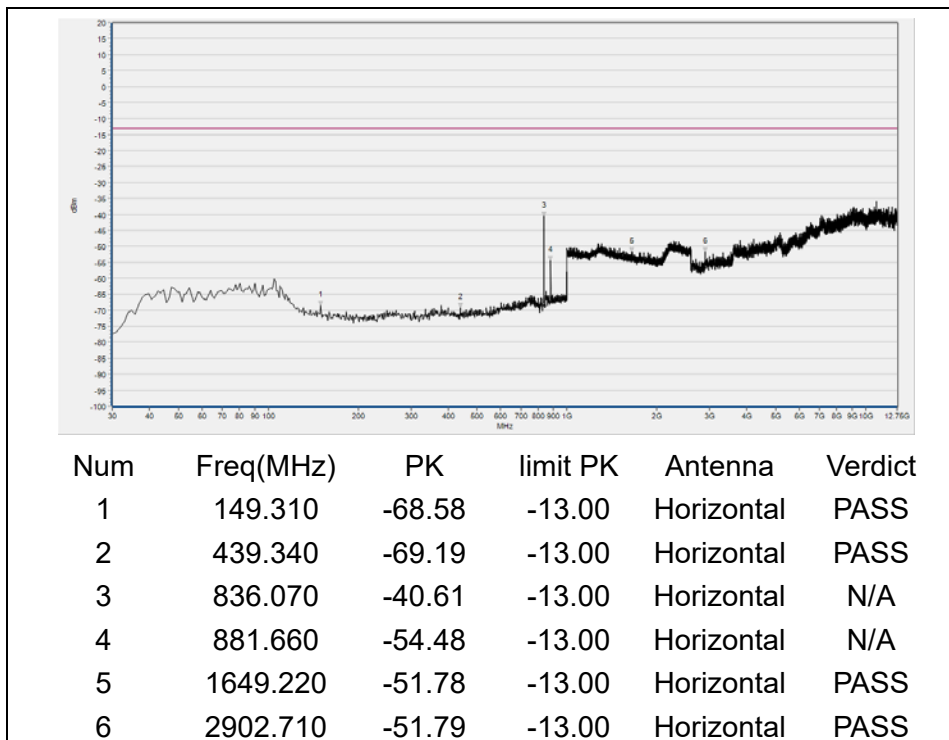

(Plot A3, CDMA BC0, Channel = 384, Horizontal)

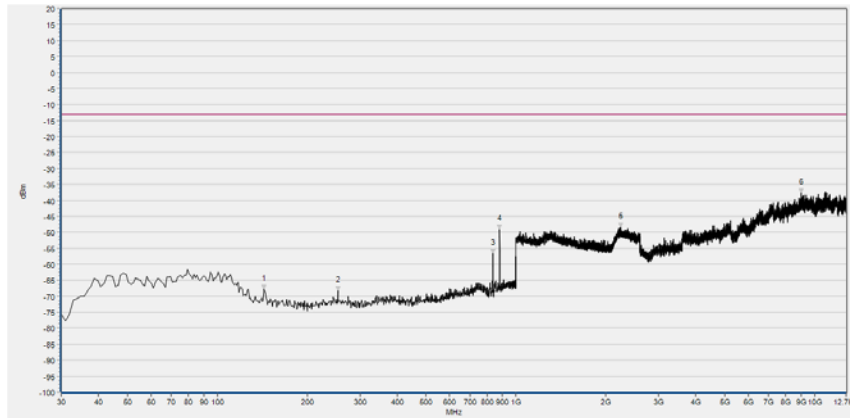

Num	Freq(MHz)	PK	limit PK	Antenna	Verdict
1	143.490	-67.92	-13.00	Vertical	PASS
2	253.100	-68.27	-13.00	Vertical	PASS
3	836.070	-56.71	-13.00	Vertical	N/A
4	881.660	-49.00	-13.00	Vertical	N/A
5	2241.457	-48.28	-13.00	Vertical	PASS
6	9032.579	-37.60	-13.00	Vertical	PASS

(Plot A4, CDMA BC0, Channel = 384, Vertical)

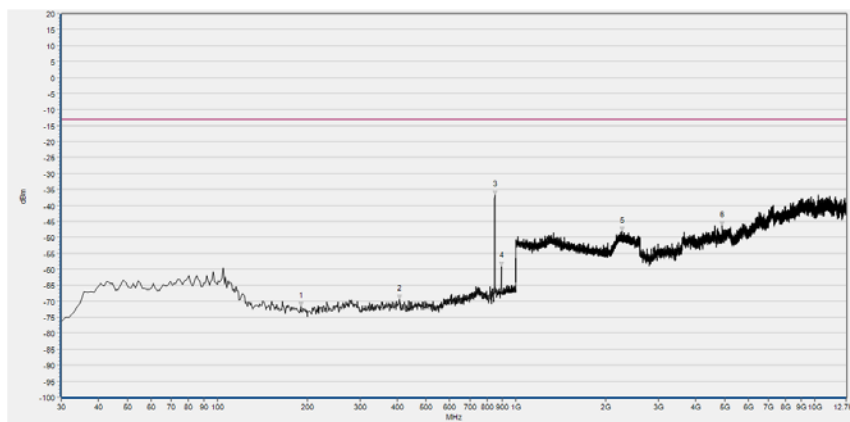

Num	Freq(MHz)	PK	limit PK	Antenna	Verdict
1	191.020	-71.65	-13.00	Horizontal	PASS
2	406.360	-69.28	-13.00	Horizontal	PASS
3	848.680	-36.67	-13.00	Horizontal	N/A
4	893.300	-59.21	-13.00	Horizontal	N/A
5	2260.664	-48.20	-13.00	Horizontal	PASS
6	4907.238	-46.29	-13.00	Horizontal	PASS

(Plot A5, CDMA BC0, Channel = 777, Horizontal)

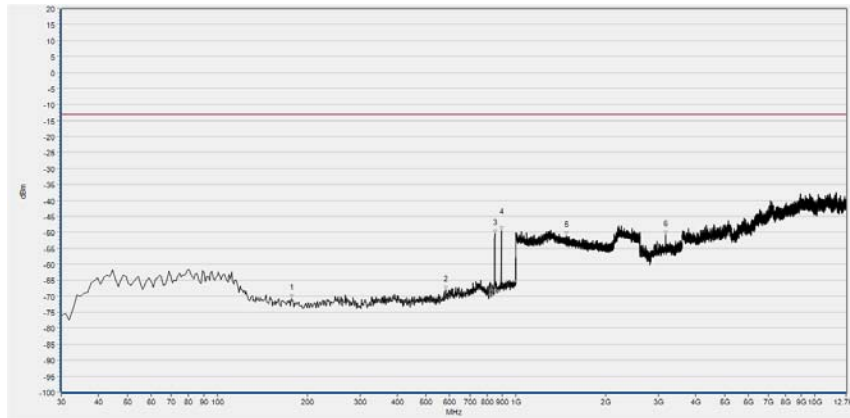

Num	Freq(MHz)	PK	limit PK	Antenna	Verdict
1	177.440	-70.78	-13.00	Vertical	PASS
2	581.930	-67.98	-13.00	Vertical	PASS
3	848.680	-50.33	-13.00	Vertical	N/A
4	893.300	-49.49	-13.00	Vertical	N/A
5	1471.869	-50.99	-13.00	Vertical	PASS
6	3162.966	-50.83	-13.00	Vertical	PASS

(Plot A6, CDMA BC0, Channel = 777, Vertical)

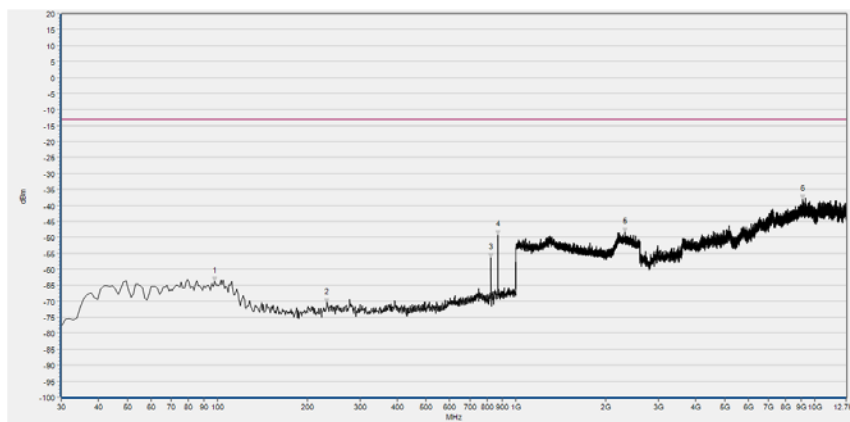

Num	Freq(MHz)	PK	limit PK	Antenna	Verdict
1	97.900	-63.80	-13.00	Horizontal	PASS
2	232.730	-70.47	-13.00	Horizontal	PASS
3	824.430	-56.45	-13.00	Horizontal	N/A
4	869.050	-49.32	-13.00	Horizontal	N/A
5	2315.086	-48.39	-13.00	Horizontal	PASS
6	9119.331	-38.02	-13.00	Horizontal	PASS

(Plot B1, EVDO 0 BC0, Channel = 1013, Horizontal)

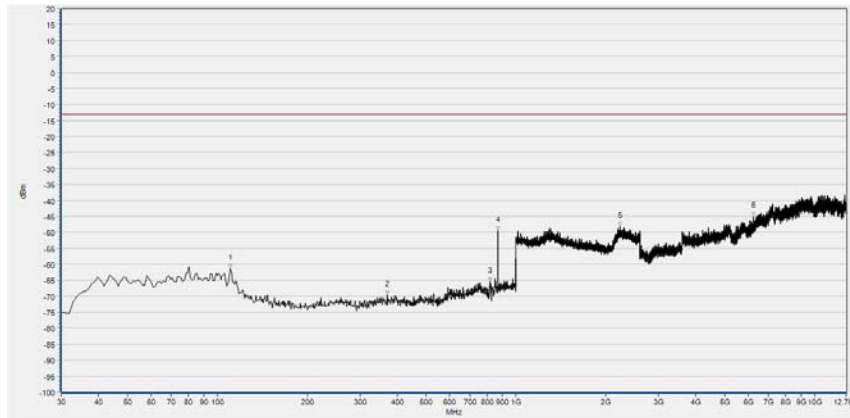

Num	Freq(MHz)	PK	limit PK	Antenna	Verdict
1	110.510	-61.25	110.510	Vertical	PASS
2	370.470	-69.62	370.470	Vertical	PASS
3	819.580	-65.31	819.580	Vertical	N/A
4	870.020	-49.54	870.020	Vertical	N/A
5	2229.932	-48.21	2229.932	Vertical	PASS
6	6247.281	-44.94	6247.281	Vertical	PASS

(Plot B2, EVDO 0 BC0, Channel = 1013, Vertical)

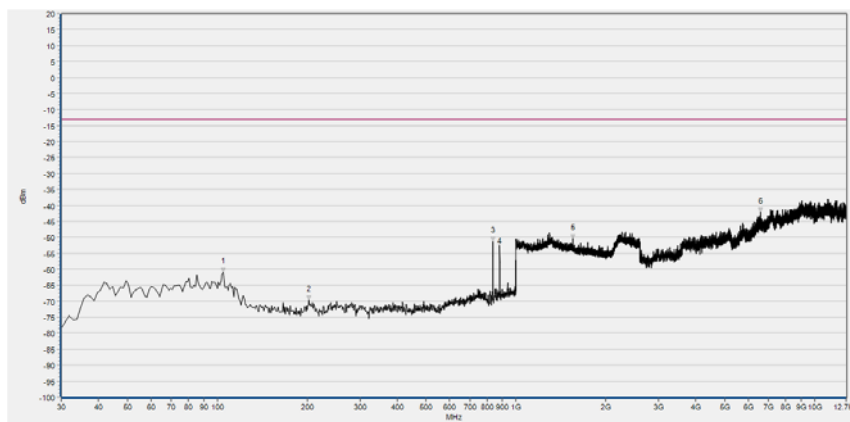

Num	Freq(MHz)	PK	limit PK	Antenna	Verdict
1	104.690	-60.84	-13.00	Horizontal	PASS
2	202.660	-69.72	-13.00	Horizontal	PASS
3	836.070	-51.35	-13.00	Horizontal	N/A
4	881.660	-52.74	-13.00	Horizontal	N/A
5	1550.620	-50.42	-13.00	Horizontal	PASS
6	6579.524	-42.05	-13.00	Horizontal	PASS

(Plot B3, EVDO 0 BC0, Channel = 384, Horizontal)

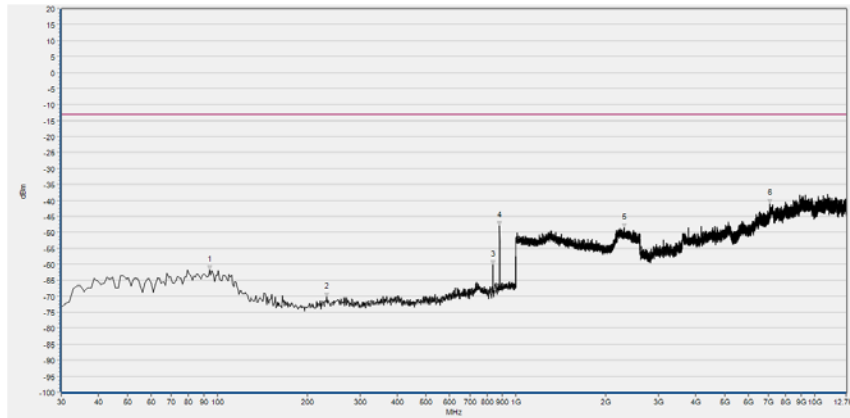

Num	Freq(MHz)	PK	limit PK	Antenna	Verdict
1	94.020	-61.90	-13.00	Vertical	PASS
2	231.760	-70.34	-13.00	Vertical	PASS
3	836.070	-60.31	-13.00	Vertical	N/A
4	881.660	-48.00	-13.00	Vertical	N/A
5	2304.842	-48.58	-13.00	Vertical	PASS
6	7063.121	-40.96	-13.00	Vertical	PASS

(Plot B4, EVDO 0 BC0, Channel = 384, Vertical)

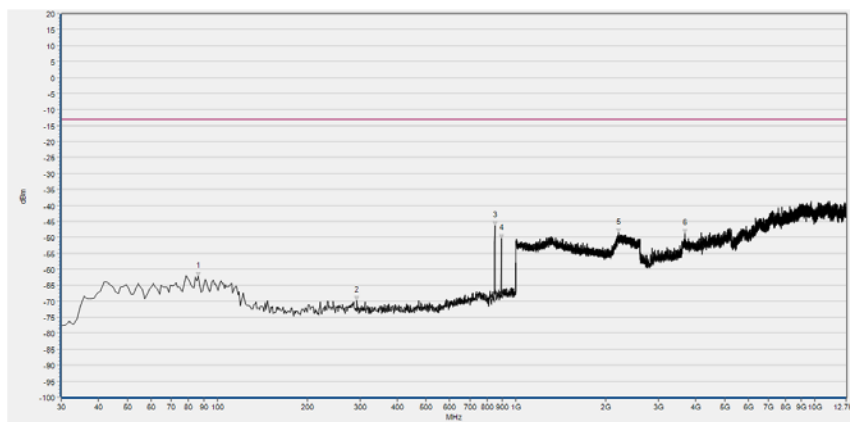

Num	Freq(MHz)	PK	limit PK	Antenna	Verdict
1	86.260	-62.32	-13.00	Horizontal	PASS
2	292.870	-69.80	-13.00	Horizontal	PASS
3	848.680	-46.31	-13.00	Horizontal	N/A
4	893.300	-50.43	-13.00	Horizontal	N/A
5	2204.962	-48.70	-13.00	Horizontal	PASS
6	3676.096	-48.87	-13.00	Horizontal	PASS

(Plot B5, EVDO 0 BC0, Channel = 777, Horizontal)

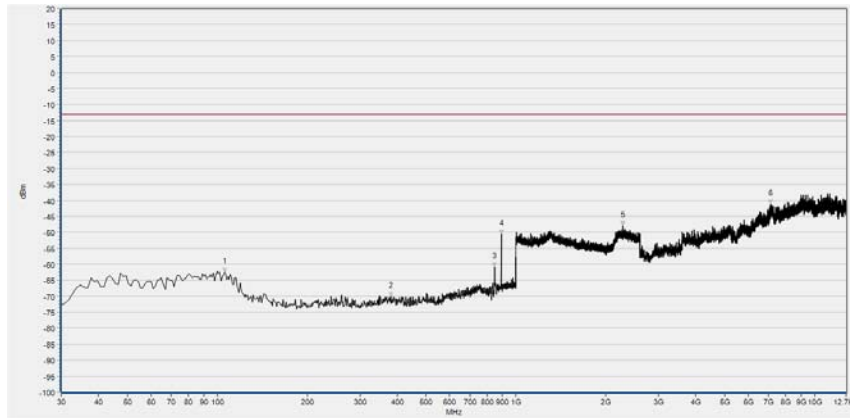

Num	Freq(MHz)	PK	limit PK	Antenna	Verdict
1	105.660	-62.45	-13.00	Vertical	PASS
2	381.140	-70.02	-13.00	Vertical	PASS
3	847.710	-60.84	-13.00	Vertical	N/A
4	893.300	-50.66	-13.00	Vertical	N/A
5	2272.189	-48.00	-13.00	Vertical	PASS
6	7122.186	-41.13	-13.00	Vertical	PASS

(Plot B6, EVDO 0 BC0, Channel = 777, Vertical)

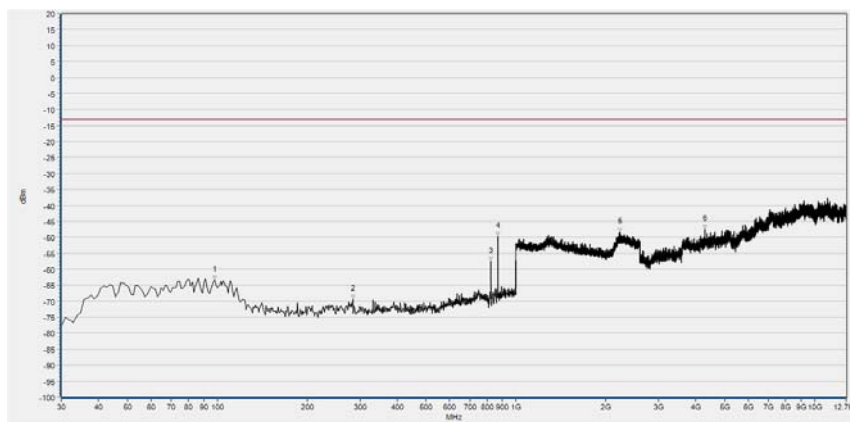

Num	Freq(MHz)	PK	limit PK	Antenna	Verdict
1	97.900	-63.36	-13.00	Horizontal	PASS
2	284.140	-69.40	-13.00	Horizontal	PASS
3	824.430	-57.61	-13.00	Horizontal	N/A
4	870.020	-49.82	-13.00	Horizontal	N/A
5	2224.170	-48.43	-13.00	Horizontal	PASS
6	4298.127	-47.55	-13.00	Horizontal	PASS

(Plot C1, EVDO A BC0, Channel = 1013, Horizontal)

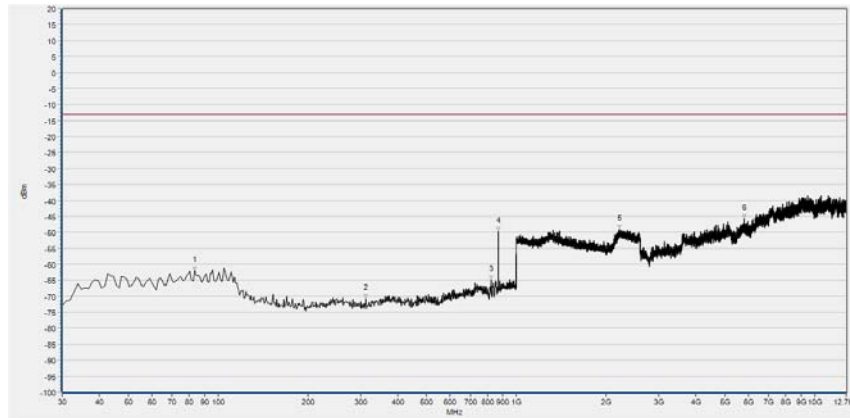

Num	Freq(MHz)	PK	limit PK	Antenna	Verdict
1	83.350	-62.10	-13.00	Vertical	PASS
2	313.240	-70.82	-13.00	Vertical	PASS
3	824.430	-64.89	-13.00	Vertical	N/A
4	870.020	-49.67	-13.00	Vertical	N/A
5	2220.968	-49.06	-13.00	Vertical	PASS
6	5813.521	-45.80	-13.00	Vertical	PASS

(Plot C2, EVDO A BC0, Channel = 1013, Vertical)

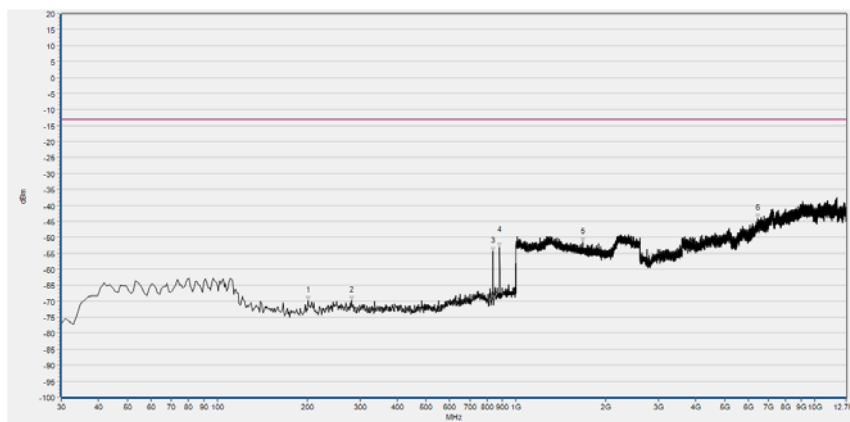

Num	Freq(MHz)	PK	limit PK	Antenna	Verdict
1	201.690	-69.92	-13.00	Horizontal	PASS
2	281.230	-69.78	-13.00	Horizontal	PASS
3	836.070	-54.39	-13.00	Horizontal	N/A
4	881.660	-53.04	-13.00	Horizontal	N/A
5	1674.190	-51.48	-13.00	Horizontal	PASS
6	6444.781	-44.24	-13.00	Horizontal	PASS

(Plot C3, EVDO A BC0, Channel = 384, Horizontal)

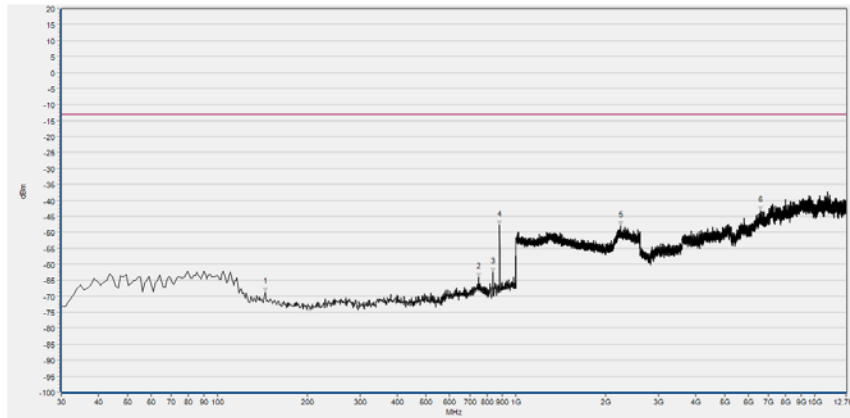

Num	Freq(MHz)	PK	limit PK	Antenna	Verdict
1	144.460	-68.64	-13.00	Vertical	PASS
2	747.800	-64.07	-13.00	Vertical	PASS
3	836.070	-62.44	-13.00	Vertical	N/A
4	881.660	-47.62	-13.00	Vertical	N/A
5	2240.176	-47.97	-13.00	Vertical	PASS
6	6581.369	-43.31	-13.00	Vertical	PASS

(Plot C4, EVDO A BC0, Channel = 384, Vertical)

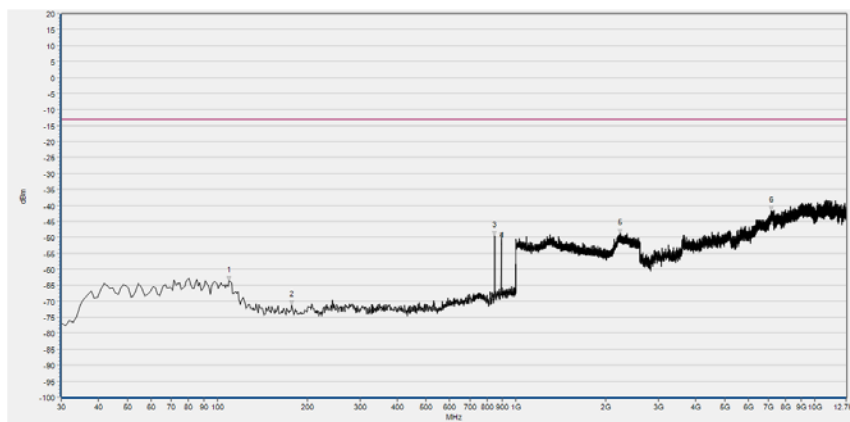

Num	Freq(MHz)	PK	limit PK	Antenna	Verdict
1	109.540	-63.61	-13.00	Horizontal	PASS
2	177.440	-71.09	-13.00	Horizontal	PASS
3	847.710	-49.56	-13.00	Horizontal	N/A
4	893.300	-50.02	-13.00	Horizontal	N/A
5	2233.133	-48.92	-13.00	Horizontal	PASS
6	7172.022	-41.71	-13.00	Horizontal	PASS

(Plot C5, EVDO A BC0, Channel = 777, Horizontal)

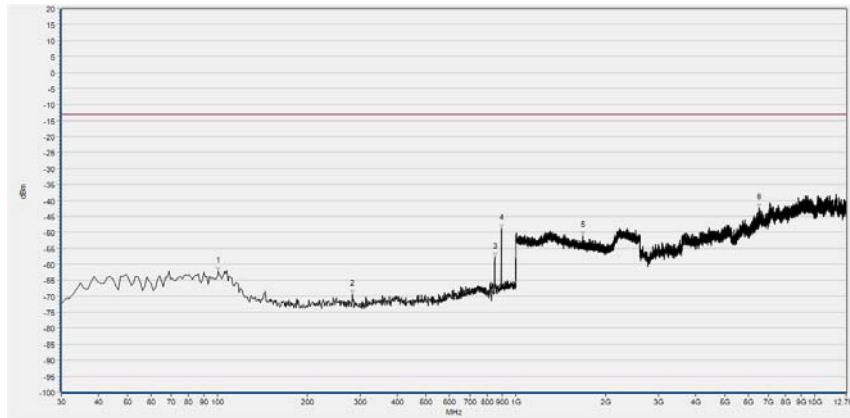

Num	Freq(MHz)	PK	limit PK	Antenna	Verdict
1	100.810	-62.32	-13.00	Vertical	PASS
2	283.170	-69.41	-13.00	Vertical	PASS
3	848.680	-57.86	-13.00	Vertical	N/A
4	893.300	-48.89	-13.00	Vertical	N/A
5	1672.909	-51.15	-13.00	Vertical	PASS
6	6514.921	-42.36	-13.00	Vertical	PASS

(Plot C6, EVDO A BC0, Channel = 777, Vertical)

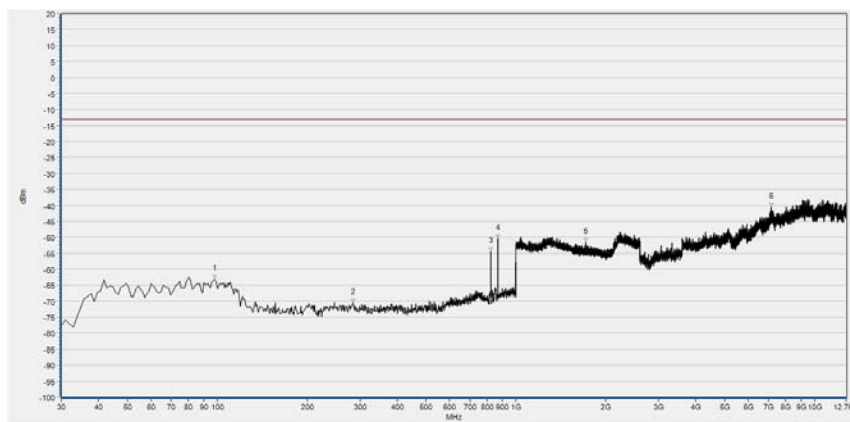

Num	Freq(MHz)	PK	limit PK	Antenna	Verdict
1	97.900	-63.19	-13.00	Horizontal	PASS
2	285.110	-70.49	-13.00	Horizontal	PASS
3	824.430	-54.39	-13.00	Horizontal	N.A
4	870.020	-50.34	-13.00	Horizontal	N.A
5	1707.483	-51.53	-13.00	Horizontal	PASS
6	7170.176	-40.62	-13.00	Horizontal	PASS

(Plot D1, EVDO B BC0, Channel = 1013, Horizontal)

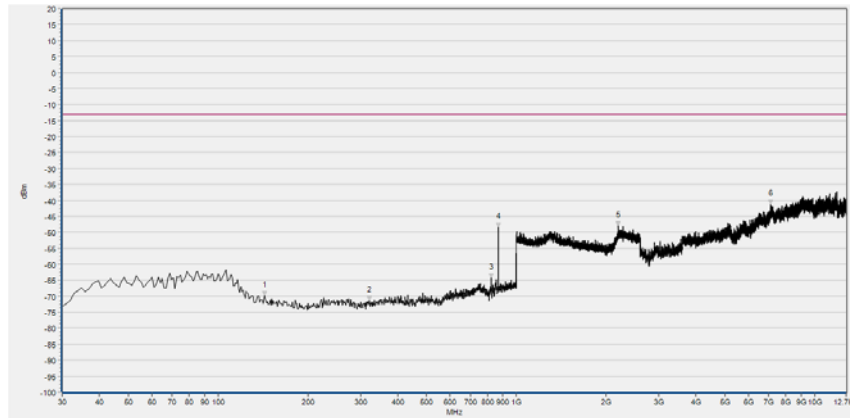

Num	Freq(MHz)	PK	limit PK	Antenna	Verdict
1	143.490	-69.93	-13.00	Vertical	PASS
2	321.970	-71.32	-13.00	Vertical	PASS
3	824.430	-64.24	-13.00	Vertical	N.A
4	870.020	-48.47	-13.00	Vertical	N.A
5	2197.919	-47.94	-13.00	Vertical	PASS
6	7131.415	-41.17	-13.00	Vertical	PASS

(Plot D2, EVDO B BC0, Channel = 1013, Vertical)

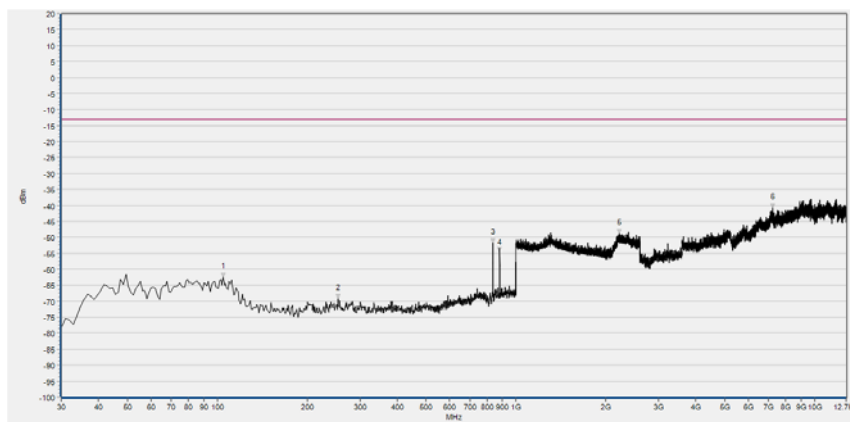

Num	Freq(MHz)	PK	limit PK	Antenna	Verdict
1	104.690	-62.38	-13.00	Horizontal	PASS
2	253.100	-69.25	-13.00	Horizontal	PASS
3	836.070	-51.67	-13.00	Horizontal	N.A
4	880.690	-54.41	-13.00	Horizontal	N.A
5	2212.645	-48.90	-13.00	Horizontal	PASS
6	7251.391	-40.81	-13.00	Horizontal	PASS

(Plot D3, EVDO B BC0, Channel =384, Horizontal)

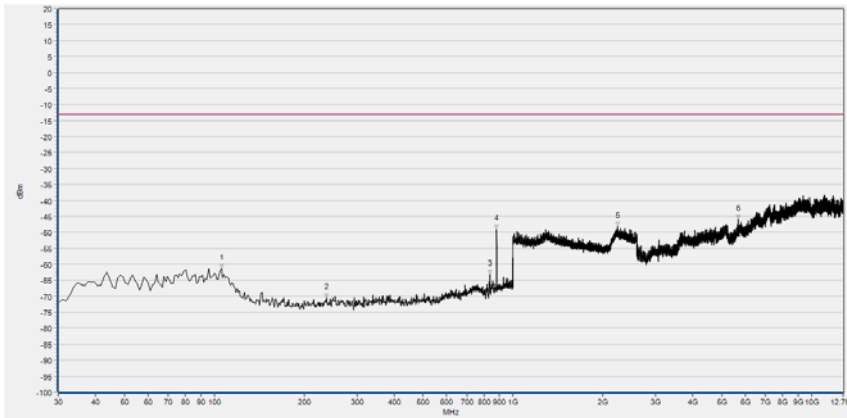

Num	Freq(MHz)	PK	limit PK	Antenna	Verdict
1	105.660	-61.34	-13.00	Vertical	PASS
2	237.580	-70.50	-13.00	Vertical	PASS
3	836.070	-63.12	-13.00	Vertical	N.A
4	881.660	-49.08	-13.00	Vertical	N.A
5	2243.377	-48.23	-13.00	Vertical	PASS
6	5673.241	-46.03	-13.00	Vertical	PASS

(Plot D4, EVDO B BC0, Channel =384, Vertical)

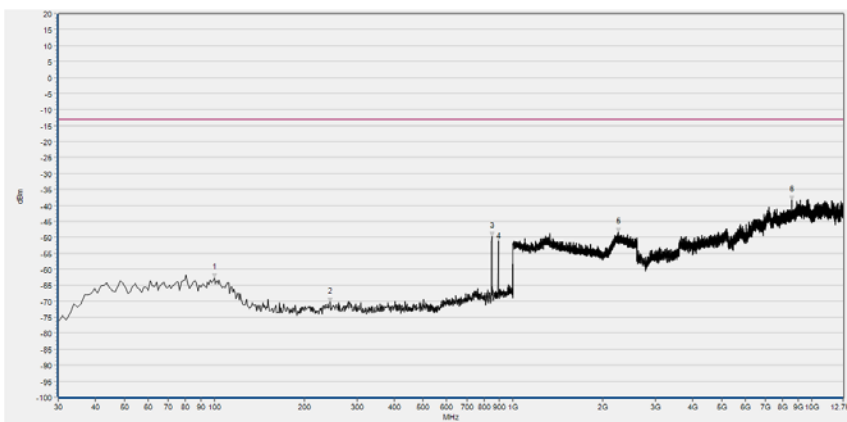

Num	Freq(MHz)	PK	limit PK	Antenna	Verdict
1	99.840	-62.65	-13.00	Horizontal	PASS
2	244.370	-70.39	-13.00	Horizontal	PASS
3	848.680	-49.82	-13.00	Horizontal	N.A
4	893.300	-51.15	-13.00	Horizontal	N.A
5	2257.463	-48.33	-13.00	Horizontal	PASS
6	8563.748	-38.31	-13.00	Horizontal	PASS

(Plot D5, EVDO B BC0, Channel = 777, Horizontal)

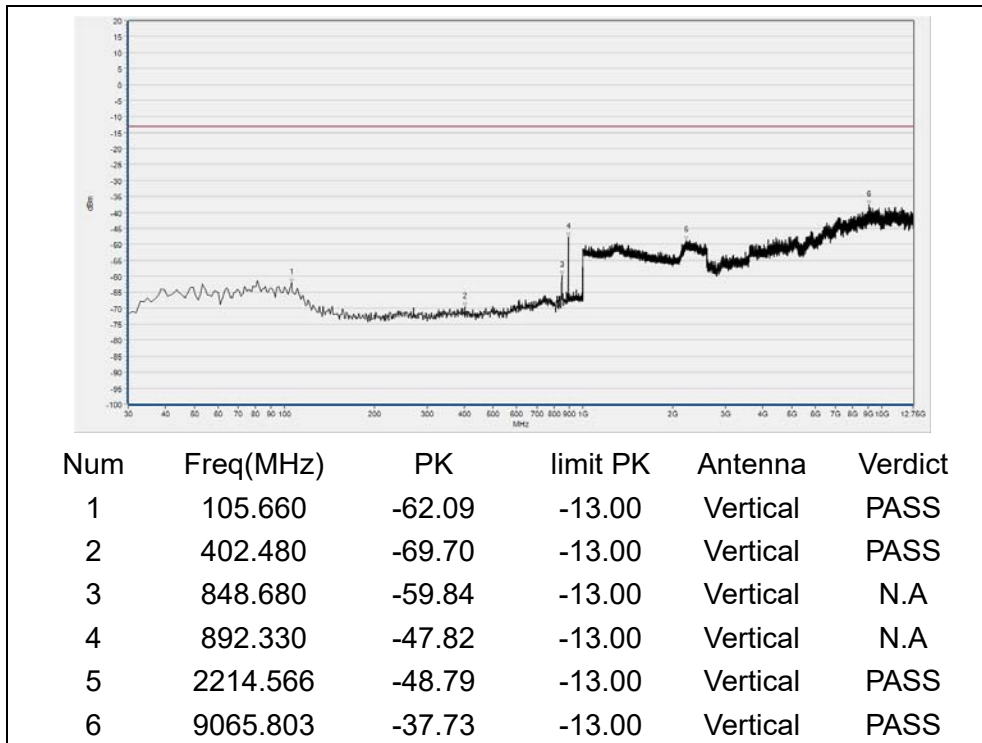

(Plot D6, EVDO B BC0, Channel = 777, Vertical)

C. Test Verdict:

Bottom Antenna:

Band	Channel	Frequency (MHz)	Measured ERP			Limit		Verdict
			dBm	W	Refer to Plot	dBm	W	
CDMA (BC0)	1013	824.70	18.403	0.069	Plot E	38.5	7	PASS
	384	836.52	21.115	0.129				PASS
	777	848.31	21.381	0.137				PASS
EVDO 0 (BC0)	1013	824.70	19.035	0.080	Plot F	38.5	7	PASS
	384	836.52	20.284	0.107				PASS
	777	848.31	19.691	0.093				PASS
EVDO A (BC0)	1013	824.70	19.217	0.084	Plot G	38.5	7	PASS
	384	836.52	19.926	0.098				PASS
	777	848.31	19.264	0.084				PASS
EVDO B (BC0)	1013	824.70	19.054	0.080	Plot H	38.5	7	PASS
	384	836.52	20.984	0.125				PASS
	777	848.31	19.620	0.092				PASS

D. Test Plots



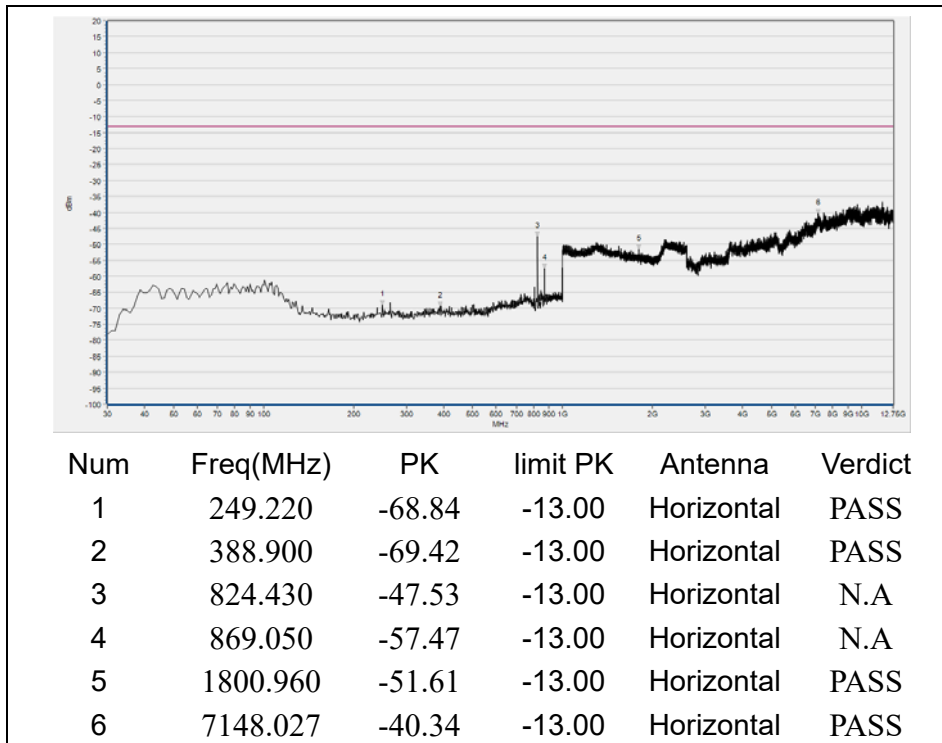

(Plot E1, CDMA BC0, Channel = 1013, Horizontal)

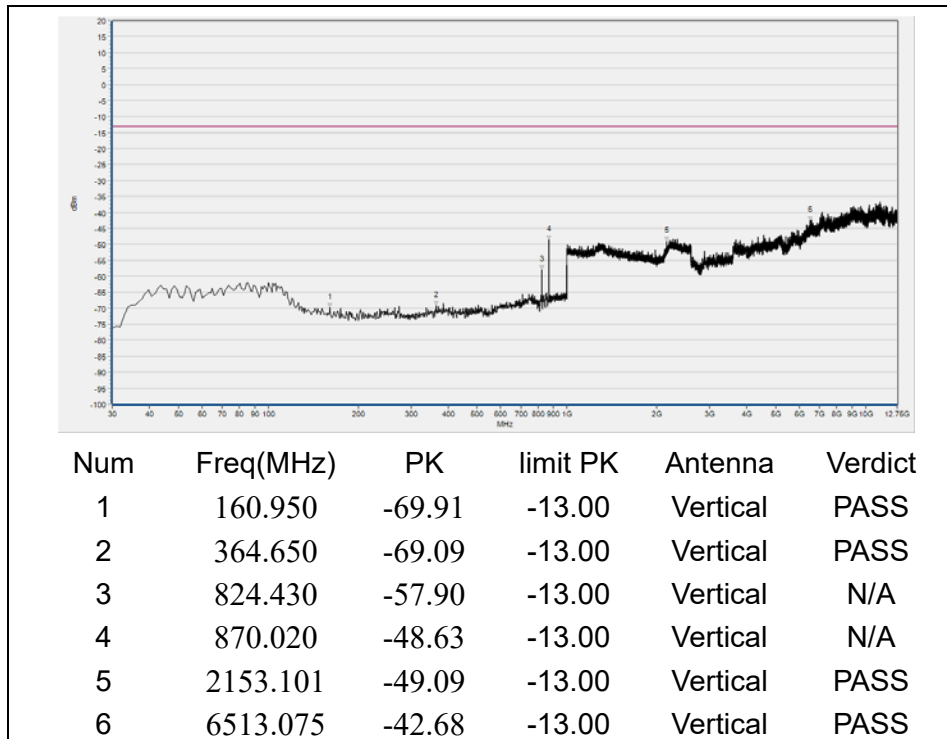

(Plot E2, CDMA BC0, Channel = 1013, Vertical)

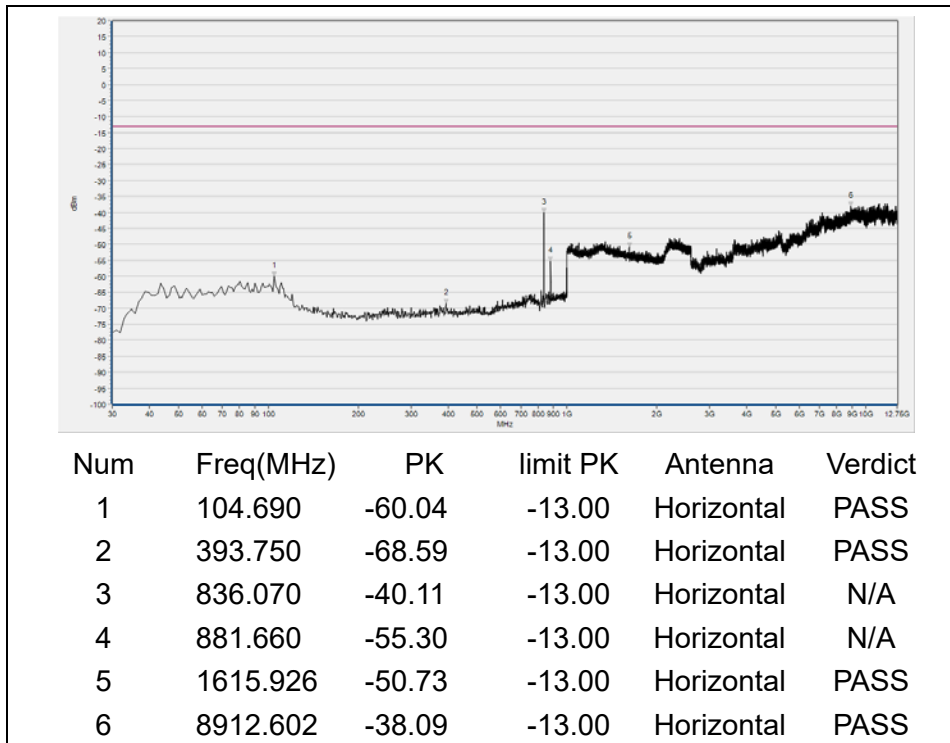

(Plot E3, CDMA BC0, Channel = 384, Horizontal)

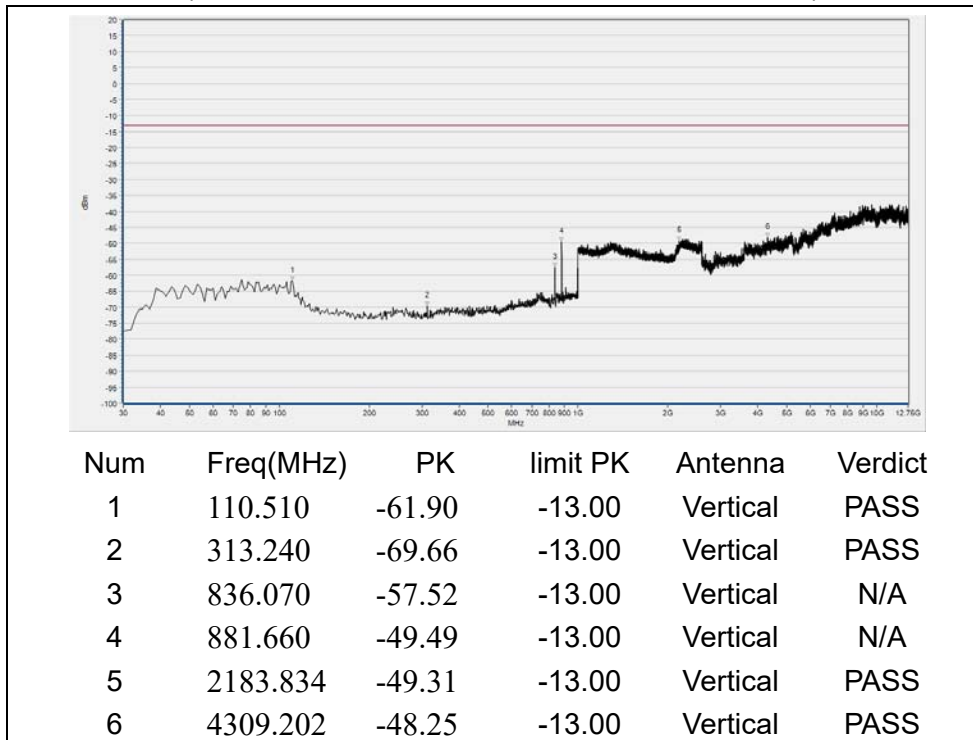

(Plot E4, CDMA BC0, Channel = 384, Vertical)

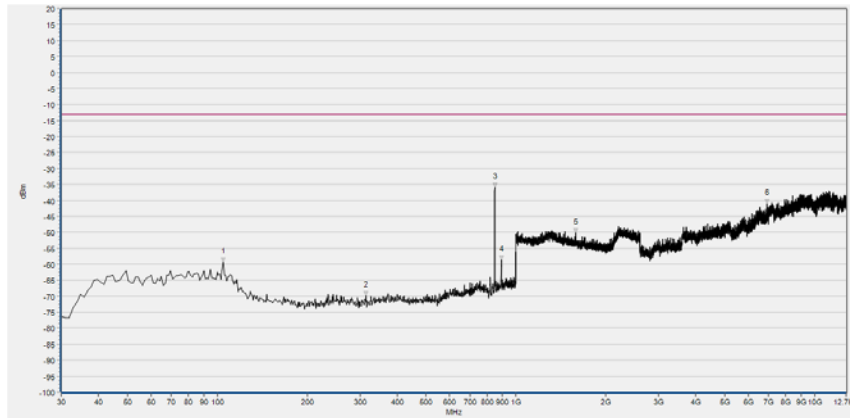

Num	Freq(MHz)	PK	limit PK	Antenna	Verdict
1	104.690	-59.37	-13.00	Horizontal	PASS
2	315.180	-69.91	-13.00	Horizontal	PASS
3	848.680	-35.93	-13.00	Horizontal	N/A
4	893.300	-58.58	-13.00	Horizontal	N/A
5	1581.353	-50.11	-13.00	Horizontal	PASS
6	6915.457	-41.11	-13.00	Horizontal	PASS

(Plot E5, CDMA BC0, Channel = 777, Horizontal)

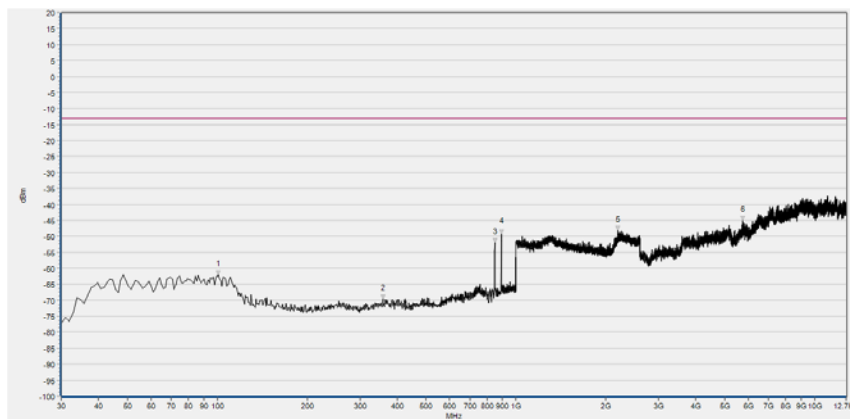

Num	Freq(MHz)	PK	limit PK	Antenna	Verdict
1	100.810	-62.06	-13.00	Vertical	PASS
2	357.860	-69.52	-13.00	Vertical	PASS
3	848.680	-52.04	-13.00	Vertical	N/A
4	893.300	-49.36	-13.00	Vertical	N/A
5	2194.718	-48.24	-13.00	Vertical	PASS
6	5735.997	-45.09	-13.00	Vertical	PASS

(Plot E6, CDMA BC0, Channel = 777, Vertical)

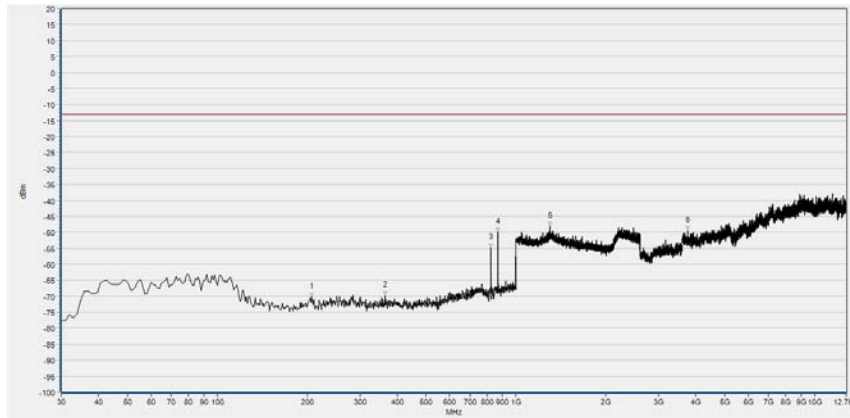

Num	Freq(MHz)	PK	limit PK	Antenna	Verdict
1	206.540	-70.34	-13.00	Horizontal	PASS
2	364.650	-69.78	-13.00	Horizontal	PASS
3	824.430	-54.77	-13.00	Horizontal	N/A
4	870.020	-49.99	-13.00	Horizontal	N/A
5	1299.000	-48.21	-13.00	Horizontal	PASS
6	3762.848	-49.42	-13.00	Horizontal	PASS

(Plot F1, EVDO 0 BC0, Channel = 1013, Horizontal)

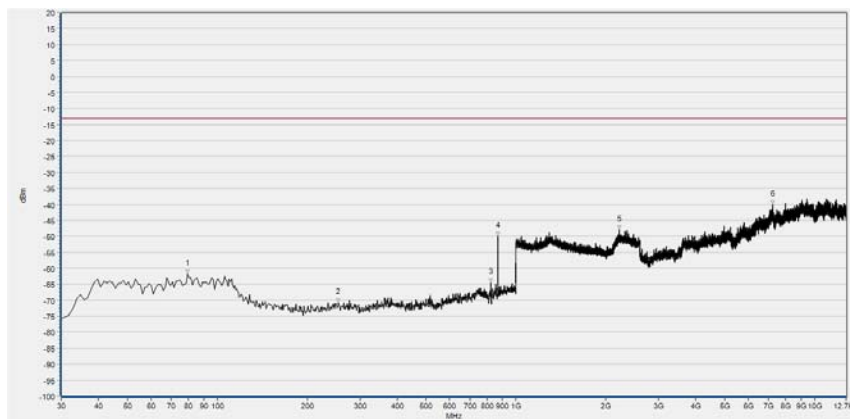

Num	Freq(MHz)	PK	limit PK	Antenna	Verdict
1	79.470	-61.74	110.510	Vertical	PASS
2	254.070	-70.70	370.470	Vertical	PASS
3	824.430	-64.46	819.580	Vertical	N/A
4	870.020	-49.84	870.020	Vertical	N/A
5	2215.206	-48.02	2229.932	Vertical	PASS
6	7247.700	-40.19	6247.281	Vertical	PASS

(Plot F2, EVDO 0 BC0, Channel = 1013, Vertical)

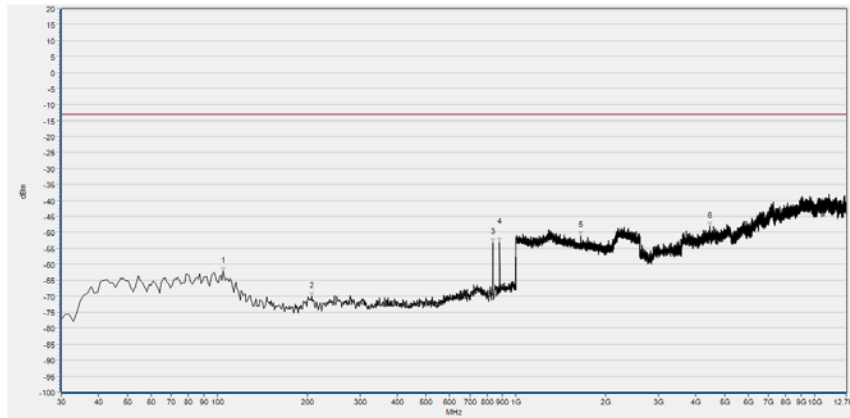

Num	Freq(MHz)	PK	limit PK	Antenna	Verdict
1	104.690	-62.21	-13.00	Horizontal	PASS
2	206.540	-70.03	-13.00	Horizontal	PASS
3	836.070	-53.25	-13.00	Horizontal	N/A
4	880.690	-53.03	-13.00	Horizontal	N/A
5	1649.220	-51.07	-13.00	Horizontal	PASS
6	4455.019	-48.20	-13.00	Horizontal	PASS

(Plot F3, EVDO 0 BC0, Channel = 384, Horizontal)

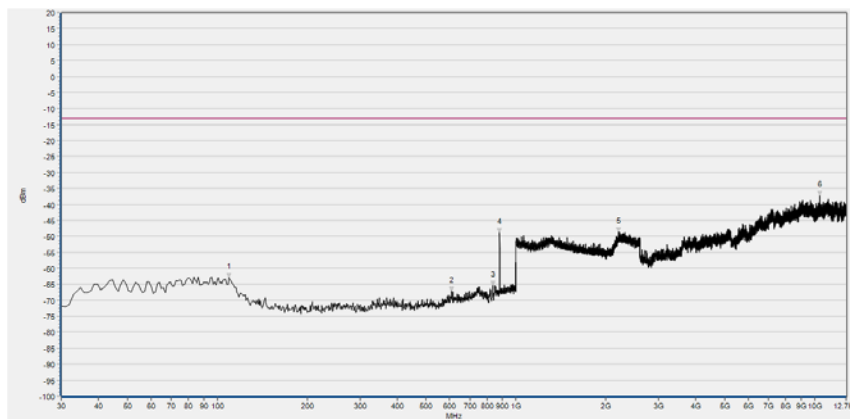

Num	Freq(MHz)	PK	limit PK	Antenna	Verdict
1	109.540	-62.90	-13.00	Vertical	PASS
2	609.090	-67.23	-13.00	Vertical	PASS
3	837.040	-65.25	-13.00	Vertical	N/A
4	881.660	-48.79	-13.00	Vertical	N/A
5	2199.840	-48.71	-13.00	Vertical	PASS
6	10405.847	-37.30	-13.00	Vertical	PASS

(Plot F4, EVDO 0 BC0, Channel = 384, Vertical)

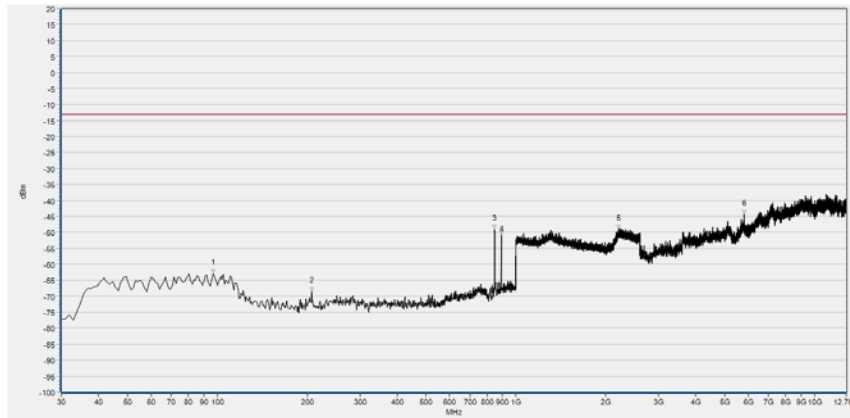

Num	Freq(MHz)	PK	limit PK	Antenna	Verdict
1	96.930	-62.97	-13.00	Horizontal	PASS
2	206.540	-68.42	-13.00	Horizontal	PASS
3	847.710	-49.05	-13.00	Horizontal	N/A
4	893.300	-50.74	-13.00	Horizontal	N/A
5	2204.322	-49.12	-13.00	Horizontal	PASS
6	5807.983	-44.39	-13.00	Horizontal	PASS

(Plot F5, EVDO 0 BC0, Channel = 777, Horizontal)

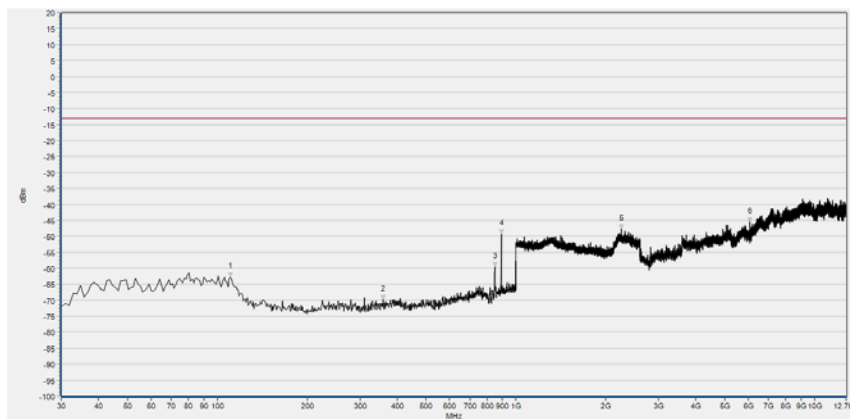

Num	Freq(MHz)	PK	limit PK	Antenna	Verdict
1	110.510	-62.67	-13.00	Vertical	PASS
2	358.830	-69.89	-13.00	Vertical	PASS
3	848.680	-59.59	-13.00	Vertical	N/A
4	892.330	-49.22	-13.00	Vertical	N/A
5	2253.621	-47.63	-13.00	Vertical	PASS
6	6059.011	-45.44	-13.00	Vertical	PASS

(Plot F6, EVDO 0 BC0, Channel = 777, Vertical)

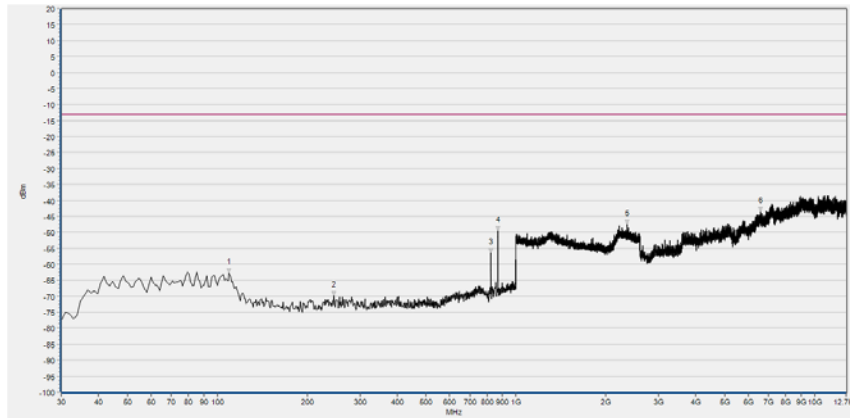

Num	Freq(MHz)	PK	limit PK	Antenna	Verdict
1	109.540	-62.72	-13.00	Horizontal	PASS
2	245.340	-69.91	-13.00	Horizontal	PASS
3	824.430	-56.51	-13.00	Horizontal	N/A
4	870.020	-49.42	-13.00	Horizontal	N/A
5	2357.983	-47.57	-13.00	Horizontal	PASS
6	6585.061	-43.51	-13.00	Horizontal	PASS

(Plot G1, EVDO A BC0, Channel = 1013, Horizontal)

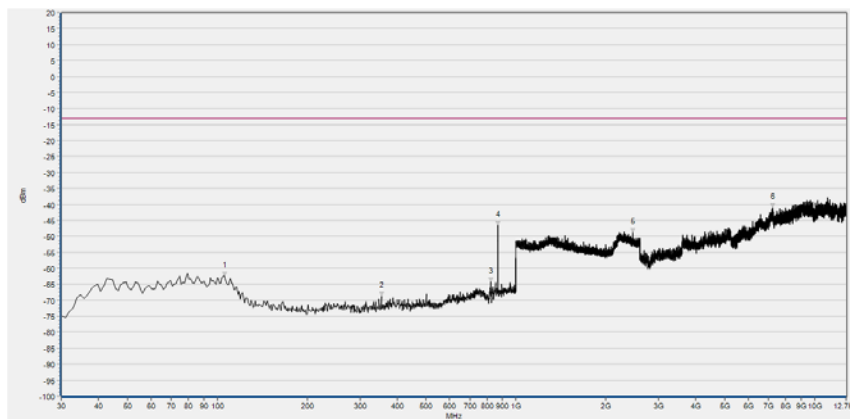

Num	Freq(MHz)	PK	limit PK	Antenna	Verdict
1	83.350	-62.10	-13.00	Vertical	PASS
2	313.240	-70.82	-13.00	Vertical	PASS
3	824.430	-64.89	-13.00	Vertical	N/A
4	870.020	-49.67	-13.00	Vertical	N/A
5	2220.968	-49.06	-13.00	Vertical	PASS
6	5813.521	-45.80	-13.00	Vertical	PASS

(Plot G2, EVDO A BC0, Channel = 1013, Vertical)

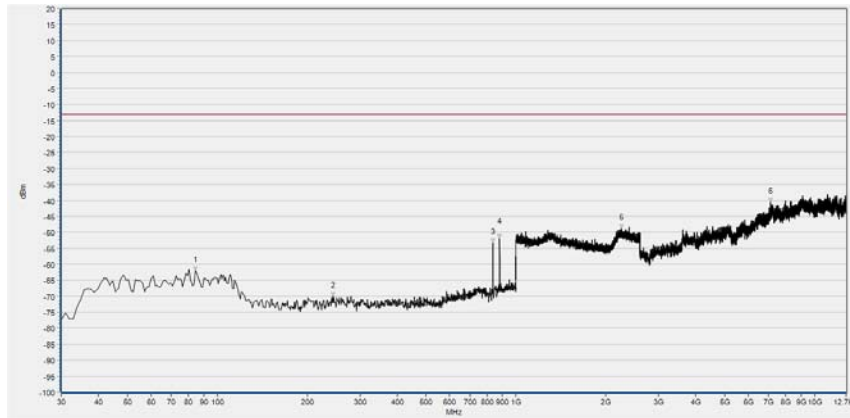

Num	Freq(MHz)	PK	limit PK	Antenna	Verdict
1	84.320	-62.12	-13.00	Horizontal	PASS
2	243.400	-69.99	-13.00	Horizontal	PASS
3	836.070	-53.20	-13.00	Horizontal	N/A
4	881.660	-52.05	-13.00	Horizontal	N/A
5	2254.262	-48.85	-13.00	Horizontal	PASS
6	7111.111	-40.65	-13.00	Horizontal	PASS

(Plot G3, EVDO A BC0, Channel = 384, Horizontal)

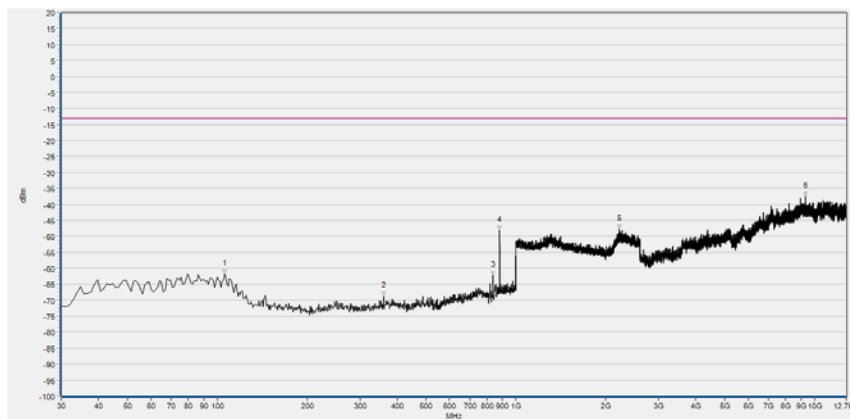

Num	Freq(MHz)	PK	limit PK	Antenna	Verdict
1	105.660	-61.80	-13.00	Vertical	PASS
2	359.800	-68.67	-13.00	Vertical	PASS
3	836.070	-62.31	-13.00	Vertical	N/A
4	881.660	-48.14	-13.00	Vertical	N/A
5	2214.566	-47.65	-13.00	Vertical	PASS
6	9305.756	-37.45	-13.00	Vertical	PASS

(Plot G4, EVDO A BC0, Channel = 384, Vertical)

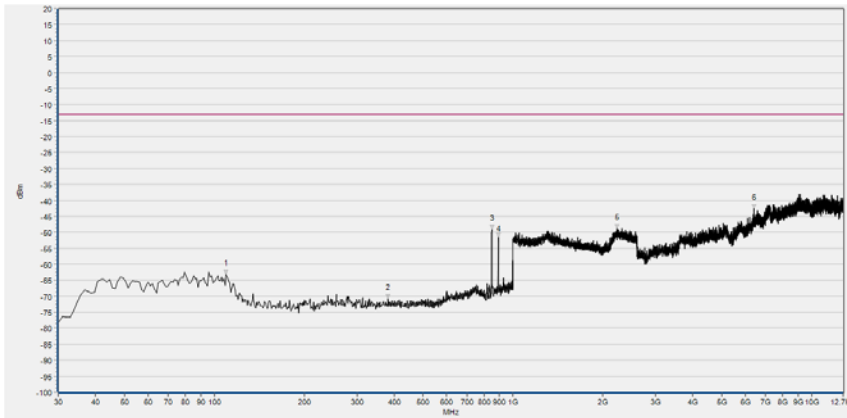

Num	Freq(MHz)	PK	limit PK	Antenna	Verdict
1	109.540	-63.18	-13.00	Horizontal	PASS
2	382.110	-70.71	-13.00	Horizontal	PASS
3	848.680	-49.04	-13.00	Horizontal	N/A
4	893.300	-51.58	-13.00	Horizontal	N/A
5	2233.774	-48.90	-13.00	Horizontal	PASS
6	6420.786	-42.61	-13.00	Horizontal	PASS

(Plot G5, EVDO A BC0, Channel = 777, Horizontal)

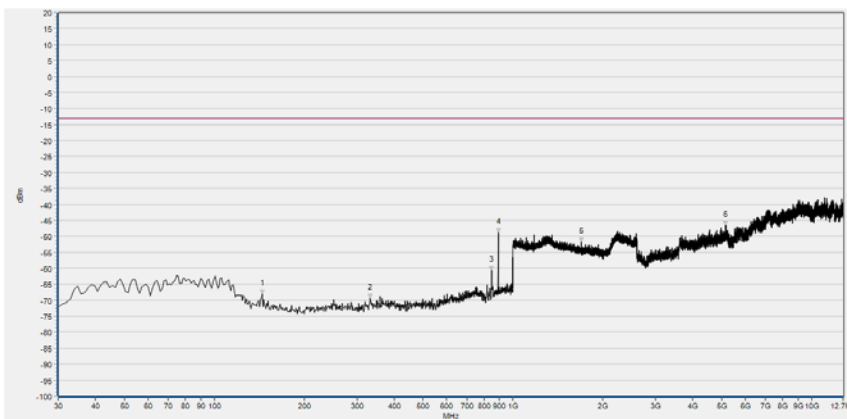

Num	Freq(MHz)	PK	limit PK	Antenna	Verdict
1	144.460	-67.94	-13.00	Vertical	PASS
2	332.640	-69.49	-13.00	Vertical	PASS
3	847.710	-60.77	-13.00	Vertical	N/A
4	893.300	-48.92	-13.00	Vertical	N/A
5	1696.599	-51.83	-13.00	Vertical	PASS
6	5150.882	-46.64	-13.00	Vertical	PASS

(Plot G6, EVDO A BC0, Channel = 777, Vertical)

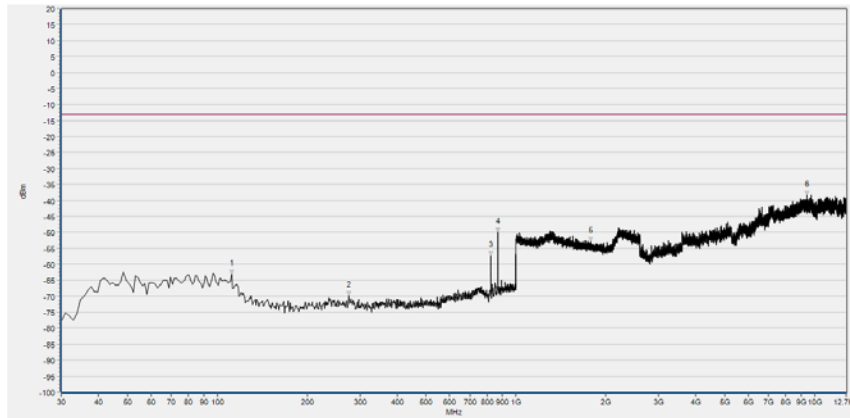

Num	Freq(MHz)	PK	limit PK	Antenna	Verdict
1	111.480	-63.23	-13.00	Horizontal	PASS
2	275.410	-69.72	-13.00	Horizontal	PASS
3	824.430	-57.41	-13.00	Horizontal	N.A
4	870.020	-49.98	-13.00	Horizontal	N.A
5	1774.070	-52.91	-13.00	Horizontal	PASS
6	9446.036	-38.26	-13.00	Horizontal	PASS

(Plot H1, EVDO B BC0, Channel = 1013, Horizontal)

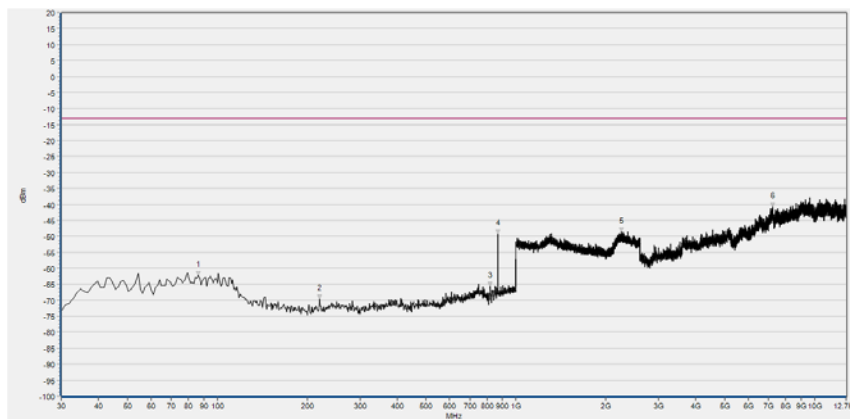

Num	Freq(MHz)	PK	limit PK	Antenna	Verdict
1	86.260	-62.25	-13.00	Vertical	PASS
2	220.120	-69.60	-13.00	Vertical	PASS
3	818.610	-65.59	-13.00	Vertical	N.A
4	869.050	-49.33	-13.00	Vertical	N.A
5	2247.219	-48.53	-13.00	Vertical	PASS
6	7244.008	-40.76	-13.00	Vertical	PASS

(Plot H2, EVDO B BC0, Channel = 1013, Vertical)

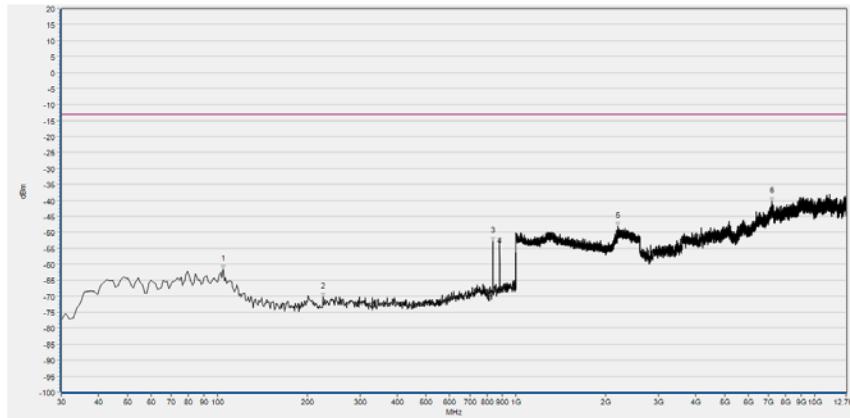

Num	Freq(MHz)	PK	limit PK	Antenna	Verdict
1	104.690	-61.53	-13.00	Horizontal	PASS
2	225.940	-70.28	-13.00	Horizontal	PASS
3	836.070	-52.85	-13.00	Horizontal	N.A
4	880.690	-52.99	-13.00	Horizontal	N.A
5	2194.078	-48.09	-13.00	Horizontal	PASS
6	7175.714	-40.44	-13.00	Horizontal	PASS

(Plot H3, EVDO B BC0, Channel =384, Horizontal)

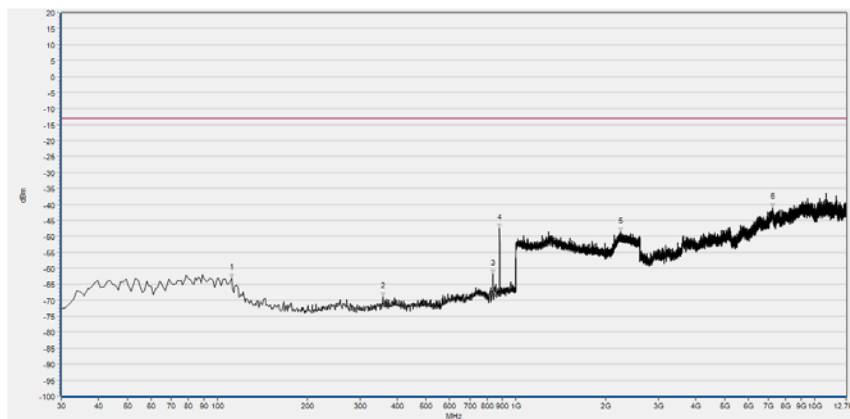

Num	Freq(MHz)	PK	limit PK	Antenna	Verdict
1	111.480	-63.15	-13.00	Vertical	PASS
2	357.860	-68.94	-13.00	Vertical	PASS
3	836.070	-61.82	-13.00	Vertical	N.A
4	881.660	-47.56	-13.00	Vertical	N.A
5	2240.176	-48.51	-13.00	Vertical	PASS
6	7238.471	-41.10	-13.00	Vertical	PASS

(Plot H4, EVDO B BC0, Channel =384, Vertical)

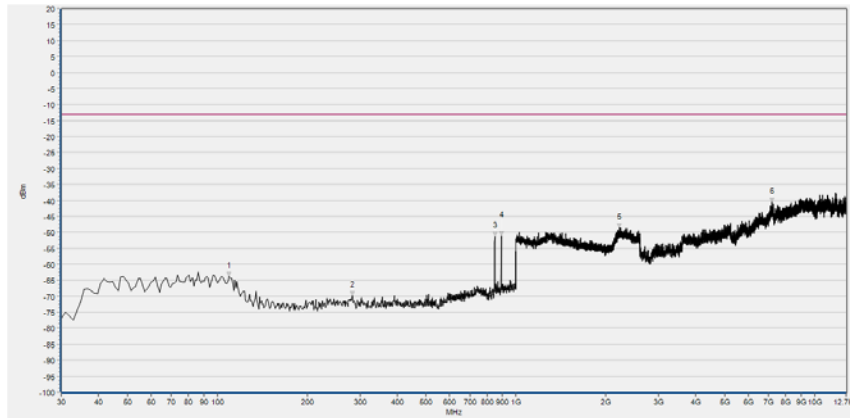

Num	Freq(MHz)	PK	limit PK	Antenna	Verdict
1	109.540	-63.86	-13.00	Horizontal	PASS
2	283.170	-69.91	-13.00	Horizontal	PASS
3	848.680	-51.22	-13.00	Horizontal	N.A
4	893.300	-51.06	-13.00	Horizontal	N.A
5	2222.249	-48.64	-13.00	Horizontal	PASS
6	7177.560	-40.66	-13.00	Horizontal	PASS

(Plot H5, EVDO B BC0, Channel = 777, Horizontal)

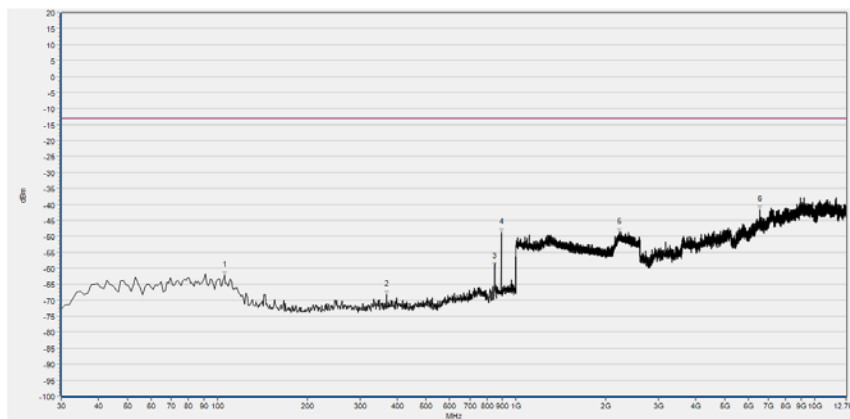

Num	Freq(MHz)	PK	limit PK	Antenna	Verdict
1	105.660	-62.34	-13.00	Vertical	PASS
2	368.530	-68.38	-13.00	Vertical	PASS
3	847.710	-59.59	-13.00	Vertical	N.A
4	894.270	-48.86	-13.00	Vertical	N.A
5	2212.645	-48.84	-13.00	Vertical	PASS
6	6564.757	-41.60	-13.00	Vertical	PASS

(Plot H6, EVDO B BC0, Channel = 777, Vertical)



REPORT No.: SZ18110268W10



Annex A Test Uncertainty

Where relevant, the following measurement uncertainty levels have been estimated for test performed on the EUT as specified in CISPR 16-1-2:

Test items	Uncertainty
Output Power	± 2.22 dB
Bandwidth	$\pm 5\%$
Conducted Spurious Emission	± 2.77 dB
Band Edge	± 2.77 dB
Equivalent Isotropic Radiated Power	± 2.22 dB
Radiated Spurious Emissions	± 6 dB

This uncertainty represent an expanded uncertainty expressed at approximately the 95% confidence level using a coverage factor of $k=2$



Annex B Testing Laboratory Information

1. Identification of the Responsible Testing Laboratory

Laboratory Name:	Shenzhen Morlab Communications Technology Co., Ltd. Morlab Laboratory
Laboratory Address:	FL.3, Building A, FeiYang Science Park, No.8 LongChang Road, Block 67, BaoAn District, ShenZhen, GuangDong Province, P. R. China
Telephone:	+86 755 36698555
Facsimile:	+86 755 36698525

2. Identification of the Responsible Testing Location

Name:	Shenzhen Morlab Communications Technology Co., Ltd. Morlab Laboratory
Address:	FL.3, Building A, FeiYang Science Park, No.8 LongChang Road, Block 67, BaoAn District, ShenZhen, GuangDong Province, P. R. China

3. Facilities and Accreditations

All measurement facilities used to collect the measurement data are located at FL.3, Building A, FeiYang Science Park, Block 67, BaoAn District, Shenzhen, 518101 P. R. China. The test site is constructed in conformance with the requirements of ANSI C63.10-2013 and CISPR Publication 22; the FCC designation number is CN1192, the test firm registration number is 226174.



4. Test Equipments Utilized

4.1 Conducted Test Equipments

Equipment Name	Serial No.	Type	Manufacturer	Cal. Date	Cal. Due
Power Splitter	NW521	1506A	Weinschel	2018.04.17	2019.04.16
Attenuator 1	(N/A.)	10dB	Resnet	2018.04.17	2019.04.16
Attenuator 2	(N/A.)	3dB	Resnet	2018.04.17	2019.04.16
EXA Signal Analyzer	MY53470836	N9010A	Agilent	2018.11.06	2019.11.05
USB Power Sensor	MY54210011	U2021XA	Agilent	2018.04.17	2019.04.16
System Simulator	152038	CMW500	R&S	2018.05.08	2019.05.07
RF cable (30MHz-26GHz)	CB01	RF01	Morlab	N/A	N/A
Coaxial cable	CB02	RF02	Morlab	N/A	N/A
SMA connector	CN01	RF03	HUBER-SUHNER	N/A	N/A
Temperature Chamber	(N/A)	HUT705P	CHONGQING HANBA EXPERIMENTAL EQUIPMENT CO.,LTD	2018.04.17	2019.04.16
Computer	T430i	Think Pad	Lenovo	N/A	N/A

**4.2 Radiated Test Equipments**

Equipment Name	Serial No.	Type	Manufacturer	Cal. Date	Cal. Due
System Simulator	152038	CMW500	R&S	2018.08.04	2019.08.03
Receiver	MY54130016	N9038A	Agilent	2018.05.18	2019.05.17
Test Antenna - Bi-Log	9163-519	VULB 9163	Schwarzbeck	2018.03.03	2019.03.02
Test Antenna - Horn	9170C-531	BBHA9170	Schwarzbeck	2018.08.06	2019.08.05
Test Antenna - Horn	01774	BBHA 9120D	Schwarzbeck	2018.08.02	2019.08.01
Coaxial cable (N male) (9KHz-30MHz)	CB04	EMC04	Morlab	N/A	N/A
Coaxial cable (N male) (30MHz-26GHz)	CB02	EMC02	Morlab	N/A	N/A
Coaxial cable (N male) (30MHz-26GHz)	CB03	EMC03	Morlab	N/A	N/A
1-18GHz pre-Amplifier	MA02	TS-PR18	Rohde& Schwarz	2018.05.08	2019.05.07
18-26.5GHz pre-Amplifier	MA03	TS-PR18	Rohde& Schwarz	2018.05.08	2019.05.07
Notch Filter	N/A	WRCG-CDMA BC0	Wainwright	2018.12.01	2019.11.30
Anechoic Chamber	N/A	9m*6m*6m	CRT	2017.11.19	2020.11.18

END OF REPORT