TEST REPORT

Report No.: SRTC2020-9003(F)-0107
Product Name: LTE/WCDMA/GSM(GPRS) Multi-Mode Digital
Mobile Phone
Model Name: Nubia 6010
Applicant: Nubia Technology Co., Ltd.
Manufacturer: Nubia Technology Co., Ltd.
Specification: FCC Part15B (Certification)
(2020 edition)
FCC ID: 2AHJO-6010

The State Radio_monitoring_center Testing Center (SRTC)
15th Building, No.30 Shixing Street, Shijingshan District,
Beijing, China

Tel: 86-10-57996183 Fax: 86-10-57996388

CONTENTS

1. General information	3
1.1 Notes of the test report	3
1.2 Information about the testing laboratory	3
1.3 Applicant's details	3
1.4 Manufacturer's details	3
1.5 Application details	4
1.6 Reference specification	4
1.7 Information of EUT	4
1.7.1 General information	4
1.7.2 EUT details	5
1.7.3 Auxiliary equipment details	5
2. Test information	6
2.1 Summary of the test results	7
2.2 Test result	8
2.2.1 Conducted Emissions-FCC Part15.107	8
2.2.2 Radiated Emissions-FCC Part15.109	18
2.3. List of test equipments	30

1. General information

1.1 Notes of the test report

The test report may only be reproduced or published in full. Reproduction or publication of extracts from the report requires the prior written permission of The State Radio_monitoring_center Testing Center (SRTC).

The test results relate only to individual items of the samples which have been tested.

1.2 Information about the testing laboratory

Company: The State Radio_monitoring_center Testing Center (SRTC)
Address: 15th Building, No.30 Shixing Street, Shijingshan District
Testing location: No.80, Zhaojiachang, BeizangCun, Daxing District, Beijing, China.
City: Beijing
Country or Region: China
Contacted person: Liu Jia
Tel: +86 10 57996183
Fax: +86 10 57996388
Email: liujiaf@srtc.org.cn

1.3 Applicant's details

Company: Nubia Technology Co., Ltd.
Address: Room 1801, Building 2, Chongwen Park, Nanshan Zhiyuan, No.3370, Liuxian Rd, Nanshan District, Shenzhen City, Guangdong Province, P. R. China
City: Shenzhen
Country or Region: China
Contacted person: Gong Bolin
Tel: +86-755-86360200

1.4 Manufacturer's details

Company: Nubia Technology Co., Ltd.
Address: Room 1801, Building 2, Chongwen Park, Nanshan Zhiyuan, No.3370, Liuxian Rd, Nanshan District, Shenzhen City, Guangdong Province, P. R. China
City: Shenzhen
Country or Region: China
Contacted person: Gong Bolin
Tel: +86-755-86360200

1.5 Application details

Date of reception of test sample: 17th Mar. 2021

Date of test: 17th Mar. 2021 to 29th Mar. 2021

1.6 Reference specification

FCC Part 15B, 2020 (Certification)

1.7 Information of EUT

1.7.1 General information

Name of EUT	LTE/WCDMA/GSM(GPRS) Multi-Mode Digital Mobile Phone
Model Name	Nubia 6010
FCC ID	2AHJO-6010
Frequency Range	GSM: GSM850 / PCS1900 WCDMA: FDD II / FDD IV / FDD V LTE: FDD 2/ FDD 4/ FDD 5/ FDD 7/ FDD 12/ FDD 17/FDD 26/FDD 66 Bluetooth: 2.4~2.4835GHz WiFi: 2.4~2.4835GHz
Equipment Class	Class B
Power Supply	Battery or Charger
Rated Power Supply Voltage	3.85V
Extreme Temperature	Lowest: -10°C Highest: +55°C
Extreme Voltage	Minimum: 3.6V Maximum: 4.4V
HW Version	z91A
SW Version	GEN_MX_6010_V1.0

1.7.2 EUT details

Product Name	Model Name	IMEI
LTE/WCDMA/GSM(GPRS) Multi-Mode Digital Mobile Phone	Nubia 6010	867563050000560

Note1: The EUT has passed EMC test, and the original test report number is SRTC2020-9003(F)-0069. The Flash capacity is changed to 4G RAM+64G ROM. Nubia 6010 is the variant of the initial certified product ZTE A7030.

1.7.3 Auxiliary equipment details

AE (Auxiliary Equipment) 1#: Laptop

Manufacturer	Lenovo
Model Number	E40-70
S/N	MP06WE9U
Input Voltage	100V-240V AC

AE (Auxiliary Equipment) 2#: USB Cable1

Manufacturer	Dongguan Guojun Plastic Electronic Co.,Ltd
Model Number	USB-TC20-W-70-M-L

AE (Auxiliary Equipment) 3#: USB Cable2

Manufacturer	Shenzhen Luxshare Precision Industry Co.,Ltd.
Model Number	USB-TC20-W-70-M-L

AE (Auxiliary Equipment) 4#: Charger1

Manufacturer	RUIJING
Model Number	STC-A520A-Z
S/N	/
Input Voltage	100V-240V AC 400mA
Output Voltage	5.0VDC 2000mA

AE (Auxiliary Equipment) 5#: Charger2

Manufacturer	Chenyang
Model Number	STC-A520A-Z
S/N	/
Input Voltage	100V-240V AC 400mA
Output Voltage	5.0VDC 2000mA

AE (Auxiliary Equipment) 6#: Headset1

Manufacturer	JUWEI ELECTRONICS CO.,LTD
Model Number	JWEP1036-Z01R

AE (Auxiliary Equipment) 7#: Headset2

Manufacturer	ShenZhen FDC Electronic Co.,Ltd
Model Number	DEM-66

Note2: As the information described in these above tables, the relevant tests have been performed in order to verify in which supply would have the worst features. When the EUT exercised with 2# USB Cable, 4# Charger, 6# Headset is the worst feature, and record the results in the test report.

Note3: AE1# Laptop was selected by testing laboratory and was only cooperated with this test, not for sale.

2. Test information

2.1 Summary of the test results

No.	Test case	FCC reference	Verdict
1	Conducted emissions	15.107	Pass
2	Radiated emissions	15.109	Pass

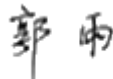
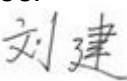
Approved By: Mr. Liu Wei Director of the test department 	Checked By: Mr. Guo Yu Vice director of the test department 
Tested by: Mr. Liu Jian Test engineer 	Issued date: 2021.3.29

2.2 Test result

2.2.1 Conducted Emissions-FCC Part15.107

Ambient condition:

Temperature	Relative humidity	Pressure
23.4°C	41.9%	101.2kPa

Test Setup with laptop:

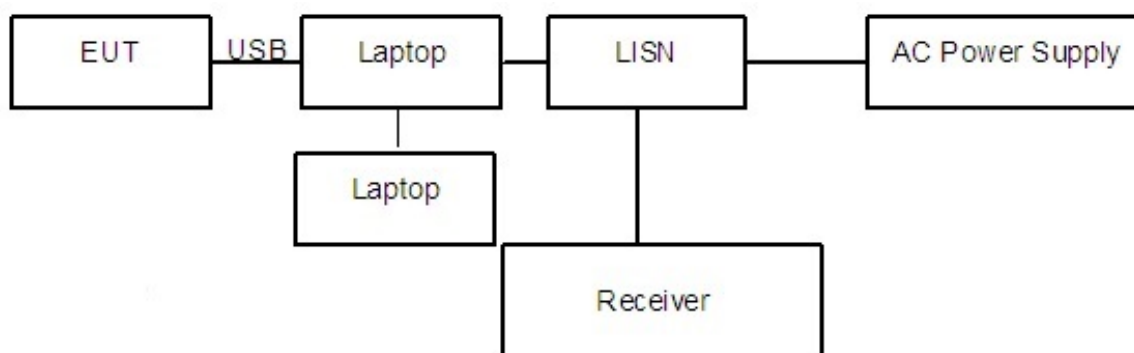

Figure 1

Test Procedure:

The EUT is placed on a non-metallic table 0.8m above the horizontal metal reference ground plane. The accessories of the EUT are connected with the EUT such as headset etc. The EUT was connected with a laptop via the USB cable and transferred the data by copying large files from laptop to the EUT. The laptop's LAN port is connected with another laptop via cable. And the data transferring between two laptops is maintained.

The AC main power supply of the laptop is connected to LISN and LISN is connected to the reference ground. The test set-up and the test methods are performed according to ANSI C63.4:2014.

Then start the test software EMC32. Sweep the whole frequency band through the range from 150 KHz to 30 MHz with RBW 9kHz, VBW 30kHz. The measurement should be done for both L line and N line. During pre-test, the receiver uses both peak detector and average detector. And the final test, the receiver uses both average detector and Quasi-peak detector.

The data of cable loss has been calibrated in full testing frequency range before the testing.

Test Setup with charger:

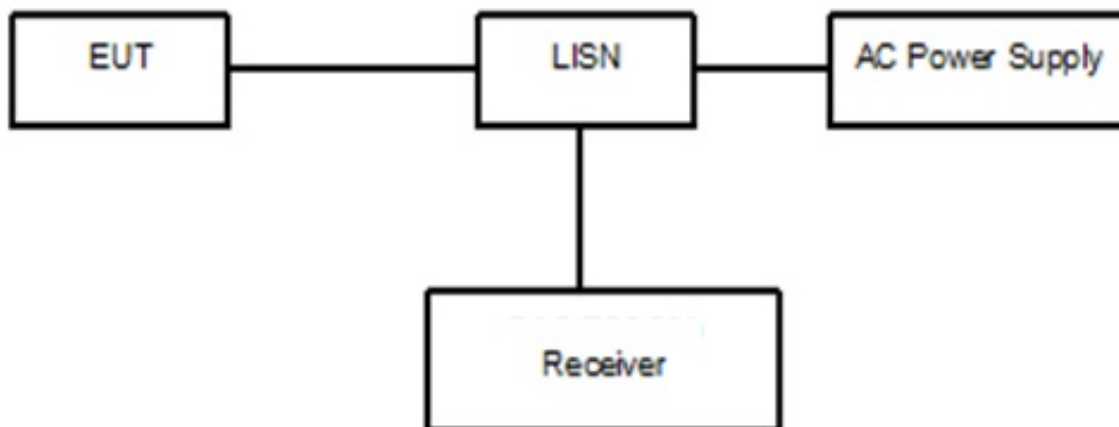

Figure 2

Test Procedure:

The EUT is placed on a non-metallic table 0.8m above the horizontal metal reference ground plane. The EUT is connected with LISN via the charger. The LISN is connected to the reference ground. The accessories of the EUT are connected with the EUT such as headset etc. Open the following functions of EUT: Camera, flash lamp, FM, GPS and video.

The test set-up and the test methods are performed according to ANSI C63.4:2014. Then start the test software EMC32. Sweep the whole frequency band through the range from 150 KHz to 30 MHz with RBW 9kHz, VBW 30kHz. The measurement should be done for both L line and N line. During pre-test, the receiver uses both peak detector and average detector. And the final test, the receiver uses both average detector and Quasi-peak detector.

The data of cable loss has been calibrated in full testing frequency range before the testing.

A "reference path loss" Corr.(dB) is established and the $L_{cable}+ATT+VDF$ is the attenuation of "reference path loss", and including the cable loss, the attenuation of the attenuator, the voltage division factor of AMN.

The measurement results are obtained as described below:

$$P_{result}=P_{mea}+ Corr.(dB)$$

Sample calculation: $(55.21 \text{ dB}\mu\text{V}) = (25.61 \text{ dB}\mu\text{V}) + (29.6 \text{ dB})$, the corresponding frequency is 0.179850MHz.

Limit:

Frequency of Emission(MHz)	Limits(dB μ V)	
	Quasi-peak	Average
0.15~0.5	66 to 56*	56 to 46*
0.5~5	56	46
5~30	60	50

Note: * Decreases with the logarithm of the frequency

Test result:

Noise Level of the Measuring Instrument

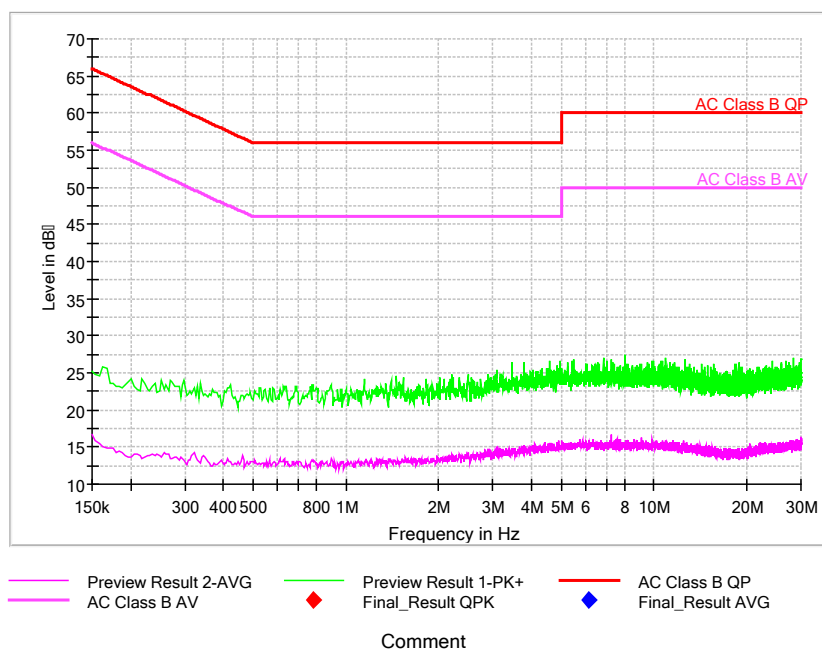

Pic1.Conducted emission L and N Line

This result is from the original test report SRTC2020-9003(F)-0069.

240VAC:

EUT + 2#AE: USB Cable1+4# AE: Charger1+6# AE: Headset1:

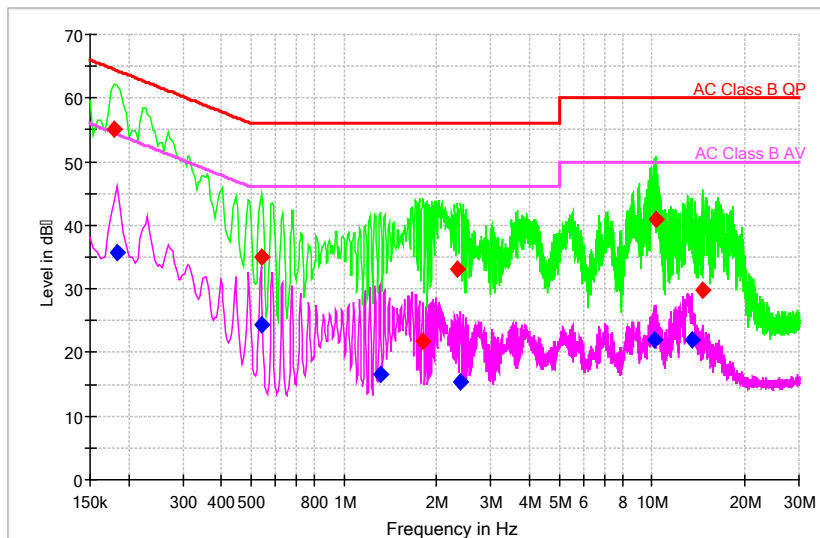

Preview Result 2-AVG AC Class B AV Preview Result 1-PK+ Final_Result QPK AC Class B QP Final_Result AVG

Comment

Pic2. Conducted emission L&N Line

Frequency (MHz)	QuasiPeak (dBµV)	Average (dBµV)	Limit (dBµV)	Margin (dB)	Line	Corr. (dB)	Pmea QuasiPeak (dBµV)	Pmea Average (dBµV)
0.179850	55.21	---	64.49	9.29	L1	29.6	25.61	---
0.184114	---	35.67	54.30	18.63	L1	29.6	---	6.07
0.538050	---	24.28	46.00	21.72	L1	29.6	---	-5.32
0.542314	35.01	---	56.00	20.99	L1	29.6	5.41	---
1.309886	---	16.62	46.00	29.38	L1	29.7	---	-13.08
1.808807	21.67	---	56.00	34.33	L1	29.7	-8.03	---
2.337579	33.06	---	56.00	22.94	L1	29.7	3.36	---
2.393014	---	15.39	46.00	30.61	N	29.7	---	-14.31
10.230771	---	21.96	50.00	28.04	N	29.7	---	-7.74
10.277679	40.80	---	60.00	19.20	L1	29.7	11.1	---
13.446043	---	22.00	50.00	28.00	L1	29.8	---	-7.8
14.631514	29.81	---	60.00	30.19	L1	29.8	0.01	---

This result is from the original test report SRTC2020-9003(F)-0069.

240VAC:

EUT + 3#AE: USB Cable2+5# AE: Charger2+7# AE: Headset2:

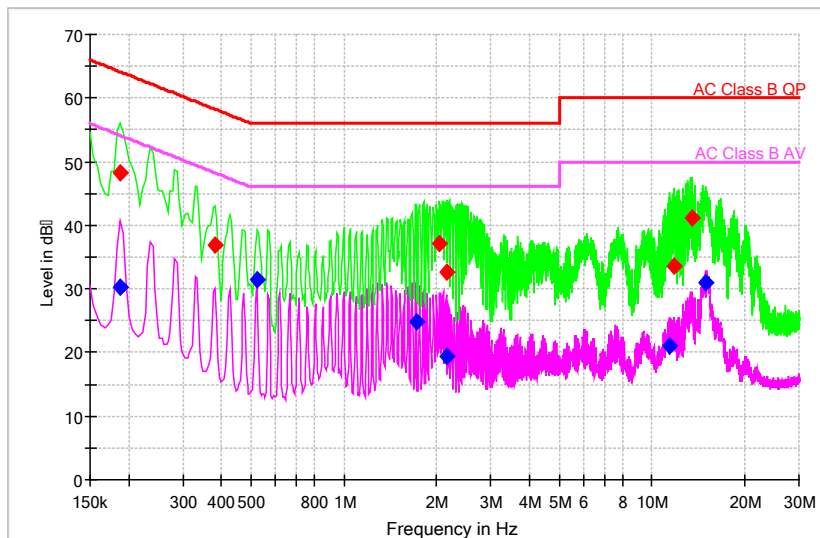

Preview Result 2-AVG AC Class B AV Preview Result 1-PK+ Final_Result QPK AC Class B QP Final_Result AVG

Comment

Pic3. Conducted emission L&N Line

Frequency (MHz)	QuasiPeak (dBµV)	Average (dBµV)	Limit (dBµV)	Margin (dB)	Line	Corr. (dB)	Pmea QuasiPeak (dBµV)	Pmea Average (dBµV)
0.188379	---	30.24	54.11	23.87	L1	29.6	---	0.64
0.188379	48.32	---	64.11	15.78	L1	29.6	18.72	---
0.380271	36.90	---	58.27	21.37	L1	29.6	7.3	---
0.520993	---	31.37	46.00	14.63	N	29.6	---	1.77
1.714993	---	24.93	46.00	21.07	N	29.7	---	-4.77
2.039079	37.12	---	56.00	18.88	L1	29.7	7.42	---
2.145686	---	19.47	46.00	26.53	L1	29.7	---	-10.23
2.149950	32.68	---	56.00	23.32	L1	29.7	2.98	---
11.382129	---	20.93	50.00	29.07	L1	29.8	---	-8.87
11.804293	33.49	---	60.00	26.51	L1	29.8	3.69	---
13.428986	41.24	---	60.00	18.76	L1	29.8	11.44	---
14.904429	---	31.08	50.00	18.92	L1	29.8	---	1.28

This result is from the original test report SRTC2020-9003(F)-0069.

120VAC:

EUT + 2#AE: USB Cable1+4# AE: Charger1+6# AE: Headset1:

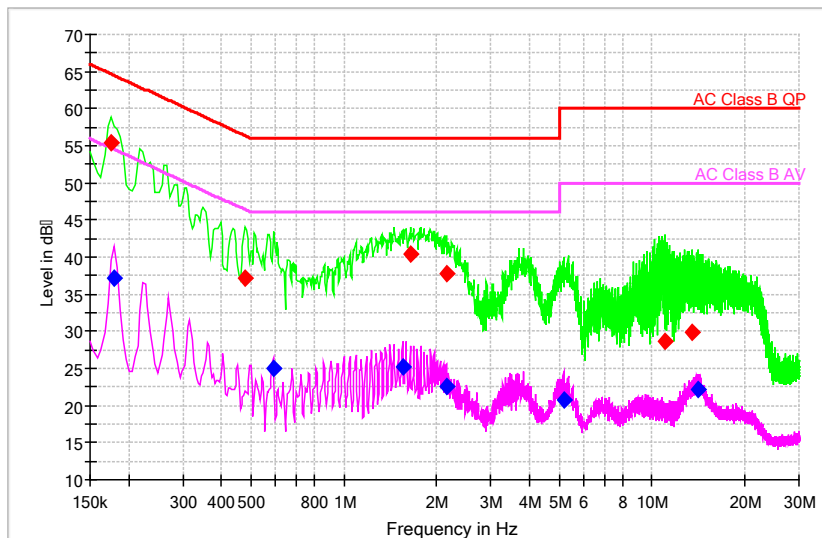

Preview Result 2-AVG AC Class B AV (magenta line)
Preview Result 1-PK+ Final_Result QPK (green line)
AC Class B QP Final_Result AVG (red line)
AC Class B AV (magenta line)
Final_Result QPK (red diamond)
Final_Result AVG (blue diamond)

Comment

Pic4. Conducted emission L&N Line

Frequency (MHz)	QuasiPeak (dBμV)	Average (dBμV)	Limit (dBμV)	Margin (dB)	Line	Corr. (dB)	Pmea QuasiPeak (dBμV)	Pmea Average (dBμV)
0.175586	55.43	---	64.69	9.26	L1	29.6	25.83	---
0.179850	---	37.09	54.49	17.41	L1	29.6	---	7.49
0.478350	37.22	---	56.37	19.14	L1	29.6	7.62	---
0.589221	---	24.93	46.00	21.07	L1	29.6	---	-4.67
1.548686	---	25.23	46.00	20.77	L1	29.7	---	-4.47
1.642500	40.33	---	56.00	15.67	L1	29.7	10.63	---
2.145686	37.78	---	56.00	18.22	L1	29.7	8.08	---
2.145686	---	22.59	46.00	23.41	N	29.7	---	-7.11
5.160536	---	20.81	50.00	29.19	N	29.7	---	-8.89
11.002607	28.71	---	60.00	31.29	L1	29.8	-1.09	---
13.535593	29.90	---	60.00	30.10	L1	29.8	0.1	---
14.175236	---	22.15	50.00	27.85	L1	29.8	---	-7.65

This result is from the original test report SRTC2020-9003(F)-0069.

120VAC:

EUT + 3#AE: USB Cable2+5# AE: Charger2+7# AE: Headset2:

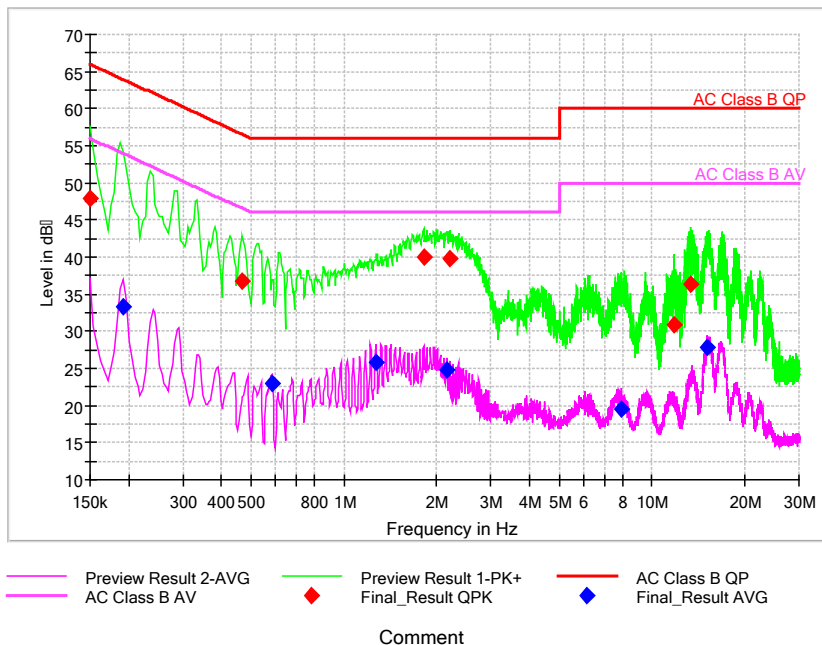

Pic5. Conducted emission L&N Line

Frequency (MHz)	QuasiPeak (dBμV)	Average (dBμV)	Limit (dBμV)	Margin (dB)	Line	Corr. (dB)	Pmea QuasiPeak (dBμV)	Pmea Average (dBμV)
0.150000	47.99	---	66.00	18.01	L1	29.6	18.39	---
0.192643	---	33.33	53.92	20.59	L1	29.6	---	3.73
0.469821	36.85	---	56.52	19.67	L1	29.6	7.25	---
0.584957	---	23.00	46.00	23.00	N	29.6	---	-6.6
1.271507	---	25.87	46.00	20.13	N	29.7	---	-3.83
1.813071	40.01	---	56.00	15.99	L1	29.7	10.31	---
2.158479	---	24.73	46.00	21.27	L1	29.7	---	-4.97
2.209650	39.88	---	56.00	16.12	L1	29.7	10.18	---
7.962171	---	19.55	50.00	30.45	L1	29.7	---	-10.15
11.791500	30.89	---	60.00	29.11	L1	29.8	1.09	---
13.377814	36.32	---	60.00	23.68	L1	29.8	6.52	---
15.151757	---	27.91	50.00	22.09	L1	29.8	---	-1.89

This result is from the original test report SRTC2020-9003(F)-0069.
EUT +2#AE: USB Cable1+6# AE: Headset1+1# AE: Laptop:

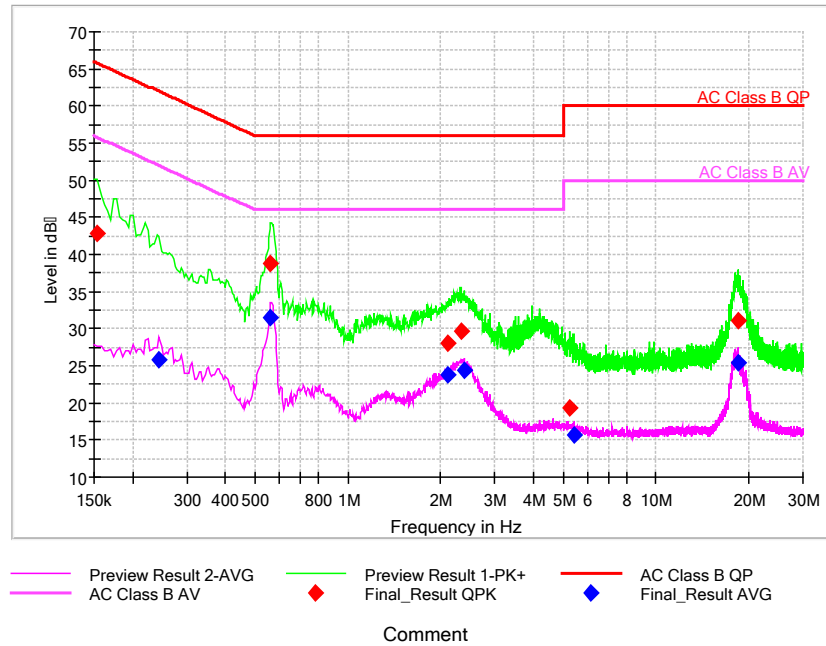

Pic6. Conducted emission L&N Line

Frequency (MHz)	QuasiPeak (dBμV)	Average (dBμV)	Limit (dBμV)	Margin (dB)	Line	Corr. (dB)	Pmea QuasiPeak (dBμV)	Pmea Average (dBμV)
0.153928	42.82	---	65.79	22.97	L1	29.6	13.22	---
0.244263	---	25.91	51.95	26.04	L1	29.6	---	-3.69
0.562401	---	31.51	46.00	14.49	L1	29.6	---	1.91
0.562401	38.77	---	56.00	17.23	L1	29.6	9.17	---
2.105961	28.08	---	56.00	27.92	L1	29.7	-1.62	---
2.109888	---	23.69	46.00	22.31	N	29.7	---	-6.01
2.321980	29.71	---	56.00	26.29	L1	29.7	0.01	---
2.392678	---	24.35	46.00	21.65	N	29.7	---	-5.35
5.244138	19.30	---	60.00	40.70	L1	29.7	-10.4	---
5.405171	---	15.59	50.00	34.41	L1	29.7	---	-14.11
18.492039	---	25.32	50.00	24.68	L1	29.8	---	-4.48
18.523461	30.99	---	60.00	29.01	L1	29.8	1.19	---

This result is from the original test report SRTC2020-9003(F)-0069.

EUT + 3#AE: USB Cable2+7# AE: Headset2+1# AE: Laptop:

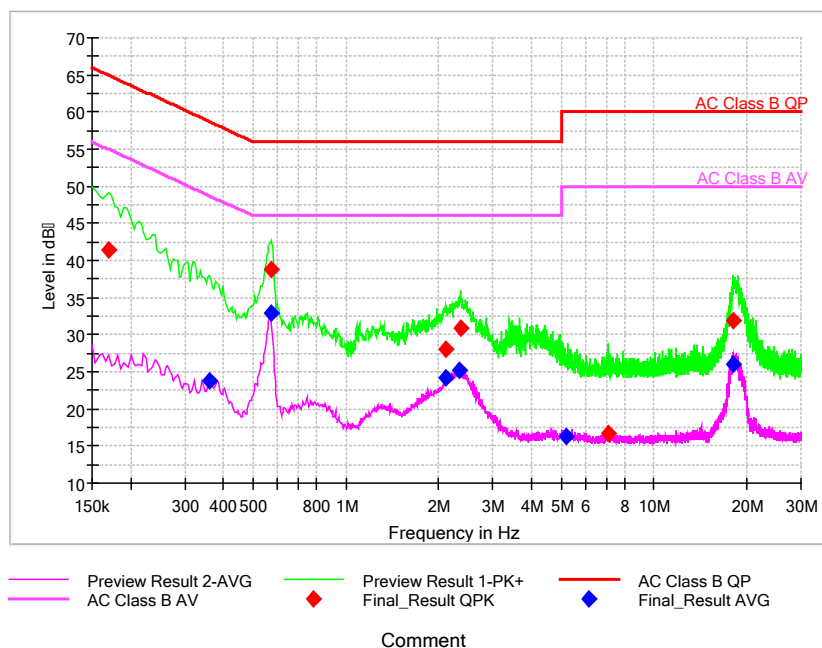

Pic7. Conducted emission L&N Line

Frequency (MHz)	QuasiPeak (dBμV)	Average (dBμV)	Limit (dBμV)	Margin (dB)	Line	Corr. (dB)	Pmea QuasiPeak (dBμV)	Pmea Average (dBμV)
0.169638	41.33	---	64.98	23.65	L1	29.6	11.73	---
0.362092	---	23.77	48.68	24.91	L1	29.6	---	-5.83
0.570257	---	32.85	46.00	13.15	L1	29.6	---	3.25
0.570257	38.82	---	56.00	17.18	L1	29.6	9.22	---
2.113816	28.10	---	56.00	27.90	L1	29.7	-1.6	---
2.117743	---	24.09	46.00	21.91	N	29.7	---	-5.61
2.321980	---	25.29	46.00	20.71	N	29.7	---	-4.41
2.349474	30.83	---	56.00	25.17	L1	29.7	1.13	---
5.173441	---	16.21	50.00	33.79	L1	29.7	---	-13.49
7.117618	16.76	---	60.00	43.24	L1	29.7	-12.94	---
18.107132	---	25.92	50.00	24.08	L1	29.8	---	-3.88
18.114987	31.91	---	60.00	28.09	L1	29.8	2.11	---

New test result:
EUT + Laptop:

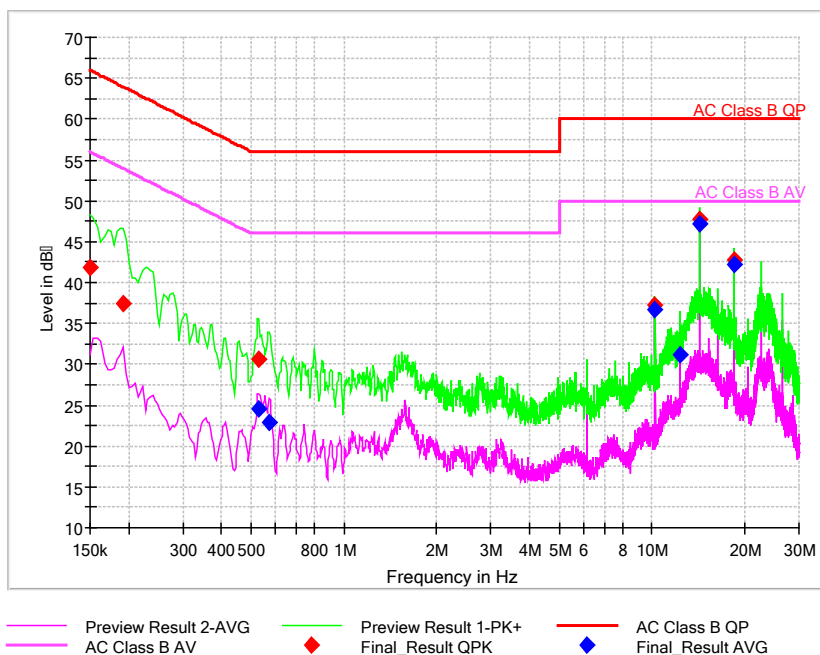

Pic8. Conducted emission L&N Line

Frequency (MHz)	QuasiPeak (dBμV)	Average (dBμV)	Limit (dBμV)	Margin (dB)	Line	Corr. (dB)	Pmea QuasiPeak (dBμV)	Pmea Average (dBμV)
0.150000	41.76	---	66.00	24.24	L1	29.7	12.06	---
0.192643	37.45	---	63.92	26.47	L1	29.7	7.75	---
0.529521	---	24.53	46.00	21.47	L1	29.7	---	-5.17
0.529521	30.62	---	56.00	25.38	L1	29.7	0.92	---
0.572164	---	22.83	46.00	23.17	L1	29.7	---	-6.87
10.239300	---	36.62	50.00	13.38	N	29.9	---	6.72
10.239300	37.15	---	60.00	22.85	N	29.9	7.25	---
12.286157	---	31.16	50.00	18.84	L1	30.0	---	1.16
14.337279	47.75	---	60.00	12.25	L1	30.0	17.75	---
14.337279	---	47.16	50.00	2.84	L1	30.0	---	17.16
18.430993	---	42.26	50.00	7.74	L1	30.1	---	12.16
18.430993	42.81	---	60.00	17.19	L1	30.1	12.71	---

2.2.2 Radiated Emissions-FCC Part15.109

Ambient condition:

Temperature	Relative humidity	Pressure
23.1°C	41.0%	101.2kPa

Test Setup:

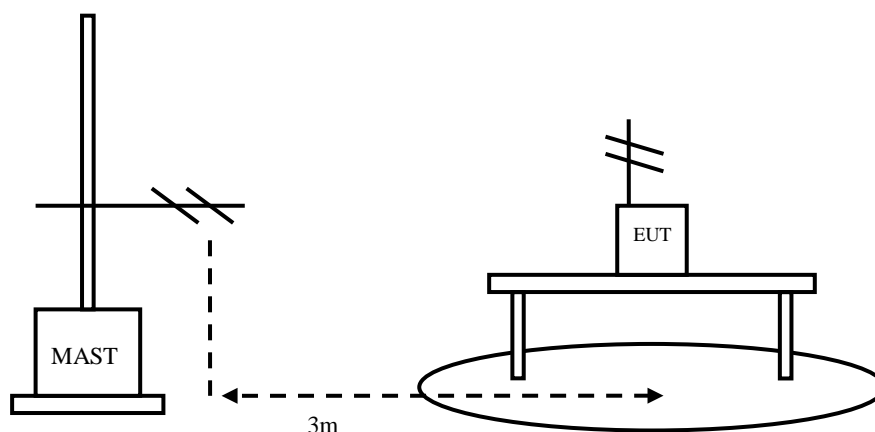

Figure 3

Test Procedure:

EUT+Laptop:

The EUT should be placed on a non-metallic table 80cm above the ground plane. The receive antennas shall be moved from 1 to 4 meters. The distance between EUT and receive antenna should be 3 meters.

The accessories of the EUT are connected with the EUT such as headset etc. The EUT was connected with a laptop via the USB cable and transferred the data by copying large files from laptop to the EUT. The test set-up and the test methods are performed according to ANSI C63.4:2014

Then start the test software EMC32. Sweep the whole frequency band through the range from 30MHz to 1GHz, using receive log period antenna VULB 9163.

During the test, the height of receive antenna shall be moved from 1 to 4 meters, and the antenna shall be performed under horizontal and vertical polarization. The turn table shall be rotated from 0 to 360 degrees for detecting the maximum of radiated spurious signal level. The measurements shall be repeated with orthogonal polarization of the test antenna. The EUT is laid in two modes as follow:
1. put the EUT in horizontal direction; 2. put the EUT in vertical direction.

The data of cable loss and antenna factor have been calibrated in full testing frequency range before the testing.

EUT+Charger:

The EUT should be placed on a non-metallic table 80cm above the ground plane. The receive antennas shall be moved from 1 to 4 meters. The distance between EUT and receive antenna should be 3 meters.

The EUT should work in idle mode. The accessories of the EUT are connected with the EUT such as headset etc. Open the following functions of EUT: Camera, flash lamp, FM, GPS and video. The test set-up and the test methods are performed according to ANSI C63.4:2014.

Then start the test software EMC32. Sweep the whole frequency band through the range from 30MHz to 1GHz, using receive log period antenna VULB 9163.

During the test, the height of receive antenna shall be moved from 1 to 4 meters, and the antenna shall be performed under horizontal and vertical polarization. The turn table shall be rotated from 0 to 360 degrees for detecting the maximum of radiated spurious signal level. The measurements shall be repeated with orthogonal polarization of the test antenna. The EUT is laid in two modes as follow:
1. put the EUT in horizontal direction; 2. put the EUT in vertical direction.

The data of cable loss and antenna factor have been calibrated in full testing frequency range before the testing. All test results are performed with max hold at the horizontal and vertical polarity.

RBW=120kHz, VBW=300kHz, when the test frequency: 30MHz<f<1GHz

RBW=1MHz, VBW=3MHz, when the test frequency: f>1GHz

A “reference path loss” is established and the A_{Rpl} is the attenuation of “reference path loss”, and including the gain of receive antenna, the gain of the preamplifier, the cable loss.

The measurement results are obtained as described below:

$$\text{Result} = P_{\text{mea}} + A_{Rpl}$$

Limit:

Frequency of Emission(MHz)	Limits	
	Detector	Unit (dB μ V/m)
30~88	Quasi-peak	40
88~216	Quasi-peak	43.5
216~960	Quasi-peak	46
960~1000	Quasi-peak	54
1000~5th harmonic of the highest frequency or 40GHz, whichever is lower	Average	54
	Peak	74

Test result:

Sample calculation: $(21.20 \text{ dB } \mu \text{ V/m}) = (42.80 \text{ dB } \mu \text{ V/m}) + (-21.6 \text{ dB})$, the corresponding frequency is 70.018000MHz.

These results are from the original test report SRTC2020-9003(F)-0069.

EUT + 2#AE: USB Cable1+4# AE: Charger1+6# AE: Headset1:

Frequency(MHz)	Result(dB μ V/m)	Limit (dB μ V/m)	ARpl (dB)	Pmea (dB μ V/m)	Polarity
70.018000	21.20	40.00	-21.6	42.80	V
72.962000	21.72	40.00	-22.3	44.02	V
73.227500	20.83	40.00	-22.4	43.23	V
73.786500	18.70	40.00	-22.5	41.20	V
75.604000	18.07	40.00	-22.9	40.97	V
75.960500	15.85	40.00	-23.0	38.85	V

EUT + 3#AE: USB Cable2+5# AE: Charger2+7# AE: Headset2:

Frequency(MHz)	Result(dB μ V/m)	Limit (dB μ V/m)	ARpl (dB)	Pmea (dB μ V/m)	Polarity
50.672500	23.32	40.00	-17.2	40.52	V
51.012000	24.90	40.00	-17.2	42.10	V
51.351500	25.14	40.00	-17.3	42.44	V
51.662000	24.62	40.00	-17.3	41.92	V
52.341000	22.81	40.00	-17.4	40.21	V
52.998000	23.03	40.00	-17.5	40.53	V

EUT + 2#AE: USB Cable1+6# AE: Headset1+1# AE: Laptop:

Frequency(MHz)	Result(dB μ V/m)	Limit (dB μ V/m)	ARpl (dB)	Pmea (dB μ V/m)	Polarity
168.002500	26.79	43.50	-20.8	47.59	V
407.989000	30.19	46.00	-11.5	41.69	V
455.995500	28.93	46.00	-10.4	39.33	V
551.985500	28.60	46.00	-7.9	36.50	V
600.000500	30.20	46.00	-6.6	36.80	V
800.006000	26.37	46.00	-3.4	29.77	V

EUT + 3#AE: USB Cable2+7# AE: Headset2+1# AE: Laptop:

Frequency(MHz)	Result(dB μ V/m)	Limit (dB μ V/m)	ARpl (dB)	Pmea (dB μ V/m)	Polarity
168.002500	26.86	43.50	-20.8	47.66	V
407.989000	30.27	46.00	-11.5	41.77	V
455.995500	28.95	46.00	-10.4	39.35	V
551.985500	28.47	46.00	-7.9	36.37	V
599.992000	30.16	46.00	-6.6	36.76	V
800.006000	26.35	46.00	-3.4	29.75	V

New test result:

EUT + Laptop:

Frequency(MHz)	Result(dB μ V/m)	Limit (dB μ V/m)	ARpl (dB)	Pmea (dB μ V/m)	Polarity
30.679	30.97	40.00	-12.3	43.27	V
71.6615	27.2	40.00	-23.4	50.6	V
145.3815	16.24	43.50	-22.4	38.64	V
295.974	23.68	46.00	-18.1	41.78	V
394.6715	16.85	46.00	-14.9	31.75	V
597.935	16.88	46.00	-9.6	26.48	V

These results are from the original test report SRTC2020-9003(F)-0069.
 EUT + 2#AE: USB Cable1+4# AE: Charger1+6# AE: Headset1:

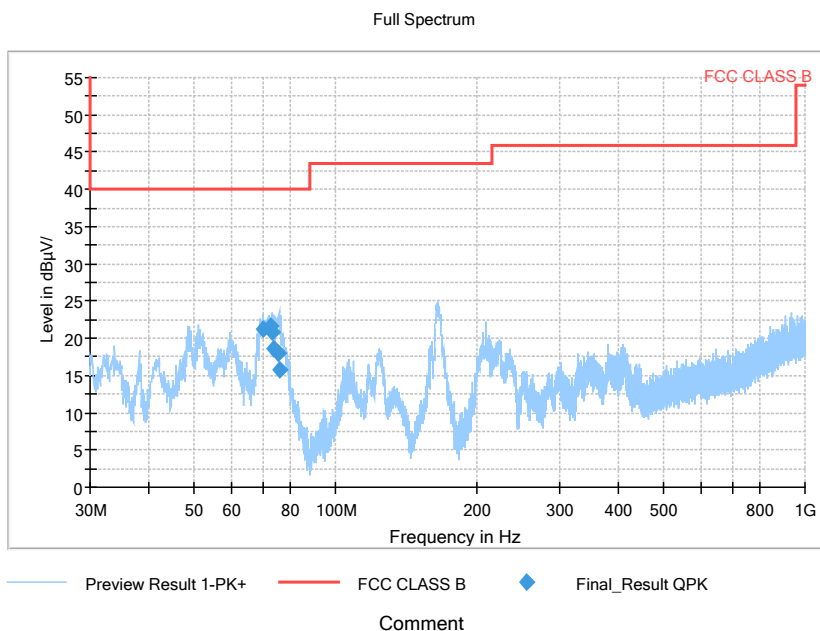

Pic9. Radiated emission(30MHz – 1GHz)

Note: The test data in the graph includes two polarizations: horizontal and vertical

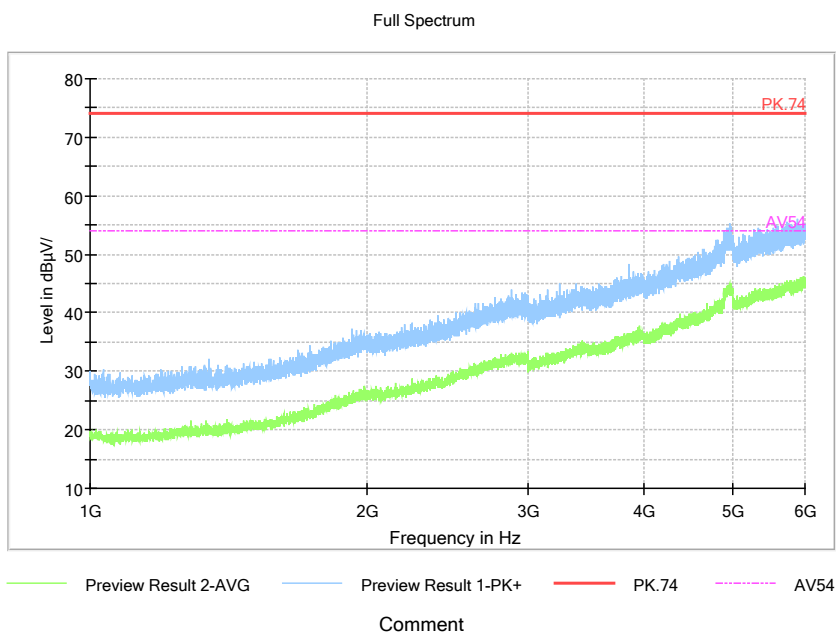

Pic10. Radiated emission (1GHz –6GHz)

Note: The test data in the graph includes two polarizations: horizontal and vertical.

Full Spectrum

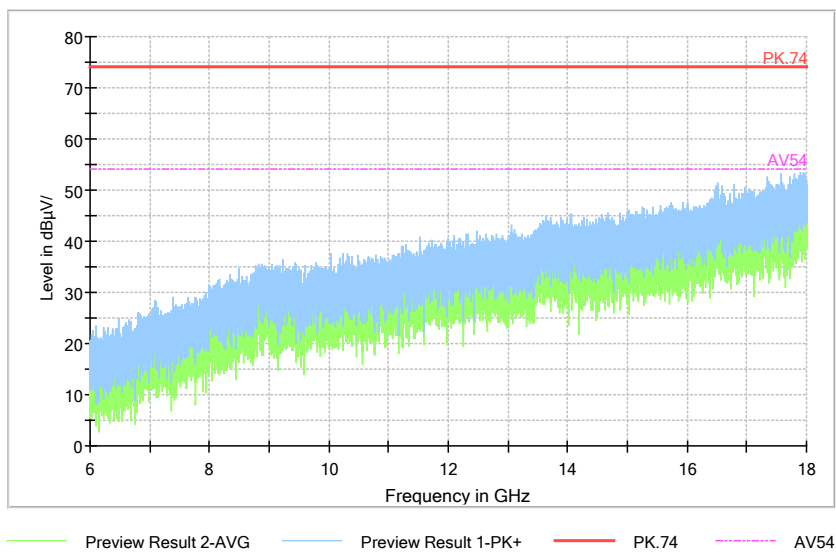

Comment

Pic11. Radiated emission (6GHz –18GHz)

Note: The test data in the graph includes two polarizations: horizontal and vertical.

EUT+ 3#AE: USB Cable2+5# AE: Charger2+7# AE: Headset2:

Full Spectrum

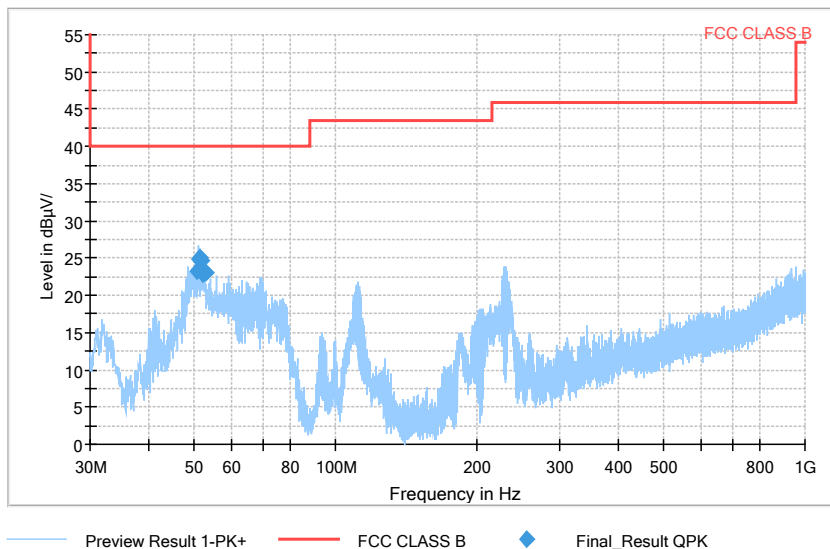

Comment

Pic12. Radiated emission(30MHz – 1GHz)

Note: The test data in the graph includes two polarizations: horizontal and vertical

Full Spectrum

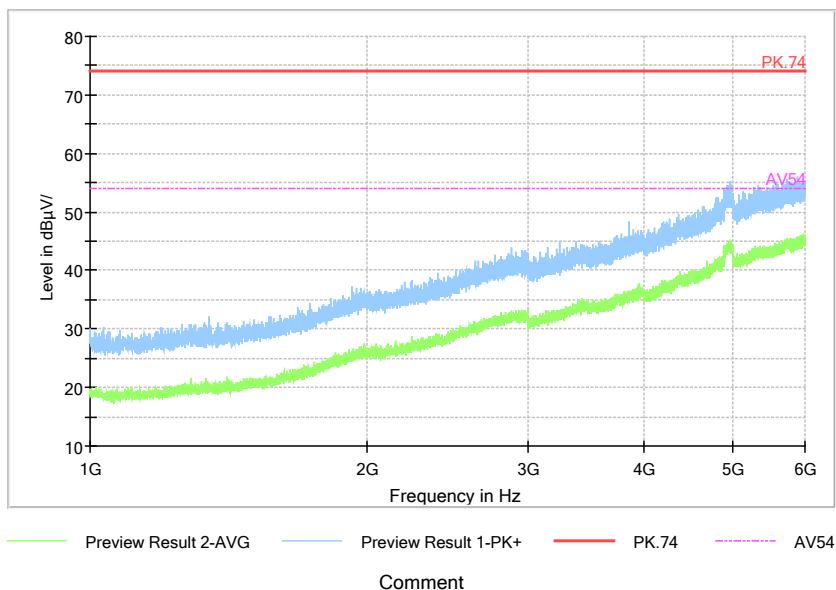

Comment

Pic13. Radiated emission (1GHz –6GHz)

Note: The test data in the graph includes two polarizations: horizontal and vertical.

Full Spectrum

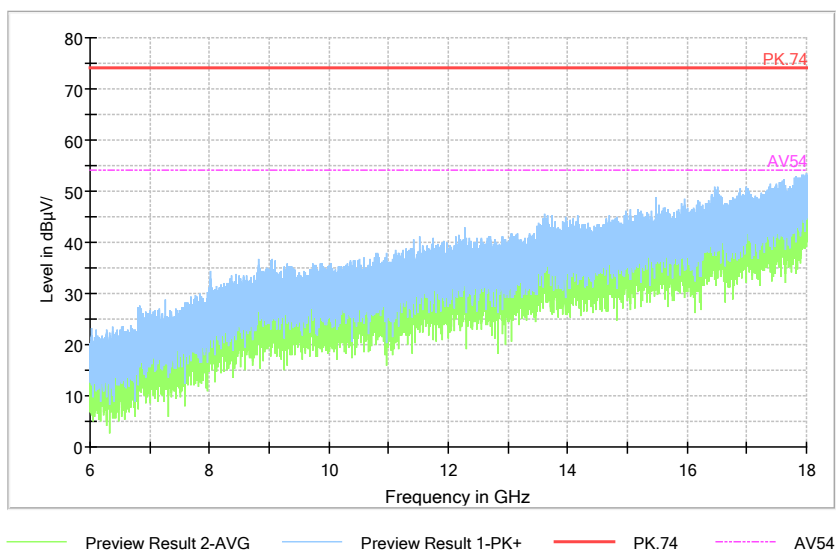

Comment

Pic14. Radiated emission (6GHz –18GHz)

Note: The test data in the graph includes two polarizations: horizontal and vertical.

EUT + 2#AE: USB Cable1 +6# AE: Headset1+1# AE: Laptop:

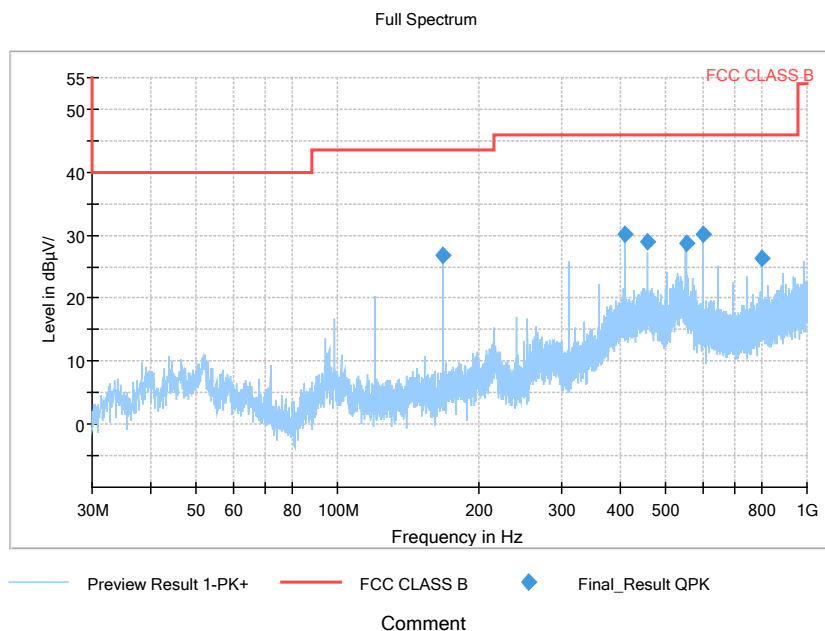

Pic15. Radiated emission(30MHz – 1GHz)

Note: The test data in the graph includes two polarizations: horizontal and vertical

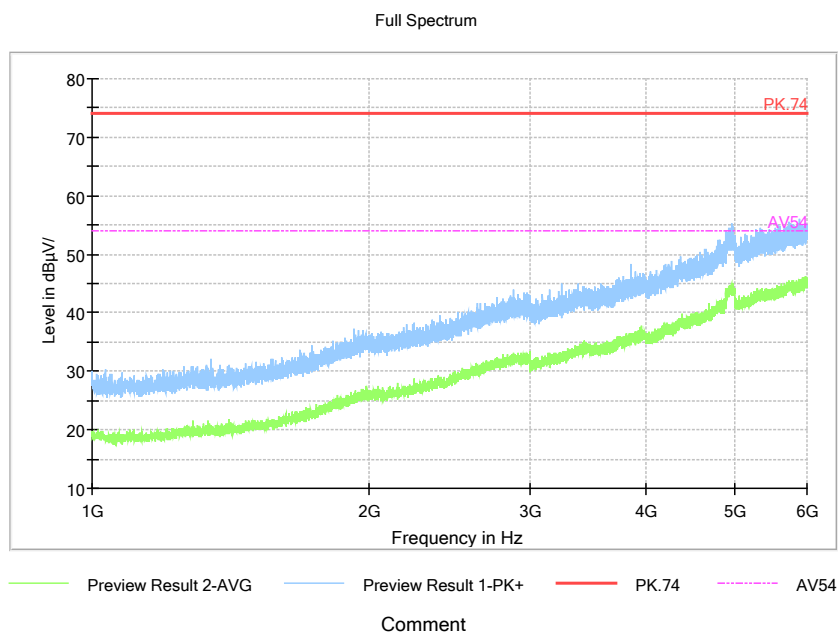

Pic16. Radiated emission (1GHz –6GHz)

Note: The test data in the graph includes two polarizations: horizontal and vertical.

Full Spectrum

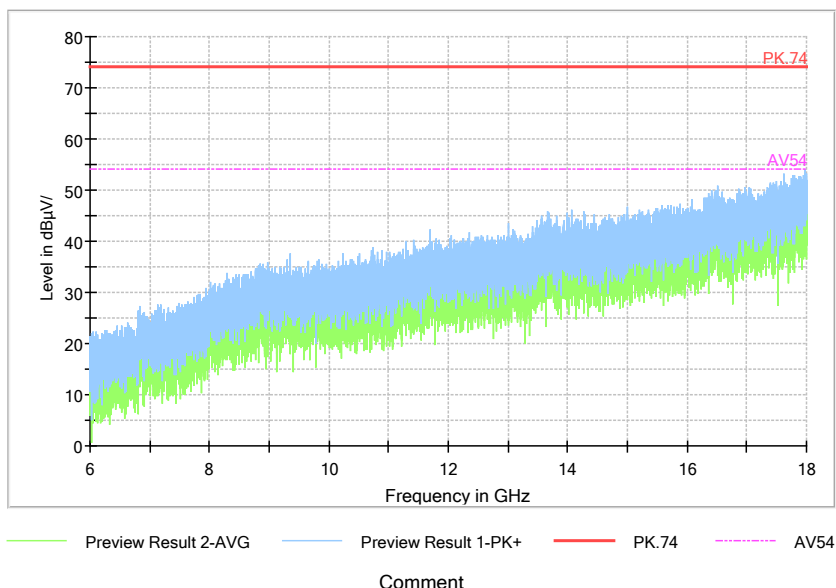

Comment

Pic17. Radiated emission (6GHz –18GHz)

Note: The test data in the graph includes two polarizations: horizontal and vertical.

EUT + 3#AE: USB Cable2+7# AE: Headset2+1# AE: Laptop:

Full Spectrum

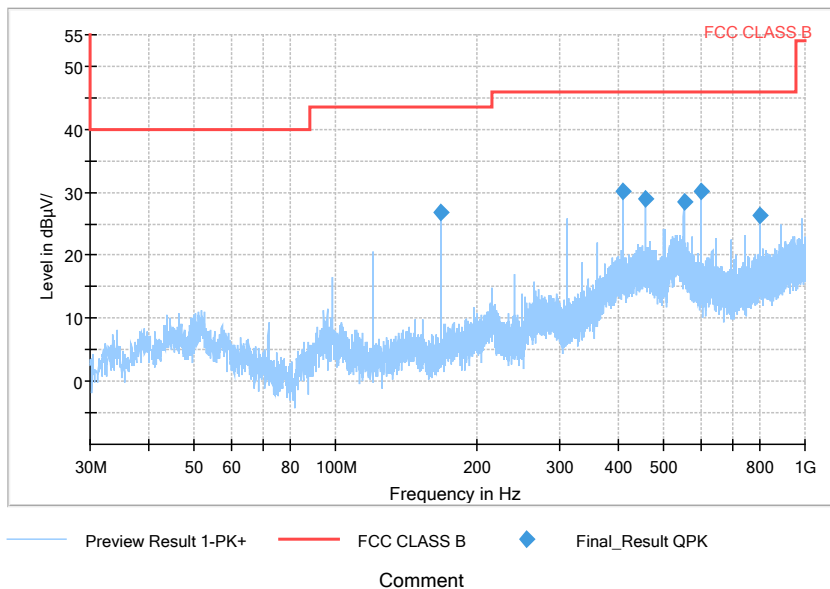

Comment

Pic18. Radiated emission(30MHz – 1GHz)

Note: The test data in the graph includes two polarizations: horizontal and vertical

Full Spectrum

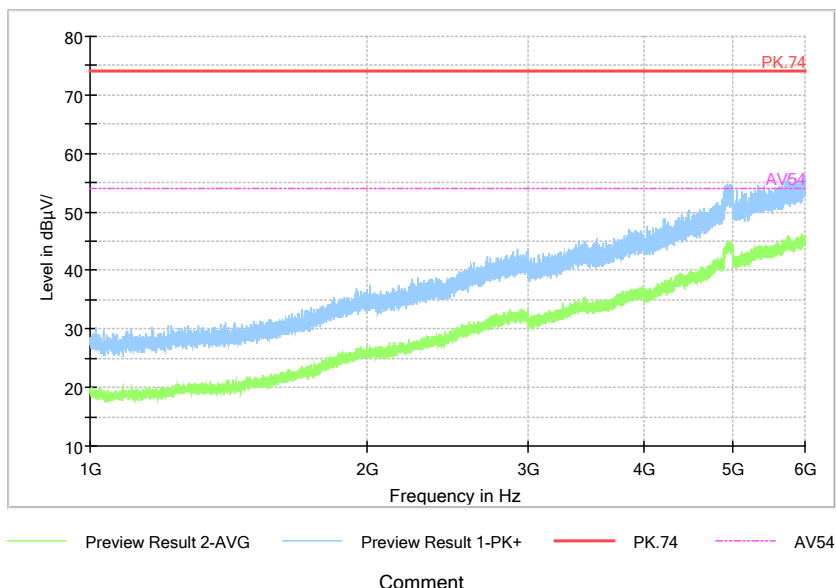

Comment

Pic19. Radiated emission (1GHz –6GHz)

Note: The test data in the graph includes two polarizations: horizontal and vertical

Full Spectrum

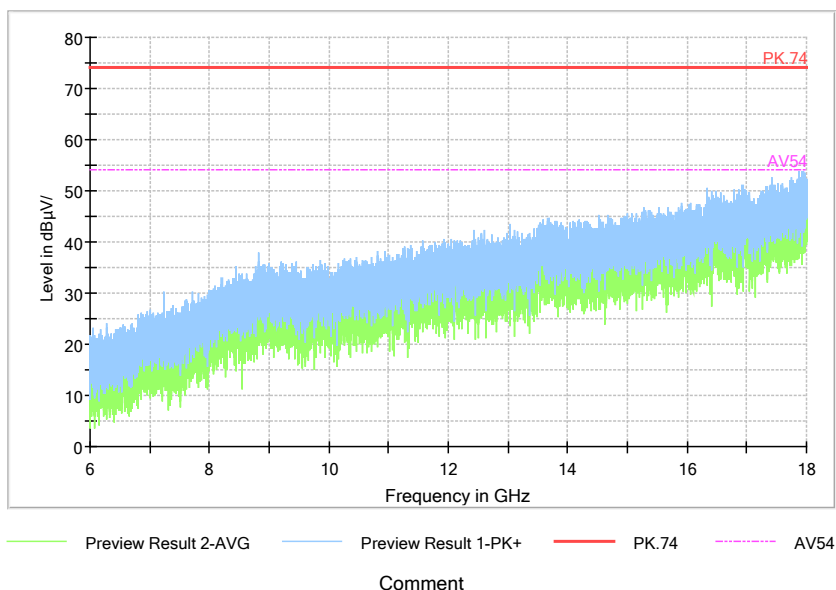

Comment

Pic20. Radiated emission (6GHz –18GHz)

Note: The test data in the graph includes two polarizations: horizontal and vertical

New test result:

EUT + Laptop: refer to Pic21, Pic22, Pic23

Full Spectrum

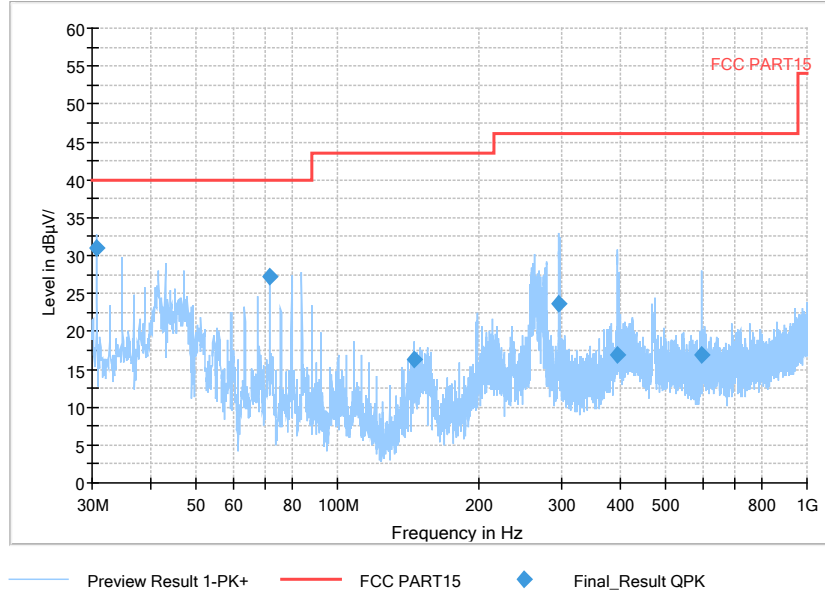

Pic21. Radiated emission(30MHz – 1GHz)

Note: The test data in the graph includes two polarizations: horizontal and vertical

Full Spectrum

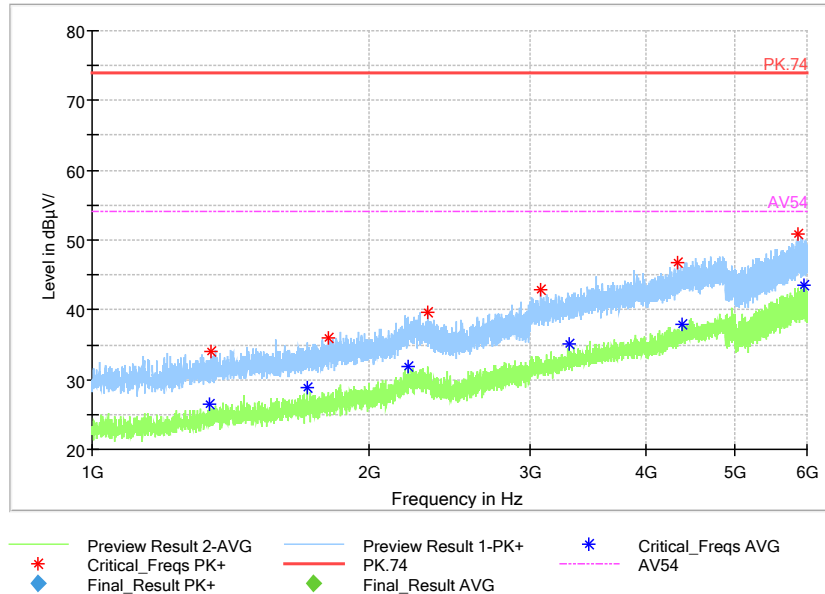

Pic22. Radiated emission (1GHz –6GHz)

Note: The test data in the graph includes two polarizations: horizontal and vertical.

Full Spectrum

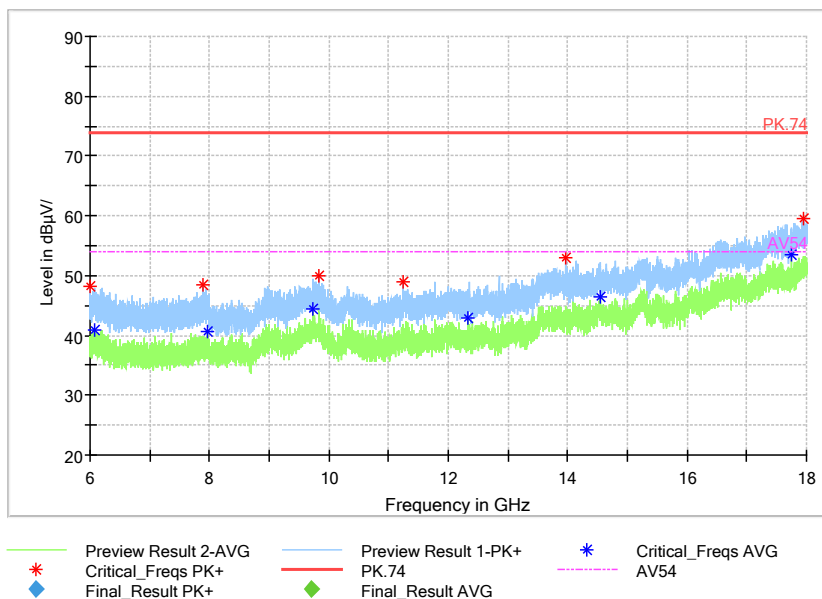

Pic23. Radiated emission (6GHz –18GHz)

Note: The test data in the graph includes two polarizations: horizontal and vertical.

2.3. List of test equipments

No.	Name/Model	Manufacturer	S/N	Calibration Due Date	Calibration Date
1	23.18m×16.88m×9.60mS emi-AnechoicChamber	FRANKONIA	-----	5th Sep. 2021	6th Sep. 2016
2	ESW EMI test receiver	R&S	101574	20th Aug. 2021	20th Aug. 2020
3	9.080m×5.255m×3.525m Shielding room	FRANKONIA	-----	5th Sep. 2021	6th Sep. 2016
4	ESR3 EMI test receiver	R&S	102361	21th Apr. 2021	20th Apr. 2020
5	VULB 9163 Ultra log test antenna	schwarzbeck	867	25th Mar. 2022	25th Mar. 2021
6	ENV216 AMN	R&S	3560.6550. 12	20th Aug. 2021	20th Aug. 2020
7	HF 907 Double-Ridged Waveguide Horn Antenna	R&S	100512	25th Mar. 2022	25th Mar. 2021
8	PS2000 Turn Table	FRANKONIA	-----	-----	-----
9	MA260 Antenna Master	FRANKONIA	-----	-----	-----
10	EMC32EMI test software Version 10.20.01	R&S	-----	-----	-----

-----The end-----