



MRT Technology (Suzhou) Co., Ltd
Phone: +86-512-66308358
Fax: +86-512-66308368
Web: www.mrt-cert.com

Report No.: 1602RSU00101
Report Version: V01
Issue Date: 03-24-2016

MEASUREMENT REPORT

FCC PART 95 Walkie Talkie

FCC ID: 2AHJLR8
APPLICANT: Shenzhen Freetalker Industry Co., Ltd

Application Type: Certification
Product: Walkie Talkie
Model No.: R8, T-899, R5, R6, R7, R9
FCC Rule Part(s): FCC Part 95: 2015
Test Procedure(s): ANSI/TIA-603-D: 2010
Test Date: February 10 ~ March 24, 2016

Reviewed By : Robin Wu
(Robin Wu)

Approved By : Marlin Chen
(Marlin Chen)



The test results relate only to the samples tested.
This equipment has been shown to be capable of compliance with the applicable technical standards as indicated in the measurement report and was tested in accordance with the measurement procedures specified in ANSI/TIA-603-D: 2010. Test results reported herein relate only to the item(s) tested.
The test report shall not be reproduced except in full without the written approval of MRT Technology (Suzhou) Co., Ltd.

Revision History

Report No.	Version	Description	Issue Date
1602RSU00101	Rev. 01	Initial report	2016-03-24

CONTENTS

Description	Page
§2.1033 General Information	5
1. INTRODUCTION	6
1.1. Scope	6
1.2. MRT Test Location	6
2. PRODUCT INFORMATION	7
2.1. Equipment Description.....	7
2.2. Frequency Operation / Channel List	7
2.3. Test Standards	8
2.4. Test Methodology	8
3. TEST EQUIPMENT CALIBRATION DATE	9
4. MEASUREMENT UNCERTAINTY	10
5. TEST RESULT	11
5.1. Summary	11
5.2. RF Output Power.....	12
5.2.1. Provisions Applicable	12
5.2.2. Test Procedure.....	12
5.2.3. Test Setup.....	13
5.2.4. Test Result.....	14
5.3. Modulation Characteristics.....	15
5.3.1. Provisions Applicable	15
5.3.2. Test Procedure.....	15
5.3.2.1 <i>Frequency deviation</i>	15
5.3.2.2 <i>Modulation Frequency Response</i>	15
5.3.2.3 <i>Audio Low Pass Filter Response</i>	16
5.3.3. Test Setup.....	16
5.3.4. Test Result.....	17
5.4. Occupied Bandwidth And Emission Mask	23
5.4.1. Provisions Applicable	23
5.4.2. Test Procedure.....	23
5.4.3. Test Setup.....	23
5.4.4. Test Result.....	24
5.5. Unwanted Radiated Spurious Emission	28
5.5.1. Provisions Applicable	28

5.5.2.	Test Procedure.....	28
5.5.3.	Test Setup.....	29
5.5.4.	Test Result.....	30
5.6.	Frequency Stability	31
5.6.1.	Provisions Applicable	31
5.6.2.	Test Procedure.....	31
5.6.2.1.	<i>Frequency stability versus environmental temperature</i>	<i>31</i>
5.6.2.2.	<i>Frequency stability versus input voltage.....</i>	<i>31</i>
5.6.3.	Test Setup.....	32
5.6.4.	Test Result.....	33
6.	CONCLUSION.....	35

§2.1033 General Information

Applicant:	Shenzhen Freetalker Industry Co., Ltd
Applicant Address:	6/F, Building A, Xinghong Science Park, No.111 of Shuiku Rd., Fenghuanggang, Xixiang, Bao'an, Shenzhen, China
Manufacturer:	Shenzhen Freetalker Industry Co., Ltd
Manufacturer Address:	6/F, Building A, Xinghong Science Park, No.111 of Shuiku Rd., Fenghuanggang, Xixiang, Bao'an, Shenzhen, China
Test Site:	MRT Technology (Suzhou) Co., Ltd
Test Site Address:	D8 Building, Youxin Industrial Park, No.2 Tian'edang Rd., Wuzhong Economic Development Zone, Suzhou, China
MRT Registration No.:	809388
FCC Rule Part(s):	Part 95
Model No.	R8, T-899, R5, R6, R7, R9
FCC ID:	2AHJLR8
Test Device Serial No.:	N/A <input type="checkbox"/> Production <input checked="" type="checkbox"/> Pre-Production <input type="checkbox"/> Engineering
FCC Classification:	Part 95 Family Radio Face Held Transmitter (FRF)

Test Facility / Accreditations

Measurements were performed at MRT Laboratory located in Tian'edang Rd., Suzhou, China.

- MRT facility is a FCC registered (MRT Reg. No. 809388) test facility with the site description report on file and has met all the requirements specified in Section 2.948 of the FCC Rules.
- MRT facility is an IC registered (MRT Reg. No. 11384A-1) test laboratory with the site description on file at Industry Canada.
- MRT facility is a VCCI registered (R-4179, G-814, C-4664, T-2206) test laboratory with the site description on file at VCCI Council.
- MRT Lab is accredited to ISO 17025 by the American Association for Laboratory Accreditation (A2LA) under the American Association for Laboratory Accreditation Program (A2LA Cert. No. 3628.01) in EMC, Telecommunications and Radio testing for FCC, Industry Canada, EU and TELEC Rules.



1. INTRODUCTION

1.1. Scope

Measurement and determination of electromagnetic emissions (EMC) of radio frequency devices including intentional and/or unintentional radiators for compliance with the technical rules and regulations of the Federal Communications Commission and the Industry Canada Certification and Engineering Bureau.

1.2. MRT Test Location

The map below shows the location of the MRT LABORATORY, its proximity to the Taihu Lake. These measurement tests were conducted at the MRT Technology (Suzhou) Co., Ltd. Facility located at D8 Building, No.2 Tian'edang Rd., Wuzhong Economic Development Zone, Suzhou, China. The detailed description of the measurement facility was found to be in compliance with the requirements of § 2.948 according to ANSI C63.4-2009 on September 30, 2013.



2. PRODUCT INFORMATION

2.1. Equipment Description

Product Name	Walkie Talkie
Model No.	R8, T-899, R5, R6, R7, R9
Frequency Range	462.5625~462.7125MHz (FRS 1~7 channel) 467.5625~467.7125MHz (FRS 8~14 channel) 462.5500~462.7250MHz (GMRS 15~22 channel)
Maximum Radiated Output Power	20.06dBm
Type of Modulation	FM
Antenna Type	Fixed external

Note: The difference of models is only for different markets.

2.2. Frequency Operation / Channel List

Channel	Frequency	Description	Channel	Frequency	Description
1	462.5625MHz	FRS	12	467.6625 MHz	FRS
2	462.5875 MHz	FRS	13	467.6875 MHz	FRS
3	462.6125 MHz	FRS	14	467.7125 MHz	FRS
4	462.6375 MHz	FRS	15	462.5500 MHz	GMRS
5	462.6625 MHz	FRS	16	462.5750 MHz	GMRS
6	462.6875 MHz	FRS	17	462.6000 MHz	GMRS
7	462.7125 MHz	FRS	18	462.6250 MHz	GMRS
8	467.5625 MHz	FRS	19	462.6500 MHz	GMRS
9	467.5875 MHz	FRS	20	462.6750 MHz	GMRS
10	467.6125 MHz	FRS	21	462.7000 MHz	GMRS
11	467.6375 MHz	FRS	22	462.7250 MHz	GMRS

2.3. Test Standards

The following report is prepared on behalf of the Shenzhen Freetalker Industry Co., Ltd in accordance with FCC Part 95, Subpart A, Subpart B and FCC Part 2 of the Federal Communication Commission rules.

The objective is to determine compliance with FCC Part 95, Subpart A, Subpart B and FCC Part 2 of the Federal Communication Commission rules.

Maintenance of compliance is the responsibility of the manufacturer. Any modification of the product, which results in lowering the emission, should be checked to ensure compliance has been maintained.

2.4. Test Methodology

All measurements contained in this report were conducted with TIA-603-D Land Mobile FM or PM Communications Equipment Measurement and Performance Standards and Performance standards and ANSI C63.4-2014, American National Standard for Methods of Measurement of Radio-Noise Emissions from Low-Voltage Electrical and Electronic Equipment in the range of 9 kHz to 40 GHz.

3. TEST EQUIPMENT CALIBRATION DATE

Modulation Characteristics – TR3

Instrument	Manufacturer	Type No.	Asset No.	Cali. Interval	Cali. Due Date
Audio Analyzer	Agilent	U8903B	MRTSUE06143	1 year	2016/08/11
Modulation Analyzer	HP	8901A	MRTSUE06210	1 year	2016/07/08
Temperature/Humidity Meter	Yuhuaze	HTC-2	MRTSUE06180	1 year	2016/12/20

Occupied Bandwidth And Emission Mask – TR3

Instrument	Manufacturer	Type No.	Asset No.	Cali. Interval	Cali. Due Date
Spectrum Analyzer	Agilent	N9020A	MRTSUE06106	1 year	2016/05/08
Audio Analyzer	Agilent	U8903B	MRTSUE06143	1 year	2016/08/11
Temperature/Humidity Meter	Yuhuaze	HTC-2	MRTSUE06180	1 year	2016/12/20

Unwanted Radiated Spurious Emission / RF Output Power – AC1

Instrument	Manufacturer	Type No.	Asset No.	Cali. Interval	Cal. Due Date
ESG Vector Signal Generator	Agilent	E4438C	MRTSUE06026	1 year	2016/12/08
Microwave System Amplifier	Agilent	83017A	MRTSUE06076	1 year	2016/03/29
Loop Antenna	Schwarzbeck	FMZB1519	MRTSUE06025	1 year	2016/12/14
TRILOG Antenna	Schwarzbeck	VULB9162	MRTSUE06022	1 year	2016/11/07
BroadBand Horn Antenna	Schwarzbeck	BBHA9120 D	MRTSUE06023	1 year	2016/11/07
Broadband Horn Antenna	Schwarzbeck	BBHA9170	MRTSUE06024	1 year	2017/01/04
Temperature/Humidity Meter	Yuhuaze	HTC-2	MRTSUE06181	1 year	2016/12/20

Frequency Stability – TR3

Instrument	Manufacturer	Type No.	Asset No.	Cali. Interval	Cali. Due Date
Spectrum Analyzer	Agilent	N9020A	MRTSUE06106	1 year	2016/05/08
Temperature & Humidity Chamber	BAOYT	BYH-1500L	MRTSUE06051	1 year	2016/12/08
Temperature/Humidity Meter	Yuhuaze	HTC-2	MRTSUE06180	1 year	2016/12/20

4. MEASUREMENT UNCERTAINTY

Where relevant, the following test uncertainty levels have been estimated for tests performed on the EUT as specified in CISPR 16-4-2. This uncertainty represents an expanded uncertainty expressed at approximately the 95% confidence level using a coverage factor of $k = 2$.

Radiated Emission Measurement
Measuring Uncertainty for a Level of Confidence of 95% ($U=2Uc(y)$): 9kHz ~ 1GHz: $\pm 4.2\text{dB}$ 1GHz ~ 40GHz: $\pm 4.8\text{dB}$

5. TEST RESULT

5.1. Summary

Product Name: Walkie Talkie

FCC ID: 2AHJLR8

Number of Channels: 22

FCC Part Section(s)	Test Description	Test Result	Reference
95.639	Radiated Output Power (ERP)	Pass	Section 5.2
95.637	Modulation Characteristics	Pass	Section 5.3
95.633	Occupied Bandwidth and Emission Mask	Pass	Section 5.4
95.635	Radiated Spurious Emissions	Pass	Section 5.5
95.621, 95.626	Frequency Stability	Pass	Section 5.6

Notes:

- (1) All modes of operation were investigated. The test results shown in the following sections represent the worst case emissions.
- (2) The analyzer plots shown in this section were all taken with a correction table loaded into the analyzer. The correction table was used to account for the losses of the cables and attenuators used as part of the system to connect the EUT to the analyzer at all frequencies of interest.
- (3) All antenna port conducted emissions testing was performed on a test bench with the antenna port of the EUT connected to the spectrum analyzer through calibrated cables and attenuators.

5.2. RF Output Power

5.2.1. Provisions Applicable

Per FCC §2.1046 and §95.639(d): No FRS unit, under any condition of modulation, shall exceed 0.500 W effective radiated Power (ERP)

Per FCC §2.1046 and §95.639(a): No GMRS transmitter, under any condition of modulation, shall exceed 50 W Carrier power (average TP during one un-modulated RF cycle) when transmitting emission type A1D, F1D, G1D, A3E, F3E or G3E.

5.2.2. Test Procedure

1. On a test site, the EUT shall be placed on a turntable and in the position closest to the normal use as declared by the user.
2. The test antenna shall be oriented initially for vertical polarization located 3m from the EUT to correspond to the transmitter.
3. The output of the antenna shall be connected to the measuring receiver and either a peak or quasi-peak detector was used for the measurement as indicated on the report. The detector selection is based on how close the emission level was approaching the limit.
4. The transmitter shall be switched on; if possible, without the modulation and the measurement receiver shall be tuned to the frequency of the transmitter under test.
5. The test antenna shall be raised and lowered through the specified range of height until the measuring receiver detects a maximum signal level.
6. The transmitter shall then be rotated through 360° in the horizontal plane, until the maximum signal level is detected by the measuring receiver.
7. The test antenna shall be raised and lowered again through the specified range of height until the measuring receiver detects a maximum signal level.
8. The maximum signal level detected by the measuring receiver shall be noted.
9. The measurement shall be repeated with the test antenna set to horizontal polarization.
10. Replace the antenna with a proper Antenna (substitution antenna).
11. The substitution antenna shall be oriented for vertical polarization and, if necessary, the length of the substitution antenna shall be adjusted to correspond to the frequency of transmitting.

12. The substitution antenna shall be connected to a calibrated signal generator.
13. If necessary, the input attenuator setting of the measuring receiver shall be adjusted in order to increase the sensitivity of the measuring receiver.
14. The test antenna shall be raised and lowered through the specified range of the height to ensure that the maximum signal is received.
15. The input signal to substitution antenna shall be adjusted to the level that produces a level detected by the measuring receiver, that is equal to the level noted while the transmitter radiated power was measured, corrected for the change of input attenuation setting of the measuring receiver.
16. The input level to the substitution antenna shall be recorded as power level in dBm, corrected for any change of input attenuator setting of the measuring receiver.
17. The measurement shall be repeated with the test antenna and the substitution antenna oriented for horizontal polarization.

5.2.3. Test Setup

30MHz ~ 1GHz Test Setup:

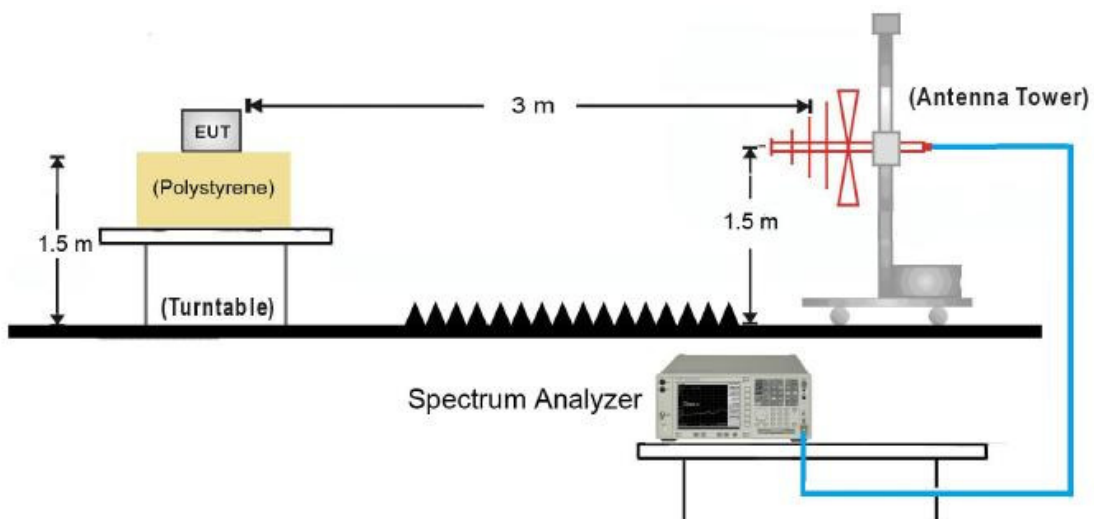

5.2.4. Test Result

Channel	Channel Description	Frequency	Effective Radiated Power		Limit	Over Limit
		MHz	dBm	W	W	W
1	FRS	462.5625	19.97	0.0993	0.5	-0.4007
2		462.5875	19.92	0.0982	0.5	-0.4018
3		462.6125	19.25	0.0841	0.5	-0.4159
4		462.6375	19.57	0.0906	0.5	-0.4094
5		462.6625	19.75	0.0944	0.5	-0.4056
6		462.6875	19.81	0.0957	0.5	-0.4043
7		462.7125	19.70	0.0933	0.5	-0.4067
8	FRS	467.5625	20.03	0.1007	0.5	-0.3993
9		467.5875	20.01	0.1002	0.5	-0.3998
10		467.6125	19.98	0.0995	0.5	-0.4005
11		467.6375	20.06	0.1014	0.5	-0.3986
12		467.6625	19.80	0.0955	0.5	-0.4045
13		467.6875	19.79	0.0953	0.5	-0.4047
14		467.7125	20.04	0.1009	0.5	-0.3991
15	GMRS	462.5500	19.55	0.0902	50	-49.9098
16		462.5750	19.49	0.0889	50	-49.9111
17		462.6000	19.80	0.0955	50	-49.9045
18		462.6250	19.33	0.0857	50	-49.9143
19		462.6500	19.41	0.0873	50	-49.9127
20		462.6750	19.54	0.0899	50	-49.9101
21		462.7000	19.57	0.0906	50	-49.9094
22		462.7250	19.91	0.0979	50	-49.9021

5.3. Modulation Characteristics

5.3.1. Provisions Applicable

Per FCC §2.1047 and §95.637(a): A GMRS transmitter that transmits emission type F3E must not exceed a peak frequency deviation of plus or minus 5 kHz. A FRS unit that transmits emission type F3E must not exceed a peak frequency deviation of plus or minus 2.5 kHz, and the audio frequency response must not exceed 3.125 kHz, the audio frequency response shall roll off before 3.125 kHz.

Each GMRS transmitter, except a mobile station transmitter with a power output of 2.5 W or less, must automatically prevent a greater than normal audio level from causing over-modulation.

The transmitter also must include audio frequency low pass filtering, unless it complies with the applicable paragraphs of § 95.631 (without filtering.) The filter must be between the modulation limiter and the modulated stage of the transmitter. At any frequency (f in kHz) between 3 and 20 kHz, the filter must have an attenuation of at least $60 \log_{10}(f/3)$ dB greater than the attenuation at 1 kHz.

Above 20 kHz, it must have an attenuation of at least 50 dB greater than the attenuation at 1 kHz.

5.3.2. Test Procedure

5.3.2.1 Frequency deviation

1. Configure the EUT as shown in figure 1, adjust the audio input for 60% of rated system deviation at 1 KHz using this level as a reference (0dB) and vary the input level from -20 to +20dB. Record the frequency deviation obtained as a function of the input level.
2. Repeat step (1) with input frequency changing to 500, 1000, 2500 and 3125Hz in sequence.

5.3.2.2 Modulation Frequency Response

1. Configure the EUT as shown in figure 1.
2. Adjust the audio signal generator frequency to the sound pressure level 107dB SPL at the microphone of the EUT.
3. Vary the Audio frequency from 100 Hz to 5 KHz and record the frequency deviation.
4. The peak frequency deviation must not exceed 2.5 KHz.

5.3.2.3 Audio Low Pass Filter Response

1. Connect the equipment in figure 2.
2. Connect the audio frequency generator as close as possible the input of the post limiter low pass filter within the transmitter under test.
3. Connect the audio spectrum analyzer to the output of the post limiter low pass filter within the transmitter under test.
4. Apply a 1000 Hz tone from the audio frequency generator and adjust the level per manufacturer's specifications.
5. Record the dB level of the 1000 Hz spectral line on the audio spectrum analyzer as LEV1.
6. Set the audio frequency generator to the desired test frequency between 3000 Hz and the upper low pass filter limit.
7. Record audio spectrum analyzer levels, at the test frequency in step (6).
8. Record the dB level on the audio spectrum analyzer as LEV2. Method of Measurement for transmitters.

5.3.3. Test Setup

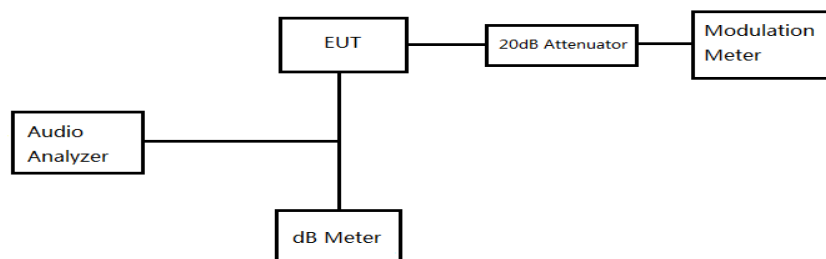

Figure 1

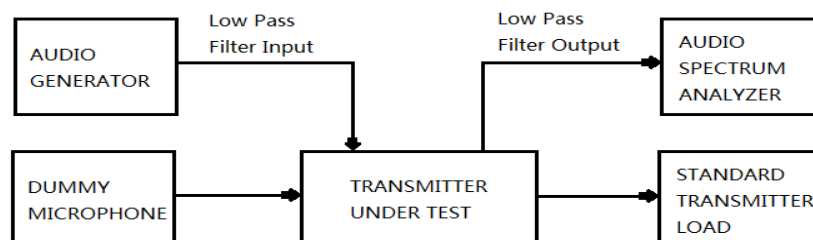
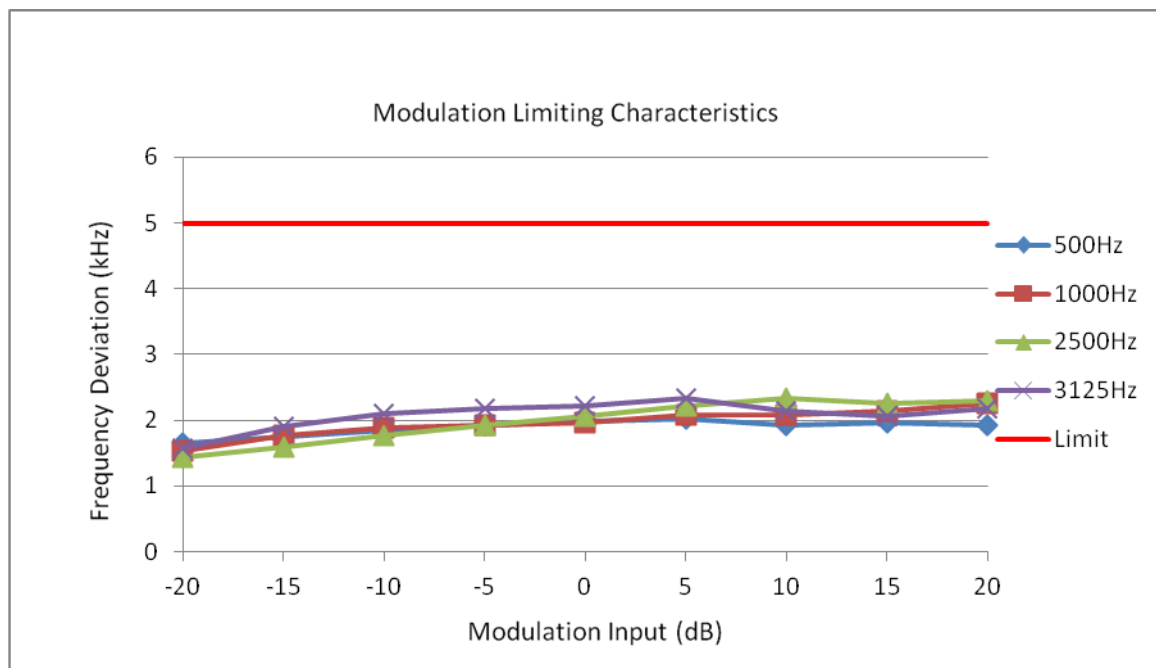

Figure 2

5.3.4. Test Result

Product	Walkie Talkie	Temperature	26°C
Test Engineer	Andy Zhu	Relative Humidity	54%
Test Item	Frequency Deviation	Date of Test	2016/02/17

Channel 22: 462.725MHz GMRS					
Modulation Input (dB)	Peak Frequency Deviation (kHz) at 500Hz	Peak Frequency Deviation (kHz) at 1000Hz	Peak Frequency Deviation (kHz) at 2500Hz	Peak Frequency Deviation (kHz) at 3125Hz	Limit (kHz)
-20.00	1.64	1.53	1.44	1.57	5.00
-15.00	1.74	1.77	1.59	1.91	5.00
-10.00	1.85	1.88	1.77	2.1	5.00
-5.00	1.92	1.93	1.92	2.17	5.00
0.00	1.99	1.97	2.06	2.22	5.00
5.00	2.03	2.08	2.21	2.34	5.00
10.00	1.92	2.07	2.33	2.14	5.00
15.00	1.96	2.14	2.25	2.06	5.00
20.00	1.92	2.25	2.29	2.17	5.00



Product	Walkie Talkie	Temperature	26°C
Test Engineer	Andy Zhu	Relative Humidity	54%
Test Item	Frequency Deviation	Date of Test	2016/02/17

Channel 11: 467.6375MHz FRS					
Modulation Input (dB)	Peak Frequency Deviation (kHz) at 500Hz	Peak Frequency Deviation (kHz) at 1000Hz	Peak Frequency Deviation (kHz) at 2500Hz	Peak Frequency Deviation (kHz) at 3125Hz	Limit (kHz)
-20.00	0.71	0.62	0.33	0.28	2.50
-15.00	0.85	0.75	0.62	0.37	2.50
-10.00	0.92	0.88	0.55	0.61	2.50
-5.00	0.96	0.8	0.71	0.75	2.50
0.00	0.93	0.99	0.88	0.52	2.50
5.00	1.27	1.18	0.77	0.56	2.50
10.00	1.35	1.21	0.82	0.64	2.50
15.00	1.58	1.35	0.99	0.67	2.50
20.00	1.71	1.62	1.14	0.71	2.50

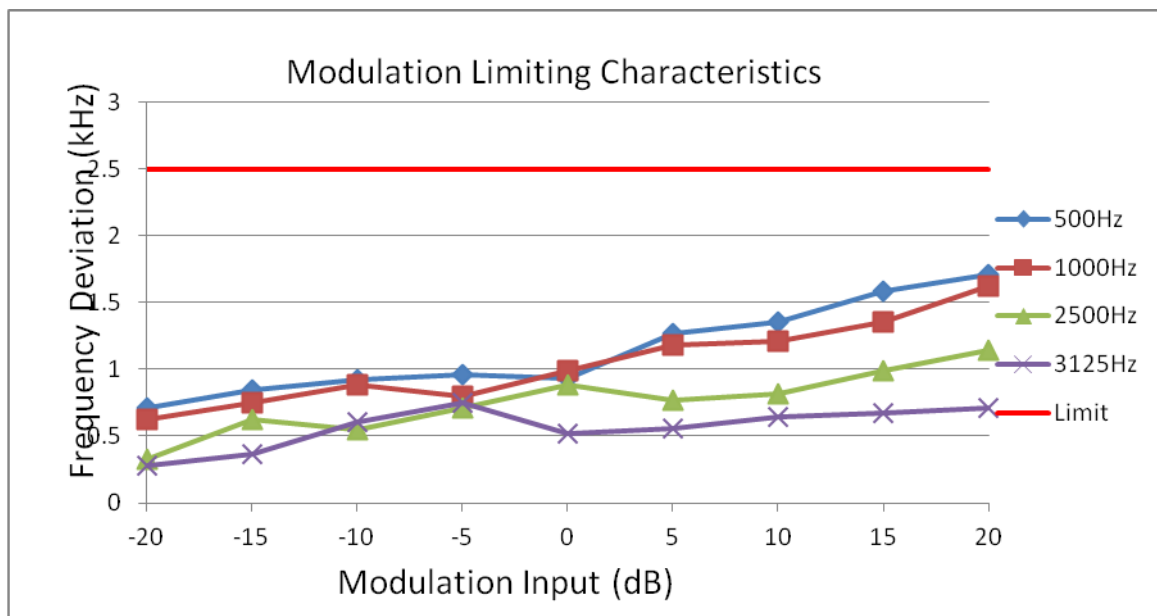

Product	Walkie Talkie	Temperature	26°C
Test Engineer	Andy Zhu	Relative Humidity	54%
Test Item	Audio Low Pass Filter Frequency Response	Date of Test	2016/02/17

Channel 22: 462.725MHz GMRS		
Frequency (kHz)	Response (dB)	Limit (dB)
1	-0.01	0.00
2	-0.01	0.00
3	-5.26	0.00
4	-13.41	-7.50
5	-17.17	-13.31
6	-25.62	-18.06
7	-28.61	-22.08
8	-29.52	-25.56
9	-33.18	-28.63
10	-37.19	-31.37
20	-57.18	-50.00
30	-62.81	-50.00
40	-62.47	-50.00
50	-62.47	-50.00
60	-62.47	-50.00
70	-62.47	-50.00
80	-62.47	-50.00
90	-62.47	-50.00
100	-62.47	-50.00

Audio Low Pass Filter Frequency Response

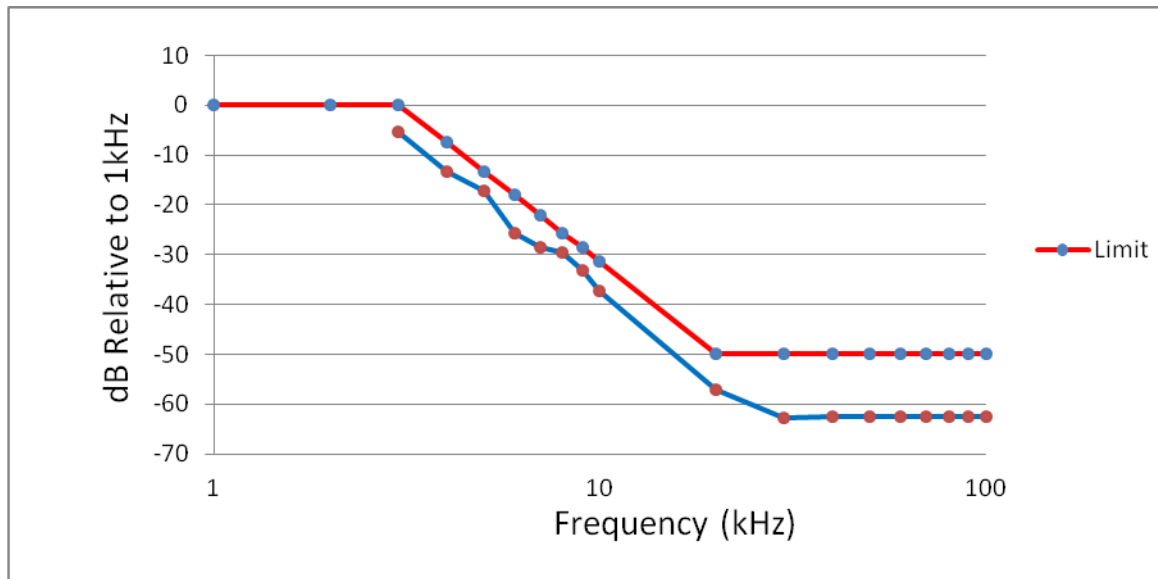

Product	Walkie Talkie	Temperature	26°C
Test Engineer	Andy Zhu	Relative Humidity	54%
Test Item	Audio Frequency Response	Date of Test	2016/02/17

Channel 11: 467.6375MHz FRS		
Modulation Frequency (Hz)	Peak Modulation Deviation (kHz)	Limit (kHz)
100	0.33	3.125
200	0.51	3.125
300	0.77	3.125
400	0.64	3.125
500	0.82	3.125
600	1.18	3.125
700	1.25	3.125
800	1.48	3.125
900	1.64	3.125
1000	1.77	3.125
1250	1.92	3.125
1500	1.99	3.125
1750	2.08	3.125
2000	1.92	3.125
2250	1.74	3.125
2500	1.72	3.125
2750	1.5	3.125
3000	1.44	3.125
3125	1.26	3.125
3250	1.15	3.125
3500	0.97	3.125
4000	1.04	3.125
5000	0.89	3.125

Audio Frequency Response

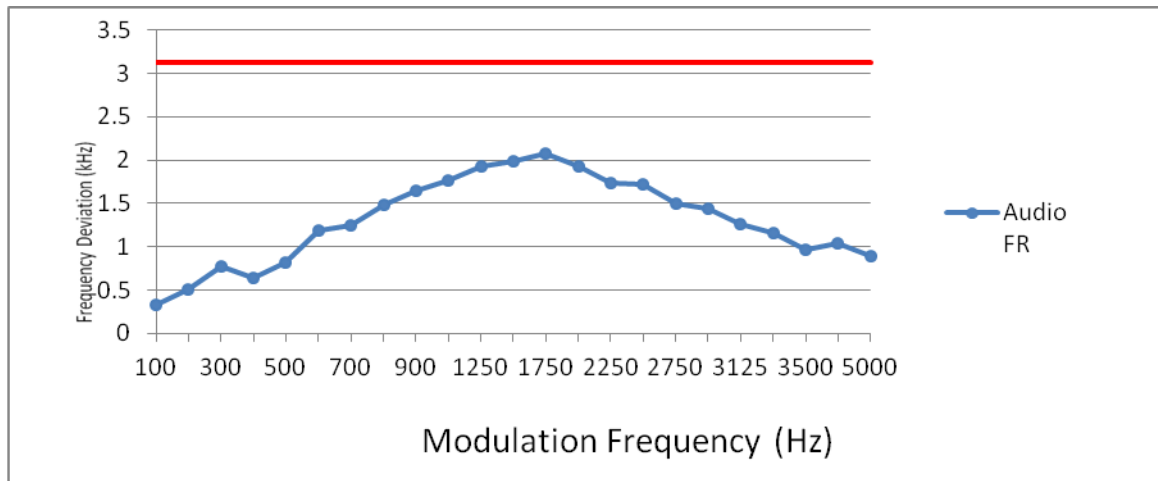

5.4. Occupied Bandwidth And Emission Mask

5.4.1. Provisions Applicable

According to FCC Part §95.633 (a), the authorized bandwidth for emission type F1D, G1D, F3E or G3E is 20 kHz. (c) The authorized bandwidth for emission type F3E or F2D transmitted by a FRS unit is 12.5 kHz.

Per FCC §95.635 (b) (1), at least 25 dB (decibels) on any frequency removed from the center of the authorized bandwidth by more than 50% up to and including 100% of the authorized bandwidth.

Per FCC §95.635 (b) (3), At least 35 dB on any frequency removed from the center of the authorized bandwidth by more than 100% up to and including 250% of the authorized bandwidth.

Per FCC §95.635 (b) (7), At least $43 + 10 \log_{10} (T)$ dB on any frequency removed from the center of the authorized bandwidth by more than 250%.

5.4.2. Test Procedure

The set-up test equipment in the following configuration:

The EUT was modulated by 2.5 KHz Sine wave audio signal. The level of the audio signal employed is 16 dB greater than that necessary to produce 50% of rated system deviation. Rated system deviation is 2.5 KHz (12.5 KHz channel spacing).

Setting the SPA Center Frequency = fundamental frequency, RBW=VBW=300 Hz, Span=20 KHz. Setting SPA to Max hold. Mark peak -20dB.

5.4.3. Test Setup

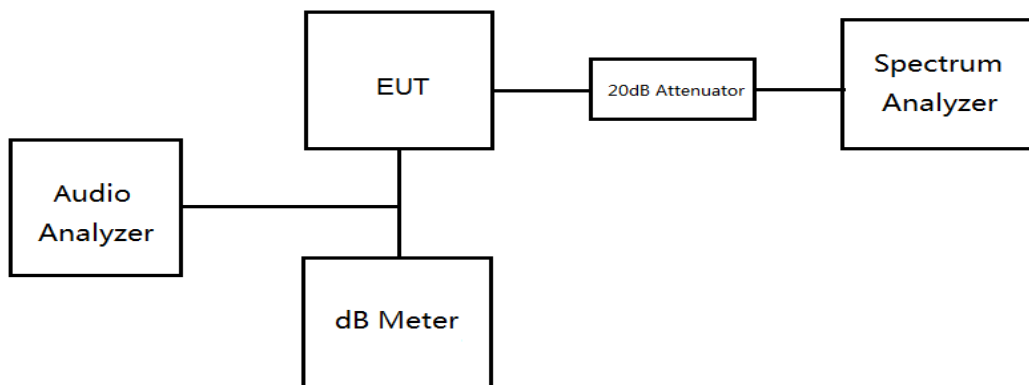

5.4.4. Test Result

Product	Walkie Talkie	Temperature	26°C
Test Engineer	Andy Zhu	Relative Humidity	54%
Test Item	Occupied Bandwidth	Date of Test	2016/02/18

The Occupied Bandwidth is measured to be 7.46kHz for GMRS

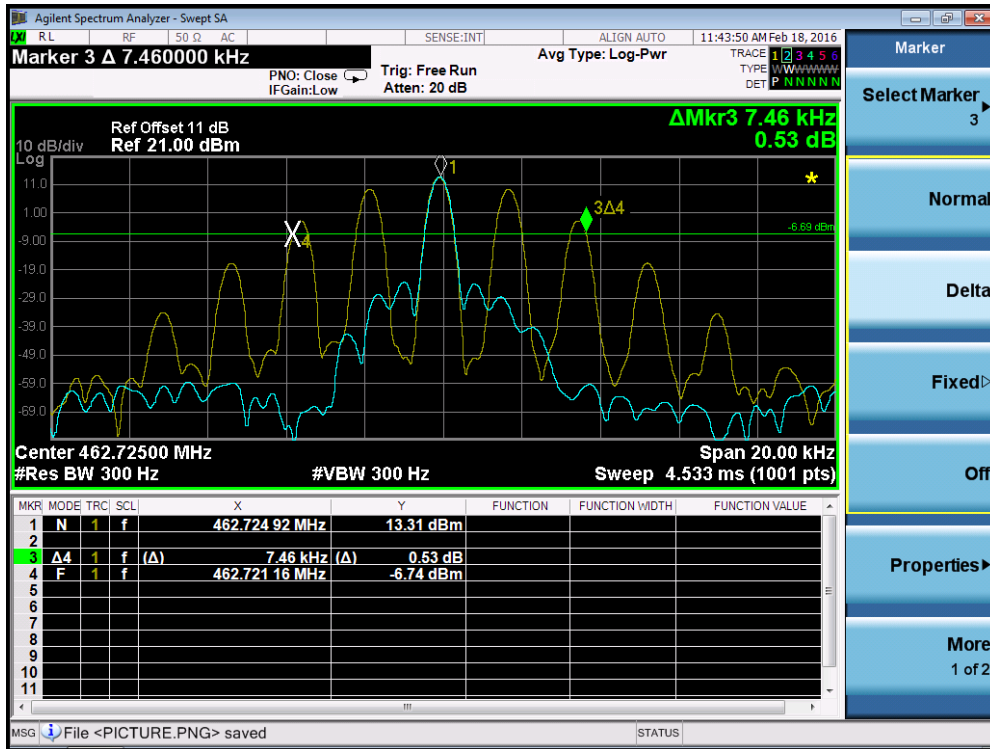

The Occupied Bandwidth is measured to be 8.26kHz for FRS

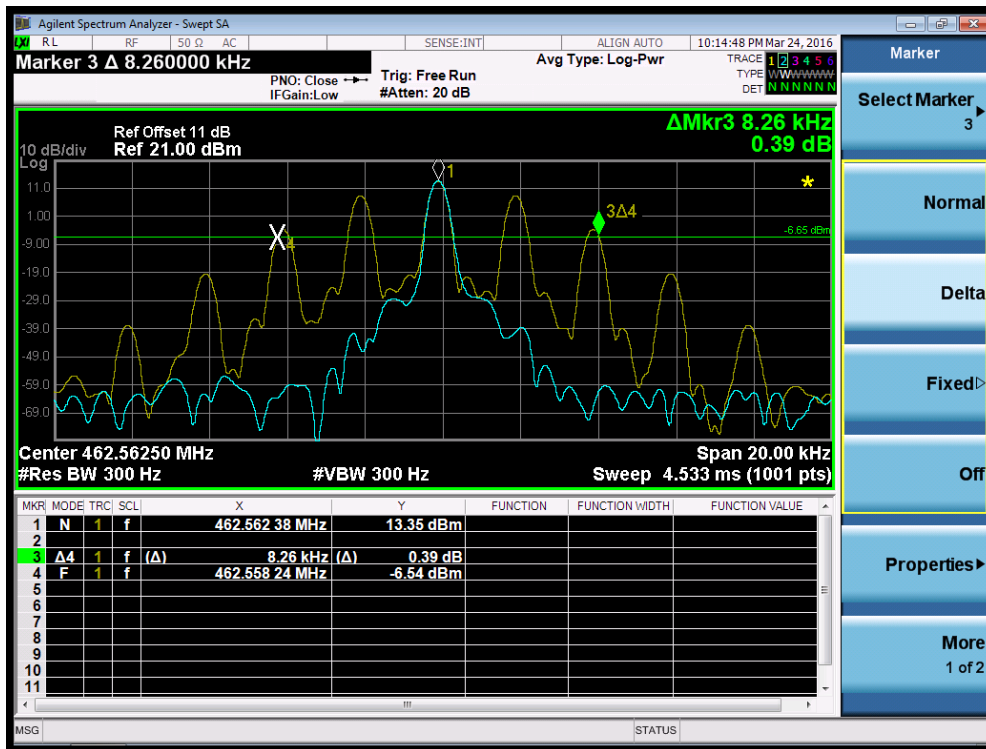

The Occupied Bandwidth is measured to be 8.64kHz for FRS

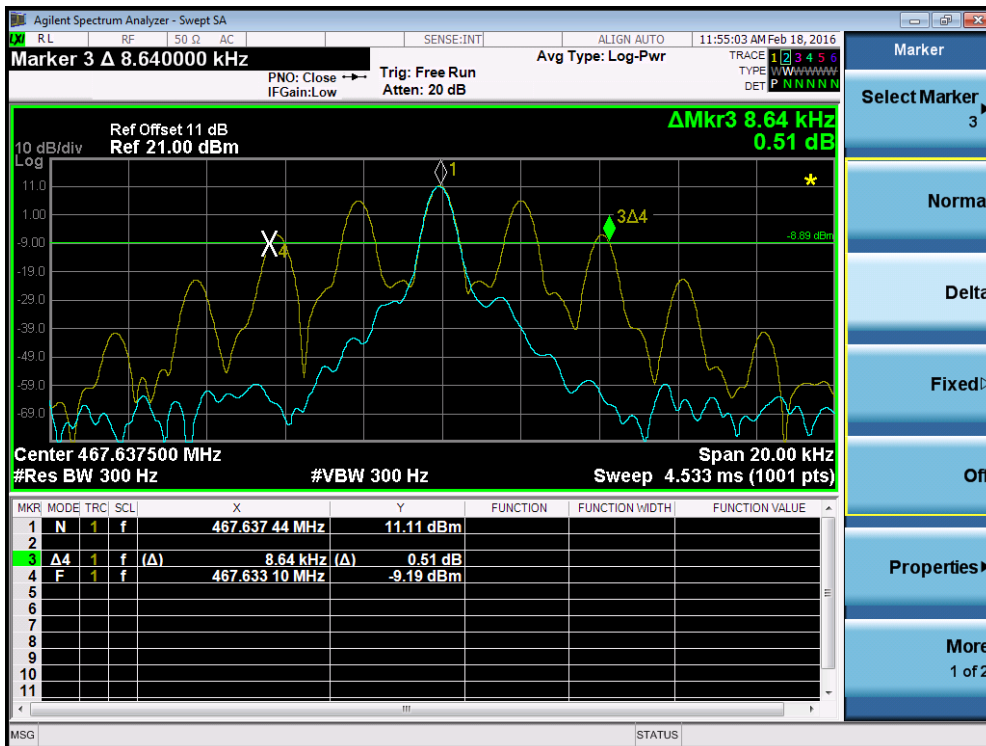

Product	Walkie Talkie	Temperature	26°C
Test Engineer	Andy Zhu	Relative Humidity	54%
Test Item	Mask	Date of Test	2016/02/18

Channel 22: 462.725MHz GMRS

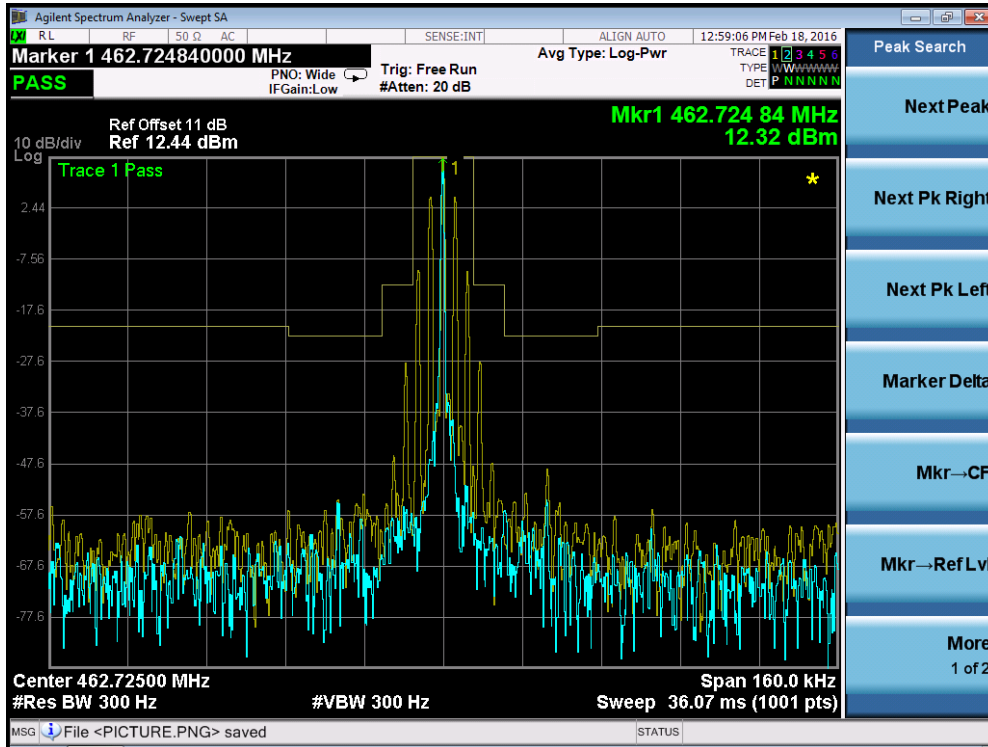

Channel 01: 462.5625MHz FRS

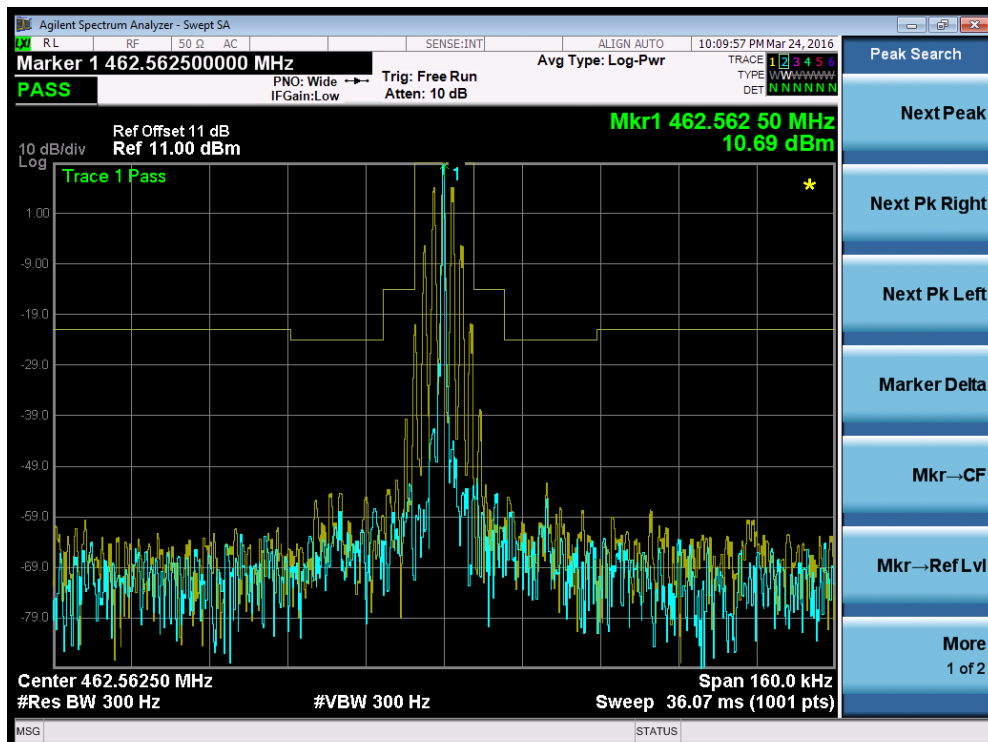

Channel 11: 467.6375MHz FRS

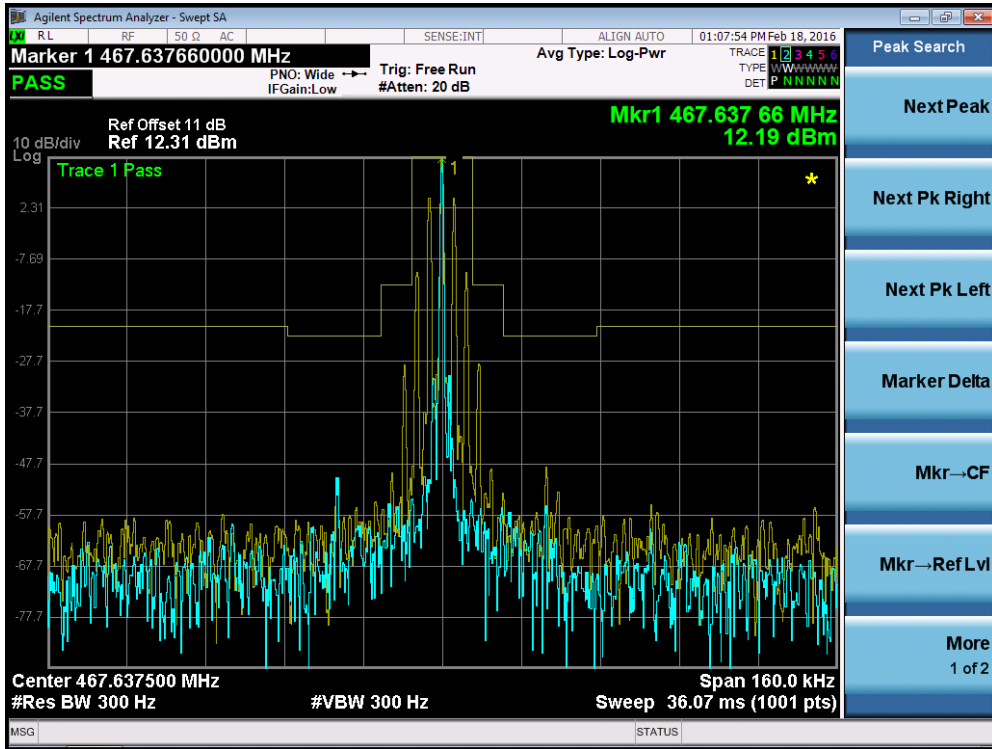

5.5. Unwanted Radiated Spurious Emission

5.5.1. Provisions Applicable

According to FCC section 95.635(b7), the unwanted emission should be attenuated below TP by at least $43+10 \log (\text{Transmit Power})$ dB.

5.5.2. Test Procedure

1. On a test site, the EUT shall be placed on a turntable and in the position closest to the normal use as declared by the user.
2. The test antenna shall be oriented initially for vertical polarization located 3m from the EUT to correspond to the transmitter.
3. The output of the antenna shall be connected to the measuring receiver and either a peak or quasi-peak detector was used for the measurement as indicated on the report. The detector selection is based on how close the emission level was approaching the limit.
4. The transmitter shall be switched on; if possible, without the modulation and the measurement receiver shall be tuned to the frequency of the transmitter under test.
5. The test antenna shall be raised and lowered through the specified range of height until the measuring receiver detects a maximum signal level.
6. The transmitter shall then be rotated through 360° in the horizontal plane, until the maximum signal level is detected by the measuring receiver.
7. The test antenna shall be raised and lowered again through the specified range of height until the measuring receiver detects a maximum signal level.
8. The maximum signal level detected by the measuring receiver shall be noted.
9. The measurement shall be repeated with the test antenna set to horizontal polarization.
10. Replace the antenna with a proper Antenna (substitution antenna).
11. The substitution antenna shall be oriented for vertical polarization and, if necessary, the length of the substitution antenna shall be adjusted to correspond to the frequency of transmitting.
12. The substitution antenna shall be connected to a calibrated signal generator.
13. If necessary, the input attenuator setting of the measuring receiver shall be adjusted in order to increase the sensitivity of the measuring receiver.
14. The test antenna shall be raised and lowered through the specified range of the height to

ensure that the maximum signal is received.

15. The input signal to substitution antenna shall be adjusted to the level that produces a level detected by the measuring receiver, that is equal to the level noted while the transmitter radiated power was measured, corrected for the change of input attenuation setting of the measuring receiver.
16. The input level to the substitution antenna shall be recorded as power level in dBm, corrected for any change of input attenuator setting of the measuring receiver.
17. The measurement shall be repeated with the test antenna and the substitution antenna oriented for horizontal polarization.

5.5.3. Test Setup

30MHz ~ 1GHz Test Setup:

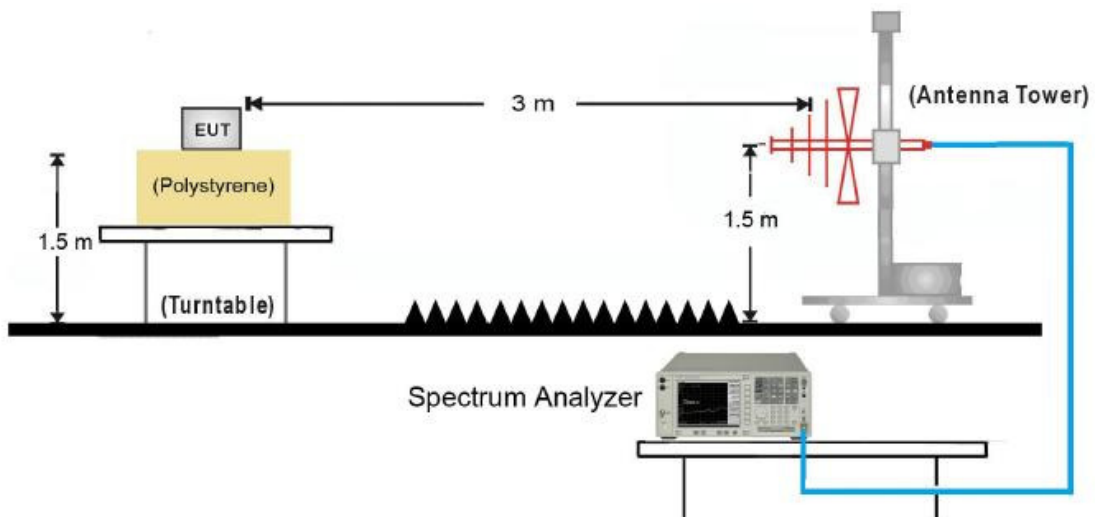

Above 1GHz Test Setup:

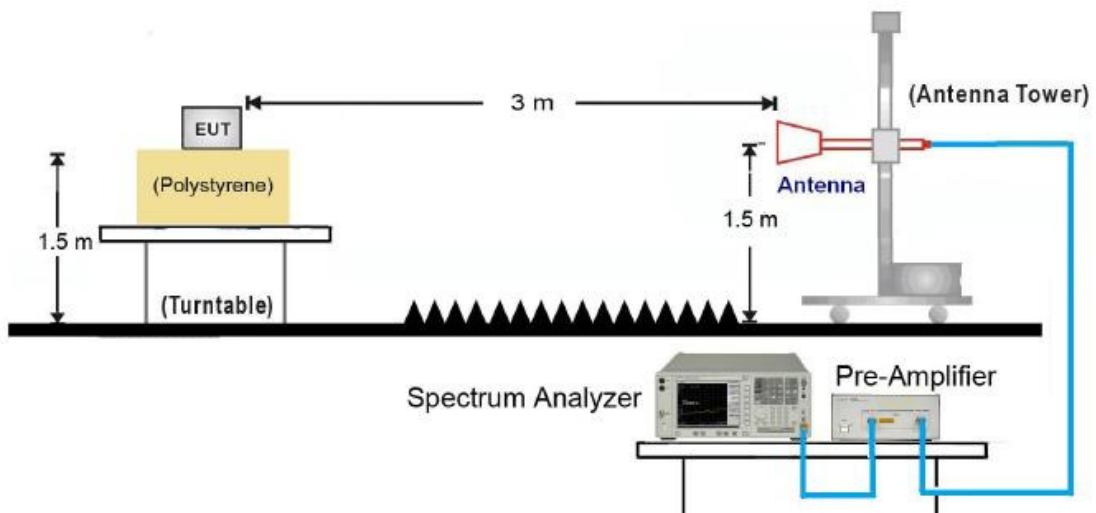

5.5.4. Test Result.

Product	Walkie Talkie	Temperature	26°C
Test Engineer	Andy Zhu	Relative Humidity	54%
Test Mode	Channel 11	Test Site	AC1

Frequency (MHz)	Polarity (V/H)	Emission level (dBm)	FCC Part 95 Limit (dBm)	Over Limit (dBm)
935.5	V	-33.7	-13	-20.7
1403.5	V	-36.1	-13	-23.1
1870.0	V	-40.7	-13	-27.7
2338.0	V	-46.9	-13	-33.9
3740.5	V	-38.7	-13	-25.7
935.5	H	-37.6	-13	-24.6
1403.5	H	-43.0	-13	-30.0
1870.0	H	-43.9	-13	-30.9
2338.0	H	-52.5	-13	-39.5
3740.5	H	-45.8	-13	-32.8

Product	Walkie Talkie	Temperature	26°C
Test Engineer	Andy Zhu	Relative Humidity	54%
Test Mode	Channel 22	Test Site	AC1

Frequency (MHz)	Polarity (V/H)	Emission level (dBm)	FCC Part 95 Limit (dBm)	Over Limit (dBm)
925.5	V	-33.5	-13	-20.5
1388.0	V	-29.9	-13	-16.9
1850.9	V	-38.2	-13	-25.2
2776.5	V	-36.3	-13	-23.3
3701.8	V	-37.4	-13	-24.4
925.5	H	-35.9	-13	-22.9
1388.0	H	-36.5	-13	-23.5
1850.9	H	-37.7	-13	-24.7
2776.5	H	-34.8	-13	-21.8
3701.8	H	-38.8	-13	-25.8

5.6. Frequency Stability

5.6.1. Provisions Applicable

According to FCC Section 95.626, the frequency stability shall be measured with variation of ambient temperature from -30°C to +50°C centigrade. Each FRS unit must be maintained within a frequency tolerance of 0.00025%.

According to FCC Section 95.621, the frequency stability shall be measured with variation of ambient temperature from -30°C to +50°C centigrade each GMRS transmitter for mobile station, small base station and control station operation must be maintained within a frequency tolerance of 0.0005%.

5.6.2. Test Procedure

5.6.2.1. Frequency stability versus environmental temperature

1. Setup the configuration per figure 1 for frequencies measurement inside an environment chamber. Install new battery in the EUT.
2. Turn on EUT and set SA center frequency to the EUT radiated frequency. Set SA Resolution Bandwidth to 1 KHz and Video Resolution Bandwidth to 1 KHz and Frequency Span to 50KHz. Record this frequency as reference frequency.
3. Set the temperature of chamber to 50°C. Allow sufficient time (approximately 30 min) for the temperature of the chamber to stabilize. While maintaining a constant temperature inside the chamber, turn the EUT on and measure the EUT operating frequency.
4. Repeat step 2 with a 10°C decreased per stage until the lowest temperature -30°C is measured, Record all measured frequencies on each temperature step.

5.6.2.2. Frequency stability versus input voltage

1. Setup the configuration per figure 1 for frequencies measured at temperature if it is within 15°C to 25°C. Otherwise, an environment chamber set for a temperature of 20°C shall be used. The EUT shall be powered by DC 3.6 V.
2. Set SA center frequency to the EUT radiated frequency. Set SA Resolution Bandwidth to 1 KHz and Video Resolution Bandwidth to 1KHz. Record this frequency as reference frequency.
3. Supply the EUT primary voltage at the operating end point which is specified by manufacturer and record the frequency.

5.6.3. Test Setup

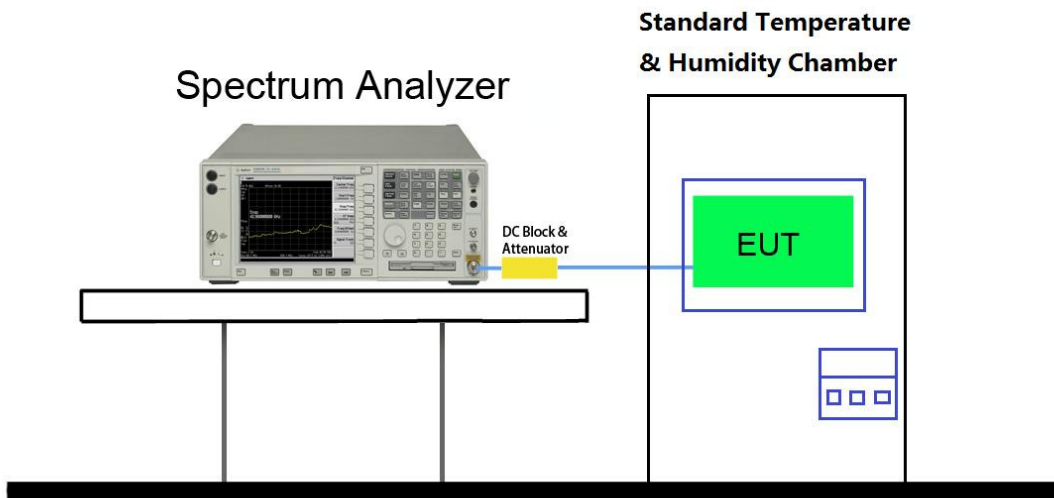

5.6.4. Test Result

Assigned Frequency (MHz)	Test Voltage (V)	Test Temperature (°C)	Measured Frequency (MHz)	Frequency Deviation (%)	Limit (%)
FRS Channel 1 462.5625	3.6	-30	462.5628298	0.0000713	0.00025
	3.6	-20	462.5629052	0.0000876	0.00025
	3.6	-10	462.5620215	-0.0001034	0.00025
	3.6	0	462.5620514	-0.0000970	0.00025
	3.6	10	462.5627481	0.0000536	0.00025
	3.6	20	462.5619974	-0.0001087	0.00025
	3.6	30	462.5620153	-0.0001048	0.00025
	3.6	40	462.5629858	0.0001050	0.00025
	3.6	50	462.5625487	0.0000105	0.00025
FRS Channel 11 467.6375	3.6	-30	467.6371784	-0.0000688	0.00025
	3.6	-20	467.6372904	-0.0000448	0.00025
	3.6	-10	467.6370554	-0.0000951	0.00025
	3.6	0	467.6370847	-0.0000888	0.00025
	3.6	10	467.6380637	0.0001205	0.00025
	3.6	20	467.6379284	0.0000916	0.00025
	3.6	30	467.6380257	0.0001124	0.00025
	3.6	40	467.6380035	0.0001077	0.00025
	3.6	50	467.6380471	0.0001170	0.00025
GMRS Channel 22 462.725	3.6	-30	462.7252623	0.0000567	0.0005
	3.6	-20	462.7250415	0.0000090	0.0005
	3.6	-10	462.7250515	0.0000111	0.0005
	3.6	0	462.7259525	0.0002058	0.0005
	3.6	10	462.7252541	0.0000549	0.0005
	3.6	20	462.7250528	0.0000114	0.0005
	3.6	30	462.7251859	0.0000402	0.0005
	3.6	40	462.7250526	0.0000114	0.0005
	3.6	50	462.7250365	0.0000079	0.0005

Note: Frequency Deviation= (Measured Frequency–Declared Frequency)/ Declared Frequency*100.

Assigned Frequency (MHz)	Test Temperature (°C)	Test Voltage (V)	Measured Frequency (MHz)	Frequency Deviation (%)	Limit (%)
FRS Channel 1 462.5625	25	3.3	462.5628471	0.0000750	0.00025
	25	3.6	462.5623680	-0.0000285	0.00025
	25	4.5	462.5629153	0.0000898	0.00025
FRS Channel 11 467.6375	25	3.3	467.6370158	-0.0001035	0.00025
	25	3.6	467.6369225	-0.0001235	0.00025
	25	4.5	467.6370518	-0.0000958	0.00025
GMRS Channel 22 462.725	25	3.3	462.7259026	0.0001951	0.0005
	25	3.6	462.7258251	0.0001783	0.0005
	25	4.5	462.7253510	0.0000759	0.0005

Note: Frequency Deviation= (Measured Frequency–Declared Frequency)/ Declared Frequency*100.

6. CONCLUSION

The data collected relate only the item(s) tested and show that the **Walkie Talkie FCC ID: 2AHJLR8** is in compliance with Part 95 of the FCC Rules.

_____ The End _____