



DOBOT

User Guide

Dobot Magician

User Guide

Issue: V1.6.1

Date: 2018-06-12

Shenzhen Yuejiang Technology Co., Ltd

Copyright © ShenZhen Yuejiang Technology Co., Ltd 2018. All rights reserved.

No part of this document may be reproduced or transmitted in any form or by any means without prior written consent of Yuejiang Technology Co., Ltd

Disclaimer

To the maximum extent permitted by applicable law, the products described (including its hardware, software and firmware, etc.) in this document are provided **AS IS**, which may have flaws, errors or faults. Yuejiang makes no warranties of any kind, express or implied, including but not limited to, merchantability, satisfaction of quality, fitness for a particular purpose and non-infringement of third party rights. In no event will Yuejiang be liable for any special, incidental, consequential or indirect damages resulting from the use of our products and documents.

Before using our product, please thoroughly read and understand the contents of this document and related technical documents that are published online, to ensure that the robotic arm is used on the premise of fully understanding the robotic arm and related knowledge. Please use this document with technical guidance from professionals. Even if follow this document or any other related instructions, Damages or losses will be happen in the using process, Dobot shall not be considered as a guarantee regarding to all security information contained in this document.

The user has the responsibility to make sure following the relevant practical laws and regulations of the country, in order that there is no significant danger in the use of the robotic arm.

Shenzhen Yuejiang Technology Co., Ltd

Address: 4F, A8, Tanglang Industrial Area, Taoyuan Street, Nanshan District, Shenzhen, PRC

Website: www.dobot.cc

Preface

Purpose

This Document describes the functions, technical specifications, installation guide and system commissioning of Dobot Magician, making it easy for users to fully understand and use it.

Intended Audience

This document is intended for:



- Customer Engineer
- Sales Engineer
- Installation and Commissioning Engineer
- Technical Support Engineer

Change History

Date	Change Description
2018/09/11	Updated the connection figure between Dobot Magician and sliding rail
2018/06/12	The first release

Symbol Conventions

The symbols that may be founded in this document are defined as follows.

Symbol	Description
 DANGER	Indicates a hazard with a high level of risk which, if not avoided, could result in death or serious injury
WARNING	Indicates a hazard with a medium level or low level of risk which, if not avoided, could result in minor or moderate injury, robotic arm damage
NOTICE	Indicates a potentially hazardous situation which, if not avoided, can result in robotic arm damage, data loss, or unanticipated result
 NOTE	Provides additional information to emphasize or supplement important points in the main text

Contents

1. Security Precautions	1
1.1 General Security	1
1.2 Precautions.....	2
2. Quick Start	4
2.1 Connecting Cables to the Dobot Magician.....	4
2.2 Installing the DobotStudio.....	5
2.2.1 System Requirements.....	5
2.2.2 Obtaining the DobotStudio Package.....	6
2.2.3 Installing the DobotStudio	6
2.2.4 Verifying the Installation.....	8
2.3 Powering On/Off the Dobot Magician	10
2.4 Getting Started	10
3. Introduction.....	18
3.1 Overview.....	18
3.2 Appearance and Constitute.....	18
3.3 Working Principle	18
3.3.1 Workspace	18
3.3.2 Coordinate System	20
3.3.3 Motion Function.....	21
3.4 Technical Specifications	23
3.4.1 Technical Parameters	23
3.4.2 Sizes	24
4. Interface Description	26
4.1 Interface Board	26
4.2 LED Indicator	28
4.3 Multiplexed I/O Interface Description	28
4.3.1 Multiplexed Base I/O Interface Description.....	28
4.3.2 Multiplexed Forearm I/O Interface Description	30
5. Operation	31
5.1 Introduction to the DobotStudio	31
5.1.1 Function Modules	31
5.1.2 Common Areas of DobotStudio Page.....	33
5.2 Performing Teaching & Playback Tasks.....	35
5.2.1 Installing a Suction Cup Kit.....	35
5.2.2 Installing a Gripper Kit	38
5.2.3 Teaching & Playback Page	40
5.2.4 ARC Motion Mode	43
5.2.5 Teaching & Playback Example	46
5.3 Working in Offline Mode	52
5.4 Writing and Drawing	54
5.4.1 Installing a Writing and drawing kit	54
5.4.2 Connecting the DobotStudio.....	55

5.4.3	Importing Image Files and Setting Writing Parameters	57
5.4.4	Adjust the Position of the Pen Nib.....	63
5.5	Performing Laser Engraving Tasks	65
5.5.1	Installing a Laser Kit.....	66
5.5.2	Connecting the DobotStudio.....	68
5.5.3	Importing Image Files and Setting Engraving Parameters.....	70
5.5.4	Adjust the Laser Focus and Start to Grave	76
5.6	Engraving a Grayscale Image.....	81
5.6.1	Installing a Grayscale-engraving Kit	82
5.6.2	Connecting the DobotStudio.....	82
5.6.3	Importing Image Files and Setting Engraving Parameters.....	84
5.6.4	Adjust the Laser Focus and Start to Engrave.....	87
5.7	Controlling with your Hand Gesture	92
5.7.1	Installing a Leap Motion Controller	92
5.7.2	Leap Motion Demo	93
5.8	Controlling with your Mouse	96
5.9	Operating 3D Printing	100
5.9.1	Installing 3D Printing Kit.....	101
5.9.2	Operating Repetier Host.....	106
5.9.3	Operating Cura	121
5.10	Calibration	127
5.10.1	Base Calibration.....	127
5.10.2	Sensor Calibration.....	130
5.10.3	Homing.....	140
5.11	Connecting with WIFI Kit.....	141
5.12	Connecting with Bluetooth Kit.....	144
5.13	Operating Blockly.....	146
5.14	Scripting.....	148
5.15	Operating Stick Controller Kit	149
5.16	Operating Sliding Rail.....	错误!未定义书签。
5.16.1	Installing sliding rail	错误!未定义书签。
5.16.2	Sliding Rail Parameter Description	错误!未定义书签。
5.16.3	Demo Description	错误!未定义书签。
5.17	Multiplexed I/O Demo.....	152
5.17.1	Level Output.....	153
5.17.2	Level Input	155
5.17.3	PWM OUTPUT	157

1. Security Precautions

This topic describes the security precautions that should be noticed when using this product. Please read this document carefully before using the robotic arm for the first time. This product need to be carried out in an environment meeting design specifications, you cannot remold the product without authorization, otherwise it could lead to product failure, and even personal injury, electric shock, fire, etc. The installation personnel, operators, teaching personnel, and programmers of the robotic arm must read this document carefully and use the robotic arm strictly according to the regulations of this document strictly.

1.1 General Security



Robotic arm is an electrical equipment. Non-professional technicians cannot modify the wire, otherwise it is vulnerable to injury the device or the person.

The following security rules should be followed when using the robotic arm.

- You should comply with local laws and regulations when operating the robotic arm. The security precautions in this document are only supplemental to local laws and regulations.
- The **DANGER**, **WARNING**, and **NOTICE** marks in this document are only supplemental to the security precautions.
- Please use the robotic arm in the specified environment scope. If not, exceeding the specifications and load conditions will shorten the service life of the product even damage the equipment.
- Before operating and maintaining the robotic arm, the personnel responsible for the installation, operation and maintenance must be trained to understand the various security precautions and to master the correct methods of operation and maintenance.
- Highly corrosive cleaning is not suited to cleaning the robotic arm. The anodized components are not suitable for immersion cleaning.
- People cannot repair and disassemble the robotic arm without professional training. If there is a problem with the robotic arm, please contact Dobot technical support engineer in time.
- Please comply with the relevant laws to deal with the product which is scrapped, and protect the environment.
- There are small parts in the packing box, Please keep them away from children, to avoid any accidents.
- DO NOT let children play with the robotic arm alone. All processes need to be monitored while running. After processes have finished, please turn off the equipment promptly.
- DO NOT put hands into the workspace of the robotic arm while running, to avoid

bruising or pinching.

- Be careful during the robotic arm carrying or installing. Please follow the instructions on the packing box to put down the robotic arm gently and place it correctly in direction of arrow.
- Commissioning of the incomplete machine is prohibited until it has been installed in a machine and the whole machine complies with the provisions of the Machinery Directive (2006/42/EC).
- It is prohibited to modify or remove the nameplates, instructions, icons and marks on the robotic arm and the related equipment.
- Please refer to Dobot Magician User Guide along with the packing box before using.

1.2 Precautions

- Please make the Dobot Magician in the workspace with a 45° angle between the Forearm and Rear Arm (as shown in Figure 1.1) before starting up. If the LED indicator turns red after starting up, it indicates that the Dobot Magician is at a limited position. Please make the Dobot Magician in the workspace.

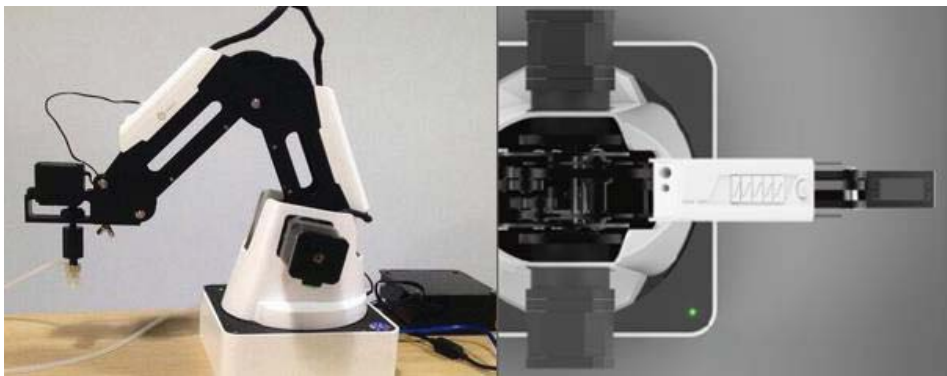

Figure 1.1 The Forearm and Rear Arm position

- Dobot Magician will move slowly to the specific position when shutdown. DO NOT put hands into the workspace of the Dobot while running, to avoid bruising or pinching. Only once the LED indicator completely turns off, the Dobot Magician can be powered down.
- If the coordinates of the Dobot Magician shown on the DobotStudio are abnormal, please press the **Reset** button on the back of the base to reset Dobot Magician or click **Home** on the DobotStudio page to perform homing.
- During resetting, Dobot Magician will disconnect from the PC automatically and the LED indicator on the base turns yellow. About 5 seconds later, if the LED indicator turns green, it indicates that the reset is successful.
- During homing, Dobot Magician will rotate clockwise to the limited position and then return to the homing point automatically, and the LED indicator on the base turns blue and is blinking. After homing, if there is a beep sound and the LED

indicator turns green, it indicates that the homing is successful.

- Please turn off the Dobot Magician completely first before connecting or disconnecting external equipment, such as Bluetooth, WIFI, stick controller, infrared sensor, color sensor, etc. Or, it causes damage to your device.
- Please wear the lasing protective eyeglass when using the laser module. Please protect your eyes and skin from the laser.
- The heating rod will produce high temperature up to 250°C when using the 3D printing module, please be careful.
- Please DO NOT operate or turn off Dobot Magician when burning firmware, to avoid machine damage.

2. Quick Start

This topic briefly describes how to operate the Dobot Magician with the software DobotStudio, allowing you to quickly know and use the robotic arm. Figure 2.1 shows the process of getting started with the Dobot Magician.

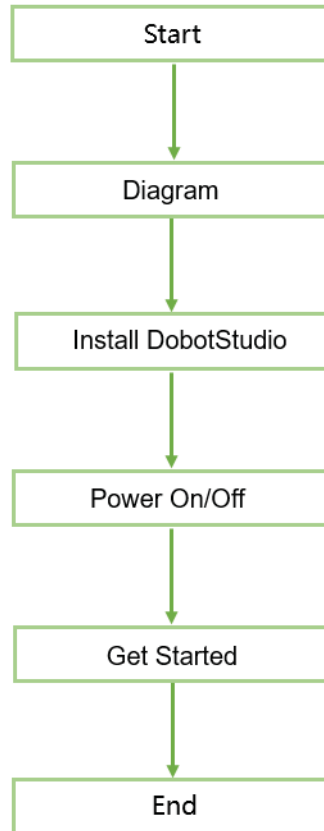

Figure 2.1 The process of getting started with the Dobot Magician

2.1 Connecting Cables to the Dobot Magician

Step 1 Connect the Dobot Magician to your computer with the supplied USB cable, as shown in Figure 2.2.



Figure 2.2 Connect the Dobot Magician to your computer

Step 2 Connect the Dobot Magician to the electrical outlet with the supplied power adapter, as shown in Figure 2.3.



Figure 2.3 Connect the Dobot Magician to the electrical outlet

2.2 Installing the DobotStudio

With the DobotStudio, you can control Dobot Magician to implement functions such as Teaching & Playback, fully programmable applications, and 3D printing. This topic introduces Teaching & Playback.

2.2.1 System Requirements

The DobotStudio supports the following Windows and macOS versions.

- Windows 7, Windows 8, and Windows 10 (This manual is explained based on this version)

- macOS 10.10, macOS 10.11, and macOS 10.12

2.2.2 Obtaining the DobotStudio Package

Before using Dobot Magician, download the Windows DobotStudio package from <https://www.dobot.cc/downloadcenter.html>. The macOS version is also downloadable in this URL.

2.2.3 Installing the DobotStudio

Prerequisites

The DobotStudio package has been obtained.

Procedure

Step 1 Unpack the DobotStudio package to a destination directory.

For example, this directory is *Installation Directory*\DobotStudio. You can install the DobotStudio to another location based on site requirements.

Step 2 In the installation directory double-click **DobotStudioSetup.exe**. The **Select Setup Language** dialog box is displayed, as shown in Figure 2.4.

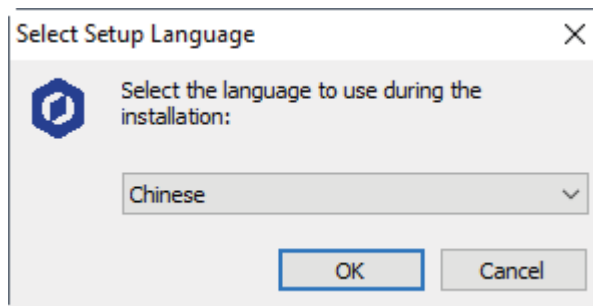

Figure 2.4 The Select Setup Language dialog box

Step 3 Choose a setup language such as **English**, as shown in Figure 2.5. You can also select **Chinese** if needed.

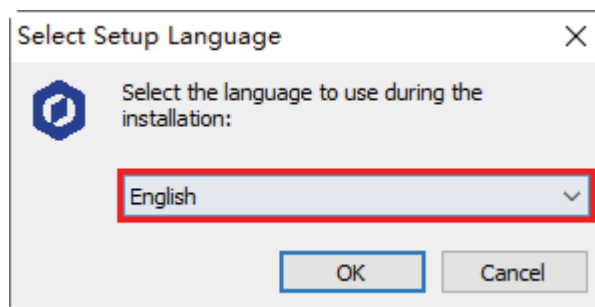

Figure 2.5 Select English

Step 4 Click **OK** to follow the on-screen instructions to continue with the installation.

During the installation, the **Device Driver Installation Wizard** dialog box is displayed, as shown in Figure 2.6.

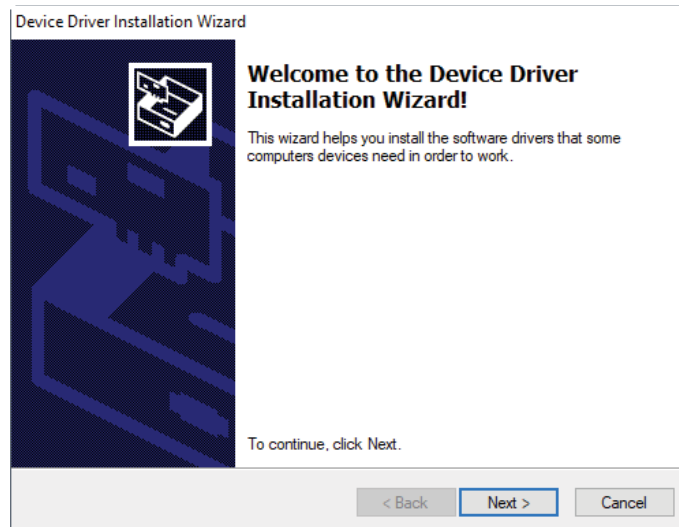

Figure 2.6 The Device Driver Installation Wizard dialog box

Step 5 Click **Next** to install the Dobot Magician driver.

When the driver is installed successfully, the **Completing the Device Driver Installation Wizard** dialog box is displayed, as shown in Figure 2.7.

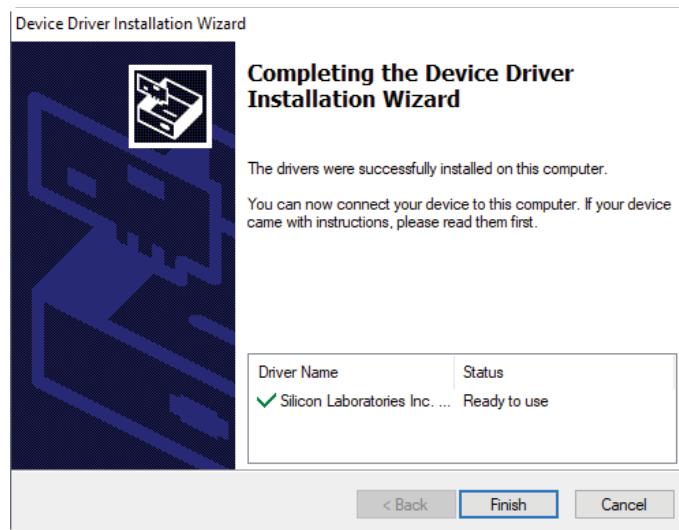

Figure 2.7 The Completing the Device Driver Installation Wizard dialog box

Step 6 Click **Finish**.

Step 7 Click **Next** to continue to install the DobotStudio by following the prompts on the **Setup – DobotStudio** dialog box.

When the installation is complete, the **Completing the DobotStudio Setup Wizard** dialog box is displayed, as shown in Figure 2.8.

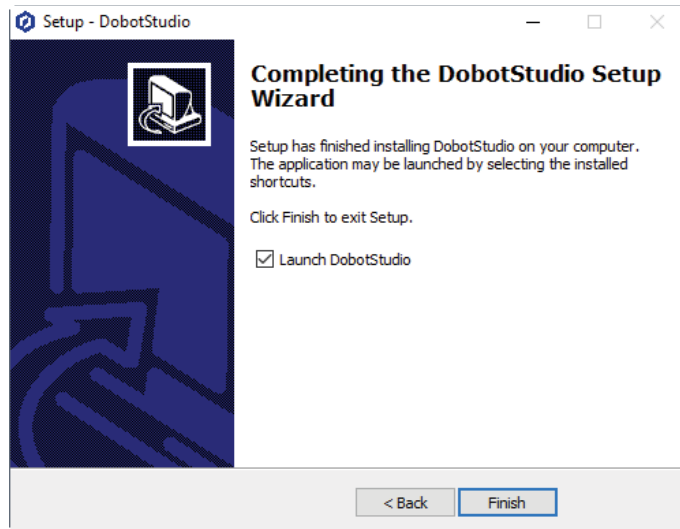

Figure 2.8 The Completing the DobotStudio Setup Wizard dialog box

Step 3 Click Finish.

2.2.4 Verifying the Installation

2.2.4.1 Verifying the DobotStudio

If the DobotStudio is launched and runs properly by double-clicking the desktop shortcut to this program, it means that it is installed successfully.

2.2.4.2 Verifying the Dobot Magician Driver

If an available COM port is displayed on the upper left corner of the DobotStudio page after the robotic arm is powered on, as shown in Figure 2.9, the Dobot Magician driver is installed successfully.



Figure 2.9 An available COM port is displayed

If no COM port is available, check whether the robotic arm driver is successfully installed by following the steps below.

Step 1 Connect the Dobot Magician to your computer with the supplied USB cable.

Step 2 Press the power button to apply power.

Step 3 Launch the **Device Manager** window to locate the **Ports (COM & LPT)** section. If the item **Silicon Labs CP210x USB to UART Bridge (COM6)** is displayed, it means the Dobot Magician driver is installed successfully.

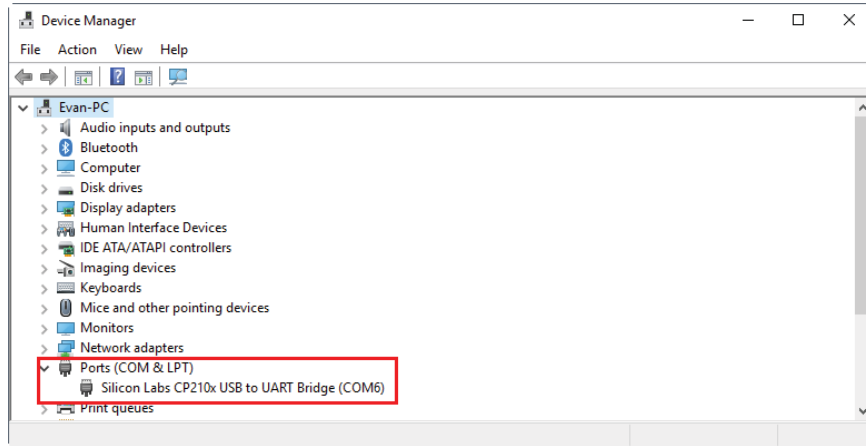

Figure 2.10 The robotic arm driver in Device Manager window

NOTE

- To reinstall the Dobot Magician driver after uninstalling it, install the driver corresponding to the Windows version in the directory **Installation Directory\DobotStudio\attachment\Drive\HardwareV1.0.0**. For example, install the 64-bit driver on a 64-bit Windows 10, as shown in Figure 2.11.

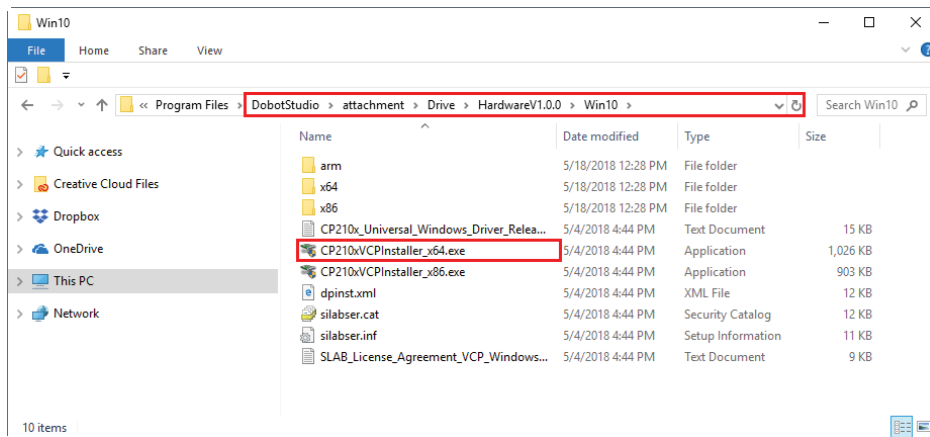



Figure 2.11 Install the 64-bit driver on a 64-bit Windows 10

- If the DobotStudio hardware version is 0.0.0, install the driver matching the Windows version in the directory **Installation Directory\DobotStudio\attachment\Drive\HardwareV0.0.0**. Please connect the DobotStudio to the robotic arm and then click to check the hardware version.

2.3 Powering On/Off the Dobot Magician

- Power on:** align the Dobot Magician into its neutral position with its Forearm and Rear Arm constructing a 45-degree angle, and press down the power button in the base, as shown in Figure 2.12. Once the robotic arm is powered on, the LED indicator turns yellow, and all the stepper motors lock. And then wait about seven seconds, a short beep sound will be heard, and the LED indicator turns from yellow to green. Now the Dobot Magician is ready to use.

NOTICE

If the LED indicator is red after powering on the Dobot Magician, it means that the robotic arm reaches its limited position. To go back to the workspace, press and hold the unlock button  on the Forearm to move the robotic arm to another desired position. After releasing the button the LED indicator turns green.

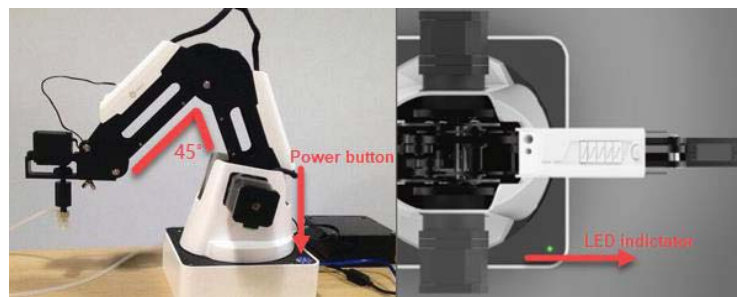

Figure 2.12 The gesture of Dobot Magician before power-on

- Power off:** When the LED indicator is green, press down the power button to turn off the robotic arm. In this case, the Forearm moves slowly to the Rear Arm while the angle between them becomes small. Finally, the two arms reach a specific position.

WARNING

During the shutdown process, watch your hand.

2.4 Getting Started

This topic describes how to use the Dobot Magician to complete the teaching & playback function by saving three points in the MOVJ mode, allowing you to get the basic knowledge of the usage of the robotic arm.

Prerequisites

- The DobotStudio has been installed. For details, see *2.2 Installing the DobotStudio*.
- The Dobot Magician is powered on. For details, see *2.3 Powering On/Off the Dobot Magician*.

Procedure

Step 1 Double-click the desktop shortcut to the DobotStudio.

The DobotStudio page with its beginner guide is displayed, as shown in Figure 2.13.

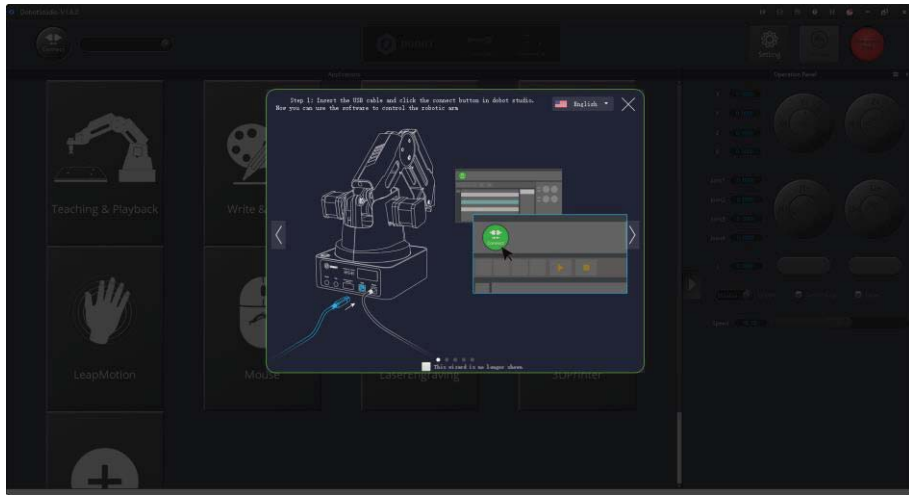

Figure 2.13 The DobotStudio page with a beginner guide

NOTE

After reading the beginner guide of the DobotStudio, click to close it.

Step 2 Click **Connect** on the DobotStudio page, as shown in Figure 2.14.

The **Question** dialog box is displayed, as shown in Figure 2.15.



Figure 2.14 Click Connect

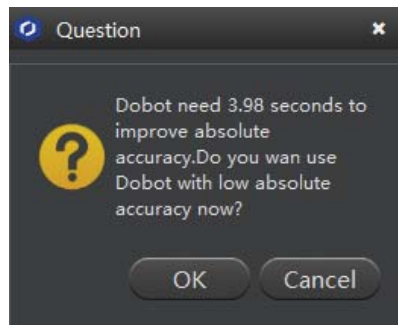

Figure 2.15 The Question dialog box

Step 3 Click **OK**.

Because this section is for quick access to the Dobot Magician only and no high accuracy is required.

When **Connect** changes to **Disconnect**, it means that the DobotStudio is connected the Dobot Magician, as shown in Figure 2.16.

NOTE

To achieve a high accuracy of the robotic arm, click **Cancel**, and wait 7.53 seconds, and then click **Connect** again. The time duration is for reference only. For the exact time, see the message from the **Question** dialog box.

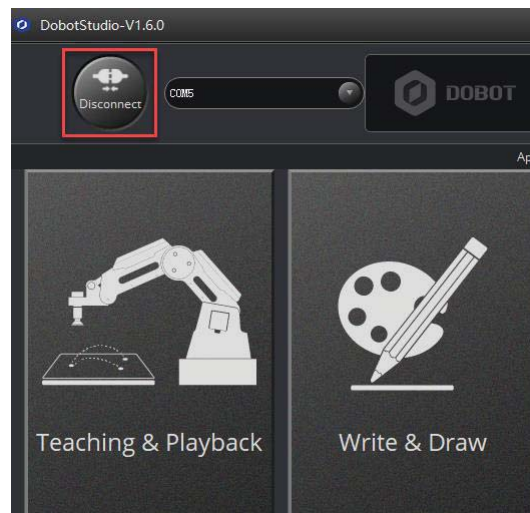

Figure 2.16 The DobotStudio is connected to the Dobot Magician

Step 4 Use DobotStudio to accomplish a teaching & playback task.

1. Click **Teaching & Playback**, as shown in Figure 2.17.



Figure 2.17 Click Teaching & Playback

NOTE

After reading a beginner guide on the **Teaching & Playback** page, as shown in Figure 2.18, click to close it.

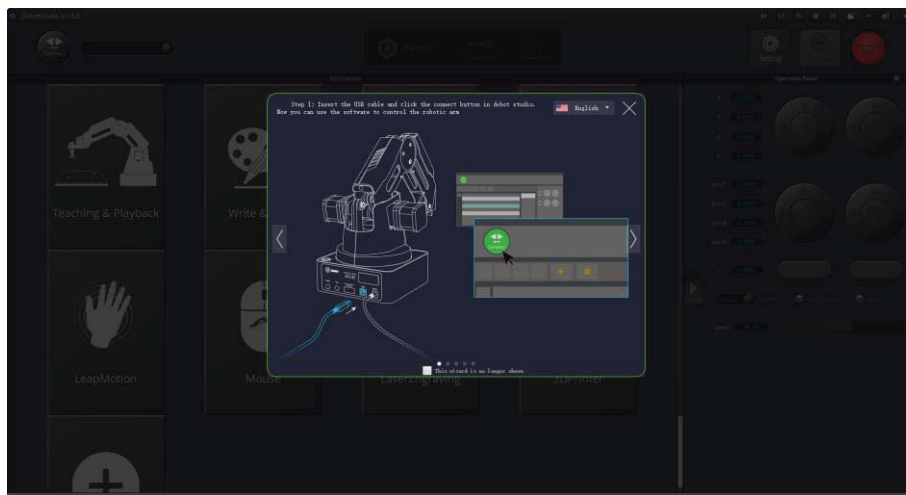

Figure 2.18 Teaching & Playback page

2. Select **PTP Point** > **MOVJ** mode in the Save Point area, as shown in Figure 2.19.

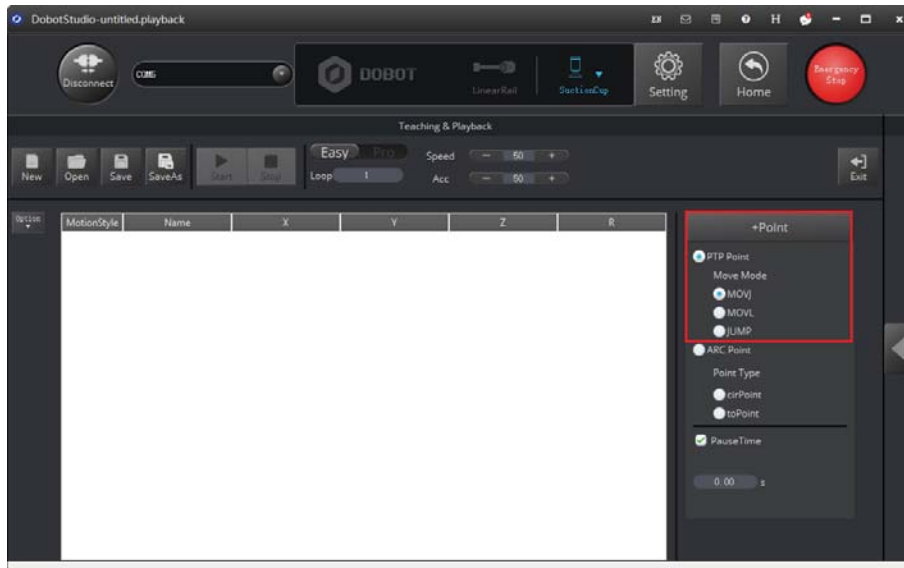



Figure 2.19 Select MOVJ motion mode

3. Press and hold the unlock button  on the Forearm to move the robotic arm to a position such as point A, and then release the button.

In this case, the DobotStudio will save the Cartesian coordinate of point A, as shown in Figure 2.20.

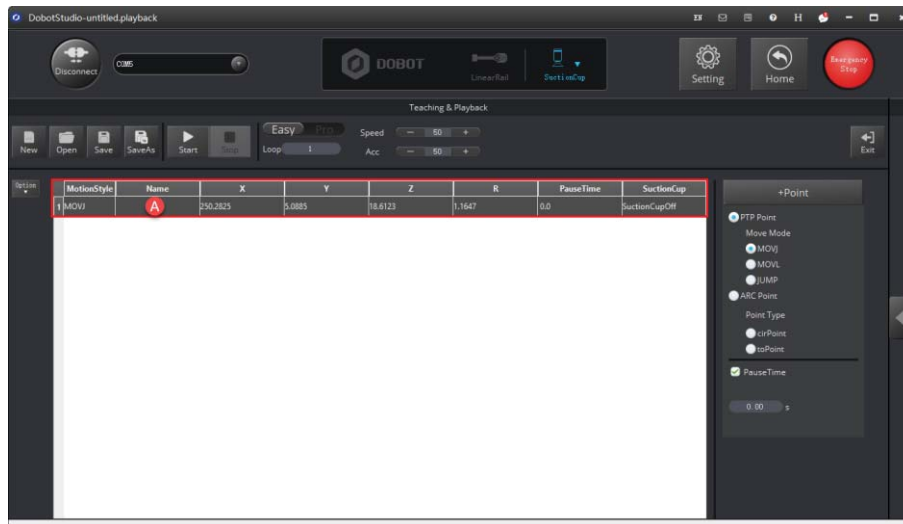

Figure 2.20 The Cartesian coordinate of point A

NOTE:

Apart from hand-guided teaching, you can accomplish a teaching task by jogging the Dobot Magician in the Cartesian or Joint coordinate system, as shown in Figure 2.21.

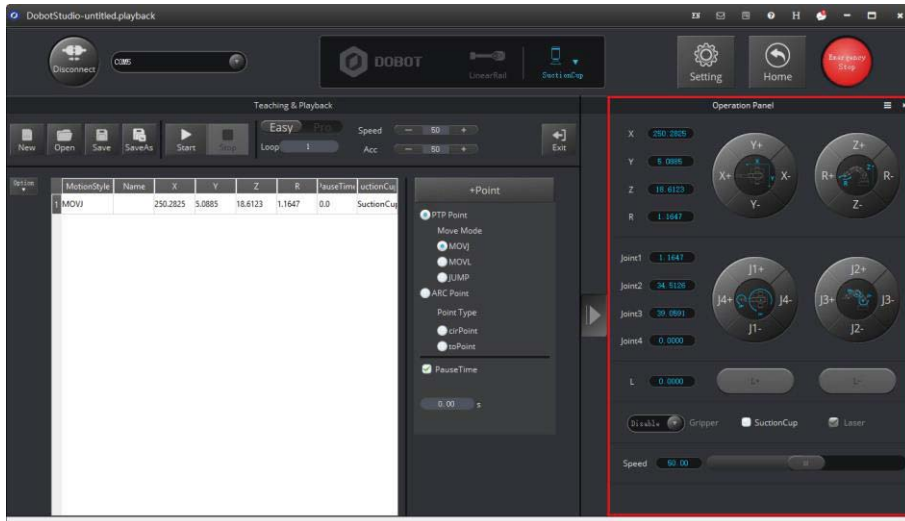

Figure 2.21 Jog the Dobot Magician in the Cartesian or Joint coordinate system

4. Move the robotic arm to other two locations such as points B and C by referring to the method of creating point A above, as shown in Figure 2.22. The robotic arm will save the Cartesian coordinates corresponding to these two points.

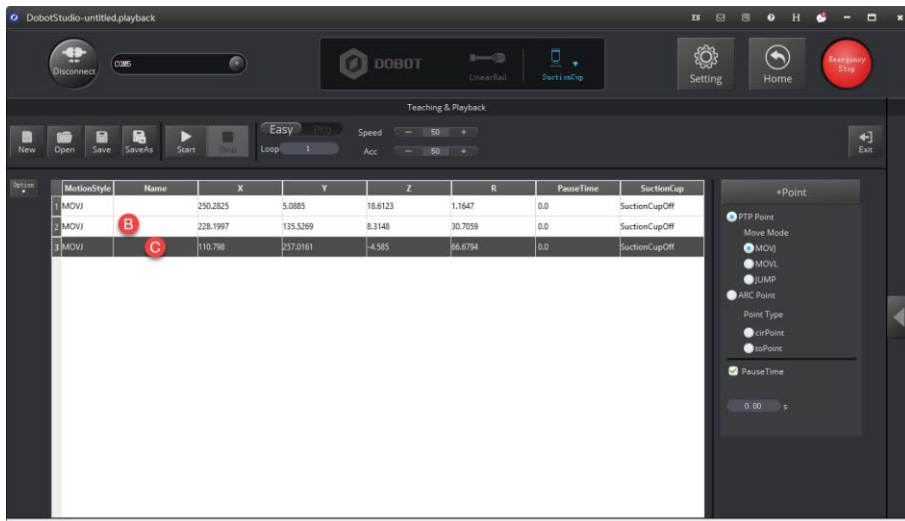

Figure 2.22 The Cartesian coordinates of points B and C

5. Enter **3** in **Loop** text box.
The robotic arm will repeat the sequence of movements for three times, as shown in Figure 2.23.

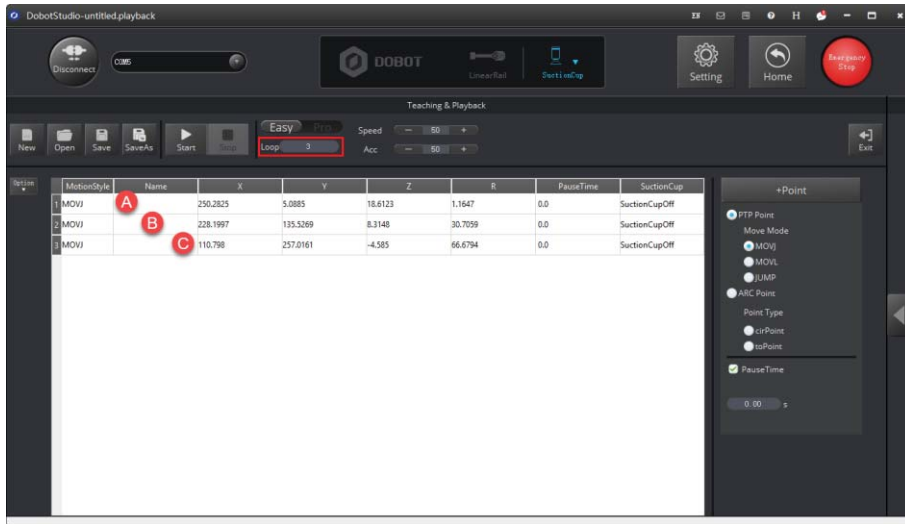

Figure 2.23 Enter 3 in the Loop text box

- Click **Start** to perform the motions taught above, as shown in Figure 2.24. The robotic arm will stop after playing back the steps for three times.

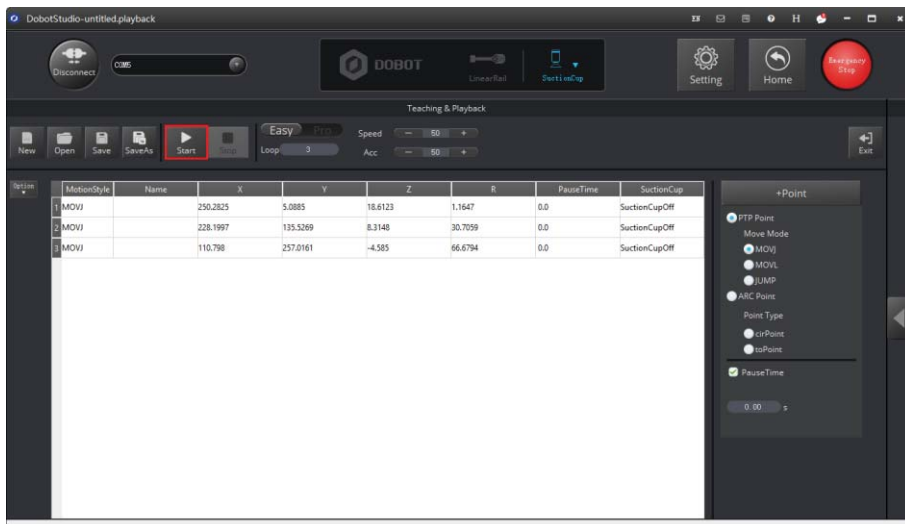

Figure 2.24 Click Start

- Click  to exit the **Teaching & Playback** page, as shown in Figure 2.25.

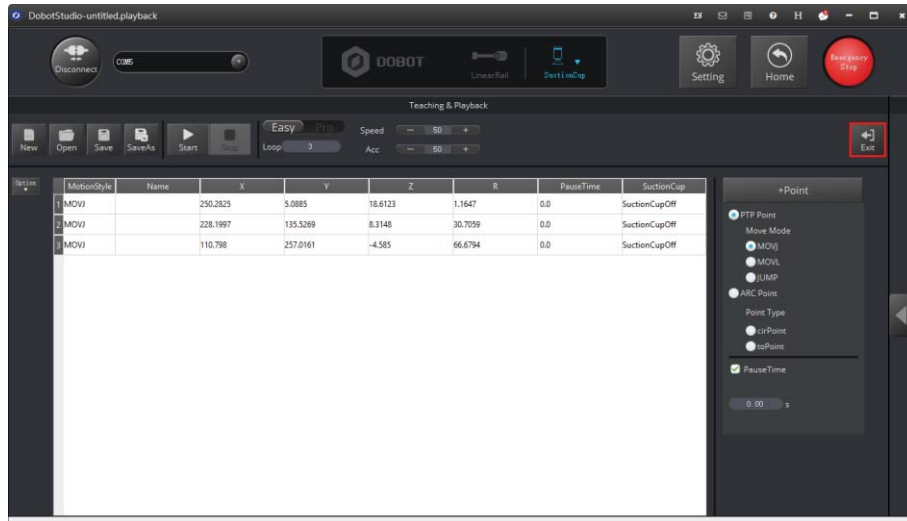

Figure 2.25 Click Exit

3. Introduction

3.1 Overview

Dobot Magician is a multifunctional desktop robotic arm for practical training education, supporting teaching and playback, blockly graphic programming, script, etc. Installed with different end-effectors, Dobot Magician can realize interesting functions such as 3D printing, laser engraving, writing and drawing. It also supports secondary development by various extensible I/O interfaces, which really makes your creativity and imagination increase without any limitation.

3.2 Appearance and Constitute

Dobot Magician consists of Abase, Rear Arm, Forearm, and end-effector, etc. Figure 3.1 shows the appearance.

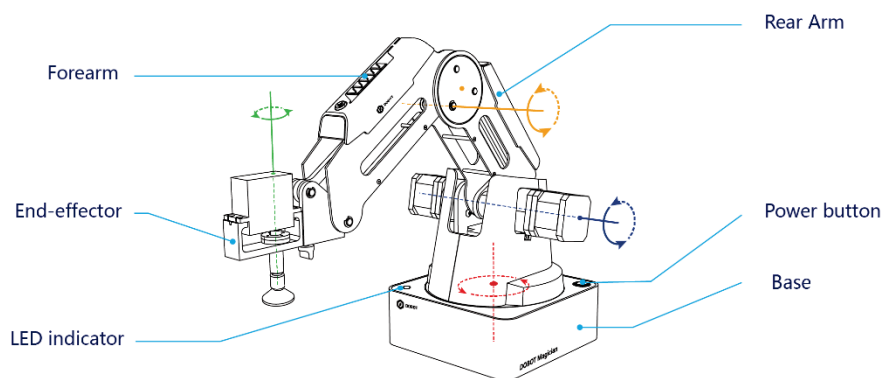

Figure 3.1 The appearance of Dobot Magician

3.3 Working Principle

This topic describes the workspace, principle, size and technical specifications of Dobot Magician.

3.3.1 Workspace

Figure 3.2 and Figure 3.3 shows the workspace.

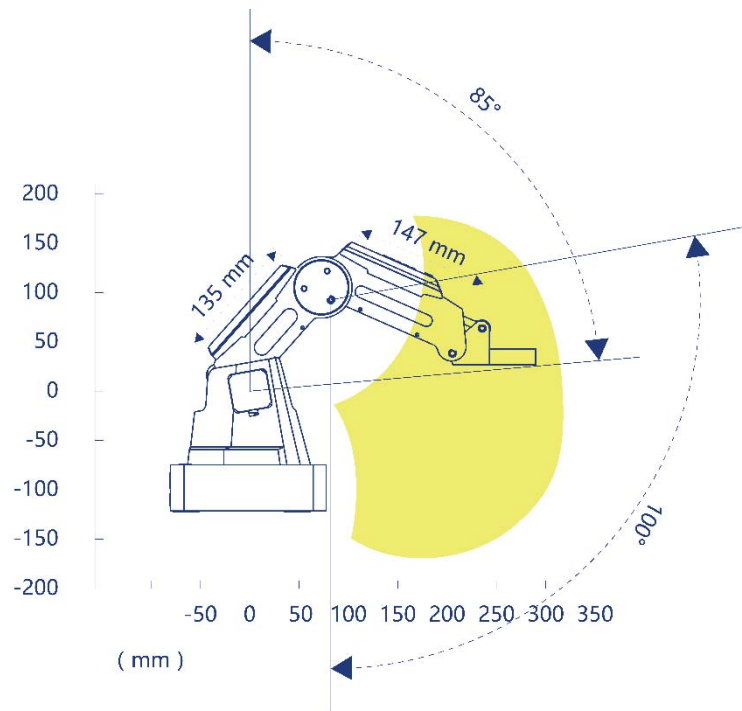

Figure 3.2 Workspace of Dobot Magician (1)

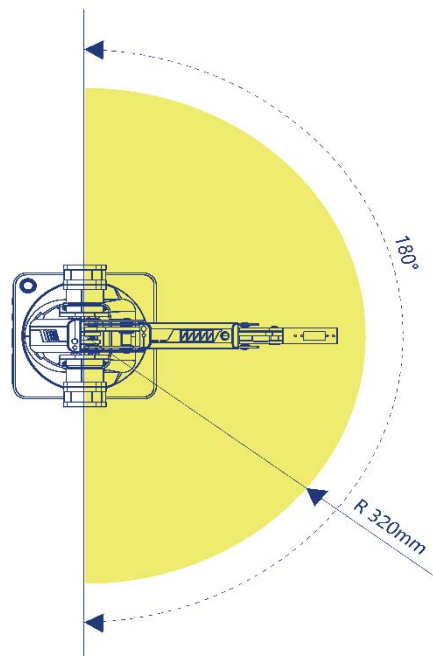

Figure 3.3 Workspace of Dobot Magician (2)

3.3.2 Coordinate System

Dobot Magician has two types of coordinate system, the joint one and the Cartesian one, as shown in Figure 3.4 and Figure 3.5 respectively.

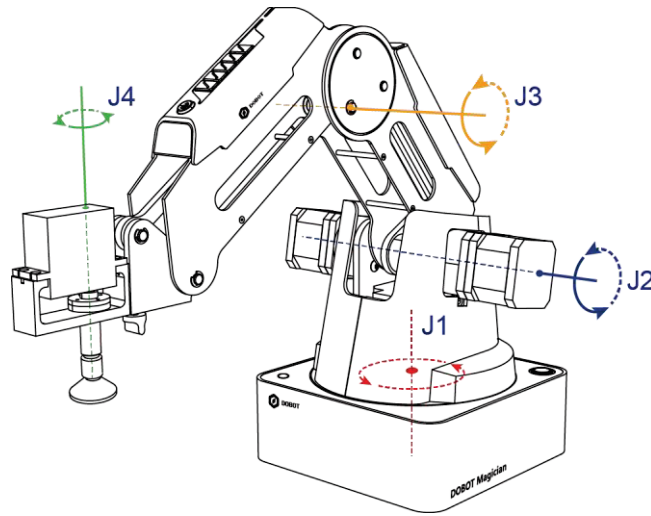

Figure 3.4 Joint coordinate system

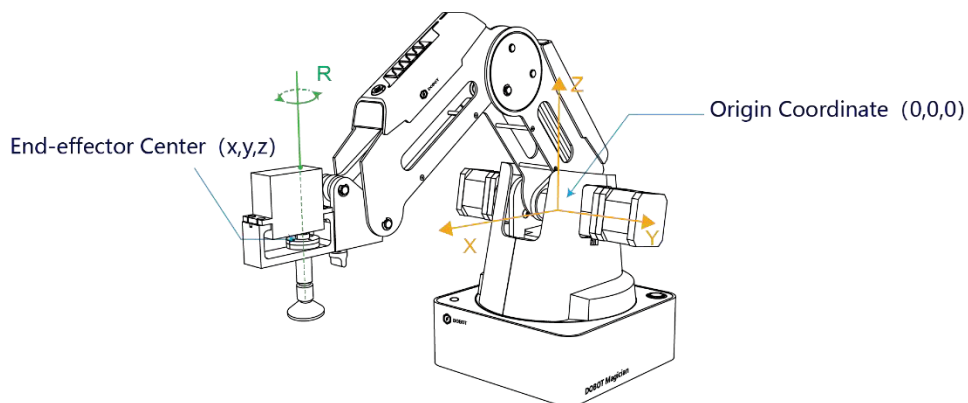

Figure 3.5 Cartesian coordinate system

- Joint coordinate system: The coordinates are determined by the motion joints.
- If the end-effector is not installed, Dobot Magician contains three joints: J1, J2, and J3, which are all the rotating joints. The positive direction of these joints is counter-clockwise.
- If the end-effector with servo is installed, such as suction cup kit, gripper kit, Dobot Magician contains four joints: J1, J2, J3 and J4, which are all the rotating joints. The positive direction of these joints is counter-clockwise.
- Cartesian coordinate system: The coordinates are determined by the base.
- The origin is the center of the three motors (Rear Arm, Forearm, base).
- The direction of X-axis is perpendicular to the base forward.

- The direction of Y-axis is perpendicular to the base leftward.
- The direction of Z-axis is vertical upward, which is based on the right hand rule.
- The R-axis is the attitude of the servo center relative to the origin of the robotic arm, of which the positive direction is counter-clockwise. The R-axis only exists once the end-effector with servo is installed.

3.3.3 Motion Function

The motion modes of Dobot Magician include Jogging, Point to Point (PTP), ARC.

3.3.3.1 Jogging Mode

Jogging mode is the mode jogging Dobot Magician along the Cartesian coordinate system or Joint coordinate system when teaching.

NOTE

This topic describes jogging mode by the GUI operation of DobotStudio.

- Cartesian coordinate system mode
- Click **X+**, **X-** and Dobot Magician will move along X-axis in the negative or positive direction.
- Click **Y+**, **Y-** and Dobot Magician will move along Y-axis in the negative or positive direction.
- Click **Z+**, **Z-** and Dobot Magician will move along Z-axis in the negative or positive direction.
- Click **R+**, **R-** and Dobot Magician will rotate along R-axis in the positive or negative direction.

NOTICE

If the end-effector with servo is installed on the Dobot Magician, the R-axis will move together with Y-axis, to make sure that the terminal posture relative to the origin stays constant.

- Joint coordinate system mode
- Click **J1+**, **J1-** and control the base motor to rotate in the negative or positive direction.
- Click **J2+**, **J2-** and control the Rear Arm motor to rotate in the negative or positive direction.
- Click **J3+**, **J3-** and control the Forearm motor to rotate in the negative or positive direction.
- Click **J4+**, **J4-** and control the servo to rotate in the negative or positive direction.

3.3.3.2 Point to Point (PTP)

PTP mode supports MOVJ, MOVL, and JUMP, which means point to point movement. The trajectory of playback depends on the motion mode.

- **MOVJ**: Joint movement. From point A to point B, each joint will run from initial angle to its target angle, regardless of the trajectory, as shown in Figure 3.6.

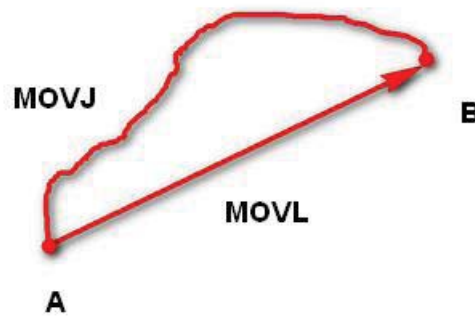

Figure 3.6 MOVL/MOVJ mode

- **MOVL**: Rectilinear movement. The joints will perform a straight line trajectory from point A to point B, as shown in Figure 3.6.
- **JUMP**: From point A to point B, the joints will move in MOVJ mode, of which the trajectory looks like a door, as shown in Figure 3.7.
 1. Move up the lifting Height in MOVJ mode.
 2. Move horizontally to a point that is above B by height.
 3. Move down to point B.



Figure 3.7 JUMP mode

3.3.3.3 ARC

The trajectory of ARC mode is an arc, which is determined by three points (the current point, any point and the end point on the arc), as shown in Figure 3.8.

NOTICE

In ARC mode, it is necessary to confirm the three points with other motion modes, and the three points cannot be in a line.

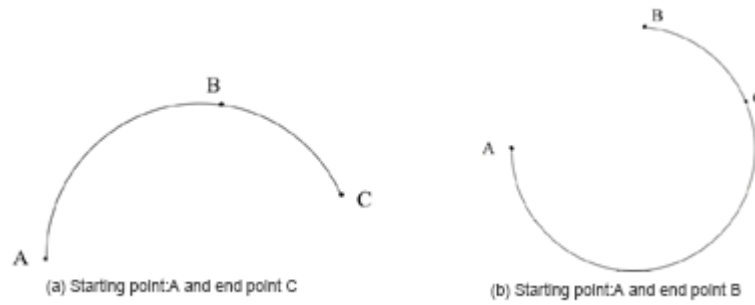

Figure 3.8 ARC mode

3.3.3.4 Application Scenarios

The application scenario depends on the trajectory in motion mode, as shown in Table 3.1.

Table 3.1 Application scenario

Motion mode	Application scenario
MOVL	If the trajectory of playback is required as a straight line, you can choose MOVL
MOVJ	If the trajectory of playback is not required but high speed is required, you can choose MOVJ
JUMP	If the movement of two points is required to lift upwards by amount of height, such as sucking up, grabbing, you can choose JUMP
ARC	If the trajectory of playback is required as an arc, such as dispensing, you can choose ARC

3.4 Technical Specifications

3.4.1 Technical Parameters

Name	Dobot Magician	
Maximum payload	500g	
Maximum reach	320mm	
Motion range	Base	-90° to 90°
	Rear Arm	0° to 85°
	Forearm	-10° to 90°
	End-effector rotation	-90° to 90°

Maximum speed (with 250g payload)	Rotational speed of Rear arm, Forearm and base	320°/s
	Rotational speed of servo	480° /s
Repeated positioning accuracy	0.2mm	
Power supply	100V-240V AC, 50/60Hz	
Power in	12V/7A DC	
Communication	USB, WIFI, Bluetooth	
I/O	20 extensible I/O interfaces	
Software	DobotStudio	
Working temperature	-10°-60°	

3.4.2 Sizes

Figure 3.9 shows the size of Dobot Magician and Figure 3.10 shows the size of the end mounting hole.

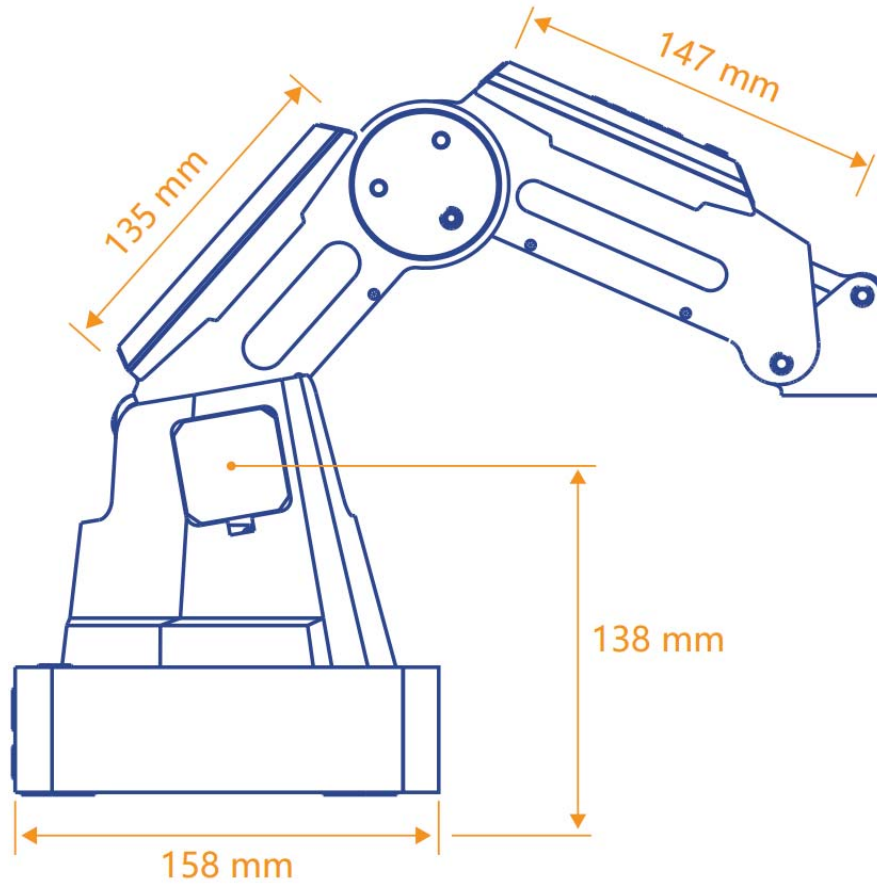

Figure 3.9 Size of Dobot Magician

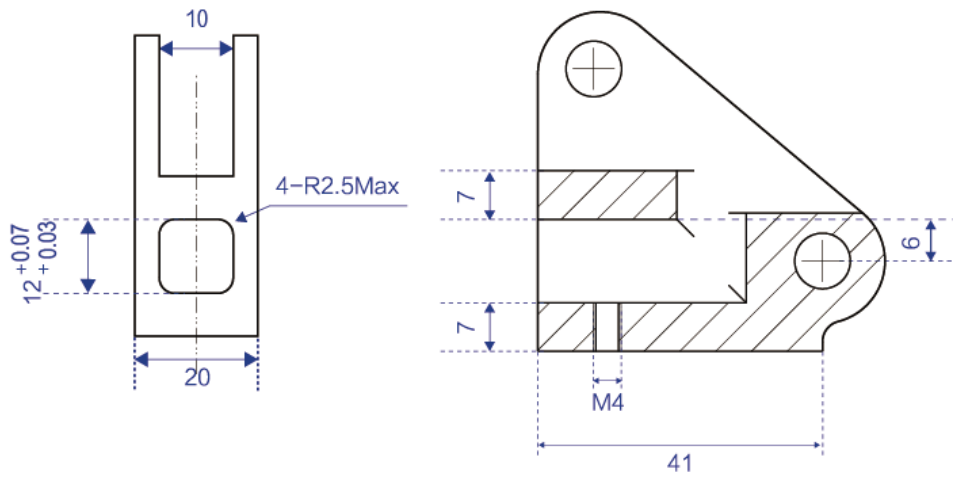

Figure 3.10 Size of end mounting hole

4. Interface Description

4.1 Interface Board

The interfaces of Dobot Magician are located on the back of the base and the Forearm respectively. Figure 4.1 shows the interfaces on the back of the base, and Table 4.1 lists the description.

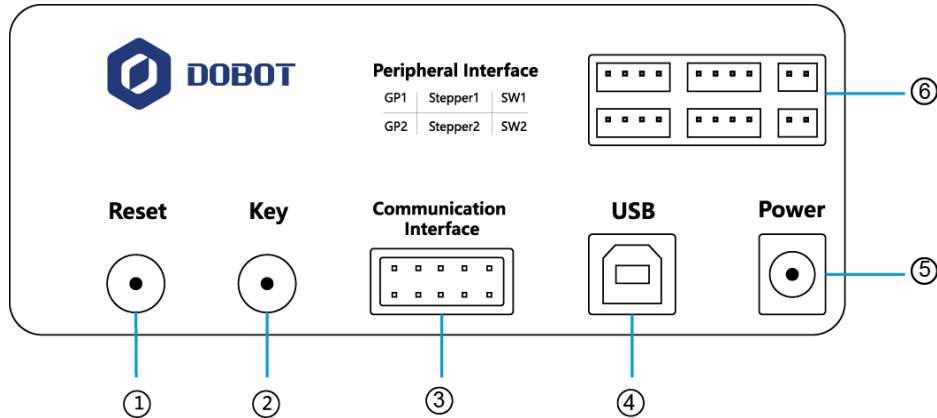

Figure 4.1 Interfaces in the base

Table 4.1 Interface Description

No.	Description
1	Reset key: Reset MCU program During resetting, the LED indicator on the base turns yellow. About 5 seconds later, if the LED indicator turns green, it indicates that the reset is successful
2	Functional key: <ul style="list-style-type: none"> Short press: Start running offline program Long press for 2 seconds: Starting homing procedure
3	Communication interface/UART interface: Connect with Bluetooth, WIFI and so on The Dobot protocol is adopted.
4	USB interface: Connect with PC
5	Power interface: Connect with power adaptor
6	Peripheral interface: Connect with air pump, extruder, sensor and other peripheral equipment. For details about peripheral interfaces, please see Table 4.2

Table 4.2 lists the peripheral interface description.

Table 4.2 Peripheral interface description

Interface	Description
SW1	Power interface of air pump; output 12V of controllable power
SW2	Output 12V of controllable power
Stepper1	User-defined stepper interface; extruder interface (3D printing mode)
Stepper2	User-defined stepper interface
GP1	Signal interface of air pump; color sensor interface; infrared sensor interface; user-defined general interface
GP2	User-defined general interface

Figure 4.2 shows the peripheral interface on the Forearm, and Table 4.3 lists the description of the peripheral interfaces.

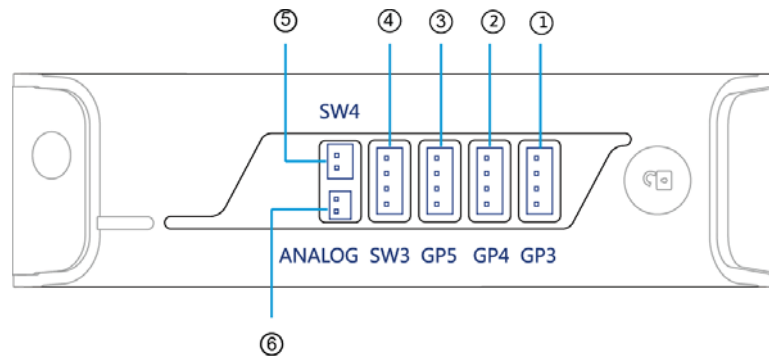

Figure 4.2 Peripheral interface in the Forearm

Table 4.3 Peripheral interface description

No.	Description
1	GP3, End-effector interface; R-axis servo interface; user-defined general interface
2	GP4, Auto levelling interface, user-defined general interface
3	GP5, Signal interface of laser engraving; user-defined general interface
4	SW3, Hot end interface (3D printing mode); Output 12V of controllable power
5	SW4, Fan interface (3D printing mode); Power interface of laser engraving; Output 12V of controllable power
6	ANALOG, Thermistor interface (3D printing mode)

4.2 LED Indicator

The LED indicator is located on the base, Table 4.4 lists the status description.

Table 4.4 LED indicator description

Status	Description
Green On	Dobot Magician works normally
Yellow On	Dobot Magician is in the starting status
Blue On	Dobot Magician is in the offline mode
Blue Blinking	Dobot Magician is running homing procedure or auto levelling
Red On	<ul style="list-style-type: none"> Dobot Magician is at the limited position Alarm is not cleared Connection of 3D printing kit is abnormal

4.3 Multiplexed I/O Interface Description

The addresses of the I/O interfaces in Dobot Magician are unified. Most of I/O interfaces have multiple functions, to control the peripheral equipment.

4.3.1 Multiplexed Base I/O Interface Description

4.3.1.1 Multiplexed UART Interface Description

Figure 4.3 shows the UART interface on the base, Table 4.5 lists the multiplexed I/O description.

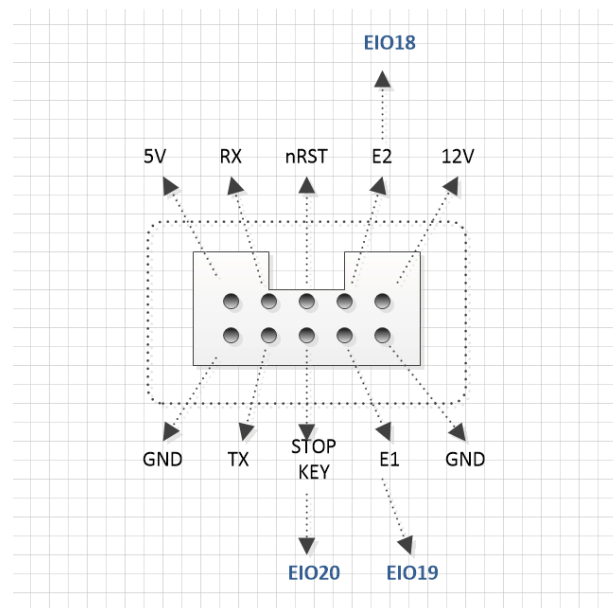

Figure 4.3 UART interface

Table 4.5 Multiplex I/O Description

I/O addressing	Voltage	Level Output	PWM	Level Input	ADC
18	3.3V	√	-	-	-
19	3.3V	-	-	√	-
20	3.3V	-	-	√	-

4.3.1.2 Multiplexed Peripheral Interface Description

Figure 4.4 shows the peripheral interface on the base, and Table 4.6 lists the multiplexed I/O description.

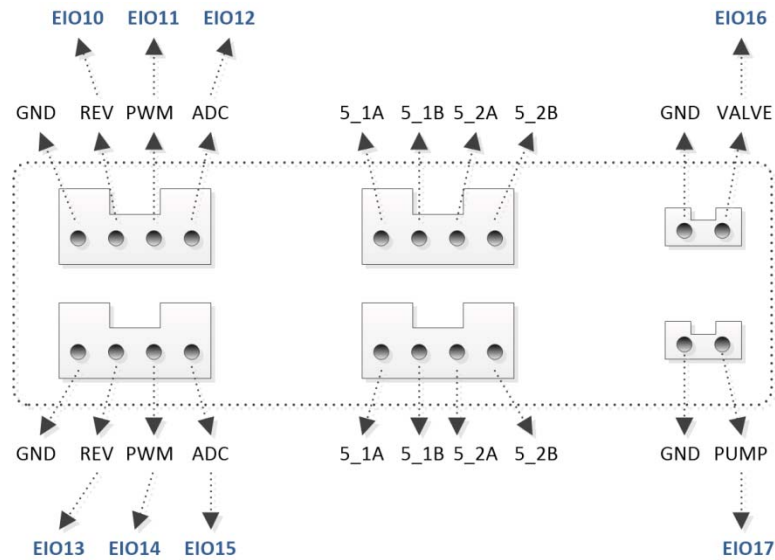

Figure 4.4 Peripheral Interface

Table 4.6 Multiplexed I/O Description

I/O addressing	Voltage	Level Output	PWM	Level Input	ADC
10	5V	√	-	-	-
11	3.3V	√	√	-	-
12	3.3V	-	-	√	-
13	5V	√	-	-	-
14	3.3V	√	√	√	-
15	3.3V	√	-	√	√
16	12V	√	-	-	-

17	12V	√	-	-	-
----	-----	---	---	---	---

4.3.2 Multiplexed Forearm I/O Interface Description

Figure 4.5 shows the peripheral interface on the Forearm, Table 4.7 lists the multiplexed I/O description.

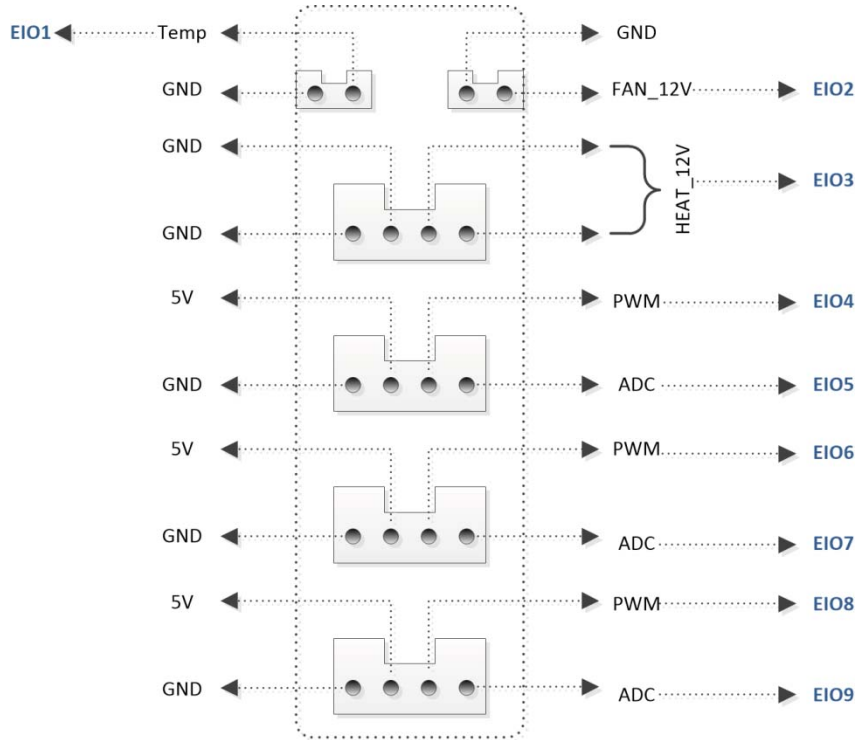

Figure 4.5 Peripheral interface in the Forearm

Table 4.7 Multiplexed I/O description

I/O addressing	Voltage	Level Output	PWM	Level Input	ADC
1	3.3V	√	-	√	√
2	12V	√	-	-	-
3	12V	√	-	-	-
4	3.3V	√	√	-	-
5	3.3V	-	-	√	-
6	3.3V	√	√	-	-
7	3.3V	-	-	√	-
8	3.3V	√	√	-	-
9	3.3V	√	-	√	√

5. Operation

5.1 Introduction to the DobotStudio

5.1.1 Function Modules

You can use the DobotStudio to control the Dobot Magician to accomplish multiple functions such as **Teaching & Playback**, **Write & Draw**, **Blockly** graphic programming, and **Script** control, as shown in Figure 5.1. For details, see Table 5.1.



Figure 5.1 The function modules on the DobotStudio page

Table 5.1 The function modules on the DobotStudio page

Function Modules	Description
Teaching & Playback	Teach the Dobot Magician how to move and then record the movement to make Dobot Magician accomplish the recorded movements
Write & Draw	Control the robotic arm to write, draw, or engrave an object using a laser
Blockly	Use Blockly to program the robotic arm in a graphic programming environment. It allows the users to drag and drop the blocks onto a workplace to generate execute code just as intuitive and easy as a block puzzle
Script	Control the robotic arm using the script commands
Leap Motion	Support hand motions as input to control the robotic arm via a Leap Motion controller
Mouse	Control the robotic arm using a mouse
LaserEngraving	Engrave a bitmap image on an object using a laser
3DPrinter	Capable of 3D printing

Function Modules	Description
Add More	Add more custom functions to manipulate the robotic arm.

You can also set the Dobot Magician by clicking **Setting** on the DobotStudio page, for example, implement general settings, base calibration, manual levelling, and auto levelling, as shown in Figure 5.2. For details, see Table 5.2.

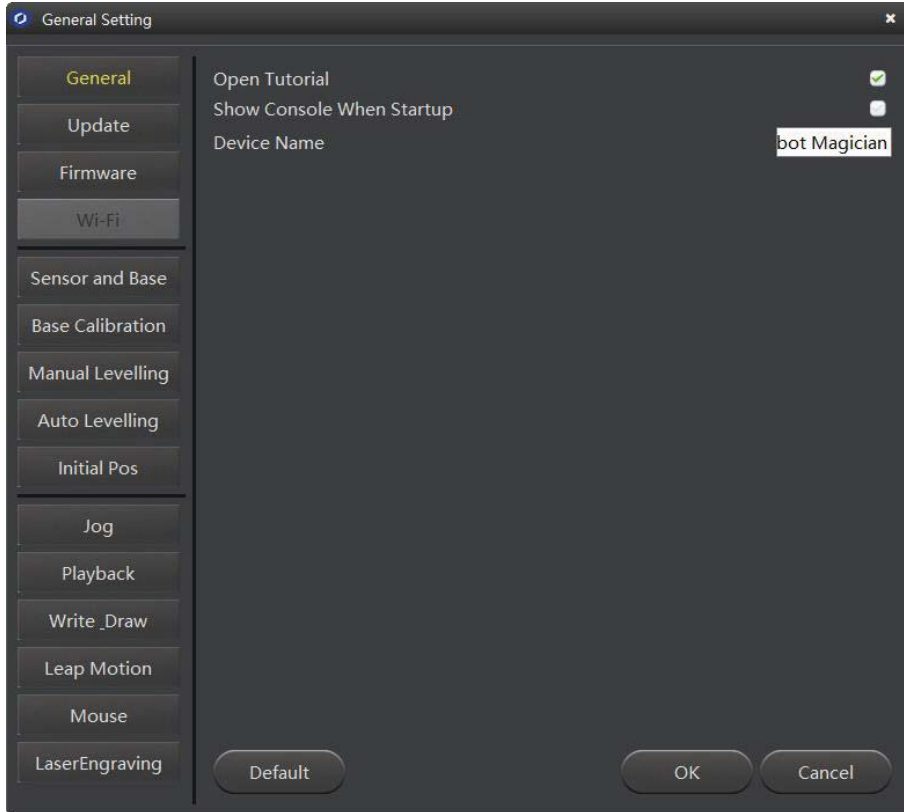

Figure 5.2 The General Setting page

Table 5.2 The General Setting page

Items	Description
Firmware	Switch firmware For example, you can switch to the 3D printer firmware to implement 3D printing from the currently selected Dobot firmware
Sensor and Base	Set the Base Encoder and the angle sensors on the Forearm and Rear Arm
Base Calibration	Calibrate the base Encoder
Manual Levelling	Manually calibrate the angle sensors on the Forearm and Rear Arm
Auto Levelling	Automatically calibrate the angle sensors on the Forearm and Rear Arm.
Initial Pos	Set the initial pose of the robotic arm.
Jog	Set the jogging speed and acceleration in the Joint coordinate system and

Items	Description
	Cartesian coordinate system
Playback	Set the joint parameters, coordinate parameters, Jump parameters, handhold teaching and LostStepParam.
Write Draw	Set the Write & Draw function, such as speed, Junction velocity, linear acceleration, acceleration, pen up offset and pen down position.
Leap Motion	Set the parameters such as speed, scale, and performance for hand gesture control.
Mouse	Set the parameters such as speed, scale, and performance for mouse control.
LaserEngraving	Set the parameters such as junction velocity, linear acceleration, acceleration, pen down position, and DPI for laser engraving.

5.1.2 Common Areas of DobotStudio Page

The DobotStudio offers the following common areas shared by all the function modules to control the robotic arm.

- You can select the liner rail or an end-effector on the DobotStudio page, as shown in Figure 5.3.

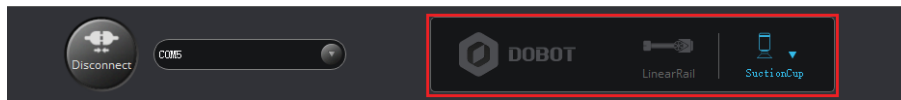

Figure 5.3 The linear rail and end-effector drop-down list

Table 5.3 The linear rail and end-effector drop-down list

Items	Description
Linear rail	When the robotic arm is connected to a linear rail, click this item to enable the rail
End-effector drop-down list	When the end-effector is a suction cup kit, gripper kit, laser kit or writing and drawing kit, select the corresponding kit in this list

- You can also perform other operations on the DobotStudio page such as Setting, Home, Emergency Stop, and viewing the versions, as shown in Figure 5.4.

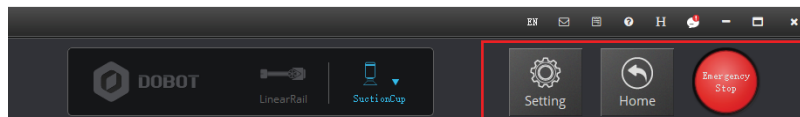

Figure 5.4 Setting, Home, Emergency Stop, and viewing the versions

Table 5.4 Setting, Home, Emergency Stop, and viewing the versions

Items	Description
Setting	Set the robotic arm such as firmware upgrade, sensor and base setup. For details, see Table 5.2
Home	Set the Dobot Magician back to its home position to get a correct reference position When the Dobot Magician is moving, if its movement is hindered by an obstacle or the stepper motors lost steps, perform the homing operation
Emergency Stop	Stop the robotic arm if an emergency occurs
	View the version information such as DobotStudio version, firmware version, and hardware version

With the **Operation Panel** on the **DobotStudio** page, you can teach the robotic arm to perform a specific task such as jogging the robotic arm in the Cartesian or joint coordinate system, or controlling a gripper, suction cup, or laser, as shown in Figure 5.5. For details, see Table 5.5.



Figure 5.5 Setting the Operation Panel

Table 5.5 Setting the Operation Panel

Items	Description
Coordinate jogging	Jog the Dobot Magician by clicking X (X+/-), Y (Y+/-), Z (Z+/-), or R (R+/-) in the Cartesian coordinate system
Joint jogging	Jog the Dobot Magician by clicking J1+/-, J2+/-, J3+/-, or J4+/- in the Joint coordinate

Items	Description
	system
Linear control	When the linear rail is enabled (see Table 5.3), click L+/- to move the robotic arm along the rail. Value range: 0 mm - 1000 mm
Gripper control	When the end-effector is chosen as a Gripper , you can set the gripper to open, close, or disable in the Gripper drop-down box
Suction cup control	When the end-effector is chosen as a Suction Cup , select SuctionCup to power on the air pump. If unselected, the air pump is powered off
Laser control	When the end-effector is chosen as a Laser , select Laser to turn on the laser. If unselected, the laser is turned off
Jogging speed control	Set the jogging speed percentage Default value: 50% Value range: 1% - 100%

5.2 Performing Teaching & Playback Tasks

This topic introduces how to perform a teaching & playback task to suck or grab a small cube. Because a suction cup kit or a gripper kit is required, we will explain them first.

5.2.1 Installing a Suction Cup Kit

A suction cup kit is the default end-effector shipped with the Dobot Magician. When using the suction cup kit, an air pump is necessary, as shown in Figure 5.6.

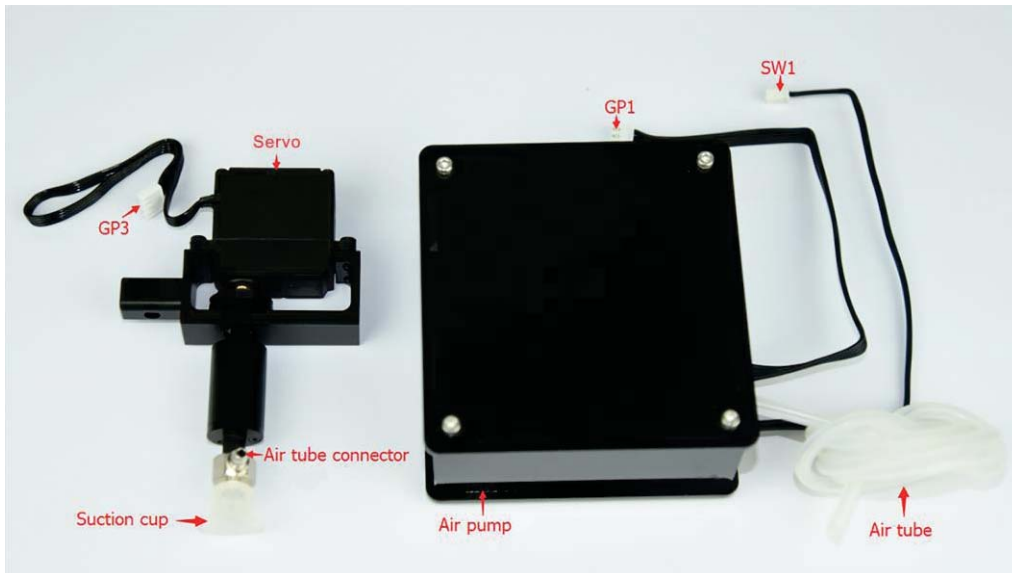

Figure 5.6 A suction cup kit

Procedure

- Step 1** Connect the air pump’s power cable **SW1** to the **SW1** connector on the Dobot Magician base’ rear panel and the signal cable **GP1** to the **GP1** connector, as shown in Figure 5.7.



Figure 5.7 Connect the air pump to the Dobot Magician

- Step 2** Insert a suction cup kit into the end's port, and fasten it with a butterfly nut, as shown in Figure 5.8.



Figure 5.8 Install a suction cup kit

- Step 3** Connect the air pump's air tube to the air tube connector of the suction cup kit, as shown in Figure 5.9.



Figure 5.9 Install an air tube

- Step 4** Connect the servo's **GP3** cable to the **GP3** connector on the Forearm, as shown in Figure 5.10.

The Forearm

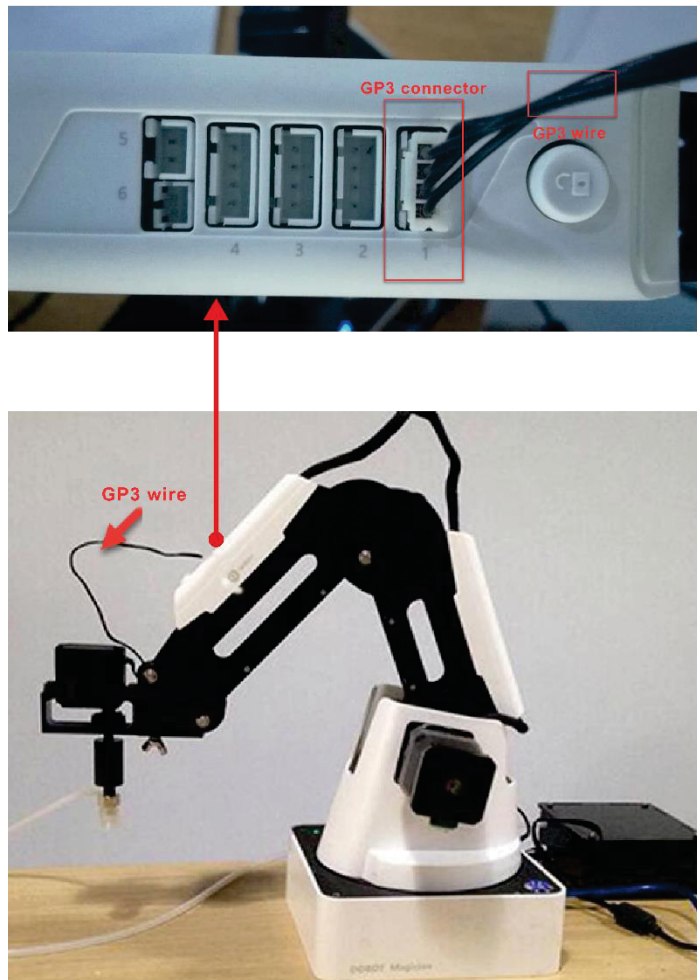

Figure 5.10 Connect the servo's GP3 cable to the GP3 connector

5.2.2 Installing a Gripper Kit

An air pump should be used with the gripper kit, as shown in Figure 5.11, to open or close the gripper.

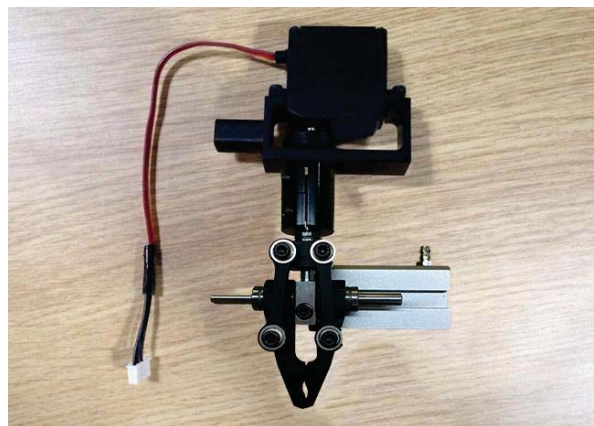

Figure 5.11 A gripper kit

Procedure

- Step 1** Dismantle the suction cup by unfastening its terminal strand with a 1.5mm hexagon wrench, as shown in Figure 5.12.



Figure 5.12 Dismantle the suction cup

- Step 2** Install a gripper kit to the servo with a 2.5mm hexagon wrench, as shown in Figure 5.13.

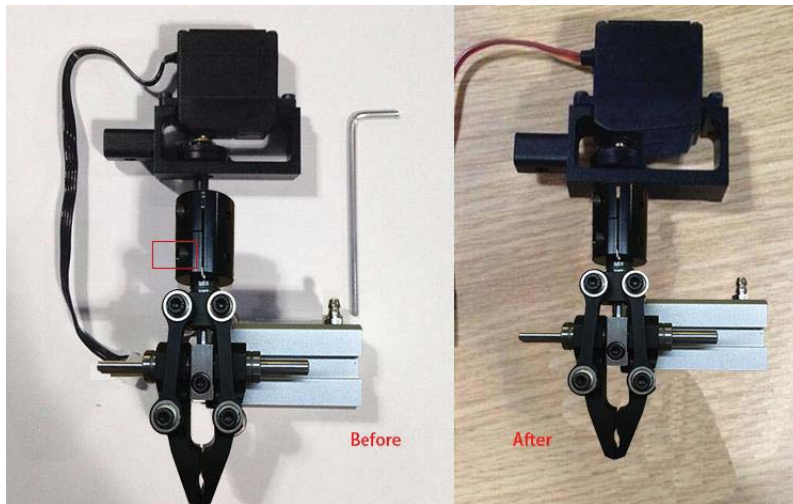

Figure 5.13 Install a gripper kit

- Step 3** Connect the gripper kit and an air pump to the Dobot Magician in the same way as the suction cup kit is installed. For details, see *5.2.1 Installing a Suction Cup Kit*. Figure 5.14 shows the effect of the gripper kit installation.

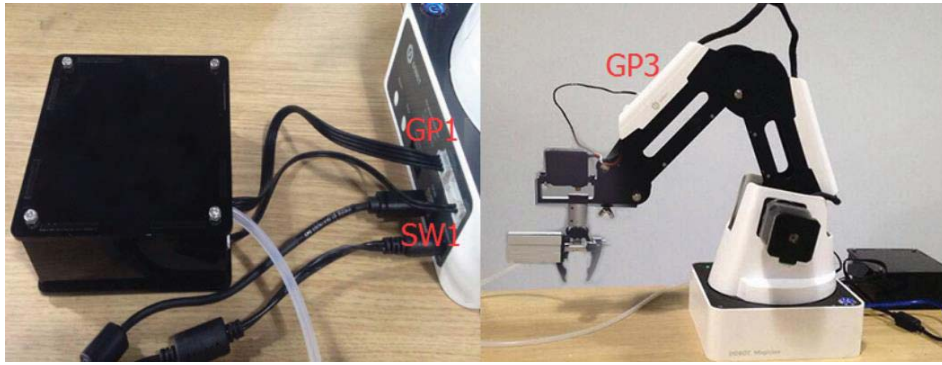

Figure 5.14 The effect of the gripper kit installation

5.2.3 Teaching & Playback Page

The **Teaching & Playback** page is shown in Figure 5.15. To access it, select **Connect > Teaching & Playback** on the **DobotStudio** page.

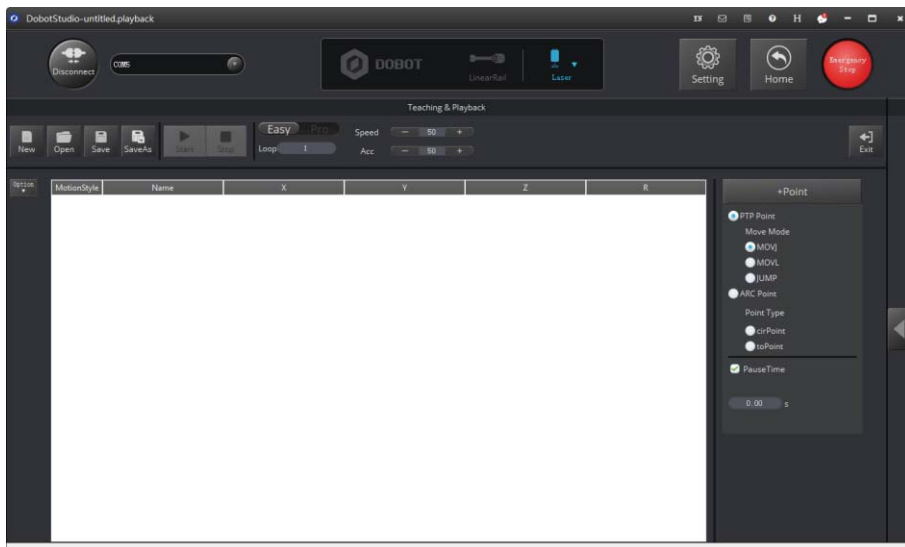

Figure 5.15 The Teaching & Playback page

- In both **Easy** and **Pro** modes, you can switch between **Easy** and **Pro** modes, set loop, speed percentage, and acceleration percentage, as shown in Figure 5.16.

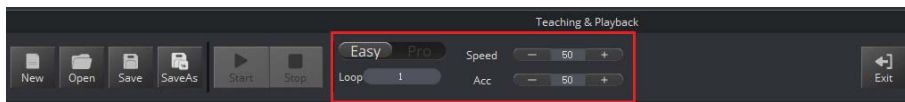

Figure 5.16 Set Easy/Pro, Loop, Speed and Acceleration (Acc)

Table 5.6 Set Easy/Pro, Loop, Speed and acceleration (Acc)

Items	Description
Easy/Pro	Click this slider to switch between Easy and Pro modes. The default is the Easy mode Apart from all the functions in the Easy mode, the Pro mode offers multiple features such as the offline mode and multiplexed I/O interface
Loop	Set the loop that the robotic arm plays back the recorded steps Default value: 1 Value range: 1 - 999999
Speed	Set the speed ratio when doing playback Default value: 50% Value range: 0% - 100%
acceleration (Acc)	Set the acceleration ratio when doing playback Default value: 50% Value range: 0 - 100%
Exit	Exit the current Teaching & Playback page to return to the DobotStudio page

- In both **Easy** and **Pro** modes, you can save points, set the motion mode and the pause time for a save point, as shown in Figure 5.17.

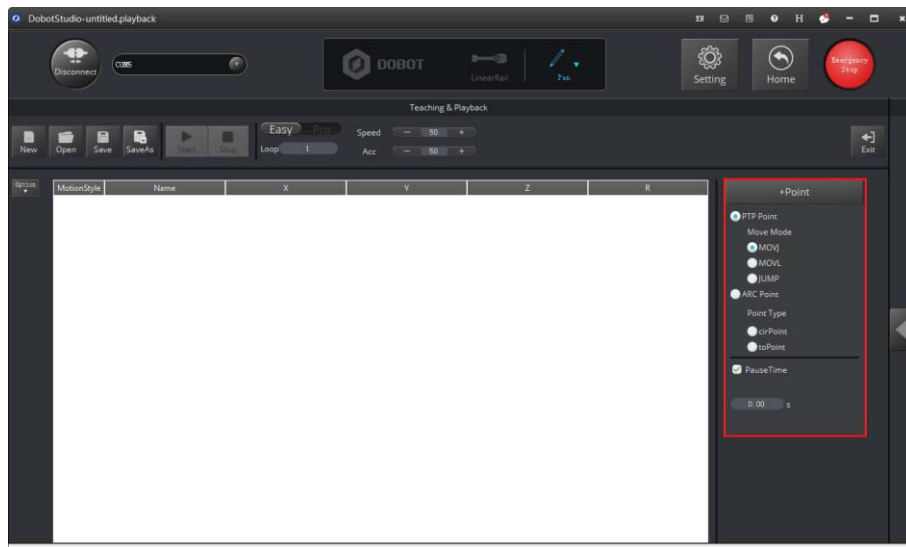

Figure 5.17 Set the save points, motion modes and pause time

Table 5.7 Set the save points, motion modes, and pause time

Items	Description
+Point	Click to create a new save point in the Save points list
Motion mode	Choose a PTP (point to point) Point mode or ARC Point mode. In the PTP Point mode, you can select MOVJ, MOVL, or JUMP mode while the ARC Point mode requires a second point cirPoint and a finish point toPoint as well as the start point set via the PTP Point mode

Items	Description
Pause time	Set the pause time for a save point

- In both **Easy** and **Pro** modes, you can edit a highlighted save point such as copy, paste, cut, switch between motion modes, modify name and coordinates, as shown in Figure 5.18.

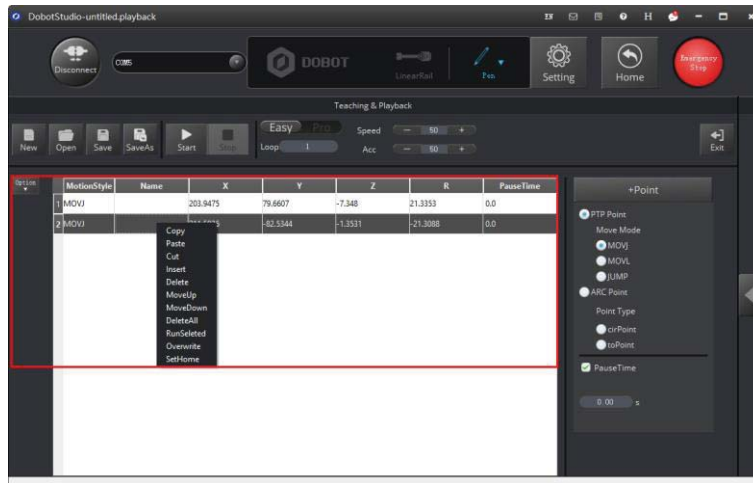

Figure 5.18 The Save points list

Table 5.8 The Save points list

Items	Description
A right-click mouse operation	In the right-click popup menu you can edit a highlighted save point such as copy, paste, cut, insert, and delete, as shown in Figure 5.18
A double-click mouse operation	Double-clicking a cell to modify its value

- **Pro** mode: To enter the **Pro** mode from the current **Easy** mode, click the **Easy/Pro** slider, as shown in Figure 5.19. Apart from all the functions in the default **Easy** mode, the **Pro** mode allows the robotic arm to run a save point each time, detect lost-steps, work in offline mode, and perform the multiplexed I/O interface. For details, see Table 5.9.

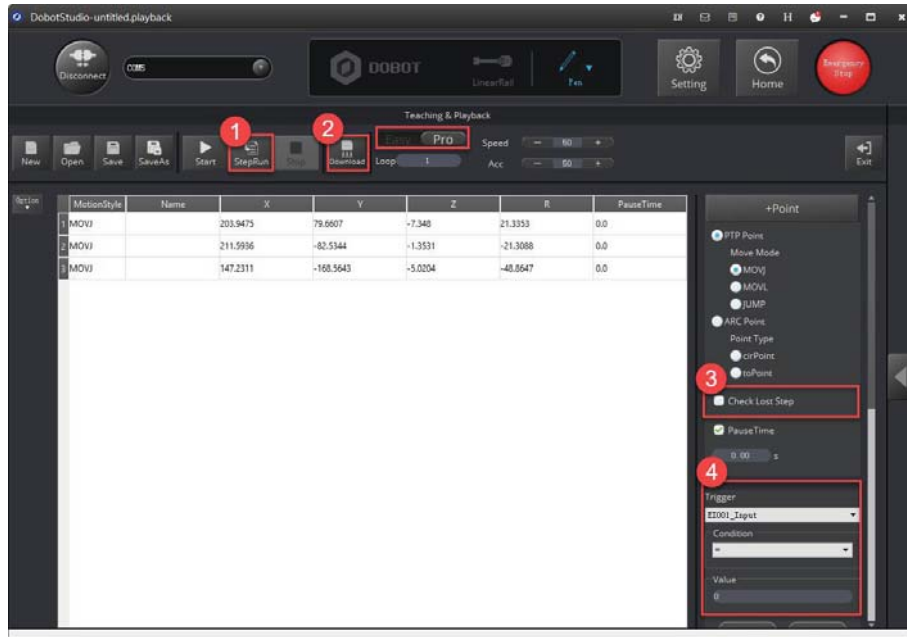

Figure 5.19 The Pro mode of the Teaching & Playback function

Table 5.9 The Pro mode of the Teaching & Playback function

No.	Description
1	StepRun: run a save point each time in the Save points list. Before clicking StepRun , please select a saved point.
2	Download: download the Save points list to the Dobot Magician for working in offline mode. For details, see 5.3 <i>Working in Offline Mode</i>
3	Check Lost Step: the Dobot Magician detects if lost-steps occur in its movements. The default threshold is 5 degrees. It should be at least 0.5 degrees. You can set the threshold by selecting Setting > Playback > LostStepParam . If Check Lost Step is selected, the robotic arm detects if the stepper motors lose steps when moving. If unselected, no detection is performed If the Dobot Magician detects lost-steps, it stops working, and its LED indicator turns red. In this case, click Home to get a correct reference position
4	Multiplexed I/O interface: control the Dobot Magician via the I/O interfaces such as turning on or off the air pump

5.2.4 ARC Motion Mode

Application Scenarios

The **ARC** motion mode requires three points in an arc to complete the arc movement process. In the **ARC** motion mode, only the second point and end point are saved while the start point is determined by the other modes.

Prerequisites

The Dobot Magician has been powered on and connected to your computer.

Procedure

NOTICE

Note the following rules when saving points to prevent the robotic arm from working outside its normal workspace.

- Any two points cannot coincide.
- The three points cannot be in the same straight line.
- The arc trajectory cannot exceed the Dobot Magician's normal workspace.

For example the points A, B, and C are on the arc. Point A is the start point; Point B is the second point; Point C is the end point, as shown in Figure 5.20.

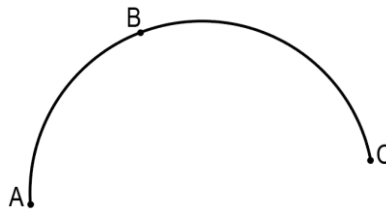

Figure 5.20 The arc trajectory

Step 1 Click **Teaching & Playback**.

The **Teaching & Playback** page is displayed.

Step 2 Save the start point A.

1. Select **MOVJ** motion mode in the Save Point area.

2. Click  to display the **Operation Panel**, as shown in Figure 5.21.



Figure 5.21 Display the Operation Panel

3. Set the jogging speed percentage to **50** on the **Operation Panel**.
4. Jog the Dobot Magician in the Cartesian or Joint coordinate system to move the robotic arm to a location called position A.
5. Click **+Point** to save the coordinate corresponding to the position A, as shown in Figure 5.22.

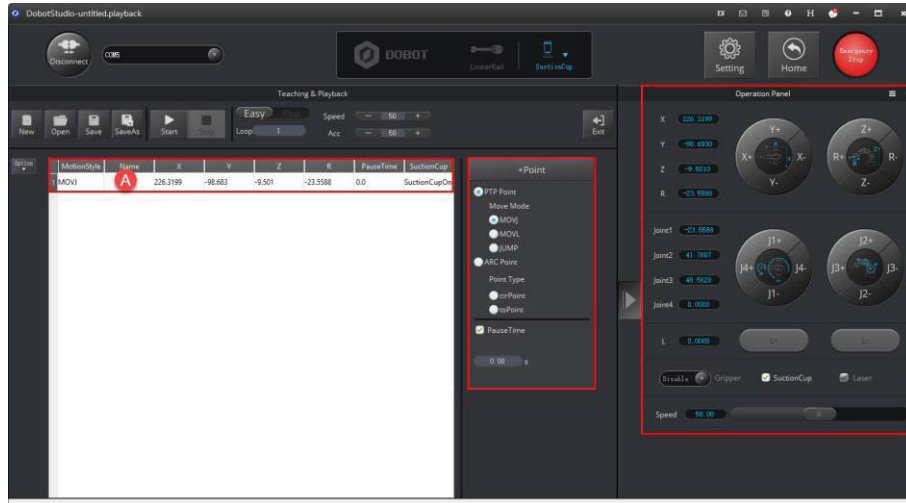

Figure 5.22 Save the start position A

Step 3 Save the second point B and the end point C.

1. Select **cirPoint** to save the second point in the Save Point area.
2. Jogging the Dobot Magician in the Cartesian or Joint coordinate system to move the robotic arm to the second position B as required.
3. Click **+Point** to save the coordinate corresponding to the position B. In this case, the DobotStudio automatically changes the motion mode to **toPoint** to get ready to save the end position.
4. Jogging the Dobot Magician in the Cartesian or Joint coordinate system to move the robotic arm to the end position C as needed.
5. Click **+Point** to save the coordinates corresponding to the positions B and C, as shown in Figure 5.23.

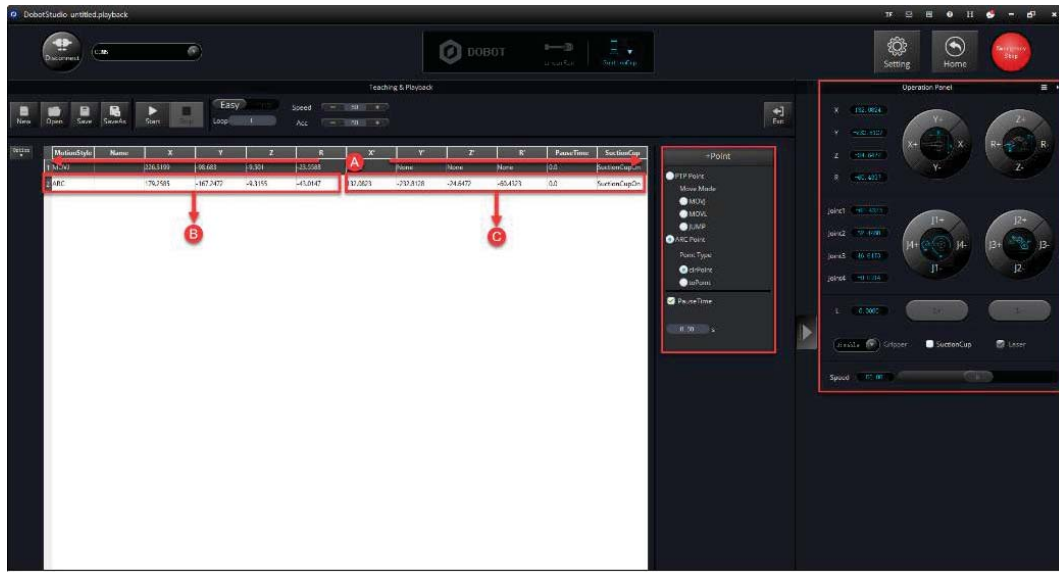

Figure 5.23 Save the second position B and the end position C

- Step 4** Set the percentage of both speed and acceleration for playback, for example 50.
- Step 5** Set **Loop** to 2.
- Step 6** Click **Start**. The Dobot Magician perform the sequence of ARC trajectory as taught from its memory system, moving from positions A through C, as shown in .

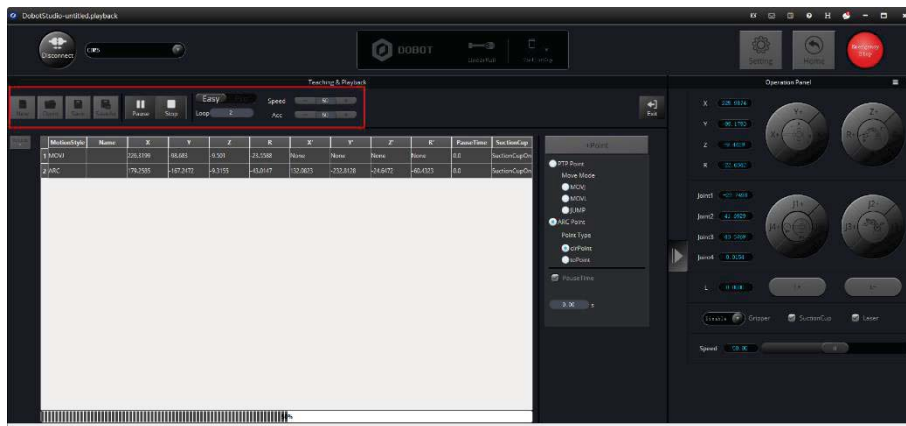

Figure 5.24 Move the small cube in the ARC motion mode

5.2.5 Teaching & Playback Example

Application Scenarios

You can use Teaching & Playback function module to manipulate the Dobot Magician to accomplish different tasks such as transportation or intelligent sort. This topic introduces how to move small cubes from position A to B in the **JUMP** motion mode.

Prerequisites

- The Dobot Magician has been powered on and connected to your computer.

- A suction cup kit has been installed. For details, see *5.2.1 Installing a Suction Cup Kit*.

Procedure

- Step 1** Choose **SuctionCup** as the end-effector on the **DobotStudio** page, as shown in Figure 5.25.



Figure 5.25 Choose SuctionCup as the end-effector

- Step 2** Click **Teaching & Playback**.

The **Teaching & Playback** page is displayed.

NOTE

After reading the beginner guide of the DobotStudio, click  to close it.

- Step 3** Save the start point A.

1. Put a small cube on the work surface near the suction cup kit.
2. Select the **MOVJ** motion mode in the Save Point area.

3. Click  to display the **Operation Panel**, as shown in Figure 5.26.



Figure 5.26 Display the Operation Panel

4. Set the jogging speed percentage to **50** on the **Operation Panel**.

NOTE

To change the jogging speed, select **Setting > Jog** to set the speed and acceleration of the joints, linear rail, or the Cartesian coordinate system, as shown in Figure 5.27.

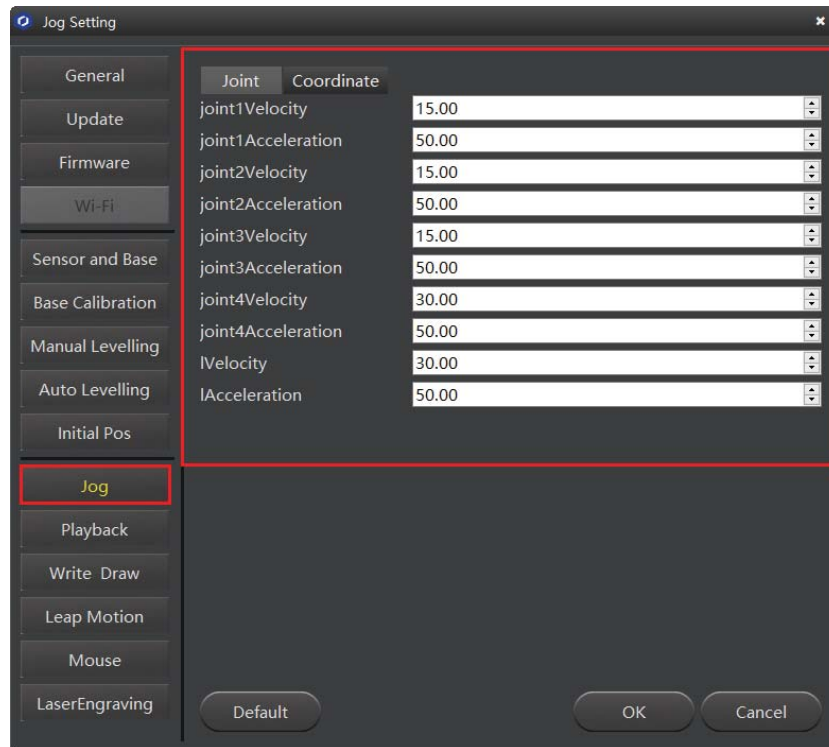

Figure 5.27 Adjust the jogging speed

NOTICE

Regarding the jogging speed and acceleration in the Joint coordinate system and Cartesian coordinate system, we recommend that it should be less than 500mm/s if loaded and that less than 800mm/s if not loaded.

5. Jog the Dobot Magician in the Cartesian or Joint coordinate system to move the suction cup close enough to the small cube for picking-up. For example, the suction cup reaches this location called position A.
6. Select **SuctionCup** on the **Operation Panel** to turn on the air pump to pick up the small cube.
7. Set the **PauseTime** to **1** second in the Save Point area.
8. Click **+Point** to save the coordinate corresponding to the position A, as shown in Figure 5.28.

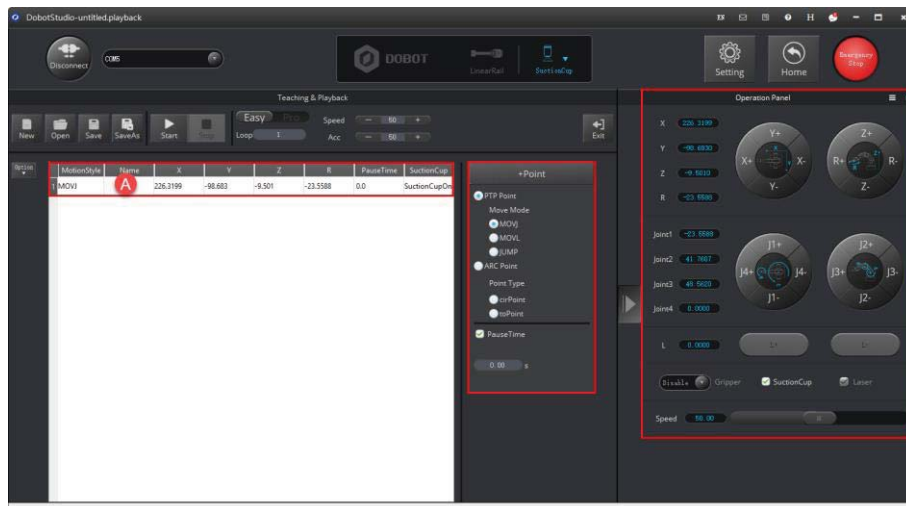

Figure 5.28 Save the start position A

Step 4 Save the end point B.

1. Select the **JUMP** motion mode in the Save Point area.

NOTE

To change the jogging speed percentage, drag the speed slider.

2. Set the lifting height (**JumpHeight**) and the maximum lifting height (**Z Limit**) by selecting **Setting > Playback > JumpParam**, as shown in Figure 5.29.

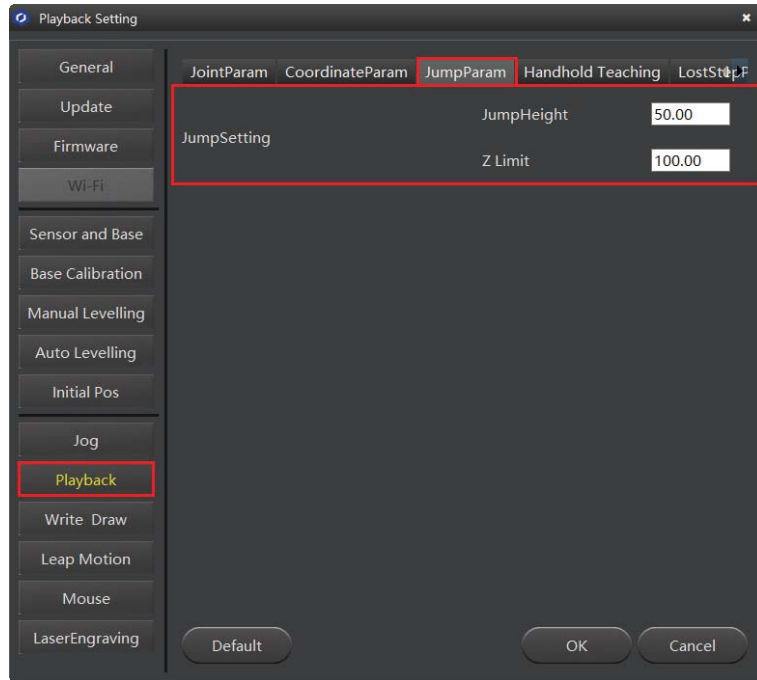

Figure 5.29 Jump parameters

3. Jogging the Dobot Magician in the Cartesian or Joint coordinate system to move the small cube to the end position B as required.
4. Unselect **SuctionCup** to turn off the air pump to release the small cube.
5. Click **+Point** to save the coordinate corresponding to the position B, as shown in Figure 5.30.

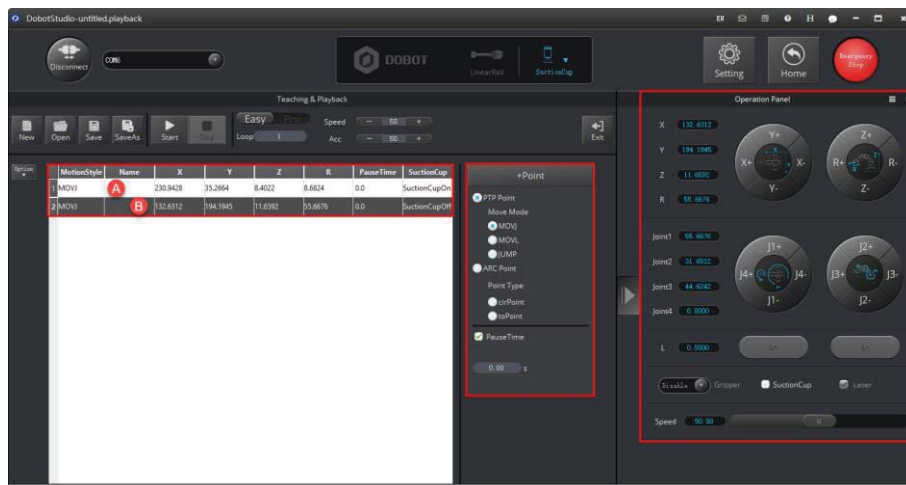

Figure 5.30 Save the end position B

Step 5 Set the percentage of both speed and acceleration for playback, for example, 50.

NOTE

To change the speed and acceleration of playback, select **Setting > Playback >**

JointParam/CoordinateParm to adjust the speed and acceleration of the Cartesian or Joint coordinate system, as shown in Figure 5.31. For details, see Table 5.10.

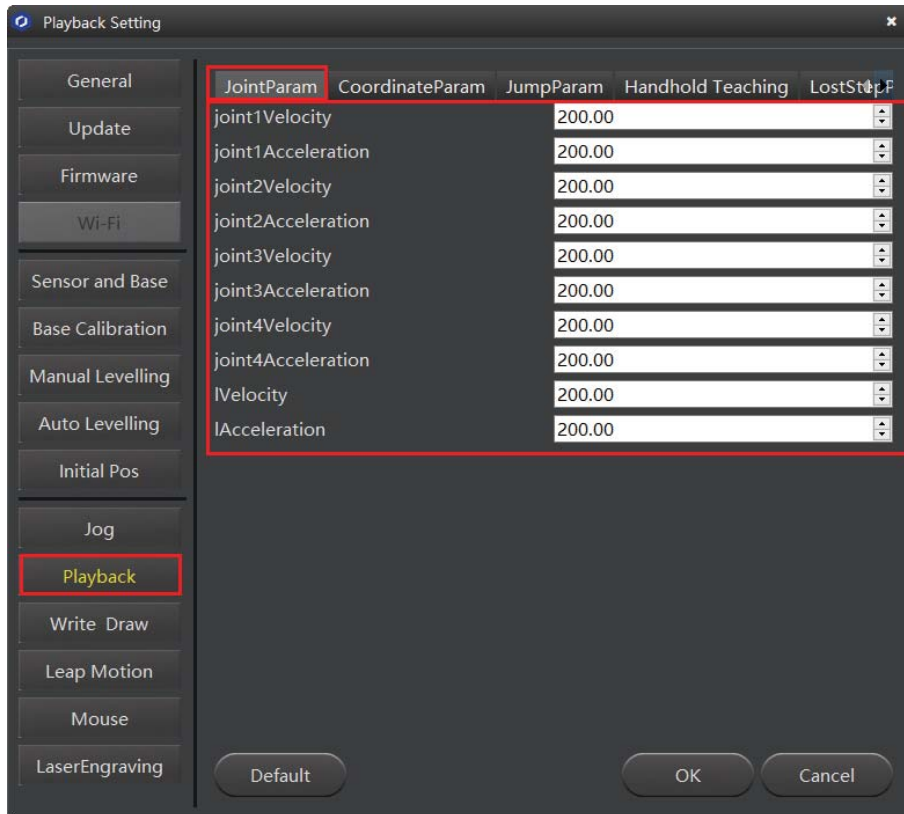



Figure 5.31 Set the speed and acceleration of the playback

Table 5.10 Set the Playback

Items	Description
JointParam	Set the speed and acceleration of the joints
CoordinateParam	Set the speed and acceleration in the Cartesian coordinate system
JumpParam	Set the Jump height and Z limit, which are required in the JUMP motion mode
Handhold Teaching	Enable or disable the handhold teaching. Automatically save a point when releasing the unlock button  or pressing this button
LostStepParam	Set the lost-step checking threshold

 NOTICE

We recommend that the motion range of Joint 1 should be 60° to -90° , the motion range of Joint 2 should be 0° to 85° , the motion range of Joint 3 is -5° to 85° , and the motion range of Joint 4 is -90° to 90° .

Step 6 Set **Loop** to **2**.

Step 7 Place the small object back to the position A, and click **Start**. The Dobot Magician performs the sequence of JUMP trajectory as taught from its memory system, moving the small cube from positions A through B.

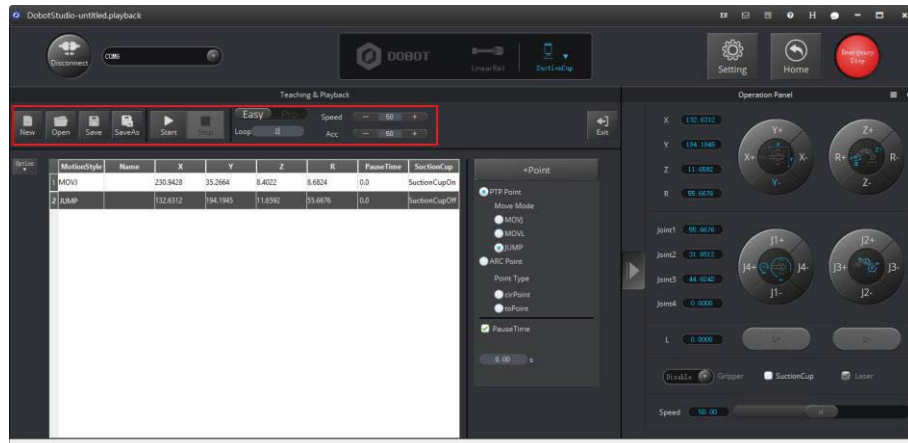

Figure 5.32 Move the small cube in the JUMP motion mode

5.3 Working in Offline Mode

Offline mode allows the Dobot Magician to perform the points in the Save points list previously downloaded from the DobotStudio without keeping the USB connection established.

Prerequisites

- The Dobot Magician has been powered on.
- The Dobot Magician has been connected to the DobotStudio.
- The points have been saved.

Procedure

Step 1 Click the **Easy/Pro** slider to enter the **Pro** mode on the **Teaching & Playback** page.

Step 2 Click **Download**.

The **Question** dialog box is displayed, asking if you want the Dobot Magician to automatically go back to its homing point before performing the save points in the offline mode, as shown in Figure 5.33.

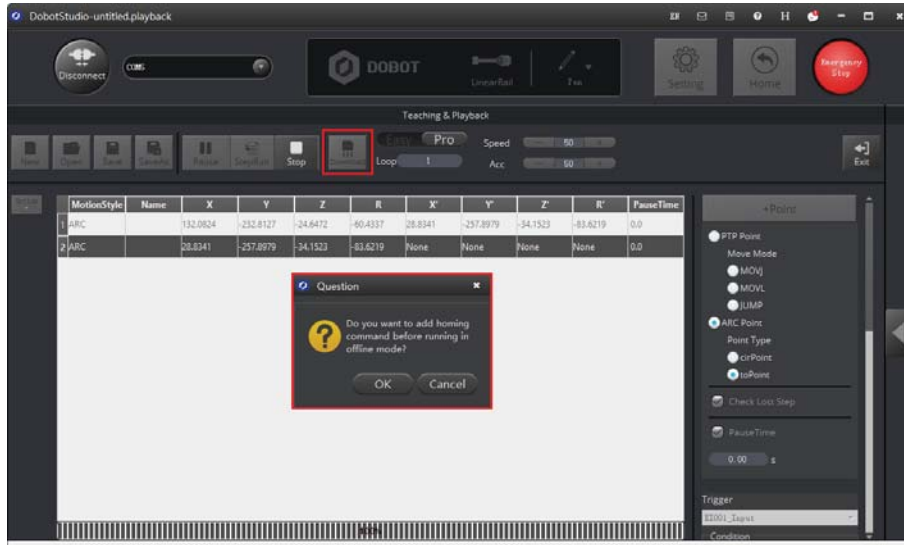

Figure 5.33 Click Download

Step 3 Click **OK** to download the Save points list.

When the process bar at the bottom of the **DobotStudio** page shows 100% and then disappears, it means that the download is complete, as shown in Figure 5.34.



Figure 5.34 The process bar at the bottom of the **DobotStudio** page

Step 4 Disconnect the DobotStudio from the Dobot Magician or the USB cable between the robotic arm and your computer.

Step 5 Short press the **Key** button once on the base’s rear panel.

The Dobot Magician returns to its homing point and performs the downloaded saved points. To stop the robotic arm’s movement, short press the **Key** button once.

5.4 Writing and Drawing

Figure 5.35 shows the process of writing and drawing.

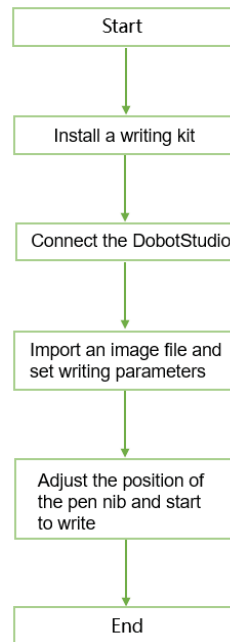

Figure 5.35 The process of writing and draw

5.4.1 Installing a Writing and drawing kit

A writing and drawing kit consists of a pen and a pen holder. For detailed steps, see below.

Step 1 Install a pen in the pen holder.

Step 2 Fasten the writing and drawing kit to the Dobot Magician's end with a butterfly nut, as shown in Figure 5.36.

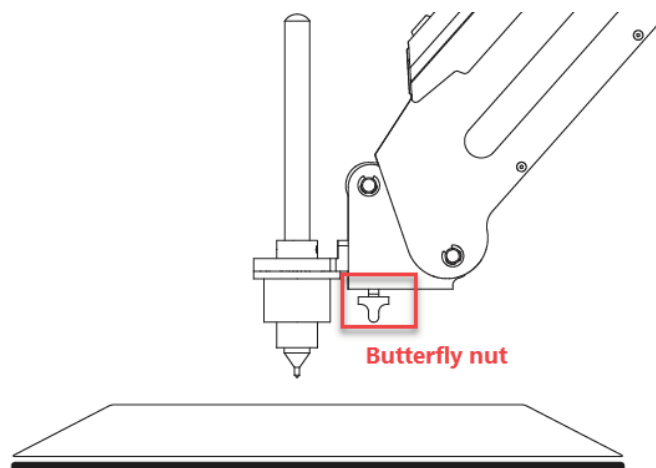

Figure 5.36 Install a writing and drawing kit

NOTE

To change to a new pen, unfasten the four M3*5 set screws in the pen holder with a 1.5mm hexagon wrench, as shown in Figure 5.37.

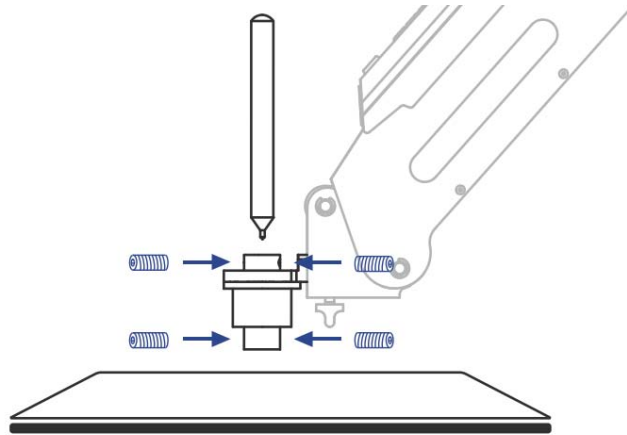

Figure 5.37 Change to a new pen

Step 3 Position a sheet of paper on the work surface within the workspace of the Dobot Magician.

5.4.2 Connecting the DobotStudio

Step 1 Launch the DobotStudio, and select the COM port, and then click **Connect**.

If the current firmware of the Dobot Magician is the 3D Printing firmware instead of the Dobot firmware, the **Select tool** dialog box is displayed, asking if you want to switch to the Dobot firmware. In this case, perform the following steps to switch to this firmware.

1. Select **DobotStudio** to upgrade the Dobot firmware, as shown in Figure 5.38.

The **Question** dialog box is displayed.

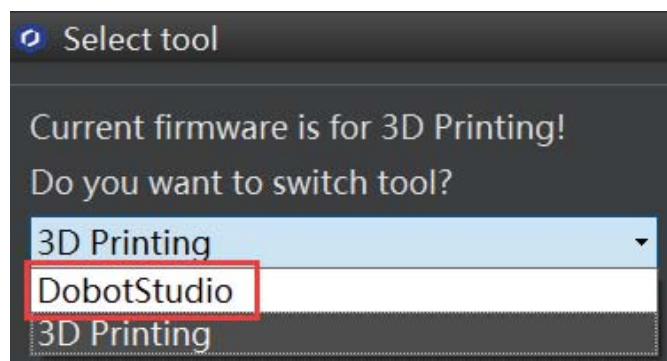

Figure 5.38 Select the DobotStudio to upgrade the Dobot firmware

2. Click **OK**, as shown in Figure 5.39.

The Dobot firmware upgrade window is displayed.

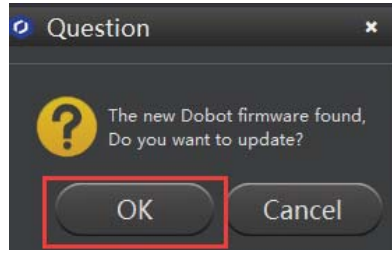

Figure 5.39 Confirm the firmware upgrade

3. Click **Confirm** to upgrade the Dobot firmware, as shown in Figure 5.40. When the upgrade process bar shows 100%, and a short beep sound is heard, it means that the firmware is upgraded successfully, as shown in Figure 5.41. In this case, the LED indicator turns from red to green. Then click **Quit** to exit.

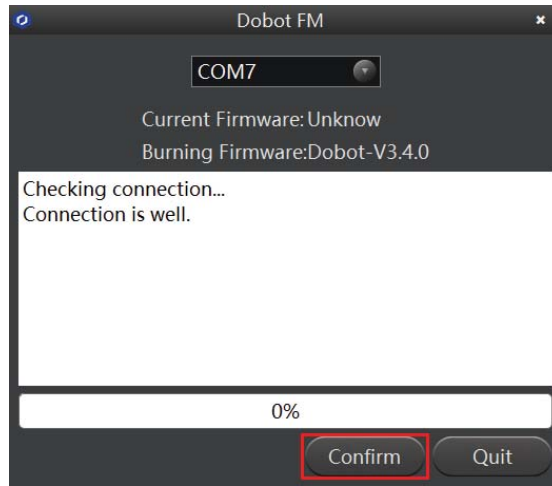

Figure 5.40 Click **Confirm**

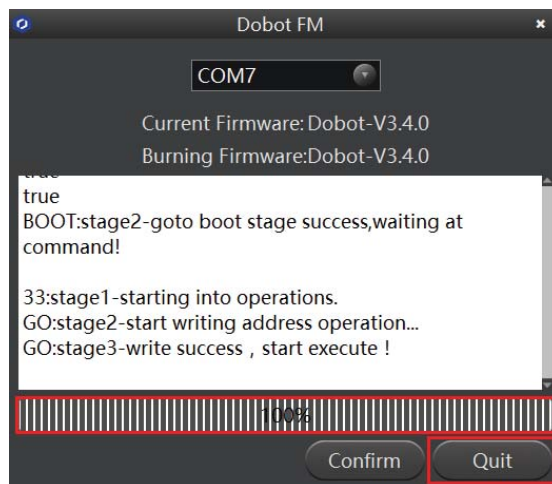

Figure 5.41 The firmware upgrade is successful

WARNING

During the firmware upgrade, do not stop it. Otherwise, errors occur.

Step 2 Click **Connect** on the **DobotStudio** page to connect the **DobotStudio** to the Dobot Magician.

Step 3 Click **Write & Draw**, as shown in Figure 5.42.



Figure 5.42 Click Write & Draw

Step 4 Choose **Pen** as the end-effector on the **Write & Draw** page, as shown in Figure 5.43.



Figure 5.43 Choose Pen as the end-effector

5.4.3 Importing Image Files and Setting Writing Parameters

When performing a write & draw task, a built-in or custom image file is required. Only a PLT or SVG image can be used. The built-in file is located in the directory *Installation Directory* \DobotStudio\config\prefab\system\source.

Prerequisites

A PLT or SVG image file has been created.

Procedure

Step 1 Click **Write & Draw** on the **DobotStudio** page, as shown in Figure 5.44.

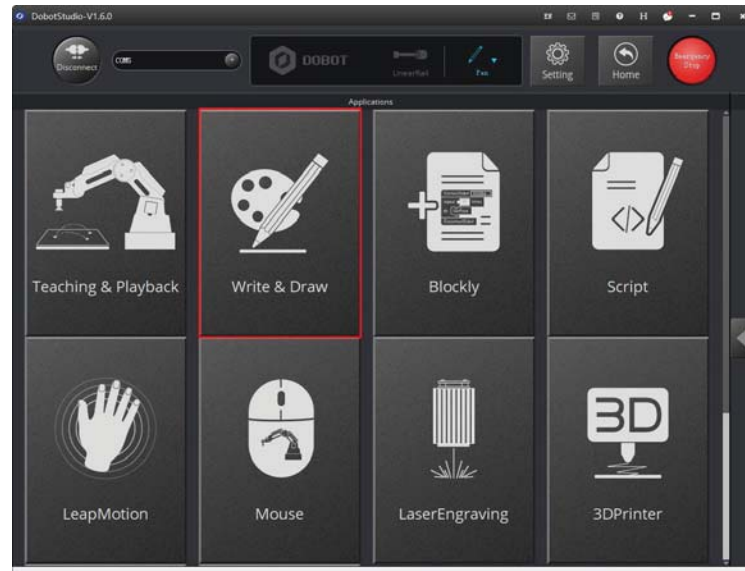

Figure 5.44 Click Write & Draw

Step 2 Import an image file using one of the following methods.

⚠ NOTICE

The imported image should be placed within the annular area on the **Write & Draw** page, as shown in Figure 5.45. If not, the robotic arm reaches its limited position and cannot draw or write. In this case, the image is highlighted with a red border, as shown in Figure 5.46.

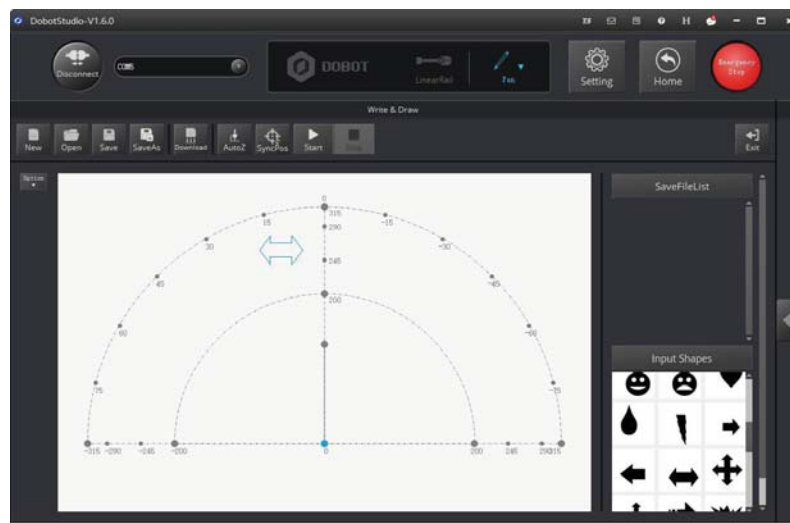

Figure 5.45 The PLT or SVG image is located within the annular area

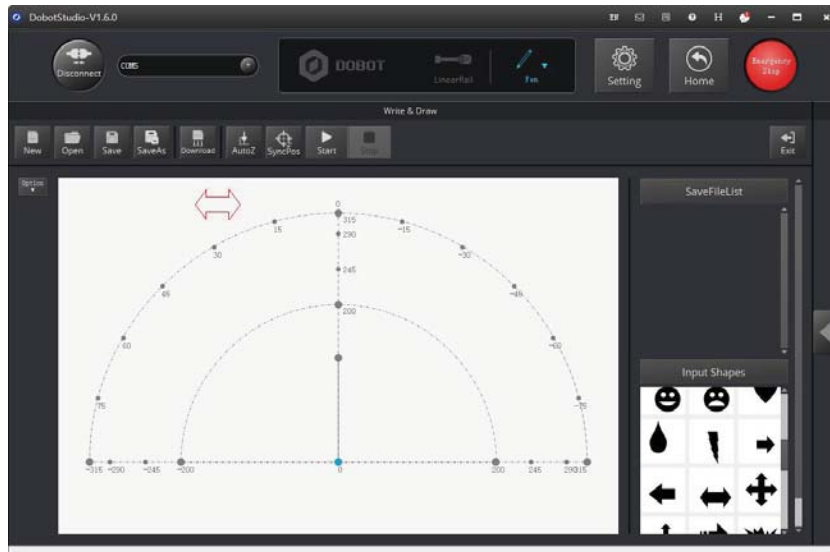

Figure 5.46 The PLT or SVG image is located outside the annular area

- Click **Open** on the **Write & Draw** page to import a built-in PLT or SVG image file from the DobotStudio installation directory **InstallatonDirectory\DobotStudio\config\prefab\system\source**, as shown in Figure 5.47. You can also import your custom PLT or SVG image file.

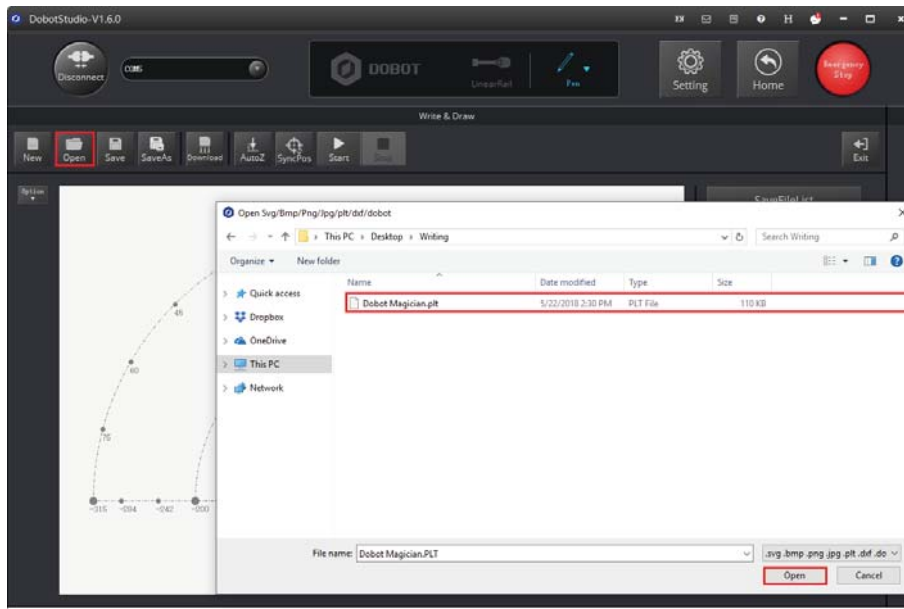

Figure 5.47 Open a PLT or SVG system image file

- Click a shape in the **Input Shapes** area, as shown in Figure 5.48.

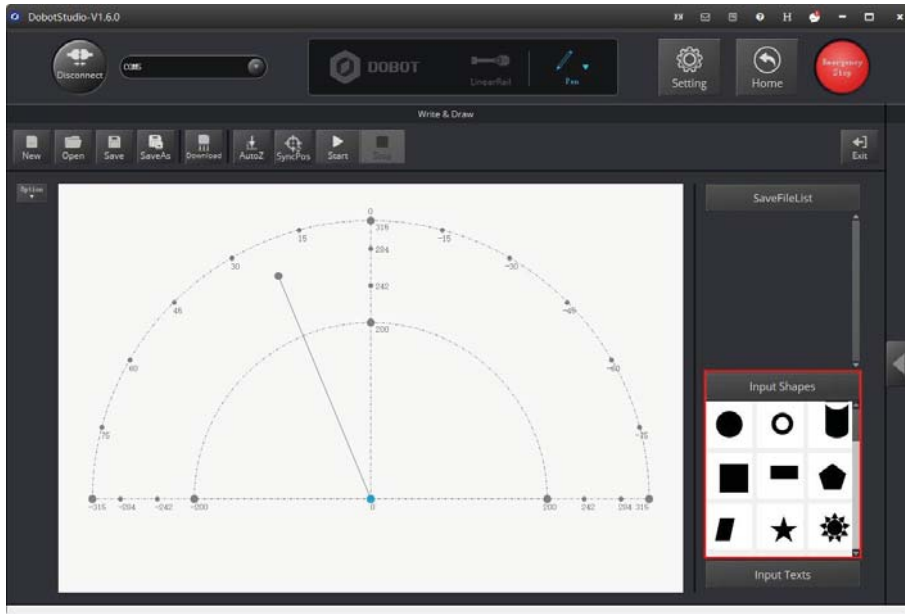

Figure 5.48 Insert a system image file

- Click **Input Texts** on the **Write & Draw** page to input texts, and set its style, and then click **OK** to display the text on the annular area, as shown in Figure 5.49.

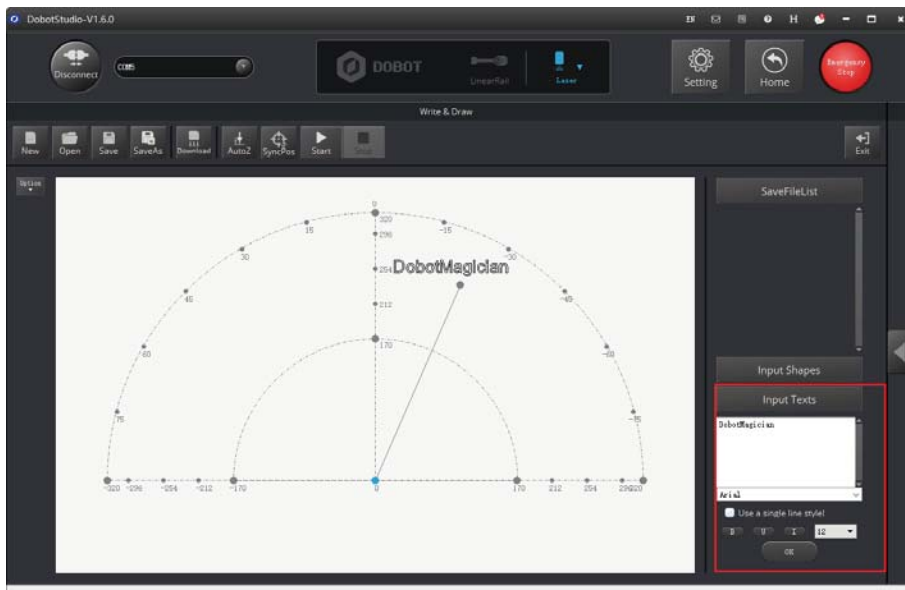

Figure 5.49 Input text

- Click **Open** to import an image file such as BMP, JPEG, or PNG to convert this image to its corresponding SVG file that the DobotStudio supports, as shown in Figure 5.50. Once this image is imported, the **SVG Converter** dialog box is displayed, as shown in Figure 5.51. In this dialog box, drag the slider to set the black and white threshold, and click

Convert **Bitmap To SVG** to perform the conversion, and then click **Plot to Main Scene** to display the converted SVG file on the annular area of the **Write & Draw** page.

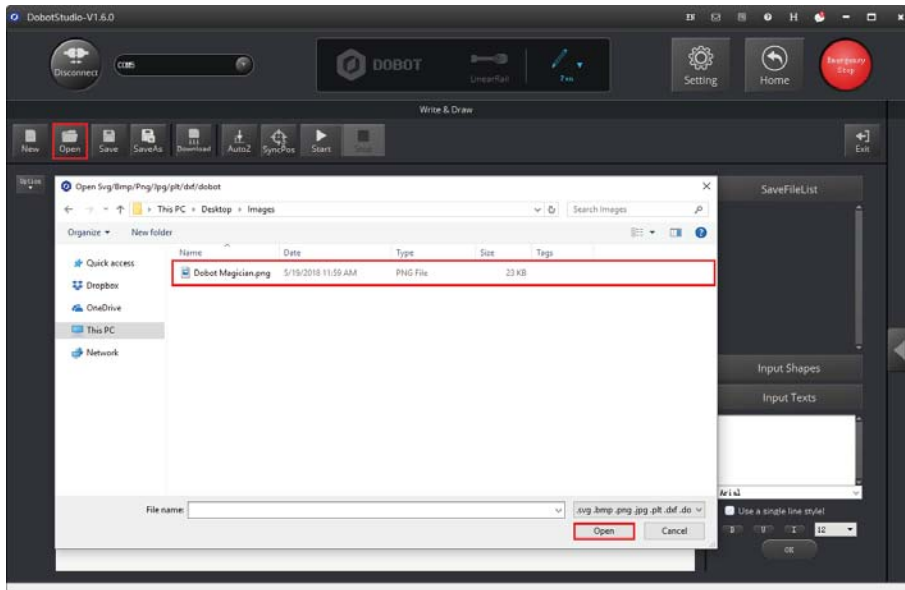

Figure 5.50 Import an image

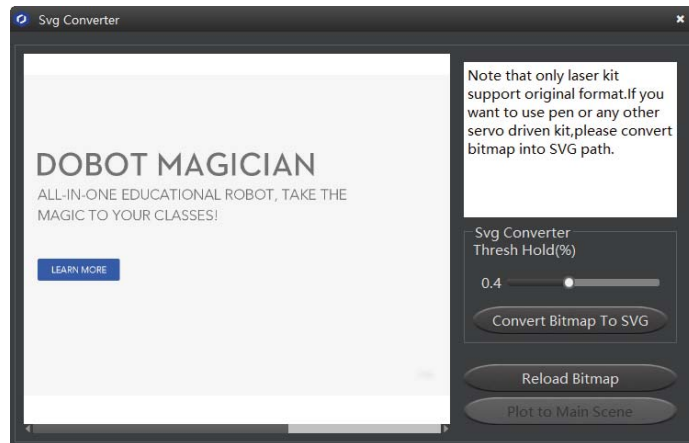

Figure 5.51 Convert an image to SVG

Step 3 Set the writing parameters.

1. Click **Setting** on the **Write & Draw** page, as shown in Figure 5.52.

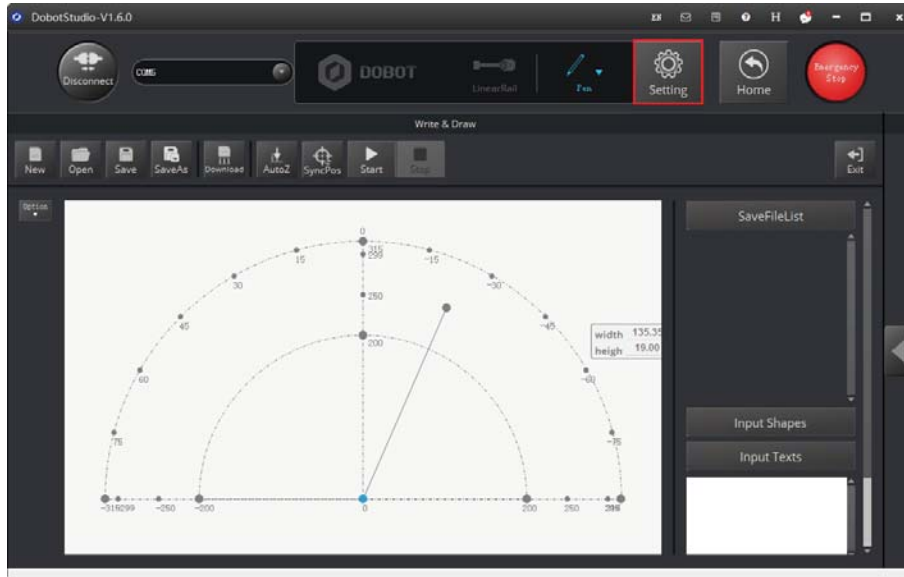

Figure 5.52 Click Setting

2. Click **Write & Draw** to set the Dobot Magician's **Velocity** (mm/s), junction velocity (**JunctionVel**: mm/s), **PlanAcc** (mm/s²), acceleration (**Acc**: mm/s²), **PenUpOffset** (mm), **PenDown** (mm), as shown in Figure 5.53.

NOTE

We recommend to set the Velocity in the range of 0mm/s to 500mm/s and to adjust the acceleration between 0mm/s² and 500mm/s².

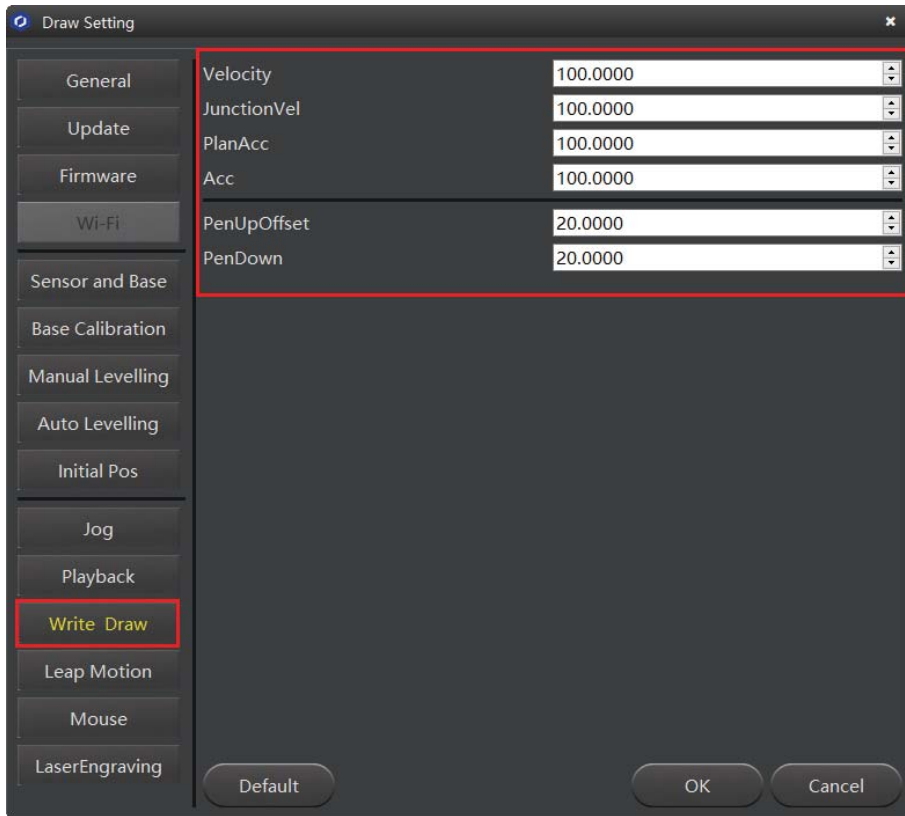



Figure 5.53 Setting the parameters of the Write & Draw function

5.4.4 Adjust the Position of the Pen Nib

Procedure

- Step 1** Raise and lower the position of the pen nib.

Press and hold the unlock button  on the Forearm to move the Dobot Magician to raise and lower the pen nib until it slightly squeezes the paper. You can also jog the robotic arm in the Cartesian or Joint coordinate system to slowly pull the Z axis down to a suitable vertical position for writing, as shown in Figure 5.54.

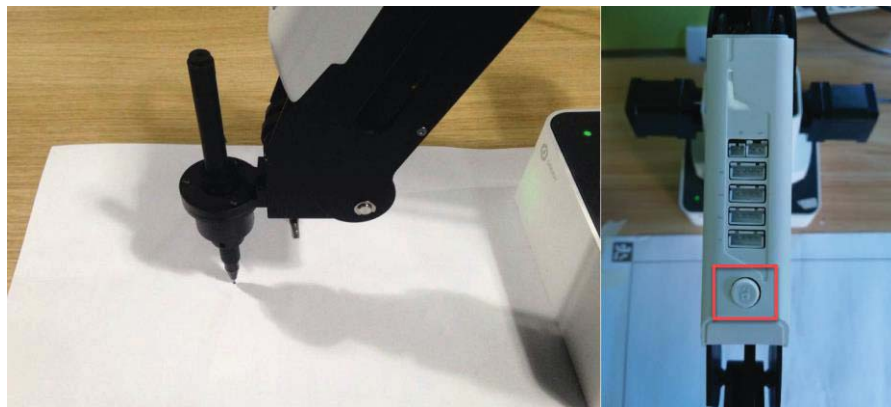

Figure 5.54 Adjust the position of the pen nib

NOTE

The point marked by a red box, as shown in Figure 5.55, corresponds to the position of the writing and drawing kit of the Dobot Magician. This point changes its position only within the annular area when the robotic arm moves.

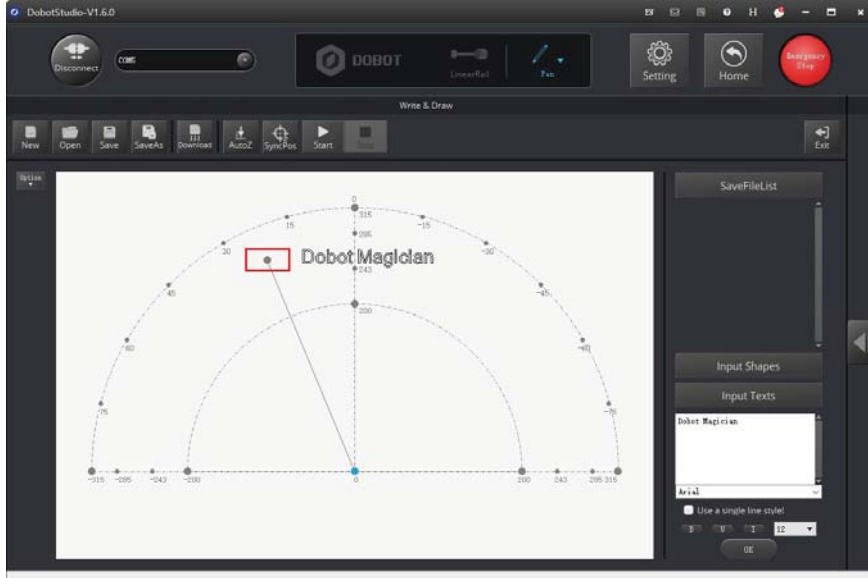

Figure 5.55 The point corresponding to the laser kit of the robotic arm

Step 2 Click **AutoZ** on the **Write & Draw** page to obtain and save the current value of the Z axis.

Once this step is complete, the next time you start to write, directly import a PLT or SVG image file without adjusting the position of the pen nib, and click **SyncPos**, and then click **Start** to start writing on the paper, as shown in Figure 5.56.

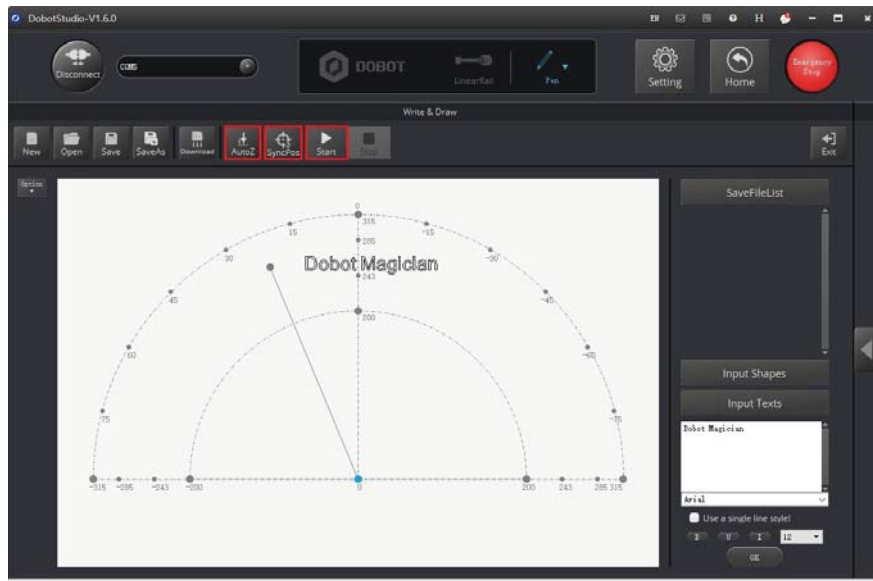

Figure 5.56 Lock the height of writing

NOTE

The value of the Z axis is the **PenDown** parameter. This parameter can be set by selecting **Setting > Write Draw > PenDown** on the **Write & Draw** page, as shown in Figure 5.57. If the effect of writing is not satisfactory, slightly raise and lower the height of the writing and drawing kit or directly change the value of **PenDown**.

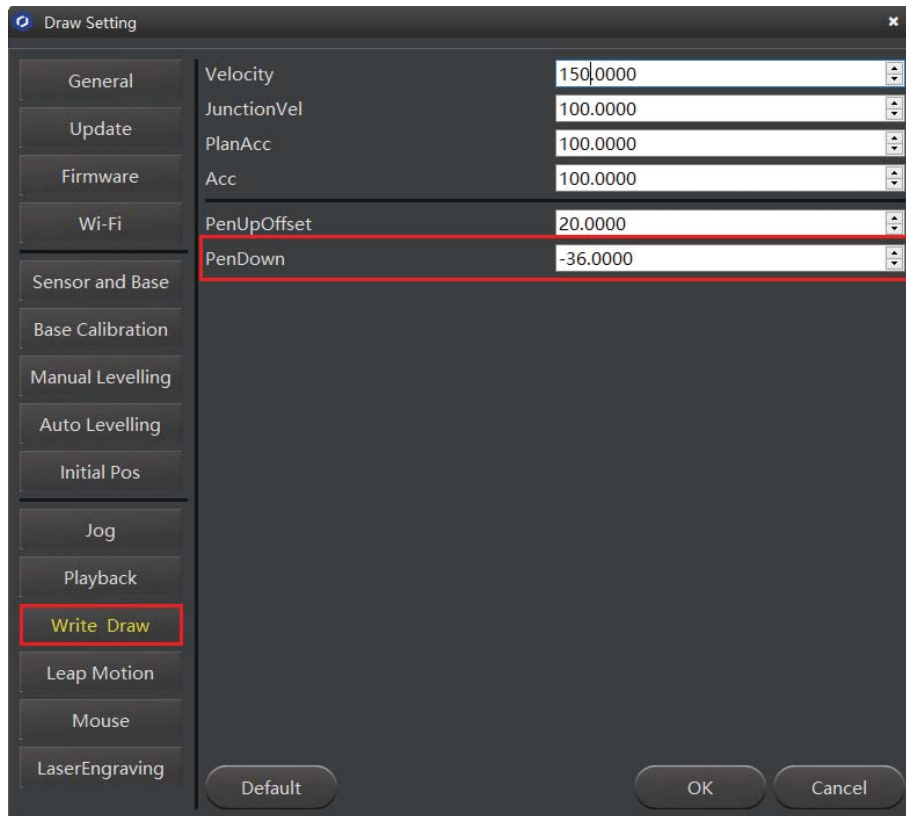

Figure 5.57 The PenDown parameter

Step 3 Click **SyncPos**.

The Dobot Magician automatically moves above the position (**PenDown**) of the start point of the text.

Step 4 Click **Start** to start writing on the paper.

When writing, click **Pause** to pause the writing and **Stop** to halt the writing.

5.5 Performing Laser Engraving Tasks

Figure 5.58 shows the process of laser engraving.

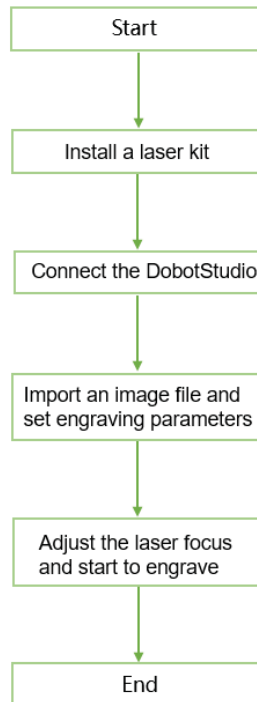

Figure 5.58 The process of laser engraving

⚠ NOTICE

The LaserEngraving is different from the grayscale engraving. The former uses the same firmware and DobotStudio function module as those of the **Write & Draw** function, and it can only engrave a vector graphics by drawing lines while the latter can engrave a grayscale image. For more information about the grayscale engraving, see [5.6 Engraving a Grayscale Image](#).

5.5.1 Installing a Laser Kit

Procedure

A laser kit includes a laser. For detailed steps, see below.

Step 1 Fasten the laser kit to the Dobot Magician's end with a butterfly nut, as shown in Figure 5.59.

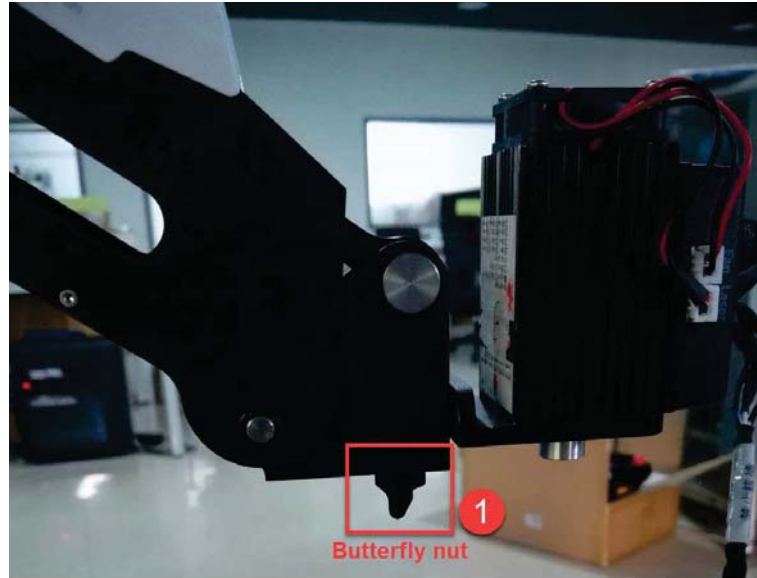

Figure 5.59 Fasten the laser with a butterfly nut

Step 2 Connect the laser's power cable to the **SW4** connector on the Forearm and the TTL control cable to the **GP5** connector, as shown in Figure 5.60.

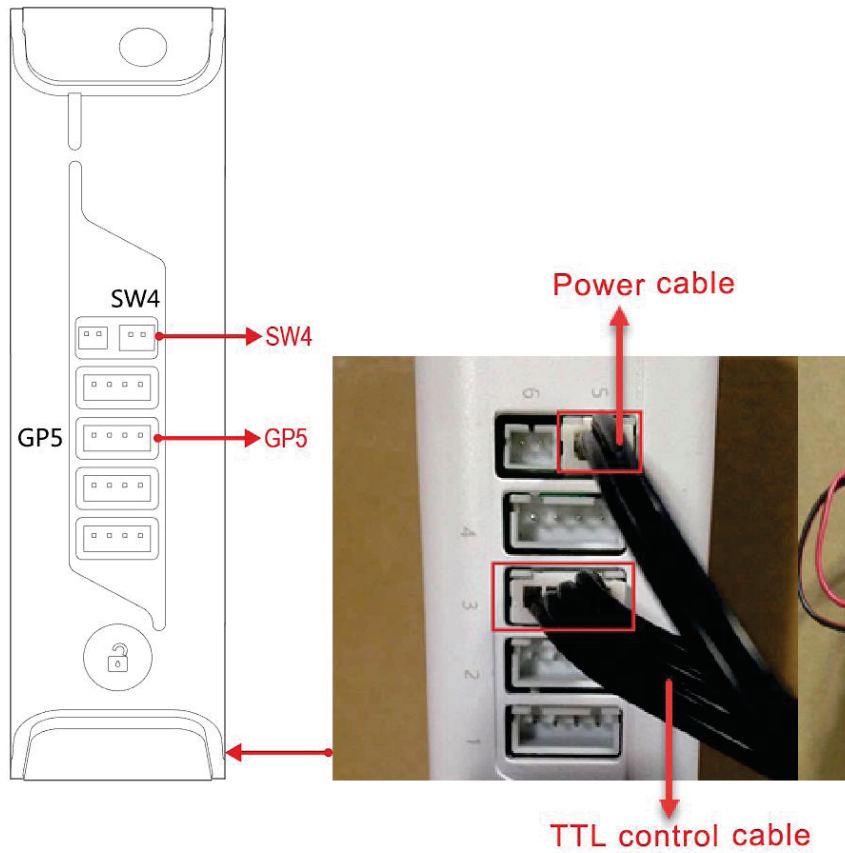

Figure 5.60 Connect the laser to the SW4 and GP5 connectors

5.5.2 Connecting the DobotStudio

Step 1 Launch the DobotStudio, and select the COM port, and then click **Connect**.

If the current firmware of the Dobot Magician is the 3D Printing firmware instead of the Dobot firmware, the **Select tool** dialog box is displayed, asking if you want to switch to the Dobot firmware. In this case, perform the following steps to switch to this firmware.

1. Select **DobotStudio** to upgrade the Dobot firmware, as shown in Figure 5.61. The **Question** dialog box is displayed.

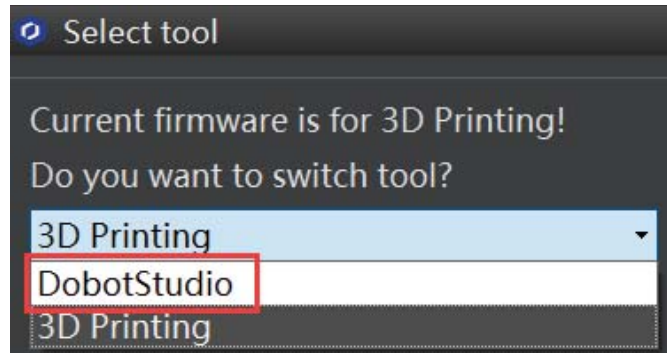

Figure 5.61 Select the DobotStudio to upgrade the Dobot firmware

2. Click **OK**, as shown in Figure 5.62.

The Dobot firmware upgrade window is displayed.

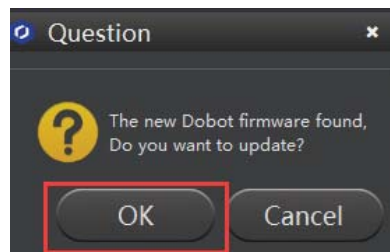

Figure 5.62 Confirm the firmware upgrade

3. Click **Confirm** to upgrade the Dobot firmware, as shown in Figure 5.63. When the upgrade process bar shows 100% and a short beep sound is heard, it means that the firmware is upgraded successfully, as shown in Figure 5.64. In this case, the LED indicator turns from red to green. Then click **Quit** to exit.

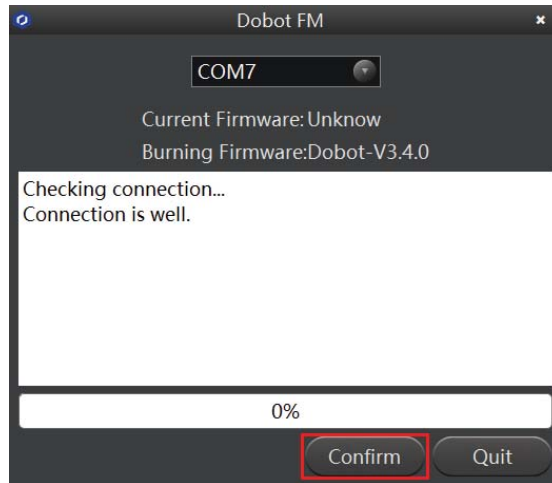

Figure 5.63 Click **Confirm**

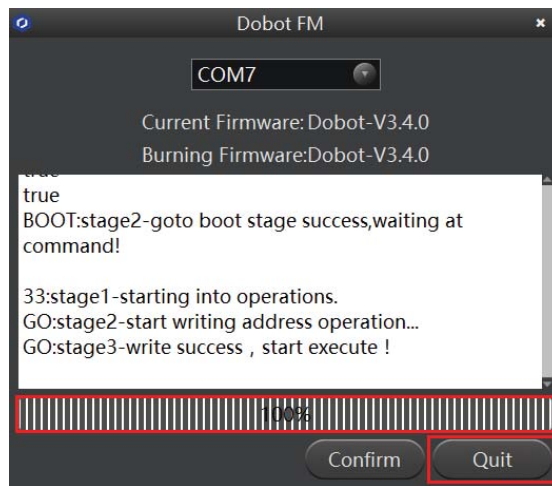

Figure 5.64 The firmware upgrade is successful

 **WARNING**

During the firmware upgrade, do not stop it. Otherwise, errors occur.

- Step 2** Click **Connect** on the **DobotStudio** page to connect the DobotStudio to the Dobot Magician.
- Step 3** Click **Write & Draw** module function, as shown in Figure 5.65.

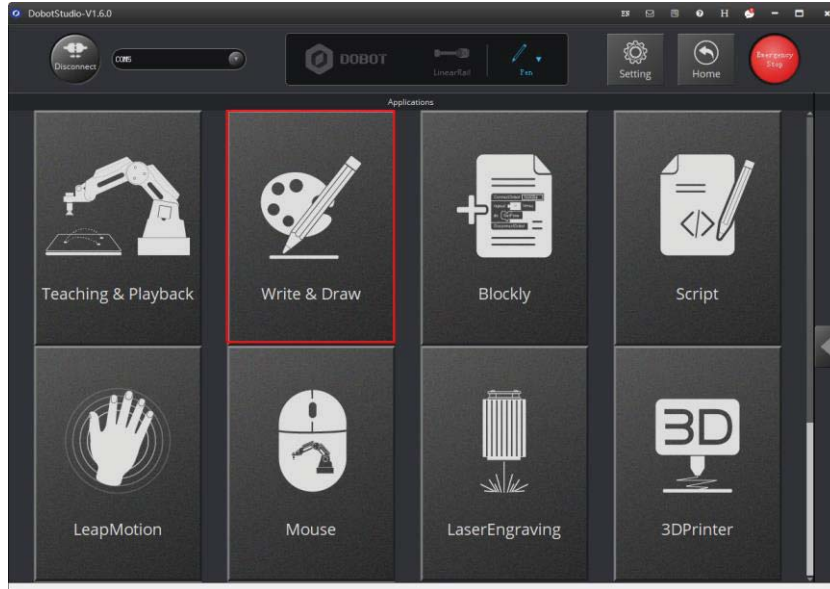

Figure 5.65 Click Write & Draw

Step 4 Choose **Laser** as the end-effector, as shown in Figure 5.66.



Figure 5.66 Choose Laser as the end-effector

5.5.3 Importing Image Files and Setting Engraving Parameters

When performing a laser-engraving task, a built-in or a custom image file is required. Only a PLT or SVG image can be used. The built-in image file is located in the directory *Installation Directory*\DobotStudio\config\prefab\system\source.

Prerequisites

A PLT or SVG image file has been created.

Procedure

Step 1 Click **Write & Draw** on the **DobotStudio** page, as shown in Figure 5.67.

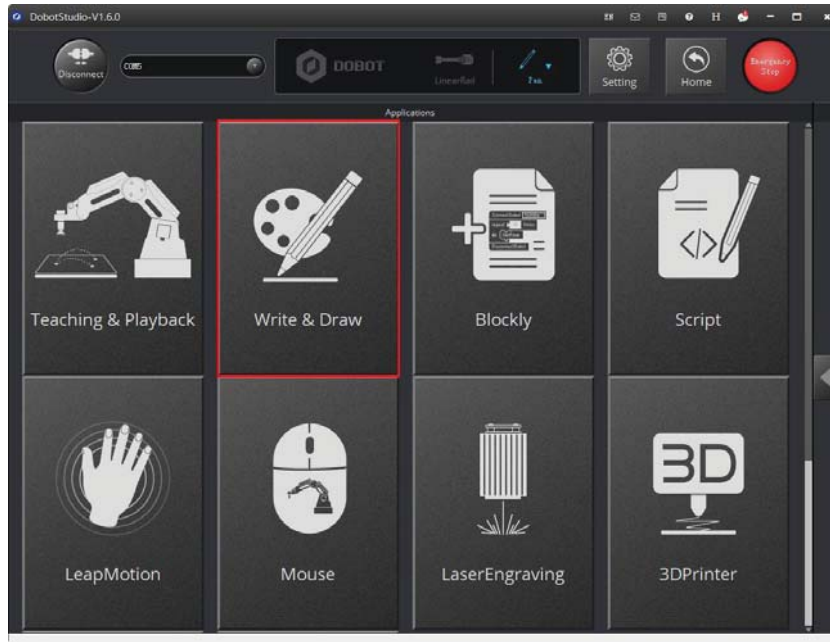

Figure 5.67 Click Write & Draw

Step 2 Import an image file using one of the following methods.

NOTICE

The imported image should be placed within the annular area on the **Write & Draw** page, as shown in Figure 5.68. If not, the robotic arm reaches its limited position and thus cannot engrave on an object. In this case, the image is highlighted with a red border, as shown in Figure 5.69.

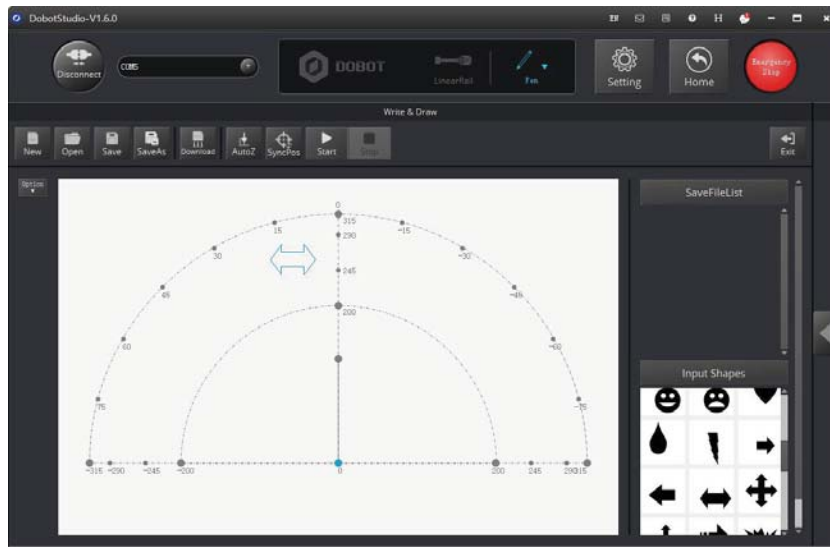

Figure 5.68 The PLT or SVG image is located within the annular area

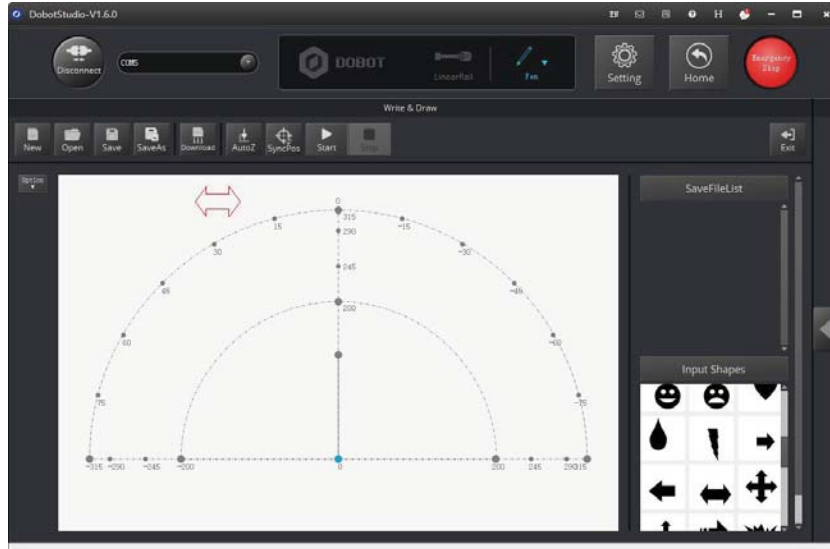

Figure 5.69 The PLT or SVG image is located outside the annular area

- Click **Open** on the **Write & Draw** page to import a built-in PLT or SVG image file from the DobotStudio installation directory *InstallationDirectory\DobotStudio\config\prefab\system\source*, as shown in Figure 5.70. You can also import your custom PLT or SVG image file.

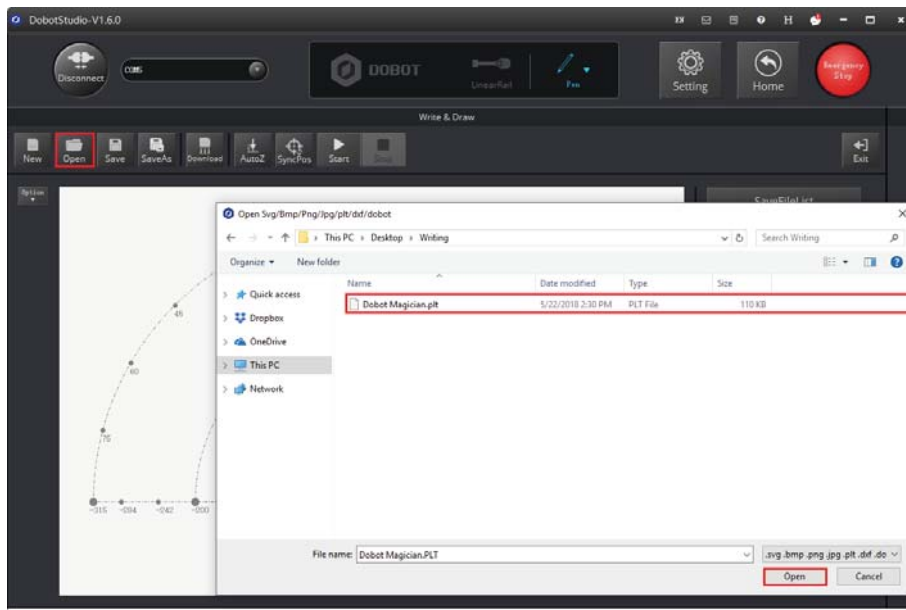

Figure 5.70 Open a PLT or SVG file

- Click a shape in the **Input Shapes** area to directly import a system image file, as shown in Figure 5.71.

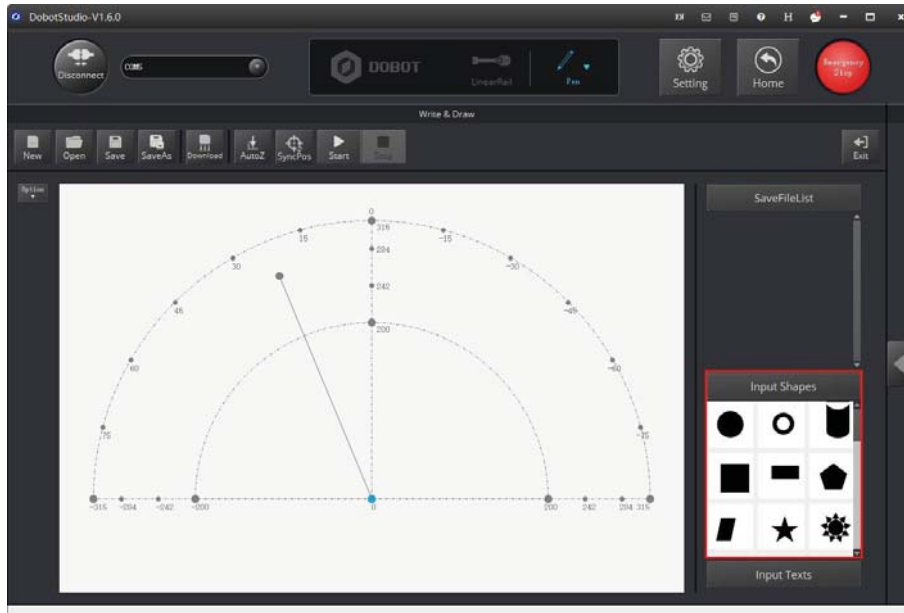

Figure 5.71 Insert a system image file

- Click **Input Texts** on the **Write & Draw** page to input texts, and set its style, and then click **OK** to display the text on the annular area, as shown in Figure 5.72.

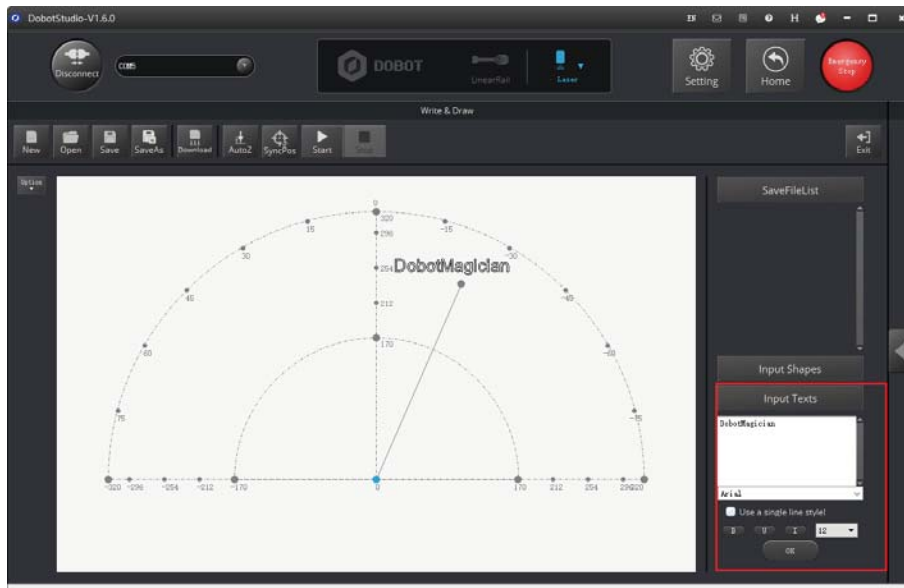

Figure 5.72 Input text

- Click **Open** to import an image file such as BMP, JPEG, or PNG to convert this image to its corresponding SVG file that the DobotStudio supports, as shown in Figure 5.73. Once this image is imported, the **SVG Converter** dialog box is displayed, as shown in Figure 5.74. In this dialog box, drag the slider to set the black and white threshold, and click **Convert Bitmap To SVG** to perform the conversion, and then click **Plot to Main Scene**

to display the converted SVG file on the annular area of the **Write & Draw** page.

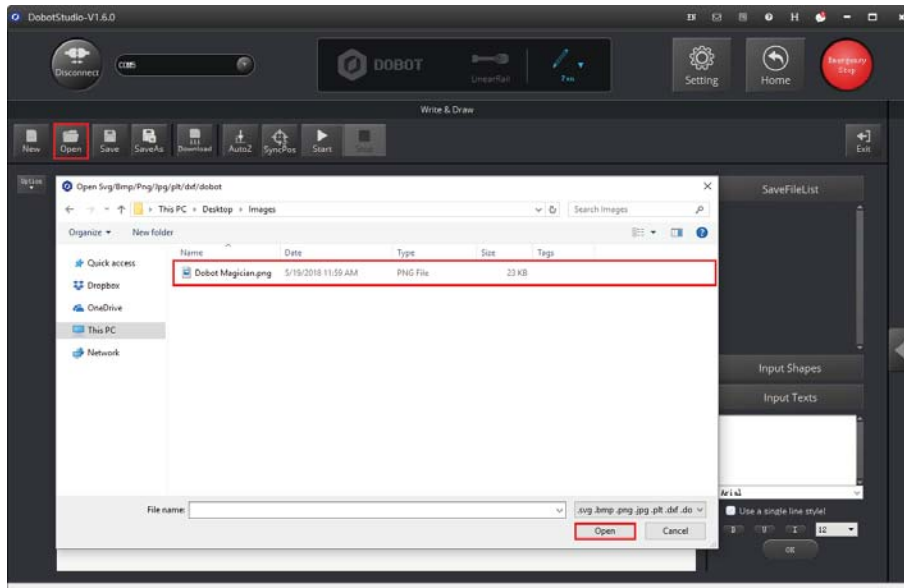

Figure 5.73 Import an image file

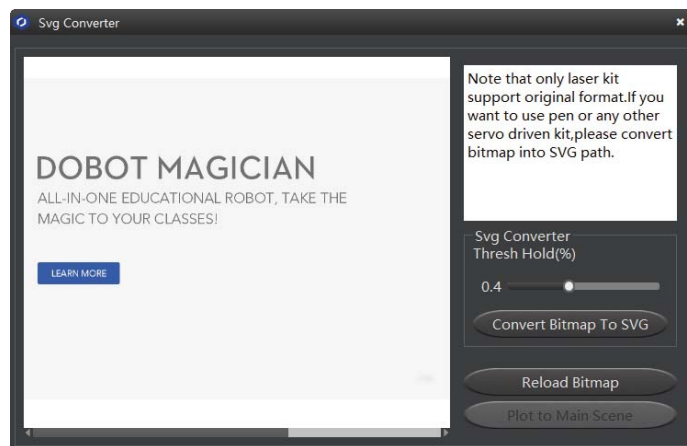

Figure 5.74 Convert Bitmap to SVG

Step 3 Set the laser-engraving's parameters.

1. Click **Setting** on the **Write & Draw** page, as shown in Figure 5.75.

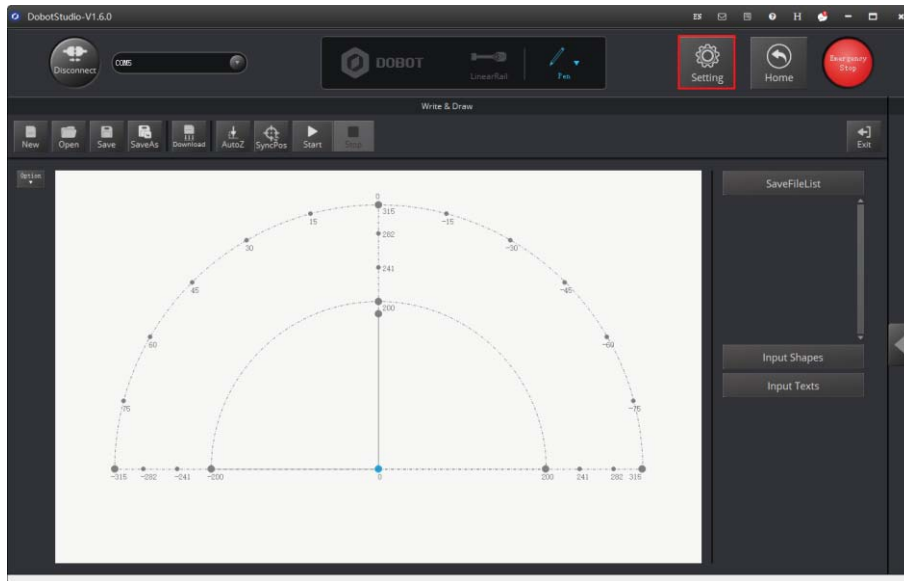

Figure 5.75 Click Setting

2. Click **Write & Draw** to set the Dobot Magician's **Velocity** (mm/s), junction velocity (**JunctionVel**: mm/s), **PlanAcc** (mm/s²), acceleration (**Acc**: mm/s²), **PenUpOffset** (mm), **PenDown** (mm), as shown in Figure 5.76.

 **NOTE**

We recommend to set the Velocity in the range of 0mm/s to 500mm/s and to adjust the acceleration between 0mm/s² and 500mm/s².

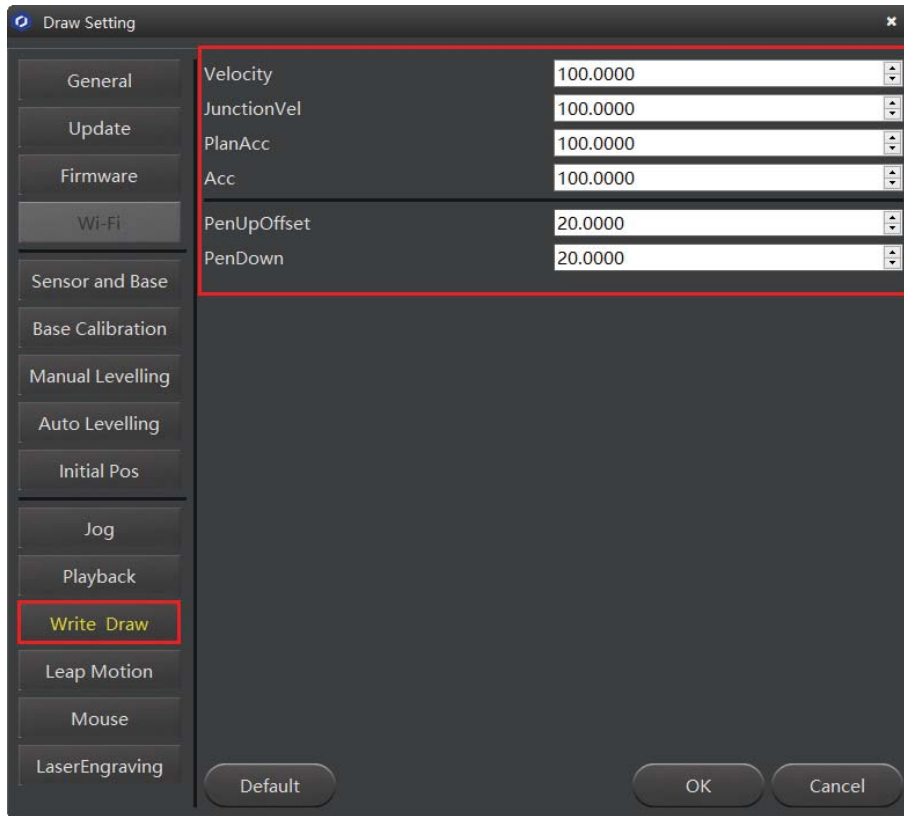

Figure 5.76 Setting the parameters of the Write & Draw function

5.5.4 Adjust the Laser Focus and Start to Grave

Procedure

Step 1 Choose **Laser** as the end-effector on the **Write & Draw** page, as shown in Figure 5.77.



Figure 5.77 Choose Laser as the end-effector



Step 2 Click  to display the **Operation Panel**, and then select **Laser** to turn on the laser, as shown in Figure 5.78. In this case, the laser gives out a laser beam.



Figure 5.78 Turn on the laser

⚠ Danger

- When using a laser, wear lasing protective eyeglass.
- Never aim the laser at a person's eye and clothes or stare at the laser from within the beam.
- In the central laser focus, a high temperature heat is created and can burn materials such as papers and wooden boards.
- Never aim the laser at a person and their clothes.
- Do not allow the children to play with the Dobot Magician. Monitor the robotic arm while it is running and power off it once the movement is complete.

Step 3 Press and hold the unlock button  on the Forearm to move the robotic arm to raise and lower the height of the laser kit until the laser is the brightest with a smallest possible spot size. When the laser power level is high enough, the laser beam can burn and cut the paper. After getting a pretty good focus, unselect **Laser** on the **Operation Panel** page to turn off the laser, as shown in Figure 5.79.