



Figure 5.79 Unselect the Laser

NOTICE

- If you cannot set the laser to be at its minimum focus, it's probably because the focal length is long. To shorten the focal length, slightly turn the sliver lens screw (as shown in Figure 5.80) on the bottom of the laser kit.

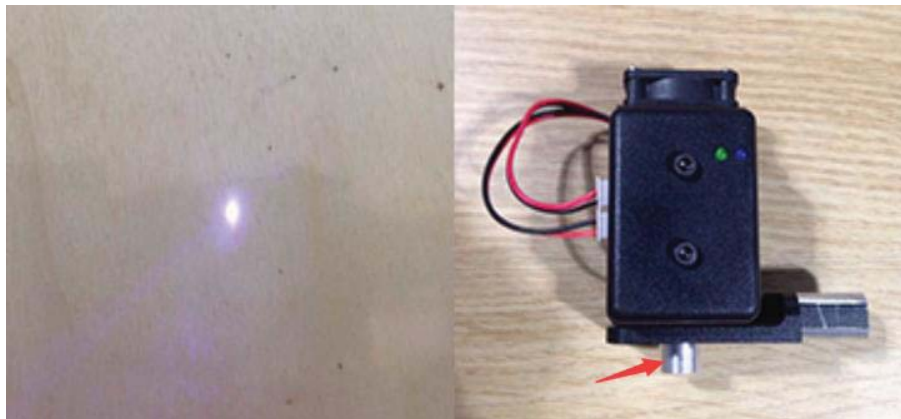

Figure 5.80 Adjust the laser focus

- The point marked by a red box, as shown in Figure 5.81, corresponds to the position of the end-effector of the Dobot Magician. This point changes its position only within the annular area when the robotic arm moves.

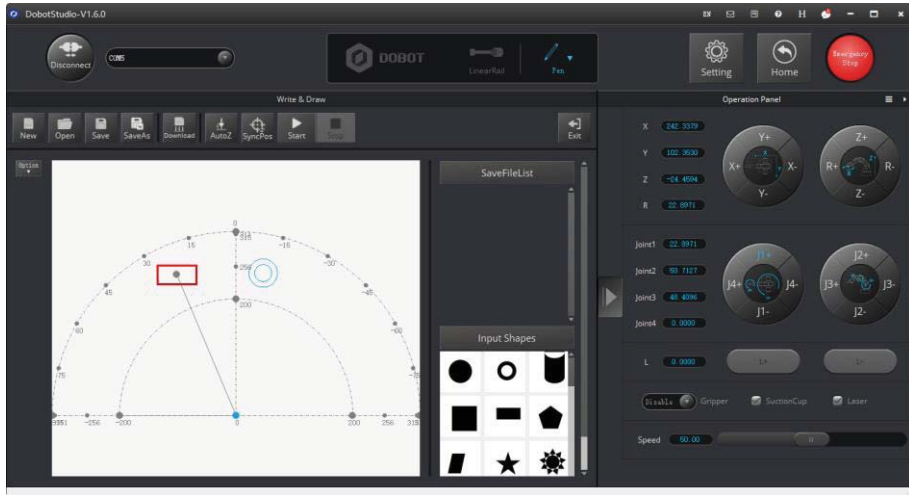

Figure 5.81 The point corresponding to the end-effector of the robotic arm

Step 4 Click **AutoZ** on the **Write & Draw** page to obtain and save the current value of Z axis.

Once this step is complete, the next time you start to engrave, directly import a PLT or SVG image file without adjusting the position of the laser kit, and click **SyncPos**, and then click **Start** to start engraving on the paper, as shown in Figure 5.82.

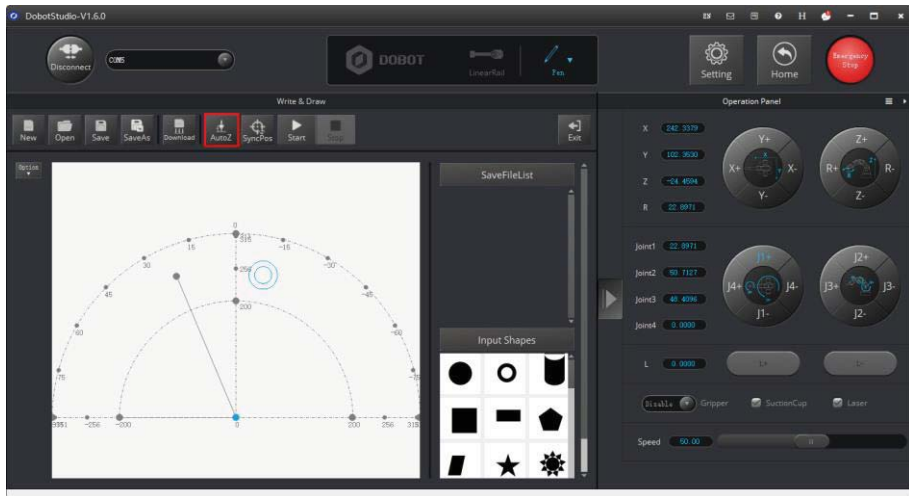

Figure 5.82 Lock the height of engraving

NOTE

The value of the Z axis is the **PenDown** parameter. This parameter can be set by selecting **Setting > Write Draw > PenDown** on the **Write & Draw** page, as shown in Figure 5.83. If the effect of engraving is not satisfactory, slightly raise and lower the height of the laser kit or directly change the value of **PenDown**.

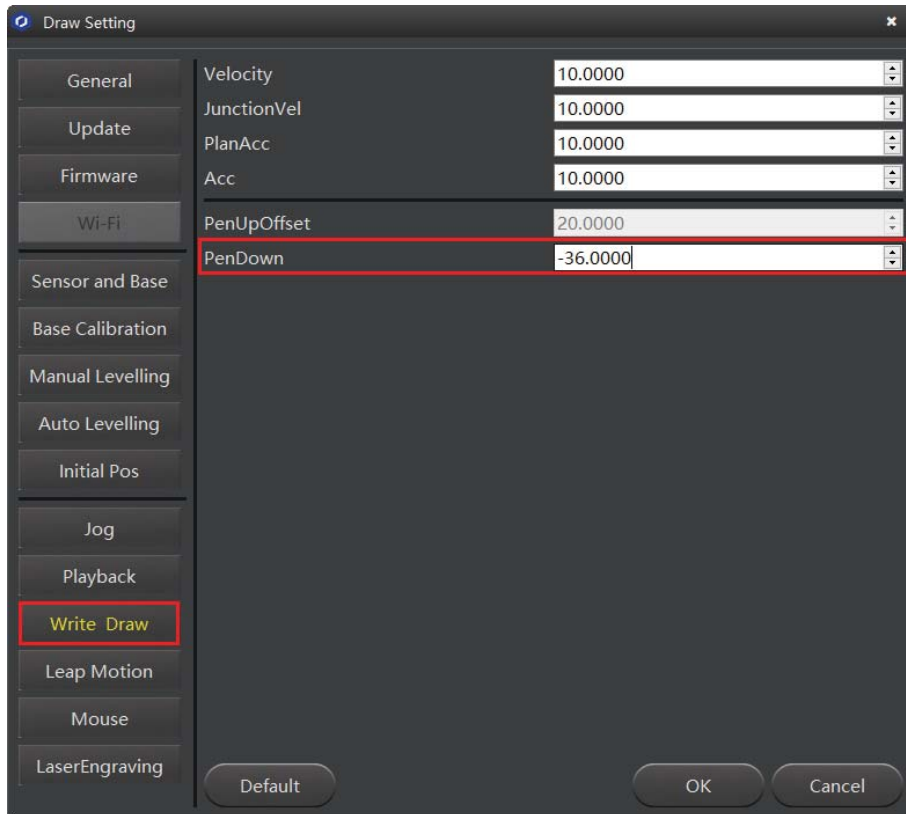

Figure 5.83 Set the PenDown parameters

Step 5 Click **SyncPos**.

The Dobot Magician automatically moves above the position (**PenUpOffset**) of the start point of the laser-engraving.

Step 6 Click **Start** to start engraving on the paper.

When engraving, click **Pause** to pause the engraving and **Stop** to halt the engraving.

Figure 5.84 shows the effect of the laser-engraving.

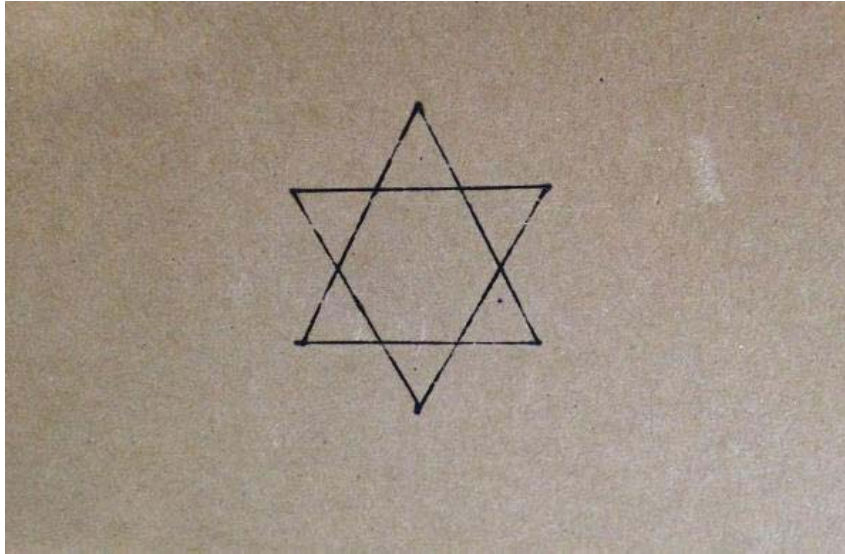

Figure 5.84 The effect of the laser-engraving

5.6 Engraving a Grayscale Image

Figure 5.85 shows the process of engraving a grayscale image.

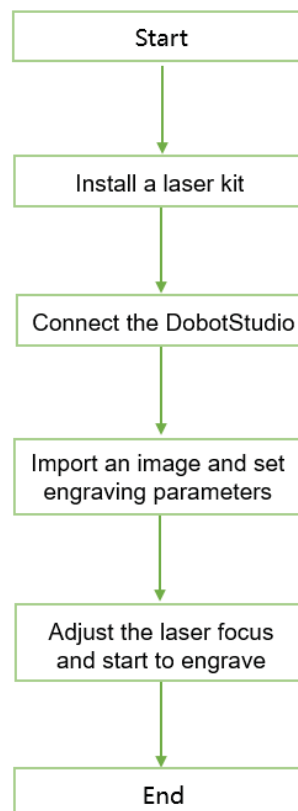

Figure 5.85 The process of engraving a grayscale image

5.6.1 Installing a Grayscale-engraving Kit

Both grayscale-engraving and laser-engraving use the laser kit as the end-effector. For the installation method, see *5.5.1 Installing a Laser Kit*.

5.6.2 Connecting the DobotStudio

Step 1 Launch the DobotStudio, and select the COM port, and then click **Connect**.

If the current firmware of the Dobot Magician is the 3D Printing firmware instead of the Dobot firmware, the **Select tool** dialog box is displayed, asking if you want to switch to the Dobot firmware. In this case, perform the following steps to switch to this firmware.

1. Select **DobotStudio** to upgrade the Dobot firmware, as shown in Figure 5.86. The **Question** dialog box is displayed.

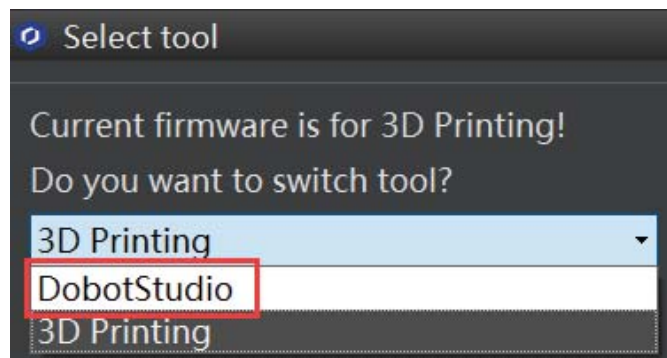

Figure 5.86 Select the DobotStudio to upgrade the Dobot firmware

2. Click **OK**, as shown in Figure 5.87.

The Dobot firmware upgrade window is displayed.

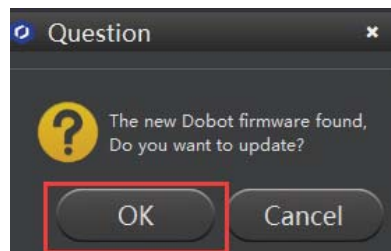

Figure 5.87 Confirm the firmware upgrade

3. Click **Confirm** to upgrade the Dobot firmware, as shown in Figure 5.88. When the upgrade process bar shows 100%, and a short beep sound is heard, it means that the firmware is upgraded successfully, as shown in Figure 5.89. In this case, the LED indicator turns from red to green. Then click **Quit** to exit.

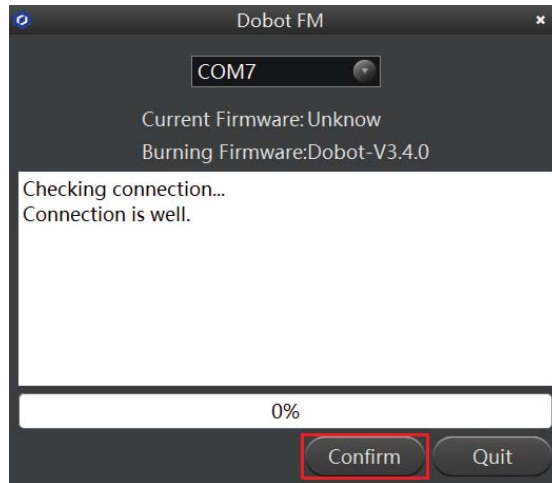

Figure 5.88 Click Confirm

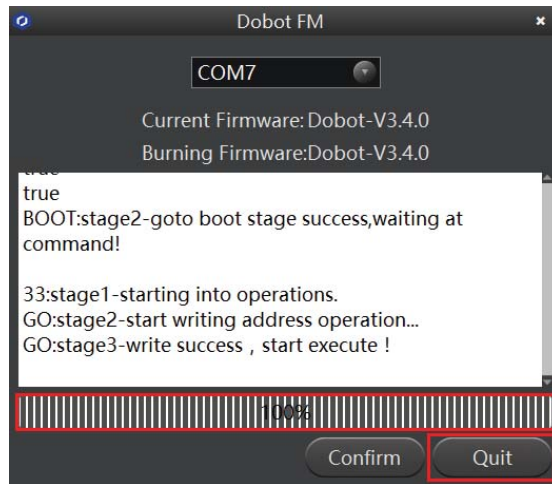

Figure 5.89 The firmware upgrade is successful

 **WARNING**

During the firmware upgrade, do not stop it. Otherwise, errors occur.

Step 2 Click **LaserEngraving**, as shown in Figure 5.90.

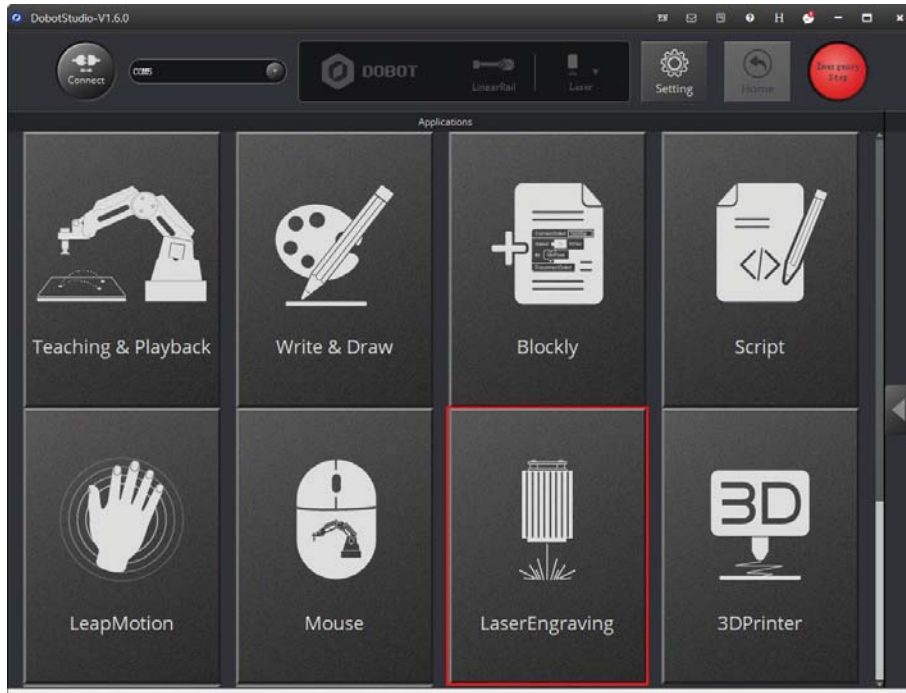

Figure 5.90 Click LaserEngraving

5.6.3 Importing Image Files and Setting Engraving Parameters

Prerequisites

An image file has been created.

Procedure

⚠ NOTICE

The imported image should be placed within the annular area on the **LaserEngraving** page, as shown in Figure 5.91. If not, the robotic arm reaches its limited position and thus cannot engrave on an object. In this case, the image is highlighted with a red border, as shown in Figure 5.92.

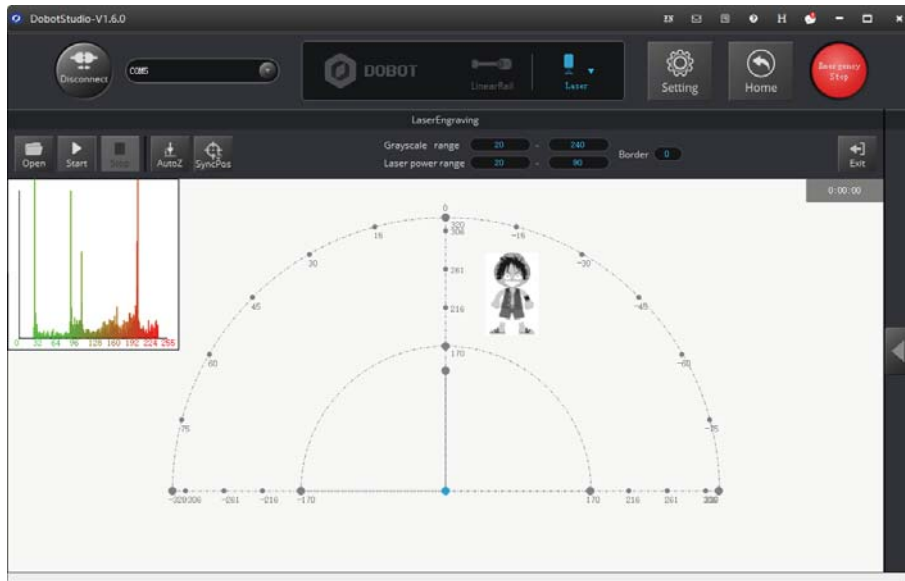

Figure 5.91 The image file is located within the annular area

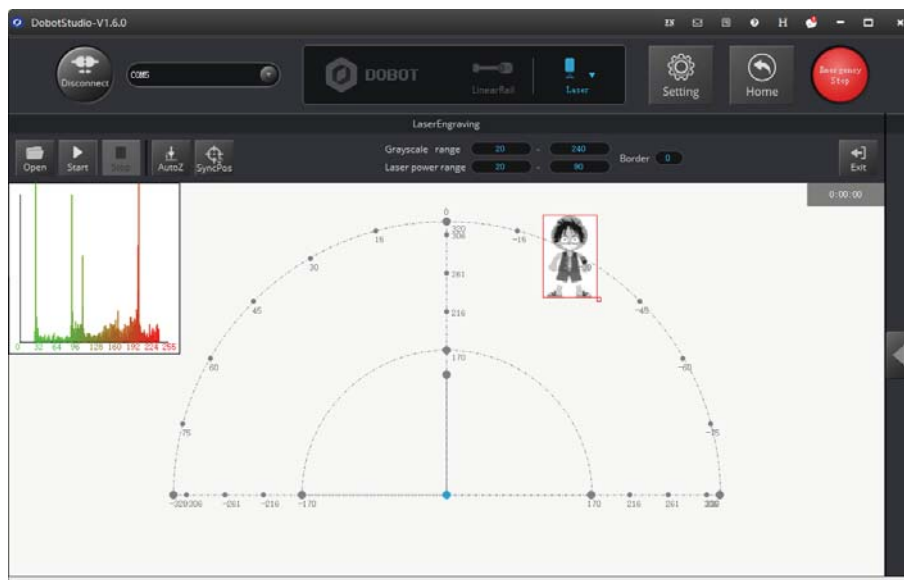

Figure 5.92 The image file is located outside the annular area

Step 1 Choose **Laser** as the end-effector on the **LaserEngraving** page, as shown in Figure 5.93.

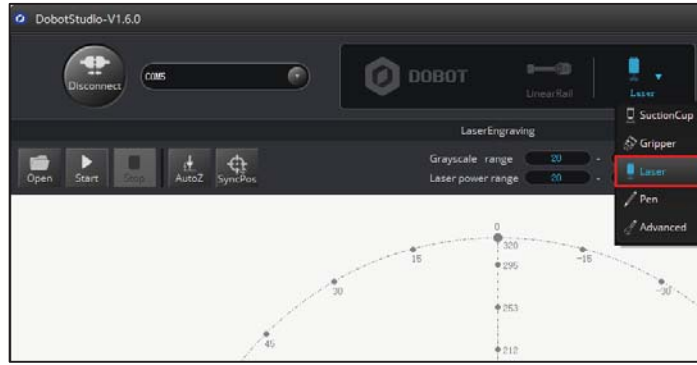

Figure 5.93 Choose Laser as the end-effector

Step 2 Click **Open** to import an image file such as BMP, JPEG, or PNG, as shown in Figure 5.94.

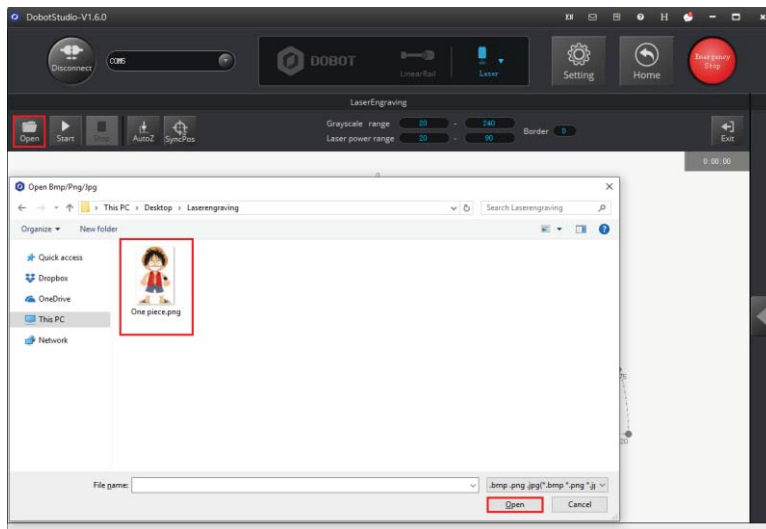

Figure 5.94 Import an image file

Step 3 Set the **Grayscale range**, **Laser power range**, and **Border**, as shown in Figure 5.95. For details, see Table 5.11.

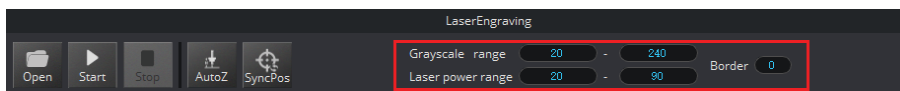

Figure 5.95 Set the grayscale range, laser power range, and border

Table 5.11 Laser engraving parameters

Items	Description
Grayscale range	Set the grayscale range

Items	Description
	Range: 0 - 255 Default value: 20 - 240
Laser power range	Set the laser power range Range: 2 - 100 Default value: 20 - 90
Border	Set the border width. Unit: pixel Range: 0 - 50 Default value: 4

Step 4 Set the laser-engraving parameters.

1. Click **Setting** on the **LaserEngraving** page.
2. Set the **JunctionVel** (junction velocity), **PlanAcc** (linear acceleration), and **Acc** (**acceleration**), for example, set all to 5, as shown in Figure 5.96.

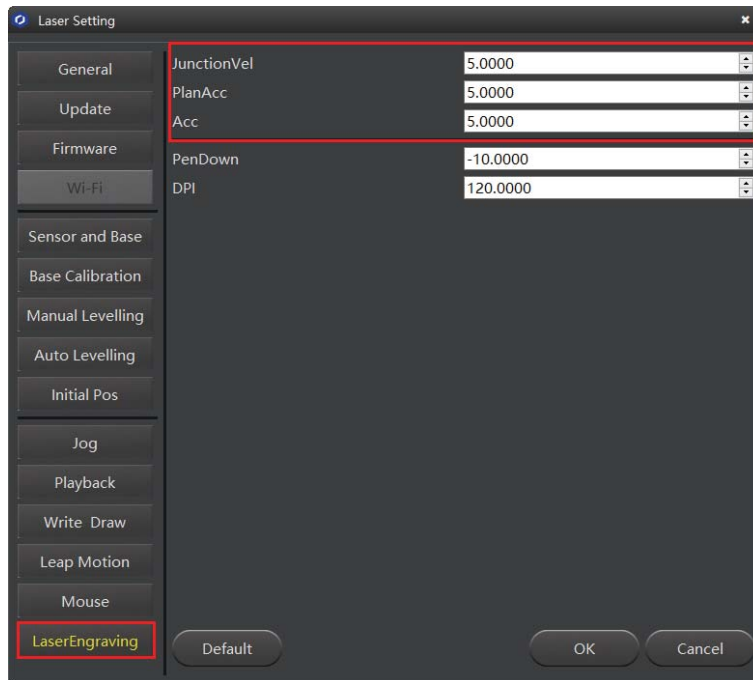



Figure 5.96 Set the parameters of laser engraving

5.6.4 Adjust the Laser Focus and Start to Engrave

- Step 1** Click  to display the **Operation Panel**, and then select **Laser** to turn on the laser, as shown in Figure 5.97. In this case, the laser gives out a laser beam.

 Danger

- When using a laser, wear lasing protective eyeglass.
- Never aim the laser at a person's eye and clothes or stare at the laser from within the beam.
- In the central laser focus, a high-temperature heat is created and can burn materials such as papers and wooden boards.
- Never aim the laser at a person and their clothes.
- Do not allow the children to play with the Dobot Magician. Monitor the robotic arm while it is running and power off it once the movement is complete.



Figure 5.97 Select the Laser

Step 2 Adjust the laser focus.

Press and hold the unlock button  on the Forearm to move the robotic arm to raise and lower the height of the laser kit until the laser is the brightest with a smallest possible spot size. When the laser power level is high enough, the laser beam can burn and cut the paper. After getting a pretty good focus, unselect **Laser** on the **Operation Panel** page to turn off the laser, as shown in Figure 5.98.



Figure 5.98 Unselect the Laser

NOTICE

- If you cannot set the laser to be at its minimum focus, it's probably because the focal length is long. To shorten the focal length, slightly turn the sliver lens screw (as shown in Figure 5.99) on the bottom of the laser kit.

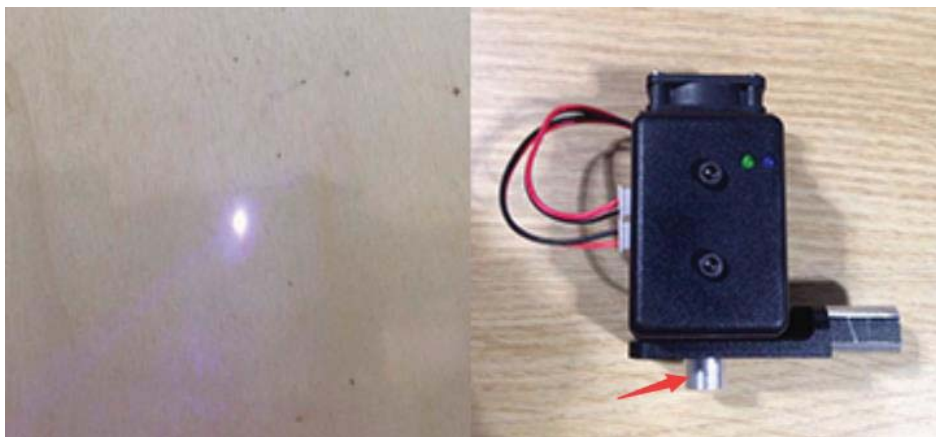

Figure 5.99 Adjust the focus

- The point marked by a red box, as shown in Figure 5.100, corresponds to the position of the laser kit of the Dobot Magician. This point changes its position only within the annular area when the robotic arm moves.

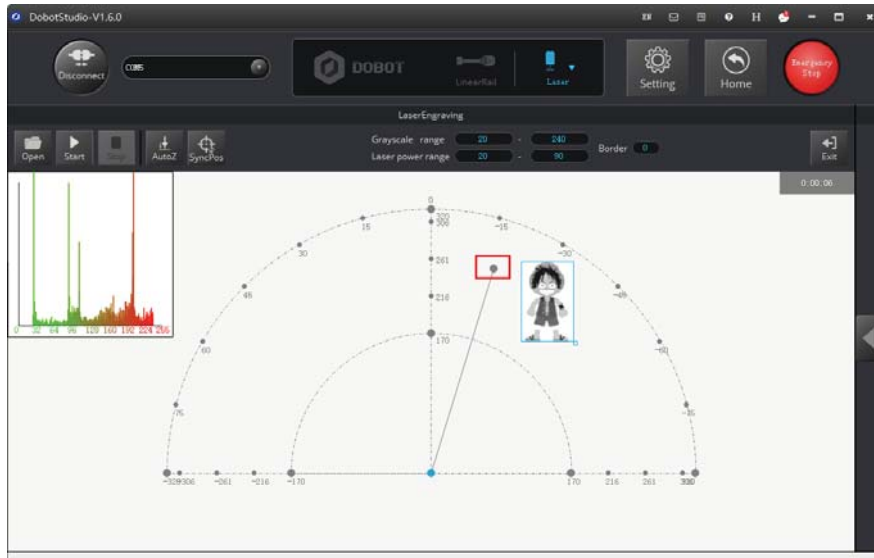

Figure 5.100 The point corresponding to the laser kit of the robotic arm

Step 3 Click **AutoZ** on the **LaserEngraving** page to obtain and save the current value of the Z axis.

Once this step is complete, the next time you start to engrave, directly import an image file without adjusting the position of the laser kit, and click **SyncPos**, and then click **Start** to start engraving on the paper, as shown in Figure 5.101.

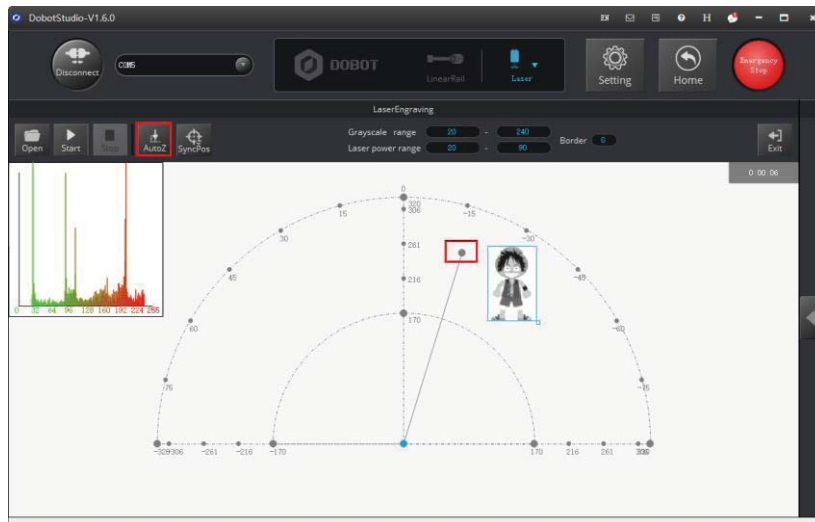

Figure 5.101 Lock the height of engraving

NOTE

The value of Z axis is the **PenDown** parameter. This parameter can be set by selecting **Setting > LaserEngraving > PenDown**, as shown in Figure 5.102. If the effect of engraving is not satisfactory, slightly raise and lower the height of the laser kit or directly change the value of **PenDown**.

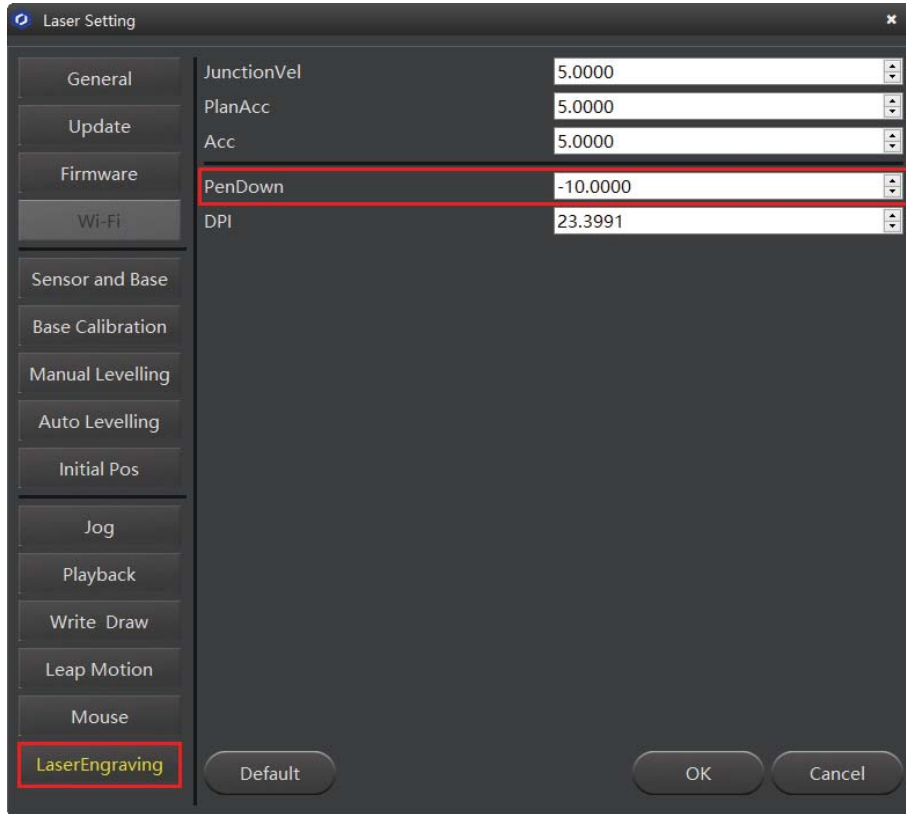

Figure 5.102 Set the PenDown parameters

Step 4 Click **SyncPos**.

The Dobot Magician automatically moves above the position of the start point of the laser-engraving.

Step 5 Click **Start** to start engraving on the paper.

When engraving, click **Pause** to pause the engraving and **Stop** to halt the engraving.

Figure 5.103 shows the effect of the laser-engraving.



Figure 5.103 The effect of laser-engraving

5.7 Controlling with your Hand Gesture

You can use the **LeapMotion** function module of the DobotStudio to perform tasks, for example, grab or suck an object with your hand gesture.

5.7.1 Installing a Leap Motion Controller

Prerequisites

- The Leap Motion controller (a hand gesture controller) has been obtained.
- The Leap Motion driver software has been obtained. Download the Windows version, as shown in Figure 5.104, from the <https://www.leapmotion.com/setup/desktop/windows>.



Figure 5.104 Download the Leap Motion driver software for Windows

Procedure

- Step 1** Connect a Leap Motion controller to your computer with a USB cable, and put it on the work surface with its face up, as shown in Figure 5.105.



Figure 5.105 Connect the Leap Motion controller to your computer

- Step 2** Install the Leap Motion driver software by following the on-screen instructions, as shown in Figure 5.106.

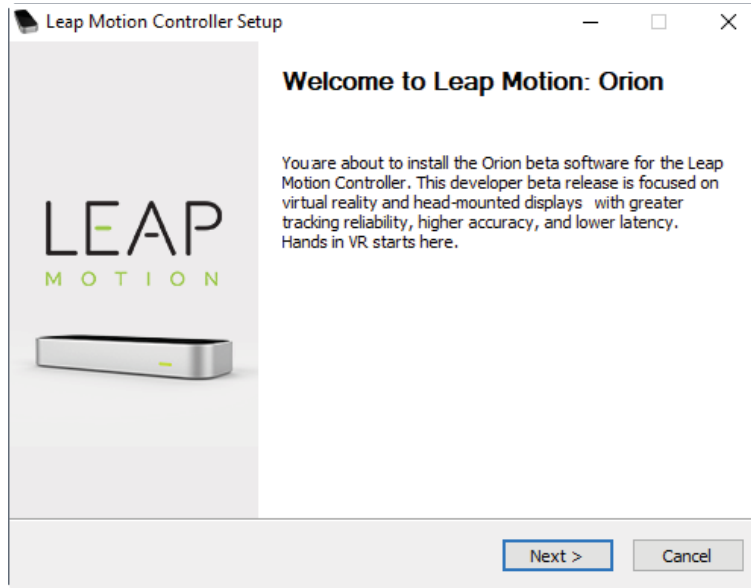

Figure 5.106 The Leap Motion Installation Interface

5.7.2 Leap Motion Demo

You can move or sort an object with the LeapMotion function. This topic introduces how to move a small cube with a hand gesture.

Prerequisites

- The Dobot Magician is powered on and connected to your computer.
- The suction cup kit has been installed. For details, see *5.2.1 Installing a Suction Cup Kit*.

Procedure

- Step 1** Launch the DobotStudio, and click **Connect** to connect to the Dobot Magician.
- Step 2** Click **LeapMotion**, as shown in Figure 5.107.



Figure 5.107 Click LeapMotion

Step 3 Click **Setting** on the **DobotStudio** page, as shown in Figure 5.108.

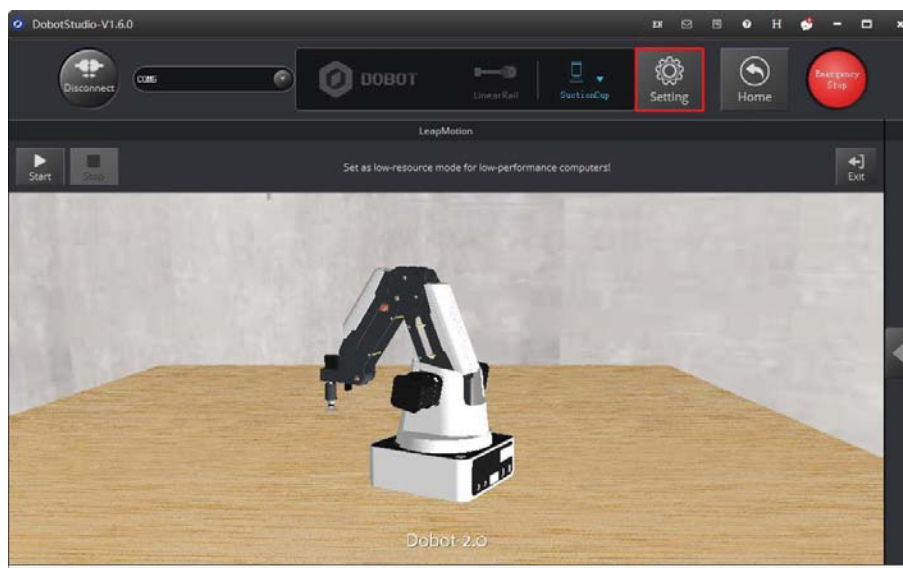

Figure 5.108 Click Setting

Step 4 Click **Leap Motion**, as shown in Figure 5.109. Set the parameters, as shown in Table 5.12, and click **OK**.

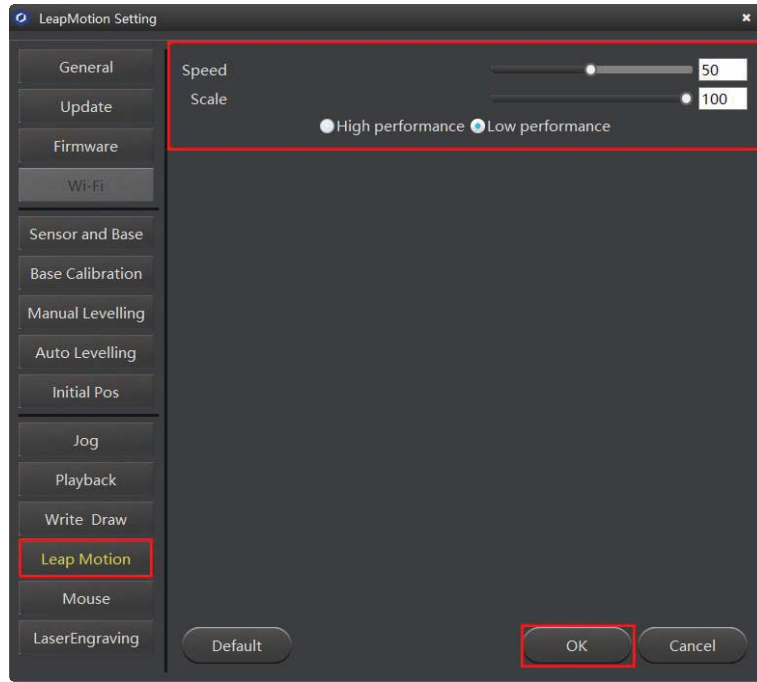

Figure 5.109 Set the parameters of the Leap Motion function

Table 5.12 Set the parameters of the Leap Motion function

Items	Description
Speed	The velocity percentage of the Dobot Magician: Unit: % Value range: 1 - 100 Default value: 50
Scale	The scale of the Dobot Magician: Unit: % Value range: 1 - 100 Default value: 100
High performance/Low performance	Choose a performance mode suitable for your computer. Select the Low performance (default) for the low configuration computer to prevent video delay

Step 5 Choose **SuctionCup** as the end-effector on the **DobotStudio** page, and click **Start** to control the **Dobot Magician** with your hand gesture, as shown in Figure 5.110. To maintain the Dobot Magician in a stable state, move your hand into the workspace of the Leap Motion controller while keeping your palm upward. And turn your palm down, and then move your hand above this area to control the Dobot Magician.

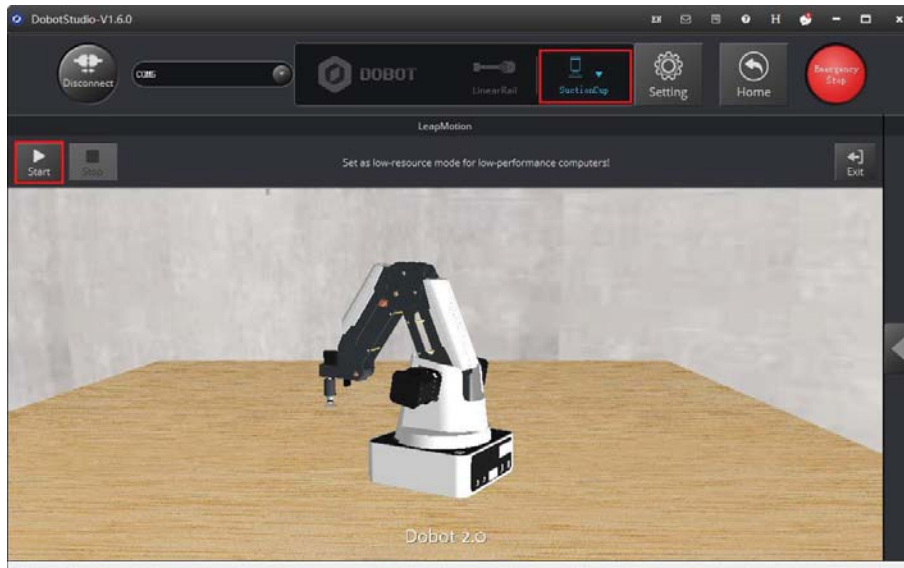

Figure 5.110 Click Start

NOTE

Move your hand in the workspace of the Leap Motion controller to control the Dobot Magician to perform a particular task, as shown in Table 5.13.

Table 5.13 The robotic arm’s movement created with your hand gesture

Hand gesture	Robotic arm’s movement
Move your palm up, down, front, back, right, or left	The robotic arm moves accordingly
Clench your fist	Control the air pump to suck air
Unclench your fist	Turn off the air pump

Step 6 Put a small cube on the work surface in the workspace of the Dobot Magician, such as point A, and use the hand gesture to move robotic arm above the cube until it’s close to the cube.

Step 7 Clench your fist to control the air pump to suck the small cube, and move your fist to make Dobot Magician take the cube to another position while clenching your fist, such as position B, and then unclench your fist to turn off the air pump to drop the cube.

Step 8 Turn your palm upward and click **Stop** to stop the hand control.

5.8 Controlling with your Mouse

You can use the **Mouse** function module of the DobotStudio to perform tasks, for example, grab or suck an object with your mouse. This topic introduces how to move a small cube with a mouse.

Prerequisites

- The Dobot Magician is powered on and connected to your computer.
- The suction cup kit has been installed. For details, see *5.2.1 Installing a Suction Cup Kit*.

Procedure

Step 1 Click **Mouse**, as shown in Figure 5.111.



Figure 5.111 Click Mouse

Step 2 Choose **SuctionCup** as the end-effector on the **DobotStudio** page, as shown in Figure 5.112.

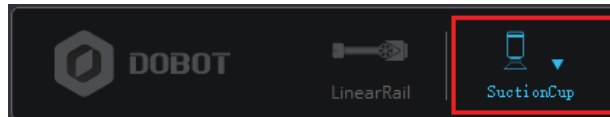

Figure 5.112 Choose SuctionCup as the end-effector

Step 3 Click **Setting**, as shown in Figure 5.113.

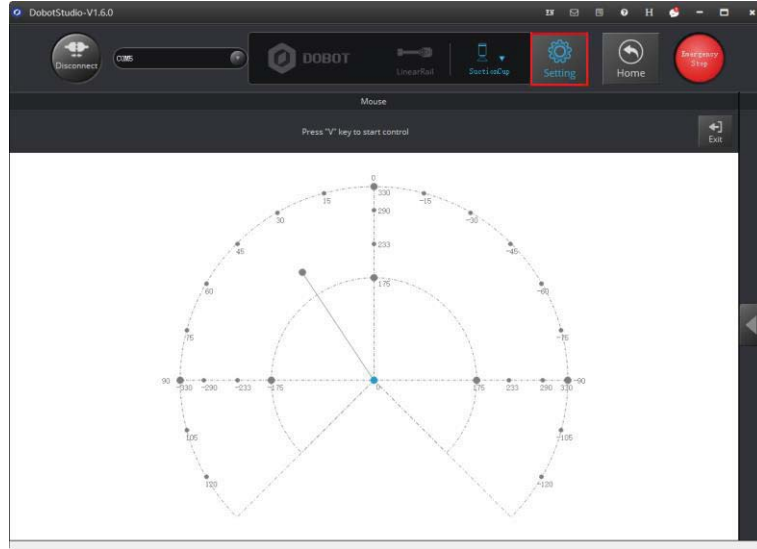

Figure 5.113 Click Setting

Click **Mouse**, as shown in Figure 5.114. Set the parameters, as shown in

Table 5.14, and click **OK**.

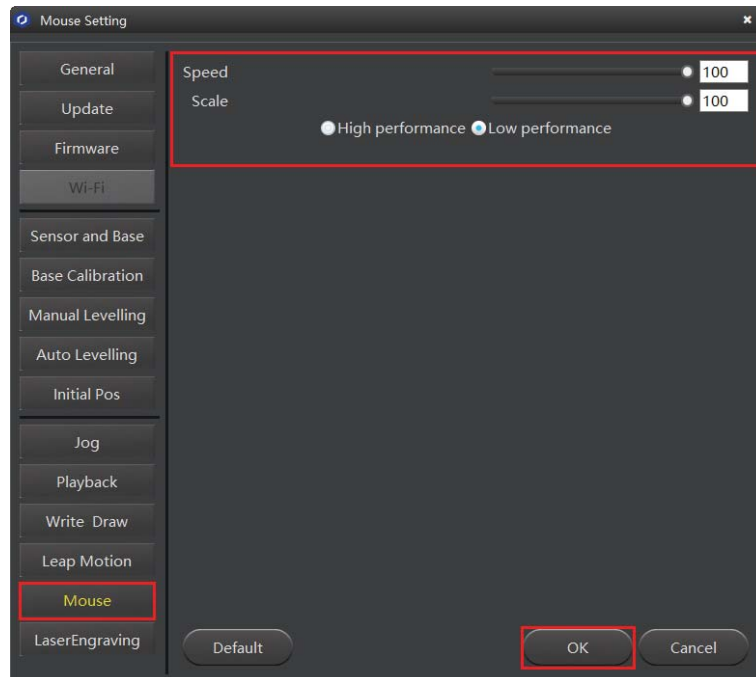

Figure 5.114 Set the parameters of mouse control

Table 5.14 Set the parameters of mouse control

Parameters	Description
Speed	The velocity percentage of the Dobot Magician: Unit: % Value range: 1 - 100 Default value: 50
Scale	The scale of the Dobot Magician: Unit: % Value range: 1 - 100 Default value: 100
High performance/Low performance	Choose a performance mode suitable for your computer. Select Low performance (default) for the low configuration computer to prevent video delay

- Step 1** Put a small cube on the work surface in the workspace of the Dobot Magician, such as point A.
- Step 2** Press **V** to enable the mouse control of the Dobot Magician. Press and hold the left mouse button to drag the mouse within the red annular area to move the robotic arm, as shown in Figure 5.115.

NOTICE

Do not move the mouse outside the red annular area. If not, the robotic arm reaches its limited position. In this case, drag the mouse to into the annular area.

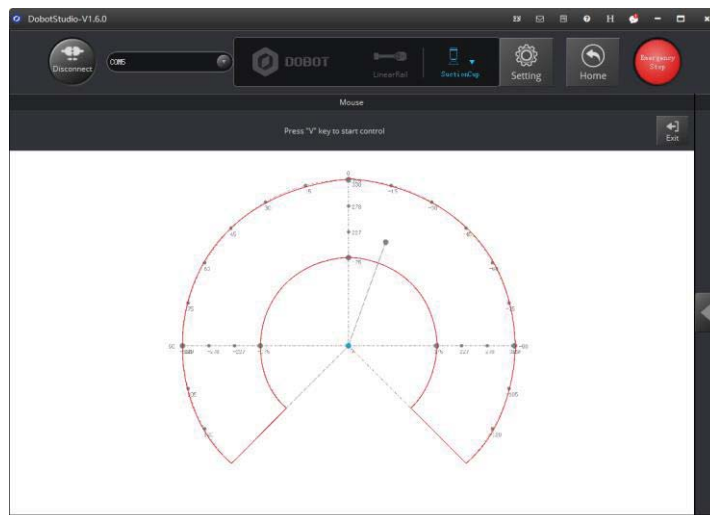

Figure 5.115 Move the robotic arm in the red annular area

Step 3 Move the Dobot Magician above the cube by dragging the mouse and then place it close to the cube.

 **NOTE**

For details on how to use the mouse to control the robotic arm on the **Mouse** page, see Table 5.15.

Table 5.15 The robotic arm's movement created with your mouse

Mouse action	Robotic arm's movement
Move your mouse front, back, right, or left	The robotic arm moves accordingly
Scroll the mouse wheel up or down	The robotic arm moves accordingly
Press and hold the left mouse button	Suction cup: the air pump sucks air in Gripper: increase holding force
Release the left mouse button	Suction cup: the air pump is powered off Gripper: open
Right-click the mouse button	Gripper: close

Step 4 Press and hold the left mouse button to control the air pump to suck air to move the mouse to drag the robotic arm to take the cube to another position, such as point B, and release the left mouse button, and the air pump stops working to drop the cube here.

Step 5 Press **V** or **ESC** to disable the mouse control.

5.9 Operating 3D Printing

After installing 3D printing kit, you can import 3D module into the 3D printing software for 3D printing. Figure 5.116 shows the 3D printing process.

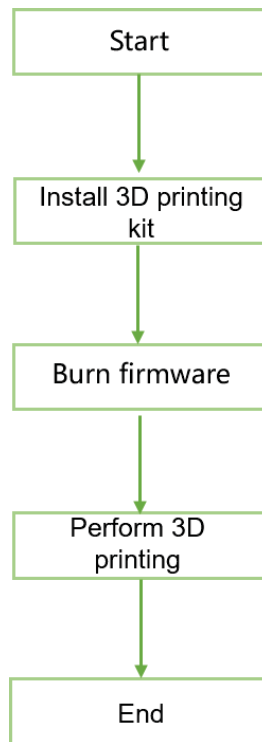

Figure 5.116 3D printing process

During 3D printing, the 3D printing control software is required. You can use **Repetier Host** or **Cura** software for 3D printing.

- **Reptier-Host:** **Reptier-Host** can slice with the third party slicing (such as CuraEngine, Slic3r, etc), check and modify **G-Code**, control 3D printing manually. More parameter settings make **Reptier-Host** very flexible.
- **Cure:** The slicing of **Cura** is fast and stable. It has strong inclusiveness to 3D model structure and less parameter settings.

⚠ NOTICE

This section uses Windows as an example to describe how to perform 3D printing with **Repetier Host** and **Cura**. For Mac OS, only **Cura** is supported.

5.9.1 Installing 3D Printing Kit

3D printing kit contains extruder, hot end, motor cable, filament, and filament holder as shown in Figure 5.117.



Figure 5.117 3D printing kit

Procedure

- Step 1** Press down the lever on the extruder, and push down the filament to the bottom of the hole via the pulley, as shown in Figure 5.118.

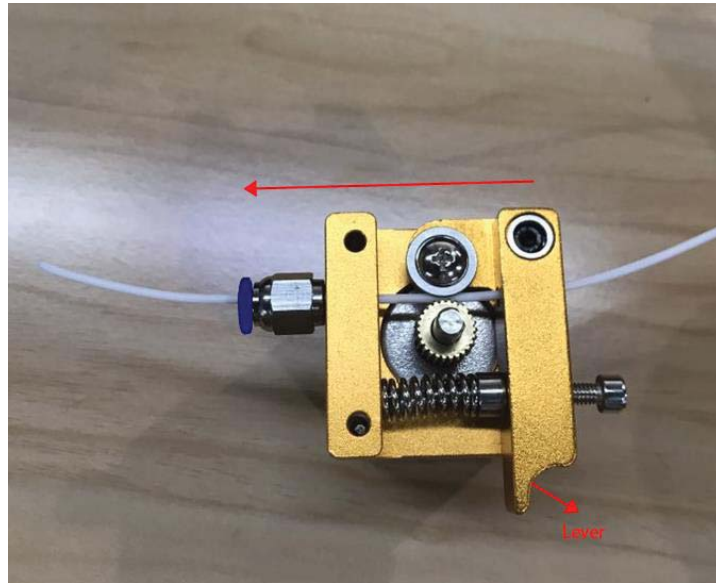

Figure 5.118 Push down the filament

- Step 2** Connect the end of the PTFE tube to the hot end and push it down to the bottom of the hot end, and connect the other end to the extruder, as shown in



Figure 5.119 Connect extruder and hot end

- Step 3** Insert the filament into the PTFE tube and push it down to the bottom of the hot end.

 NOTICE

Please make sure that the PTFE tube has been pushed down to the bottom of the hot

end. Otherwise, it will cause abnormal discharge.

- Step 4** Fix the hot end on the Dobot Magician with butterfly nut, as shown in Figure 5.120.

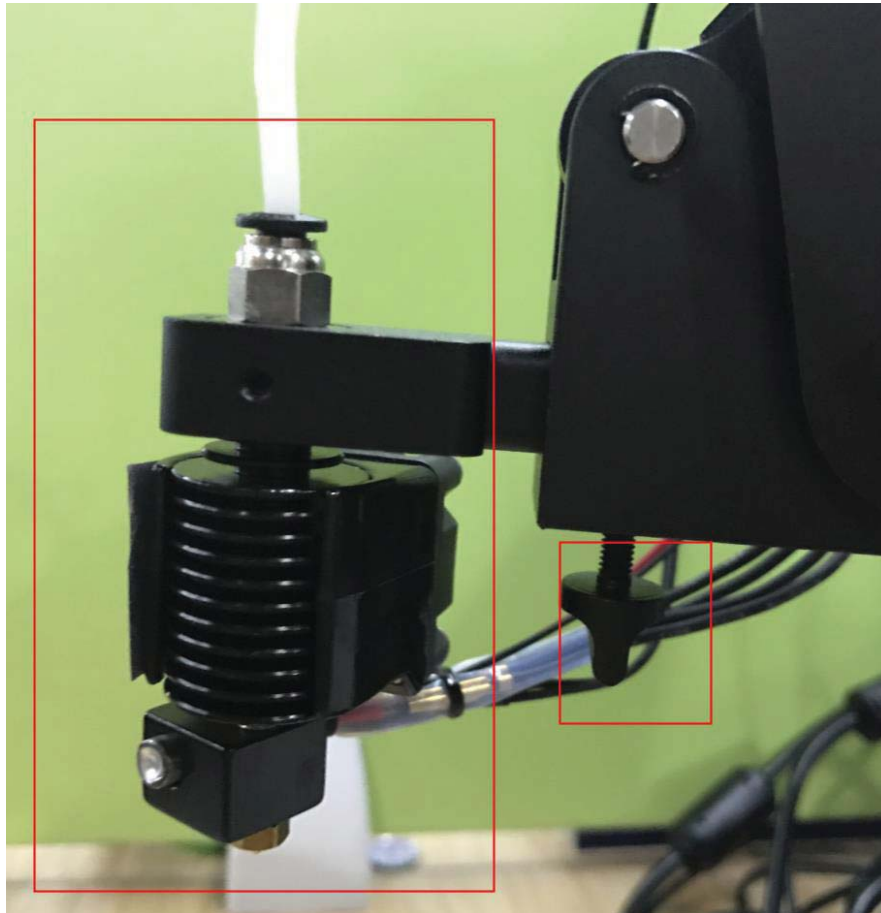

Figure 5.120 Fix hot end

- Step 5** Insert the heating cable to the interface 4 on the Forearm, the fan cable to the interface 5 and the thermistor cable to the interface 6, as shown in Figure 5.121.

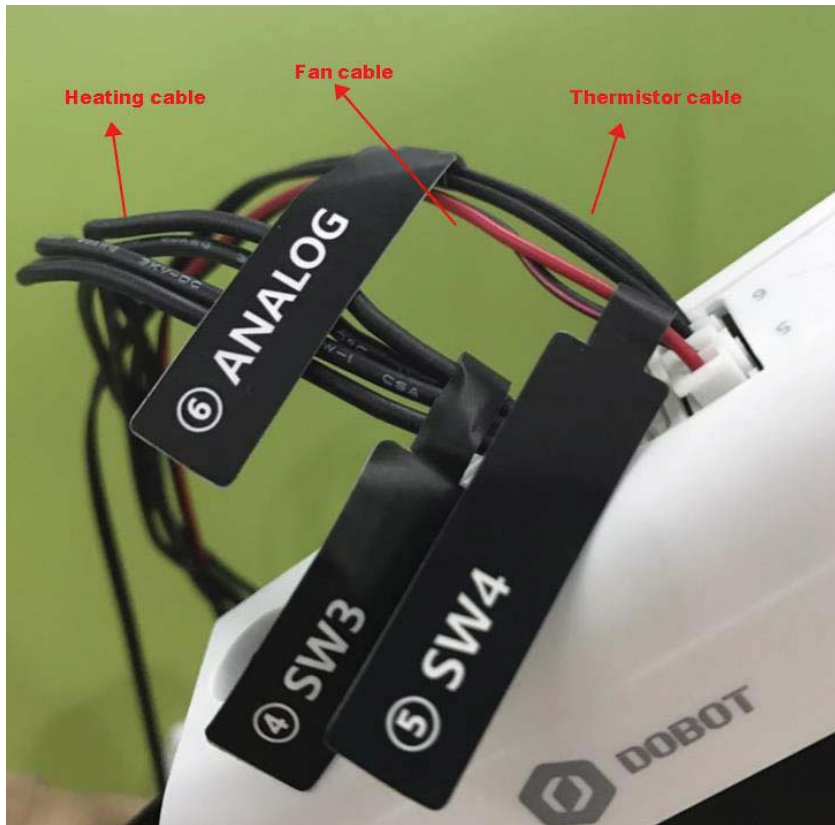

Figure 5.121 Connect hot end to the Forearm

Step 6 Connect the extruder to the **Stepper1** interface on the back of the base with motor cable, as shown in Figure 5.122.

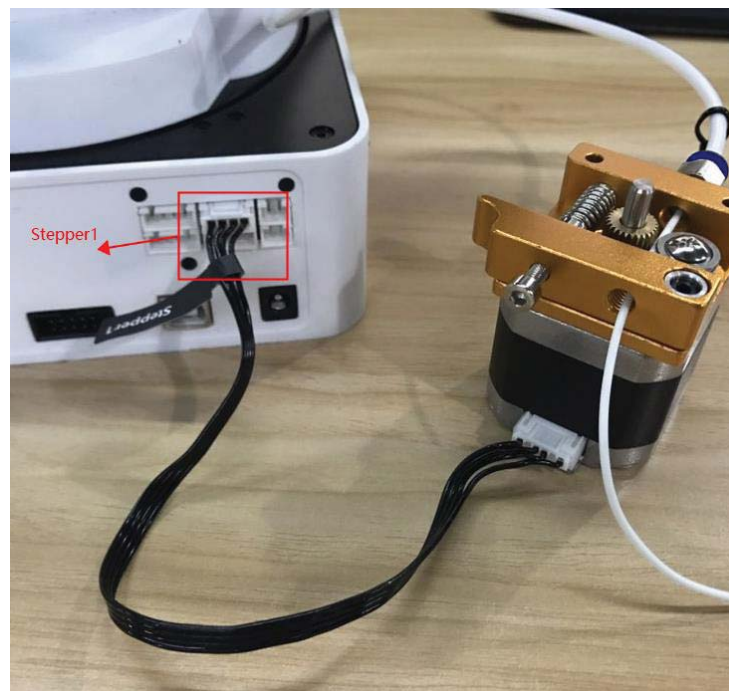

Figure 5.122 Connect with extruder

Step 7 Place the filament and the extruder to the filament holder, as shown in Figure 5.123.



Figure 5.123 Place filament and extruder to the Filament holder

5.9.2 Operating Repetier Host

Repetier Host has been built into DobotStudio. After burning 3D printing firmware, the **Repetier Host** page will be displayed automatically.

Prerequisites

- The 3D printing model has been prepared.
 - The printing platform has been prepared and please place it in the workspace of the Dobot Magician.
 - Dobot Magician has been powered on.
 - Dobot Magician has been connected to DobotStudio successfully (Only USB connection is supported).
 - The 3D printing kit has been installed.

5.9.2.1 Burning Firmware

Procedure

Step 1 Click **3DPrinter** on the DobotStudio page.

The **3D Printing FM** page is displayed, as shown in Figure 5.124.

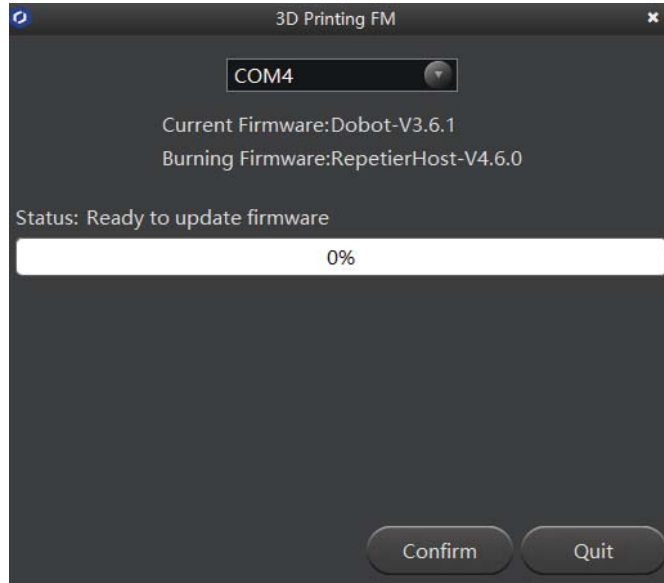

Figure 5.124 Burn firmware

Step 2 Click **Confirm** to start burning 3D printing firmware.

After burning 3D printing firmware, the **Repetier Host** page is displayed automatically, as shown in Figure 5.125.

If the LED indicator on the base turns red, it indicates that the connection of the 3D printing kit is abnormal.

! WARNING

Please DO NOT operate or turn off Dobot Magician when burning firmware, to avoid machine damage.

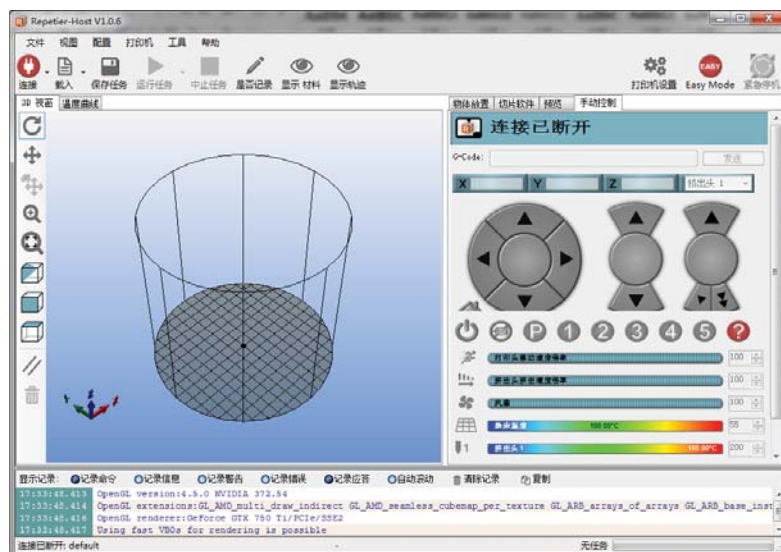

Figure 5.125 Repetier Host page

⚠ NOTICE

If the current firmware is set for 3D printing when operating 3D printing, you can click **Connect** directly on the DobotStudio page. And then Click **OK** on the **Select tool** page to switch to **Repetier Host**, as shown in Figure 5.126.

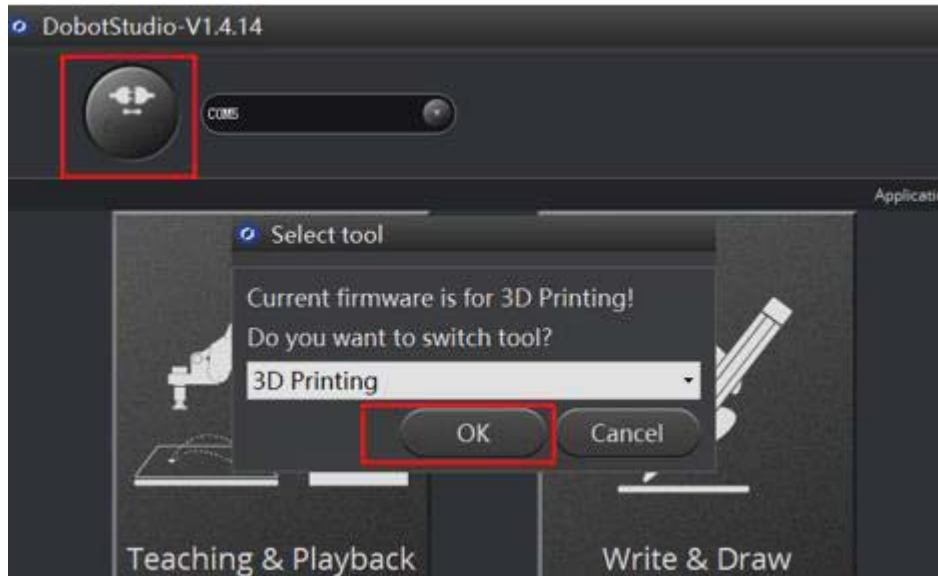

Figure 5.126 Switch into 3D printing automatically

5.9.2.2 Performing 3D Printing

Procedure

Step 1 Set printing parameters.

Printing parameters only need to be set for the first time.

1. Click **Printer Settings** on the top right corner of the **Pepetier Host** page.
The **Printer Settings** page is displayed.
2. Set the corresponding parameters on the **Connection** tab as shown in the red box of Figure 5.127. The other parameters are set by default.

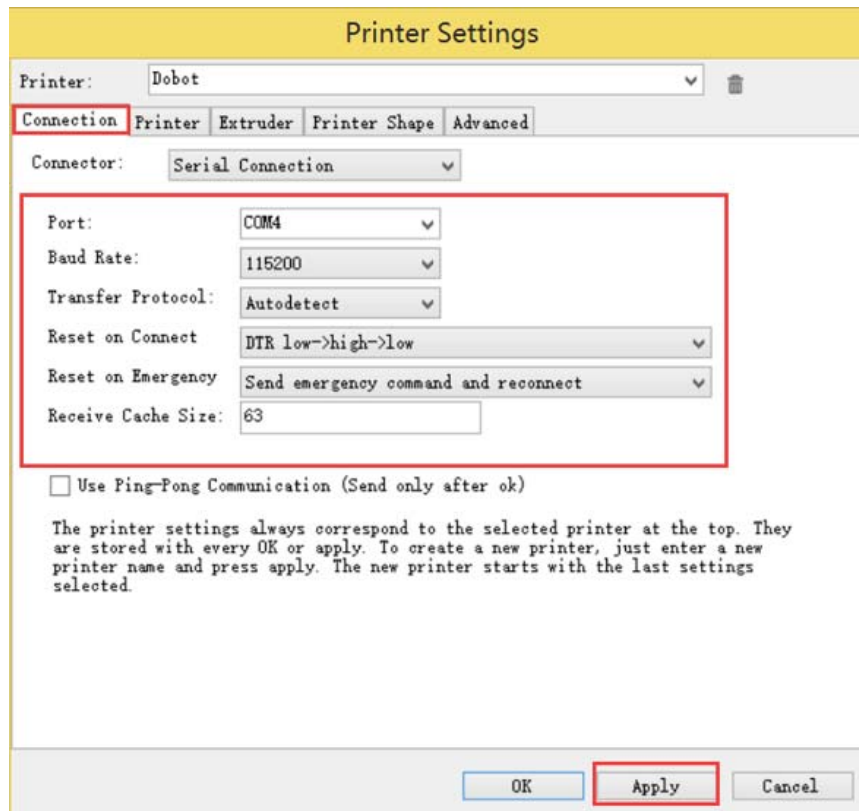

Figure 5.127 Connection setting

3. Click **Apply**.
4. Unselect the corresponding options on the **Printer** tab as shown in the red box of, Figure 5.128 and the other parameters are set by default. Then, click **Apply**.

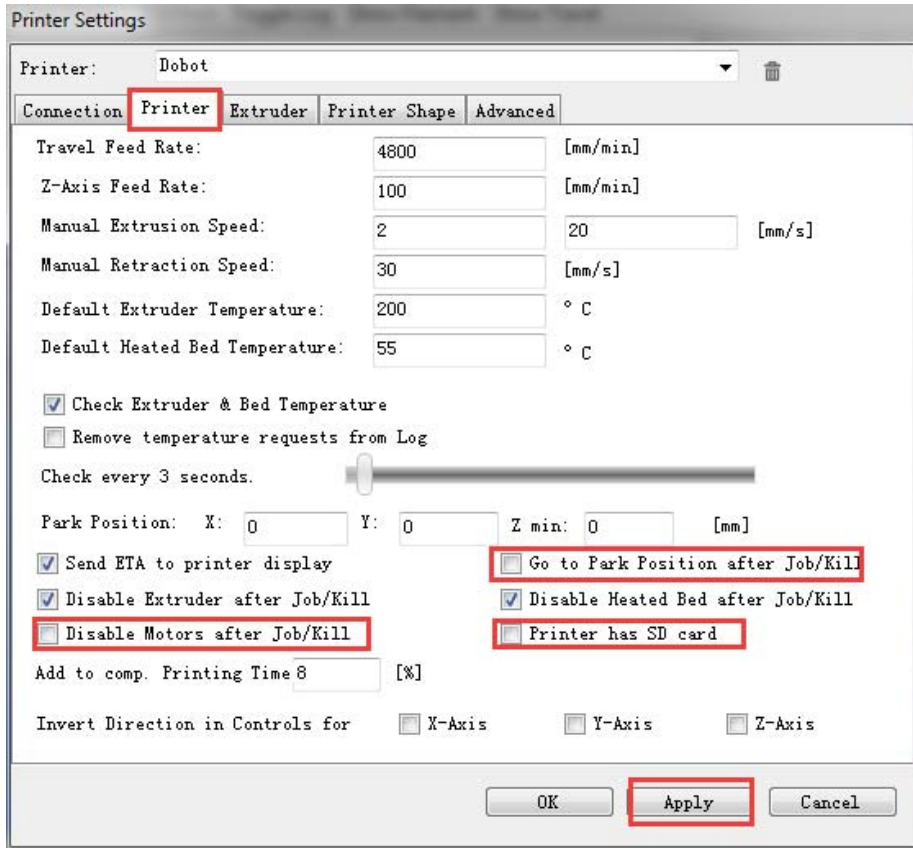

Figure 5.128 Unselect options

5. Set the corresponding parameters on the **Extruder** tab as shown in the red box of Figure 5.129, the other parameters are set by default. Then, Click **Apply**.

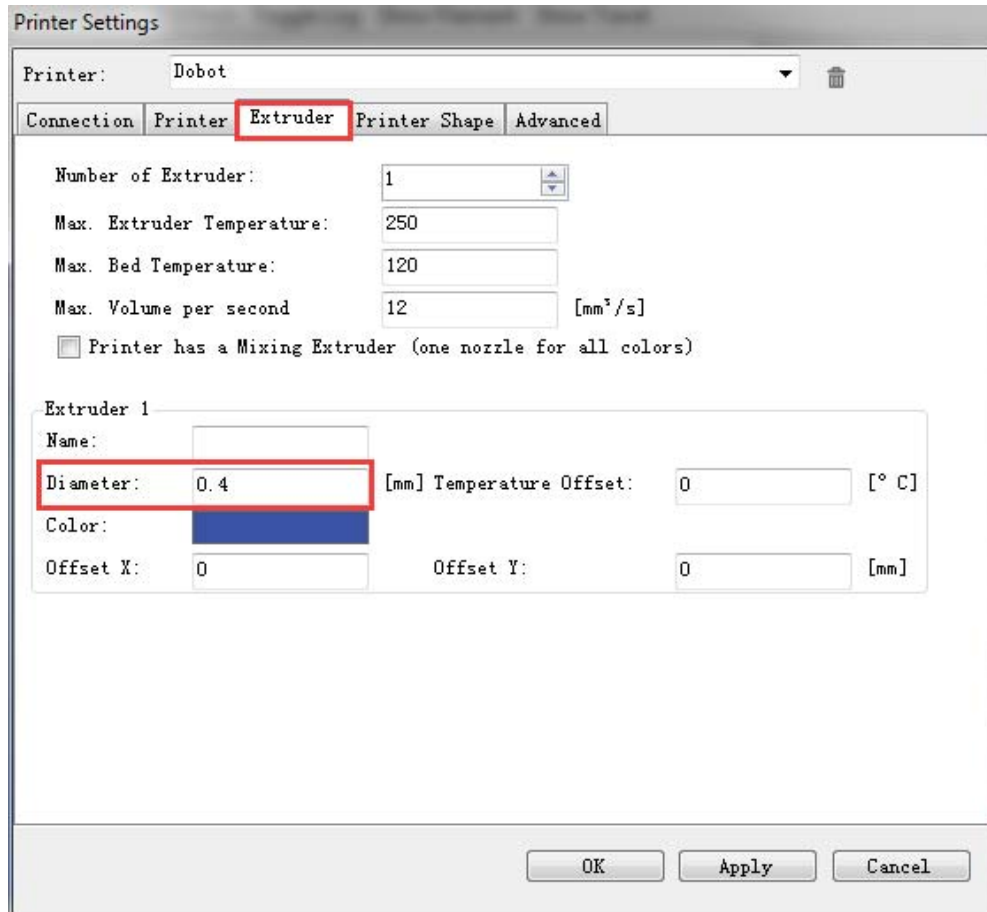

Figure 5.129 Extruder settings

6. Set the corresponding parameters on the **Printer Shape** tab as shown in the red box of Figure 5.130, the other parameters are set by default. Then, Click **Apply**.

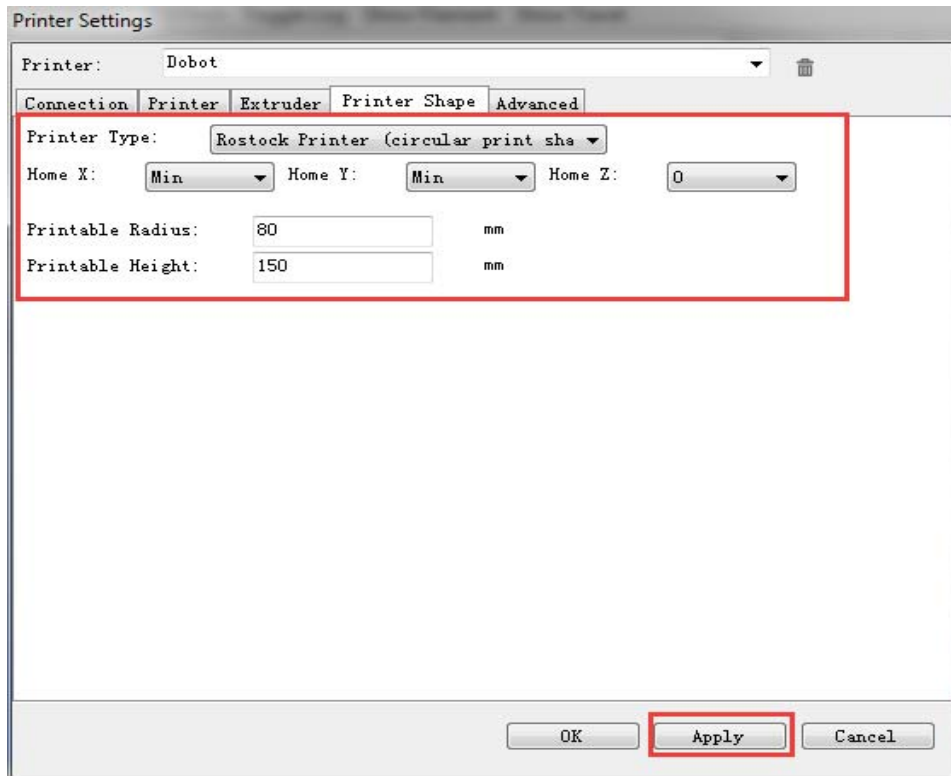

Figure 5.130 Printer shape settings

7. Click **OK**

Step 2 Click **Connect** on the **Repetier Host** page to connect Dobot Magician.

After the connection is successful, the current heating temperature will be shown on the below of the **Repetier Host** page, as shown in Figure 5.131.

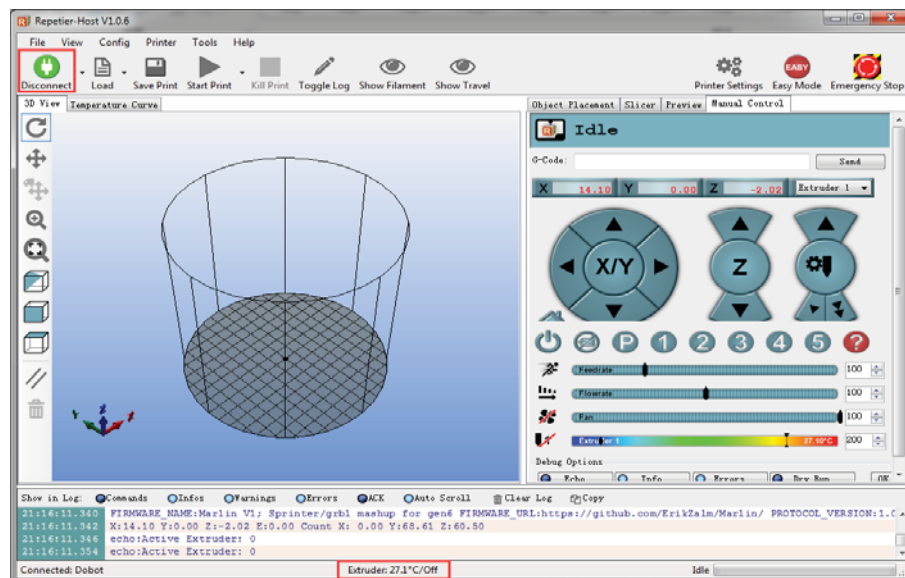



Figure 5.131 Connect to Dobot Magician

Step 3 Text extruder.

Before printing, you need to test the extruder to check whether the melted filament flows from the nozzle of the extruder.

The temperature of the extruder should be above 170°C. Dobot Magician will not start 3D printing until the filament is in the melting state. So you need to heat the extruder first.

1. Set the heating temperature to 200°C on the **Manual Control** tab of the **Repetier Host** page and click , as shown in Figure 5.132.

 **DANGER**

The heating rod will produce high temperature up to 250°C, please be careful. Do not let children play with it alone. The process needs to be monitored when it is running. After the process is completed, please turn off the equipment promptly.

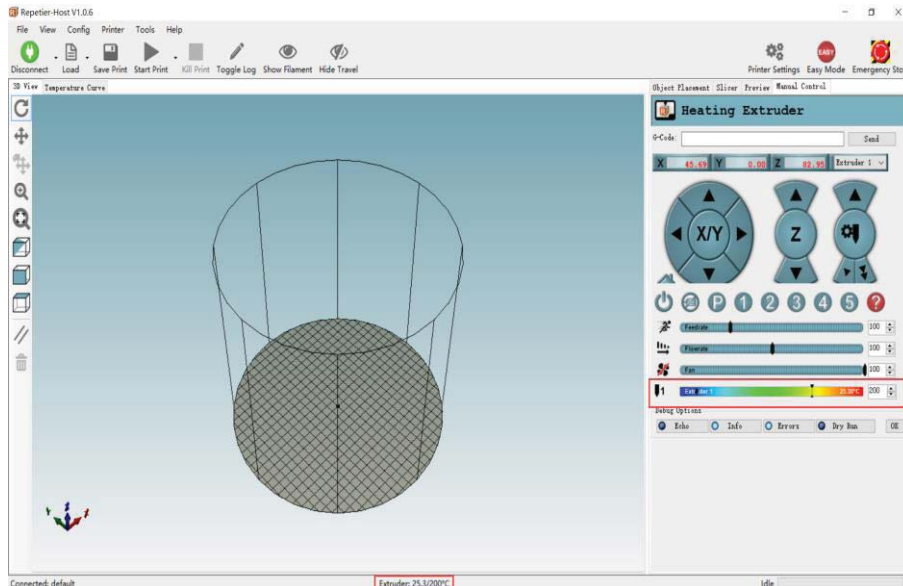

Figure 5.132 Heat the extruder

2. Click the extruder feeder when the heating temperature is up to 200°C and feed up to 10mm-30mm, as shown in Figure 5.133.

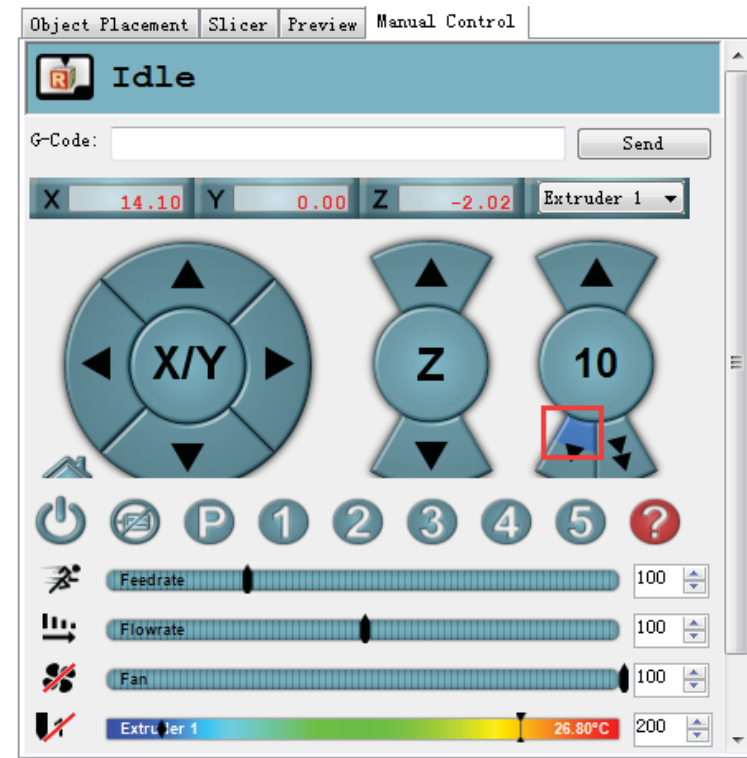

Figure 5.133 Extrude filament

If the melted filament flows from the nozzle of the extruder, the extruder is working properly.

⚠ NOTICIE

If the filament extrusion is in the opposite direction. Please remove the filament, and turn the extruder around, then re-push down the filament.

Step 4 Adjust the printing space and get the printing coordinates.

📖 NOTE

During printing, if the distance from Dobot Magician to the printing platform is too large or too small to paste the first layer, it can lead to the nozzle blockage. For increasing the stickiness of the first layer, placing a masking paper on the platform is recommended.

1. Press the **Unlock** key on the Forearm and drag Dobot Magician to make the printing head contact the surface of the masking paper (The distance between the printing head and the surface of the masking paper is the thickness of a sheet of A4 paper), then release the **Unlock** key.
2. Input command **M415** on the **G-Code** command window and press **Enter** to

get the current coordinates, as shown in Figure 5.134.

Also, you can press the **Key** button on the back of the base to get the current coordinates.

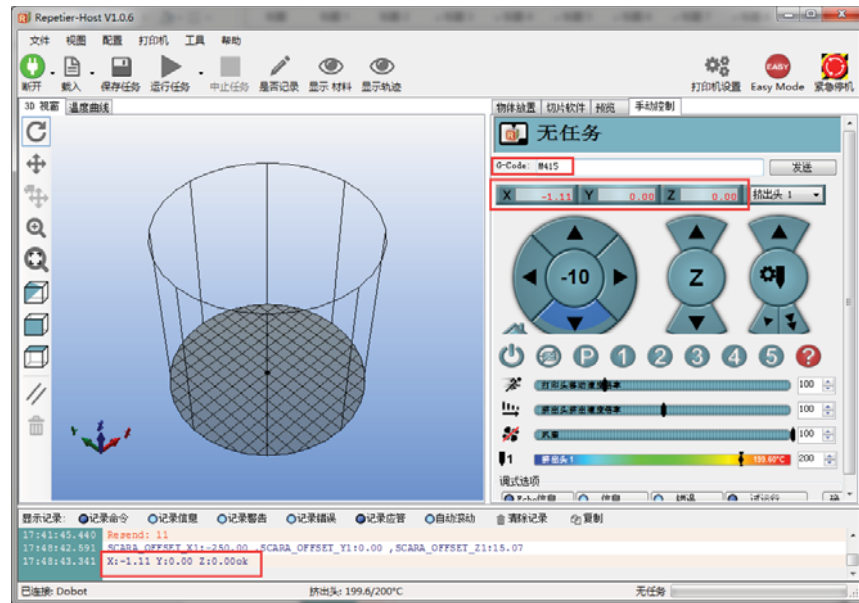

Figure 5.134 Input M415

NOTE

If you cannot find the **G-Code** command window, please click **EASY** to close **Easy Mode**, as shown in Figure 5.135.

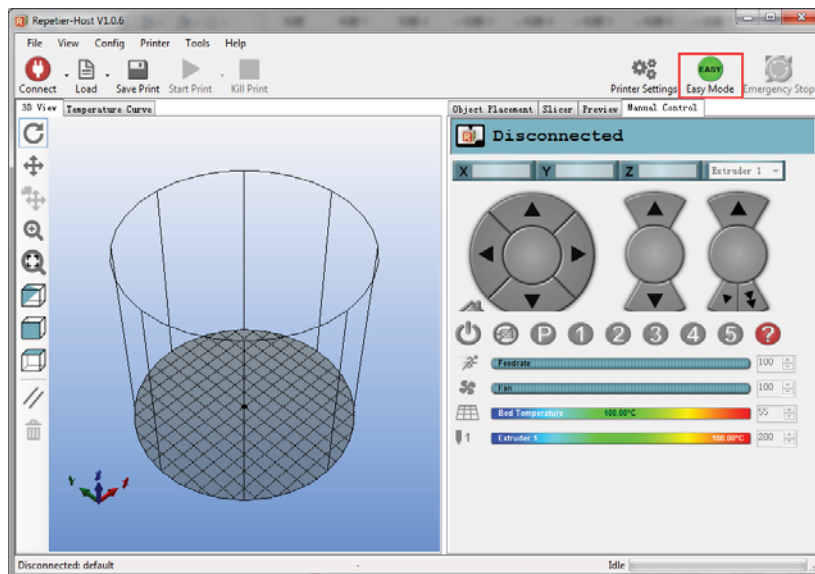

Figure 5.135 Easy mode

Step 5 Click **Load** to import the prepared 3D printing model, as shown in Figure 5.136.

The format of 3D model is STL. You can design 3D model and transform it into STL format.

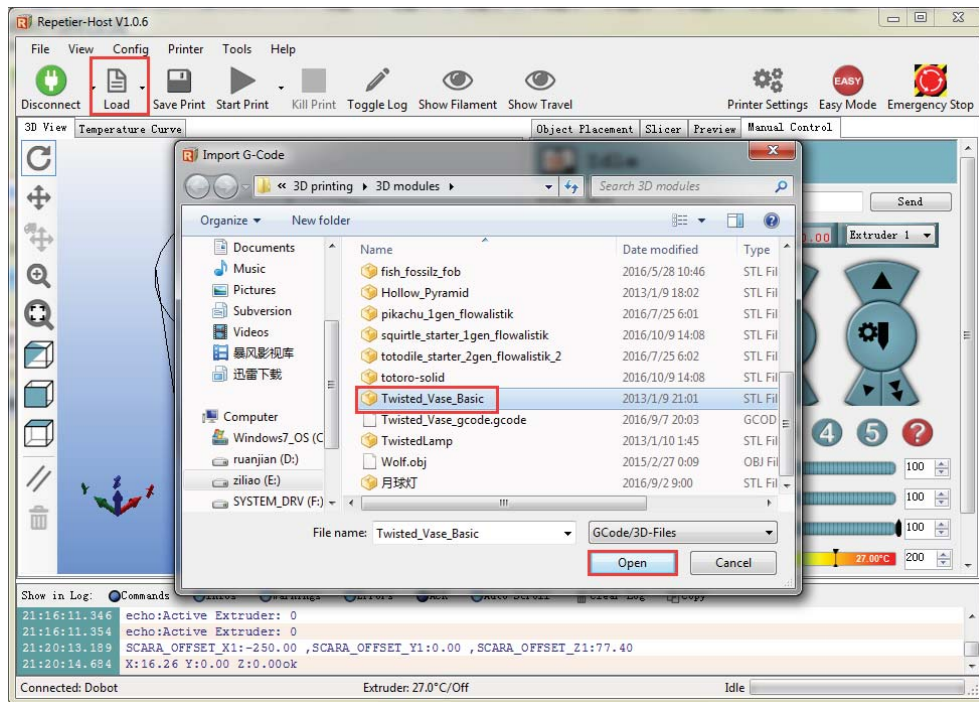

Figure 5.136 Import 3D printing Model

After importing the model, you can center, zoom, or rotate the model on the **Object Placement** page, as shown in Figure 5.137.

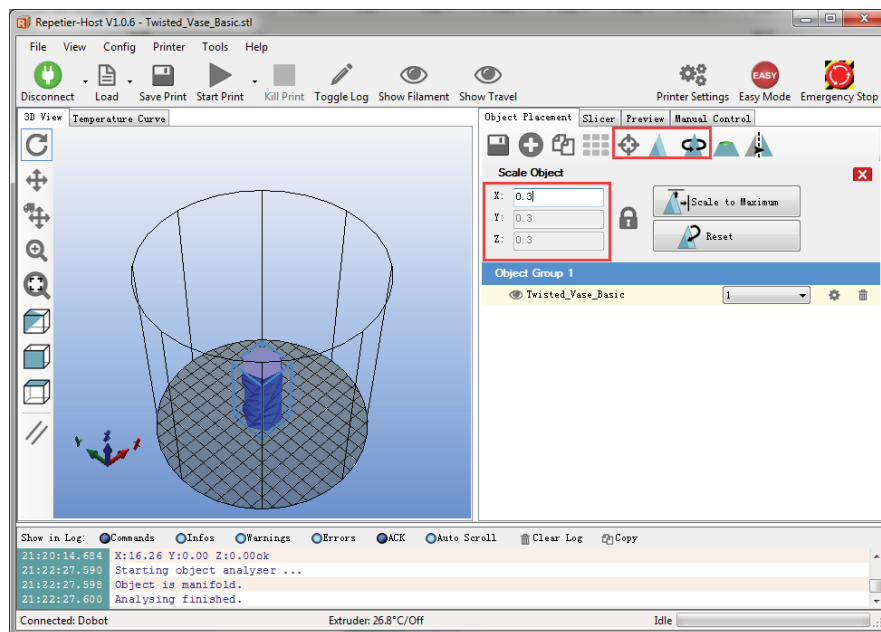

Figure 5.137 Model operation

Step 6 Set slicing parameters and slice up.

You need to set the slicing parameters before first printing.

3. Select **Slic3r** from **Slicer** on the **Slicer** tab of the **Repetier Host** page, and click **Configuration**, as shown in Figure 5.138.

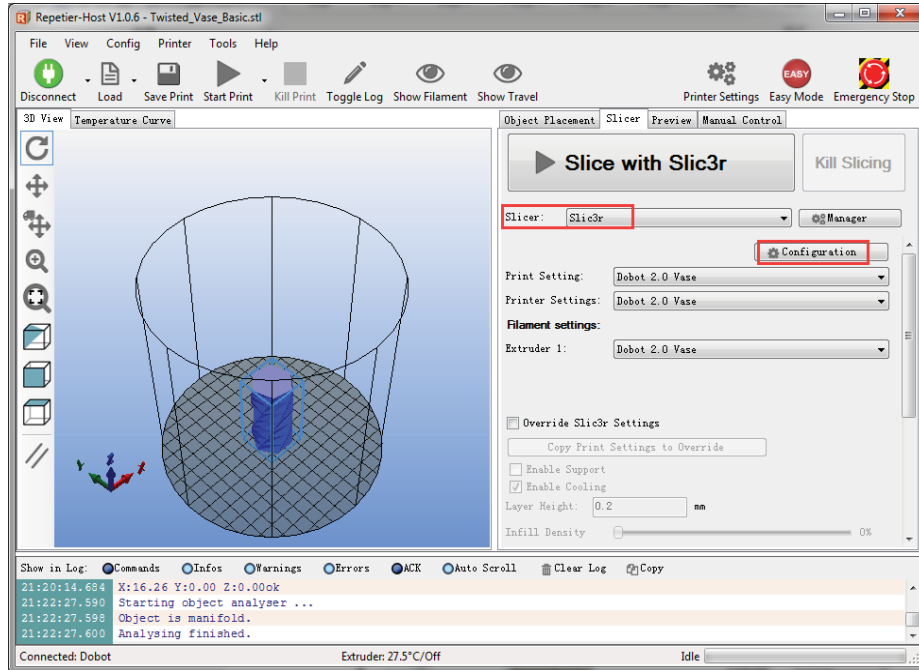

Figure 5.138 Select slicer

The Slic3r page is displayed, as shown in Figure 5.139.

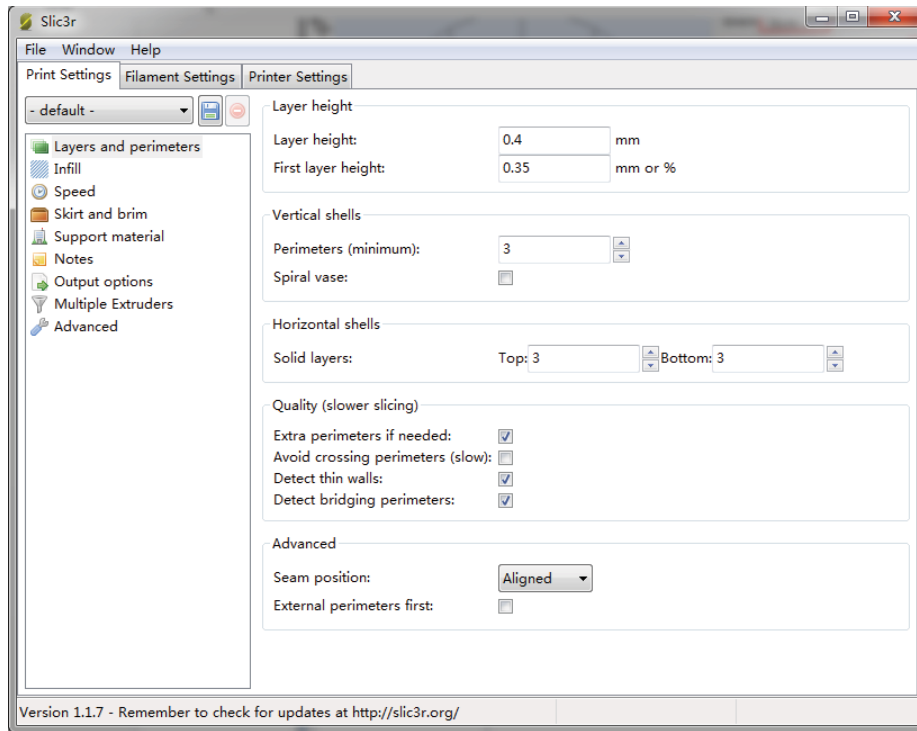

Figure 5.139 Slic3r page

4. Set the slicing parameters on the **Slic3r** page.

The 3D printing effect depends on the slice parameters. This topic provides a configuration sample, you can select **File > Load Config** on the **Slic3r** page to import it directly for printing.

The path of the configuration sample is **Installation directory\DobotStudio\attachment**, as shown in Figure 5.140.

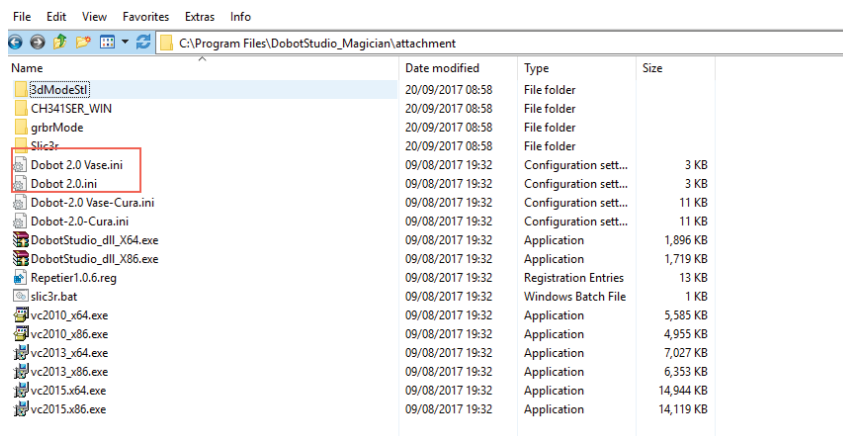

Figure 5.140 Configuration sample

Dobot-2.0-Vase.ini is used for printing a thin-walled vase, while Dobot-2.0.ini

is used for the filling, the filling rate is 20%.

5. Save the **Printing Settings**, **Filament Settings** and **Printer Settings** tabs respectively after importing configuration sample, as shown in Figure 5.141.

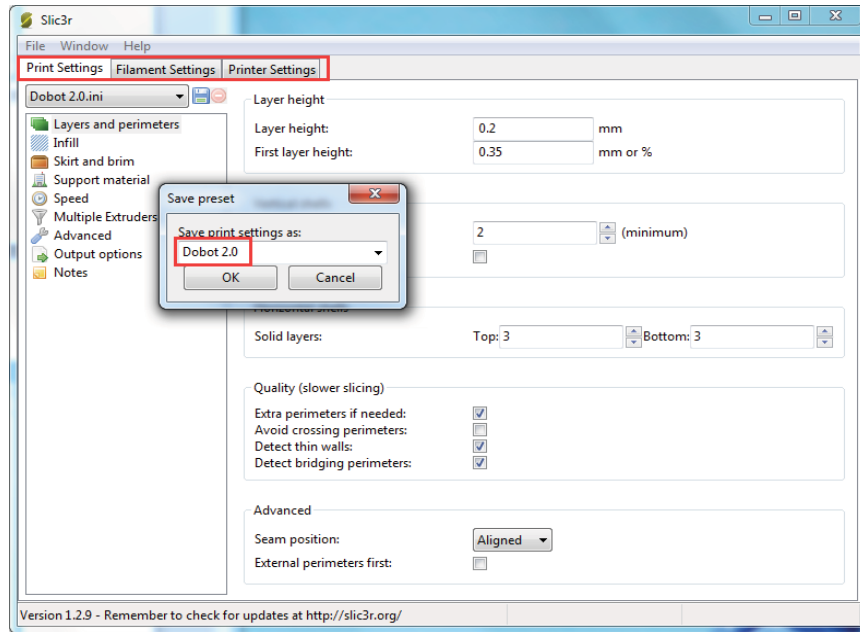

Figure 5.141 Save configuration file

6. Click **Slici with Slic3r** on the **Slicer** tab of the **Repetier Host** page, as shown in Figure 5.142.

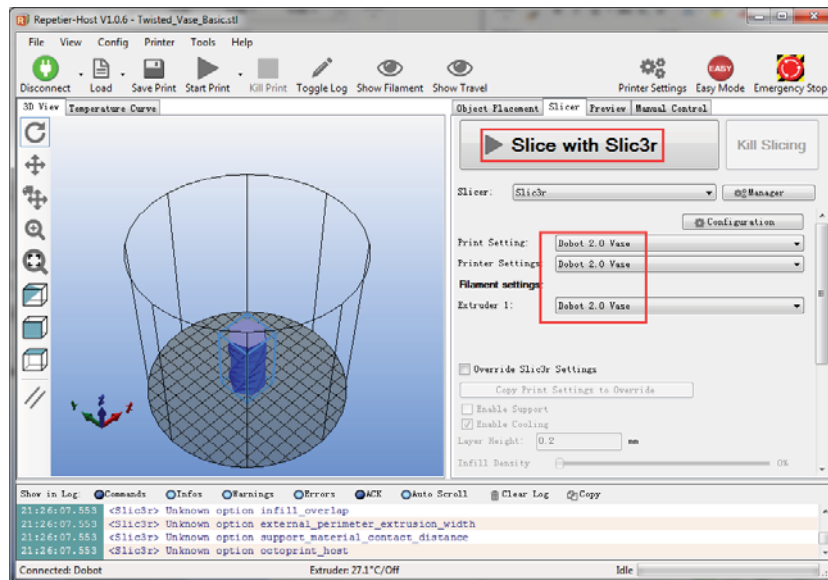

Figure 5.142 Start to slice

7. Click  on the top left corner of the **Repetier Host** page to print.

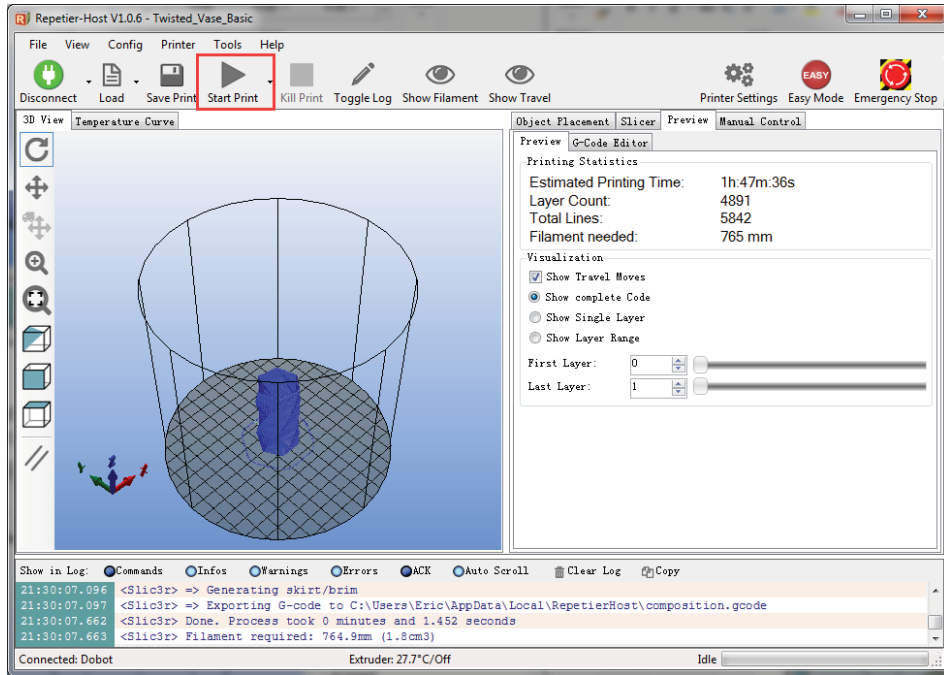

Figure 5.143 Start printing

Here we choose vase mode to print, and the product after printing as shown in Figure 5.144.

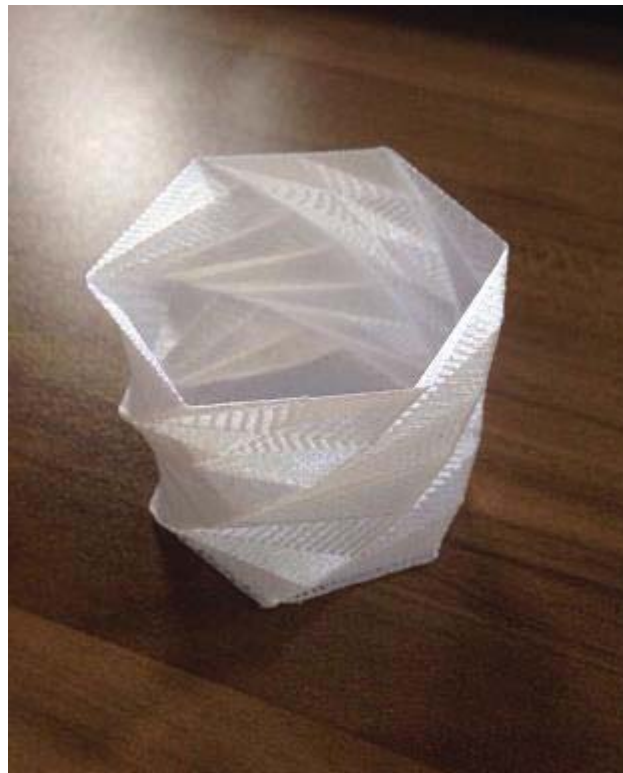

Figure 5.144 The product of printing

5.9.3 Operating Cura

If you need to use Cura software for 3D printing, please launch the Cura software after burning firmware.

Prerequisites

- Slice software **Cura** has been installed.

The download path is <https://ultimaker.com/en/products/ultimaker-cura-software/list>.

Please download the recommended version **V14.07**. The way how to install and use is not described in this topic.

- The 3D printing model has been prepared.
- The printing platform has been prepared and please place it in the workspace of Dobot Magician.
- Dobot Magician has been powered on.
- Dobot Magician has been connected to DobotStudio successfully (Only USB connection is supported).
- The 3D printing kit has been installed.

5.9.3.1 Burning Firmware

Procedure

Step 1 Click **3DPrinter** on the **DobotStudio** page.

The **3D Printing FM** page is displayed, as shown in Figure 5.145.

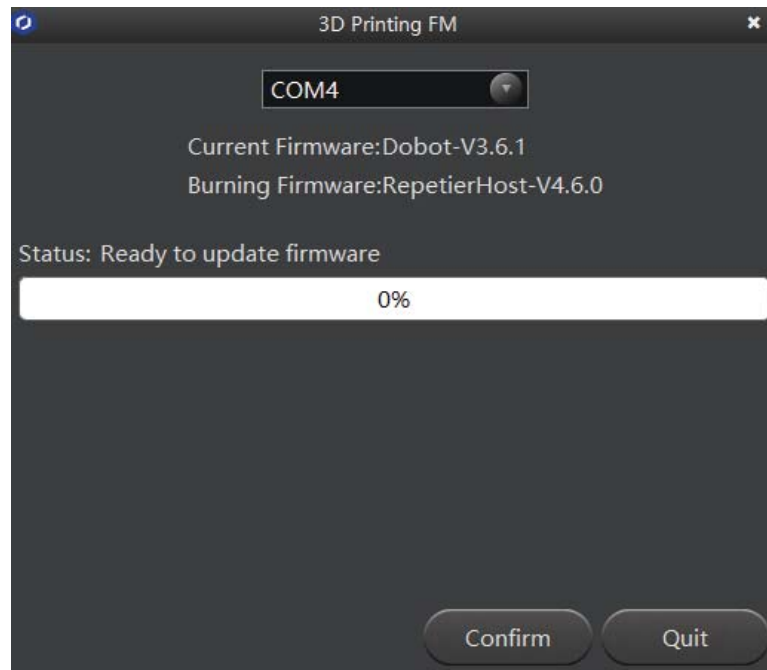

Figure 5.145 Burn firmware

Step 2 Click **Confirm** to start burning 3D printing firmware.

After burning 3D printing firmware, if the LED indicator on the base turns red, it indicates that the connection of the 3D printing kit is abnormal..

WARNING

Please **DO NOT** operate or turn off Dobot Magician when burning firmware, to avoid machine damage.

5.9.3.2 Performing 3D Printing

Procedure

Step 1 Launch **Cura** software.

Step 2 Set slicing parameters.

1. Select **Machine > settings** on the Cura page.

The **Machine settings** page is displayed.

2. Set the corresponding parameters on the Machine settings and click **OK**, as shown in Figure 5.146. Table 5.16 lists the values of the parameters that need to be set. The other parameters are set by default.

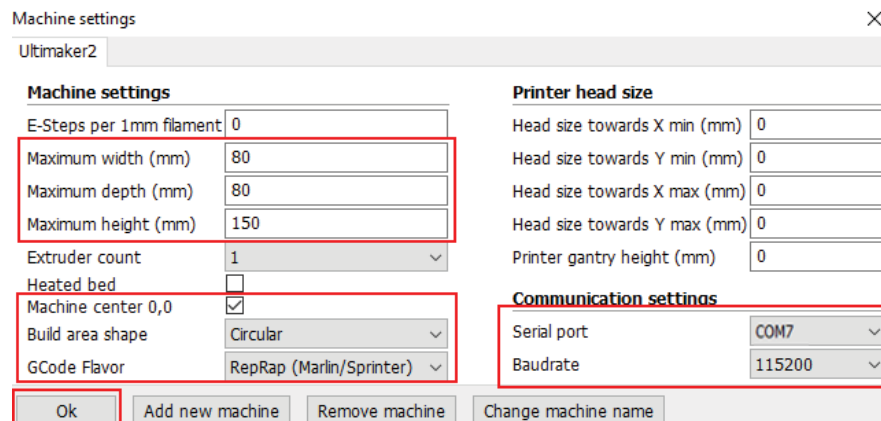

Figure 5.146 Parameters setting

Table 5.16 3D printing parameters description

Parameter	Description
Maximum width	The maximum width please set to 80mm
Maximum depth	The maximum with please set to 80mm
Maximum height	The maximum height Please set to 150mm
Machine center 0,0	Machine center, please select it

Parameter	Description
GCode Flavor	The style of GCode Please select RepRap Marlin/Sprinter
Build area shape	Build the area shape Please select Circular
Serial port	Serial port Please select the corresponding serial port
Baudrate	Baud rate Please set to 115200

- Set slice parameters, and select **File > Open Profile** to import these parameters, as shown in Figure 5.147.

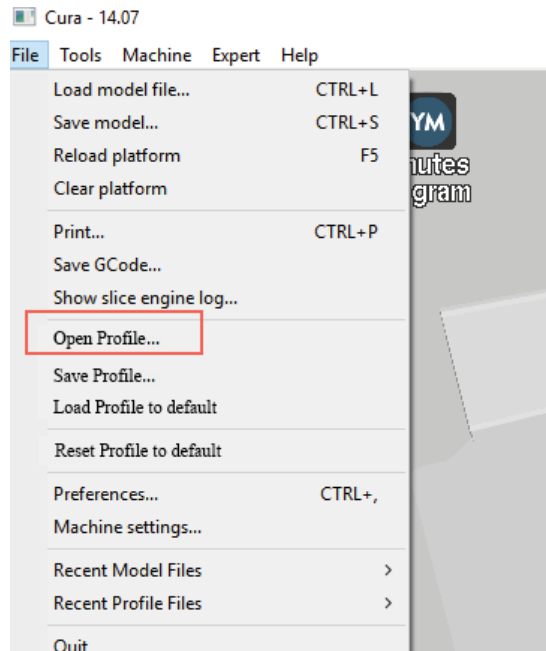

Figure 5.147 Import slice parameters

The 3D printing effect depends on the slice parameters. This topic provides a configuration sample, you can import it directly for printing.

The path of the configuration sample is *Installation directory\DobotStudio\attachment*, as shown in Figure 5.148.

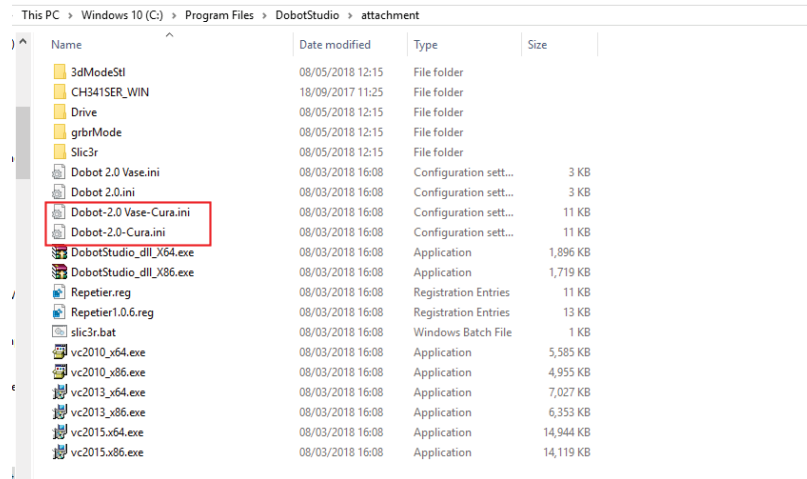



Figure 5.148 Configuration sample

Dobot-2.0-Vase-Cura.ini is used for printing a thin-walled vase, while Dobot-2.0-Cura.ini is used for the filling, the filling rate is 20%.

- Click , the **Open 3D model** page is displayed, and select the 3D printing model prepared.

The format of 3D model is STL. You can design 3D model and transform it into STL format.

After importing the model, click the model itself, you can center, zoom or rotate, and so on, as shown in Figure 5.149.

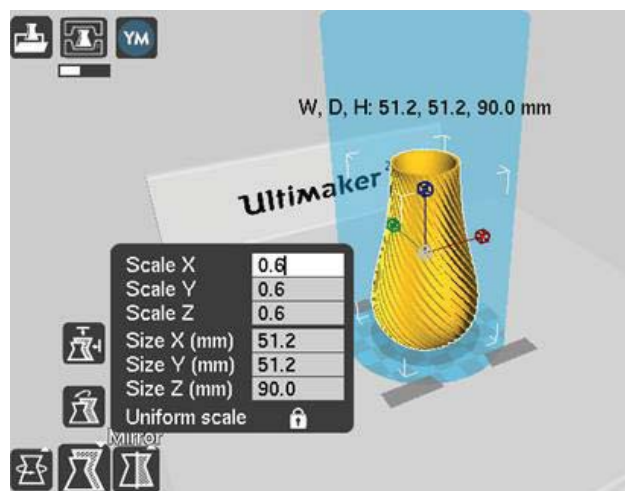



Figure 5.149 Zoom and rotate

- Click  to connect with Dobot Magician.

The printing window is displayed and the current printing temperature is shown on the top corner of the window, as shown in Figure 5.150.

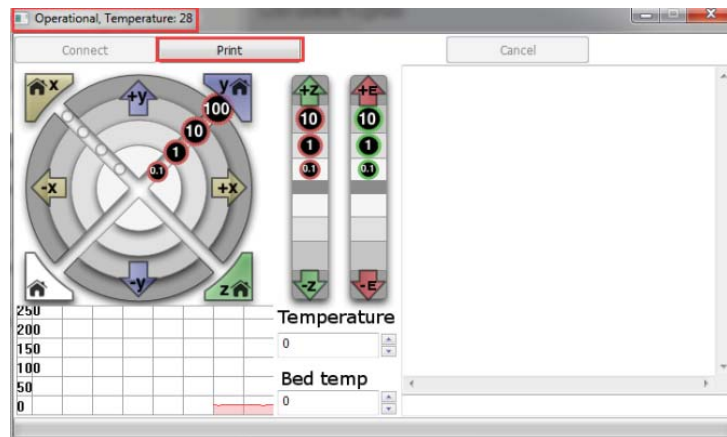

Figure 5.150 Printing window

6. Set **Temperature** to **200** and press down **Enter** to heat the extruder.

The temperature of the extruder should be above 170°C. Dobot Maigicain will not start 3D printing until the filament is in the melting state. So you need to heat the extruder first.

 **DANGER**

The heating rod will produce high temperature up to 250°C, please be careful. Do not let children play with it alone. The process needs to be monitored when it is running. After the process is completed, please turn off the equipment promptly.

Step 3 Test the extruder.

Before printing, you need to test the extruder to check whether the melted filament flows from the nozzle of the extruder.

Click the feedstock extruder or click the given stepper, such as **10**, **1**, **0.1** (**10** is recommended) on the **Operational** page and feed up to 10mm-30mm, as shown in Figure 5.151.

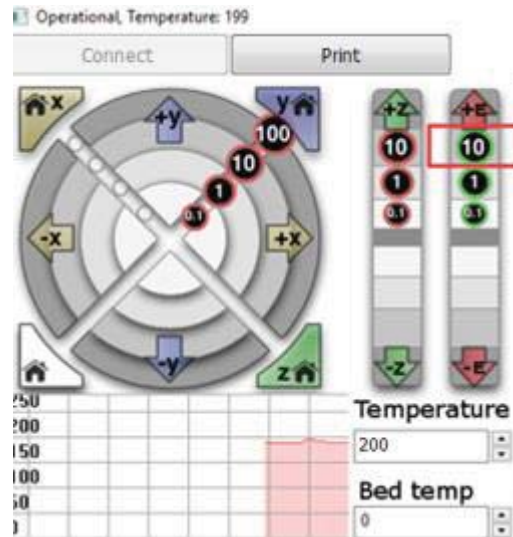

Figure 5.151 Click feedstock extruder

If the melted filament flows from the nozzle of the extruder, the extruder is working properly.

NOTICE

If the filament extrusion is in the opposite direction, please remove the filament, and turn the extruder around, then re-push down the filament.

Step 4 Adjust the printing space and get printing coordinates.

NOTE

During printing, if the distance from Dobot Magician to the printing platform is too large or too small to paste the first layer, it can lead to the nozzle blockage. For increasing the stickiness of the first layer, placing a masking paper on the platform is recommended.

1. Press the **Unlock** key on the Forearm and drag Dobot Magician to make the printing head contact the surface of the masking paper (The distance between the printing head and the surface of the masking paper is the thickness of a sheet of A4 paper), then release the **Unlock** key.
2. Input command **M415** on the lower right of the **Operational** page to get the current coordinates, as shown in Figure 5.152.

Also, you can press the **Key** button on the back of the base to get the current coordinates.

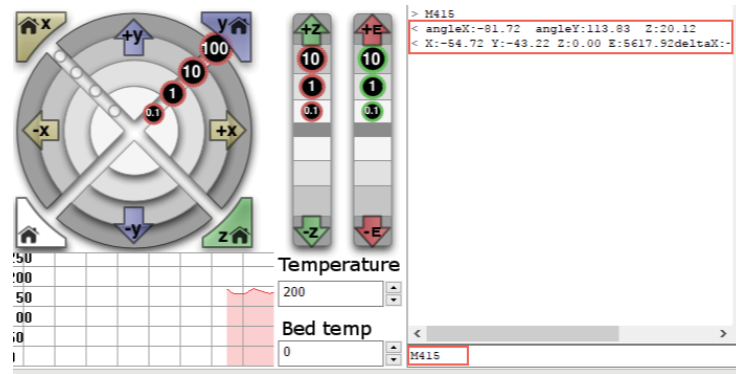

Figure 5.152 Input command M415

Step 5 Click **Print**, Dobot Magician moves to the printing origin (System setting) and starts printing.

5.10 Calibration

5.10.1 Base Calibration

The base Encoder has been calibrated before being shipped out. Generally, the J1-coordinate is 0° after homing, where the homing point is the system default. Namely, the Forearm is located at the middle in front of the base.

If the J1-coordinate is not 0° (error range: $1^\circ - 3^\circ$) after homing, you need to re-calibrate the base Encoder.

Prerequisites

- The writing and drawing kit has been installed. For details, please see *5.4.1 Installing a Writing and drawing kit*.
- Dobot Magician has been powered on.
- Dobot Magician has been connected to DobotStudio successfully.
- The sensor calibration board has been prepared.

Procedure

Step 1 Place the Dobot Magician at the right position on the sensor calibration board, as shown in Figure 5.153.



Figure 5.153 Location of Dobot Magician

Step 2 (Optional) Set the homing point and make the nib contact the surface of the calibration board.

This step is used for observing the nib position on the calibration board when moving J1-axis in **Step 5**, to improve calibration accuracy.

1. Click **Teaching & Playback** on the DobotStudio page.

The **Teaching & Playback** page is displayed.

2. Press the **Unlock** key on the Forearm and drag Dobot Magician to make the nib contact the surface of the calibration board, then release the **Unlock** key.

The coordinates of this point will be displayed on the **Teaching & Playback** page.

3. Select this point and right-click **SetHome**, as shown in Figure 5.154.

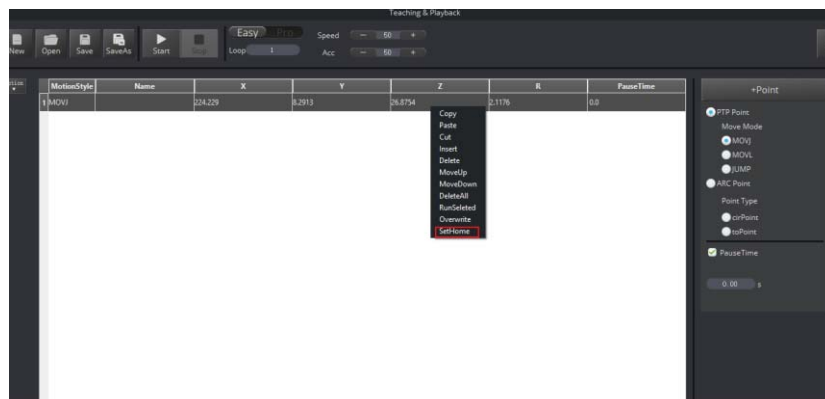

Figure 5.154 Set homing position

- Step 3** Click **Setting > Base Calibration** on the DobotStudio page.
The **Base Calibration** page is displayed.
- Step 4** Click **Next** on the **Base Calibration** page.
Dobot will start homing. Please ensure that there are no obstacles in the workspace during homing.
- Step 5** Click **+J1** or **-J1** to make the nib at a point on the line between **A3** and **B3** on the calibration board, as shown in Figure 5.155 and Figure 5.156.
If the speed is too fast when moving J1-axis, you can drag **Speed** slider to adjust speed.

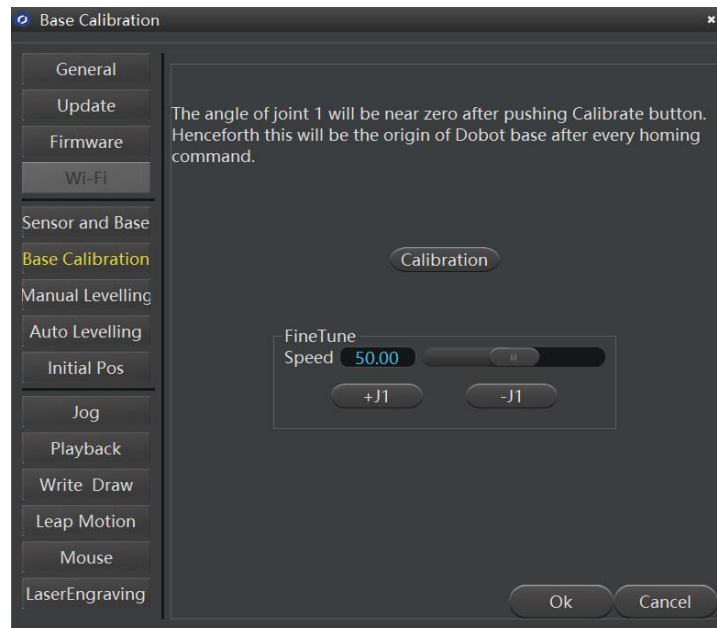

Figure 5.155 Move J1-axis



Figure 5.156 Nib position

Step 6 Click **Calibration** to start calibrating the base Encoder.

You can check the J1-coordinate on the **Operation Panel** page, as shown in Figure 5.157.



Figure 5.157 J1-coordinate

5.10.2 Sensor Calibration

The angle sensors of the Forearm and Rear Arm have been calibrated before being shipped out. Generally, the Z-coordinate will remain the same when moving Dobot Magician in the same horizontal plane. If changed, you need to recalibrate the angle sensors by manual levelling or auto levelling to improve the positioning accuracy.

- **Manual Levelling:** It is more accurate to calibrate manually with DobotStudio, sensor calibration board, and writing and drawing kit, which is suitable for the application scenarios with high requirements for absolute positioning accuracy.
- **Auto Levelling:** It is simple and quick to calibrate automatically with DobotStudio and auto-levelling tool, which is suitable for the application scenarios without high

requirements for absolute positioning accuracy, such as writing and drawing, 3D printing.

5.10.2.1 Manual Levelling

Prerequisites

- Dobot Magician has been powered on.
- Dobot Magician has been connected to DobotStudio successfully.
- The sensor calibration board has been prepared.

Procedure

Step 1 Place the Dobot Magician at the right position on the sensor calibration board, as shown in Figure 5.158.



Figure 5.158 Location of Dobot Magician

Step 2 Click **Setting > Manual Levelling** on the DobotStudio page.

The **Manual Levelling** page is displayed.

Step 3 Click **Next** on the **Manual Levelling** page.

Dobot Magician will finish the auto-compensation of the angle sensor coefficients of the Forearm and Rear Arm move according to the system settings. The result is as shown in Figure 5.159.

NOTICE

Please remove all end-effectors from Dobot Magician before calibrating

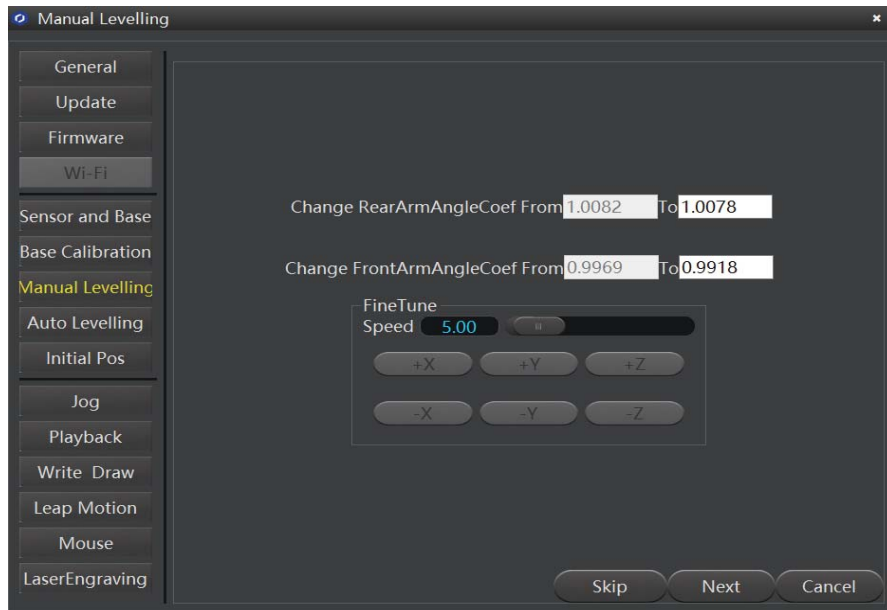

Figure 5.159 Get the angle sensor coefficients

Step 4 Click **Next** and set **Angle Precision**, **Distance Precision**, **Result Range**.

In this step, please keep the default values, as shown in Figure 5.160.

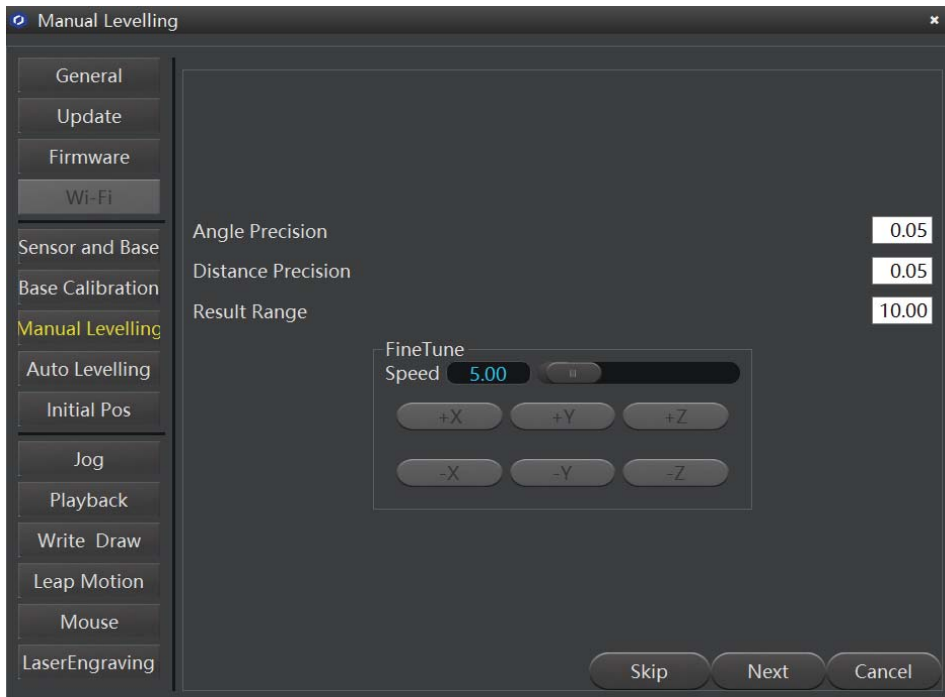

Figure 5.160 Set precisions

Step 5 Click **Next** and follow the instructions on the **Manual Levelling** page to move Dobot Magician to the first calibrated point. If the calibrated point is **A3** on the Calibration board.

1. Install the writing and drawing kit. For details, please see *5.4.1 Installing a Writing and drawing kit*.
2. Press the **Unlock** key on the Forearm and drag Dobot Magician to make the nib near the **A3** point on the calibration board, then release the **Unlock** key.
3. Click coordinate buttons on the **Manual Levelling** page (as shown in Figure 5.161) to make the nib align to the center of A3 point on the calibration board, as shown in Figure 5.162.

If the speed is too fast when clicking coordinate buttons, you can drag **Speed** slider to adjust speed.

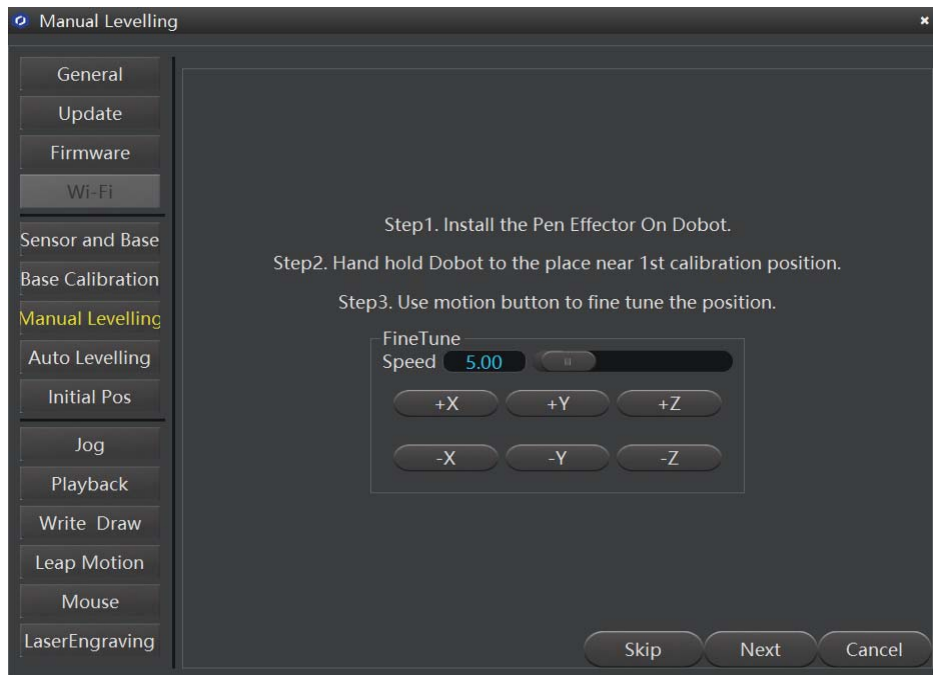

Figure 5.161 Fine-tune page

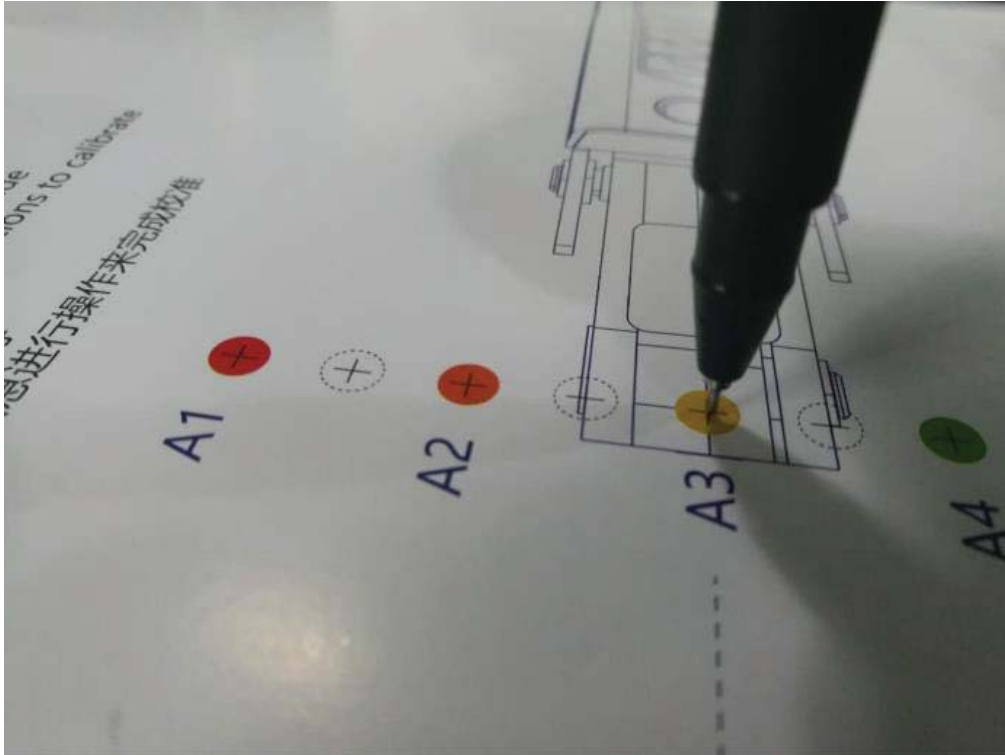

Figure 5.162 Nib position

Step 6 Click **Next** and follow the instructions on the **Manual Levelling** page (as shown in Figure 5.163) to move Dobot Magician to make the nib in the center of the second calibrated point. If the calibrated point is **B3** on the calibration board, as shown in Figure 5.164.

 **NOTICE**

Please **DO NOT** drag Dobot Magician in this step, to avoid manual levelling failure. If the speed is too fast when clicking coordinate buttons, you can drag **Speed** slider to adjust speed.

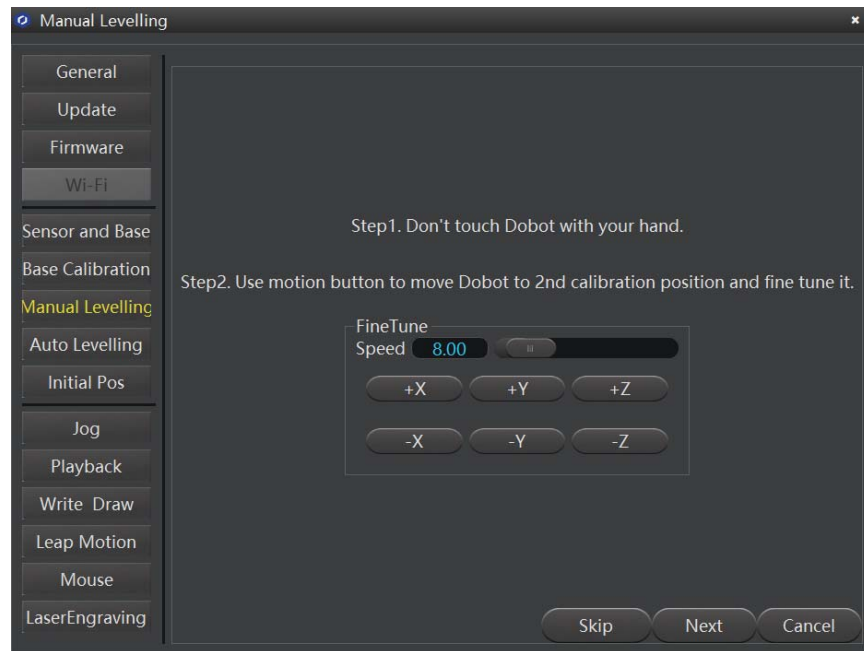

Figure 5.163 Fine-tune page

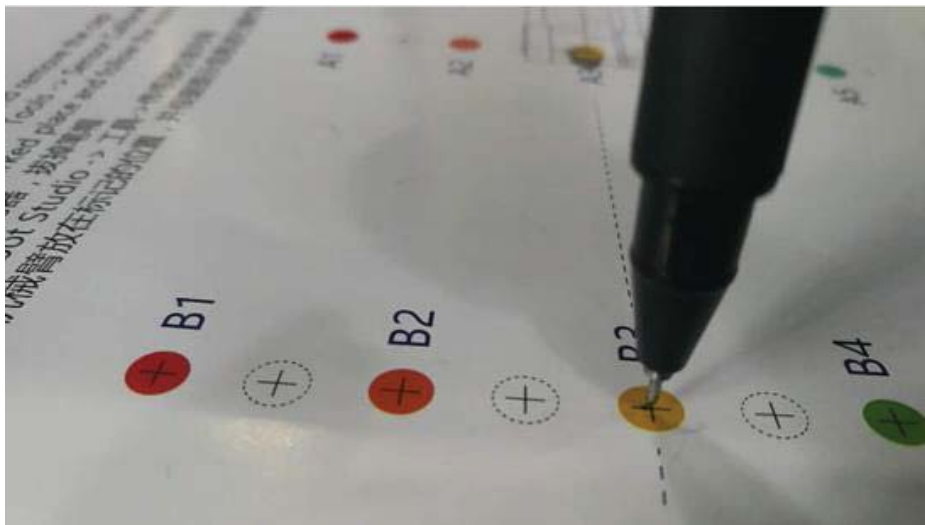

Figure 5.164 Nib position on the second calibrated point

Step 7 Click **Next** and set the distance between the two calibrated points, as shown in Figure 5.165.

The distance between the two calibrated points on the Calibration board is 80mm, so please keep the default value in this step.

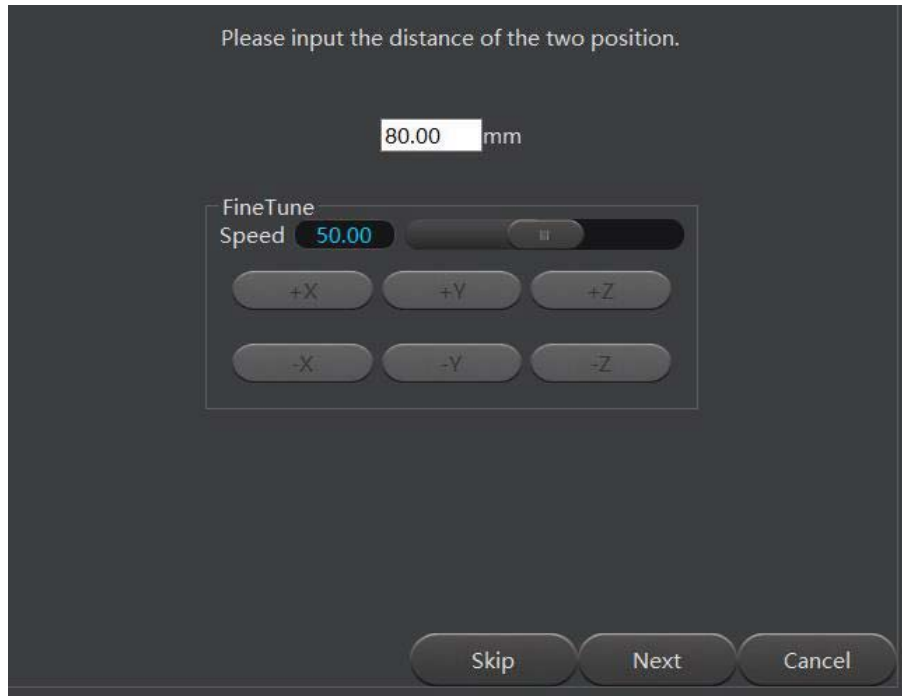

Figure 5.165 Set the distance between the two calibrated points

Step 8 Click **Next** to start calibrating.

The result is shown as Figure 5.166.

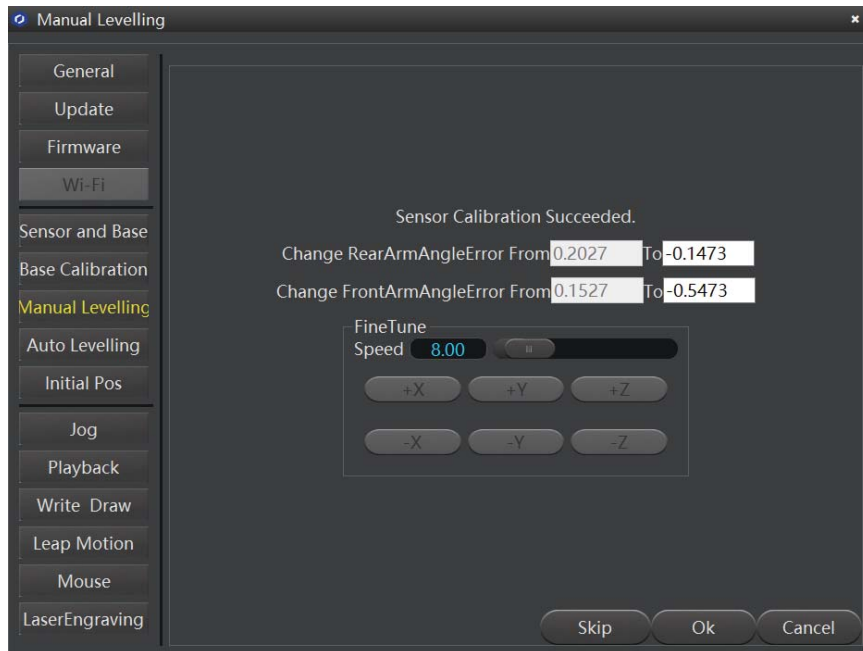

Figure 5.166 Calibrating result

5.10.2.2 Auto Levelling

Prerequisites

- Dobot Magician has been connected to a PC via USB cable.
- Dobot Magician has been connected to the power adapter.
- The auto-levelling tool has been obtained, as shown in Figure 5.167.



Figure 5.167 Auto-levelling tool

Procedure

Step 1 Place Dobot Magician on the flat platform.

 NOTICE

Please ensure that the platform is flat. Or, the auto levelling will be failed.

Step 2 Fix the auto-levelling tool on the Dobot Magician with butterfly nut, as shown in Figure 5.168.



Figure 5.168 Fix auto-levelling tool

Step 3 Insert the cable of the auto-levelling tool to the interface **2** on the Forearm, as shown in Figure 5.169.



Figure 5.169 Insert the cable of the auto-levelling

Step 4 Power on Dobot Magician and connect it to DobotStudio.

Step 5 Click **Setting > Auto Levelling** on the DobotStudio page.

The Auto Levelling page is displayed, as shown in Figure 5.170.

 **NOTICE**

Please ensure that there are no obstacles in the workspace during auto levelling.

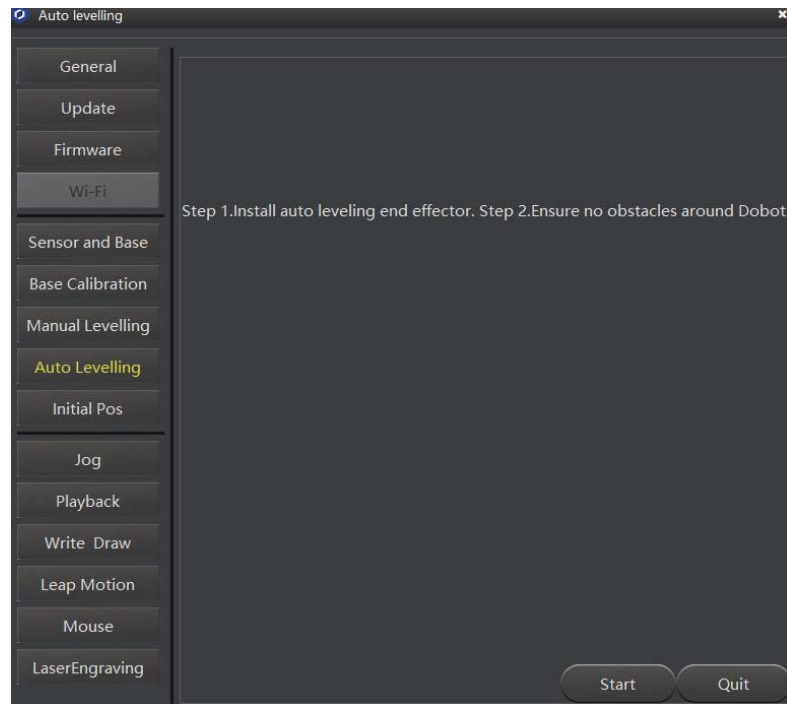

Figure 5.170 Auto levelling page

Step 6 Click **Start** on the **Auto Levelling** page.

Dobot Magician starts auto levelling. The levelling process will take about 2 minutes. The result is shown as Figure 5.171.

 **NOTE**

If the auto levelling is failed, please check if the platform is flat and try again.

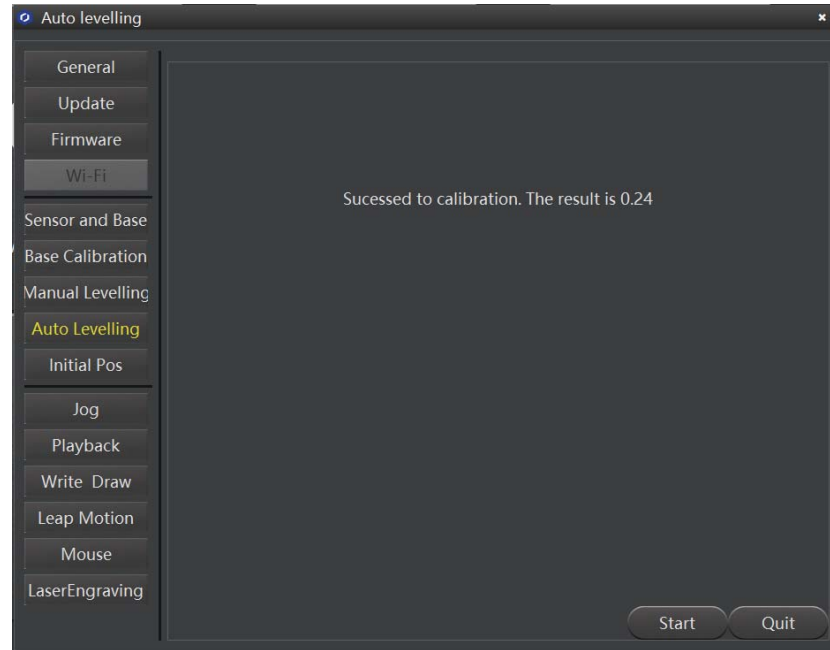

Figure 5.171 Auto levelling result

5.10.3 Homing

Dobot Magician has been calibrated before being shipped out. If the Dobot Magician has been hit or the motor has lost step, leading data abnormal, you need to operate homing to improve the positioning accuracy.

Prerequisites

- Dobot Magician has been powered on.
- Dobot Magician has been connected to DobotStudio successfully.

Procedure

Click **Home** on the DobotStudio page, as shown in Figure 5.172.

⚠ NOTICE

- Please remove the end-effector from the Dobot Magician before homing.
- Please ensure that there are no obstacles in the workspace during homing.

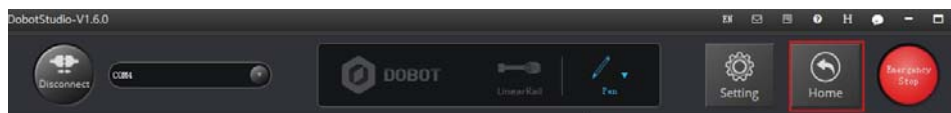

Figure 5.172 Operate homing

Dobot Magician will rotate clockwise to the limited position and then return to the default homing point automatically and the LED indicator on the base turns blue and is blinking. After the

homing is successful, there is a beep sound and the LED indicator turns green.

Also, the homing point can be use-defined, you can select a saved point on the **Teachong&Playback** page and right-click **SetHome** to set this saved point as the homing point, as shown in Figure 5.173.

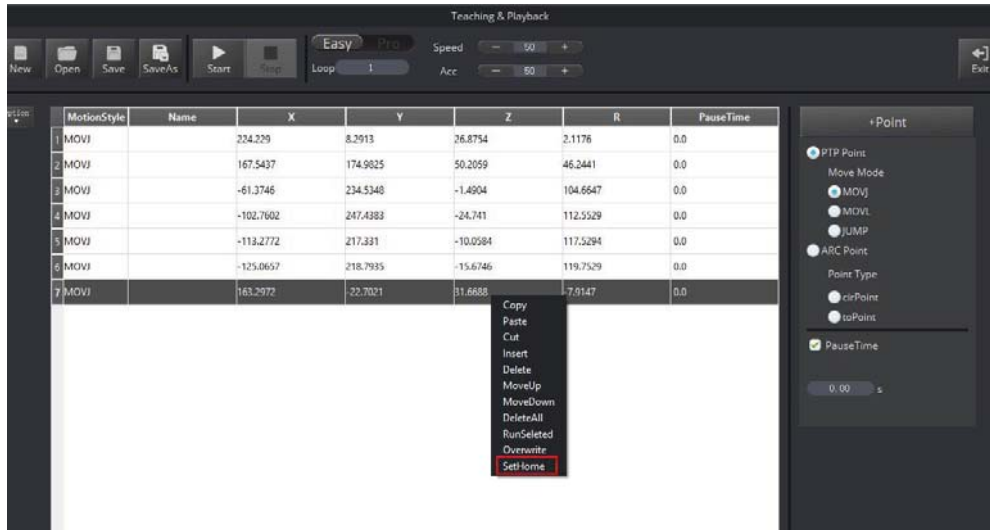

Figure 5.173 Set homing point

5.11 Connecting with WIFI Kit

You can connect Dobot Magician to a PC via WIFI kit without USB cable, making Dobot Magician and PC in the same WLAN. Figure 5.174 shows the WIFI kit.



Figure 5.174 WIFI kit

Prerequisites

- Dobot Magician has been connected to a PC via USB cable.

- Dobot Magician has been connected to the power adapter.
- The WIFI name and password have been obtained and must be the same as that of PC.

Procedure

Step 1 Connect the WIFI kit to the UART interface on the base, as shown in Figure 5.175.



Figure 5.175 Connect with WIFI kit

⚠ NOTICE

Please turn off the Dobot Magician completely first before connecting or disconnecting external equipment. Or, it causes serious damage to your device

Step 2 Press down the power button to turn on the Dobot Magician.

After turning on, there are two short beep sounds and the blue LED indicator on the WIFI module is on.

Step 3 Select the corresponding serial port from the serial drop-down list, and click **Connect**.

Step 4 Click **Setting > Wi-Fi**.

The **Set Dobot Wi-Fi** page is displayed.

Step 5 Set the related parameters on the **Set Dobot Wi-Fi** page.

In this topic, please select **Dynamic Host Configuration Protocol (DHCP)** and set **SSID** and **Password** to obtain the IP address of Dobot Magician, as shown in Figure 5.176.

If you unselect **Dynamic Host Configuration Protocol (DHCP)**, you need to set **IP address, Netmask, Gateway**. For details, please see Table 5.17.

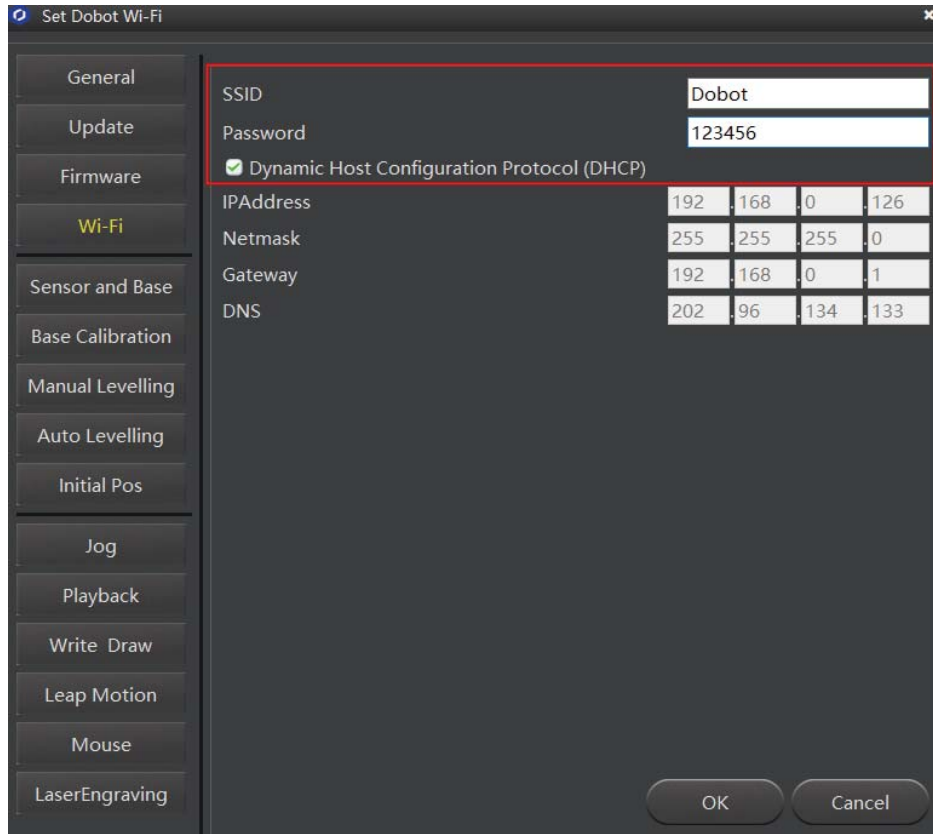

Figure 5.176 Set WIFI

Table 5.17 Parameter description

Parameter	Description
SSID	Set WIFI name The WIFI name and password have been obtained and must be the same as that of PC
Password	Set WIFI password
Dynamic Host Configuration Protocol (DHCP)	Whether to select DHCP Yes: Only set SSID and Password No: Only set IPAddress , Netmask and Gateway
IPAddress	Set the IP address of Dobot Magician. The IP address of Dobot Magician and the PC must be in the same WLAN without conflict.
Netmask	Set subnet mask
Gateway	Set gateway
DNS	Set DNS

Step 6 Click **OK**.

Issue V1.0 (2018-06-12)

User Guide

Copyright © Yuejiang Technology Co., Ltd.

About 5 seconds later, the green LED indicator on the WIFI module is on, indicating that the Dobot Magician has been connected with WLAN, as shown in Figure 5.177.



Figure 5.177 Status of LED indicator

- Step 7** Click **Disconnect** on the left pane of the DobotStudio page.
- Step 8** After 2 seconds later, select the IP address from the drop-down list on the upper left pane of the DobotStudio page and click **Connect**, as shown in Figure 5.178.

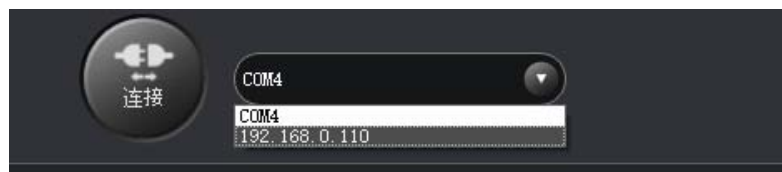

Figure 5.178 IP address of Dobot Magician

After the connection is successful, you can control Dobot Magician without USB cable.

5.12 Connecting with Bluetooth Kit

Dobot Magician can be connected to smart phone with Bluetooth. Figure 5.179 shows the Bluetooth kit. Please download the matched DobotStudio APP from the website https://cn.dobot.cc/downloadcenter.html?sub_cat=69#sub-download.



Figure 5.179 Bluetooth kit

Prerequisites

- Dobot Magician has been connected to the power adapter.
- The DobotStudio APP has been downloaded.

Procedure

- Step 1** Connect the Bluetooth kit to the UART interface on the base, as shown in Figure 5.180.



Figure 5.180 Connect with Bluetooth kit

⚠ NOTICE

Please turn off the Dobot Magician completely first before connecting or disconnecting external equipment. Or, it causes serious damage to your device.

Step 2 Press down the power button to turn on the Dobot Magician.

After turning on, there are three short beep sounds and the blue LED indicator on the Bluetooth module is on and the green one is blinking.

Turn on the Bluetooth and launch DobotStudio APP on your phone. And click **Connect** to connect with Dobot Magician.

This topic only describes how to connect Bluetooth kit. For details how to operate Dobot Magician with DobotStudio APP, please see <https://www.youtube.com/watch?v=kyeXwuf17IY>.

5.13 Operating Blockly

Blockly is a programming platform based on Google Blockly. You can program through the puzzle format, which is straightforward and easy to understand.

Prerequisites

- Dobot Magician has been powered on.
- Dobot Magician has been connected to DobotStudio successfully.

Procedure

Step 1 Click **Blockly** on the DobotStudio page.

The **Blockly** page is displayed.

Step 2 Drag the blockly module on the left pane of the **Blockly** page to program, as shown in Figure 5.181.

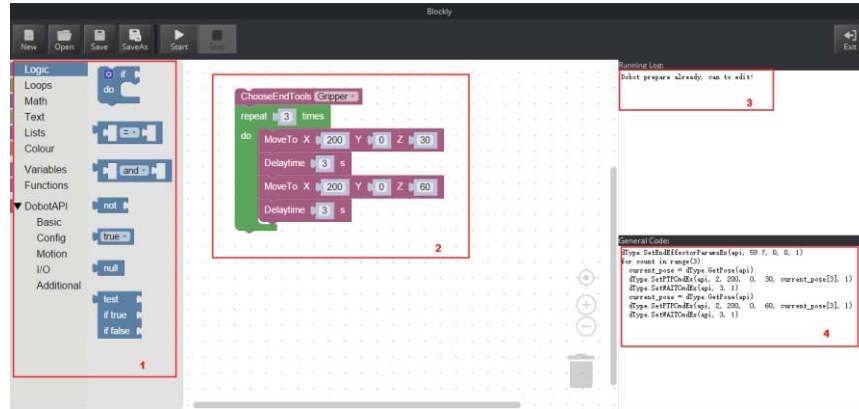

Figure 5.181 Blockly graphic programming

Table 5.18 lists the description of blockly module.

Table 5.18 Blockly description

No.	Description
1	The selection area of blockly module, including logistic, loop, math, and Dobot API. You can program by dragging them to the window.
2	The window of blockly programming
3	The running log of Dobot Magician
4	The corresponding codes of the blockly module on the programming window

The demo in Figure 5.181 is described as follows.

1. Set the end-effector as **Gripper**.
2. Set the loop number as 3 and make the Z-axis move back and forth 3 times.
3. Set the pause time as 3.

Step 3 Click **Save** on the **Blockly** page.

The Saving Blockly file page is displayed.

Step 4 Input the use-defined name and the saving path, and click **Save**. The default path of

the programming file is *Installation directory/DobotStudio/config/bystore*. Please replace the path based on site requirements.

Step 5 Click **Start** on the **Blockly** page, and Dobot Magician will move according to the program.

5.14 Scripting

You can control Dobot Magician over scripting. Dobot Magician supports various API, such as velocity/acceleration setting, motion mode setting, and I/O configuration, which uses Python language for secondary development. For details about the Dobot Magician API interface and function description, please see *Dobot Magician API Description*.

The download path is https://www.dobot.cc/downloadcenter.html?sub_cat=72#sub-download.

Prerequisites

- Dobot Magician has been powered on.
- Dobot Magician has been connected to DobotStudio successfully.

Procedure

Step 1 Click **Script** on the **DobotStudio** page.

The **Script** page is displayed.

Step 2 Write a script.

You can call the interface by double-clicking on the left pane of the **Script** page, the corresponding interface will be displayed on the middle pane, as shown in

Figure 5.182. You can also click  icon of the corresponding interface to view the way how to set the parameters. The scripting examples (including Jog, PTP, and Pallet) can refer to *Installation directory/DobotStudio/config/ststore/*.

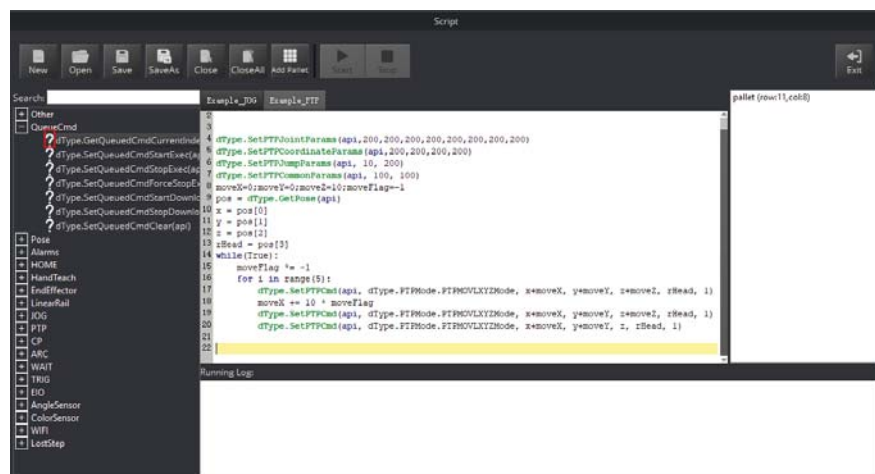

Figure 5.182 Write a script

- Step 3** Click **Save** on the **Script** page.
The Saving Scrip File page is displayed.
- Step 4** Input the use-defined name and the saving path, and click **Save**.
The default path of the script is *Installation directory/DobotStudio/config/ststore*.
Please replace the path based on site requirements.
- Step 5** Click **Start**, and Dobot Magician will move according to the script file.
The running log will be displayed on the lower pane of the **Script** page for checking.

5.15 Operating Stick Controller Kit

Dobot Magician can be controlled by stick controller kit without DobotStudio. Figure 5.183 shows the stick controller kit. From left to right: Stick controller, USB Host module, USB cable (used for charging stick controller), Transceiver.



Figure 5.183 Stick controller kit

Prerequisites

- Dobot Magician has been connected to a PC over USB cable.
- Dobot Magician has been connected to the power adapter.

Procedure

- Step 1** Connect the transceiver to the USB module.
- Step 2** Connect the USB Host module to the UART interface on the base, as shown in Figure 5.184.



Figure 5.184 Connect with USB Host module

Step 3 Press down the power button to turn on the Dobot Magician.

The blue LED indicator on the USB Host module is on. After turning on, there are four short beep sounds and the green one is on.

 NOTICE

Please turn off the Dobot Magician completely first before connecting or disconnecting external equipment. Or, it causes serious damage to your device.

Step 4 Press down the power button on the stick controller, as shown in Figure 5.185.

The red LED indicator on the middle of the stick controller is blinking, indicating that the Dobot Magician can be controlled by the stick controller.



Figure 5.185 Power button of the stick controller

Table 5.19 lists the functions of buttons on the stick controller.

Table 5.19 Button function

Button	Function
Power button	Turn on stick controller The stick controller will turn off automatically
LT	Turn on the peripheral motor
RT	Turn off the peripheral motor off
RB	Switch to Cartesian coordinate system mode
LB	Switch to Joint coordinate system mode
X	Control the outtake of the air pump
Y	Control the intake of the air pump
B	Turn off the air pump
Left stick: Front/back	<ul style="list-style-type: none"> Cartesian coordinate system mode: Dobot Magician moves along X-axis in the positive/negative direction Joint coordinate system mode: Dobot Magician rotates along J1-axis in the positive/negative direction
Left stick: Left/right	<ul style="list-style-type: none"> Cartesian coordinate system mode: Dobot Magician moves along Y-axis in the

Button	Function
	<p>positive/negative direction</p> <ul style="list-style-type: none"> Joint coordinate system mode: Dobot Magician rotates along J2-axis in the positive/negative direction
Right stick: Front/back	<ul style="list-style-type: none"> Cartesian coordinate system mode: Dobot Magician moves along Z-axis in the positive/negative direction Joint coordinate system mode: Dobot Magician rotates along J3-axis in the positive/negative direction
Right stick: Left/right	<ul style="list-style-type: none"> Cartesian coordinate system mode: Dobot Magician rotates along R-axis in the positive/negative direction Joint coordinate system mode: Dobot Magician rotates along J4-axis in the positive/negative direction

5.16 Multiplexed I/O Demo

The addresses of the I/O interfaces in Dobot Magician are unified. Most of I/O interfaces have multiple functions. For details, please see 4.3 Multiplexed I/O Interface Description.

You can set I/O interfaces on the advanced **Teaching&Playback** page to control the peripheral equipment, as shown in Figure 5.186.

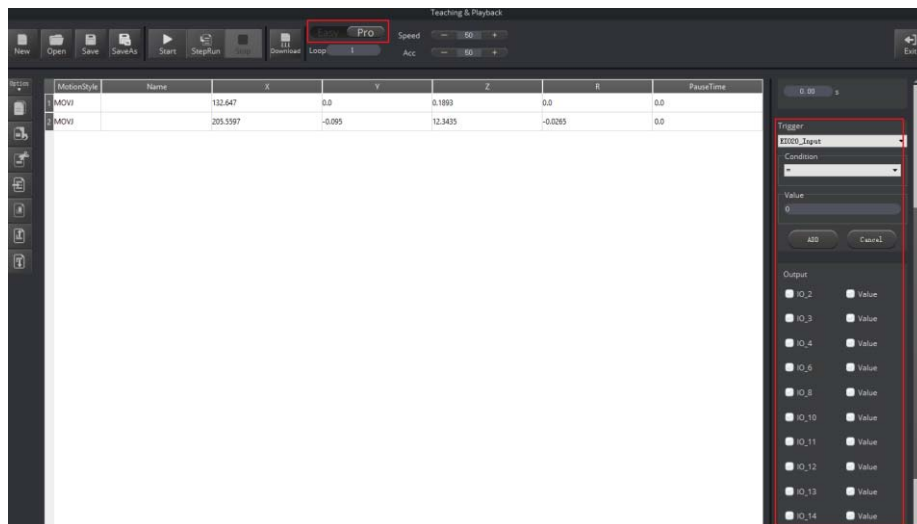

Figure 5.186 I/O setting page

Now, demos of level output, level input, and PWM output are given below.

5.16.1 Level Output

Normally, air pump can be controlled by the I/O interfaces. The I/O 11 controls its intake (High level) and outtake (Low level) and the I/O 16 controls its start-stop. Table 5.20 lists the multiplexed descriptions of I/O 11 and I/O 16.

Table 5.20 Multiplexed I/O description

I/O addressing	Voltage	Level Output	PWM	Level Input	ADC
11	3.3V	√	√	-	-
16	12V	√	-	-	-

The I/O 11 and I/O 16 are located at the peripheral interface of the base, as shown in Figure 5.187.

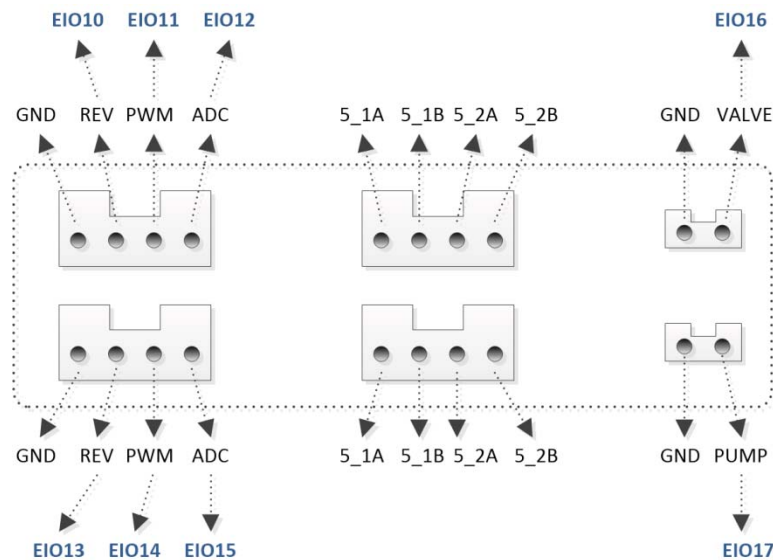

Figure 5.187 Peripheral Interface on the base

Prerequisites

- The air pump has been connected to Dobot Magician. For details, please see 5.2.1 *Installing a Suction Cup Kit*.
- Dobot Magician has been powered on.
- Dobot Magician has been connected to DobotStudio successfully.

Procedure

Step 1 Select **Pen** from the end-effector drop-down list on the DobotStudio page, as shown in Figure 5.188.

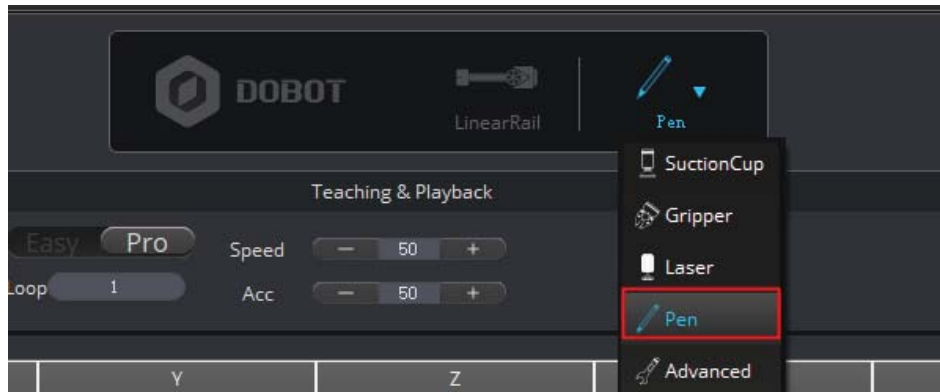

Figure 5.188 Select end-effector

⚠NOTICE

Normally, If **SuctionCup** or **Gripper** is selected from the end-effector drop-down list after the air pump has been connected, the air pump will be controlled by the system. In this topic, we use I/O interfaces to control the air pump, so **SuctionCup** and **Gripper** cannot be selected, to avoid conflict.

- Step 2** Click **Easy** icon on the **Teaching&Playback** page, as shown in Figure 5.189.

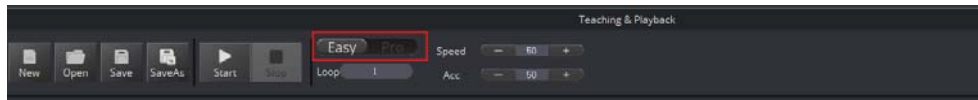

Figure 5.189 Switch advanced function

- Step 3** Select **IO_11**, **IO_16** and their corresponding **Value** on the **Output** pane, and click **+Point**.

“The saved point is displayed on the **Teaching&Playback** page, as shown in Figure 5.190.

📖NOTE

If the intake is not obvious, please modify **PauseTime** of this saved point.

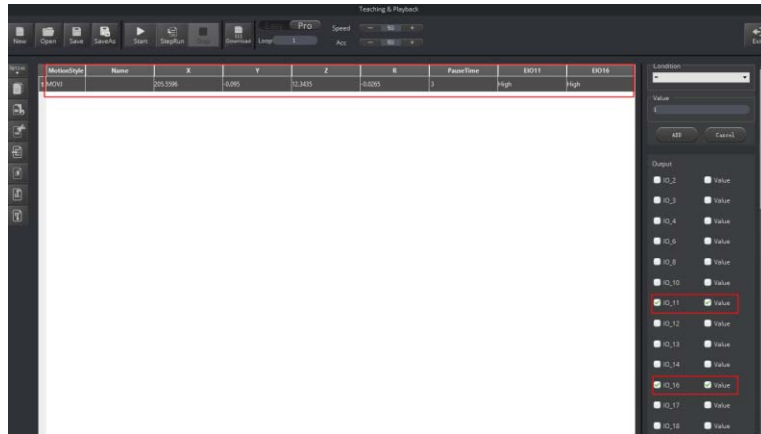

Figure 5.190 Saved point

Step 4 Select this point and click **StepRun**.

The air pump is humming with intake.

Step 5 Select **IO_11**, **IO_16** and the corresponding **Value** of **IO_16** on the Output pane, and click **+Point**.

The saved point is displayed on the **Teaching&Playback** page, as shown in Figure 5.191.

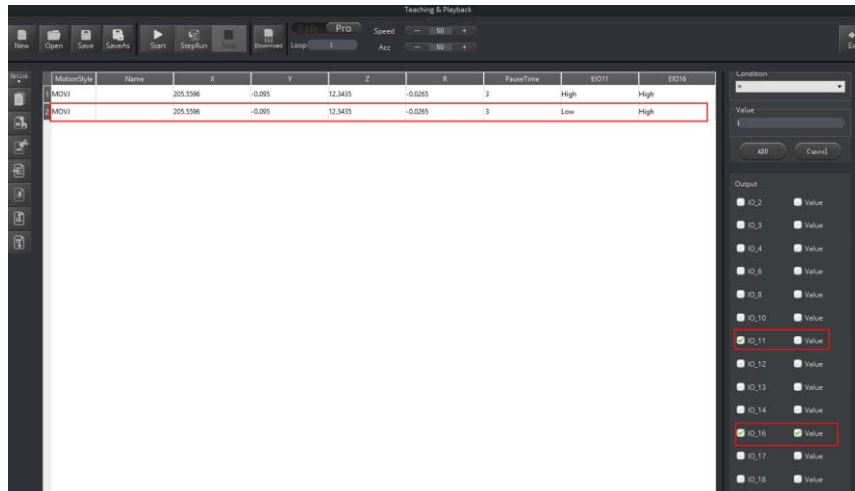

Figure 5.191 Saved point

Step 6 Select this point and click **StepRun**.

The air pump is humming with outtake.

5.16.2 Level Input

This topic also takes I/O 12 as an example.

Table 5.21 Multiplexed I/O description

I/O addressing	Voltage	Level Output	PWM	Level Input	ADC
12	3.3V	-	-	√	-

Prerequisites

- Dobot Magician has been powered on.
- Dobot Magician has been connected to DobotStudio successfully.
- The saved points list has been existed on the **Teaching&Playback** page.

Procedure

Step 1 Click  icon on the **Teaching&Playback** page, as shown in Figure 5.192.

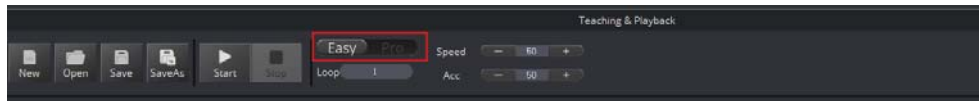

Figure 5.192 Switch advanced function

Step 2 Select a saved point on the **Teaching&Playback** page.

Step 3 Select **EIO11_Input** on the **Trigger** pane, and set **Condition** and its **Value**. Here, **Value** only can be set to **0** or **1**. **1**: High level; **0**: Low level.

Step 4 Click **ADD**, as shown in Figure 5.193.

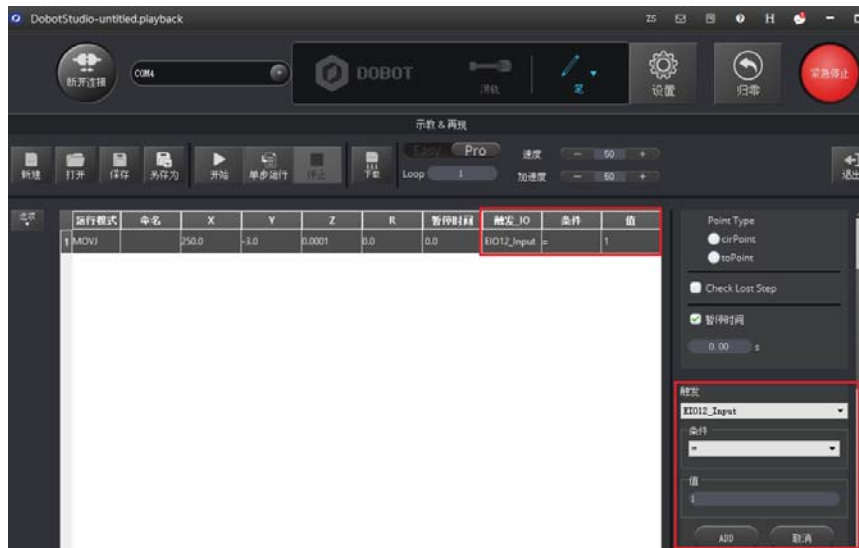

Figure 5.193 Saved point

5.16.3 PWM OUTPUT

This topic also takes I/O 11 as an example.

Table 5.22 Multiplexed I/O description

I/O addressing	Voltage	Level Output	PWM	Level Input	ADC
11	3.3V	√	√	-	-

Prerequisites

- Dobot Magician has been powered on.
- Dobot Magician has been connected to DobotStudio successfully.

Procedure

Step 1 Click  icon on the **Teaching&Playback** page, as shown in Figure 5.194.



Figure 5.194 Switch advanced function

Step 2 Select **IO_11** on the Output pane, and click **+Point**, as shown in Figure 5.195.

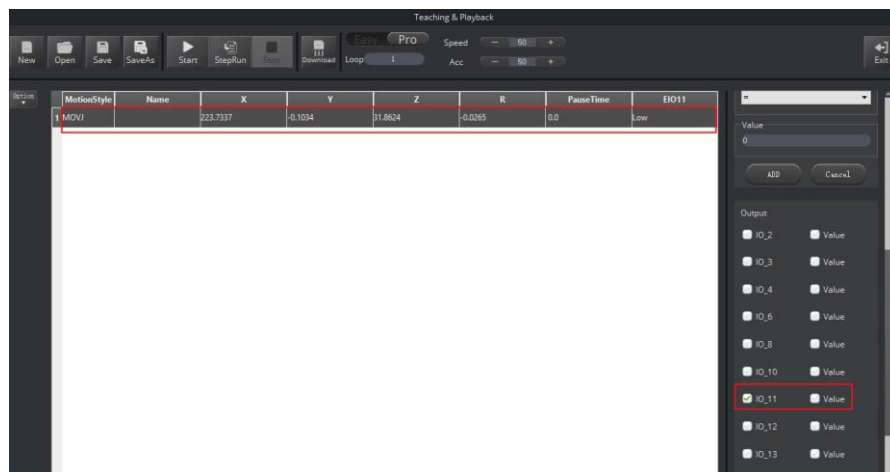

Figure 5.195 Saved point

Step 3 Double-click **EIO11** cell and select **...** from the drop-down list. The **EIO Setting** page is displayed, as shown in Figure 5.196.

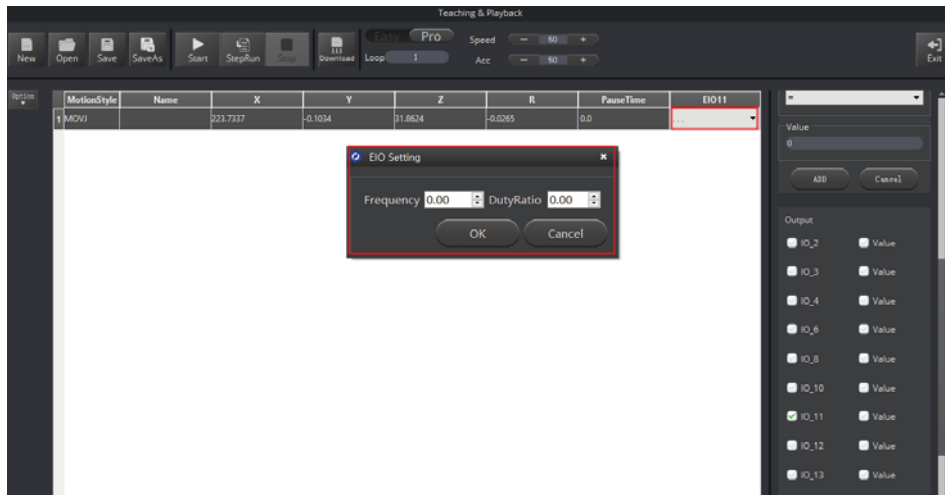

Figure 5.196 EIO setting

Step 4 Set **Frequency** (Unit: KHZ; Value range: 10HZ-1MHZ) and **DutyRatio** (0%-100%) on the **EIO Setting** page.

FCC Statement

This device complies with Part 15 of the FCC rules. Operation is subject to the following two conditions: 1) this device may not cause harmful interference, and 2) this device must accept any interference received, including interference that may cause undesired operation.

Note: This equipment has been tested and found to comply with the limits for a Class B digital device, pursuant to part 15 of the FCC Rules. These limits are designed to provide reasonable protection against harmful interference in a residential installation. This equipment generates uses and can radiate radio frequency energy and, if not installed and used in accordance with the instructions, may cause harmful interference to radio communications. However, there is no guarantee that interference will not occur in particular installation. If this equipment does cause harmful interference to radio or television reception, which can be determined by turning the equipment off and on, the user is encouraged to try to correct the interference by one or more of the following measures:

- Reorient or relocate the receiving antenna.
 - Increase the separation between the equipment and receiver.
 - Connect the equipment into an outlet on a circuit different from that to which the receiver is connected.
 - Consult the dealer or an experienced radio/TV technician for help.
- Changes or modifications not expressly approved by the party responsible for compliance could void the user's authority to operate the equipment.

FCC Radiation Exposure Statement

For Bluetooth kit and WIFI kit:

This device complies with FCC RF radiation exposure limits set forth for an uncontrolled environment. This transmitter must not be co-located or operating in conjunction with any other antenna or transmitter.

This device must operate with a minimum distance of 20 cm between the radiator and user body.

IC Note:

This device complies with Industry Canada's licence-exempt RSSs. Operation is subject to the following two conditions:

- (1) This device may not cause interference; and
- (2) This device must accept any interference, including interference that may cause undesired operation of the device.

Cet appareil est conforme aux CNR exemptes de licence d'Industrie Canada . Son fonctionnement est soumis aux deux conditions suivantes :

- (1) Ce dispositif ne peut causer d'interférences ; et
- (2) Ce dispositif doit accepter toute interférence , y compris les interférences qui peuvent causer un mauvais fonctionnement de l'appareil.