



FCC Part 15C Test Report

FCC ID: 2AHHYPTS-018

Product Name:	Remote dog training
Trademark:	
Model Name :	PTS-018 PTS-008, PTS-015, PTS-108, PTS-118, p-collar 310, p-collar 320, p-collar 330, p-collar 340, p-collar 610, p-collar 620, p-collar 630, p-collar 640, p-collar 810, p-collar 820, p-collar 910, p-collar 920, p-nobark310, p-nobark320
Prepared For :	Shenzhen Patpet Technology Co., Ltd
Address :	Room 309,Hengfengyuan Business Building, BanAn 72 District, Shenzhen, Guangdong, China
Prepared By :	Shenzhen BCTC Technology Co., Ltd.
Address :	No.101,Yousong Road,Longhua New District, Shenzhen,China
Test Date:	Feb. 19 - Feb. 24, 2016
Date of Report :	Feb. 24, 2016
Report No.:	BCTC-160201454E



VERIFICATION OF COMPLIANCE

Applicant's name..... : **Shenzhen Patpet Technology Co., Ltd**
 Address..... : Room 309,Hengfengyuan Business Building, BanAn 72
 District, Shenzhen, Guangdong, China
Manufacture's Name..... : **Shenzhen Patpet Technology Co., Ltd**
 Address..... : Room 309,Hengfengyuan Business Building, BanAn 72
 District, Shenzhen, Guangdong, China

Product description

Product name.....: Remote dog training

Trademark: 
 PTS-018
 PTS-008, PTS-015, PTS-108, PTS-118, p-collar 310,
 p-collar 320, p-collar 330, p-collar 340, p-collar 610,
 Model Name: p-collar 620, p-collar 630, p-collar 640, p-collar 810,
 p-collar 820, p-collar 910, p-collar 920, p-nobark310,
 p-nobark320

Test procedure FCC Part15.231

Standards ANSI C63.10-2013

This device described above has been tested by BCTC, and the test results show that the equipment under test (EUT) is in compliance with the FCC requirements. And it is applicable only to the tested sample identified in the report.

This report shall not be reproduced except in full, without the written approval of BCTC, this document may be altered or revised by BCTC, personal only, and shall be noted in the revision of the document.

Test Result : **Pass**

Testing Engineer : Eric Yang
 (Eric Yang)

Technical Manager : Sophie Lu
 (Sophia Lee)

Authorized Signatory : Carson Zhang
 (Carson. Zhang)





Table of Contents	Page
1 . SUMMARY OF TEST RESULTS	5
1.1 TEST FACILITY	6
1.2 MEASUREMENT UNCERTAINTY	6
2 . GENERAL INFORMATION	7
2.1 GENERAL DESCRIPTION OF EUT	7
2.2 DESCRIPTION OF TEST MODES	8
2.3 BLOCK DIGRAM SHOWING THE CONFIGURATION OF SYSTEM TESTED	8
2.4 DESCRIPTION OF SUPPORT UNITS(CONDUCTED MODE)	8
2.5 EQUIPMENTS LIST FOR ALL TEST ITEMS	9
3 . EMC EMISSION TEST	10
3.1 CONDUCTED EMISSION MEASUREMENT	10
3.1.1 POWER LINE CONDUCTED EMISSION LIMITS	10
3.1.2 TEST PROCEDURE	11
3.1.3 DEVIATION FROM TEST STANDARD	11
3.1.4 TEST SETUP	11
3.1.5 EUT OPERATING CONDITIONS	11
3.1.6 TEST RESULTS	11
3.2 RADIATED EMISSION MEASUREMENT	14
3.2.1 RADIATED EMISSION LIMITS	14
3.2.2 TEST PROCEDURE	15
3.2.3 TEST SETUP	16
3.2.4 EUT OPERATING CONDITIONS	17
3.2.5 TEST RESULTS	18
4 . BANDWIDTH TEST	23
4.1 APPLIED PROCEDURES / LIMIT	23
4.1.1 TEST PROCEDURE	23
4.1.2 DEVIATION FROM STANDARD	23
4.1.3 TEST SETUP	23
4.1.4 EUT OPERATION CONDITIONS	23
4.1.5 TEST RESULTS	24
5 . CALCULATION OF AVERAGE FACTOR	25
6 . DWELL TIME	28
6.1 DEVIATION FROM STANDARD	28
6.2 TEST SETUP	28



Table of Contents	Page
6.3 EUT OPERATION CONDITIONS	28
6.4 TEST RESULTS	29
7 . ANTENNA REQUIREMENT	30
7.1 STANDARD REQUIREMENT	30
7.2 EUT ANTENNA	30
8 . EUT TEST PHOTO	31
APPENDIX-PHOTOGRAPHS OF EUT CONSTRUCTIONAL DETAILS	



1. SUMMARY OF TEST RESULTS

Test procedures according to the technical standards:

FCC Part15 (15.231) , Subpart C			
Standard Section	Test Item	Judgment	Remark
15.207	Conducted Emission	PASS	
15.209,15.231b	Radiated Emission Test	PASS	
15.231c	20dB Occupy Bandwidth	PASS	
15.231a	Dwell time	PASS	
15.203	Antenna Requirement	PASS	

NOTE:

(1) "N/A" denotes test is not applicable in this Test Report



1.1 TEST FACILITY

Shenzhen BCTC Technology Co., Ltd.
Add.:No.101,Yousong Road,Longhua New District, Shenzhen,China
FCC Registration No.:187086

1.2 MEASUREMENT UNCERTAINTY

The reported uncertainty of measurement $y \pm U$, where expanded uncertainty U is based on a standard uncertainty multiplied by a coverage factor of $k=2$, providing a level of confidence of approximately **95 %**.

No.	Item	Uncertainty
1	Conducted Emission Test	$\pm 1.38\text{dB}$
2	RF power,conducted	$\pm 0.16\text{dB}$
3	Spurious emissions,conducted	$\pm 0.21\text{dB}$
4	All emissions,radiated(<1G)	$\pm 4.68\text{dB}$
5	All emissions,radiated(>1G)	$\pm 4.89\text{dB}$
6	Temperature	$\pm 0.5^{\circ}\text{C}$
7	Humidity	$\pm 2\%$



2. GENERAL INFORMATION

2.1 GENERAL DESCRIPTION OF EUT

Equipment	Remote dog training
Trade Name	
Model Name	PTS-018 PTS-008, PTS-015, PTS-108, PTS-118, p-collar 310, p-collar 320, p-collar 330, p-collar 340, p-collar 610, p-collar 620, p-collar 630, p-collar 640, p-collar 810, p-collar 820, p-collar 910, p-collar 920, p-nobark310, p-nobark320
Model Difference	All the models are the same circuit and RF module, except the model names and outlook color.
Product Description	The EUT is a Remote dog training
	Operation Frequency: 433.92MHz
	Modulation Type: ASK
	Antenna Designation: Internal Antenna
	Antenna Gain 1.2dBi
	Based on the application, features, or specification exhibited in User's Manual, the EUT is considered as an ITE/Computing Device. More details of EUT technical specification, please refer to the User's Manual.
Adapter	Model: XH-UL0510-A1 I/P: AC100-240V 50-60Hz 300mA O/P: DC 5V 1000mA
Battery	DC 3.7V DC 5V from adapter
Connecting I/O Port(s)	Please refer to the User's Manual
Hardware Version	---

Note:

1. For a more detailed features description, please refer to the manufacturer's specifications or the User's Manual.



2.2 DESCRIPTION OF TEST MODES

For All Emission	
Final Test Mode	Description
Mode 1	TX Mode

Note:

- (1) New battery is used during the test
- (2) The antenna is telescopic antenna, The worst mode is on max length(7cm).
- (3) For this device equipped with 4 buttons, all 4 buttons was pre-tested and the worst button was Increase the speed button and the data was recrding the report.

2.3 BLOCK DIGRAM SHOWING THE CONFIGURATION OF SYSTEM TESTED

Radiated Spurious Emission Test



2.4 DESCRIPTION OF SUPPORT UNITS(CONDUCTED MODE)

The EUT has been tested as an independent unit together with other necessary accessories or support units. The following support units or accessories were used to form a representative test configuration during the tests.

Item	Equipment	Mfr/Brand	Model/Type No.	Series No.	Note

Note:

- (1) The support equipment was authorized by Declaration of Confirmation.
- (2) For detachable type I/O cable should be specified the length in cm in 『Length』 column.
- (3) “YES” is means “shielded” “with core”; “NO” is means “unshielded” “without core”.



2.5 EQUIPMENTS LIST FOR ALL TEST ITEMS

For Conducted Emission at the mains terminals Test

Item	Equipment	Manufacturer	Model#	Serial#	Last Cal.	Next Cal.	Calibration period
1	EMI Receiver	R&S	ESCI	101421	2015.08.25	2016.08.24	1 year
2	LISN	SCHWARZBECK	NSLK8127	812779	2015.08.25	2016.08.24	1 year
3	Pulse Limiter	R&S	ESH3-Z2	100681	2015.08.25	2016.08.24	1 year
4	843 Cable 1#	FUJIKURA	843C1#	001	2015.08.25	2016.08.24	1 year

Radiation, 20db bandwidth, dwell time test equipment

Item	Kind of Equipment	Manufacturer	Type No.	Serial No.	Last calibration	Calibrated until	Calibration period
1	Spectrum Analyzer	Agilent	E4407B	MY45108040	2015.06.06	2016.06.05	1 year
2	Test Receiver	R&S	ESCI	1166.5950K03-101165-ha	2015.06.06	2016.06.05	1 year
3	Bilog Antenna	R&S	VULB9168	VULB9168-438	2015.06.06	2016.06.05	1 year
4	50Ω Coaxial Switch	Anritsu	MP59B	6200264416	2015.06.06	2016.06.05	1 year
5	Spectrum Analyzer	ADVANTEST	R3132	150900201	2015.06.06	2016.06.05	1 year
6	Horn Antenna	R&S	HF906	10027	2015.06.06	2016.06.05	1 year
8	Amplifier	R&S	BBV9743	9743-019	2015.06.06	2016.06.05	1 year
9	Loop Antenna	ARA	PLA-1030/B	1029	2015.08.06	2016.08.05	1 year
10	RF cables (9kHz~1GHz)	R&S	R203	R20X	2015.06.06	2016.06.05	1 year
11	Antenna connector (20db bandwidth, dwell time)	Florida RFLabs	Lab-Fle	RF 01#	2015.06.06	2016.06.05	1 year

Note: The temporary antenna connector is soldered on the PCB board in order to perform conducted tests and this temporary antenna connector is listed in the equipment list.



3. EMC EMISSION TEST

3.1 CONDUCTED EMISSION MEASUREMENT

3.1.1 POWER LINE CONDUCTED EMISSION Limits (Frequency Range 150KHz-30MHz)

FREQUENCY (MHz)	Class B (dBuV)		Standard
	Quasi-peak	Average	
0.15 -0.5	66 - 56 *	56 - 46 *	CISPR
0.0 -5.0	56.00	46.00	CISPR
5.0 -30.0	60.00	50.00	CISPR

0.15 -0.5	66 - 56 *	56 - 46 *	FCC
0.50 -5.0	56.00	46.00	FCC
5.0 -30.0	60.00	50.00	FCC

Note:

- (1) The tighter limit applies at the band edges.
- (2) The limit of " * " marked band means the limitation decreases linearly with the logarithm of the frequency in the range.

The following table is the setting of the receiver

Receiver Parameters	Setting
Attenuation	10 dB
Start Frequency	0.15 MHz
Stop Frequency	30 MHz
IF Bandwidth	9 kHz

3.1.2 TEST PROCEDURE

- a. The EUT was placed 0.8 meters from the horizontal ground plane with EUT being connected to the power mains through a line impedance stabilization network (LISN). All other support equipments powered from additional LISN(s). The LISN provide 50 Ohm/ 50uH of coupling impedance for the measuring instrument.
- b. Interconnecting cables that hang closer than 40 cm to the ground plane shall be folded back and forth in the center forming a bundle 30 to 40 cm long.
- c. I/O cables that are not connected to a peripheral shall be bundled in the center. The end of the cable may be terminated, if required, using the correct terminating impedance. The overall length shall not exceed 1 m.
- d. LISN at least 80 cm from nearest part of EUT chassis.
- e. For the actual test configuration, please refer to the related Item –EUT Test Photos.

3.1.3 DEVIATION FROM TEST STANDARD

No deviation

3.1.4 TEST SETUP

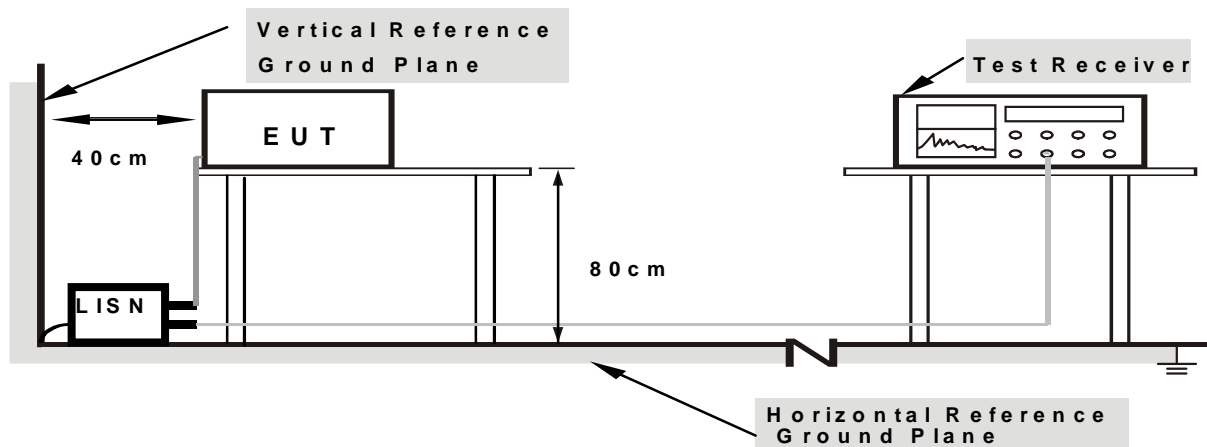

Note: 1.Support units were connected to second LISN.

2.Both of LISNs (AMN) are 80 cm from EUT and at least 80 cm from other units and other metal planes

3.1.5 EUT OPERATING CONDITIONS

The EUT was configured for testing in a typical fashion (as a customer would normally use it). The EUT has been programmed to continuously transmit during test. This operating condition was tested and used to collect the included data.

3.1.6 TEST RESULTS



Conducted Emission At The Mains Terminals Test Data			
Temperature:	24.5 °C	Relative Humidity:	54%
Pressure:	1009hPa	Phase :	Line
Test Voltage :	DC 5V from adapter input AC 120V/60Hz	Test Mode:	TX Mode

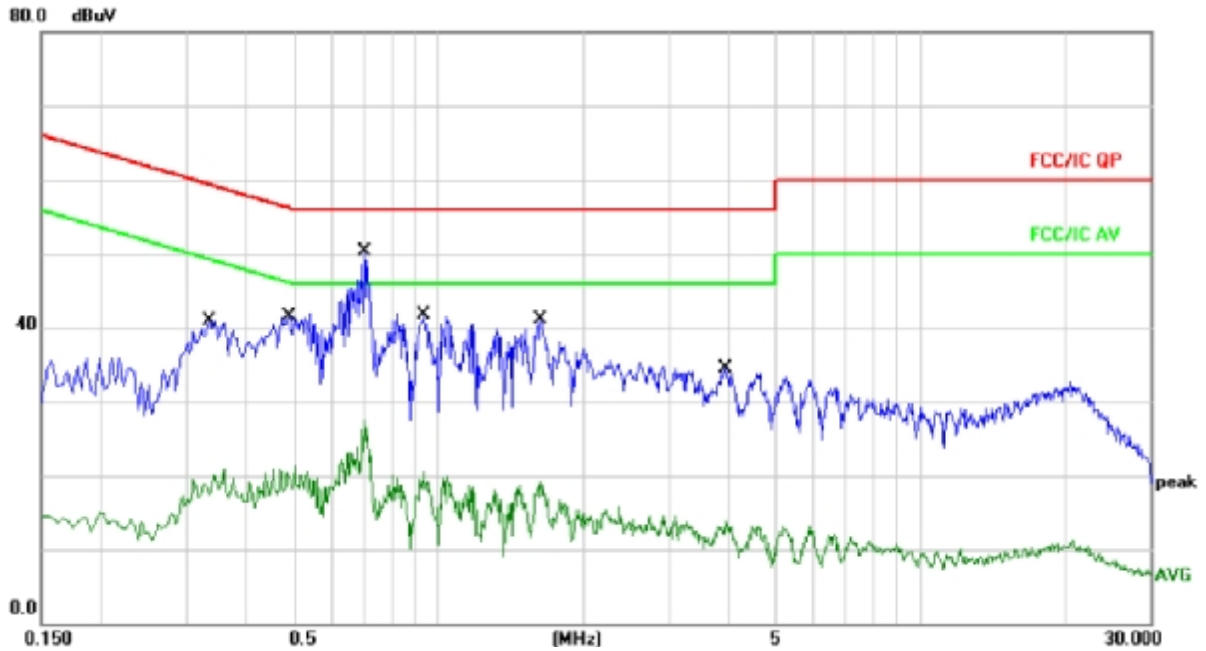

No. Mk.	Freq. MHz	Reading Level dBuV	Correct Factor dB	Measurement dBuV	Limit dBuV	Over dB	Detector	Comment
1	0.3321	8.01	10.10	18.11	49.40	-31.29	AVG	
2	0.3339	30.79	10.10	40.89	59.35	-18.46	QP	
3	0.4900	31.32	10.11	41.43	56.17	-14.74	QP	
4	0.4900	9.89	10.11	20.00	46.17	-26.17	AVG	
5 *	0.7019	40.09	10.14	50.23	56.00	-5.77	QP	
6	0.7019	17.41	10.14	27.55	46.00	-18.45	AVG	
7	0.9340	31.58	10.16	41.74	56.00	-14.26	QP	
8	0.9340	9.52	10.16	19.68	46.00	-26.32	AVG	
9	1.6300	31.01	10.18	41.19	56.00	-14.81	QP	
10	1.6300	8.93	10.18	19.11	46.00	-26.89	AVG	
11	3.9620	24.31	10.16	34.47	56.00	-21.53	QP	
12	3.9620	2.30	10.16	12.46	46.00	-33.54	AVG	



Conducted Emission At The Mains Terminals Test Data			
Temperature:	24.5 °C	Relative Humidity:	54%
Pressure:	1009hPa	Phase :	Neutral
Test Voltage :	DC 5V from adapter input AC 120V/60Hz	Test Mode:	TX Mode

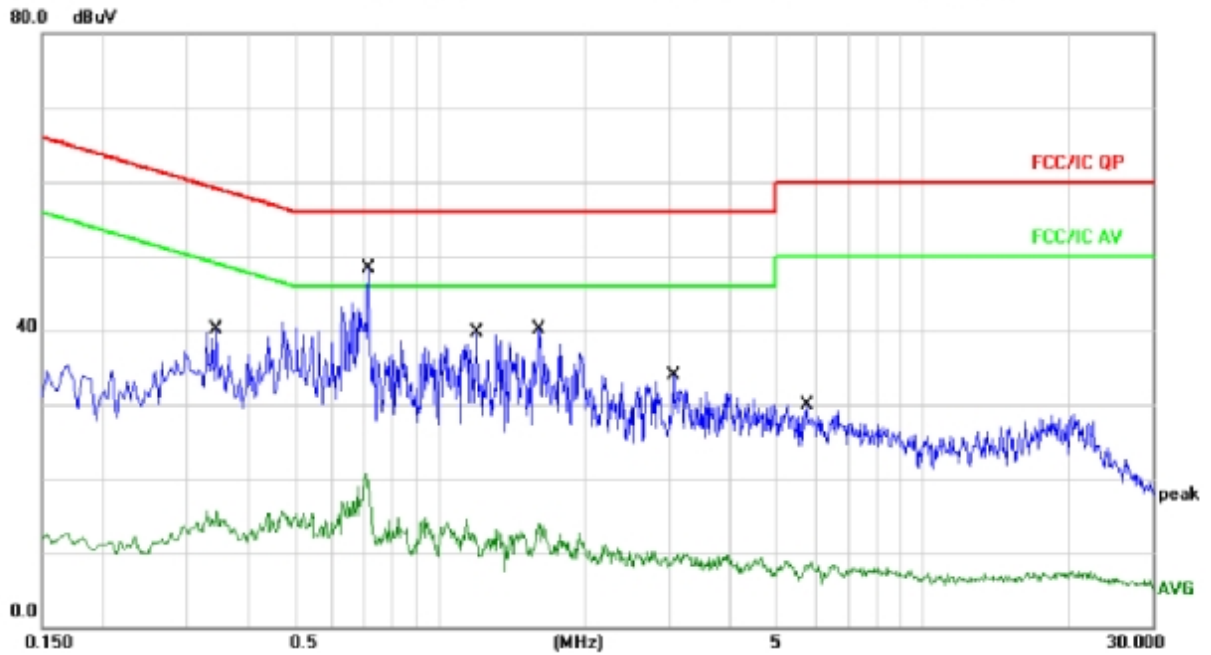

No.	Mk.	Freq. MHz	Reading Level dBuV	Correct Factor dB	Measurement dBuV	Limit dBuV	Over dB	Detector	Comment
1		0.3480	29.96	10.10	40.06	59.06	-19.00	QP	
2		0.3460	5.60	10.10	15.70	49.06	-33.36	AVG	
3	^	0.7140	38.12	10.14	48.26	56.00	-7.74	QP	
4		0.7140	9.61	10.14	19.75	46.00	-26.25	AVG	
5		1.1940	29.60	10.17	39.77	56.00	-16.23	QP	
6		1.1940	1.38	10.17	11.55	46.00	-34.45	AVG	
7		1.6019	29.86	10.18	40.04	56.00	-15.96	QP	
8		1.6019	3.76	10.18	13.94	46.00	-32.06	AVG	
9		3.0420	23.66	10.19	33.85	56.00	-22.15	QP	
10		3.0579	-1.05	10.19	9.14	46.00	-36.86	AVG	
11		5.7540	19.71	10.10	29.81	60.00	-30.19	QP	
12		5.7819	-2.39	10.10	7.71	50.00	-42.29	AVG	



3.2 RADIATED EMISSION MEASUREMENT

3.2.1 RADIATED EMISSION LIMITS (Frequency Range 9kHz-1000MHz)

20dBc in any 100 kHz bandwidth outside the operating frequency band. In case the emission fall within the restricted band specified on 15.205(a), then the 15.231(b) limit in the table below has to be followed.

Frequencies(MHz)	Field Strength(micorvolts/meter)	Measurement Distance(meters)
0.009~0.490	2400/F(KHz)	300
0.490~1.705	24000/F(KHz)	30
1.705~30.0	30	30
30~88	100	3
88~216	150	3
216~960	200	3
Above 960	500	3

LIMITS OF RADIATED EMISSION MEASUREMENT (Above 1000MHz)

FREQUENCY (MHz)	Class B (dBuV/m) (at 3M)	
	PEAK	AVERAGE
Above 1000	74	54

Notes:

- (1) The limit for radiated test was performed according to FCC PART 15C.
- (2) The tighter limit applies at the band edges.
- (3) Emission level (dBuV/m)=20log Emission level (uV/m).

FUNDAMENTAL AND HARMONICS EMISSION LIMITS

Fundamental Frequency (MHz)	Field Strength of Fundamental (microvolts/meter)	Field Strength of Spurious Emissions (microvolts/meter)
40.66 - 40.70	2,250	225
70 - 130	1,250	125
130 - 174	1,250 to 3,750 **	125 to 375 **
174 - 260	3,750	375
260 - 470	3,750 to 12,500 **	375 to 1,250 **
Above 470	12,500	1,250

** linear interpolations

[Where F is the frequency in MHz, the formulas for calculating the maximum permitted fundamental field strengths are as follows: for the band 130-174 MHz, $\mu\text{V/m}$ at 3 meters = $56.81818(F) - 6136.3636$; for the band 260-470 MHz, $\mu\text{V/m}$ at 3 meters = $41.6667(F) - 7083.3333$. The maximum permitted unwanted emission level is 20 dB below the maximum permitted fundamental level.]



FREQUENCY RANGE OF RADIATED MEASUREMENT (For unintentional radiators)

Highest frequency generated or Upper frequency of measurement used in the device or on which the device operates or tunes (MHz)	Range (MHz)
Below 1.705	30
1.705 – 108	1000
108 – 500	2000
500 – 1000	5000
Above 1000	5 th harmonic of the highest frequency or 40 C whichever is lower

Spectrum Parameter	Setting
Attenuation	Auto
Start Frequency	1000 MHz
Stop Frequency	10th carrier harmonic
RBW / VBW setting	1 MHz / 1 MHz for Peak

Receiver Parameter	Setting
Attenuation	Auto
Start ~ Stop Frequency	9kHz~150kHz / RB 200Hz for QP
Start ~ Stop Frequency	150kHz~30MHz / RB 9kHz for QP
Start ~ Stop Frequency	30MHz~1000MHz / RB 120kHz for QP

3.2.2 TEST PROCEDURE

- The measuring distance of at 3 m shall be used for measurements at frequency up to 1GHz. For frequencies above 1GHz, any suitable measuring distance may be used.
- The EUT was placed on the top of a rotating table 0.8 meters above the ground at a 3 meter open area test site. The table was rotated 360 degrees to determine the position of the highest radiation.
- The height of the equipment or of the substitution antenna shall be 0.8 m; the height of the test antenna shall vary between 1 m to 4 m. Both horizontal and vertical polarizations of the antenna are set to make the measurement.
- The initial step in collecting conducted emission data is a spectrum analyzer peak detector mode pre-scanning the measurement frequency range. Significant peaks are then marked and then Quasi Peak detector mode re-measured.
- If the Peak Mode measured value compliance with and lower than Quasi Peak Mode Limit, the EUT shall be deemed to meet QP Limits and then no additional QP Mode measurement performed.
- For the actual test configuration, please refer to the related Item –EUT Test Photos.

- g. Place the measurement antenna away from each area of the EUT determined to be a source of emissions at the specified measurement distance, while keeping the measurement antenna aimed at the source of emissions at each frequency of significant emissions, with polarization oriented for maximum response.

The measurement antenna may have to be higher or lower than the EUT, depending on the radiation pattern of the emission and staying aimed at the emission source for receiving the maximum signal. The final measurement antenna elevation shall be that which maximizes the emissions. The measurement antenna elevation for maximum emissions shall be restricted to a range of heights of from 1 m to 4 m above the ground or reference ground plane.

Note:

Both horizontal and vertical antenna polarities were tested and performed pretest to three orthogonal axis. The worst case was X axis and the emissions were reported

3.2.3 TEST SETUP

- (A) Radiated Emission Test-Up Frequency Below 30MHz

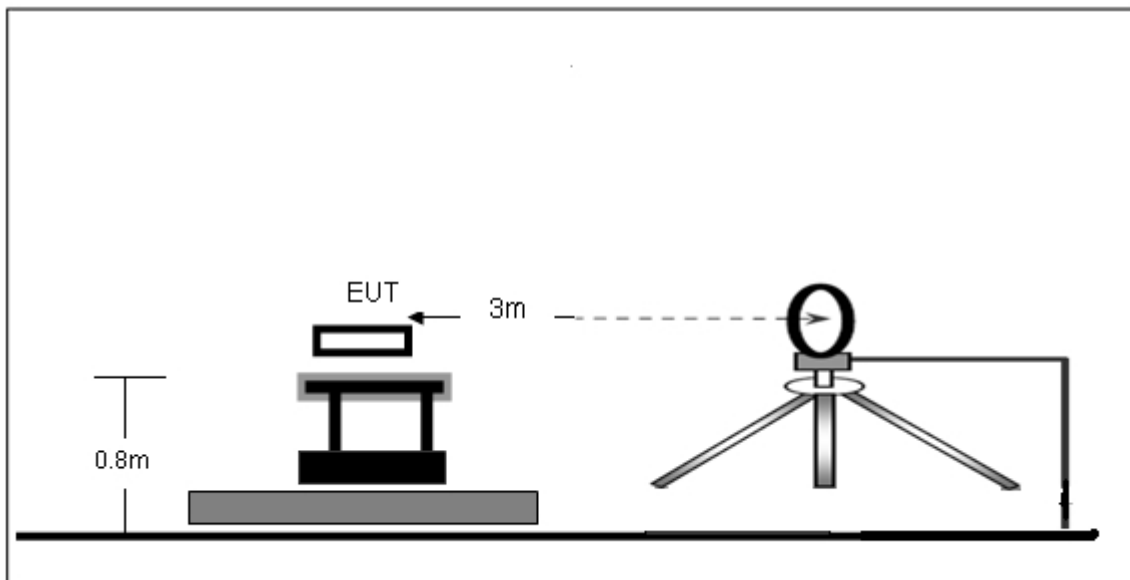

(B) Radiated Emission Test-Up Frequency 30MHz~1GHz

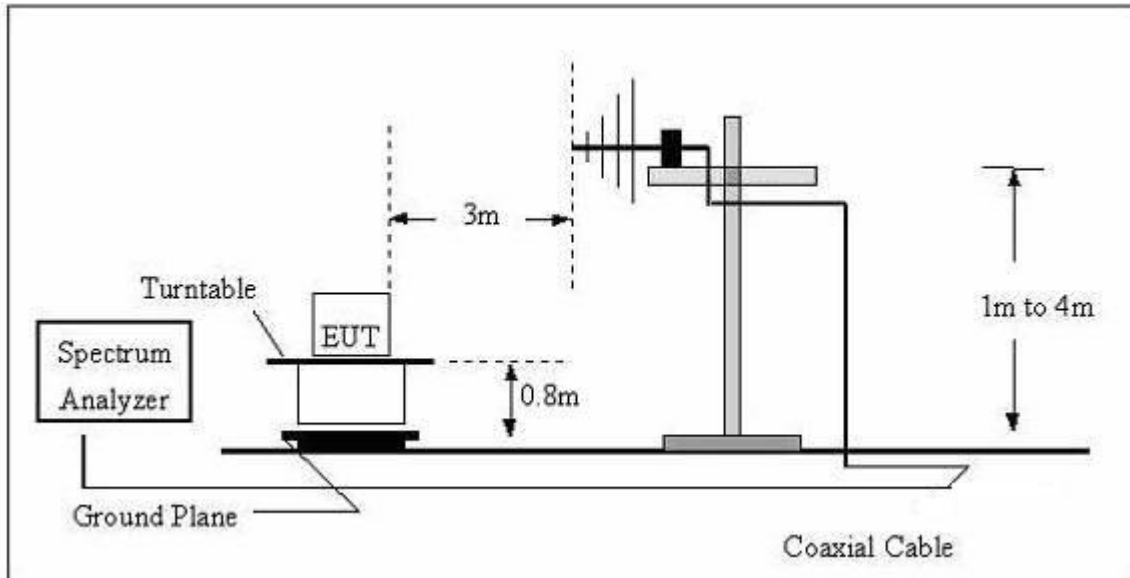

(C) Radiated Emission Test-Up Frequency Above 1GHz

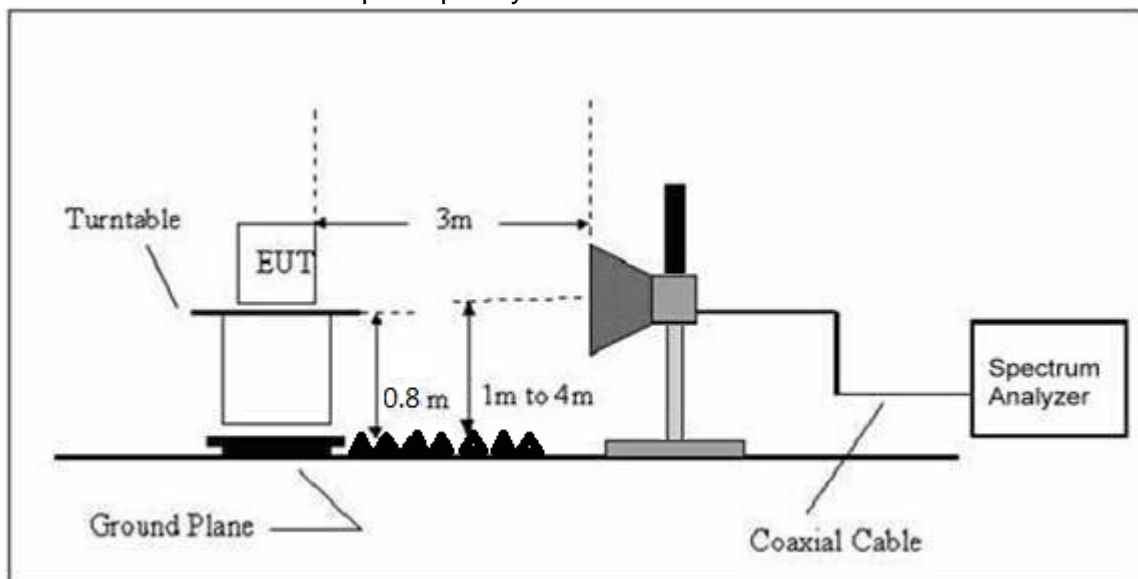

3.2.4 EUT OPERATING CONDITIONS

The EUT tested system was configured as the statements of 2.4 Unless otherwise a special operating condition is specified in the follows during the testing.



3.2.5 TEST RESULTS

Radiated Spurious Emission (Below 30MHz)

EUT :	Remote dog training	Model Name :	PTS-018
Temperature :	20 °C	Relative Humidity :	48%
Pressure :	1010 hPa	Polarization :	---
Test Voltage :	By Battery		
Test Mode :	TX Mode		

Freq. (MHz)	Reading (dBuV/m)	Limit (dBuV/m)	Margin (dB)	State P/F
--	--	--	--	PASS
--	--	--	--	PASS

NOTE:

The amplitude of spurious emissions which are attenuated by more than 20dB below the permissible value has no need to be reported.

Distance extrapolation factor = $40 \log(\text{specific distance}/\text{test distance})$ (dB);

Limit line = specific limits(dBuv) + distance extrapolation factor.



Radiated Spurious Emission (Between 30MHz – 1GHz)

EUT :	Remote dog training	Model Name :	PTS-018
Temperature :	26 °C	Relative Humidity :	54%
Pressure :	1010 hPa	Polarization :	Horizontal
Test Voltage :	DC 3V		
Test Mode :	TX Mode		

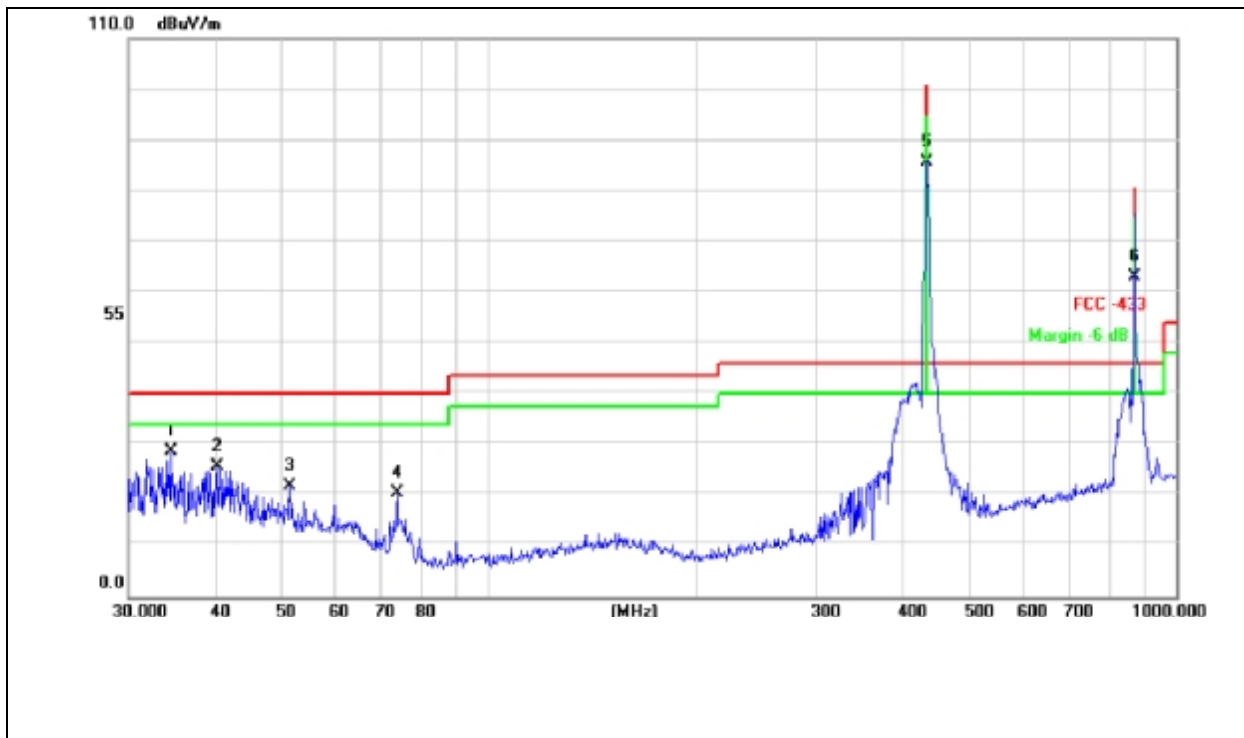

No.	Mk.	Freq. MHz	Reading Level dBuV	Correct Factor dU/m	Measure- ment dBuV/m	Limit dBuV/m	Over dB	Detector	Antenna Height cm	Table Degree	Comment
1	*	34.5172	37.15	-8.47	28.68	40.00	-11.32	QP			
2		40.2757	34.55	-8.89	25.66	40.00	-14.34	QP			
3		51.4806	32.54	-10.54	22.00	40.00	-18.00	QP			
4		73.8170	38.43	-15.82	20.61	40.00	-19.39	QP			
5		433.9200	95.00	-9.37	85.63	100.80	-15.17	peak			
6		867.8400	65.29	-2.05	63.24	80.80	-17.56	peak			

Remark:

Factor = Antenna Factor + Correct Factor.

Correct Factor= Cable Loss – Pre-amplifier



EUT :	Remote dog training	Model Name :	PTS-018
Temperature :	26 °C	Relative Humidity :	54%
Pressure :	1010 hPa	Polarization :	Vertical
Test Voltage :	DC 3V		
Test Mode :	TX Mode		

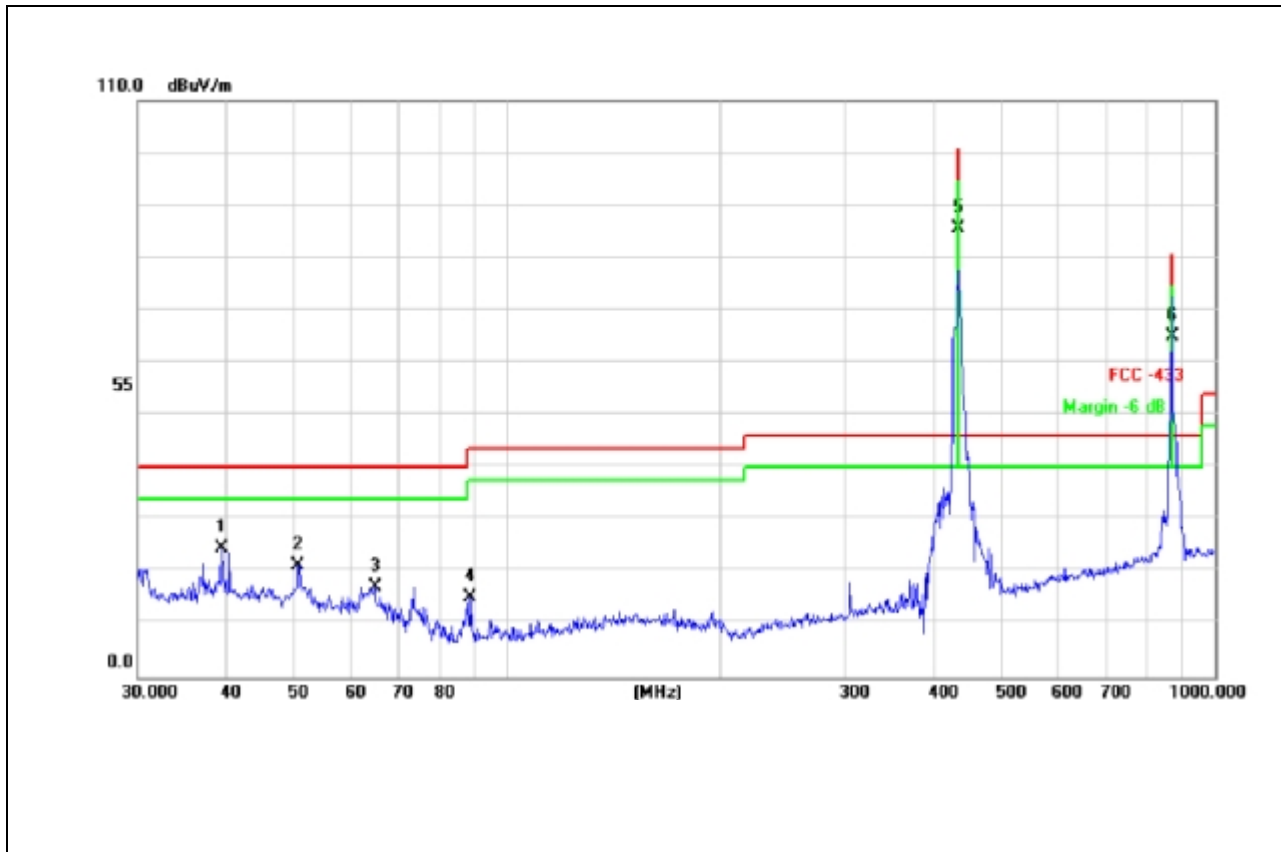

No. Mk.	Freq. MHz	Reading Level dBuV	Correct Factor dB/m	Measurement dBuV/m	Limit dBuV/m	Over dB	Detector	Antenna Height cm	Table Degree degree	Comment
1	39.4371	33.38	-8.83	24.55	40.00	-15.45	QP			
2	50.5860	31.60	-10.39	21.21	40.00	-18.79	QP			
3	64.8865	29.78	-12.49	17.29	40.00	-22.71	QP			
4	86.6524	32.82	-17.66	15.16	43.50	-28.34	QP			
5	* 433.9200	94.96	-9.37	85.59	100.80	-15.21	peak			
6	867.8400	67.00	-2.05	64.95	80.80	-15.85	peak			

Remark:

Factor = Antenna Factor + Correct Factor.

Correct Factor= Cable Loss – Pre-amplifier



For average Emission

Frequency MHz	Peak Level dBuV/m	Duty cycle factor	AverageLevel dBuV/m	Polarization	Limit AV	Margin
433.92	85.59	-6.61	78.98	Vertical	80.80	-1.82
867.84	64.95	-6.61	58.34	Vertical	60.80	-2.46

Notes: 1. Average emission Level = Peak Level + Duty cycle factor
2. Duty cycle level please see clause 5.

Frequency MHz	Peak Level dBuV/m	Duty cycle factor	AverageLevel dBuV/m	Polarization	Limit AV	Margin
433.92	85.63	-6.61	79.02	Horizontal	80.80	-1.78
867.84	63.24	-6.61	56.63	Horizontal	60.80	-4.17

Notes: 1. Average emission Level = Peak Level + Duty cycle factor
2. Duty cycle level please see clause 5.



Radiated Spurious Emission (1GHz to 10th harmonics)

Frequency MHz	Peak Level dBuV/m	Duty cycle factor	Average Level dBuV/m	Polarization	Limit		Margin dB	
					PK	AV	PK	AV
1301.76	64.79	-6.61	58.18	Vertical	80.80	60.80	-16.01	-2.62
1735.68	62.41	-6.61	55.8	Vertical	80.80	60.80	-18.39	-5.00
2169.60	58.39	-6.61	51.78	Vertical	80.80	60.80	-22.41	-9.02
2603.52	58.24	-6.61	51.63	Vertical	80.80	60.80	-22.56	-9.17
3037.44	52.03	-6.61	45.42	Vertical	80.80	60.80	-28.77	-15.38
3471.36	52.78	-6.61	46.17	Vertical	80.80	60.80	-28.02	-14.63

Frequency MHz	Peak Level dBuV/m	Duty cycle factor	Average Level dBuV/m	Polarization	Limit		Margin dB	
					PK	AV	PK	AV
1301.76	63.25	-6.61	56.64	Horizontal	80.80	60.80	-17.55	-4.16
1735.68	61.63	-6.61	55.02	Horizontal	80.80	60.80	-19.17	-5.78
2169.60	58.34	-6.61	51.73	Horizontal	80.80	60.80	-22.46	-9.07
2603.52	56.44	-6.61	49.83	Horizontal	80.80	60.80	-24.36	-10.97
3037.44	51.68	-6.61	45.07	Horizontal	80.80	60.80	-29.12	-15.73
3471.36	52.04	-6.61	45.43	Horizontal	80.80	60.80	-28.76	-15.37

Notes: 1. Average emission Level = Peak Level + Duty cycle factor

2. Duty cycle level please see clause 5.

3. Pulse Desensitization Correction Factor

Pulse Width (PW) = 63.25ms

$2/PW = 2/63.25ms = 0.03kHz$

RBW (100 kHz) > 2/PW (0.008kHz)

Therefore PDCF is not needed

4. BANDWIDTH TEST

4.1 APPLIED PROCEDURES / LIMIT

According to FCC 15.231(c) requirement:

The bandwidth of the emission shall be no wider than 0.25% of the center frequency for devices operating between 70 MHz to 900 MHz. Those devices operating above 900 MHz, the emission spurious shall be no wider than 0.5% of the center frequency. Bandwidth is determined at the points 20 dB down from the modulated carrier.

$$B.W (20dBc) \text{ Limit} = 0.25\% * f(\text{MHz}) = 0.25\% * 433.92\text{MHz} = 1.0848\text{MHz}$$

Spectrum Parameter	Setting
Attenuation	Auto
Span Frequency	> Measurement Bandwidth or Channel Separation
RB	100kHz
VB	≥RBW
Detector	Peak
Trace	Max Hold
Sweep Time	Auto

4.1.1 TEST PROCEDURE

- a. The EUT was directly connected to the spectrum analyzer and antenna output port as show in the block diagram below,
- b. Spectrum Setting : RBW= 100kHz, VBW≥ RBW, Sweep time = Auto.

4.1.2 DEVIATION FROM STANDARD

No deviation.

4.1.3 TEST SETUP



4.1.4 EUT OPERATION CONDITIONS

The EUT tested system was configured as the statements of 2.4 Unless otherwise a special operating condition is specified in the follows during the testing.



4.1.5 TEST RESULTS

EUT :	Remote dog training	Model Name :	PTS-018
Temperature :	25 °C	Relative Humidity :	60%
Pressure :	1012 hPa	Test Voltage :	By Battery
Test Mode :	TX Mode		

Frequency	20dB Bandwidth (kHz)	Result
433.92MHz	562.5	PASS

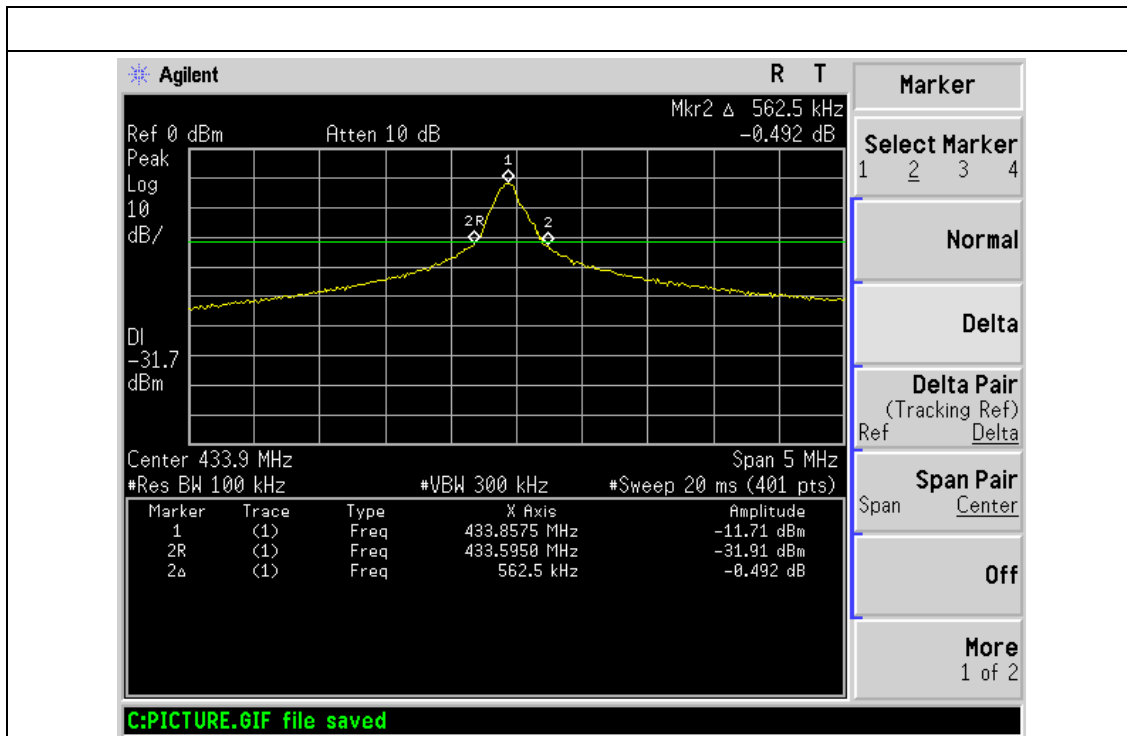



5. CALCULATION OF AVERAGE FACTOR

The output field strengths of specification in accordance with the FCC rules specify measurements with an average detector. During the test, a spectrum analyzer incorporating a peak detector was used. Therefore, a reduction factor can be applied to the resultant peak signal level and compared to the limit for measurement instrumentation incorporating an average detector.

The duty cycle is measured in 100 ms or the repetition cycle period, whichever is a shorter time frame. The duty cycle is measured by placing the spectrum analyzer to set zero span at 100kHz resolution bandwidth.

Averaging factor in dB = $20\log(\text{duty cycle})$

The duration of one cycle = 63.25ms

The duty cycle is simply the on-time divided the duration of one cycle

Duty Cycle = $(1.5\text{ms} \times 12 + 0.55\text{ms} \times 21) / 63.25 = 29.55\text{ms} / 63.25\text{ms} = 0.467$

Therefore, the averaging factor is found by $20\log 0.467 = -6.61\text{dB}$

Test plot as follows:

Note: During the 100ms, the amount of pulse and on-time of pulse are the same for every pulse train.

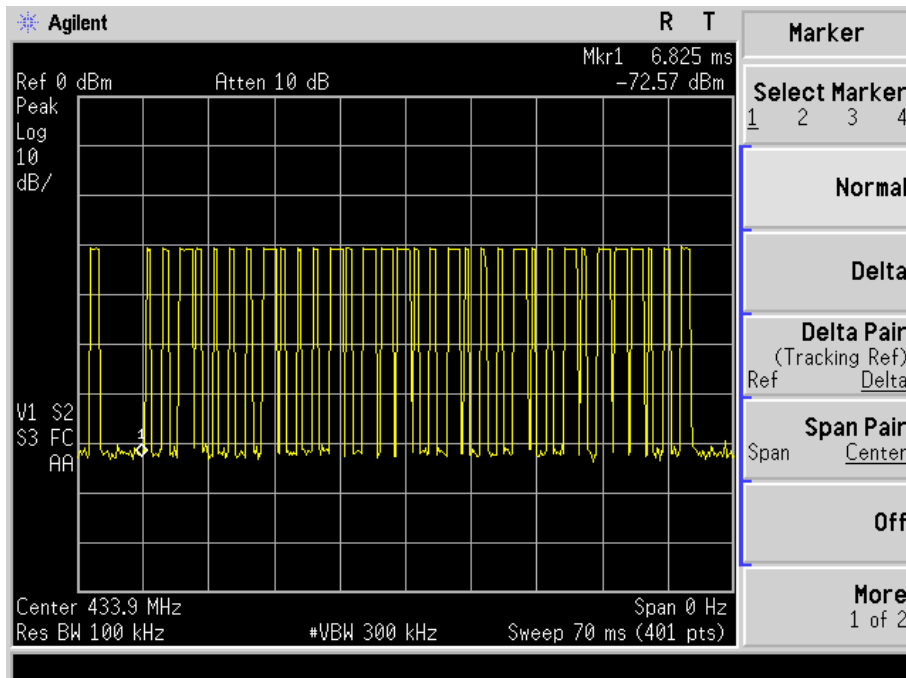
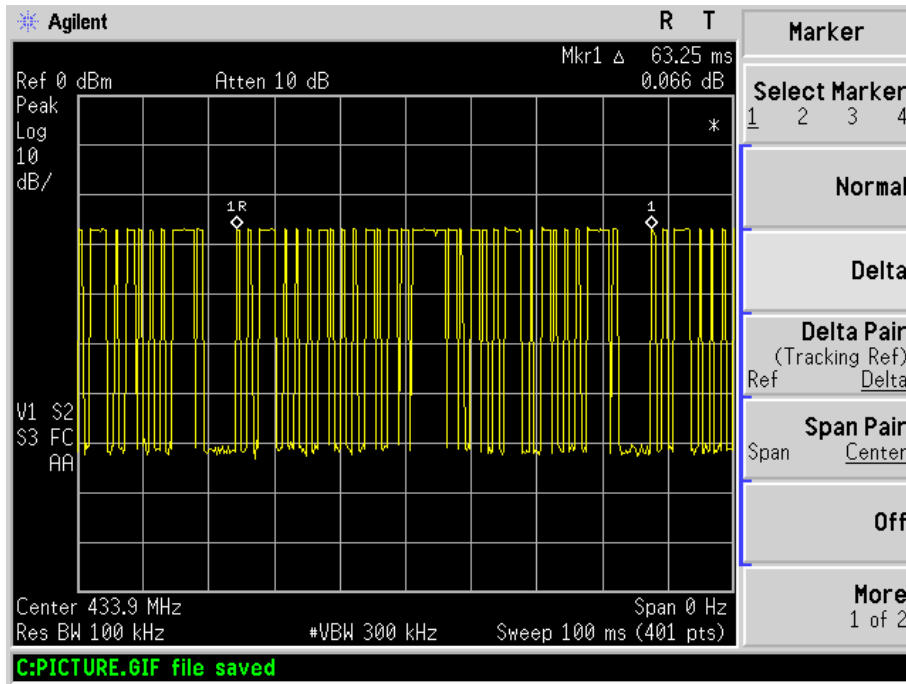

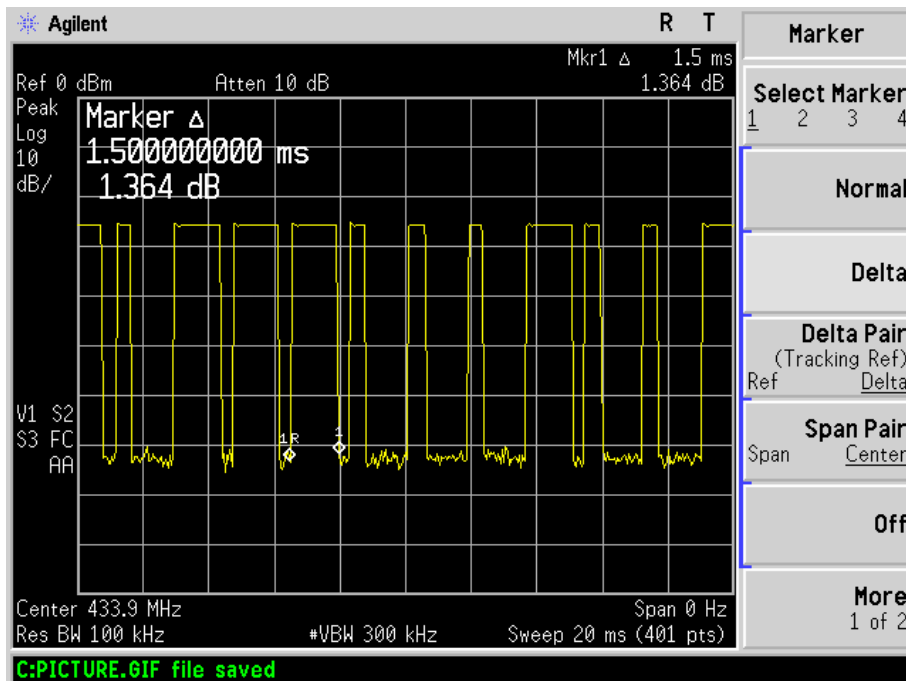
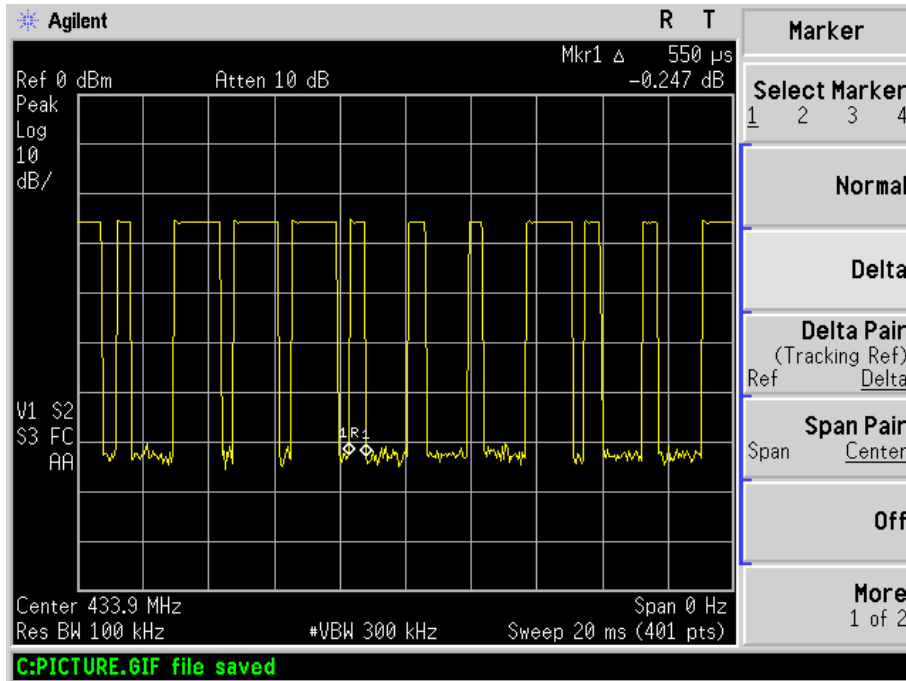



6. DWELL TIME

APPLICABLE STANDARD

According to FCC 15.231(a) requirement:

A manually operated transmitter shall employ a switch that will automatically deactivate the transmitter within not more than 5 seconds of being released.

TEST PROCEDURE

- a) Check the calibration of the measuring instrument using either an internal calibrator or a known signal from an external generator.
- b) Position the EUT without connection to measurement instrument. Turn on the EUT and connect its antenna terminal to measurement instrument via a low loss cable. Then set it to any one measured frequency within its operating range, and make sure the instrument is operated in its linear range.
- c) Set RBW to 100 kHz and VBW of spectrum analyzer to 300 kHz with a convenient frequency span including 100 kHz bandwidth from band edge.
- d) Measure the highest amplitude appearing on spectral display and set it as a reference level. Plot the graph with marking the highest point and edge frequency.
- e) Repeat above procedures until all measured frequencies were complete.

6.1 DEVIATION FROM STANDARD

No deviation.

6.2 TEST SETUP

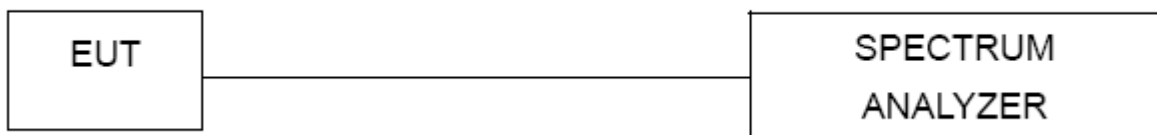

6.3 EUT OPERATION CONDITIONS

The EUT tested system was configured as the statements of 2.4 Unless otherwise a special operating condition is specified in the follows during the testing.



6.4 TEST RESULTS

	Dwell time (second)	Limit (second)	Result
Full voltage(DC 3.7V)	3.525	<5s	Pass
Low voltage(DC3.33V)	3.175	<5s	Pass

Full Voltage

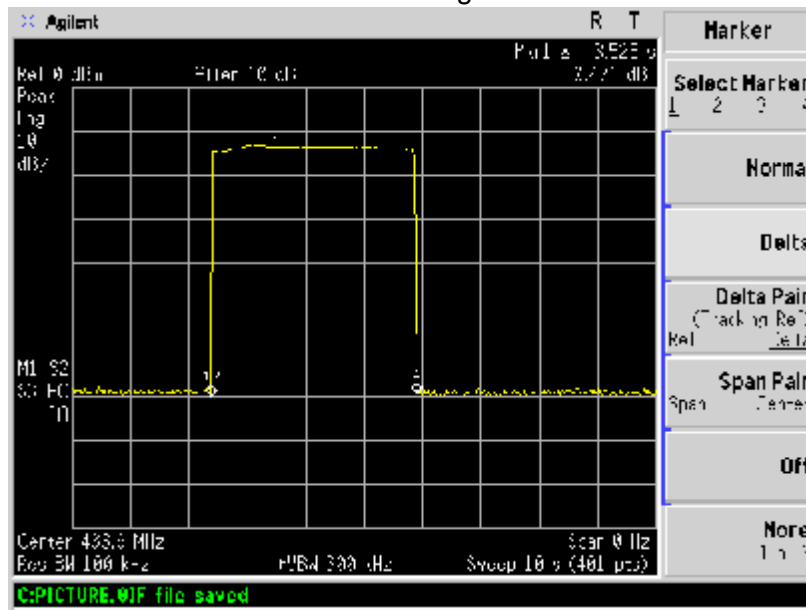

Low voltage

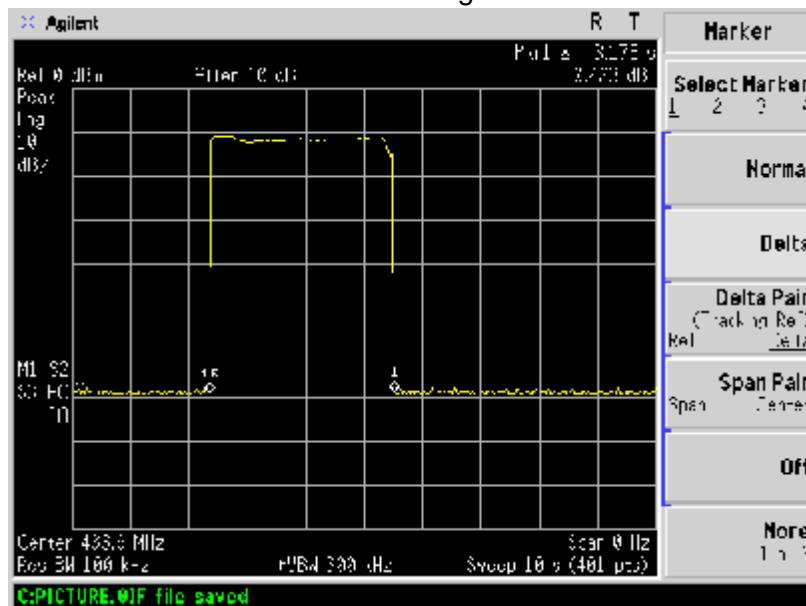



7. ANTENNA REQUIREMENT

7.1 STANDARD REQUIREMENT

15.203 requirement: For intentional device, according to 15.203: an intentional radiator shall be designed to ensure that no antenna other than that furnished by the responsible party shall be used with the device.

7.2 EUT ANTENNA

The EUT antenna is the Internal antenna. It comply with the standard requirement.

8. EUT TEST PHOTO

Radiated Measurement Photos

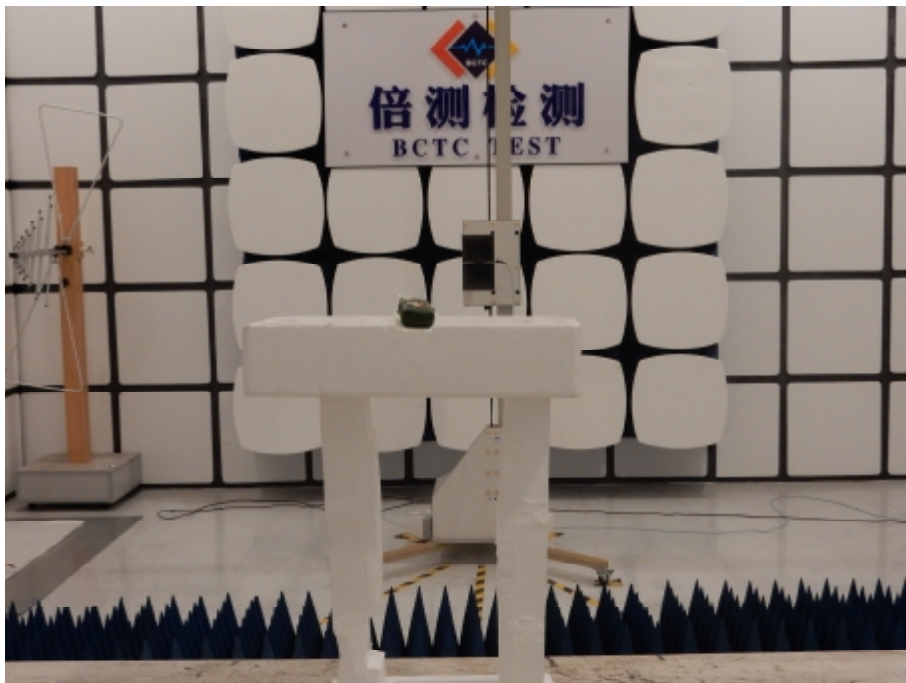
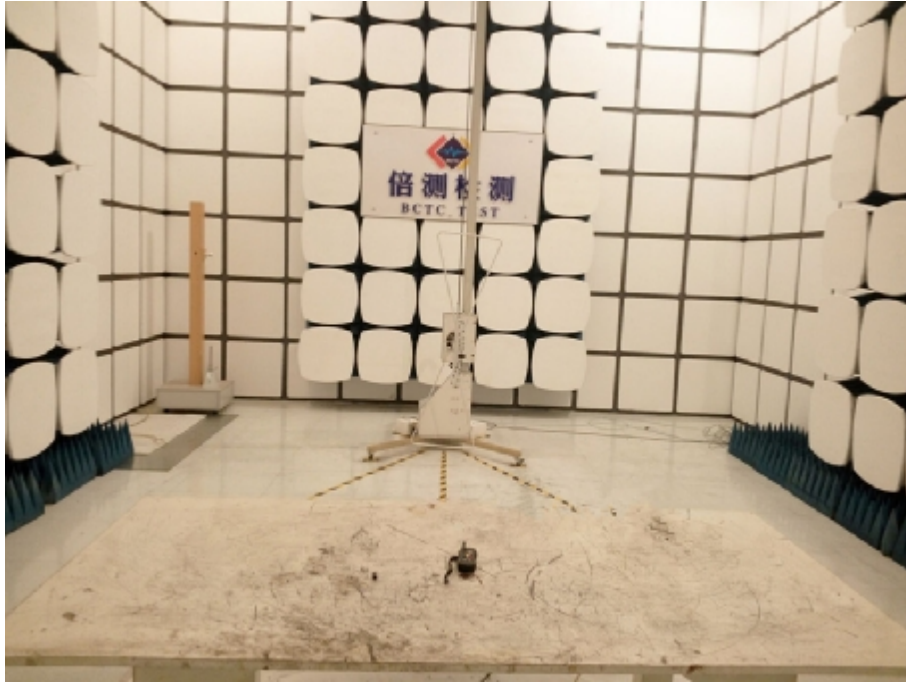

Conducted Measurement Photos



9. EUT PHOTO





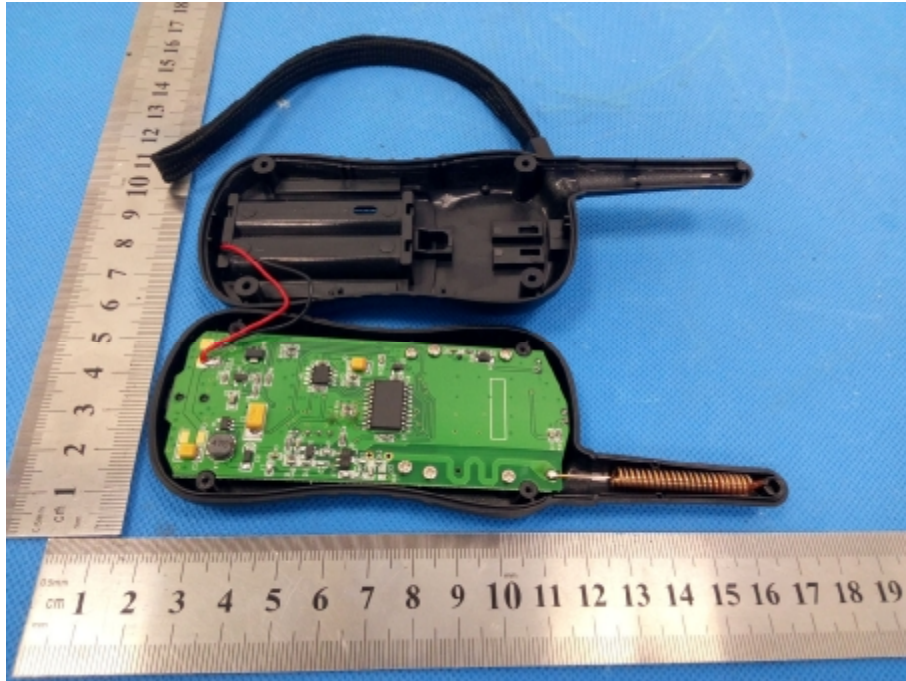

END