

TEST REPORT

Report No.: BCTC2107487150E

Applicant: Shenzhen Patpet Technology Co., Ltd.

Product Name: Dog Training Collar

Model/Type Ref.: PTS-018

Tested Date: 2021-07-13 to 2021-07-20

Issued Date: 2021-07-20

Shenzhen BCTC Testing Co., Ltd.



FCC ID: 2AHHYPTS-018-V2

Product Name: Dog Training Collar
Trademark: N/A
PTS-018
Model/Type Ref.: PTS-008, PTS-015, PTS-108, PTS-118, p-collar 310,
p-collar 320, p-collar 330, p-collar 340, p-collar 610,
p-collar 620, p-collar 630, p-collar 640, p-collar 810,
p-collar 820, p-collar 910, p-collar 920
Prepared For: Shenzhen Patpet Technology Co., Ltd.
Address: 3rd Floor, Factory Building, No. 1 Qinhui Road, Gushu
Community, Xixiang Street, Baoan District, Shenzhen,
Guangdong, China
Manufacturer: Shenzhen Patpet Technology Co., Ltd.
Address: 3rd Floor, Factory Building, No. 1 Qinhui Road, Gushu
Community, Xixiang Street, Baoan District, Shenzhen,
Guangdong, China
Prepared By: Shenzhen BCTC Testing Co., Ltd.
Address: 1-2/F., Building SB, Pengzhou Industrial Park, No.158,
Fuyuan 1st Road, Tangwei, Fuhai Subdistrict, Bao'an District,
Shenzhen, Guangdong, China
Sample Received Date: 2021-07-13
Sample tested Date: 2021-07-13 to 2021-07-20
Issue Date: 2021-07-20
Report No.: BCTC2107487150E
Test Standards: FCC Part15.231
ANSI C63.10-2013
Test Results: PASS

Tested by:

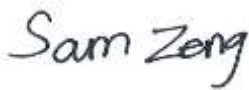

Sam zeng/Project Handler

Approved by:



Zero Zhou/Reviewer

The test report is effective only with both signature and specialized stamp. This result(s) shown in this report refer only to the sample(s) tested. Without written approval of Shenzhen BCTC Testing Co., Ltd, this report can't be reproduced except in full. The tested sample(s) and the sample information are provided by the client.

TABLE OF CONTENT

Test Report Declaration	Page
1. VERSION	5
2. TEST SUMMARY	6
3. MEASUREMENT UNCERTAINTY	7
4. PRODUCT INFORMATION AND TEST SETUP	8
4.1 Product Information	8
4.2 Test Setup Configuration	8
4.3 Support Equipment	9
4.4 Channel List	9
4.5 Test Mode	10
5. TEST FACILITY AND TEST INSTRUMENT USED	11
5.1 Test Facility	11
5.2 Test Instrument Used	11
6. CONDUCTED EMISSIONS	13
6.1 Block Diagram Of Test Setup	13
6.2 Limit	13
6.3 Test procedure	13
6.4 EUT operating Conditions	13
6.5 Test Result	14
7. RADIATED EMISSIONS	16
7.1 Block Diagram Of Test Setup	16
7.2 Limit	17
7.3 Test procedure	18
7.4 EUT operating Conditions	20
7.5 Test Result	21
8. BANDWIDTH TEST	25
8.1 Block Diagram Of Test Setup	25
8.2 Limit	25
8.3 Test procedure	25
8.4 EUT operating Conditions	25
8.5 Test Result	26
9. CALCULATION OF AVERAGE FACTOR	27
10. DWEELL TIME	29
10.1 Block Diagram Of Test Setup	29
10.2 Limit	29
10.3 Test procedure	29
10.4 Test Result	30
11. ANTENNA REQUIREMENT	31
11.1 STANDARD REQUIREMENT	31
11.2 EUT ANTENNA	31

12. EUT PHOTOGRAPHS	32
13. EUT TEST SETUP PHOTOGRAPHS	33

(Note: N/A means not applicable)

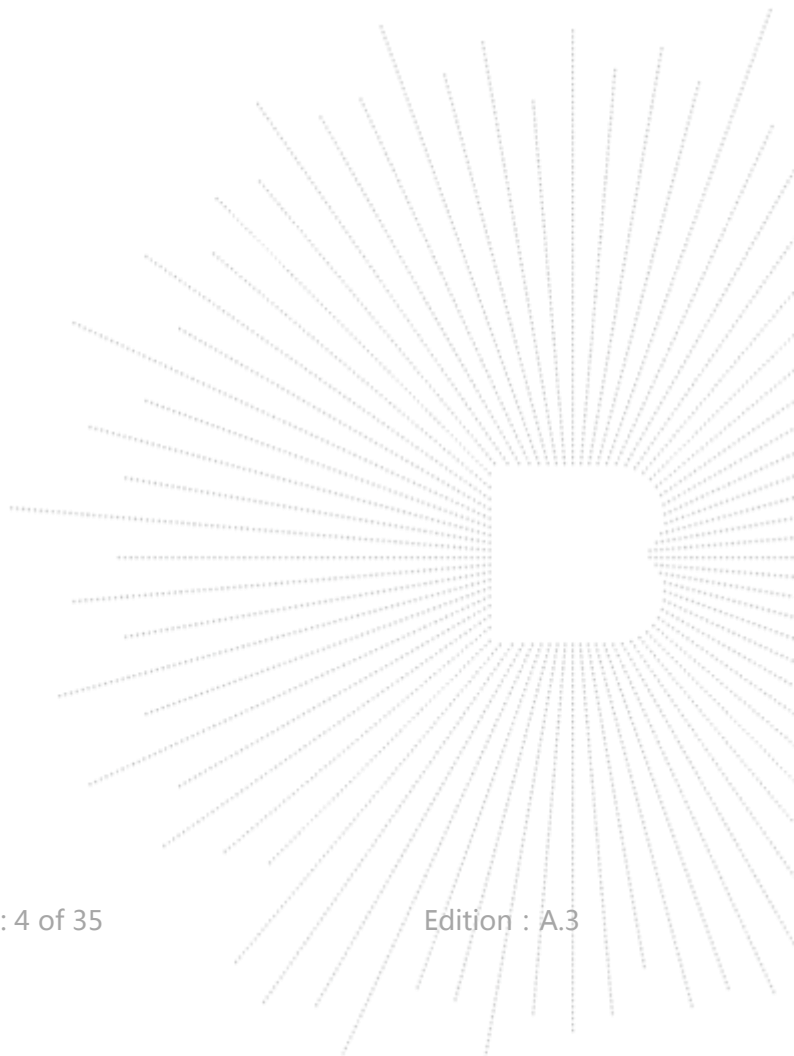

1. VERSION

Report No.	Issue Date	Description	Approved
BCTC2107487150E	2021-07-20	Original	Valid

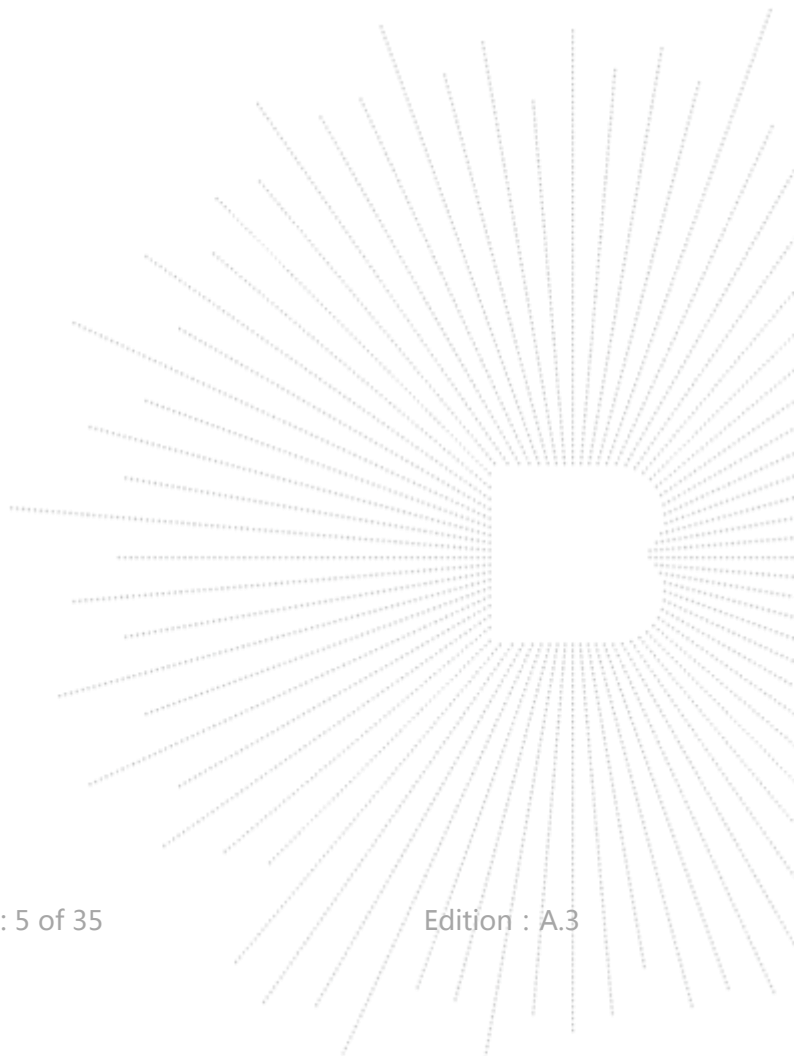

2. TEST SUMMARY

The Product has been tested according to the following specifications:

No.	Test Parameter	Clause No	Results
1	Conducted Emission	§15.207	PASS
2	Fundamental & Radiated Spurious Emission Measurement	15.209, 15.231b	PASS
3	Occupancy Bandwidth	15.231c	PASS
4	Dwell time	15.231a	PASS
5	Antenna Requirement	15.203	PASS

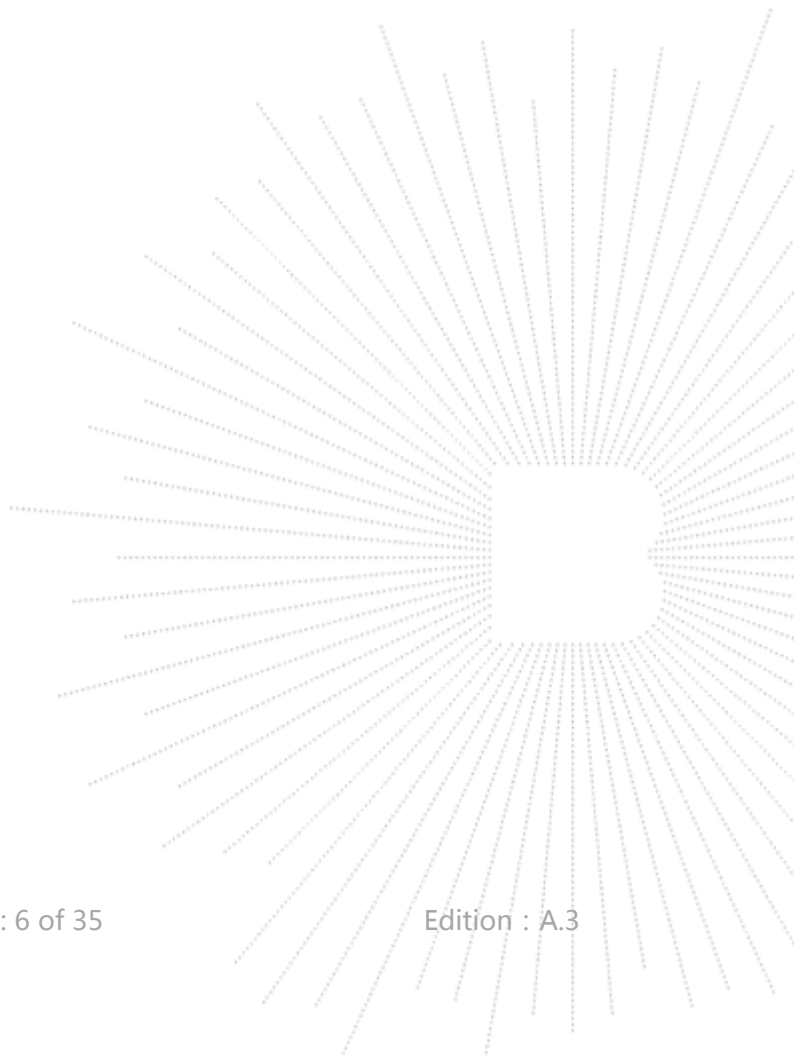

3. MEASUREMENT UNCERTAINTY

Where relevant, the following measurement uncertainty levels have been estimated for tests performed on the Product as specified in CISPR 16-4-2. This uncertainty represents an expanded uncertainty expressed at approximately the 95% confidence level using a coverage factor of $k=2$.

No.	Item	Uncertainty
1	3m chamber Radiated spurious emission(9kHz-30MHz)	U=3.7dB
2	3m chamber Radiated spurious emission(30MHz-1GHz)	U=4.3dB
3	3m chamber Radiated spurious emission(1GHz-18GHz)	U=4.5dB
4	3m chamber Radiated spurious emission(18GHz-40GHz)	U=3.34dB
5	Conducted Emission(150kHz-30MHz)	U=3.20dB
6	Conducted Adjacent channel power	U=1.38dB
7	Conducted output power uncertainty Above 1G	U=1.576dB
8	Conducted output power uncertainty below 1G	U=1.28dB
9	humidity uncertainty	U=5.3%
10	Temperature uncertainty	U=0.59°C

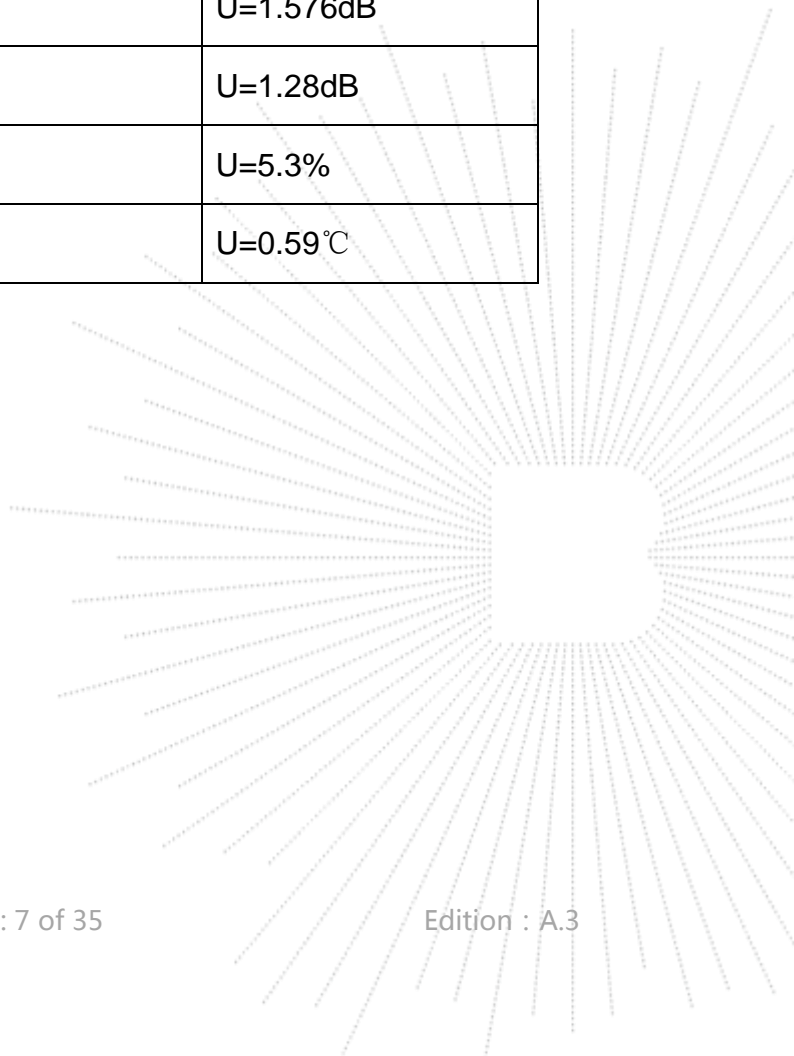

4. PRODUCT INFORMATION AND TEST SETUP

4.1 Product Information

Model/Type Ref.:	PTS-018 PTS-008, PTS-015, PTS-108, PTS-118, p-collar 310, p-collar 320, p-collar 330, p-collar 340, p-collar 610, p-collar 620, p-collar 630, p-collar 640, p-collar 810, p-collar 820, p-collar 910, p-collar 920
Model differences:	All the model are the same circuit and RF module, except model names
Hardware Version:	N/A
Software Version:	N/A
Operation Frequency:	433.92MHz
Type of Modulation:	ASK
Number Of Channel	1CH
Antenna installation:	Internal antenna
Antenna Gain:	0dBi
Ratings:	DC 5V from adapter DC 3.7V from Battery

4.2 Test Setup Configuration

See test photographs attached in *EUT TEST SETUP PHOTOGRAPHS* for the actual connections between Product and support equipment.

Conducted Emission:

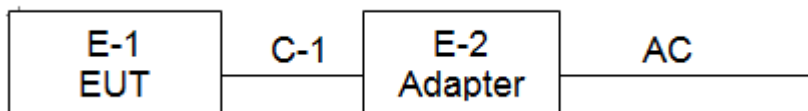

Radiated Spurious Emission

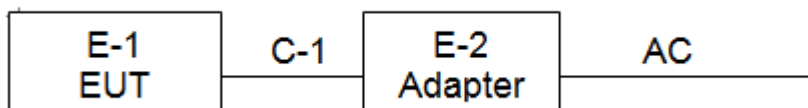

4.3 Support Equipment

No.	Device Type	Brand	Model	Series No.	Note
E-1	Dog Training Collar	N/A	PTS-018	PTS-118, p-collar 320, p-collar 330, p-collar 340, p-collar 610, p-collar 620, p-collar 630, p-collar 640, p-collar 810, p-collar 820, p-collar 910, p-collar 920, p-nobark 320	EUT
E-2	Adapter	N/A	BCTC001	N/A	Auxiliary

Item	Shielded Type	Ferrite Core	Length	Note
C-1	NO	NO	0.5M	USB cable unshielded

Notes:

1. All the equipment/cables were placed in the worst-case configuration to maximize the emission during the test.
2. Grounding was established in accordance with the manufacturer's requirements and conditions for the intended use.

4.4 Channel List

CH	Frequency (MHz)
1	433.92

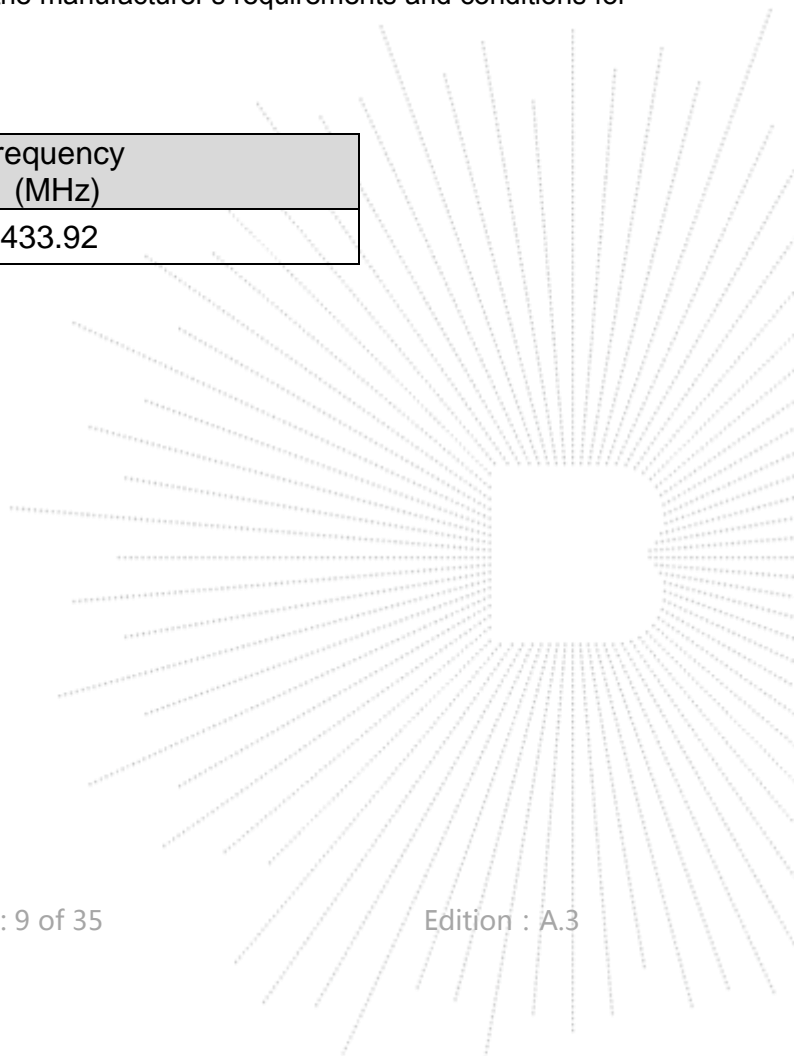

4.5 Test Mode

To investigate the maximum EMI emission characteristics generates from EUT, the test system was pre-scanning tested base on the consideration of following EUT operation mode or test configuration mode which possible have effect on EMI emission level. Each of these EUT operation mode(s) or test configuration mode(s) mentioned above was evaluated respectively.

Final Test Mode	Description
Mode 1	Charging Mode
Mode 2	TX Mode

Note:

- (1) The measurements are performed at the highest, middle, lowest available channels.
- (2) Fully-charged battery is used during the test

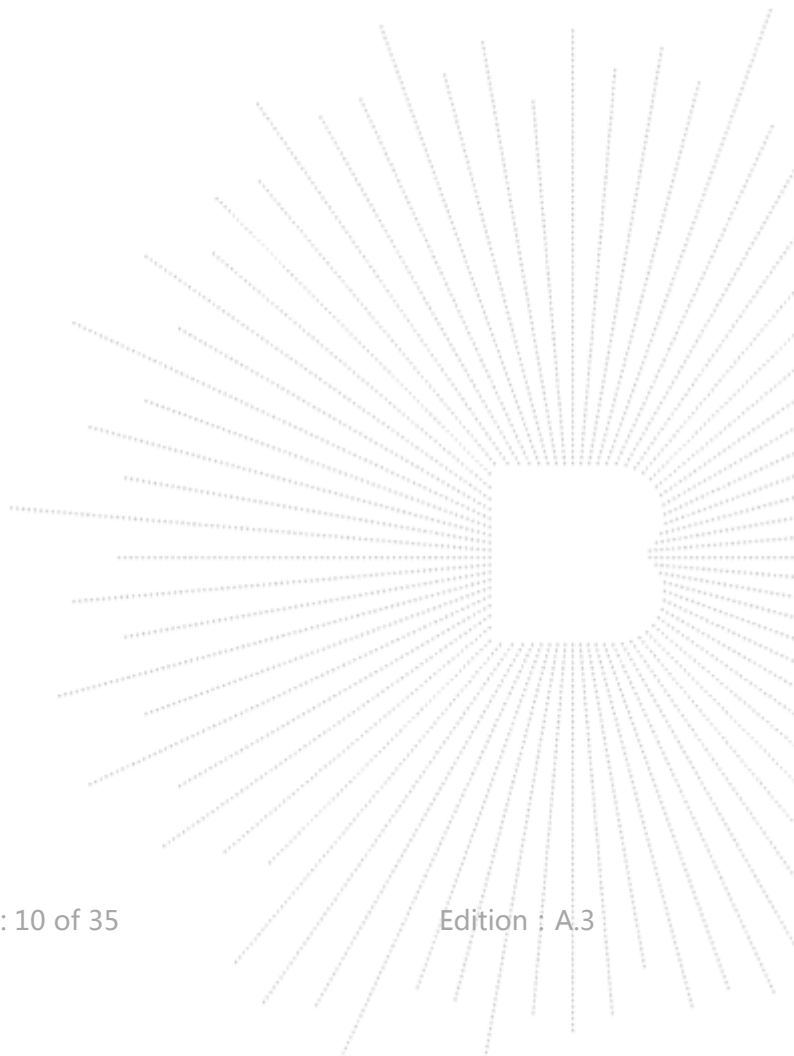

5. TEST FACILITY AND TEST INSTRUMENT USED

5.1 Test Facility

All measurement facilities used to collect the measurement data are located at Shenzhen BCTC Testing Co., Ltd. Address: 1-2/F., Building B, Pengzhou Industrial Park, No.158, Fuyuan 1st Road, Tangwei, Fuhai Subdistrict, Bao'an District, Shenzhen, Guangdong, China. The site and apparatus are constructed in conformance with the requirements of ANSI C63.4 and CISPR 16-1-1 other equivalent standards.

FCC Test Firm Registration Number: 712850

IC Registered No.: 23583

5.2 Test Instrument Used

Conduction Test equipment

Item	Equipment	Manufacturer	Type No.	Serial No.	Last calibration	Calibrated until
1	Test Receiver	R&S	ESR3	102075	May 28, 2021	May 27, 2022
2	LISN	SCHWARZBECK	NSLK8127	8127739	May 28, 2021	May 27, 2022
3	LISN	R&S	ENV216	101375	May 28, 2021	May 27, 2022
4	RF cables	Huber+Suhnar	9kHz-30MHz	B1702988-0008	May 28, 2021	May 27, 2022
5	Software	Frad	EZ-EMC	EMC-CON 3A1	\	\

Radiation Test equipment

Item	Equipment	Manufacturer	Type No.	Serial No.	Last calibration	Calibrated until
1	Spectrum Analyzer (9kHz-26.5GHz)	Agilent	E4407B	MY45109572	May 28, 2021	May 27, 2022
2	Test Receiver (9kHz-7GHz)	R&S	ESR7	101154	May 28, 2021	May 27, 2022
3	Bilog Antenna (30MHz-3GHz)	SCHWARZB ECK	VULB9163	VULB9163-942	Jun. 01, 2021	May 31, 2022
4	Horn Antenna (1GHz-18GHz)	SCHWARZB ECK	BBHA9120D	1541	Jun. 02, 2021	Jun. 01, 2022
5	Horn Antenna (18GHz-40GHz)	SCHWARZB ECK	BBHA9170	00822	May 28, 2021	May 27, 2022
6	Amplifier (9KHz-6GHz)	SCHWARZB ECK	BBV9744	9744-0037	May 28, 2021	May 27, 2022
7	Amplifier (0.5GHz-18GHz)	SCHWARZB ECK	BBV9718	9718-309	May 28, 2021	May 27, 2022
8	Amplifier (18GHz-40GHz)	MITEQ	TTA1840-35-HG	2034381	May 28, 2021	May 27, 2022
9	Loop Antenna (9KHz-30MHz)	SCHWARZB ECK	FMZB1519B	00014	May 28, 2021	May 27, 2022
10	RF cables1 (9kHz-30MHz)	Huber+Suhner	9kHz-30MHz	B1702988-0008	May 28, 2021	May 27, 2022
11	RF cables2 (30MHz-1GHz)	Huber+Suhner	30MHz-1GHz	1486150	May 28, 2021	May 27, 2022
12	RF cables3 (1GHz-40GHz)	Huber+Suhner	1GHz-40GHz	1607106	May 28, 2021	May 27, 2022
13	Power Metter	Keysight	E4419B	\	May 28, 2021	May 27, 2022
14	Power Sensor (AV)	Keysight	E9 300A	\	May 28, 2021	May 27, 2022
15	Signal Analyzer 20kHz-26.5GHz	KEYSIGHT	N9020A	MY49100060	May 28, 2021	May 27, 2022
16	Spectrum Analyzer 9kHz-40GHz	Agilent	FSP40	100363	May 28, 2021	May 27, 2022
17	D.C. Power Supply	LongWei	TPR-6405D	\	\	\
18	Software	Frad	EZ-EMC	FA-03A2 RE	\	\

6. CONDUCTED EMISSIONS

6.1 Block Diagram Of Test Setup

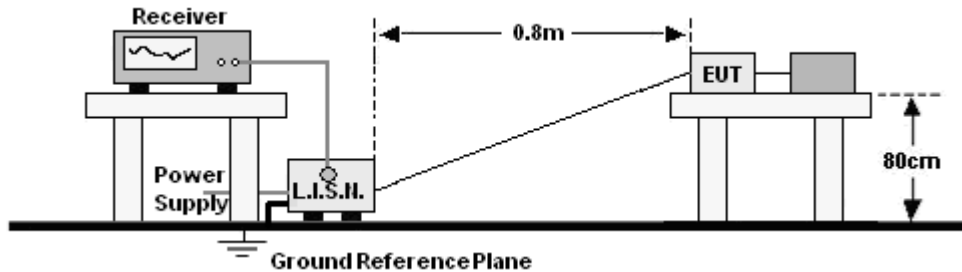

6.2 Limit

FREQUENCY (MHz)	Limit (dBuV)	
	Quas-peak	Average
0.15 -0.5	66 - 56 *	56 - 46 *
0.50 -5.0	56.00	46.00
5.0 -30.0	60.00	50.00

Notes:
 1. *Decreasing linearly with logarithm of frequency.
 2. The lower limit shall apply at the transition frequencies.

6.3 Test procedure

Receiver Parameters	Setting
Attenuation	10 dB
Start Frequency	0.15 MHz
Stop Frequency	30 MHz
IF Bandwidth	9 kHz

a. The Product was placed on a nonconductive table 0.8 m above the horizontal ground reference plane, and 0.4 m from the vertical ground reference plane, and connected to the main through Line Impedance Stability Network (L.I.S.N).

b. The RBW of the receiver was set at 9 kHz in 150 kHz ~ 30MHz with Peak and AVG detector in Max Hold mode. Run the receiver's pre-scan to record the maximum disturbance generated from Product in all power lines in the full band.

c. For each frequency whose maximum record was higher or close to limit, measure its QP and AVG values and record.

6.4 EUT operating Conditions

The EUT was configured for testing in a typical fashion (as a customer would normally use it). The EUT has been programmed to continuously transmit during test. This operating condition was tested and used to collect the included data.

6.5 Test Result

Temperature :	26 °C	Relative Humidity :	54%
Pressure :	101kPa	Phase :	L
Test Voltage :	AC 120V/60Hz	Test Mode :	Mode 1

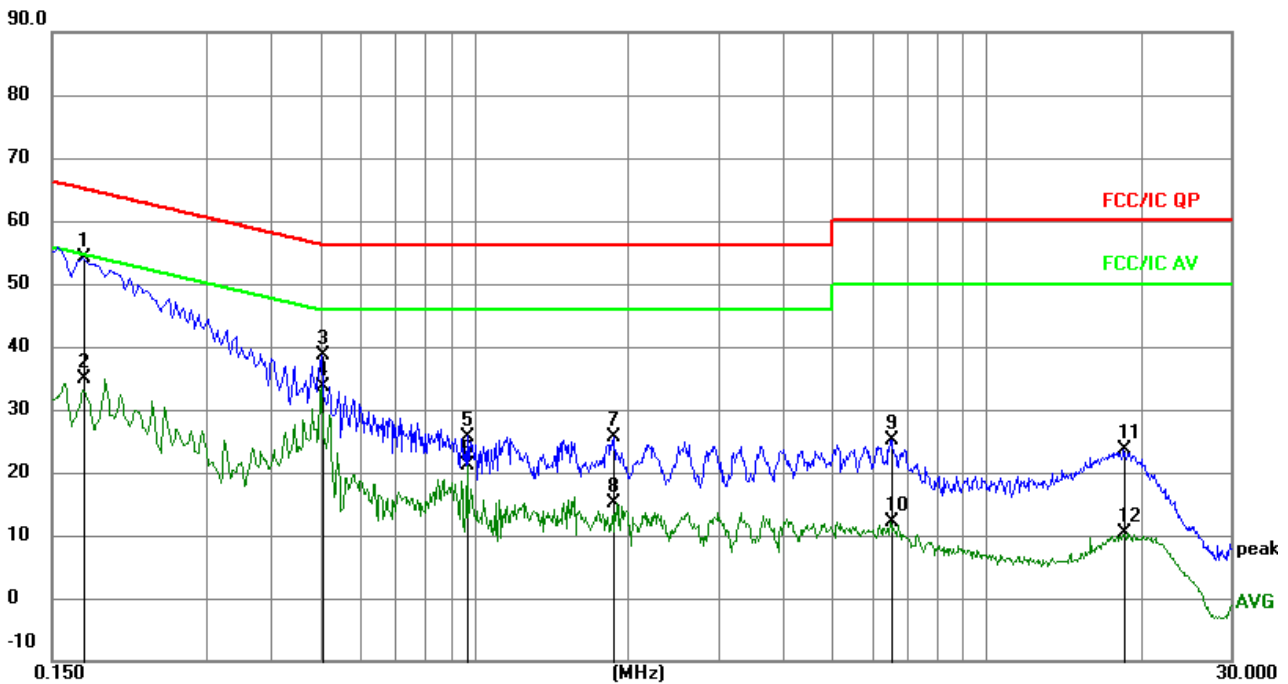

Remark:

1. All readings are Quasi-Peak and Average values.
2. Factor = Insertion Loss + Cable Loss.

No.	Mk.	Freq. MHz	Reading Level	Correct Factor dB	Measure- ment dBuV	Limit dBuV	Over dB	Detector
1	*	0.1722	44.57	9.49	54.06	64.85	-10.79	QP
2		0.1722	25.31	9.49	34.80	54.85	-20.05	AVG
3		0.5047	29.01	9.61	38.62	56.00	-17.38	QP
4		0.5047	24.13	9.61	33.74	46.00	-12.26	AVG
5		0.9684	16.00	9.58	25.58	56.00	-30.42	QP
6		0.9684	11.48	9.58	21.06	46.00	-24.94	AVG
7		1.8779	16.12	9.59	25.71	56.00	-30.29	QP
8		1.8779	5.58	9.59	15.17	46.00	-30.83	AVG
9		6.4882	15.38	9.74	25.12	60.00	-34.88	QP
10		6.4882	2.42	9.74	12.16	50.00	-37.84	AVG
11		18.5237	13.98	9.76	23.74	60.00	-36.26	QP
12		18.5237	0.51	9.76	10.27	50.00	-39.73	AVG

Temperature :	26 °C	Relative Humidity :	54%
Pressure :	101kPa	Phase :	N
Test Voltage :	AC 120V/60Hz	Test Mode :	Mode 1

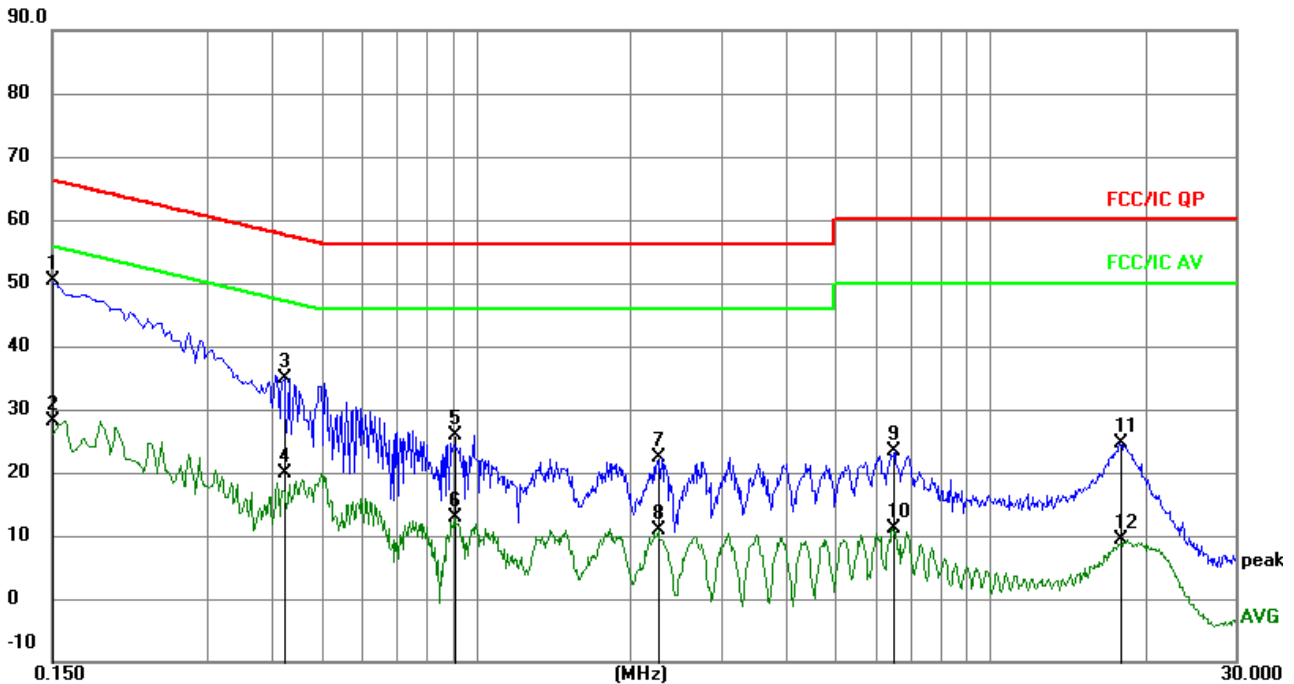
Remark:

1. All readings are Quasi-Peak and Average values.
2. Factor = Insertion Loss + Cable Loss.

No.	Mk.	Freq. MHz	Reading Level	Correct Factor dB	Measure- ment dBuV	Limit dBuV	Over dB	Detector
1	*	0.1500	40.81	9.52	50.33	66.00	-15.67	QP
2		0.1500	18.71	9.52	28.23	56.00	-27.77	AVG
3		0.4245	25.34	9.52	34.86	57.36	-22.50	QP
4		0.4245	10.34	9.52	19.86	47.36	-27.50	AVG
5		0.9105	16.17	9.60	25.77	56.00	-30.23	QP
6		0.9105	3.35	9.60	12.95	46.00	-33.05	AVG
7		2.2650	12.79	9.61	22.40	56.00	-33.60	QP
8		2.2650	1.22	9.61	10.83	46.00	-35.17	AVG
9		6.4725	13.57	9.74	23.31	60.00	-36.69	QP
10		6.4725	1.37	9.74	11.11	50.00	-38.89	AVG
11		17.9160	14.96	9.75	24.71	60.00	-35.29	QP
12		17.9160	-0.35	9.75	9.40	50.00	-40.60	AVG

7. RADIATED EMISSIONS

7.1 Block Diagram Of Test Setup

(A) Radiated Emission Test-Up Frequency Below 30MHz

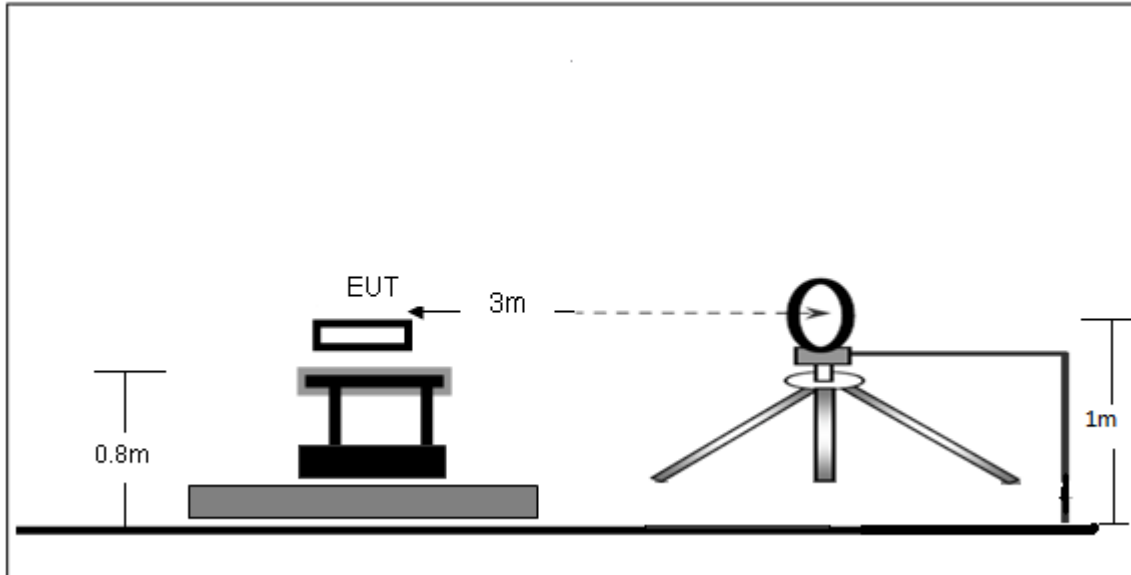

(B) Radiated Emission Test-Up Frequency 30MHz~1GHz

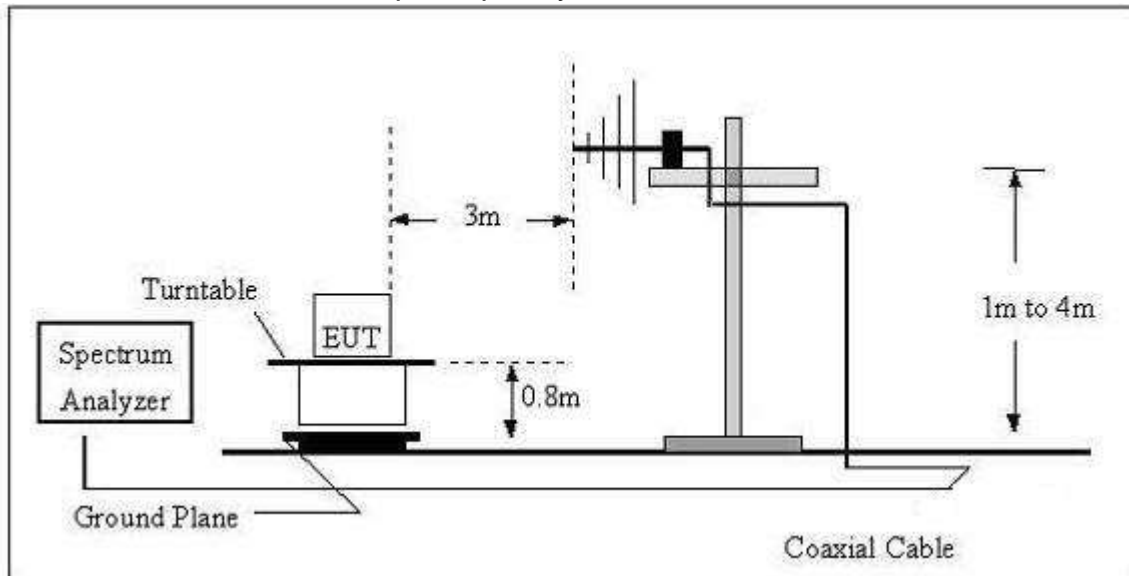

(C) Radiated Emission Test-Up Frequency Above 1GHz

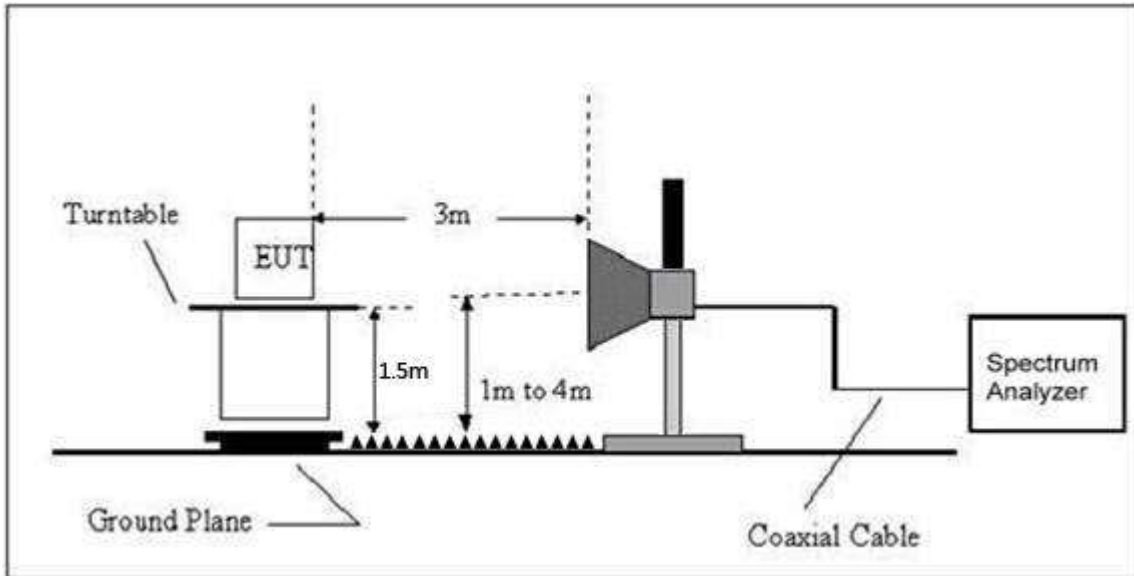

7.2 Limit

20dBc in any 100 kHz bandwidth outside the operating frequency band. In case the emission fall within the restricted band specified on 15.205(a), then the 15.209(a) limit in the table below has to be followed.

Frequency (MHz)	Field Strength uV/m	Distance (m)	Field Strength Limit at 3m Distance	
			uV/m	dBuV/m
0.009 ~ 0.490	2400/F(kHz)	300	$10000 * 2400/F(\text{kHz})$	$20\log^{(2400/F(\text{kHz}))} + 80$
0.490 ~ 1.705	24000/F(kHz)	30	$100 * 24000/F(\text{kHz})$	$20\log^{(24000/F(\text{kHz}))} + 40$
1.705 ~ 30	30	30	$100 * 30$	$20\log^{(30)} + 40$
30 ~ 88	100	3	100	$20\log^{(100)}$
88 ~ 216	150	3	150	$20\log^{(150)}$
216 ~ 960	200	3	200	$20\log^{(200)}$
Above 960	500	3	500	$20\log^{(500)}$

LIMITS OF RADIATED EMISSION MEASUREMENT (Above 1000MHz)

FREQUENCY (MHz)	Limit (dBuV/m) (at 3M)	
	PEAK	AVERAGE
Above 1000	74	54

Notes:

- (1) The limit for radiated test was performed according to FCC PART 15C.
- (2) The tighter limit applies at the band edges.
- (3) Emission level (dBuV/m) = $20\log$ Emission level (uV/m).

FREQUENCY RANGE OF RADIATED MEASUREMENT (For unintentional radiators)

Highest frequency generated or Upper frequency of measurement used in the device or on which the device operates or tunes (MHz)	Range (MHz)
Below 1.705	30
1.705 – 108	1000
108 – 500	2000
500 – 1000	5000
Above 1000	5 th harmonic of the highest frequency or 40 GHz, whichever is lower

7.3 Test procedure

Receiver Parameter	Setting
Attenuation	Auto
9kHz~150kHz	RBW 200Hz for QP
150kHz~30MHz	RBW 9kHz for QP
30MHz~1000MHz	RBW 120kHz for QP

Spectrum Parameter	Setting
1-6GHz	RBW 1 MHz /VBW 1 MHz for Peak, RBW 1 MHz / VBW 10Hz for Average

Below 1GHz test procedure as below:

- a. The EUT was placed on the top of a rotating table 0.8 meters above the ground at a 3 meter semi-anechoic chamber. The table was rotated 360 degrees to determine the position of the highest radiation.
- b. The EUT was set 3 meters away from the interference-receiving antenna, which was mounted on the top of a variable-height antenna tower.
- c. The antenna height is varied from one meter to four meters above the ground to determine the maximum value of the field strength. Both horizontal and vertical polarizations of the antenna are set to make the measurement.
- d. For each suspected emission, the EUT was arranged to its worst case and then the antenna was tuned to heights from 1 meter to 4 meters (for the test frequency of below 30MHz, the antenna was tuned to heights 1 meter) and the rotatable table was turned from 0 degrees to 360 degrees to find the maximum reading.
- e. The test-receiver system was set to Peak Detect Function and Specified Bandwidth with Maximum Hold Mode.

f. If the emission level of the EUT in peak mode was 10dB lower than the limit specified, then testing could be stopped and the peak values of the EUT would be reported. Otherwise the emissions that did not have 10dB margin would be re-tested one by one using peak, quasi-peak or average method as specified and then reported in a data sheet.

Above 1GHz test procedure as below:

g. Different between above is the test site, change from Semi- Anechoic Chamber to fully Anechoic Chamber and change form table 0.8 metre to 1.5 metre(Above 18GHz the distance is 1 meter and table is 1.5 metre).

h. Test the EUT in the lowest channel, the middle channel ,the Highest channel.

Note:

Both horizontal and vertical antenna polarities were tested and performed pretest to three orthogonal axis. The worst case emissions were reported.

Above 1GHz test procedure as below:

a. The EUT was placed on the top of a rotating table 1.5 meters above the ground at a 3 meter chamber. The table was rotated 360 degrees to determine the position of the highest radiation.

b. The EUT was set 3 meters away from the interference-receiving antenna, which was mounted on the top of a variable-height antenna tower.

c. The antenna height is varied from one meter to four meters above the ground to determine the maximum value of the field strength. Both horizontal and vertical polarizations of the antenna are set to make the measurement.

d. For each suspected emission, the EUT was arranged to its worst case and then the antenna was tuned to heights from 1 meter to 4 meters and the rota table was turned from 0 degrees to 360 degrees to find the maximum reading.

e. The test-receiver system was set to Peak Detect Function and Specified Bandwidth with Maximum Hold Mode.

f. If the emission level of the EUT in peak mode was 10dB lower than the limit specified, then testing could be stopped and the peak values of the EUT would be reported. Otherwise the emissions that did not have 10dB margin would be re-tested one by one using peak, quasi-peak or average method as specified and then reported in a data sheet.

g. Test the EUT in the lowest channel, the Highest channel.

Note:

Both horizontal and vertical antenna polarities were tested and performed pretest to three orthogonal axis. The worst case emissions were reported.

7.4 EUT operating Conditions

The EUT was configured for testing in a typical fashion (as a customer would normally use it). The EUT has been programmed to continuously transmit during test. This operating condition was tested and used to collect the included data.

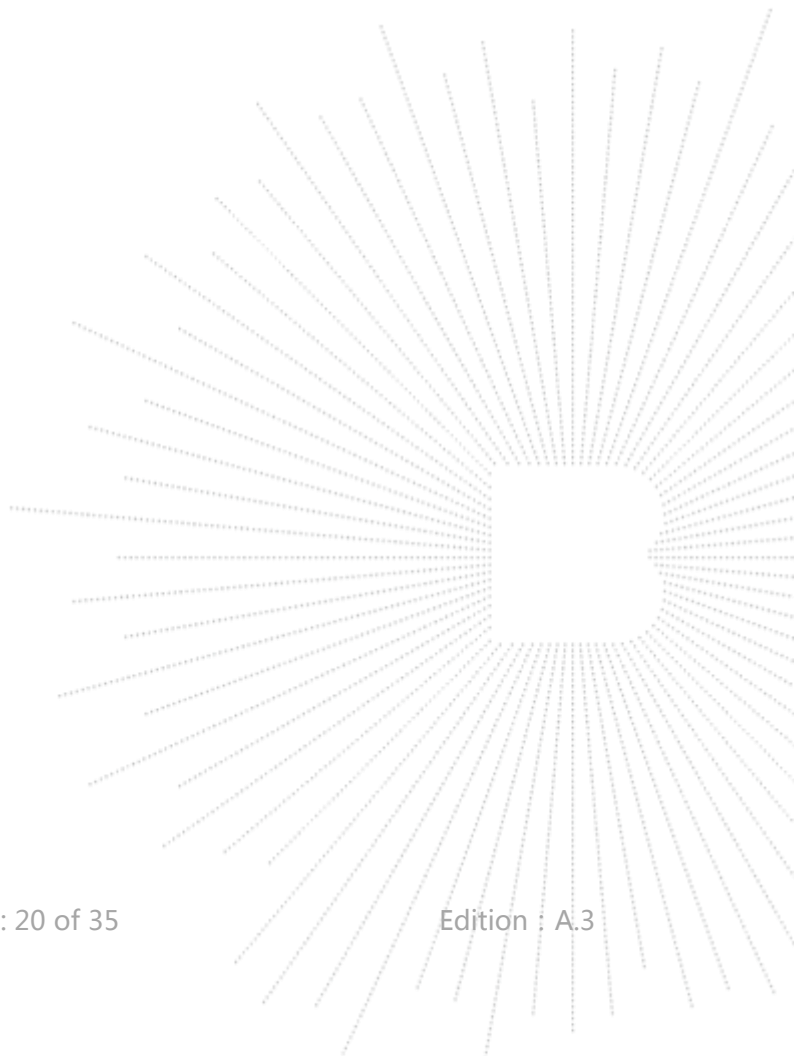

7.5 Test Result

Below 30MHz

Temperature:	26°C	Relative Humidity:	24%
Pressure:	101 kPa	Test Voltage :	DC 5V from adapter
Test Mode :	Mode 2	Polarization :	--

Freq. (MHz)	Reading (dBuV/m)	Limit (dBuV/m)	Margin (dB)	State P/F
--	--	--	--	PASS
--	--	--	--	PASS

Note:

The amplitude of spurious emissions which are attenuated by more than 20dB below the permissible value has no need to be reported.

Distance extrapolation factor = $40 \log (\text{specific distance}/\text{test distance})(\text{dB})$;

Limit line = specific limits(dBuv) + distance extrapolation factor.

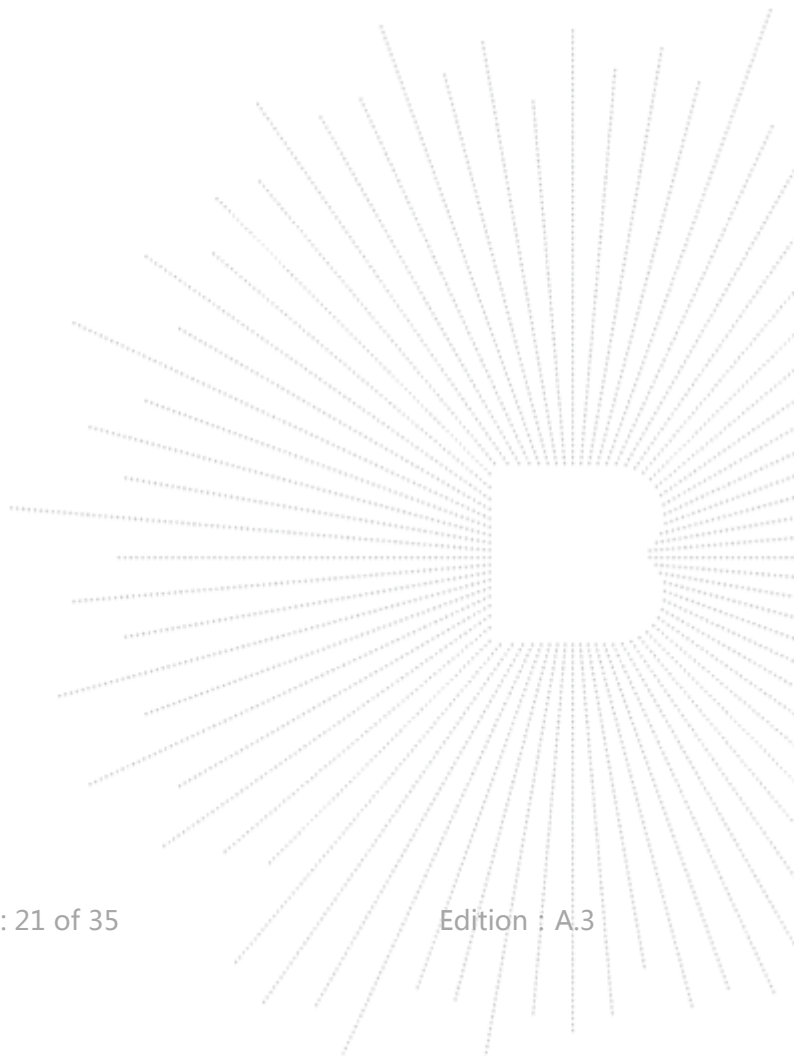

Between 30MHz – 1GHz

Temperature:	26°C	Relative Humidity:	54%
Pressure:	101 kPa	Test Voltage :	DC 3.7V from Battery
Test Mode :	Mode 2	Polarization :	Horizontal

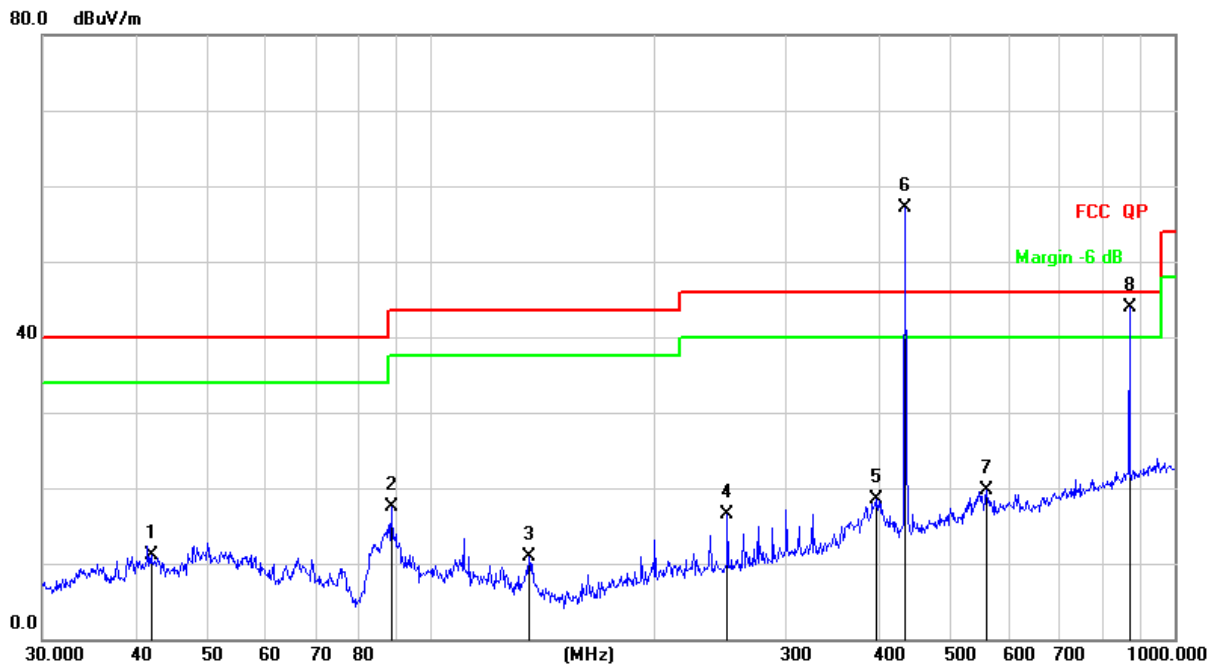

Remark:

Factor = Antenna Factor + Cable Loss – Pre-amplifier.

No.	Mk.	Freq. MHz	Reading Level dBuV	Correct Factor dB	Measure- ment dBuV/m	Limit dB/m	Over dB	Detector
1		42.0066	26.36	-15.30	11.06	40.00	-28.94	QP
2		88.3421	35.96	-18.48	17.48	43.50	-26.02	QP
3		135.5062	29.42	-18.57	10.85	43.50	-32.65	QP
4		250.3012	31.59	-15.14	16.45	46.00	-29.55	QP
5		396.2415	29.73	-11.18	18.55	46.00	-27.45	QP
6	*	434.0651	67.40	-10.33	57.07	100.83	-43.76	peak
7		558.7302	27.17	-7.48	19.69	46.00	-26.31	QP
8	!	869.1302	46.12	-2.13	43.99	80.83	-36.84	peak

Temperature:	26°C	Relative Humidity:	54%
Pressure:	101 kpa	Test Voltage :	DC 3.7V from Battery
Test Mode :	Mode 2	Polarization :	Vertical

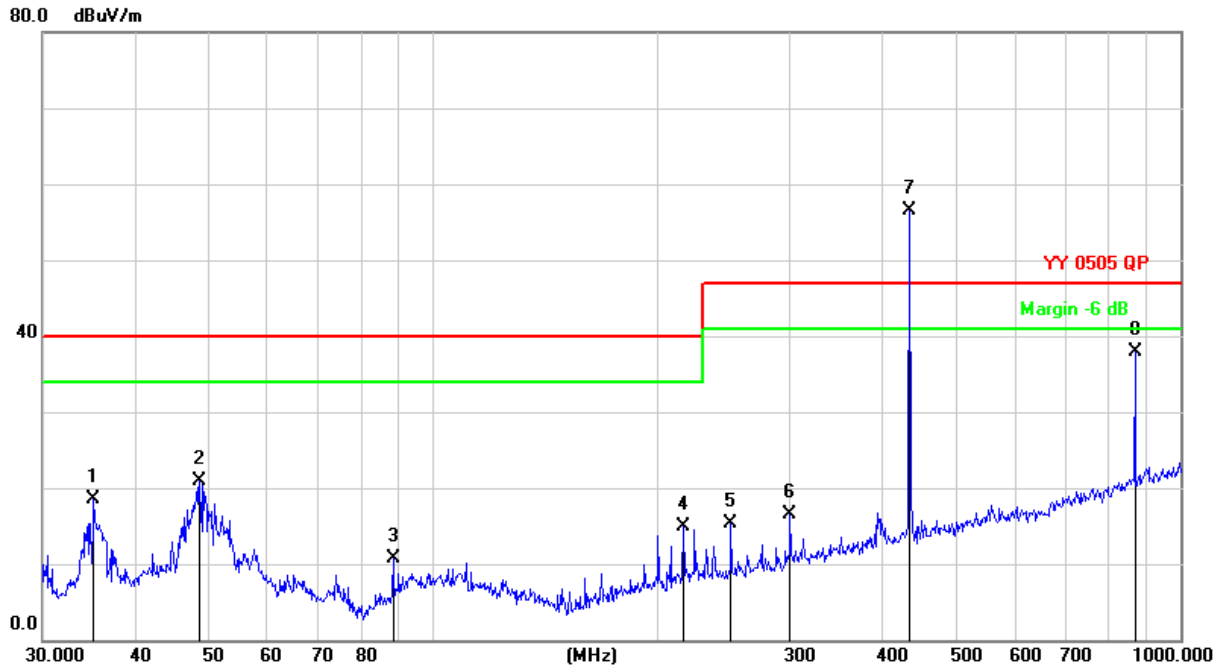

Remark:

Factor = Antenna Factor + Cable Loss – Pre-amplifier.

No.	Mk.	Freq.	Reading Level	Correct Factor	Measurement	Limit	Over	Detector
		MHz	dBuV	dB	dBuV/m	dB/m	dB	
1		35.1278	34.88	-16.32	18.56	40.00	-21.44	QP
2		48.6719	35.78	-14.92	20.86	40.00	-19.14	QP
3		88.3421	29.20	-18.48	10.72	43.50	-32.78	QP
4		216.0240	30.88	-15.93	14.95	46.00	-31.05	QP
5		250.3012	30.45	-15.14	15.31	46.00	-30.69	QP
6		300.3672	30.11	-13.59	16.52	46.00	-29.48	QP
7	*	434.0651	66.81	-10.33	56.48	100.83	-44.5	peak
8		869.1302	40.04	-2.13	37.91	80.83	-42.92	peak

For average Emission

Frequency MHz	Peak Level dBuV/m	Duty cycle factor	Average Level dBuV/m	Limit AV	Margin	Polarization
433	57.07	-4.88	52.19	80.83	-28.64	Horizontal
866	43.99	-4.88	39.11	60.83	-21.72	Horizontal

Notes: 1. Average emission Level = Peak Level + Duty cycle factor
 2. Duty cycle level please see clause 5.

Frequency MHz	Peak Level dBuV/m	Duty cycle factor	Average Level dBuV/m	Limit AV	Margin	Polarization
433	56.48	-4.88	51.60	80.83	-29.23	Vertical
866	37.91	-4.88	33.03	60.83	-27.80	Vertical

Notes: 1. Average emission Level = Peak Level + Duty cycle factor
 2. Duty cycle level please see clause 5.

Radiated Spurious Emission (1GHz to 10th harmonics)

Frequency MHz	Peak Level dBuV/m	Duty cycle factor	Average Level dBuV/m	Limit		Margin dB		Polarization
				PK	AV	PK	AV	
1299	51.64	-4.88	46.76	80.83	60.83	-34.07	-14.07	Vertical
1732	52.37	-4.88	47.49	80.83	60.83	-33.34	-13.34	Vertical
2598	51.45	-4.88	46.57	80.83	60.83	-34.26	-14.26	Vertical
3031	52.26	-4.88	47.38	80.83	60.83	-33.45	-13.45	Vertical
3464	50.05	-4.88	45.17	80.83	60.83	-35.66	-15.66	Vertical
3897	47.72	-4.88	42.84	80.83	60.83	-37.99	-17.99	Vertical
1299	47.54	-4.88	42.66	80.83	60.83	-38.17	-18.17	Horizontal
1732	47.86	-4.88	42.98	80.83	60.83	-37.85	-17.85	Horizontal
2598	49.31	-4.88	44.43	80.83	60.83	-36.4	-16.4	Horizontal
3031	49.28	-4.88	44.4	80.83	60.83	-36.43	-16.43	Horizontal
3464	47.13	-4.88	42.25	80.83	60.83	-38.58	-18.58	Horizontal
3897	48.99	-4.88	44.11	80.83	60.83	-36.72	-16.72	Horizontal

Notes: 1. Average emission Level = Peak Level + Duty cycle factor
 2. Duty cycle level please see clause 5.
 3. Pulse Desensitization Correction Factor
 Pulse Width (PW) = 63.60ms
 $2/PW = 2/63.60ms = 0.031$ kHz
 RBW (100 kHz) > 2/PW (0.031 kHz)
 Therefore PDCF is not needed
 4. Other harmonics emissions are lower than 20dB below the allowable limit.

8. BANDWIDTH TEST

8.1 Block Diagram Of Test Setup



8.2 Limit

According to FCC 15.231(c) requirement:

The bandwidth of the emission shall be no wider than 0.25% of the center frequency for devices operating between 70 MHz to 900 MHz. Those devices operating above 900 MHz, the emission spurious shall be no wider than 0.5% of the center frequency. Bandwidth is determined at the points 20 dB down from the modulated carrier.

$$\text{B.W (20dBc) Limit} = 0.25\% * f(\text{MHz}) = 0.25\% * 433.92\text{MHz} = 1.0848\text{MHz}$$

Spectrum Parameter	Setting
Attenuation	Auto
Span Frequency	> Measurement Bandwidth or Channel Separation
RB	1kHz
VB	\geq RBW
Detector	Peak
Trace	Max Hold
Sweep Time	Auto

8.3 Test procedure

- The EUT was directly connected to the spectrum analyzer and antenna output port as show in the block diagram below,
- Spectrum Setting : RBW= 1kHz, VBW \geq RBW, Sweep time = Auto.

8.4 EUT operating Conditions

The EUT tested system was configured as the statements of 2.4 Unless otherwise a special operating condition is specified in the follows during the testing.

8.5 Test Result

Temperature :	26 °C	Relative Humidity :	54%
Pressure :	101kPa	Test Voltage :	DC 3.7V from Battery
Test Mode :	Mode 2		

Frequency	20dB Bandwidth (kHz)	Limit (MHz)	Result
433.92MHz	8.521	1.0848	PASS

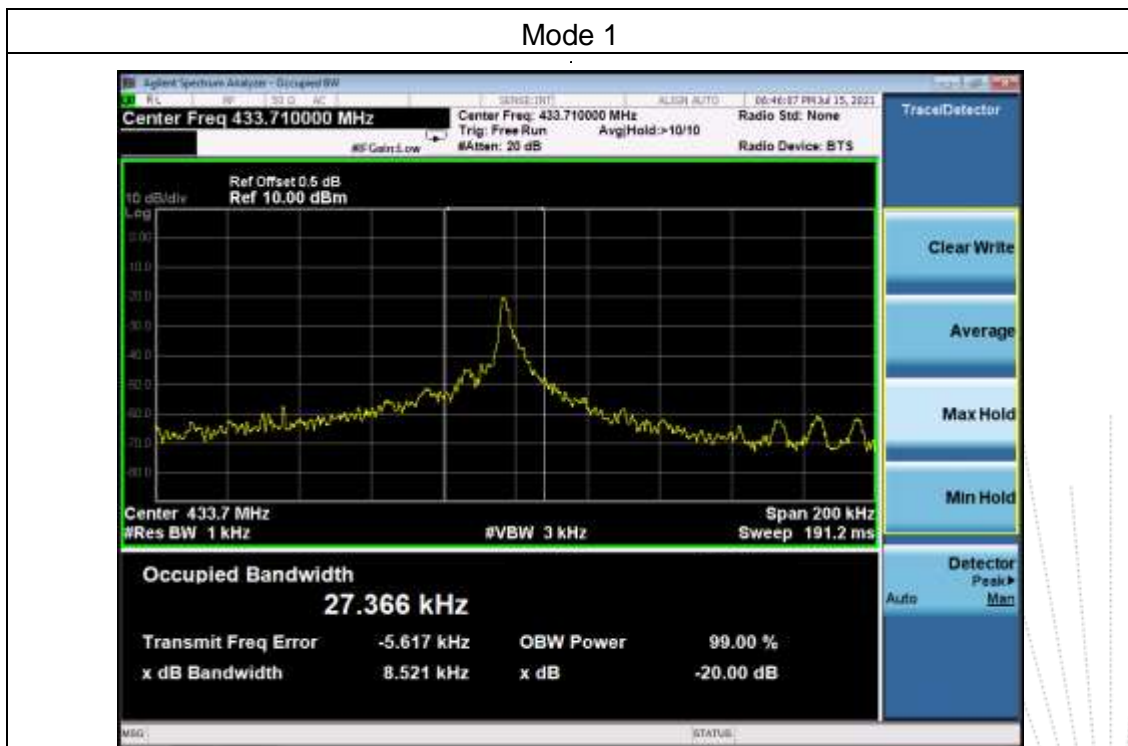

9. CALCULATION OF AVERAGE FACTOR

The output field strengths of specification in accordance with the FCC rules specify measurements with an average detector. During the test, a spectrum analyzer incorporating a peak detector was used. Therefore, a reduction factor can be applied to the resultant peak signal level and compared to the limit for measurement instrumentation incorporating an average detector.

The duty cycle is measured in 100 ms or the repetition cycle period, whichever is a shorter time frame. The duty cycle is measured by placing the spectrum analyzer to set zero span at 100kHz resolution bandwidth.

Averaging factor in dB = $20\log(\text{duty cycle})$

The duration of one cycle = 51.90ms

The duty cycle is simply the on-time divided the duration of one cycle

Duty Cycle = $(1.355\text{ms} \times 23 + 0.49\text{ms} \times 11) / 63.60\text{ms}$

= $36.55\text{ms} / 63.60\text{ms}$

= 0.57

Therefore, the averaging factor is found by $20\log 0.57 = -4.88\text{dB}$

Test plot as follows:

Note: During the 100ms, the amount of pulse and on-time of pulse are the same for every pulse train.

Cycle

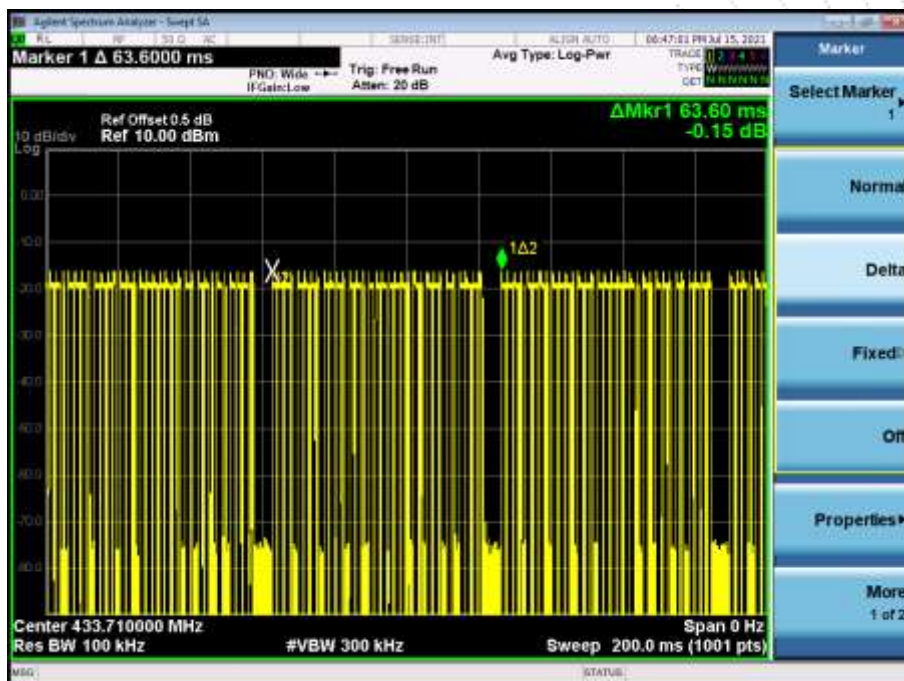

Pulse

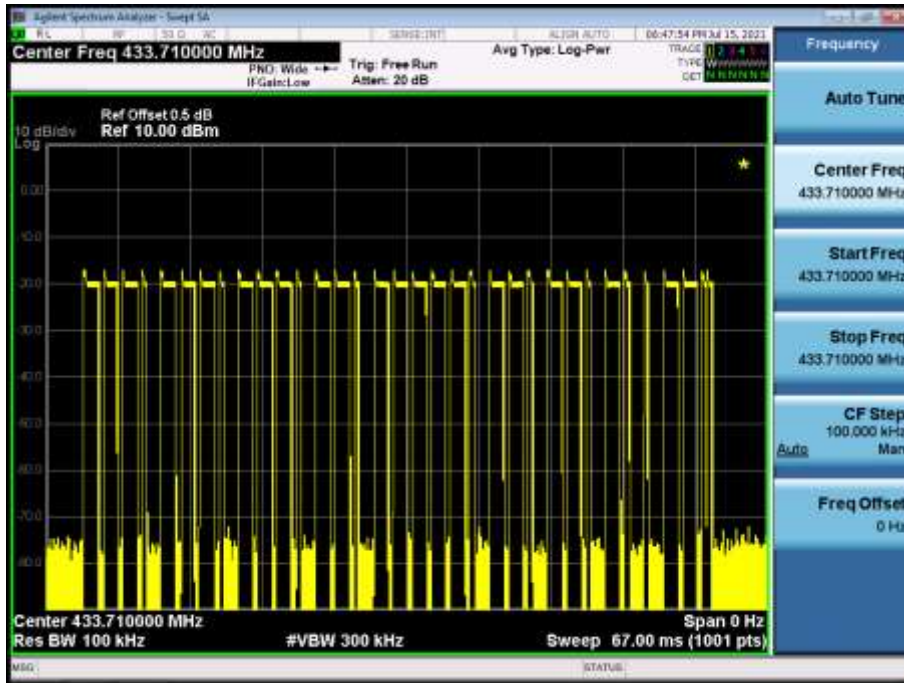

On-time

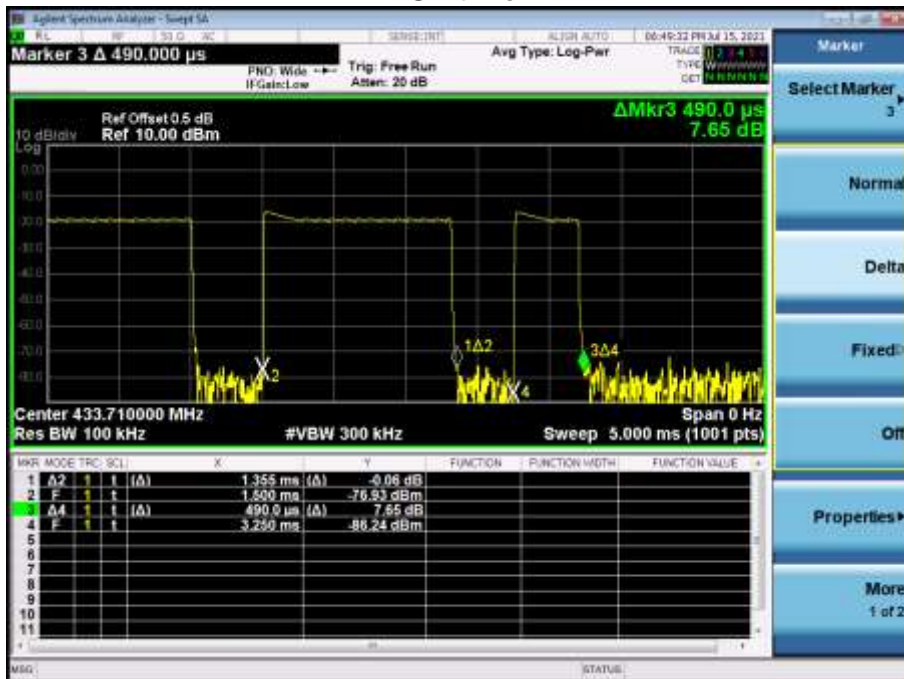

10. DWEELL TIME

10.1 Block Diagram Of Test Setup

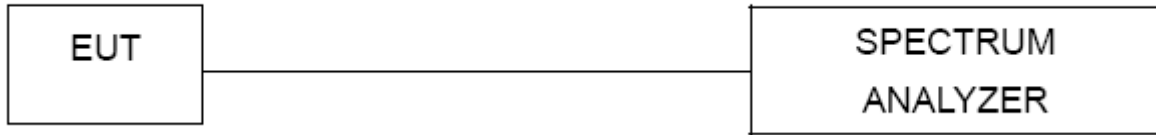

10.2 Limit

According to FCC 15.231(a) requirement:

A manually operated transmitter shall employ a switch that will automatically deactivate the transmitter within not more than 5 seconds of being released.

10.3 Test procedure

- a) Check the calibration of the measuring instrument using either an internal calibrator or a known signal from an external generator.
- b) Position the EUT without connection to measurement instrument. Turn on the EUT and connect its antenna terminal to measurement instrument via a low loss cable. Then set it to any one measured frequency within its operating range, and make sure the instrument is operated in its linear range.
- c) Set RBW to 100 kHz and VBW of spectrum analyzer to 300 kHz with a convenient frequency span including 100 kHz bandwidth from band edge.
- d) Measure the highest amplitude appearing on spectral display and set it as a reference level. Plot the graph with marking the highest point and edge frequency.
- e) Repeat above procedures until all measured frequencies were complete.

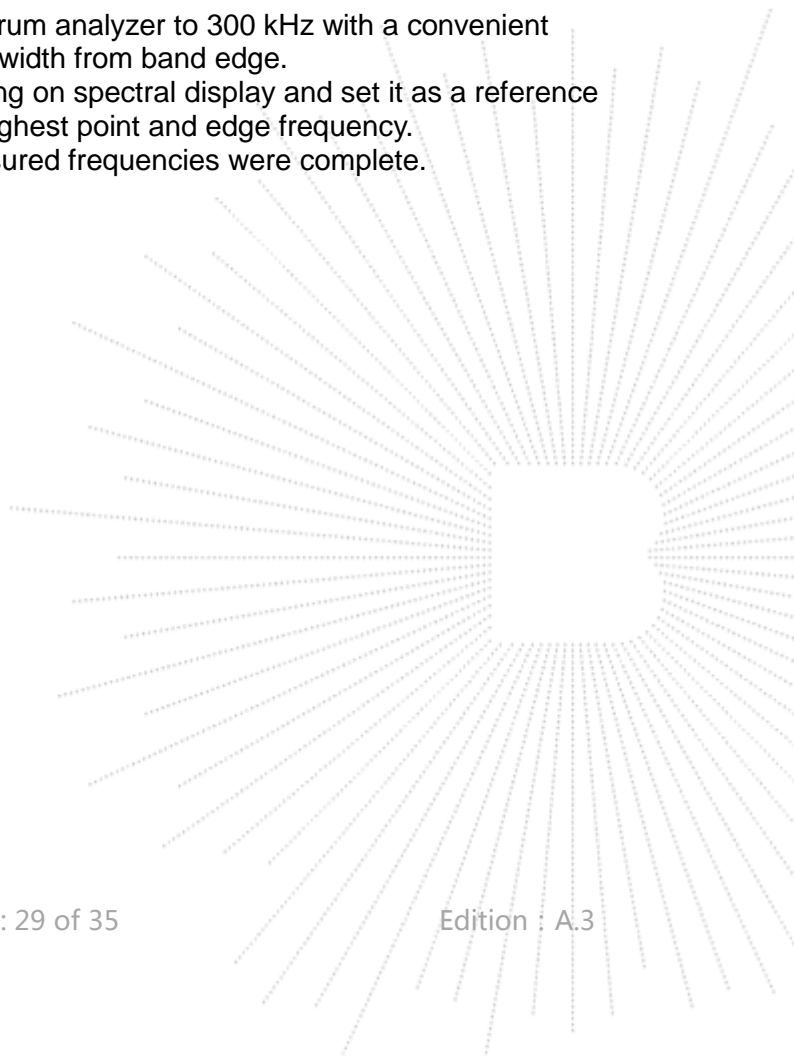

10.4 Test Result

Dwell time (second)	Limit (second)	Result
560.0ms	<5s	Pass

Test plot as follows:



11. ANTENNA REQUIREMENT

11.1 STANDARD REQUIREMENT

15.203 requirement: For intentional device, according to 15.203: an intentional radiator shall be designed to ensure that no antenna other than that furnished by the responsible party shall be used with the device.

11.2 EUT ANTENNA

The EUT antenna is the Internal antenna. It comply with the standard requirement.

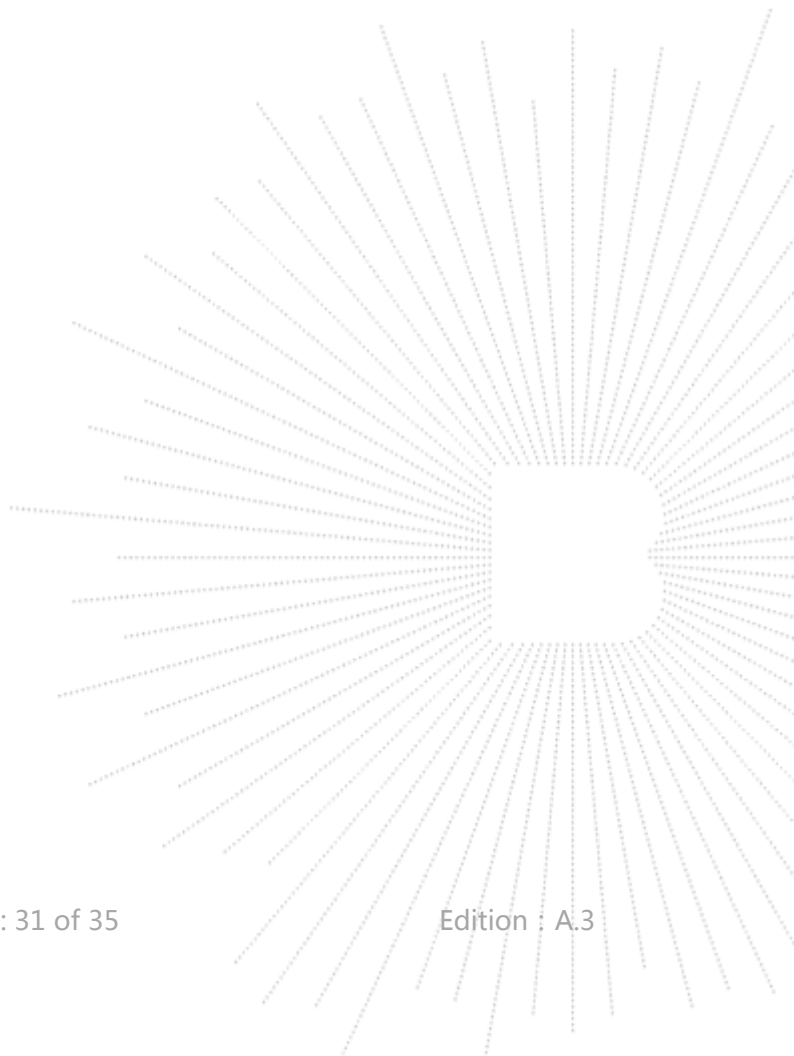

12. EUT PHOTOGRAPHS

EUT Photo 1



EUT Photo 2



13. EUT TEST SETUP PHOTOGRAPHS

Conducted emissions



Radiated Measurement Photos



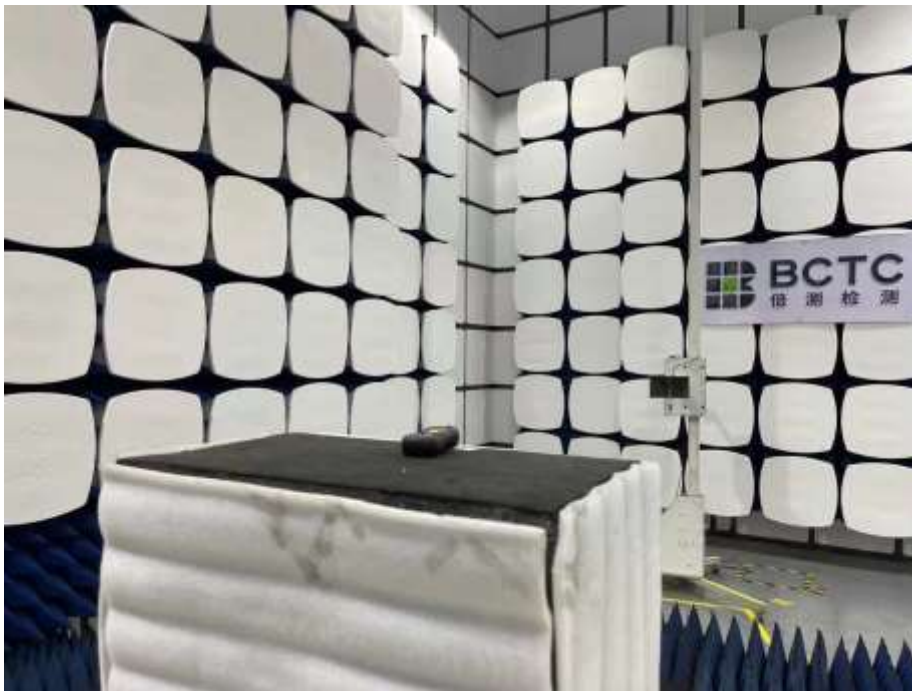

STATEMENT

- 1.The equipment lists are traceable to the national reference standards.
- 2.The test report can not be partially copied unless prior written approval is issued from our lab.
- 3.The test report is invalid without stamp of laboratory.
- 4.The test report is invalid without signature of person(s) testing and authorizing.
- 5.The test process and test result is only related to the Unit Under Test.
- 6.The quality system of our laboratory is in accordance with ISO/IEC17025.
- 7.If there is any objection to report, the client should inform issuing laboratory within 15 days from the date of receiving test report.

Address:

1-2/F., Building B, Pengzhou Industrial Park, No.158, Fuyuan 1st Road, Tangwei, Fuhai Subdistrict, Bao'an District, Shenzhen, Guangdong, China

TEL : 400-788-9558

P.C.: 518103

FAX : 0755-33229357

Website : <http://www.chnbctc.com>

E-Mail : bctc@bctc-lab.com.cn

***** END *****

