

# TEST REPORT

## FCC ID: 2AHH9-IRKET11

Applicant : Kaba Ilco Corp  
Address : 400 Jeffreys Road Rocky Mount, NC 27804 United States

### Equipment Under Test (EUT):

Name	:	REMOTE
Model	:	T-4B-HO-11

In Accordance with: FCC PART 15, SUBPART C: 2015 (Section 15.231)

Report No : T1860497 06  
Date of Test : May 10-May 30, 2016  
Date of Issue : May 30, 2016

Test Result: **PASS**

In the configuration tested, the EUT complied with the standards specified above

Authorized Signature

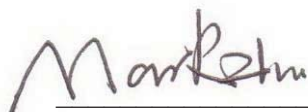

(Mark Zhu)

General Manager

The manufacture should ensure that all the products in series production are in conformity with the product sample detailed in this report. If the product in this report is used in any configuration other than that detailed in the report, the manufacturer must ensure the new system complies with all relevant standards. Any mention of Shenzhen Alpha Product Testing Co., Ltd or test done by Shenzhen Alpha Product Testing Co., Ltd Approvals in connection with, distribution or use of the product described in this report must be approved by Shenzhen Alpha Product Testing Co., Ltd Approvals in writing.

## Contents

<b>1. General Information</b> .....	<b>3</b>
1.1. Description of Device (EUT).....	3
1.2. Accessories of device (EUT).....	4
1.3. Test Lab information.....	4
<b>2. Summary of test</b> .....	<b>5</b>
2.1. Summary of test result.....	5
2.2. Assistant equipment used for test.....	5
2.3. Block Diagram.....	6
2.4. Test mode.....	6
2.5. Test Conditions.....	7
2.6. Measurement Uncertainty (95% confidence levels, k=2).....	7
2.7. Test Equipment.....	8
<b>3. Radiation Emission</b> .....	<b>9</b>
3.1. Radiation Emission Limits(15.209&231).....	9
3.2. Test Setup.....	9
3.3. Test Procedure.....	11
3.4. Test Equipment Setting For emission test.....	12
3.5. Test Condition.....	12
3.6. Test Result.....	12
<b>4. POWER LINE CONDUCTED EMISSION</b> .....	<b>15</b>
4.1. Conducted Emission Limits(15.209).....	15
4.2. Test Setup.....	15
4.3. Test Procedure.....	16
4.4. Test Results.....	16
<b>5. Occupied bandwidth</b> .....	<b>17</b>
5.1. Test limit.....	17
5.2. Method of measurement.....	17
5.3. Test Setup.....	17
5.4. Test Results.....	17
<b>6. Transmission time</b> .....	<b>19</b>
6.1. Test limit.....	19
6.2. Method of measurement.....	19
6.3. Test Setup.....	19
6.4. Test Results.....	20
<b>7. Antenna Requirement</b> .....	<b>22</b>
7.1. Standard Requirement.....	22
7.2. Antenna Connected Construction.....	22
7.3. Result.....	22
<b>8. Test setup photo</b> .....	<b>23</b>
<b>9. Photos of EUT</b> .....	<b>24</b>

## 1. General Information

### 1.1. Description of Device (EUT)

EUT : REMOTE

Model No. : T-4B-HO-11

DIFF. : N/A

Trade mark : iIco

Power supply : DC 3.3V from Button battery

Operation : 313.85MHz, 433.92MHz  
frequency

Modulation : ASK

Antenna Type : Internal antenna, max gain 0dBi.

Applicant : Kaba Ilco Corp

Address : 400 Jeffreys Road Rocky Mount, NC 27804 United States

Manufacturer : Ecartek

Address : Building #1 East Side, West Shahe Road, Chaguang Industrial Park, Xili  
Town, NanShan District, Shenzhen City, Zip:518000, China

## 1.2. Accessories of device (EUT)

Accessories : N/A

Model N/A

Input N/A

Output N/A

Accessories2 : N/A

Model N/A

## 1.3. Test Lab information

Shenzhen Alpha Product Testing Co., Ltd

Building B, East Area of Nanchang Second, Industrial Zone, Gushu 2nd Road,  
Bao'an, Shenzhen, China

March 25, 2015 File on Federal Communication Commission

Registration Number: 203110

July 18, 2014 Certificated by IC

Registration Number: 12135A

## 2. Summary of test

### 2.1. Summary of test result

Description of Test Item	Standard	Results
Spurious Emission	Section 15.231&15.209	PASS
Conduction Emission	Section 15.207	N/A
Occupied bandwidth	Section 15.231	PASS
Transmission time	Section 15.231	PASS
Band Edge	Section 15.231	N/A
Antenna Requirement	Section 15.203	PASS
Note : Test according to ANSI C63.4-2014 and ANSI C63.10-2013		

### 2.2. Assistant equipment used for test

Description	:	N/A
Manufacturer	:	N/A
Model No.	:	N/A
Remark: N/A		

### 2.3. Block Diagram

1. For radiated emissions test: EUT was placed on a turn table, which is 0.8 meter high above ground. EUT was set into test mode before test. New battery is used during all test



### 2.4. Test mode

EUT work in Continuous TX mode, and select test channel, wireless mode

Tested mode, channel, and data rate information		
Mode	Channel	Frequency (MHz)
ASK	CH1	313.85
	CH2	433.92

## 2.5. Test Conditions

Temperature range	21-25 °C
Humidity range	40-75%
Pressure range	86-106kPa

## 2.6. Measurement Uncertainty (95% confidence levels, k=2)

Item	MU	Remark
Uncertainty for Power point Conducted Emissions Test	2.42dB	
Uncertainty for Radiation Emission test in 3m chamber (below 30MHz)	2.13 dB	Polarize: V
	2.57dB	Polarize: H
Uncertainty for Radiation Emission test in 3m chamber (30MHz to 1GHz)	3.54dB	Polarize: V
	4.1dB	Polarize: H
Uncertainty for Radiation Emission test in 3m chamber (1GHz to 25GHz)	2.08dB	Polarize: H
	2.56dB	Polarize: V
Uncertainty for radio frequency	$1 \times 10^{-9}$	
Uncertainty for conducted RF Power	0.65dB	
Uncertainty for temperature	0.2 °C	
Uncertainty for humidity	1%	
Uncertainty for DC and low frequency voltages	0.06%	

## 2.7. Test Equipment

Equipment	Manufacture	Model No.	Serial No.	Last Cal.	Cal Interval
3m Semi-Anechoic	ETS-LINDGREN	N/A	SEL0017	2017.01.16	1 Year
Spectrum analyzer	Agilent	E4407B	MY49510055	2017.01.16	1 Year
Receiver	R&S	ESCI	101165	2017.01.16	1 Year
Bilog Antenna	SCHWARZBECK	VULB 9168	9168-438	2018.01.18	2 Year
Horn Antenna	SCHWARZBECK	BBHA 9120 D	BBHA 9120 D(1201)	2018.01.18	2 Year
Horn Antenna	SCHWARZBECK	BBHA 9170	BBHA 9170 D(1432)	2018.01.18	2 Year
Active Loop Antenna	Beijing Daze	ZN30900A	SEL0097	2017.01.16	1 Year
Cable	Resenberger	SUCOFLEX 104	MY6562/4	2017.01.16	1 Year
Cable	Resenberger	SUCOFLEX 104	309972/4	2017.01.16	1 Year
Cable	Resenberger	SUCOFLEX 104	329112/4	2017.01.16	1 Year
Power Meter	Anritsu	ML2487A	6K00001491	2017.01.16	1 Year
Power sensor	Anritsu	ML2491A	32516	2017.01.16	1 Year
Pre-amplifier	SCHWARZBECK	BBV9743	9743-019	2017.01.16	1 Year
Pre-amplifier	Quietek	AP-180C	CHM-0602012	2017.01.16	1 Year



### 3. Radiation Emission

#### 3.1. Radiation Emission Limits(15.209&231)

Frequency (MHz)	Field Strength Limits at 3 metres (watts, e.i.r.p.)		
	uV/m	dB uV/m	Measurement distance(m)
0.009-0.490	2400/F(kHz)	XX	300
0.490-1.705	24000/F(kHz)	XX	30
1.705-30	30	29.5	30
30~88	100(3nW)	40	3
88~216	150(6.8nW)	43.5	3
216~960	200(12nW)	46	3
Above960	500(75nW)	54	3
Carrier frequency		80.8(AV)	3
Carrier frequency		100.8(PK)	3

**NOTE:**

- a) The tighter limit applies at the band edges.
- b) Emission Level(dB uV/m)=20log Emission Level(Uv/m)

#### 3.2. Test Setup

See the next page.

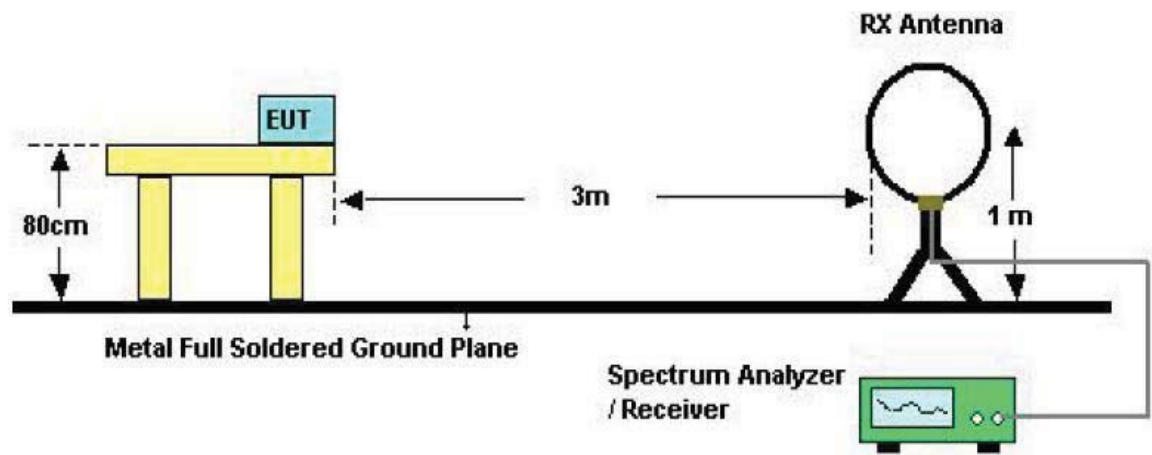

Below 30MHz Test Setup

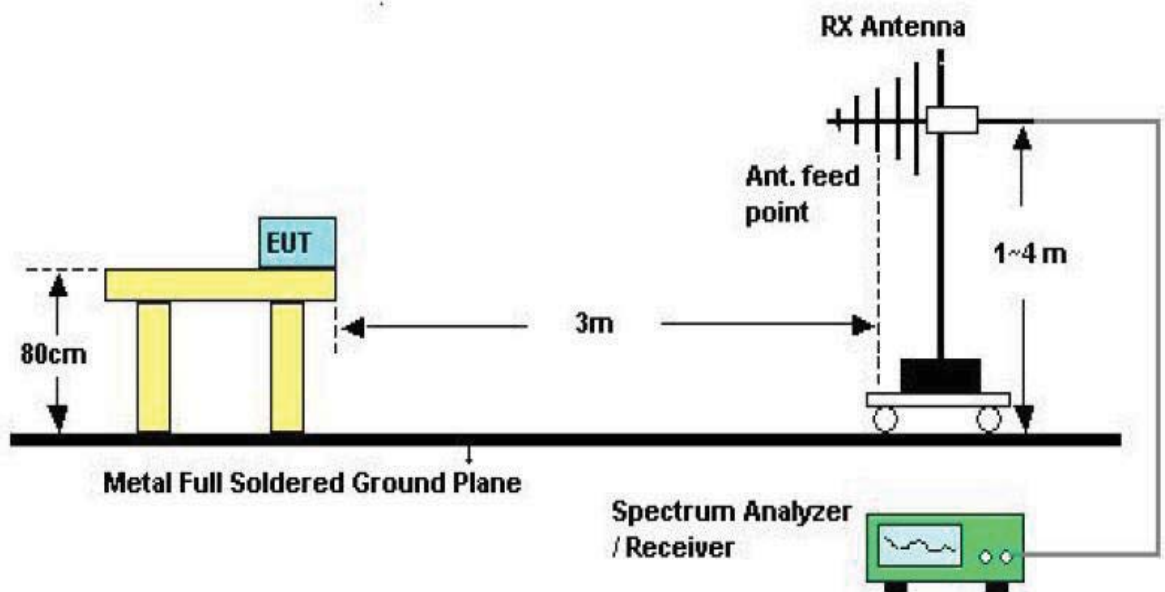

Above 30MHz Test Setup

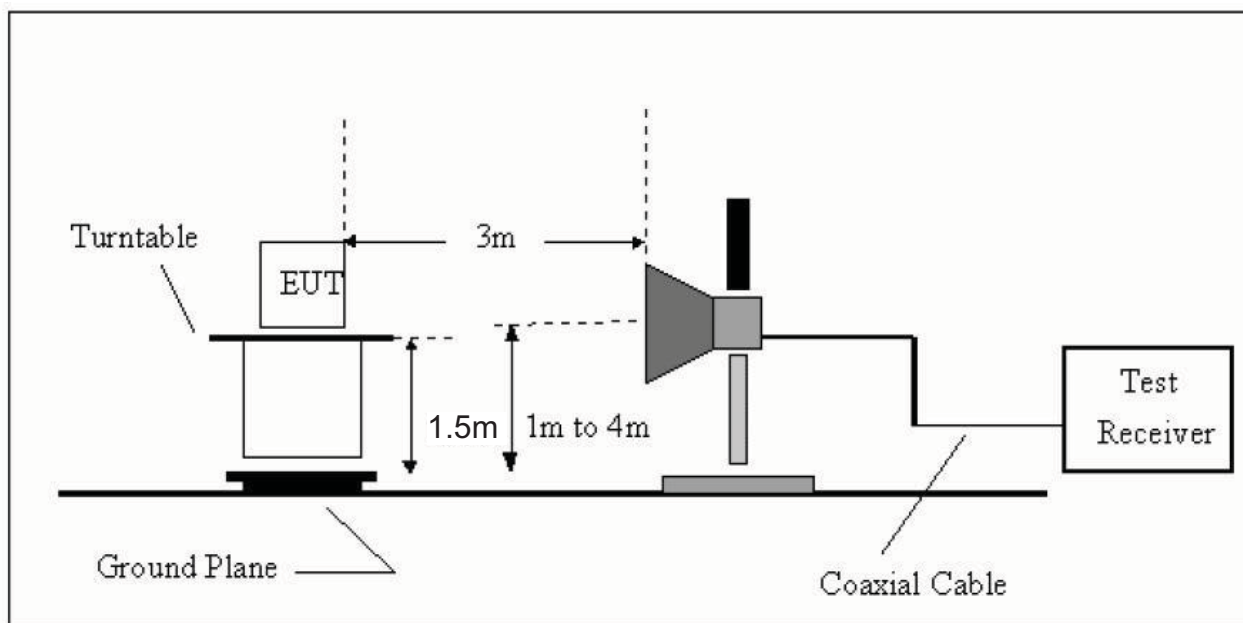

Above 1GHz Test Setup

### 3.3. Test Procedure

- a) The measuring distance of 3m shall be used for measurements at frequency up to 1GHz and above 1GHz, The EUT was placed on a rotating 0.8 m high above ground, The table was rotated 360 degrees to determine the position of the highest radiation
- b) The Test antenna shall vary between 1m and 4m, Both Horizontal and Vertical antenna are set to make measurement.
- c) The initial step in collecting conducted emission data is a spectrum analyzer Peak detector mode pre-scanning the measurement frequency range. Significant Peaks are then marked. and then Quasi Peak Detector mode remeasured
- d) If Peak value comply with QP limit Below 1GHz. The EUT deemed to comply with QP limit. But the Peak value and average value both need to comply with applicable limit above 1GHz.
- e) For the actual test configuration, please see the test setup photo.

### 3.4. Test Equipment Setting For emission test.

9KHz~150KHz	RBW 200Hz	VBW1KHz
150KHz~30MHz	RBW 9KHz	VBW 30KHz
30MHz~1GHz	RBW 120KHz	VBW 300KHz
Above 1GHz	RBW 1MHz	VBW 3MHz

### 3.5. Test Condition

Continual Transmitting in maximum power(The new battery be used during Test)

### 3.6. Test Result

We have scanned the 10th harmonic from 9KHz to the EUT.  
Detailed information please see the following page.

From 9KHz to 30MHz: Conclusion: **PASS**

Note: The amplitude of spurious emissions which are attenuated by more than 20dB below the permissible value has no need to be reported.

**Notes:** 1 --Means other frequency and mode comply with standard requirements and at least have 20dB margin.

Correct Factor=Cable Loss+Antenna Factor-Amplifier Gain

Measurement Result=Reading + Correct Factor

Margin=Measurement Result-Limit

2 –Spectrum setting:

a. Peak setting 30MHz-1GHz, RBW=100KHz, VBW=300KHz.

3- PK measure result values is less than the AVG limit values, so AV measure result values test not applicable.

## Radiated Emissions Result of Inside band

<b>EUT</b>	REMOTE		<b>Model Name</b>	T-4B-HO-11						
<b>Temperature</b>	25°C		<b>Relative Humidity</b>	56%						
<b>Pressure</b>	960hPa		<b>Test voltage</b>	DC 3.3V from Button battery						
<b>Test Mode</b>	TX CH1		<b>Test by</b>	Eric						
<b>Channel (313.85MHz Below 1GHz)</b>										
Fre. MHz	Plority H/V	Reading dBuV	Antenna Factor dB	Cable Loss dB	Amplifier Gain dB	Correct Factor dB	Measure Result dBuV/m	Limit dBuV/m	Margin dB	Remark
313.85	H	77.78	13.19	0.67	27.22	-13.36	64.42	75.6	-11.18	Peak
627.7	H	58.29	18.85	0.67	27.22	-7.70	50.59	55.6	-5.01	Peak
941.55	H	57.98	22.09	0.67	27.22	-4.46	53.52	55.6	-2.08	Peak
313.85	V	84.3	13.19	0.67	27.22	-13.36	70.94	75.6	-4.66	Peak
627.7	V	55.1	18.85	0.67	27.22	-7.70	47.4	55.6	-8.20	Peak
941.55	V	57.92	22.09	0.67	27.22	-4.46	53.46	55.6	-2.14	Peak

<b>EUT</b>	REMOTE		<b>Model Name</b>	T-4B-HO-11						
<b>Temperature</b>	25°C		<b>Relative Humidity</b>	56%						
<b>Pressure</b>	960hPa		<b>Test voltage</b>	DC 3.3V from Button battery						
<b>Test Mode</b>	TX CH1		<b>Test by</b>	Eric						
<b>Channel (313.85MHz Above 1GHz)</b>										
Freq. (MHz)	Ant. Pol H/V	Peak Reading (dBuV)	AV Reading (dBuV)	Ant. / CL CF (dB)	Actual Fs	Peak Limit (dBuV/m)	Margin (dB)	Remark		
					Peak (dBuV/m)					
1255.4	V	53.07	---	-10.67	42.57	74	-31.43	Peak		
--	V	--	---	--	--	--	--	--		
1255.4	H	50.37	---	-10.67	39.52	74	-34.48	Peak		
--	H	--	---	--	--	--	--	--		

<b>EUT</b>	REMOTE		<b>Model Name</b>	T-4B-HO-11					
<b>Temperature</b>	25°C		<b>Relative Humidity</b>	56%					
<b>Pressure</b>	960hPa		<b>Test voltage</b>	DC 3.3V from Button battery					
<b>Test Mode</b>	TX CH2		<b>Test by</b>	Eric					
<b>Channel (433.92MHz Below 1GHz)</b>									
Fre. MHz	Plority H/V	Reading dBuV	Antenna Factor dB	Cable Loss dB	Amplifier Gain dB	Correct Factor dB	Measure Result dBuV/m	Limit dBuV/m	Remark
433.92	H	74.2	15.58	0.67	27.22	-10.97	63.23	80.8	Peak
867.84	H	53.35	21.26	0.67	27.22	-5.29	48.06	60.8	Peak
433.92	V	85.31	15.58	0.67	27.22	-10.97	74.34	80.8	Peak
867.84	V	55.88	21.26	0.67	27.22	-5.29	50.59	60.8	Peak

<b>EUT</b>	REMOTE		<b>Model Name</b>	T-4B-HO-11					
<b>Temperature</b>	25°C		<b>Relative Humidity</b>	56%					
<b>Pressure</b>	960hPa		<b>Test voltage</b>	DC 3.3V from Button battery					
<b>Test Mode</b>	TX CH2		<b>Test by</b>	Eric					
<b>Channel (433.92MHz Above 1GHz)</b>									
Freq. (MHz)	Ant. Pol H/V	Peak Reading (dBuV)	AV Reading (dBuV)	Ant. / CL CF (dB)	Actual Fs	Peak Limit (dBuV/m)	Margin (dB)	Remark	
					Peak (dBuV/m)				
1301.76	V	56.45	---	-10.41	45.81	74.00	-28.19	Peak	
--	V	--	---	--	--	--	--	--	
1301.76	H	53.71	---	-10.41	43.07	74.00	-30.93	Peak	
--	H	--	---	--	--	--	--	--	

## 4. POWER LINE CONDUCTED EMISSION

### 4.1. Conducted Emission Limits (15.209)

Frequency MHz	Limits dB( $\mu$ V)	
	Quasi-peak Level	Average Level
0.15 -0.50	66 -56*	56 - 46*
0.50 -5.00	56	46
5.00 -30.00	60	50

Notes: 1. \*Decreasing linearly with logarithm of frequency.

2. The lower limit shall apply at the transition frequencies.

3. The limit decreases in line with the logarithm of the frequency in the rang of 0.15 to 0.50 MHz.

### 4.2. Test Setup

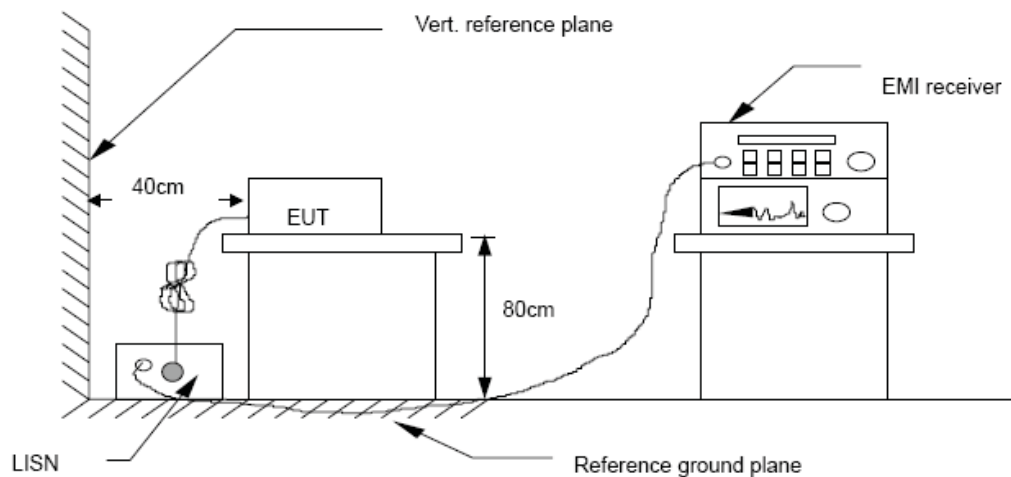

### 4.3. Test Procedure

The EUT is put on the plane 0.8m high above the ground by insulating support and is connected to the power mains through a line impedance stabilization network (L.I.S.N.). This provides a 50ohm coupling impedance for the EUT system. Please refer the block diagram of the test setup and photographs. Both sides of AC lines are checked to find out the maximum conducted emission. In order to find the maximum emission levels, the relative positions of equipment and all of the interface cables shall be changed according to ANSI C63.4-2014 on Conducted Emission Measurement.

The bandwidth of test receiver (R & S ESCS30) is set at 9 kHz.

### 4.4. Test Results

EUT power supply by battery, so the test not applicable.



## 5. Occupied bandwidth

### 5.1. Test limit

Please refer section 15.231

According to §15.231(C), The bandwidth of the emission shall be no wider than 0.25% of the center frequency for devices operating above 70MHz and below 900MHz.

### 5.2. Method of measurement

a) The bandwidth is measured at an amplitude level reduced 20dB from the reference level. The reference level is the level of the highest amplitude signal observed from the transmitter at the fundamental frequency. Once the reference level is established, the equipment is conditioned with typical modulating signal to produce the worst-case (i.e. the widest) bandwidth.

b) The test receiver RBW set 30KHz, VBW set 30KHz, Sweep time set auto.

### 5.3. Test Setup



### 5.4. Test Results

EUT: REMOTE				
M/N: T-4B-HO-11				
Test Mode: Keeping TX mode				
Test date: 2016-05-24		Test site: RF site	Tested by: Eric	
Mode	Freq (MHz)	20dB Bandwidth (KHz)	Limit (kHz)	Conclusion
ASK	313.85	122.8	784.6	PASS
	433.92	140.0	1084.8	PASS

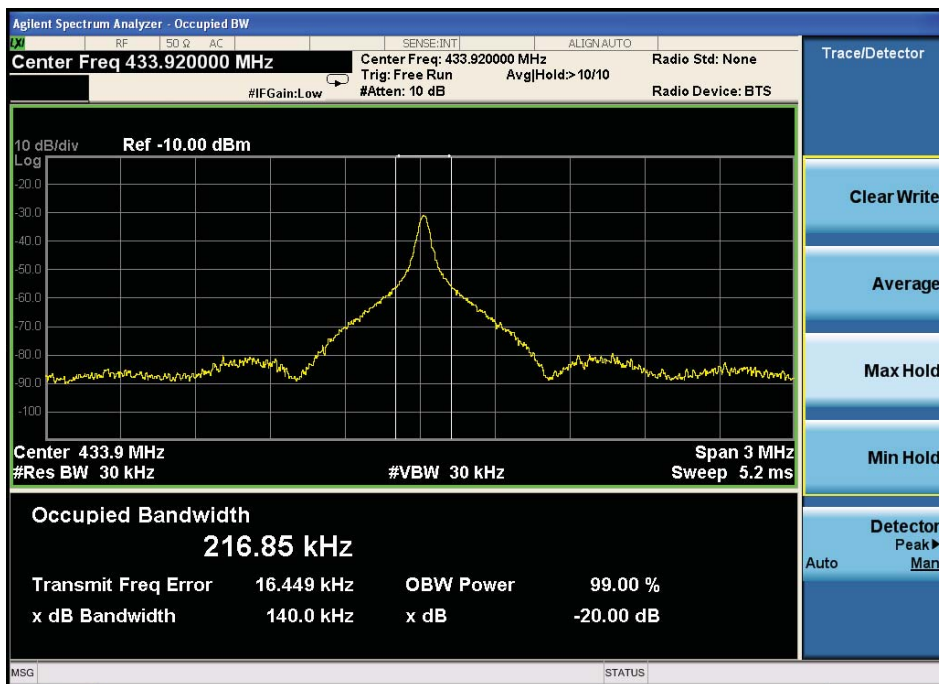
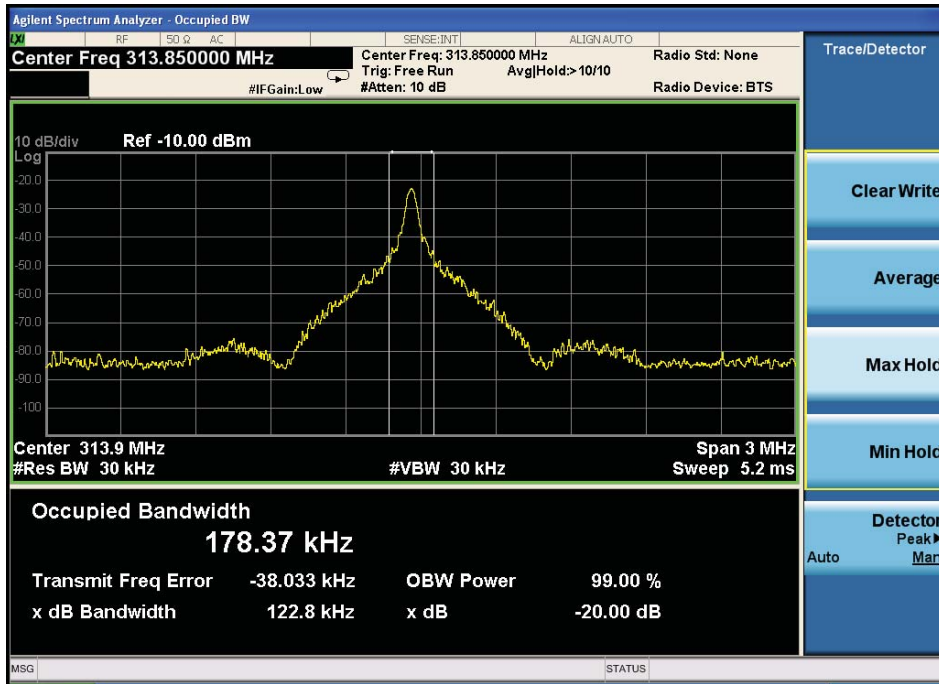

## 6. Transmission time

### 6.1. Test limit

Please refer section 15.231

According to §15.231(a)(1), A manually operated transmitter shall employ a switch that will automatically deactivate the transmitter within not more than 5 seconds of being released.

### 6.2. Method of measurement

6.2.1. Place the EUT on the table and set it in transmitting mode.

6.2.2. Remove the antenna from the EUT and then connect a low loss RF cable from the antenna port to the spectrum analyzer.

6.2.3. Set spectrum analyzer Center=313.85MHz, 433.92MHz, Span = 0MHz, Sweep = 5s.

6.2.4. Set the spectrum analyzer as RBW, VBW=1MHz,

6.2.5. Max hold, view and count how many channel in the band.

### 6.3. Test Setup



### 6.4. Test Results

EUT: REMOTE			
M/N: T-4B-HO-11			
Test Mode: Keeping TX mode			
Test date: 2016-05-24	Test site: RF site	Tested by: Eric	
Freq (MHz)	Test Result(s)	Limit (s)	Conclusion
313.85	1.09	< 5s	PASS
433.92	1.09	< 5s	PASS

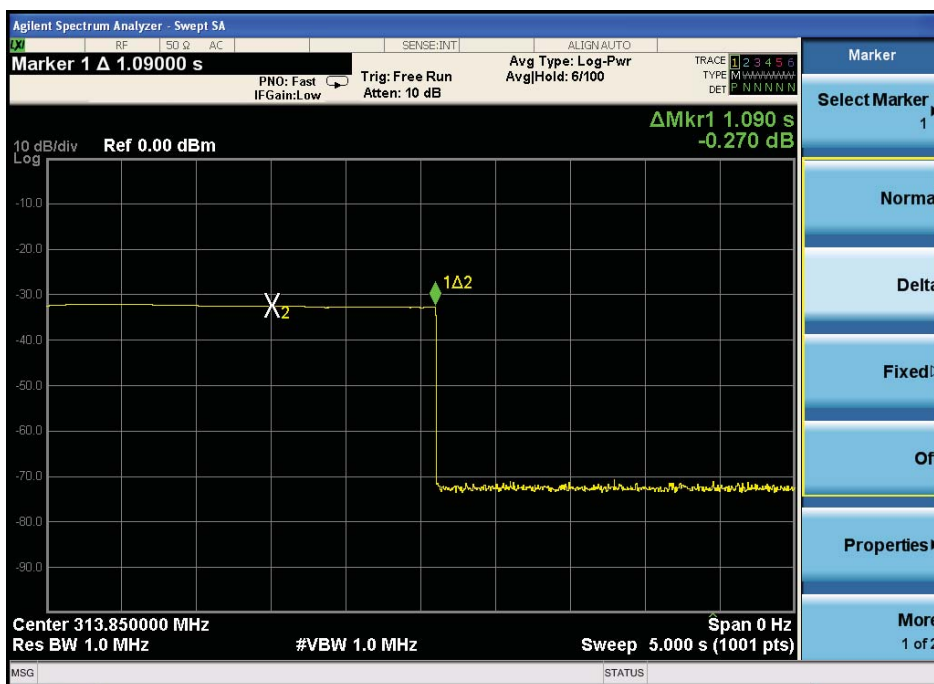



## **7. Antenna Requirement**

### 7.1. Standard Requirement

An intentional radiator shall be designed to ensure that no antenna other than that furnished by the responsible party shall be used with the device. The use of a permanently attached antenna or of an antenna that uses a unique coupling to the intentional radiator shall be considered sufficient to comply with the provisions of this Section. The manufacturer may design the unit so that a broken antenna can be replaced by the user, but the use of a standard antenna jack or electrical connector is prohibited.

### 7.2. Antenna Connected Construction

The directional gains of antenna used for transmitting is 0 dBi, and the antenna connector is designed with permanent attachment and no consideration of replacement. Please see EUT photo for details.

### 7.3. Result

The EUT antenna is PCB antenna. It comply with the standard requirement.

## 8. Test setup photo

Photos of Radiated emission



### 9. Photos of EUT











-----END OF THE REPORT-----