



FCC TEST REPORT

FCC ID: 2AHH9-FLP3A

On Behalf of

Kaba Ilco Corp

Remote Key

Model No.: PRX-FORD-5B2

Prepared for : Kaba Ilco Corp
Address : 400 Jeffreys Road, Rocky Mount, NC 27804, United States

Prepared By : Shenzhen Alpha Product Testing Co., Ltd.
Address : Building i, No.2, Lixin Road, Fuyong Street, Bao'an District, 518103,
Shenzhen, Guangdong, China

Report Number : T1881863 01
Date of Receipt : December 1, 2018
Date of Test : December 1-14, 2018
Date of Report : December 17, 2018
Version Number : REV0

Contents

| | |
|--|-----------|
| 1. General Information..... | 5 |
| 1.1. Description of Device (EUT)..... | 5 |
| 1.2. Accessories of Device (EUT)..... | 6 |
| 1.3. Tested Supporting System Details | 6 |
| 1.4. Test Facility..... | 6 |
| 2. Summary of test | 7 |
| 2.1. Summary of test result | 7 |
| 2.2. Block Diagram | 8 |
| 2.3. Test mode | 8 |
| 2.4. Test Conditions..... | 8 |
| 2.5. Measurement Uncertainty (95% confidence levels, k=2)..... | 8 |
| 2.6. Test Equipment..... | 9 |
| 3. Radiation Emission | 10 |
| 3.1. Radiation Emission Limits(15.209&231) | 10 |
| 3.2. Test Setup | 10 |
| 3.3. Test Procedure | 12 |
| 3.4. Test Equipment Setting For emission test..... | 12 |
| 3.5. Test Condition | 12 |
| 3.6. Test Result..... | 12 |
| 4. POWER LINE CONDUCTED EMISSION | 17 |
| 4.1. Conducted Emission Limits (15.209) | 17 |
| 4.2. Test Setup | 17 |
| 4.3. Test Procedure | 18 |
| 4.4. Test Results | 18 |
| 5. Occupied bandwidth..... | 19 |
| 5.1. Test limit..... | 19 |
| 5.2. Method of measurement..... | 19 |
| 5.3. Test Setup | 19 |
| 5.4. Test Results | 19 |
| 6. Transmission time..... | 21 |
| 6.1. Test limit..... | 21 |
| 6.2. Method of measurement..... | 21 |
| 6.3. Test Setup | 21 |
| 6.4. Test Results | 22 |
| 7. Antenna Requirement | 23 |
| 7.1. Standard Requirement | 23 |
| 7.2. Antenna Connected Construction | 23 |
| 7.3. Result..... | 23 |
| 8. Test setup photo | 24 |
| 9. Photos of EUT | 25 |

TEST REPORT DECLARATION

Applicant : Kaba Ilco Corp
 Address : 400 Jeffreys Road, Rocky Mount, NC 27804, United States
 Manufacturer : Qinuo Electronics Co., Ltd
 Address : 3/F, Bldg.A, Yucheng Base, Keji Rd., High-tech Industrial Park, Fengze, Quanzhou, Fujian 362000, P.R. China
 EUT Description : Remote Key
 (A) Model No. : PRX-FORD-5B2
 (B) Trademark : N/A

Measurement Standard Used:

FCC Rules and Regulations Part 15 Subpart C Section 15.231: 2017
ANSI C63.10-2013

The device described above is tested by Shenzhen Alpha Product Testing Co., Ltd. to determine the maximum emission levels emanating from the device. The maximum emission levels are compared to the FCC Part 15 Subpart C limits both conducted and radiated emissions. The test results are contained in this test report and Shenzhen Alpha Product Testing Co., Ltd. is assumed of full responsibility for the accuracy and completeness of these tests.

After the test, our opinion is that EUT compliance with the requirement of the above standards.

This report applies to above tested sample only. This report shall not be reproduced in parts without written approval of Shenzhen Alpha Product Testing Co., Ltd.

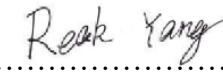
Tested by (name + signature).....: Reak Yang 
 Project Engineer

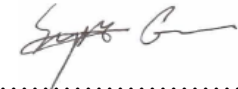
Approved by (name + signature).....: Simple Guan 
 Project Manager

Date of issue.....: December 17, 2018

Revision History

| Revision | Issue Date | Revisions | Revised By |
|----------|-------------------|------------------------|-------------|
| 00 | December 17, 2018 | Initial released Issue | Simple Guan |

1. General Information

1.1. Description of Device (EUT)

| | |
|---------------------|--|
| EUT | : Remote Key |
| Model No. | : PRX-FORD-5B2 |
| DIFF. | : N/A |
| Trade mark | : N/A |
| Power supply | : DC 3V by button cell |
| Operation frequency | : 315MHz |
| Modulation | : ASK |
| Antenna Type | : Internal Antenna, Maximum Gain is 0dBi |
| Software version | : V1.0 |
| Hardware version | : V1.0 |

1.2. Accessories of Device (EUT)

Accessories1 : /
Manufacturer : /
Model : /
Power supply : /

1.3. Tested Supporting System Details

| No. | Description | Manufacturer | Model | Serial Number | Certification or DOC |
|-----|-------------|--------------|-------|---------------|----------------------|
| / | / | / | / | / | / |

1.4. Test Facility

Shenzhen Alpha Product Testing Co., Ltd
Building i, No.2, Lixin Road, Fuyong Street, Bao'an District, 518103,
Shenzhen, Guangdong, China

June 21, 2018 File on Federal Communication Commission
Registration Number: 293961
July 25, 2017 Certificated by IC
Registration Number: 12135A

2. Summary of test

2.1. Summary of test result

| Description of Test Item | Standard | Results |
|---|-----------------------|----------------|
| Spurious Emission | Section 15.231&15.209 | PASS |
| Conduction Emission | Section 15.207 | N/A |
| Occupied bandwidth | Section 15.231 | PASS |
| Transmission time | Section 15.231 | PASS |
| Band Edge | Section 15.231 | N/A |
| Antenna Requirement | Section 15.203 | PASS |
| Note : Test according to ANSI C63.10-2013 | | |

2.2. Block Diagram

1. For radiated emissions test: EUT was placed on a turn table, which is 0.8 meters high above ground for below 1 GHz test and 1.5 meters high above ground for below 1 GHz test . EUT was set into test mode before test. New battery is used during all test



2.3. Test mode

EUT work in Continuous TX mode, and select test channel, wireless mode

| Tested mode, channel, and data rate information | | |
|---|---------|-----------------|
| Mode | Channel | Frequency (MHz) |
| ASK | CH1 | 315 |

2.4. Test Conditions

| | |
|-------------------|-----------|
| Temperature range | 21-25°C |
| Humidity range | 40-75% |
| Pressure range | 86-106kPa |

2.5. Measurement Uncertainty (95% confidence levels, k=2)

| Item | Uncertainty |
|---|----------------------|
| Uncertainty for Power point Conducted Emissions Test | 2.74dB |
| Uncertainty for Radiation Emission test in 3m chamber (below 30MHz) | 2.13 dB(Polarize: V) |
| | 2.57dB(Polarize: H) |
| Uncertainty for Radiation Emission test in 3m chamber (30MHz to 1GHz) | 3.77dB(Polarize: V) |
| | 3.80dB(Polarize: H) |
| Uncertainty for Radiation Emission test in 3m chamber (1GHz to 25GHz) | 4.16dB(Polarize: H) |
| | 4.13dB(Polarize: V) |
| Uncertainty for radio frequency | 5.4×10^{-8} |
| Uncertainty for conducted RF Power | 0.37dB |
| Uncertainty for temperature | 0.2°C |
| Uncertainty for humidity | 1% |
| Uncertainty for DC and low frequency voltages | 0.06% |

2.6. Test Equipment

| Equipment | Manufacture | Model No. | Serial No. | Last cal. | Cal Interval |
|---------------------------|------------------|-----------------------------|-------------------|------------|--------------|
| 3m Semi-Anechoic | ETS-LINDGRE N | N/A | SEL0017 | 2018.09.21 | 1Year |
| Spectrum analyzer | Agilent | E4407B | MY46185649 | 2018.09.21 | 1Year |
| Receiver | R&S | ESCI | 1166.5950K03-1011 | 2018.09.21 | 1Year |
| Receiver | R&S | ESCI | 101202 | 2018.09.21 | 1Year |
| Bilog Antenna | Schwarzbeck | VULB 9168 | VULB9168-438 | 2018.04.13 | 2Year |
| Horn Antenna | EMCO | 3115 | 640201028-06 | 2018.04.13 | 2Year |
| Active Loop Antenna | Beijing Daze | ZN30900A | SEL0097 | 2018.04.13 | 2Year |
| Cable | Resenberger | N/A | No.1 | 2018.09.21 | 1Year |
| Cable | SCHWARZBEC K | N/A | No.2 | 2018.09.21 | 1Year |
| Cable | SCHWARZBEC K | N/A | No.3 | 2018.09.21 | 1Year |
| Pre-amplifier | Schwarzbeck | BBV9743 | 9743-019 | 2018.09.21 | 1Year |
| Pre-amplifier | R&S | AFS33-18002650- 30-8P-44 | SEL0080 | 2018.09.21 | 1Year |
| Temperature controller | Terchy | MHQ | 120 | 2018.09.21 | 1Year |
| 20db Attenuator | ICPROBING | IATS1 | 82347 | 2018.09.21 | 1 Year |
| Horn Antenna | SCHWARZBEC K | BBHA 9170 | BBHA 9170294 | 2018.04.13 | 2 Year |
| Power Meter | Anritsu | ML2487A | 6K00001491 | 2018.09.21 | 1 Year |

3. Radiation Emission

3.1. Radiation Emission Limits(15.209&231)

| Frequency (MHz) | Field Strength Limits at 3 metres (watts, e.i.r.p.) | | |
|----------------------|--|----------|----------------------------|
| | uV/m | dB uV/m | Measurement distance(m) |
| 0.009-0.490 | 2400/F(kHz) | XX | 300 |
| 0.490-1.705 | 24000/F(kHz) | XX | 30 |
| 1.705-30 | 30 | 29.5 | 30 |
| 30~88 | 100(3nW) | 40 | 3 |
| 88~216 | 150(6.8nW) | 43.5 | 3 |
| 216~960 | 200(12nW) | 46 | 3 |
| Above960 | 500(75nW) | 54 | 3 |
| Carrier frequency | | 75.6(AV) | 3 |
| Carrier frequency | | 95.6(PK) | 3 |

NOTE:

- a) The tighter limit applies at the band edges.
- b) Emission Level(dB uV/m)=20log Emission Level(Uv/m)

3.2. Test Setup

See the next page.

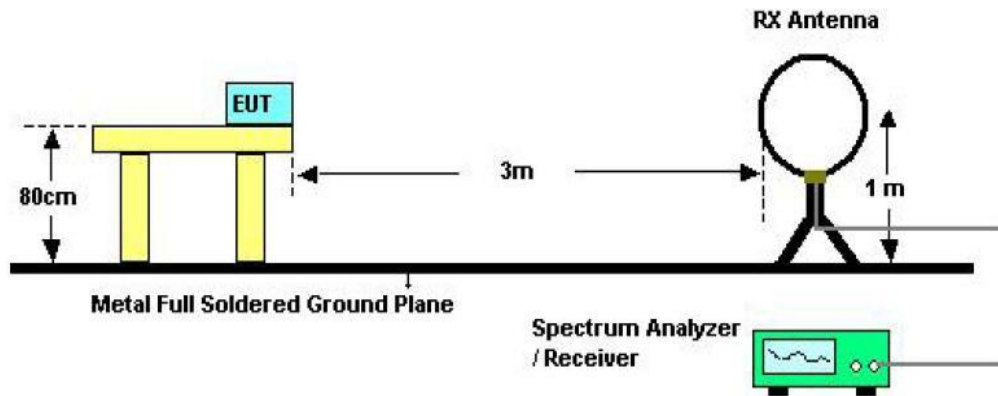

Below 30MHz Test Setup

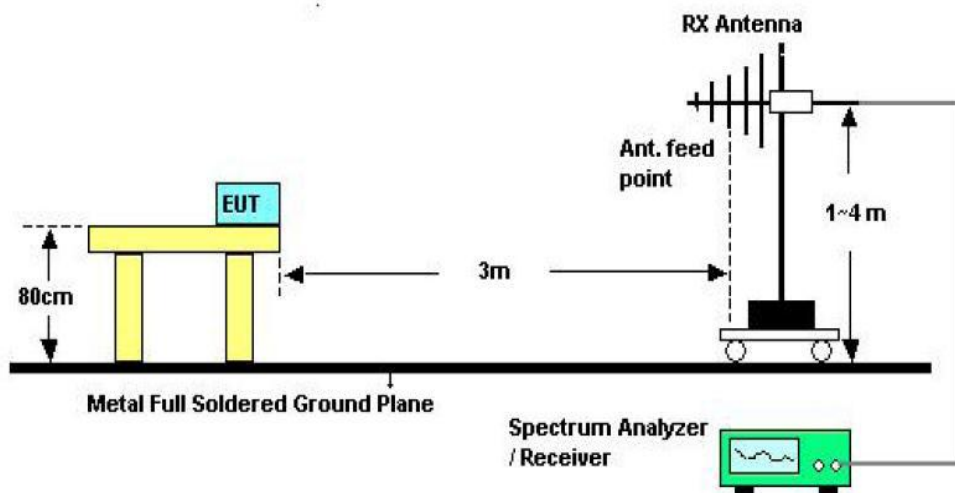

Above 30MHz Test Setup

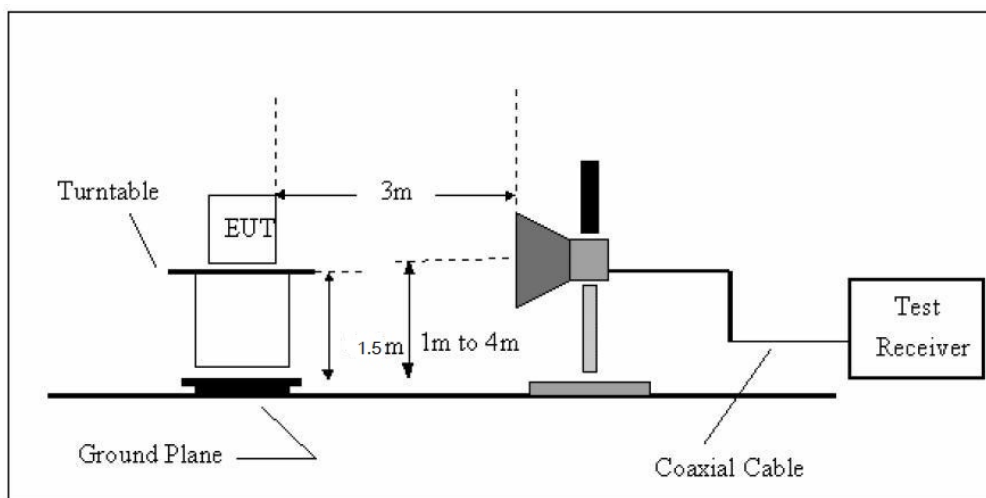

Above 1GHz Test Setup

3.3. Test Procedure

- a) The measuring distance of 3m shall be used for measurements at frequency up to 1GHz and above 1GHz, The EUT was placed on a rotating 0.8 m high above ground, The table was rotated 360 degrees to determine the position of the highest radiation
- b) The Test antenna shall vary between 1m and 4m, Both Horizontal and Vertical antenna are set to make measurement.
- c) The initial step in collecting conducted emission data is a spectrum analyzer Peak detector mode pre-scanning the measurement frequency range. Significant Peaks are then marked. and then Quasi Peak Detector mode re-measured
- d) If Peak value comply with QP limit Below 1GHz. The EUT deemed to comply with QP limit. But the Peak value and average value both need to comply with applicable limit above 1GHz.
- e) For the actual test configuration, please see the test setup photo.

3.4. Test Equipment Setting For emission test.

| | | |
|--------------|------------|------------|
| 9KHz~150KHz | RBW 200Hz | VBW 1KHz |
| 150KHz~30MHz | RBW 9KHz | VBW 30KHz |
| 30MHz~1GHz | RBW 120KHz | VBW 300KHz |
| Above 1GHz | RBW 1MHz | VBW 3MHz |

3.5. Test Condition

Continual Transmitting in maximum power (The new battery be used during Test)

3.6. Test Result

We have scanned the 10th harmonic from 9KHz to the EUT.
Detailed information please see the following page.

From 9KHz to 30MHz: Conclusion: PASS

Note: The amplitude of spurious emissions which are attenuated by more than 20dB below the permissible value has no need to be reported.

Notes: 1 --Means other frequency and mode comply with standard requirements and at least have 20dB margin.

Correct Factor=Cable Loss+Antenna Factor-Amplifier Gain

Measurement Result=Reading + Correct Factor

Margin=Measurement Result-Limit

2 –Spectrum setting:

a. Peak setting 30MHz-1GHz, RBW=100KHz, VBW=300KHz.

3- PK measure result values is less than the AVG limit values, so AV measure result values test not applicable.

Radiated Emissions Result of Inside band

| | | | |
|--------------------|------------|--------------------------|----------------------|
| EUT | Remote Key | Model Name | PRX-FORD-5B2 |
| Temperature | 25°C | Relative Humidity | 56% |
| Pressure | 960hPa | Test voltage | DC 3V by button cell |
| Test Mode | TX 315MHz | Test by | Reak |

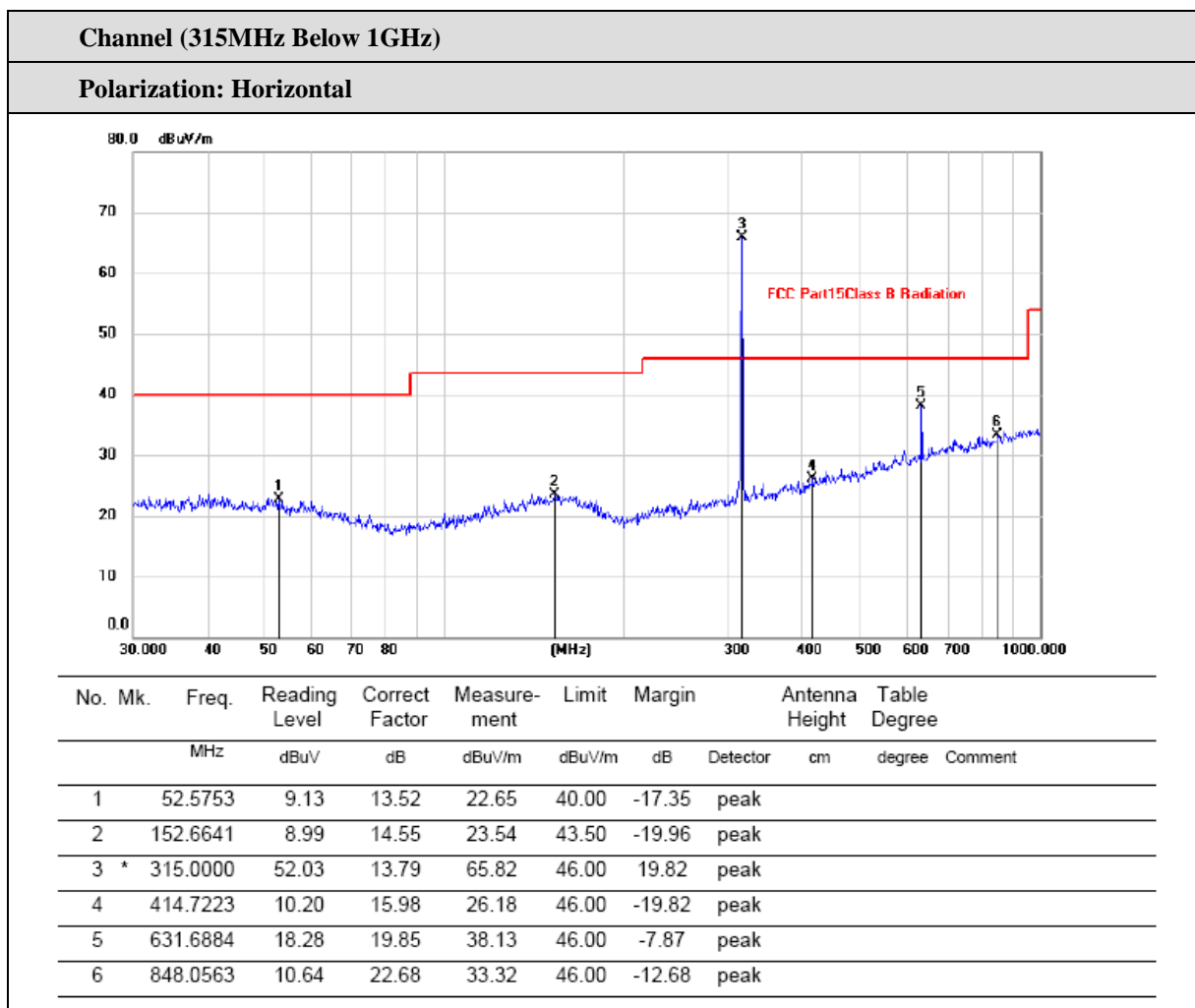

| No. | Frequency (MHz) | Reading (dBuV) | Factor (dB) | Results (dBuV/m) | Limit (dBuV/m) | Margin (dB) | Detector |
|-----|-----------------|----------------|-------------|------------------|----------------|-------------|----------|
| 1 | 315 | 52.03 | 13.79 | 65.82 | 95.62 | -29.8 | PK |
| 2 | 315 | / | / | / | 75.62 | / | AV |

Remark:

1. All readings are Quasi-Peak and Average values.
2. Margin = Result (Result = Reading + Factor) – Limit
3. When peak value applied to AVG limit, the AVG value is not calculated.

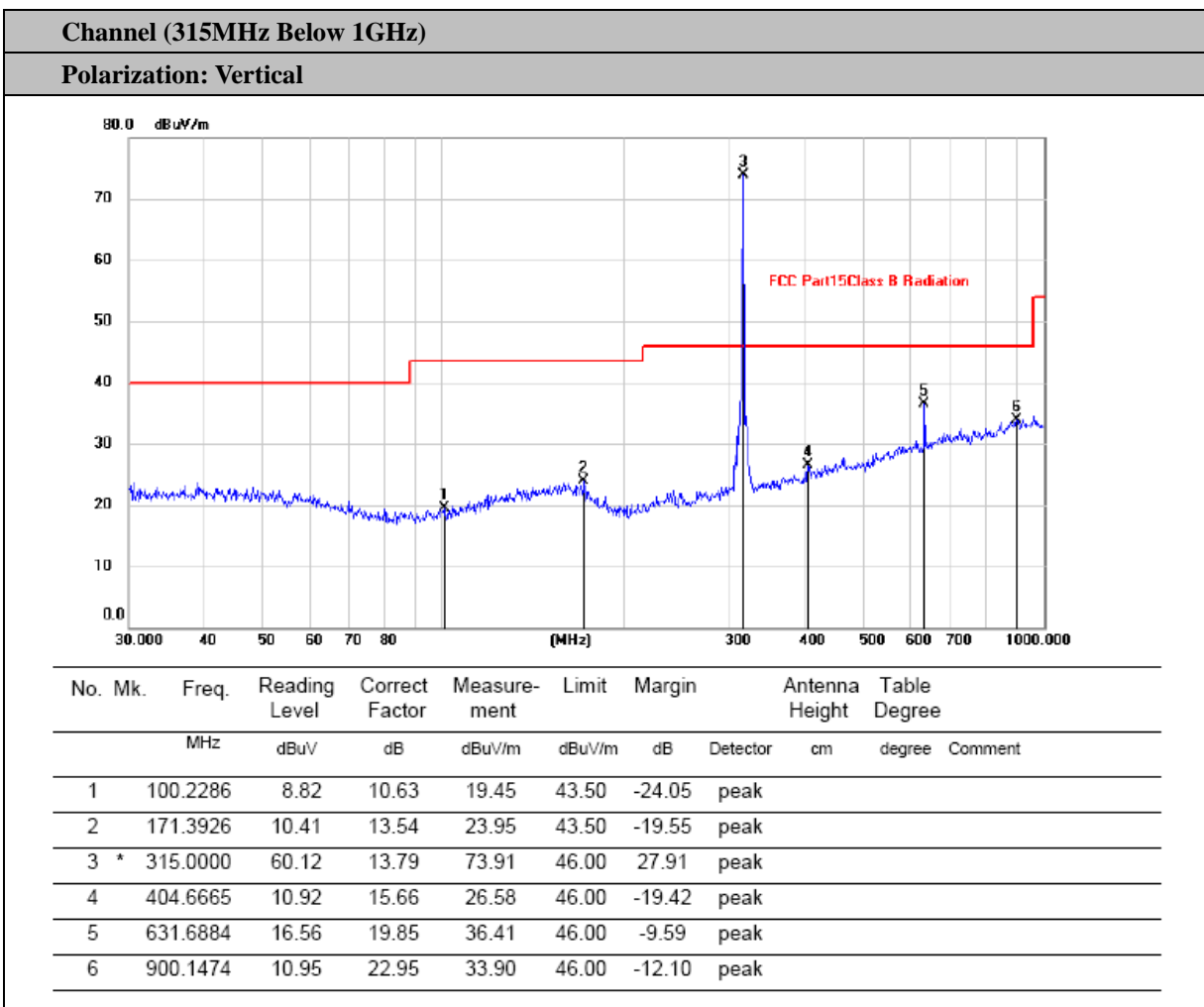

| No. | Frequency (MHz) | Reading (dBuV) | Factor (dB) | Results (dBuV/m) | Limit (dBuV/m) | Margin (dB) | Detector |
|-----|-----------------|----------------|-------------|------------------|----------------|-------------|----------|
| 1 | 315 | 60.12 | 13.79 | 73.91 | 95.62 | -21.71 | PK |
| 2 | 315 | / | / | / | 75.62 | / | AV |

Remark:

1. All readings are Quasi-Peak and Average values.
2. Margin = Result (Result = Reading + Factor) – Limi
3. When peak value applied to AVG limit, the AVG value is not calculated.

Channel (315MHz Above 1GHz)

Polarization: Horizontal

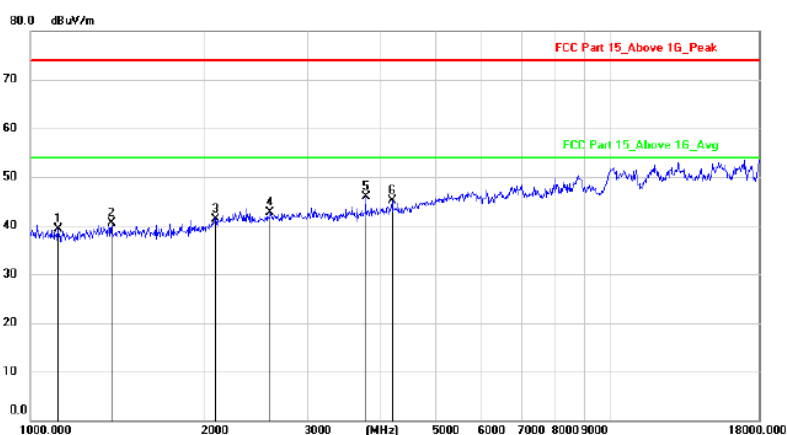

| No. | Mk. | Freq. | Reading Level | Correct Factor | Measurement | Limit | Margin | Antenna Height | Table Degree | |
|-----|-----|----------|---------------|----------------|-------------|--------|--------|----------------|--------------|---------|
| | | MHz | dBuV | dB | dBuV/m | dBuV/m | dB | cm | degree | Comment |
| 1 | | 1116.093 | 47.82 | -8.52 | 39.30 | 74.00 | -34.70 | | | peak |
| 2 | | 1378.273 | 47.58 | -7.07 | 40.51 | 74.00 | -33.49 | | | peak |
| 3 | | 2083.719 | 45.73 | -4.33 | 41.40 | 74.00 | -32.60 | | | peak |
| 4 | | 2588.122 | 45.86 | -3.16 | 42.70 | 74.00 | -31.30 | | | peak |
| 5 | * | 3779.422 | 51.78 | -5.78 | 46.00 | 74.00 | -28.00 | | | peak |
| 6 | | 4193.872 | 49.79 | -4.62 | 45.17 | 74.00 | -28.83 | | | peak |

Channel (315MHz Above 1GHz)

Polarization: Vertical

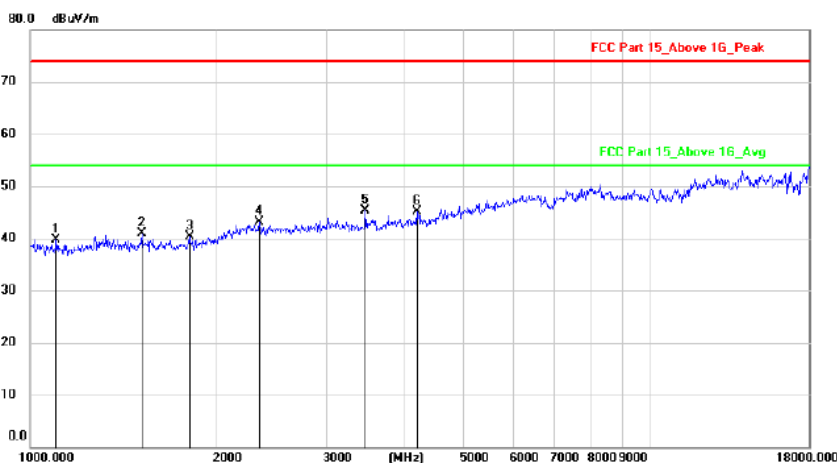

| No. | Mk. | Freq. | Reading Level | Correct Factor | Measurement | Limit | Margin | Antenna Height | Table Degree | |
|-----|-----|----------|---------------|----------------|-------------|--------|--------|----------------|--------------|---------|
| | | MHz | dBuV | dB | dBuV/m | dBuV/m | dB | cm | degree | Comment |
| 1 | | 1100.079 | 48.32 | -8.57 | 39.75 | 74.00 | -34.25 | | | peak |
| 2 | | 1511.833 | 47.80 | -6.99 | 40.81 | 74.00 | -33.19 | | | peak |
| 3 | | 1803.332 | 46.71 | -6.44 | 40.27 | 74.00 | -33.73 | | | peak |
| 4 | | 2339.107 | 46.48 | -3.34 | 43.14 | 74.00 | -30.86 | | | peak |
| 5 | * | 3465.510 | 52.01 | -6.62 | 45.39 | 74.00 | -28.61 | | | peak |
| 6 | | 4193.872 | 49.74 | -4.62 | 45.12 | 74.00 | -28.88 | | | peak |

4. POWER LINE CONDUCTED EMISSION

4.1. Conducted Emission Limits (15.209)

| Frequency MHz | Limits dB(μ V) | |
|------------------|---------------------|---------------|
| | Quasi-peak Level | Average Level |
| 0.15 -0.50 | 66 -56* | 56 - 46* |
| 0.50 -5.00 | 56 | 46 |
| 5.00 -30.00 | 60 | 50 |

Notes: 1. *Decreasing linearly with logarithm of frequency.

2. The lower limit shall apply at the transition frequencies.

3. The limit decreases in line with the logarithm of the frequency in the rang of 0.15 to 0.50 MHz.

4.2. Test Setup

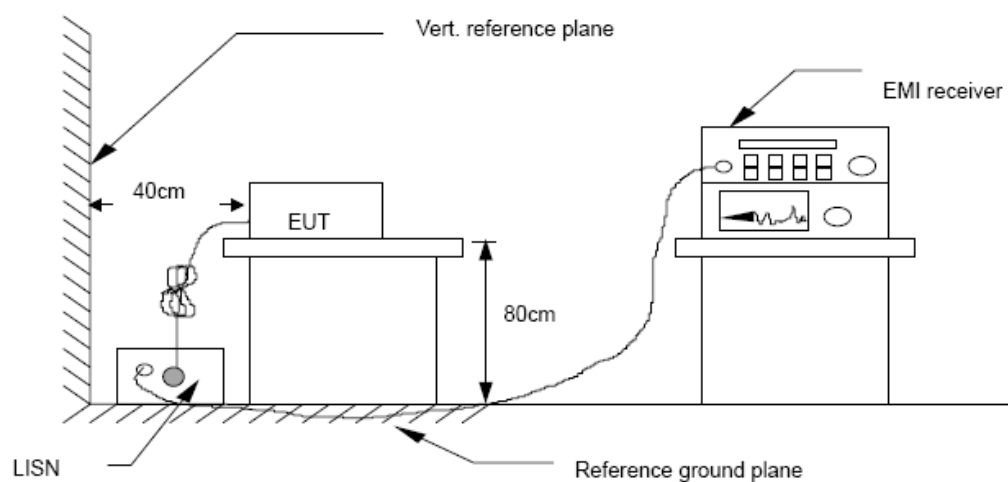

4.3. Test Procedure

The EUT is put on the plane 0.8m high above the ground by insulating support and is connected to the power mains through a line impedance stabilization network (L.I.S.N.). This provides a 50ohm coupling impedance for the EUT system. Please refer the block diagram of the test setup and photographs. Both sides of AC lines are checked to find out the maximum conducted emission. In order to find the maximum emission levels, the relative positions of equipment and all of the interface cables shall be changed according to ANSI C63.10:2013 on Conducted Emission Measurement.

The bandwidth of test receiver (R & S ESCI) is set at 9 kHz.

4.4. Test Results

EUT power supply by battery, so the test not applicable.

5. Occupied bandwidth

5.1. Test limit

Please refer section RSS-210 & 15.231

According to §15.231(C), The bandwidth of the emission shall be no wider than 0.25% of the center frequency for devices operating above 70MHz and below 900MHz.

5.2. Method of measurement

- a) The bandwidth is measured at an amplitude level reduced 20dB from the reference level. The reference level is the level of the highest amplitude signal observed from the transmitter at the fundamental frequency. Once the reference level is established, the equipment is conditioned with typical modulating signal to produce the worst-case (i.e. the widest) bandwidth.
- b) The test receiver RBW set 30KHz, VBW set 30KHz, Sweep time set auto.

5.3. Test Setup

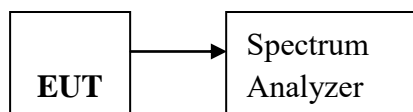

5.4. Test Results

| Mode | Freq (MHz) | 20dB Bandwidth (KHz) | 99% BW (KHz) | Limit (kHz) | Conclusion |
|------|------------|----------------------|--------------|-------------|------------|
| ASK | 315 | 149.6 | 285.34 | 787.5 | PASS |

Note: Limit = 315MHz * 0.25% = 787.5 kHz

315MHz

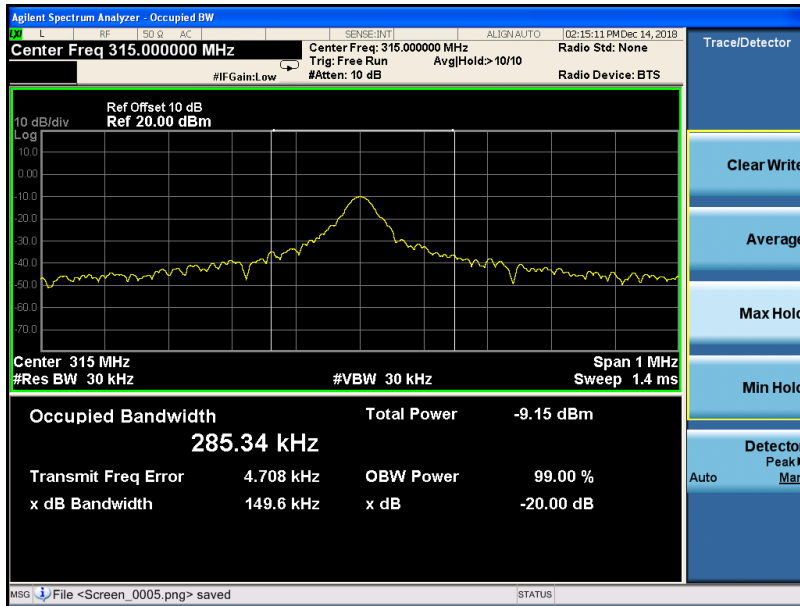

6. Transmission time

6.1. Test limit

Please refer section RSS-210 & 15.231

According to §15.231(a)(1), A manually operated transmitter shall employ a switch that will automatically deactivate the transmitter within not more than 5 seconds of being released.

6.2. Method of measurement

6.2.1. Place the EUT on the table and set it in transmitting mode.

6.2.2. Remove the antenna from the EUT and then connect a low loss RF cable from the antenna port to the spectrum analyzer.

6.2.3. Set spectrum analyzer Center= 315MHz, Span = 0MHz, Sweep = 5s.

6.2.4. Set the spectrum analyzer as RBW, VBW=1MHz,

6.2.5. Max hold, view and count how many channel in the band.

6.3. Test Setup

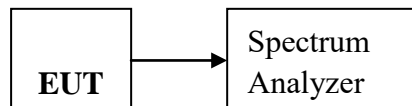

6.4. Test Results

| Freq (MHz) | Test Result(s) | Limit (s) | Conclusion |
|------------|----------------|-----------|------------|
| 315 | 0.330 | < 5s | PASS |

Compliance with 15.231 a(1) section.

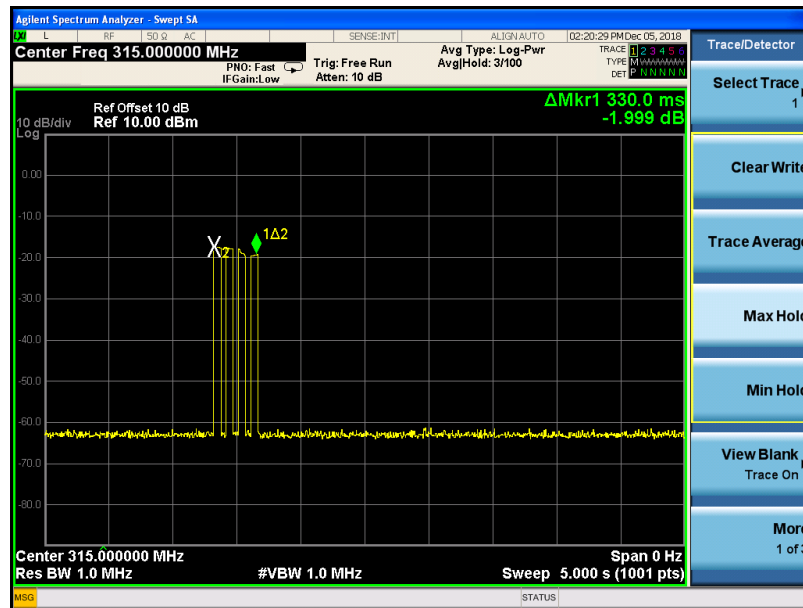

7. Antenna Requirement

7.1. Standard Requirement

An intentional radiator shall be designed to ensure that no antenna other than that furnished by the responsible party shall be used with the device. The use of a permanently attached antenna or of an antenna that uses a unique coupling to the intentional radiator shall be considered sufficient to comply with the provisions of this Section. The manufacturer may design the unit so that a broken antenna can be replaced by the user, but the use of a standard antenna jack or electrical connector is prohibited.

7.2. Antenna Connected Construction

The directional gains of antenna used for transmitting is 0 dBi, and the antenna connector is designed with permanent attachment and no consideration of replacement. Please see EUT photo for details.

7.3. Result

The EUT antenna is Internal antenna. It comply with the standard requirement.

8. Test setup photo

Photos of Radiated emission

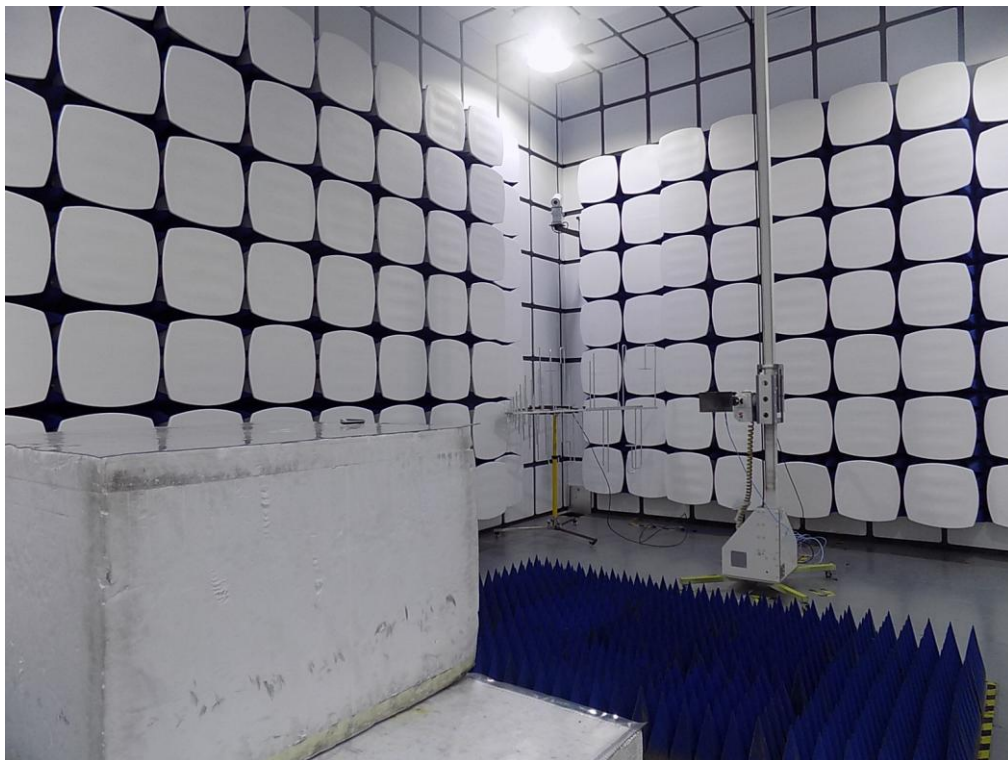
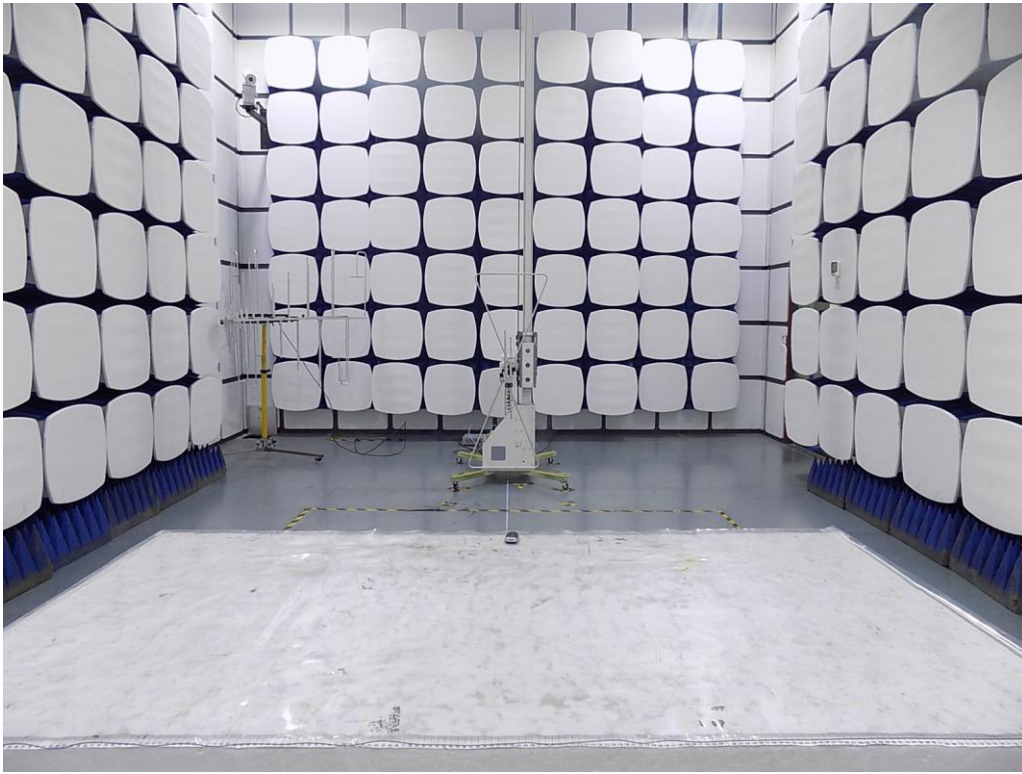

9. Photos of EUT









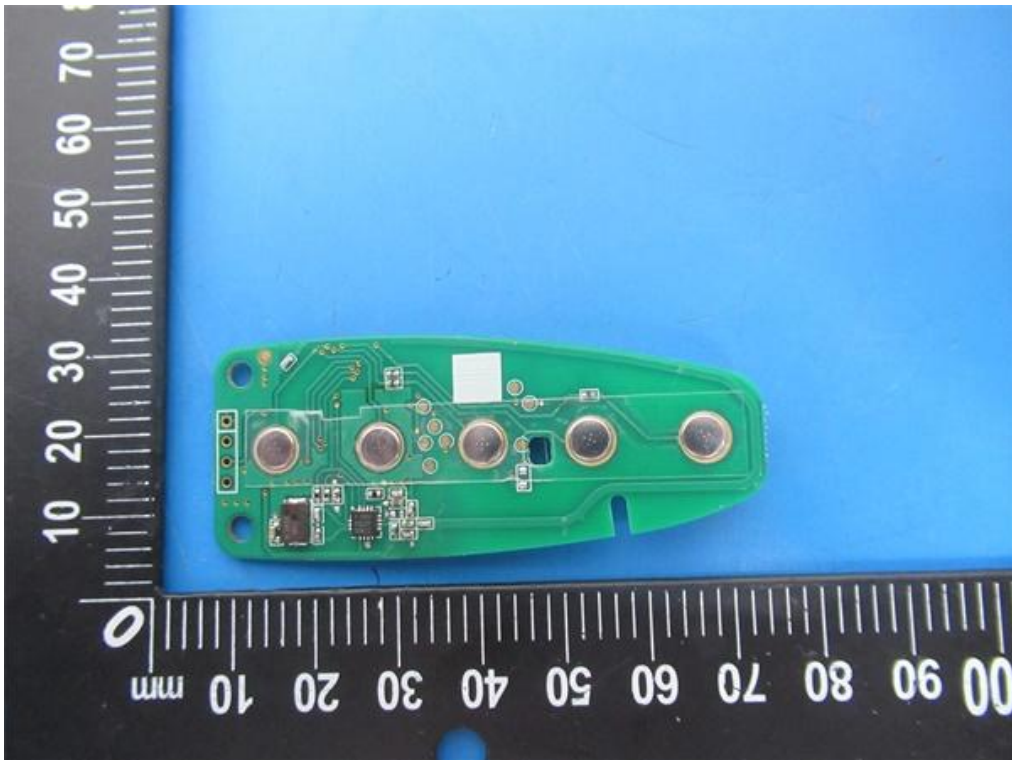
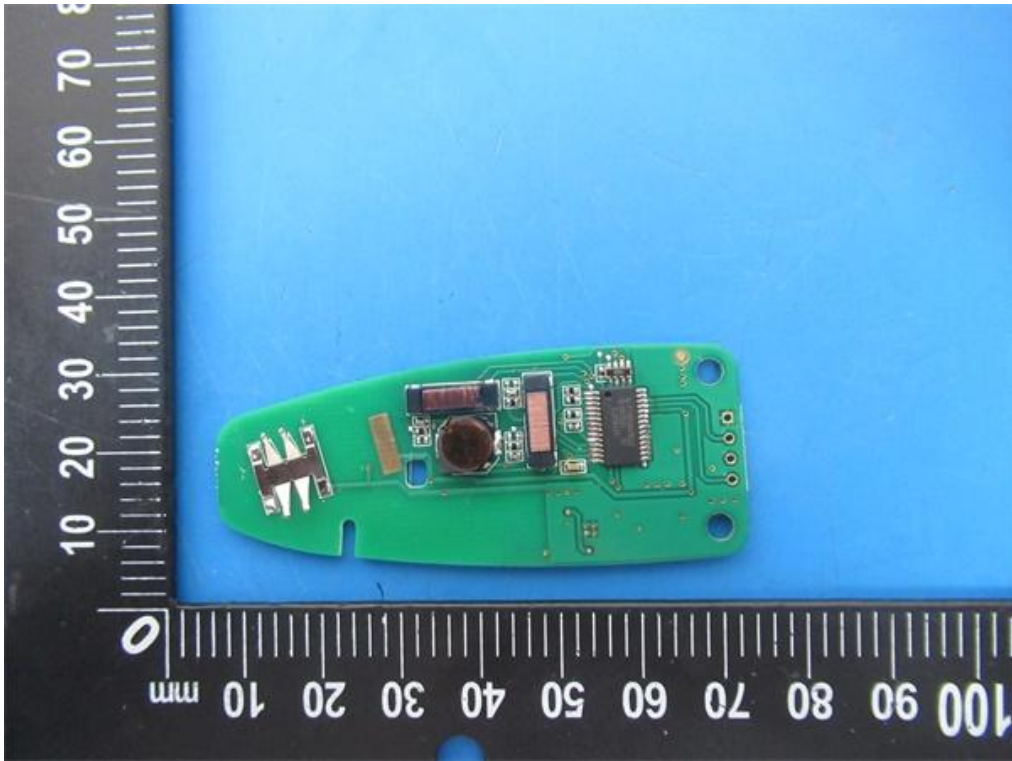



-----END OF THE REPORT-----