



**FCC PART 15 SUBPART C
CERTIFICATION TEST REPORT**

For

Portable Air-Condition

**MODEL NUMBER: TAC-12CHPA/K, TAC-14CHPA/K, TAC-14CPA/K,
TAC-12CPA/K, TAC-10CPA/K**

FCC ID: 2AHH3TAC3TYJW2-K

REPORT NUMBER: 4788426378.1-2

ISSUE DATE: 26 Feb. 2018

Prepared for

**TCL DeLonghi Home Appliances (zhongshan) Co., Ltd.
Shenghui North Industrial District, Nantou Zhongshan, Guangdong, China**

Prepared by

**UL Verification Services (Guangzhou) Co., Ltd, Song Shan Lake Branch
Room 101, Building 10, Innovation Technology Park,
Song Shan Lake Hi tech Development Zone, Dongguan, 523808, China
Tel: +86 769 33817100
Fax: +86 769 33244054
Website: www.ul.com**



Revision History

<u>Rev.</u>	<u>Issue Date</u>	<u>Revisions</u>	<u>Revised By</u>
--	2/26/2018	Initial Issue	



Summary of Test Results			
Clause	Test Items	FCC/IC Rules	Test Results
1	6dB Bandwidth and 99% Bandwidth	FCC 15.247 (a) (2)	Pass
2	Peak Conducted Output Power	FCC 15.247 (b) (3)	Pass
3	Power Spectral Density	FCC 15.247 (e)	Pass
4	Conducted Bandedge and Spurious Emission	FCC 15.247 (d)	Pass
5	Radiated Bandedge and Spurious Emission	FCC 15.247 (d) FCC 15.209 FCC 15.205	Pass
6	Conducted Emission Test For AC Power Port	FCC 15.207	Pass
7	Antenna Requirement	FCC 15.203	Pass



TABLE OF CONTENTS

1. ATTESTATION OF TEST RESULTS	6
2. TEST METHODOLOGY	7
3. FACILITIES AND ACCREDITATION	7
4. CALIBRATION AND UNCERTAINTY	8
4.1. <i>MEASURING INSTRUMENT CALIBRATION</i>	8
4.2. <i>MEASUREMENT UNCERTAINTY</i>	8
5. EQUIPMENT UNDER TEST	9
5.1. <i>DESCRIPTION OF EUT</i>	9
5.2. <i>MAXIMUM OUTPUT POWER</i>	9
5.3. <i>CHANNEL LIST</i>	9
5.4. <i>TEST CHANNEL CONFIGURATION</i>	10
5.5. <i>THE WORSE CASE CONFIGURATIONS</i>	10
5.6. <i>DESCRIPTION OF AVAILABLE ANTENNAS</i>	10
5.7. <i>DESCRIPTION OF TEST SETUP</i>	11
6. MEASURING INSTRUMENT AND SOFTWARE USED	12
7. MEASUREMENT METHODS	14
8. ANTENNA PORT TEST RESULTS	15
8.1. <i>ON TIME AND DUTY CYCLE</i>	15
8.2. <i>6 dB DTS BANDWIDTH AND 99% BANDWIDTH</i>	18
8.2.1. 802.11b MODE.....	19
8.2.2. 802.11g MODE.....	21
8.2.3. 802.11n HT20 MODE	23
8.3. <i>PEAK CONDUCTED OUTPUT POWER</i>	25
8.3.1. 802.11b MODE.....	26
8.3.2. 802.11g MODE.....	26
8.3.3. 802.11n HT20 MODE	26
8.4. <i>POWER SPECTRAL DENSITY</i>	27
8.4.1. 802.11b MODE.....	28
8.4.2. 802.11g MODE.....	30
8.4.3. 802.11n HT20 MODE	32
8.5. <i>CONDUCTED BANDEDGE AND SPURIOUS EMISSIONS</i>	34
8.5.1. 802.11b MODE.....	35
8.5.2. 802.11g MODE.....	38
8.5.3. 802.11n HT20 MODE	41



9. RADIATED TEST RESULTS44

9.1. *RESTRICTED BANDEGE* 50

9.2. *SPURIOUS EMISSIONS (9KHz-30MHz)*..... 51

9.3. *SPURIOUS EMISSIONS (30-1GHz)*..... 52

9.4. *SPURIOUS EMISSIONS (Above 1GHz)*..... 54

10. AC POWER LINE CONDUCTED EMISSIONS.....57

11. ANTENNA REQUIREMENTS60



1. ATTESTATION OF TEST RESULTS

Applicant Information

Company Name: TCL Delonghi Home Appliances (zhongshan) Co., Ltd.
Address: Shenghui North Industrial District, Nantou
Zhongshan,Guangdong,China

Manufacturer Information

Company Name: TCL Delonghi Home Appliances (zhongshan) Co., Ltd.
Address: Shenghui North Industrial District, Nantou
Zhongshan,Guangdong,China

EUT Description

EUT Name: Portable Air-Condition
Model: TAC-12CHPA/K,TAC-14CHPA/K,TAC-14CPA/K
TAC-12CPA/K, TAC-10CPA/K
Brand Name: N/A
Sample Status: Normal
Sample ID: 1102464
Sample Received Date: 30 Nov. 2017
Date of Tested: 01 Dec. 2017 ~26 Feb. 2018

APPLICABLE STANDARDS	
STANDARD	TEST RESULTS
FCC Part 15 Subpart C	PASS

Tested By:

Chris chen
Engineer Project Associate
Approved By:

Stephen Guo
Laboratory Manager

Checked By:

Shawn Wen
Laboratory Leader



2. TEST METHODOLOGY

The tests documented in this report were performed in accordance with 558074 D01 DTS Meas Guidance v04, 414788 D01 Radiated Test Site v01, FCC CFR 47 Part 2, FCC CFR 47 Part 15 and ANSI C63.10-2013.

3. FACILITIES AND ACCREDITATION

Accreditation Certificate	<p>A2LA (Certificate No.: 4338.01) Shenzhen STS Test Services Co., Ltd. has been assessed and proved to be in compliance with A2LA.</p> <p>CNAS (Registration No.: L7649) Shenzhen STS Test Services Co., Ltd. has been assessed and proved to be in compliance with CNAS.</p> <p>FCC (FCC Designation No.: 625569) Shenzhen STS Test Services Co., Ltd. has been recognized to perform compliance testing on equipment subject to the Commission's Declaration of Conformity (DoC) and Certification rules</p> <p>IC(Company No.: 12108A) Shenzhen STS Test Services Co., Ltd. has been registered and fully described in a report filed with Industry Canada. The Company Number is 12108A.</p>
---------------------------	---

Note 1: All tests measurement facilities use to collect the measurement data are located at 1/F., Building B, Zhuoke Science Park, No.190, Chongqing Road, Fuyong Street, Bao'an District, Shenzhen, Guangdong, China

Note 2: The test anechoic chamber in Shenzhen STS Test Services Co., Ltd. had been calibrated and compared to the open field sites and the test anechoic chamber is shown to be equivalent to or worst case from the open field site.



4. CALIBRATION AND UNCERTAINTY

4.1. MEASURING INSTRUMENT CALIBRATION

The measuring equipment utilized to perform the tests documented in this report has been calibrated in accordance with the manufacturer's recommendations, and is traceable to recognize national standards.

4.2. MEASUREMENT UNCERTAINTY

The reported uncertainty of measurement $y \pm U$, where expanded uncertainty U is based on a standard uncertainty multiplied by a coverage factor of $k=2$, providing a level of confidence of approximately 95 %.

No.	Item	Uncertainty
1	Conducted Emission (9KHz-150KHz)	$\pm 2.88\text{dB}$
2	Conducted Emission (150KHz-30MHz)	$\pm 2.67\text{dB}$
3	RF power,conducted	$\pm 0.71\text{dB}$
4	Spurious emissions,conducted	$\pm 0.63\text{dB}$
5	All emissions,radiated (9KHz-30MHz)	$\pm 3.02\text{dB}$
6	All emissions,radiated (30MHz-200MHz)	$\pm 3.80\text{dB}$
7	All emissions,radiated (200MHz-1000MHz)	$\pm 3.97\text{dB}$
8	All emissions,radiated(>1G)	$\pm 3.03\text{dB}$



5. EQUIPMENT UNDER TEST

5.1. DESCRIPTION OF EUT

EUT Name	Portable Air-Condition
EUT Description	N/A
Model	TAC-14CHPA/K
Series Model	TAC-12CHPA/K,TAC-14CPA/K, TAC-12CPA/K, TAC-10CPA/K
Model Difference	There are appearance and working function different , one of these parts model have electrical heating & cooling or cooling only. Therefore used the most complicated model tested representative
Radio Technology	IEEE802.11b/g/n HT20
Operation frequency	IEEE 802.11b: 2412MHz—2462MHz IEEE 802.11g: 2412MHz—2462MHz IEEE 802.11n HT20: 2412MHz—2462MHz
Modulation	IEEE 802.11b: DSSS(CCK) IEEE 802.11g: OFDM(64QAM, 16QAM, QPSK, BPSK) IEEE 802.11n HT20: OFDM (64QAM, 16QAM, QPSK,BPSK)
Power Supply	Input: AC 120V, 15000mA
Hardware Version	N/A
Software Version	N/A

5.2. MAXIMUM OUTPUT POWER

Frequency Range (MHz)	Number of Transmit Chains (NTX)	IEE Std. 802.11	Frequency (MHz)	Channel Number	Max PK Conducted Power (dBm)
2400-2483.5	1	IEEE 802.11b	2412-2462	1-11[11]	15.63
2400-2483.5	1	IEEE 802.11g	2412-2462	1-11[11]	14.79
2400-2483.5	1	IEEE 802.11nHT20	2412-2462	1-11[11]	14.68

5.3. CHANNEL LIST

Channel	Frequency (MHz)	Channel	Frequency (MHz)	Channel	Frequency (MHz)	Channel	Frequency (MHz)
1	2412	4	2425	7	2442	10	2457
2	2417	5	2432	8	2447	11	2462
3	2422	6	2437	9	2452	N/A	N/A



5.4. TEST CHANNEL CONFIGURATION

Test Mode	Test Channel	Frequency
WiFi TX(802.11b)	CH 1, CH 6, CH 11	2412MHz, 2437MHz, 2462MHz
WiFi TX(802.11g)	CH 1, CH 6, CH 11	2412MHz, 2437MHz, 2462MHz
WiFi TX(802.11n HT20)	CH 1, CH 6, CH 11	2412MHz, 2437MHz, 2462MHz

5.5. THE WORSE CASE CONFIGURATIONS

The Worse Case Power Setting Parameter under 2400 ~ 2483.5MHz Band							
Test Software Version		SecureCRT.exe					
Modulation Mode	Transmit Antenna Number	Test Channel					
		NCB: 20MHz			NCB: 40MHz		
		CH 1	CH 6	CH 11	CH 3	CH 7	CH 11
802.11b	1	Default	Default	Default	N/A		
802.11g	1	Default	Default	Default			
802.11n HT20	1	Default	Default	Default			

5.6. DESCRIPTION OF AVAILABLE ANTENNAS

Ant.	Frequency (MHz)	Antenna Type	Antenna Gain (dBi)
1	2412-2462	PCB Antenna	0

Test Mode	Transmit and Receive Mode	Description
IEEE 802.11b	<input checked="" type="checkbox"/> 1TX, 1RX	Chain 1 can be used as transmitting/receiving antenna.
IEEE 802.11g	<input checked="" type="checkbox"/> 1TX, 1RX	Chain 1 can be used as transmitting/receiving antenna.
IEEE 802.11n HT20	<input checked="" type="checkbox"/> 1TX, 1RX	Chain 1 can be used as transmitting/receiving antenna.

5.7. DESCRIPTION OF TEST SETUP

SUPPORT EQUIPMENT

Item	Equipment	Brand Name	Model Name	P/N
1	PC	HP	500-320cx	N/A

I/O CABLES

Cable No	Port	Connector Type	Cable Type	Cable Length(cm)	Remarks
1	USB Cable	N/A	N/A	100	N/A

TEST SETUP

The EUT can work in engineering mode with firmware QRCT from QUALCOMM through a Laptop.

SETUP DIAGRAM FOR TESTS

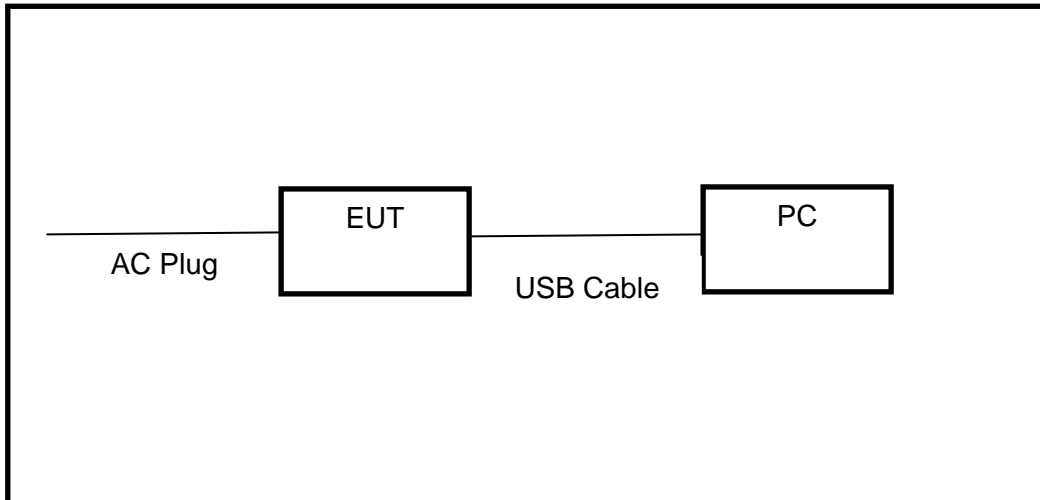



6. MEASURING INSTRUMENT AND SOFTWARE USED

Conducted Emissions						
Used	Equipment	Manufacturer	Model No.	Serial No.	Last Cal.	Next Cal.
	Test Receiver	R&S	ESCI	101427	2017.10.15	2018.10.14
	LISN	R&S	ENV216	101242	2017.10.15	2018.10.14
	Conduction Cable	EM	C01	N/A	2017.03.12	2018.03.11
	Temperature & Humidity	Mieo	HH660	N/A	2017.10.15	2018.10.14
Radiated Emissions						
Used	Equipment	Manufacturer	Model No.	Serial No.	Last Cal.	Next Cal.
	EMI Test Receiver	R&S	ESW	101535	2017.06.01	2018.05.31
	Bilog Antenna	TESEQ	CBL6111D	34678	2017.03.24	2018.03.23
	Horn Antenna	Schwarzbeck	BBHA 9120D	9120D-1343	2017.03.06	2018.03.05
	SHF-EHF Horn Antenna (15G-40GHz)	BBHA 9170	SCHWARZBECK	BBHA9170367	2017.05.02	2018.05.01
	Temperature & Humidity	HH660	Mieo	N/A	2017.10.15	2018.10.14
	Temperature & Humidity	HH660	Mieo	N/A	2017.10.15	2018.10.14
	Pre-mpifier (0.1M-3GHz)	EM	EM330	60538	2017.03.12	2018.03.11
	PreAmplifier (1G-26.5GHz)	Agilent	8449B	60538	2017.10.15	2018.10.14
	Pre-mpifier (18G-40G)	MINI-CIRCUITS	AP-040G	1382501	2017.05.15	2018.05.14
	Operational Manual Passive Loop (9K--30MHz)	ETS	6512	00165355	2017.03.06	2018.03.05
	Low frequency cable	EM	R01	N/A	2017.03.12	2018.03.11
	Low frequency cable	EM	R06	N/A	2017.03.12	2018.03.11
	High frequency cable	SCHWARZBECK	R04	N/A	2017.03.12	2018.03.11
	High frequency cable	SCHWARZBECK	R02	N/A	2017.03/12	2018.03.11
	Semi-anechoic chamber	Changling	966	N/A	2017.10.15	2018.10.14
	trun table	EM	SC100_1	60531	N/A	N/A
	Antnna mast	EM	SC100	N/A	N/A	N/A
	Max-full Antenna Corp	MF	MFA-440H	N/A	N/A	N/A



Other instruments						
Used	Equipment	Manufacturer	Model No.	Serial No.	Last Cal.	Next Cal.
	USB RF power sensor	DARE	RPR3006 W	15I00041SNO0 3	2017.10.15	2018.10.14
	Power Meter	R&S	NRP	100510	2017.10.15	2018.10.14
	Spectrum Analyzer	Agilent	E4407B	MY50140340	2017.03.11	2018.03.10
	Signal Analyzer	Agilent	N9020A	MY49100060	2017.03.11	2018.03.10



7. MEASUREMENT METHODS

No.	Test Item	KDB Name	Section
1	6dB Bandwidth and 99% Bandwidth	KDB 558074 D01 DTS Meas Guidance v04	8.0
2	Peak Output Power	KDB 558074 D01 DTS Meas Guidance v04	9.1.3
3	Power Spectral Density	KDB 558074 D01 DTS Meas Guidance v04	10.2
4	Out-of-band emissions in non-restricted bands	KDB 558074 D01 DTS Meas Guidance v04	11.0
5	Out-of-band emissions in restricted bands	KDB 558074 D01 DTS Meas Guidance v04	12.1
6	Band-edge	KDB 558074 D01 DTS Meas Guidance v04	13.3.2
7	Conducted Emission Test For AC Power Port	ANSI C63.10-2013	7.3



8. ANTENNA PORT TEST RESULTS

8.1. ON TIME AND DUTY CYCLE

LIMITS

None; for reporting purposes only

PROCEDURE

a
KDB 558074 Zero-Span Spectrum Analyzer Method

TEST SETUP

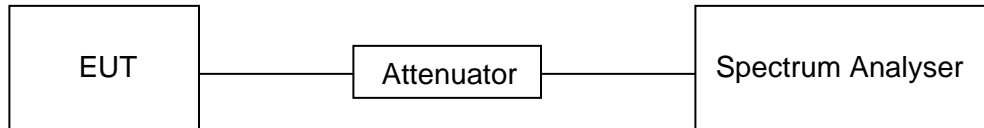

TEST ENVIRONMENT

Temperature	25°C	Relative Humidity	60%
Atmosphere Pressure	101kPa	Test Voltage	AC 120V/60Hz

RESULTS

Mode	On Time (msec)	Period (msec)	Duty Cycle x (Linear)	Duty Cycle (%)	Duty Cycle Correction Factor (db)	1/B Minimum VBW (KHz)
11b	8.240	8.240	1.0000	100.00	0.00	0.12
11g	1.368	1.410	0.9702	97.02	0.13	0.73
11n20	1.287	1.329	0.9684	96.84	0.14	0.78

Note: Duty Cycle Correction Factor=10log(1/x).
Where: x is Duty Cycle(Linear)
Where: B is On Time

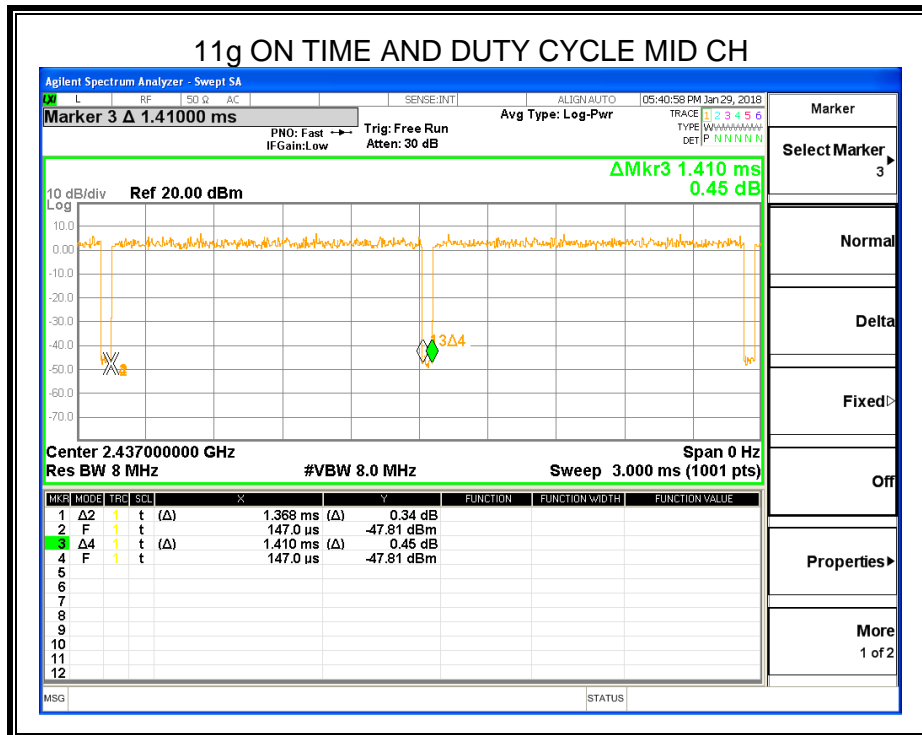
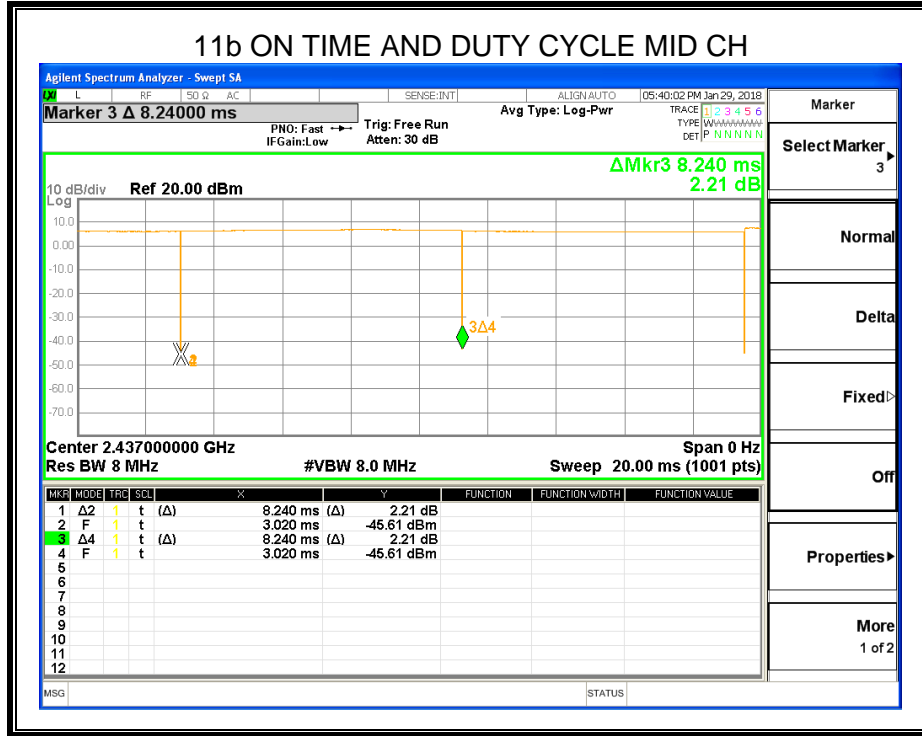

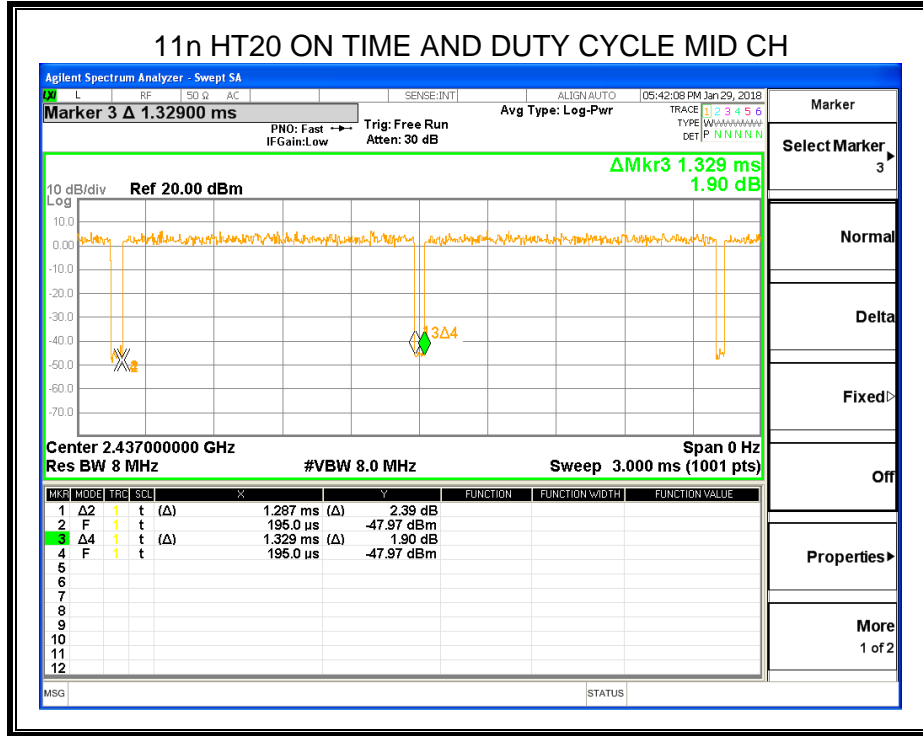

8.2. 6 dB DTS BANDWIDTH AND 99% BANDWIDTH

LIMITS

FCC Part15 (15.247) Subpart C			
Section	Test Item	Limit	Frequency Range (MHz)
FCC 15.247(a)(2)	6 dB Bandwidth	$\geq 500\text{KHz}$	2400-2483.5

TEST PROCEDURE

Connect the UUT to the spectrum analyser and use the following settings:

Center Frequency	The centre frequency of the channel under test
Detector	Peak
RBW	For 6dB Bandwidth :100K For 99% Bandwidth :1% to 5% of the occupied bandwidth
VBW	For 6dB Bandwidth : $\geq 3 \times \text{RBW}$ For 99% Bandwidth : approximately $3 \times \text{RBW}$
Trace	Max hold
Sweep	Auto couple

Allow the trace to stabilize and measure the maximum width of the emission that is constrained by the frequencies associated with the two outermost amplitude points (upper and lower frequencies) that are attenuated by 6 dB and 99% relative to the maximum level measured in the fundamental emission.

TEST SETUP

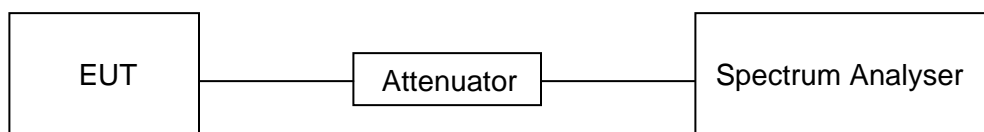



TEST ENVIRONMENT

Temperature	25°C	Relative Humidity	60%
Atmosphere Pressure	101kPa	Test Voltage	AC 120V/60Hz

RESULTS

8.2.1. 802.11b MODE

Channel	Frequency (MHz)	6dB bandwidth (MHz)	Limit (kHz)	Result
Low	2412	9.019	500	Pass
Middle	2437	9.014	500	Pass
High	2462	9.086	500	Pass

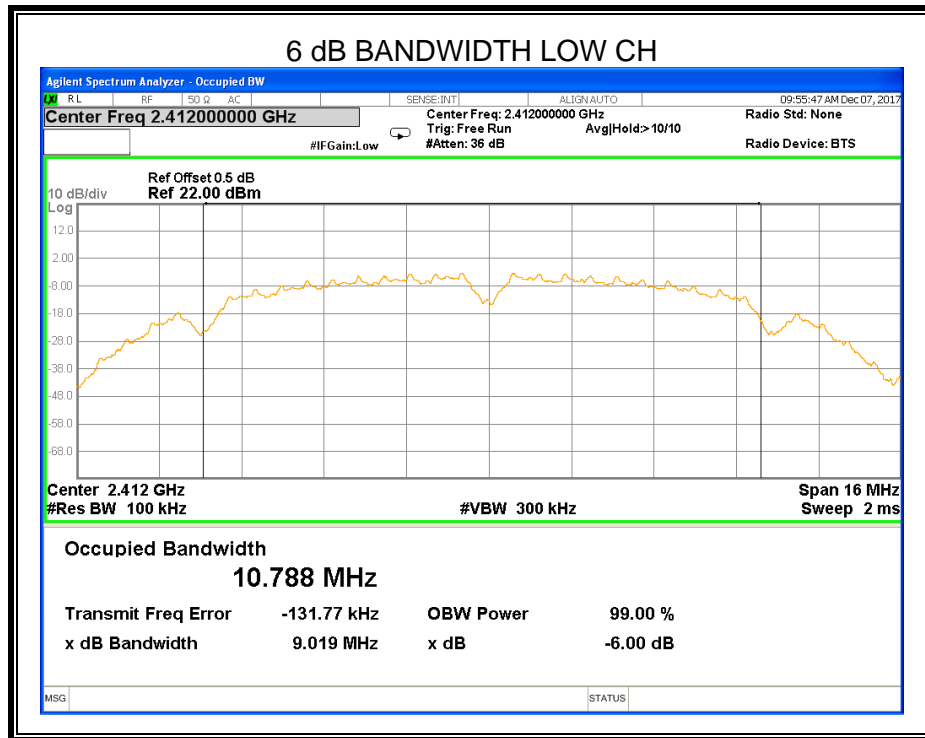

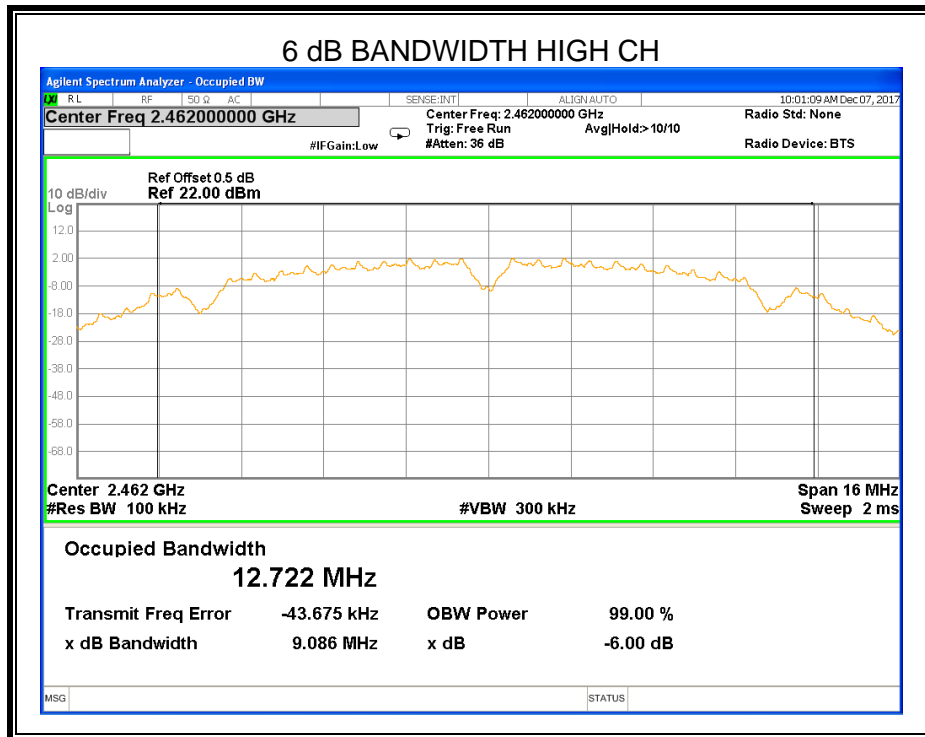
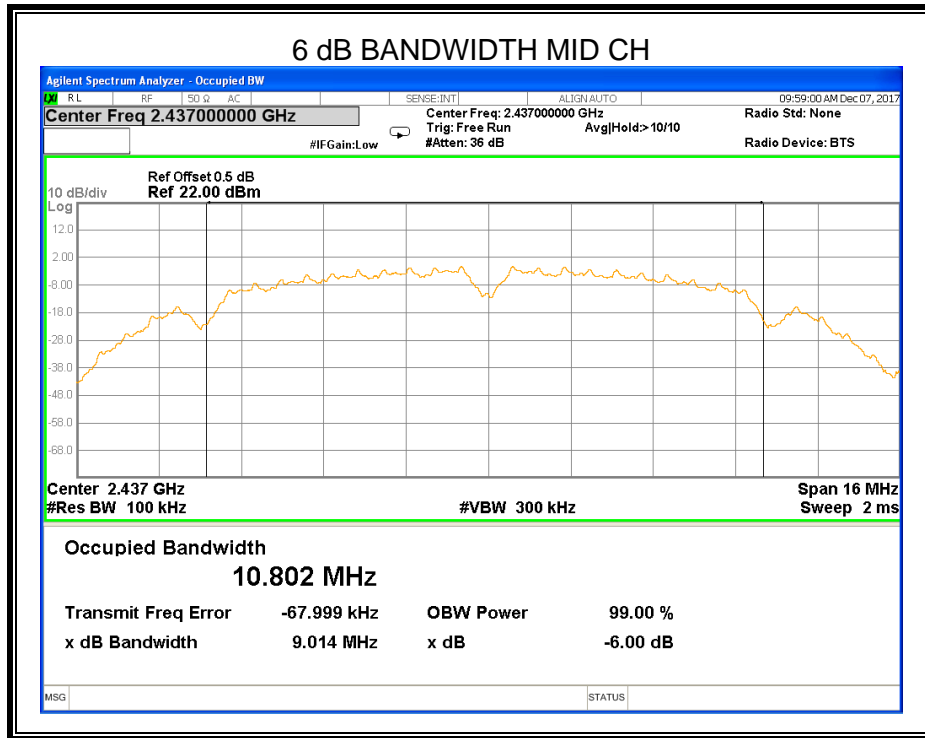



8.2.2. 802.11g MODE

Channel	Frequency (MHz)	6dB bandwidth (MHz)	Limit (kHz)	Result
Low	2412	16.35	500	Pass
Middle	2437	16.35	500	Pass
High	2462	16.34	500	Pass

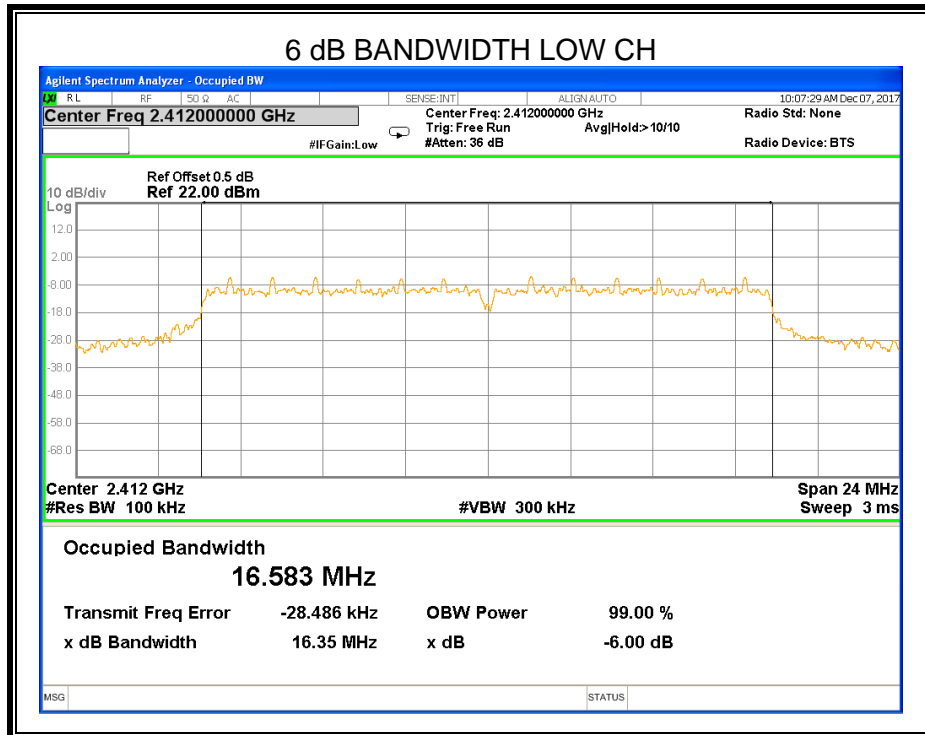

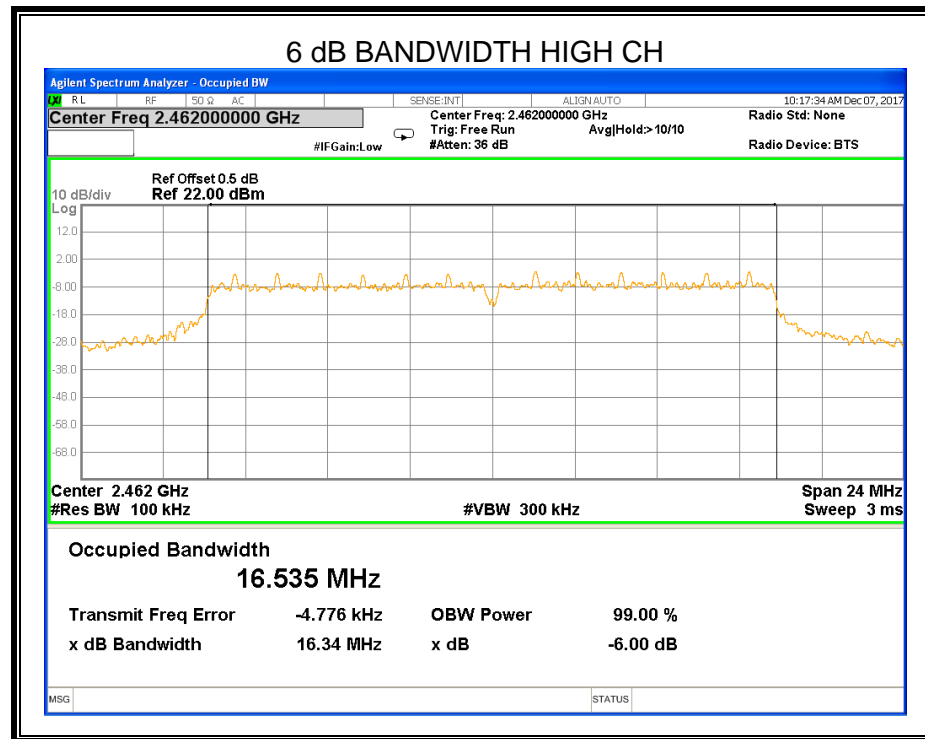
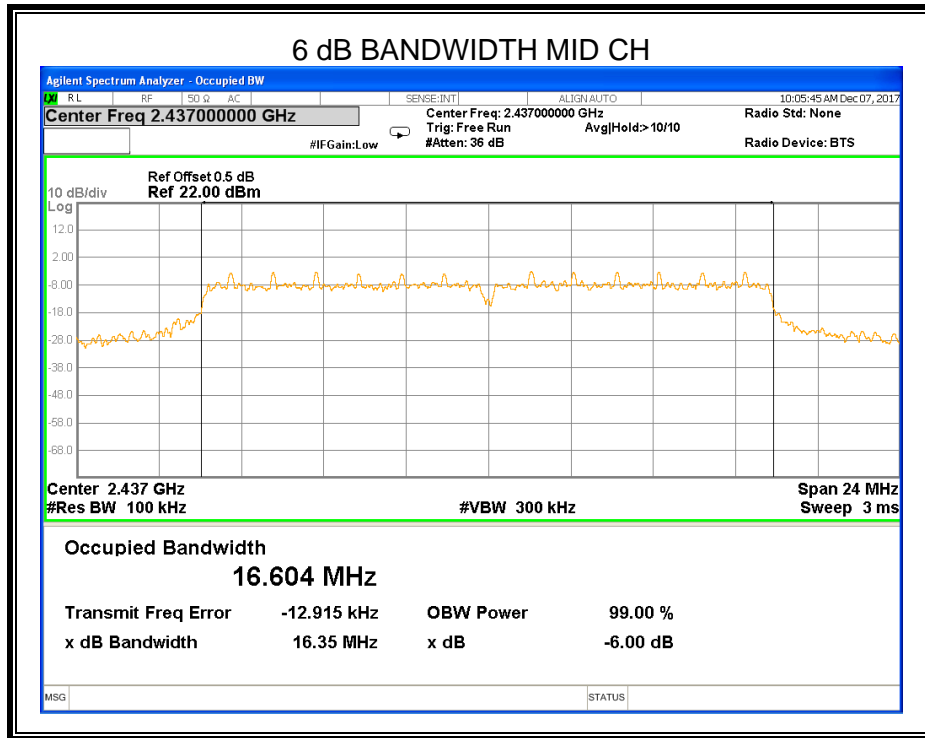



8.2.3. 802.11n HT20 MODE

Channel	Frequency (MHz)	6dB bandwidth (MHz)	Limit (kHz)	Result
Low	2412	17.59	500	Pass
Middle	2437	17.58	500	Pass
High	2462	17.57	500	Pass

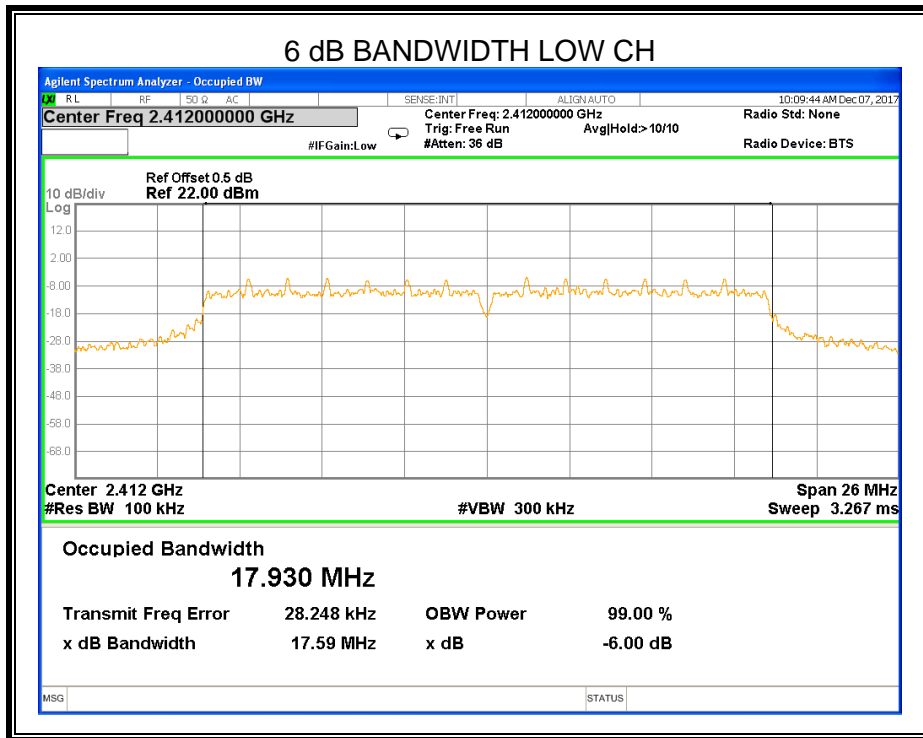

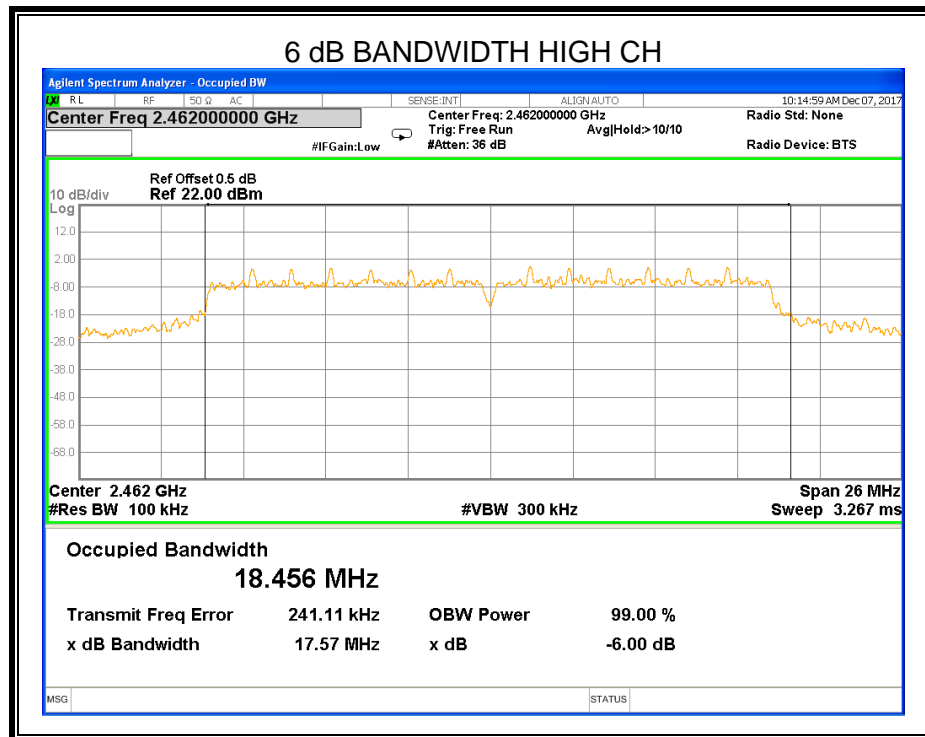
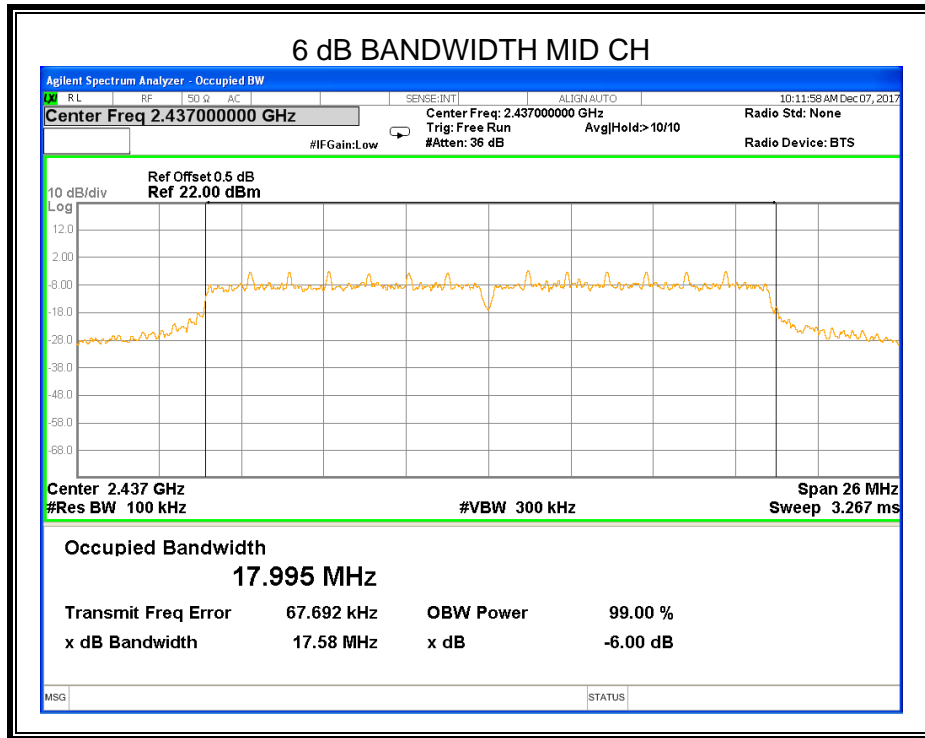



8.3. PEAK CONDUCTED OUTPUT POWER

LIMITS

FCC Part15 (15.247) Subpart C			
Section	Test Item	Limit	Frequency Range (MHz)
FCC 15.247(b)(3)	Peak Output Power	1 watt or 30dBm	2400-2483.5

TEST PROCEDURE

Place the EUT on the table and set it in the transmitting mode.
Remove the antenna from the EUT and then connect a low loss RF cable from the antenna port to the Power sensor.
Measure peak power each channel.

TEST SETUP

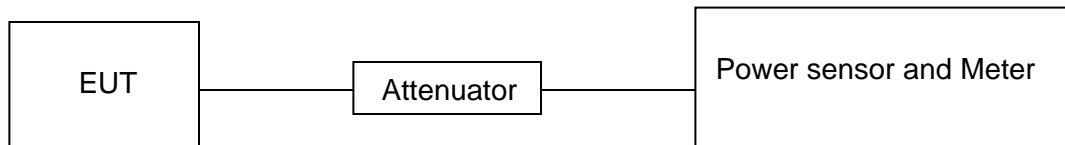

TEST ENVIRONMENT

Temperature	25°C	Relative Humidity	60%
Atmosphere Pressure	101kPa	Test Voltage	AC 120V/60Hz



RESULTS

8.3.1. 802.11b MODE

Test Channel	Frequency	Maximum Conducted Output Power(PK)	LIMIT
	(MHz)	(dBm)	dBm
Low	2412	14.64	30
Middle	2437	14.43	30
High	2462	15.63	30

8.3.2. 802.11g MODE

Test Channel	Frequency	Maximum Conducted Output Power(PK)	LIMIT
	(MHz)	(dBm)	dBm
Low	2412	12.92	30
Middle	2437	13.72	30
High	2462	14.79	30

8.3.3. 802.11n HT20 MODE

Test Channel	Frequency	Maximum Conducted Output Power(PK)	LIMIT
	(MHz)	(dBm)	dBm
Low	2412	12.87	30
Middle	2437	14.63	30
High	2462	14.68	30



8.4. POWER SPECTRAL DENSITY

LIMITS

FCC Part15 (15.247) Subpart C			
Section	Test Item	Limit	Frequency Range (MHz)
FCC §15.247 (e)	Power Spectral Density	8 dBm in any 3 kHz band	2400-2483.5

TEST PROCEDURE

Connect the UUT to the spectrum analyser and use the following settings:

Center Frequency	The centre frequency of the channel under test
Detector	Peak
RBW	$3 \text{ kHz} \leq \text{RBW} \leq 100 \text{ kHz}$
VBW	$\geq 3 \times \text{RBW}$
Span	1.5 x DTS bandwidth
Trace	Max hold
Sweep time	Auto couple.

Allow trace to fully stabilize and use the peak marker function to determine the maximum amplitude level within the RBW.

If measured value exceeds limit, reduce RBW (no less than 3 kHz) and repeat.

TEST SETUP

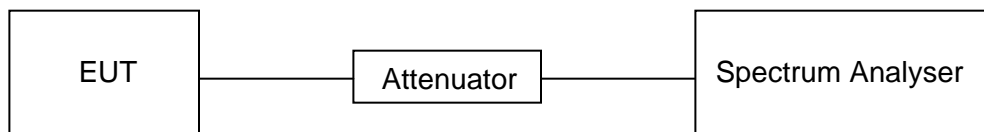

TEST ENVIRONMENT

Temperature	25°C	Relative Humidity	60%
Atmosphere Pressure	101kPa	Test Voltage	AC 120V/60Hz



RESULTS

8.4.1. 802.11b MODE

Test Channel	Frequency	Power Spectral Density (dBm/3kHz)	Limit (dBm/3kHz)	Result
Low	2412MHz	-17.419	8	PASS
Middle	2437MHz	-15.562	8	PASS
High	2462MHz	-12.374	8	PASS

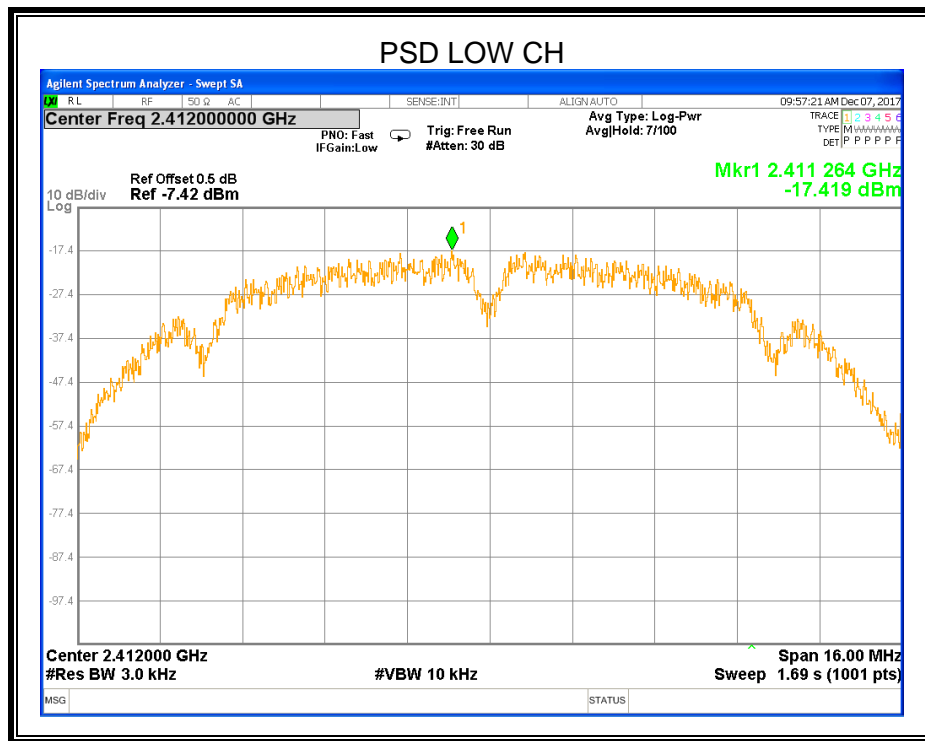

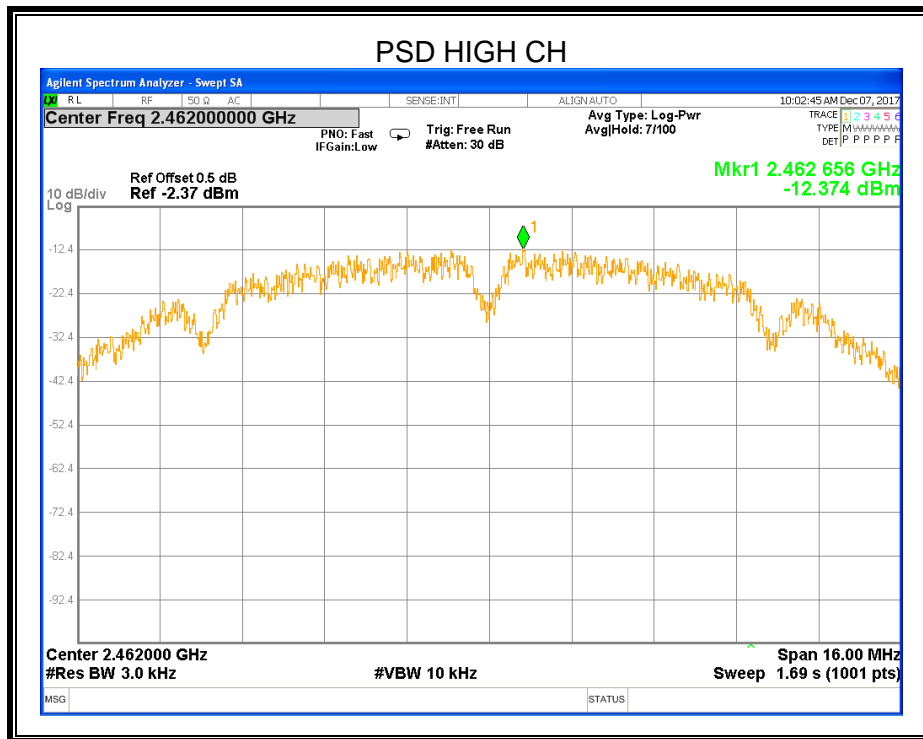
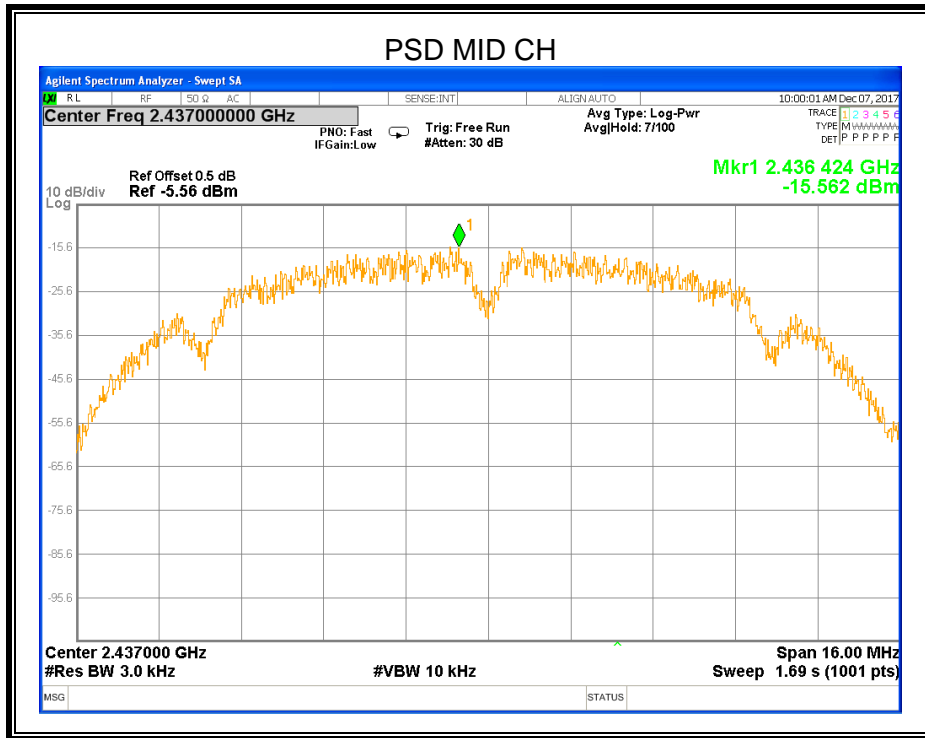



8.4.2. 802.11g MODE

Test Channel	Frequency	Power Spectral Density (dBm/3kHz)	Limit (dBm/3kHz)	Result
Low	2412MHz	-19.067	8	PASS
Middle	2437MHz	-17.559	8	PASS
High	2462MHz	-12.912	8	PASS

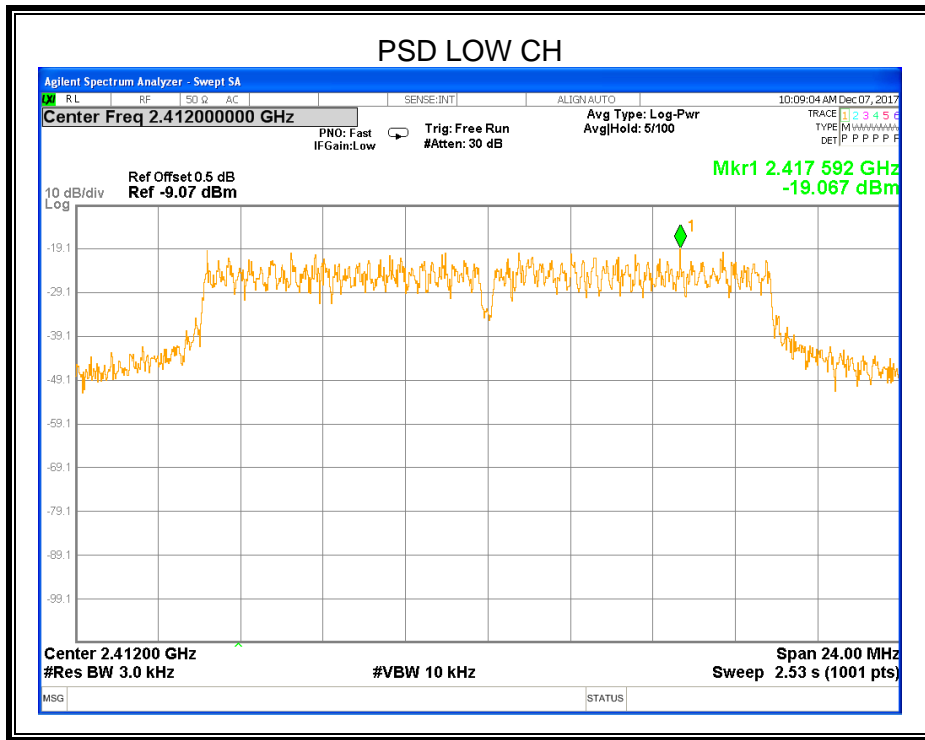

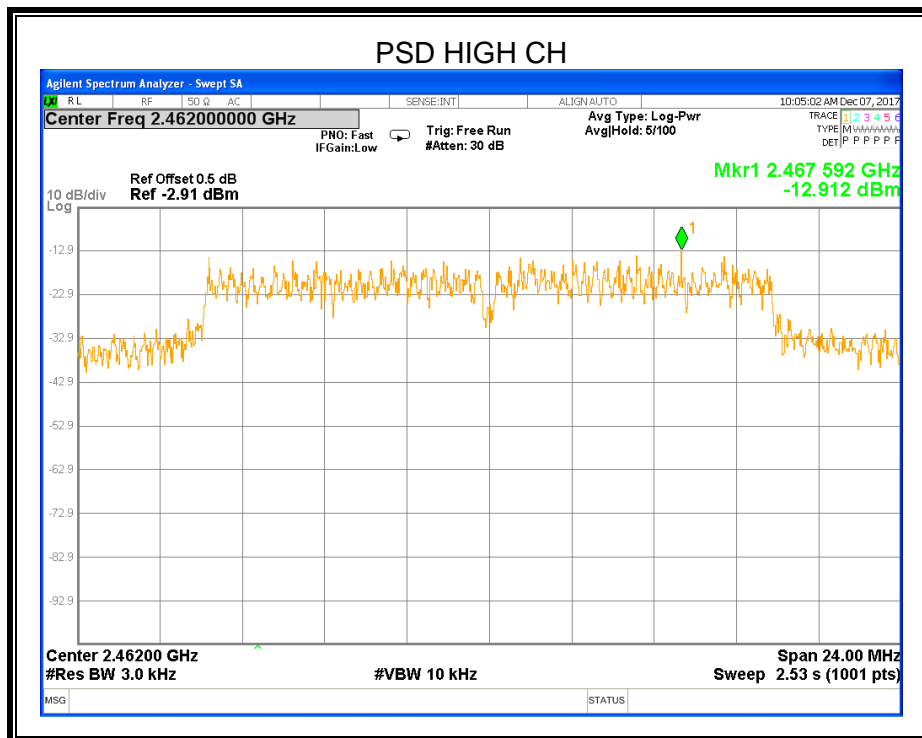
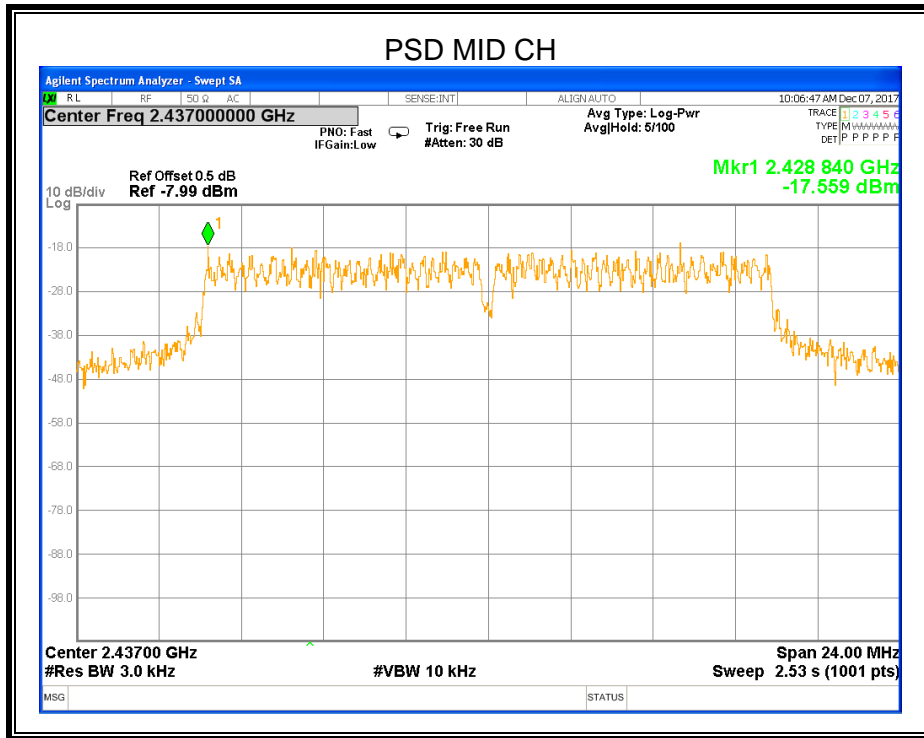



8.4.3. 802.11n HT20 MODE

Test Channel	Frequency	Power Spectral Density (dBm/3kHz)	Limit (dBm/3kHz)	Result
Low	2412MHz	-20.278	8	PASS
Middle	2437MHz	-18.210	8	PASS
High	2462MHz	-16.466	8	PASS

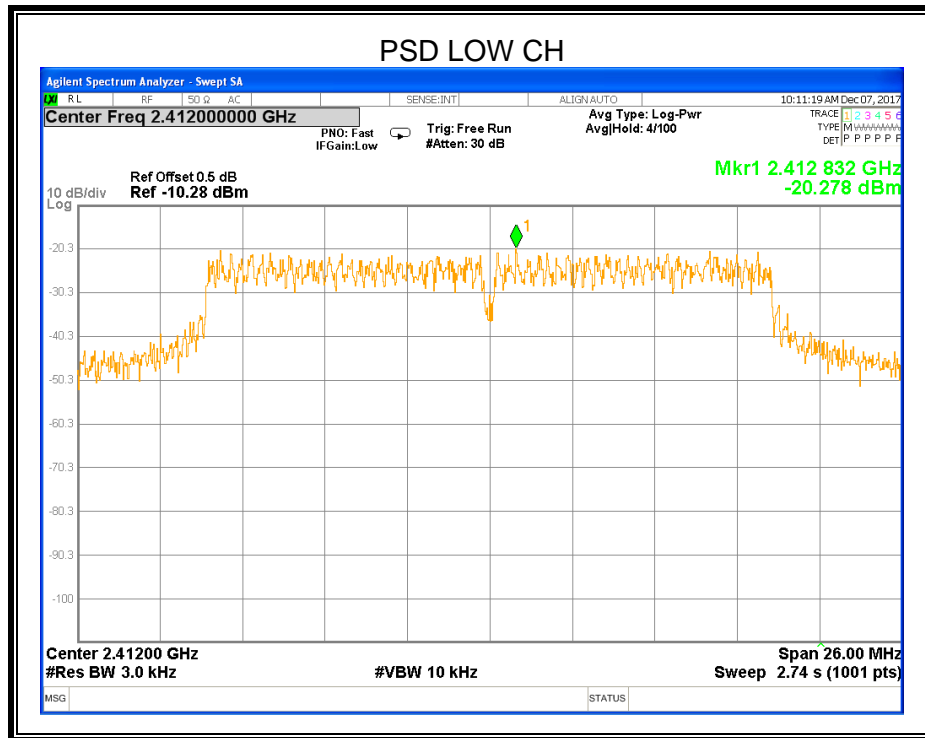

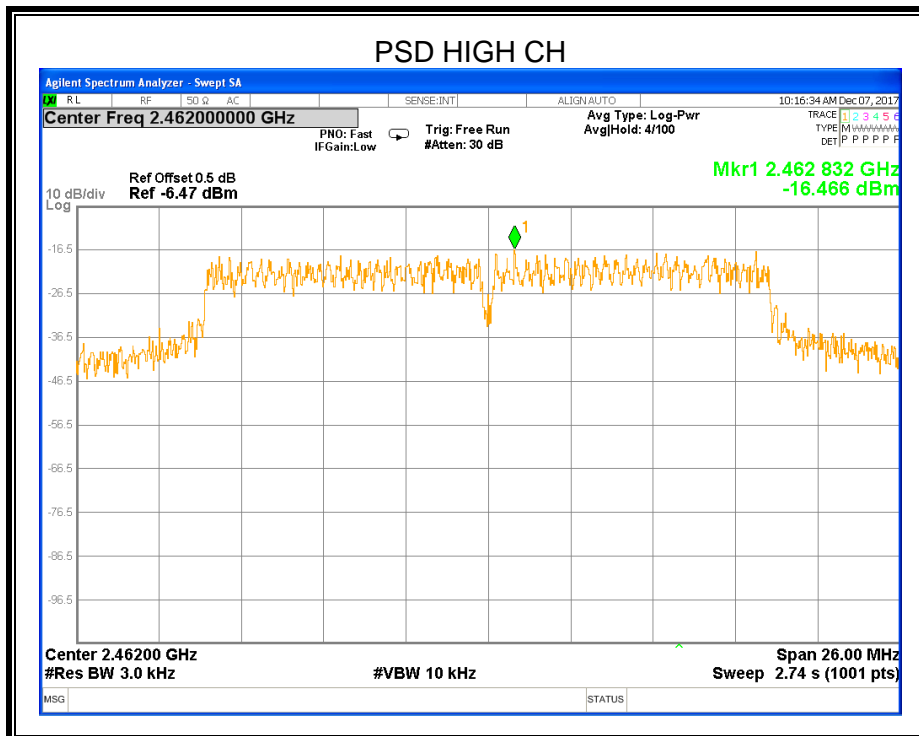
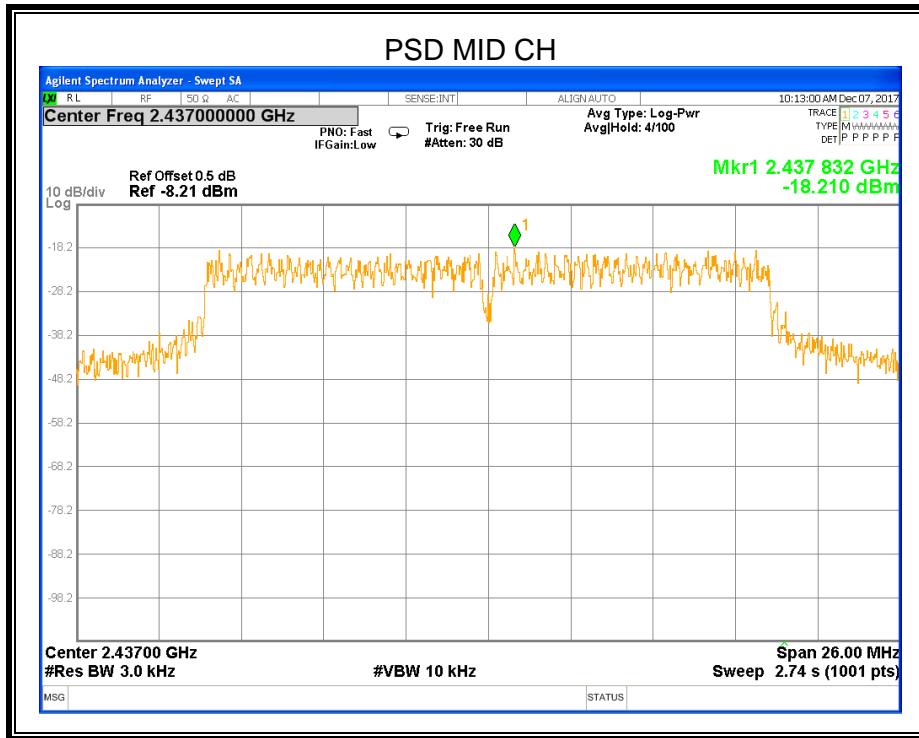



8.5. CONDUCTED BANDEGE AND SPURIOUS EMISSIONS

LIMITS

FCC Part15 (15.247) Subpart C		
Section	Test Item	Limit
FCC §15.247 (d)	Conducted Bandedge and Spurious Emissions	at least 20 dB below that in the 100 kHz bandwidth within the band that contains the highest level of the desired power

TEST PROCEDURE

Connect the UUT to the spectrum analyser and use the following settings:

Center Frequency	The centre frequency of the channel under test
Detector	Peak
RBW	100K
VBW	$\geq 3 \times \text{RBW}$
Span	1.5 x DTS bandwidth
Trace	Max hold
Sweep time	Auto couple.

Use the peak marker function to determine the maximum PSD level.

Span	Set the center frequency and span to encompass frequency range to be measured
Detector	Peak
RBW	100K
VBW	$\geq 3 \times \text{RBW}$
measurement points	$\geq \text{span}/\text{RBW}$
Trace	Max hold
Sweep time	Auto couple.

Use the peak marker function to determine the maximum amplitude level.

TEST SETUP

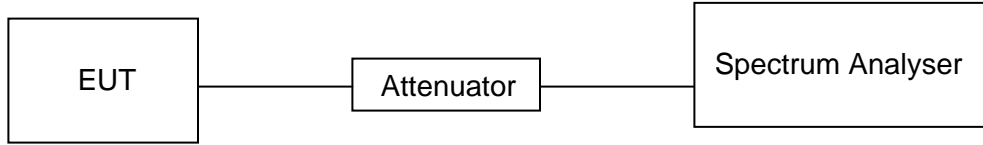

TEST ENVIRONMENT

Temperature	25°C	Relative Humidity	60%
Atmosphere Pressure	101kPa	Test Voltage	AC 120V/60Hz

RESULTS

8.5.1. 802.11b MODE

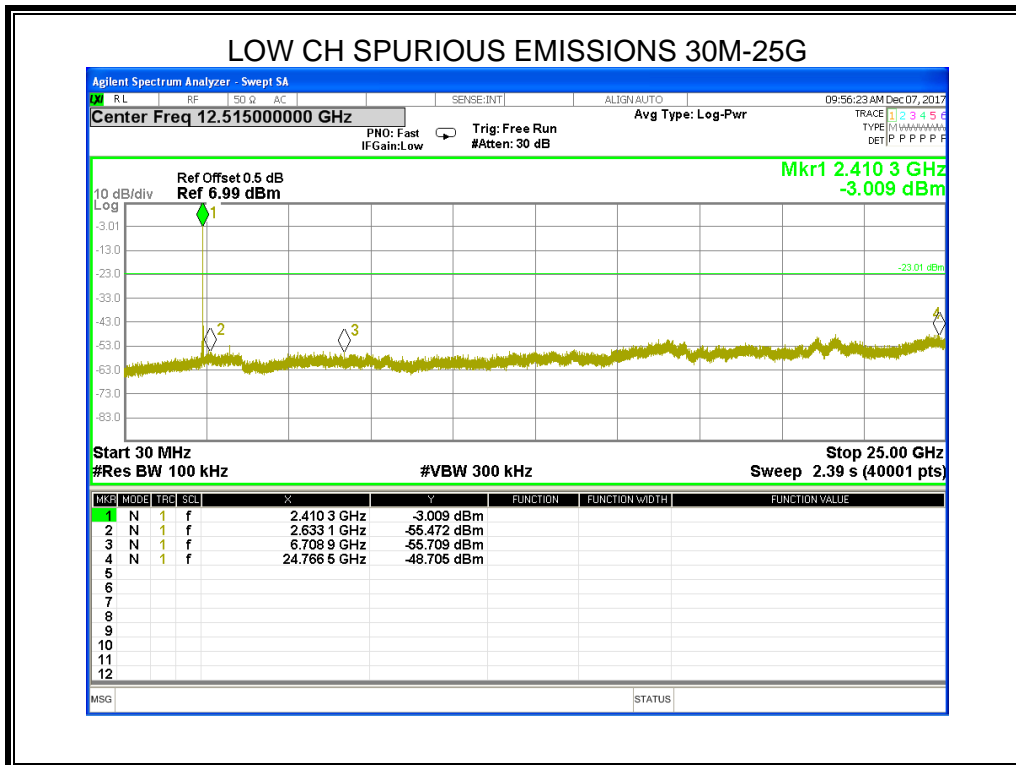

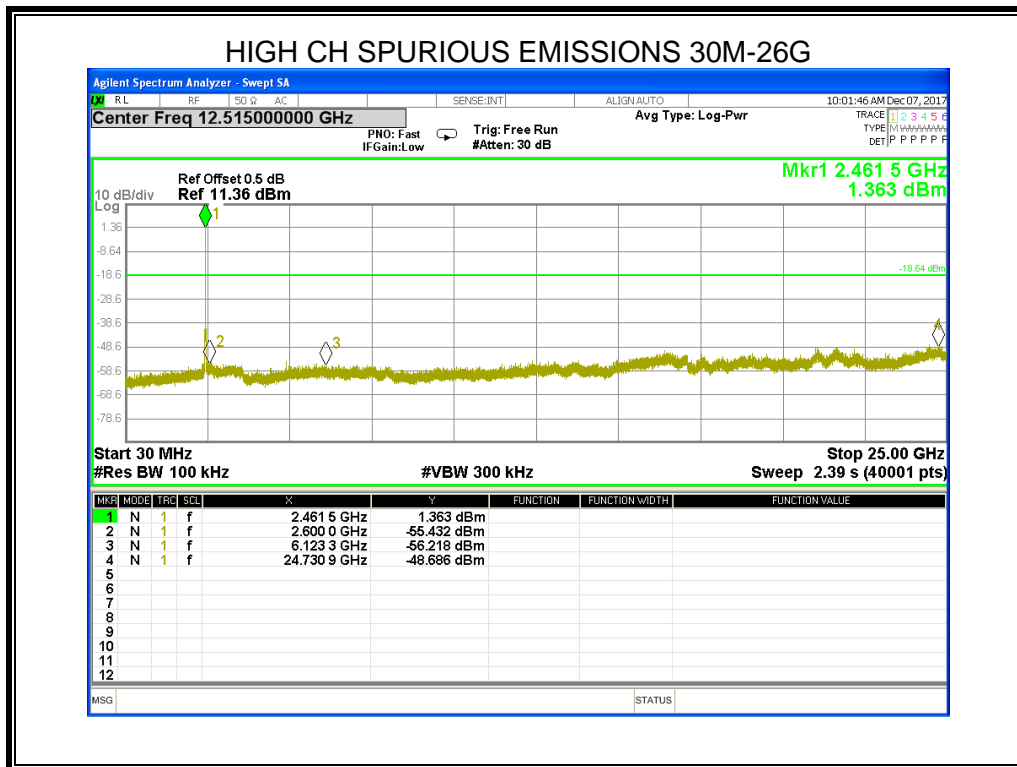
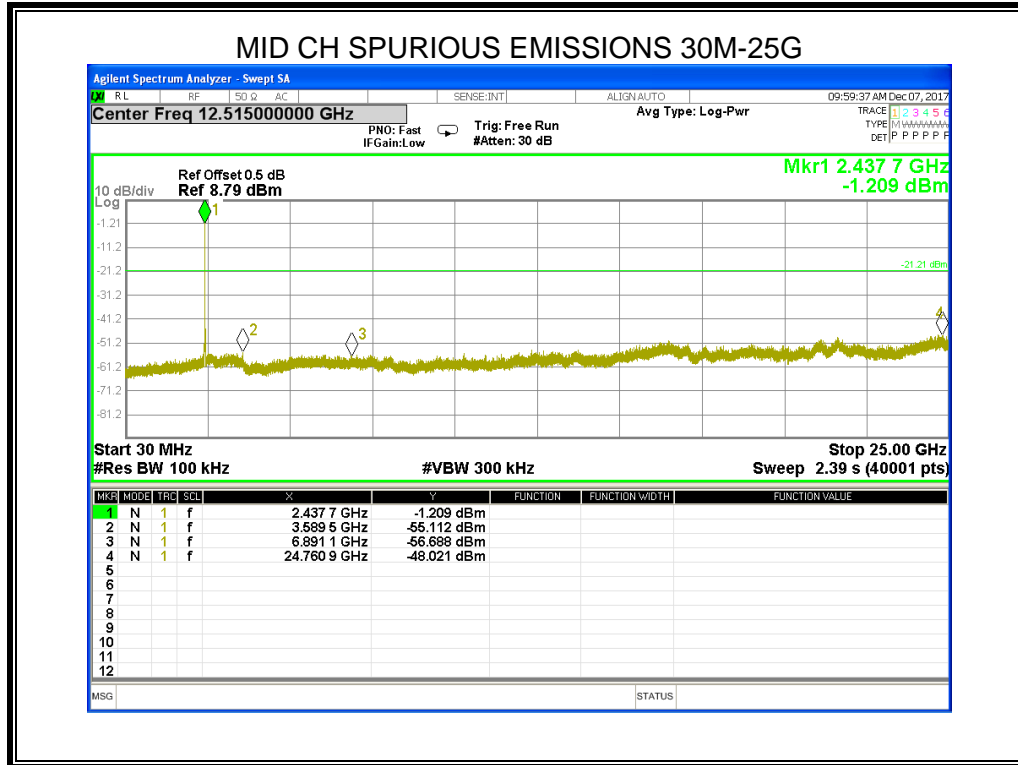

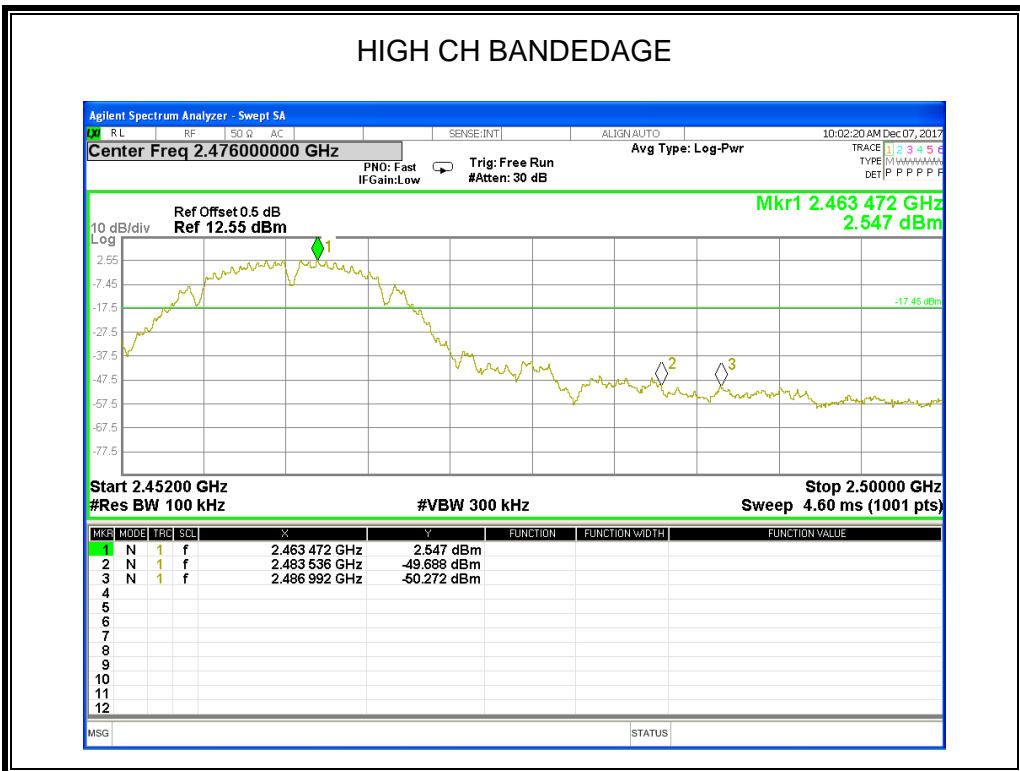
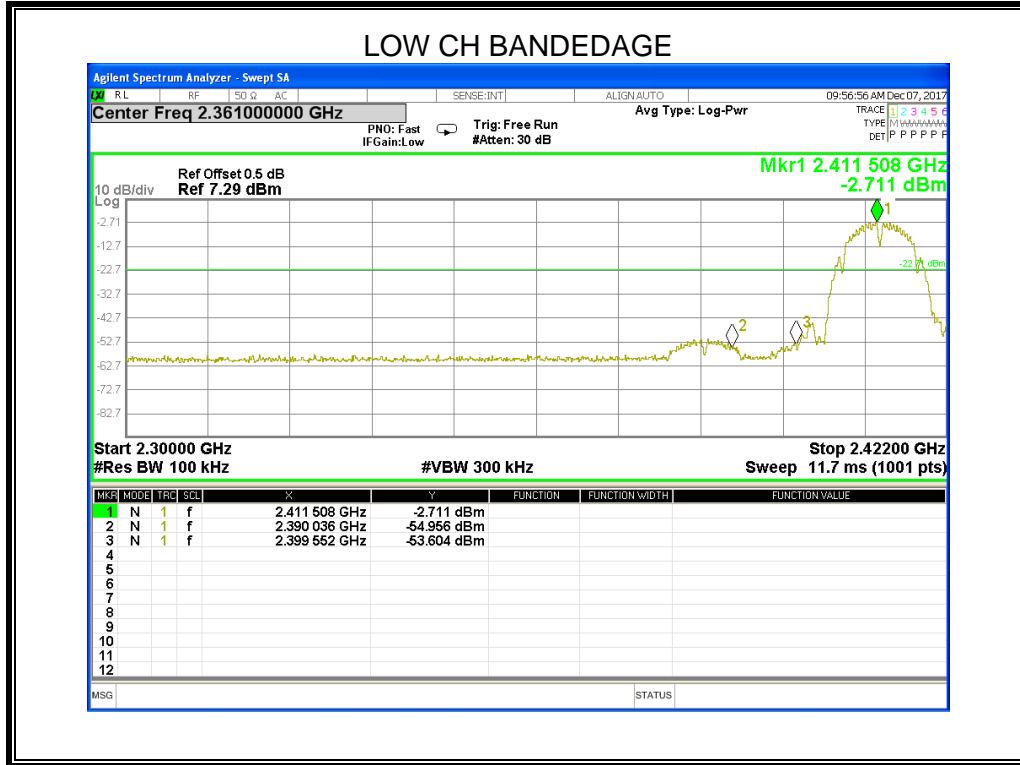



8.5.2. 802.11g MODE

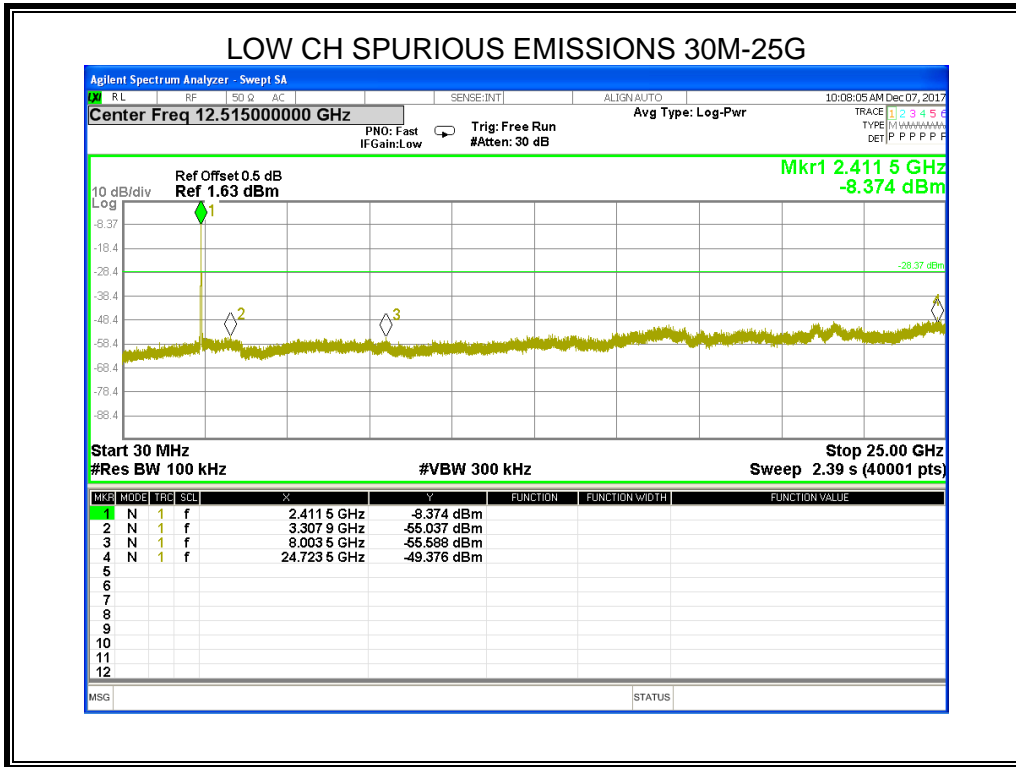

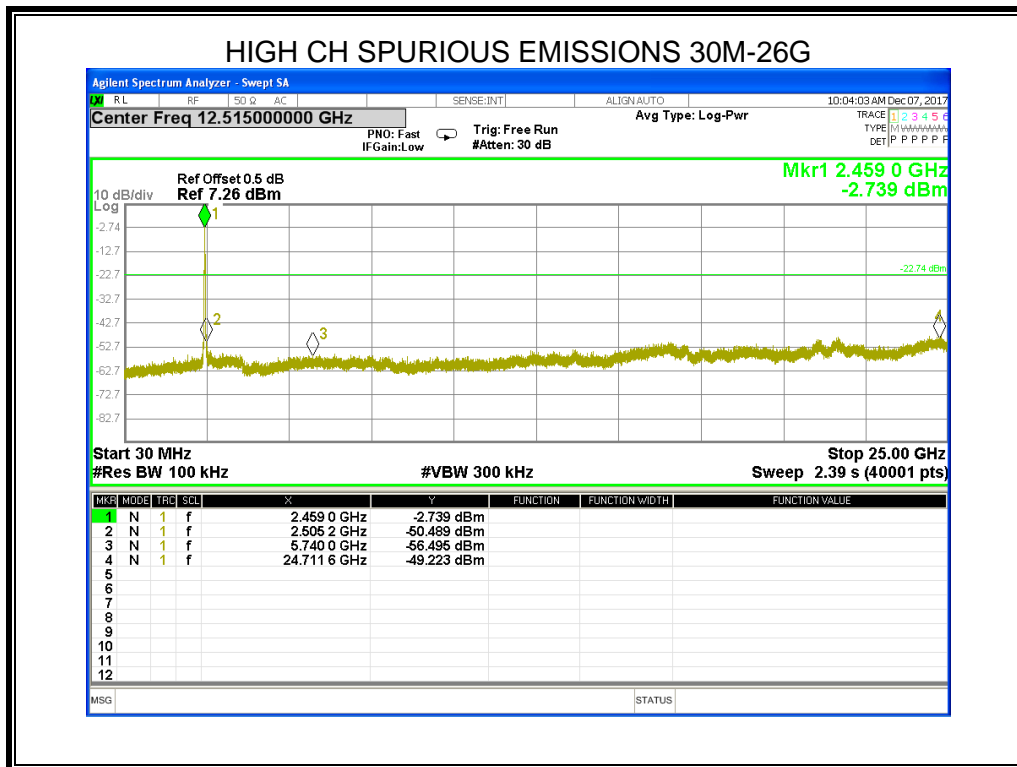
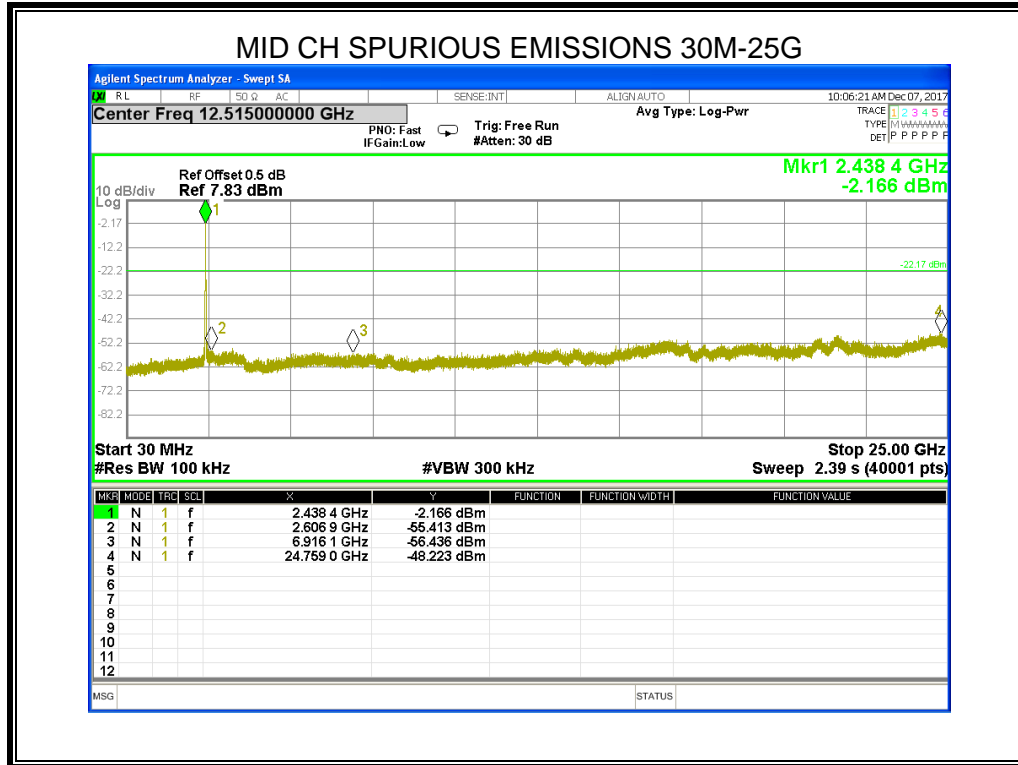

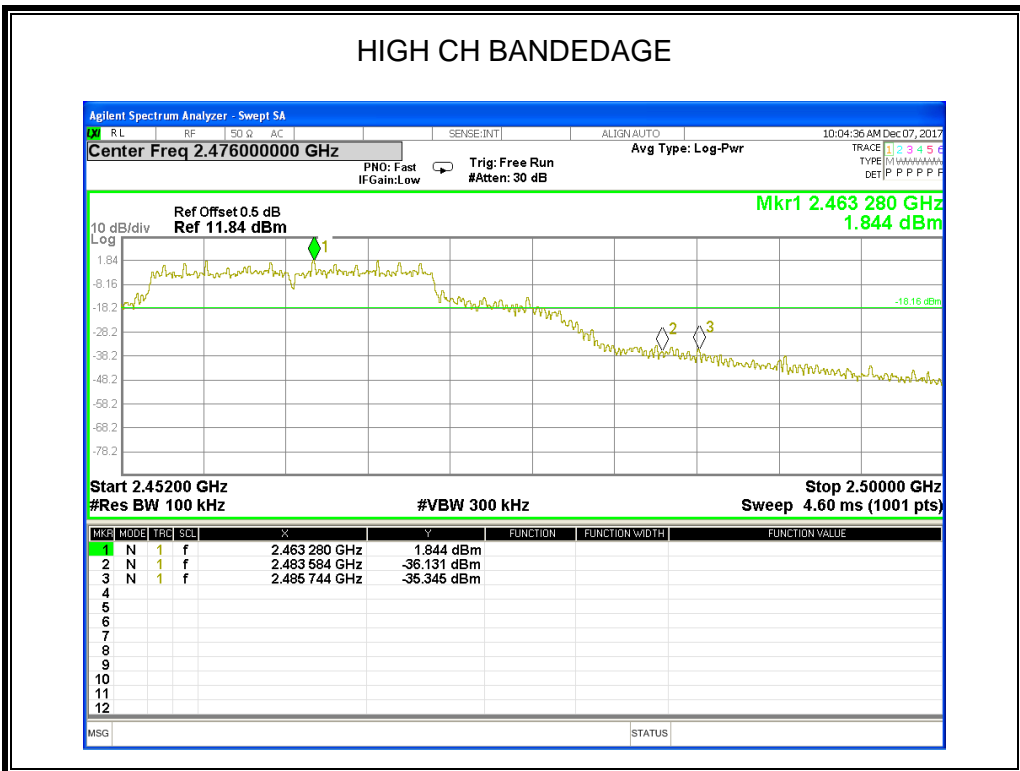
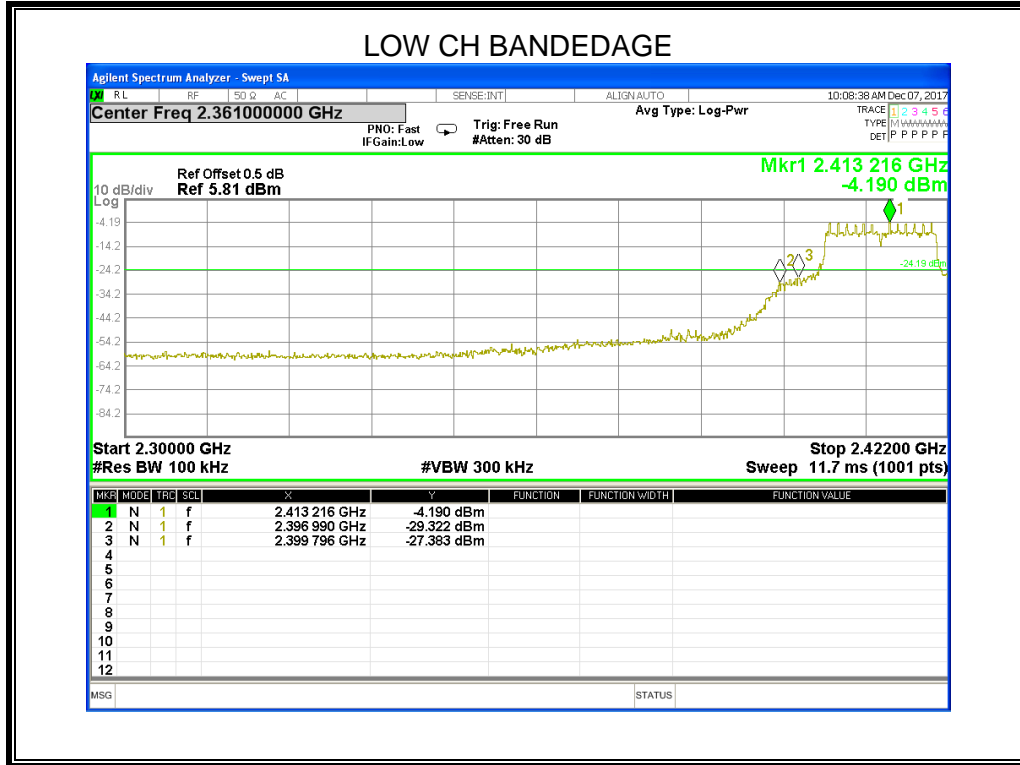



8.5.3. 802.11n HT20 MODE

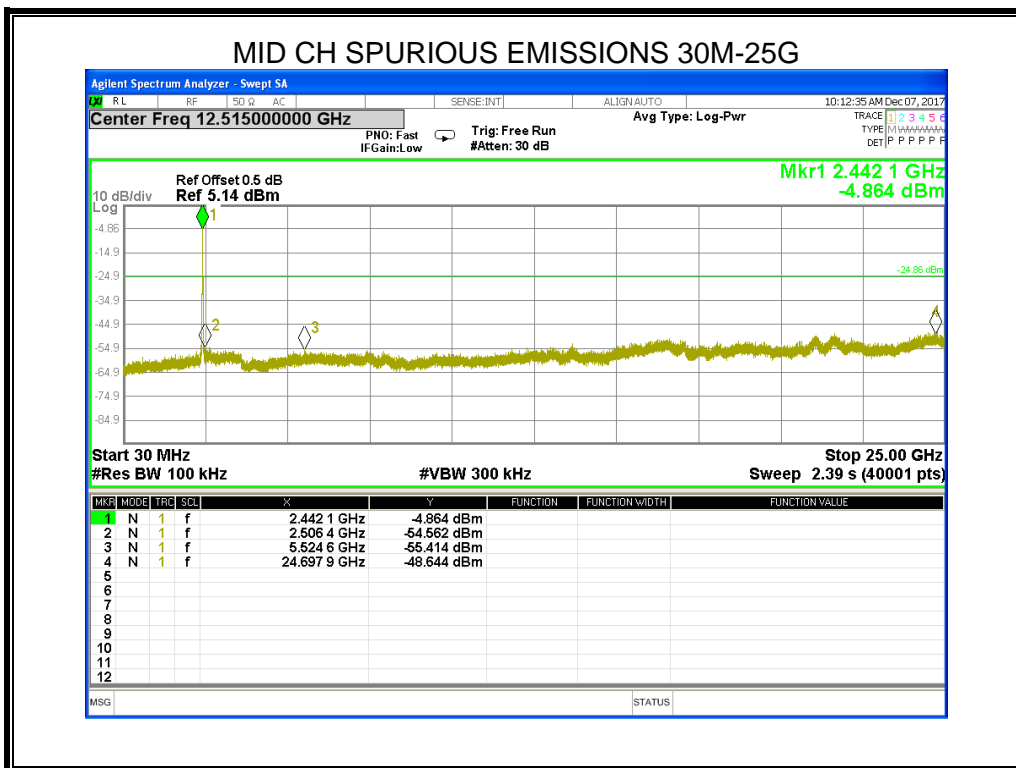
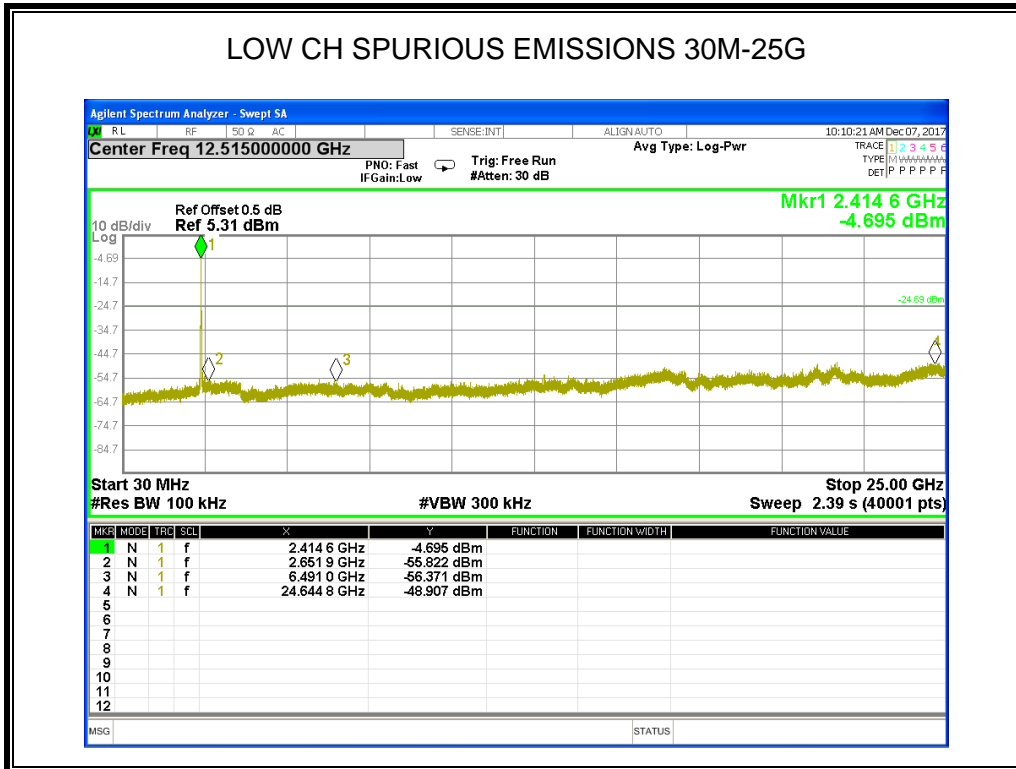



HIGH CH SPURIOUS EMISSIONS 30M-25G

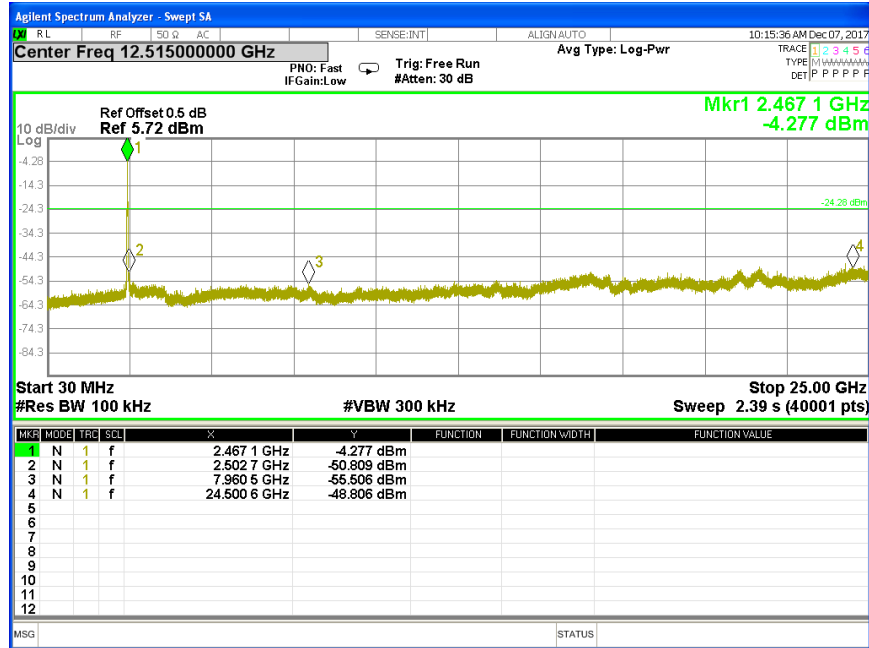



LOW CH BANDEDAGE

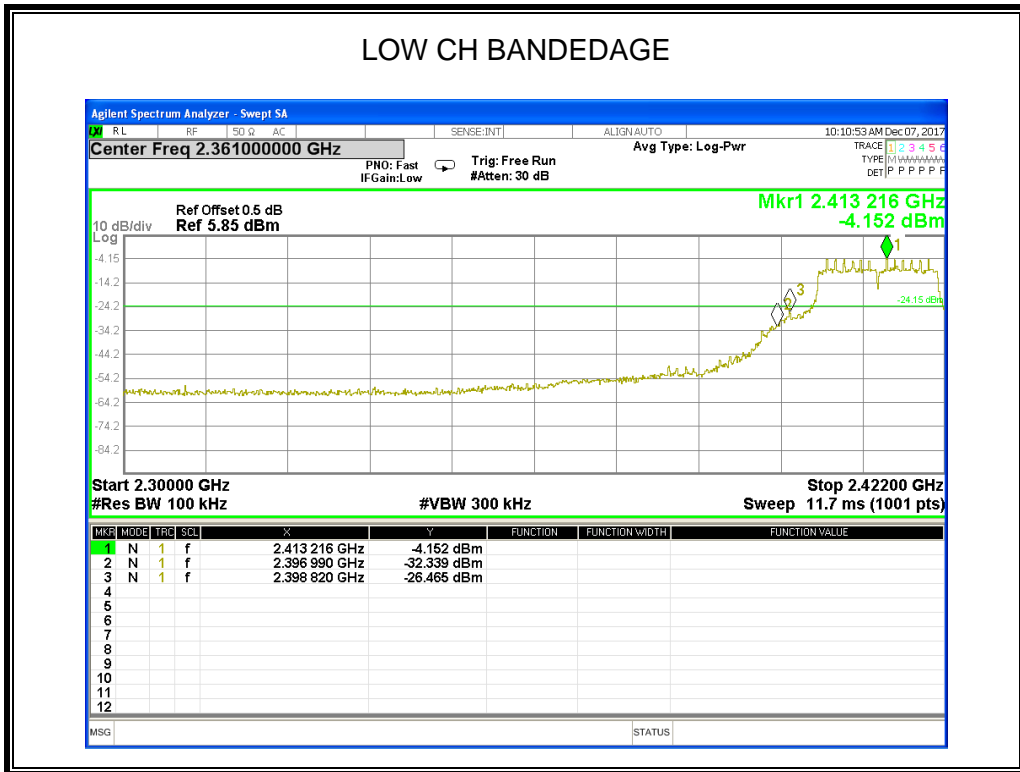

HIGH CH BANDEDAGE

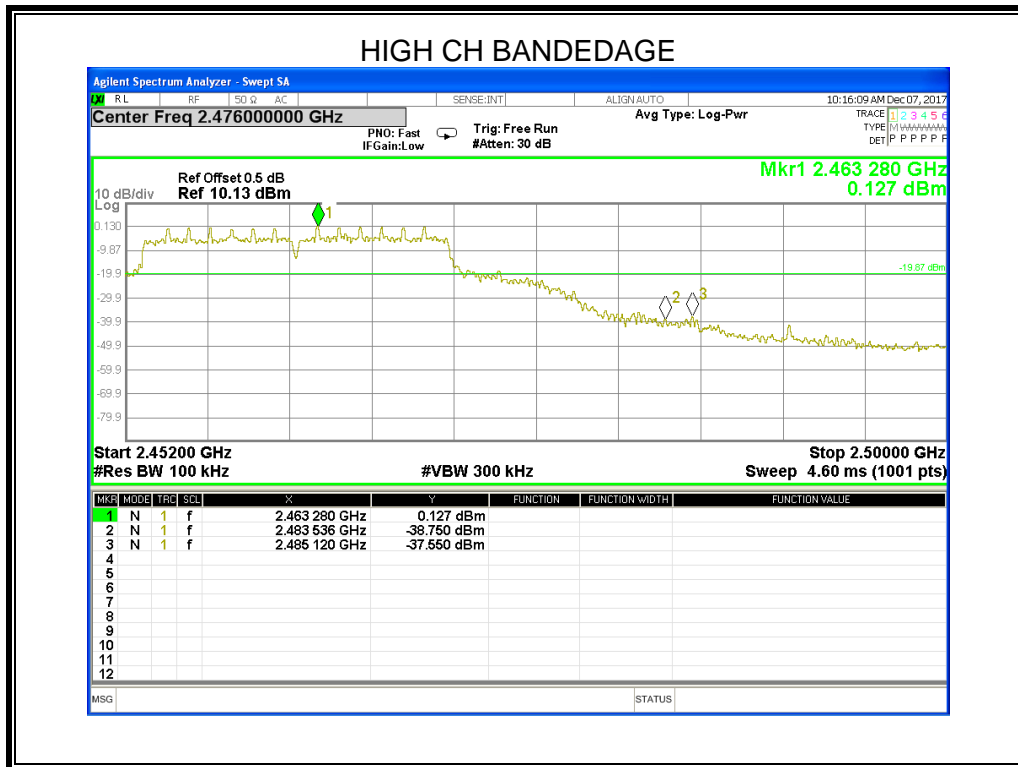



9. RADIATED TEST RESULTS

LIMITS

Please refer to FCC §15.205 and §15.209

Radiation Disturbance Test Limit for FCC (Class B)(9KHz-1GHz)

Frequency (MHz)	Field Strength (microvolts/meter)	Measurement Distance (meters)
0.009~0.490	2400/F(KHz)	300
0.490~1.705	24000/F(KHz)	30
1.705~30.0	30	30
30~88	100	3
88~216	150	3
216~960	200	3
960~1000	500	3

Note: 1) At frequencies at or above 30 MHz, measurements may be performed at a distance other than what is specified provided: measurements are not made in the near field except where it can be shown that near field measurements are appropriate due to the characteristics of the device; and it can be demonstrated that the signal levels needed to be measured at the distance employed can be detected by the measurement equipment. Measurements shall not be performed at a distance greater than 30 meters unless it can be further demonstrated that measurements at a distance of 30 meters or less are impractical. When performing measurements at a distance other than that specified, the results shall be extrapolated to the specified distance using an extrapolation factor of 20 dB/decade (inverse linear-distance for field strength measurements; inverse-linear-distance-squared for power density measurements).

(2) At frequencies below 30 MHz, measurements may be performed at a distance closer than that specified in the regulations; however, an attempt should be made to avoid making measurements in the near field. Pending the development of an appropriate measurement procedure for measurements performed below 30 MHz, when performing measurements at a closer distance than specified, the results shall be extrapolated to the specified distance by either making measurements at a minimum of two distances on at least one radial to determine the proper extrapolation factor or by using the square of an inverse linear distance extrapolation factor (40 dB/decade). This paragraph (f) shall not apply to Access BPL devices operating below 30 MHz.



Radiation Disturbance Test Limit for FCC (Above 1G)

Frequency (MHz)	dB(uV/m) (at 3 meters)	
	Peak	Average
Above 1000	74	54

Restricted bands of operation

MHz	MHz	MHz	GHz
0.090-0.110	16.42-16.423	399.9-410	4.5-5.15
¹ 0.495-0.505	16.69475-16.69525	608-614	5.35-5.46
2.1735-2.1905	16.80425-16.80475	960-1240	7.25-7.75
4.125-4.128	25.5-25.67	1300-1427	8.025-8.5
4.17725-4.17775	37.5-38.25	1435-1626.5	9.0-9.2
4.20725-4.20775	73-74.6	1645.5-1646.5	9.3-9.5
6.215-6.218	74.8-75.2	1660-1710	10.6-12.7
6.26775-6.26825	108-121.94	1718.8-1722.2	13.25-13.4
6.31175-6.31225	123-138	2200-2300	14.47-14.5
8.291-8.294	149.9-150.05	2310-2390	15.35-16.2
8.362-8.366	156.52475-156.52525	2483.5-2500	17.7-21.4
8.37625-8.38675	156.7-156.9	2690-2900	22.01-23.12
8.41425-8.41475	162.0125-167.17	3260-3267	23.6-24.0
12.29-12.293	167.72-173.2	3332-3339	31.2-31.8
12.51975-12.52025	240-285	3345.8-3358	36.43-36.5
12.57675-12.57725	322-335.4	3600-4400	(²)
13.36-13.41			

Note: ¹Until February 1, 1999, this restricted band shall be 0.490-0.510 MHz.
²Above 38.6c

TEST SETUP AND PROCEDURE

Below 30MHz

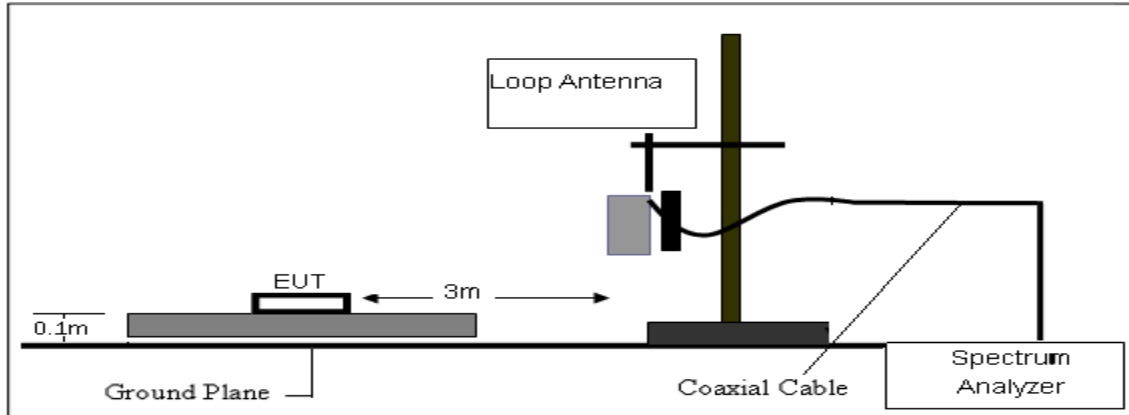

The setting of the spectrum analyser

RBW	200Hz (From 9kHz to 0.15MHz)/ 9KHz (From 0.15MHz to 30MHz)
VBW	200Hz (From 9kHz to 0.15MHz)/ 9KHz (From 0.15MHz to 30MHz)
Sweep	Auto
Detector	Peak/QP/ Average
Trace	Max hold

1. The testing follows the guidelines in ANSI C63.10-2013
2. The EUT was arranged to its worst case and then turntable (from 0 degree to 360 degrees) to find the maximum reading. A pre-amp and a high pass filter are used for the test in order to get better signal level. Both horizontal and vertical polarizations of the antenna are set to make the measurement.
3. The EUT was placed on a turntable with 0.1 meter above ground.
4. The EUT was set 3 meters from the interference receiving antenna, which was mounted on the top of a variable height antenna tower.
5. For measurement below 1GHz, the initial step in collecting conducted emission data is a spectrum analyzer peak detector mode pre-scanning the measurement frequency range. Significant peaks are then marked and then Quasi Peak detector mode re-measured. If the emission level of the EUT measured by the peak detector is 3 dB lower than the applicable limit, the peak emission level will be reported. Otherwise, the emission measurement will be repeated using the quasi-peak detector and reported.
6. For the actual test configuration, please refer to the related item in this test report (Photographs of the Test Configuration)

Below 1G

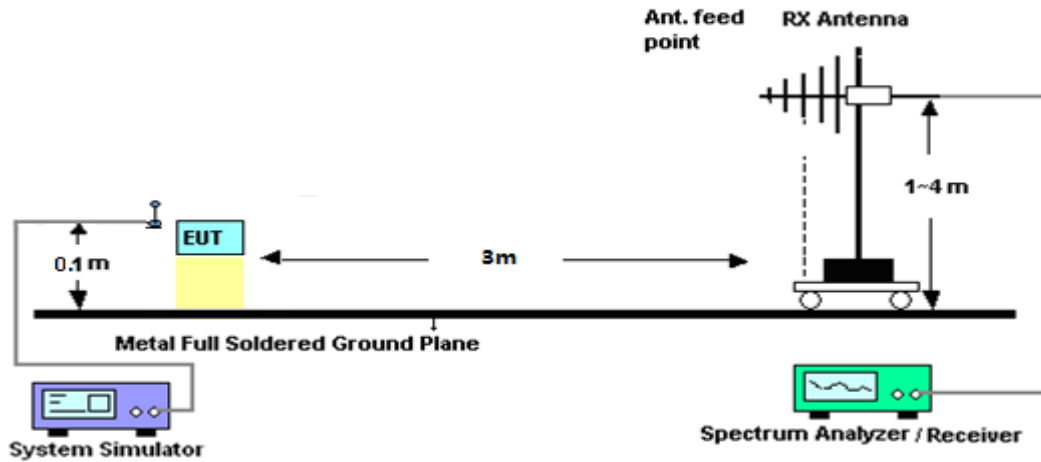

The setting of the spectrum analyser

RBW	120K
VBW	300K
Sweep	Auto
Detector	Peak/QP
Trace	Max hold

1. The testing follows the guidelines in ANSI C63.10-2013.
2. The EUT was arranged to its worst case and then tune the antenna tower (from 1 m to 4 m) and turntable (from 0 degree to 360 degrees) to find the maximum reading. A pre-amp and a high pass filter are used for the test in order to get better signal level. Both horizontal and vertical polarizations of the antenna are set to make the measurement.
3. The EUT was placed on a turntable with 0.1 meter above ground.
4. The EUT was set 3 meters from the interference receiving antenna, which was mounted on the top of a variable height antenna tower.
5. For measurement below 1GHz, the initial step in collecting conducted emission data is a spectrum analyzer peak detector mode pre-scanning the measurement frequency range. Significant peaks are then marked and then Quasi Peak detector mode re-measured. If the emission level of the EUT measured by the peak detector is 3 dB lower than the applicable limit, the peak emission level will be reported. Otherwise, the emission measurement will be repeated using the quasi-peak detector and reported.
6. For the actual test configuration, please refer to the related Item in this test report (Photographs of the Test Configuration)

ABOVE 1G

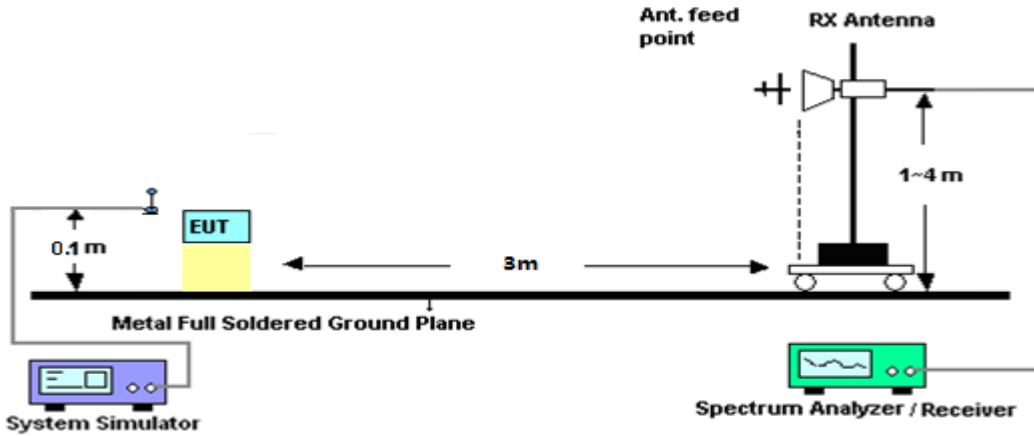

The setting of the spectrum analyser

RBW	1M
VBW	PEAK: 3M AVG: see note 6
Sweep	Auto
Detector	Peak
Trace	Max hold

1. The testing follows the guidelines in ANSI C63.10-2013.
2. The EUT was arranged to its worst case and then tune the antenna tower (from 1 m to 4 m) and turntable (from 0 degree to 360 degrees) to find the maximum reading. A pre-amp and a high pass filter are used for the test in order to get better signal level. Both horizontal and vertical polarizations of the antenna are set to make the measurement.
3. The EUT was placed on a turntable with 0.1m above ground.
4. The EUT was set 3 meters from the interference receiving antenna, which was mounted on the top of a variable height antenna tower.
5. For measurement above 1GHz, the emission measurement will be measured by the peak detector. This peak level, once corrected, must comply with the limit specified in Section 15.209.
6. For measurements above 1 GHz the resolution bandwidth is set to 1 MHz, then the video bandwidth is set to 3 MHz for peak measurements and 1 MHz resolution bandwidth with 1/T video bandwidth with peak detector for average measurements.
7. For the actual test configuration, please refer to the related item in this test report (Photographs of the Test Configuration)

X axis, Y axis, Z axis positions:

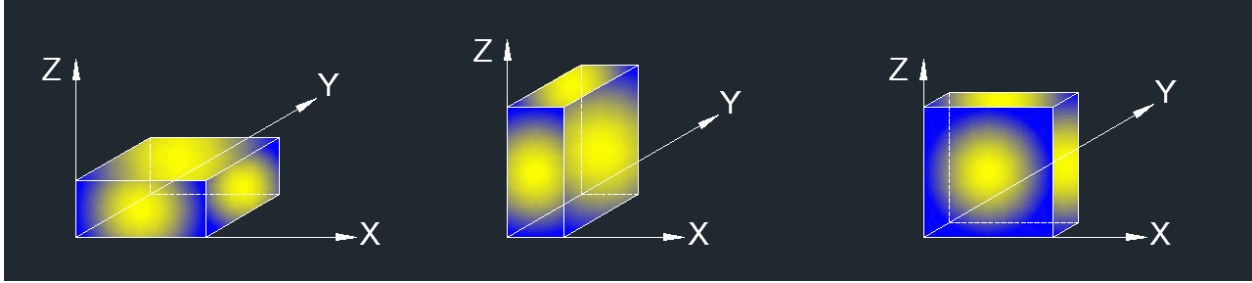

8.The EUT as shown in Figure 1 is the worst mode, the report only shown the worst mode data.

TEST ENVIRONMENT

Temperature	25°C	Relative Humidity	60%
Atmosphere Pressure	101kPa	Test Voltage	AC 120V/60Hz



9.1. RESTRICTED BANDEDGE

Frequency (MHz)	Reading (dBµV)	Amplifier (dB)	Loss (dB)	Antenna Factor (dB/m)	Corrected Factor (dB)	Emission Level (dBµV/m)	Limits (dBµV/m)	Margin (dB)	Detector Type	Comment
802.11b										
2390.00	68.08	43.80	4.91	25.90	-12.99	55.09	74.00	-18.91	PK	Vertical
2390.00	53.97	43.80	4.91	25.90	-12.99	40.98	54.00	-13.02	AV	Vertical
2390.00	69.49	43.80	4.91	25.90	-12.99	56.50	74.00	-17.50	PK	Horizontal
2390.00	52.21	43.80	4.91	25.90	-12.99	39.22	54.00	-14.78	AV	Horizontal
2483.50	69.43	43.80	5.12	25.90	-12.78	56.65	74.00	-17.35	PK	Vertical
2483.50	53.18	43.80	5.12	25.90	-12.78	40.40	54.00	-13.60	AV	Vertical
2483.50	69.49	43.80	5.12	25.90	-12.78	56.71	74.00	-17.29	PK	Horizontal
2483.50	53.06	43.80	5.12	25.90	-12.78	40.28	54.00	-13.72	AV	Horizontal
802.11g										
2390.00	67.01	43.80	4.91	25.90	-12.99	54.02	74.00	-19.98	PK	Vertical
2390.00	53.38	43.80	4.91	25.90	-12.99	40.39	54.00	-13.61	AV	Vertical
2390.00	65.70	43.80	4.91	25.90	-12.99	52.71	74.00	-21.29	PK	Horizontal
2390.00	53.97	43.80	4.91	25.90	-12.99	40.98	54.00	-13.02	AV	Horizontal
2483.50	65.27	43.80	5.12	25.90	-12.78	52.49	74.00	-21.51	PK	Vertical
2483.50	52.27	43.80	5.12	25.90	-12.78	39.49	54.00	-14.51	AV	Vertical
2483.50	65.82	43.80	5.12	25.90	-12.78	53.04	74.00	-20.96	PK	Horizontal
2483.50	52.48	43.80	5.12	25.90	-12.78	39.70	54.00	-14.30	AV	Horizontal
802.11n20										
2390.00	65.95	43.80	4.91	25.90	-12.99	52.96	74.00	-21.04	PK	Vertical
2390.00	53.36	43.80	4.91	25.90	-12.99	40.37	54.00	-13.63	AV	Vertical
2390.00	65.58	43.80	4.91	25.90	-12.99	52.59	74.00	-21.41	PK	Horizontal
2390.00	53.93	43.80	4.91	25.90	-12.99	40.94	54.00	-13.06	AV	Horizontal
2483.50	65.28	43.80	5.12	25.90	-12.78	52.50	74.00	-21.50	PK	Vertical
2483.50	52.34	43.80	5.12	25.90	-12.78	39.56	54.00	-14.44	AV	Vertical
2483.50	65.52	43.80	5.12	25.90	-12.78	52.74	74.00	-21.26	PK	Horizontal
2483.50	52.36	43.80	5.12	25.90	-12.78	39.58	54.00	-14.42	AV	Horizontal
<p>Remark: Factor = Antenna Factor + Cable Loss – Pre-amplifier. Low measurement frequencies is range from 2300 to 2412 MHz, high measurement frequencies is range from 2462 to 2500 MHz. Only show the worst point data of the emissions in the frequency 2300-2412 MHz and 2462-2500 MHz. Video bandwidth for average measurements is 1KHz.</p>										



9.2. SPURIOUS EMISSIONS (9KHz-30MHz)

Freq.	Reading	Limit	Margin	State
(MHz)	(dBuV/m)	(dBuV/m)	(dB)	P/F
--	--	--	--	PASS
--	--	--	--	PASS

Note:

The amplitude of spurious emissions which are attenuated by more than 20dB below the permissible value has no need to be reported.

Distance extrapolation factor = $40 \log(\text{specific distance}/\text{test distance})$ (dB);

Limit line = specific limits(dBuv) + distance extrapolation factor.



9.3. SPURIOUS EMISSIONS (30-1GHz)

HARMONICS AND SPURIOUS EMISSIONS (HORIZONTAL)

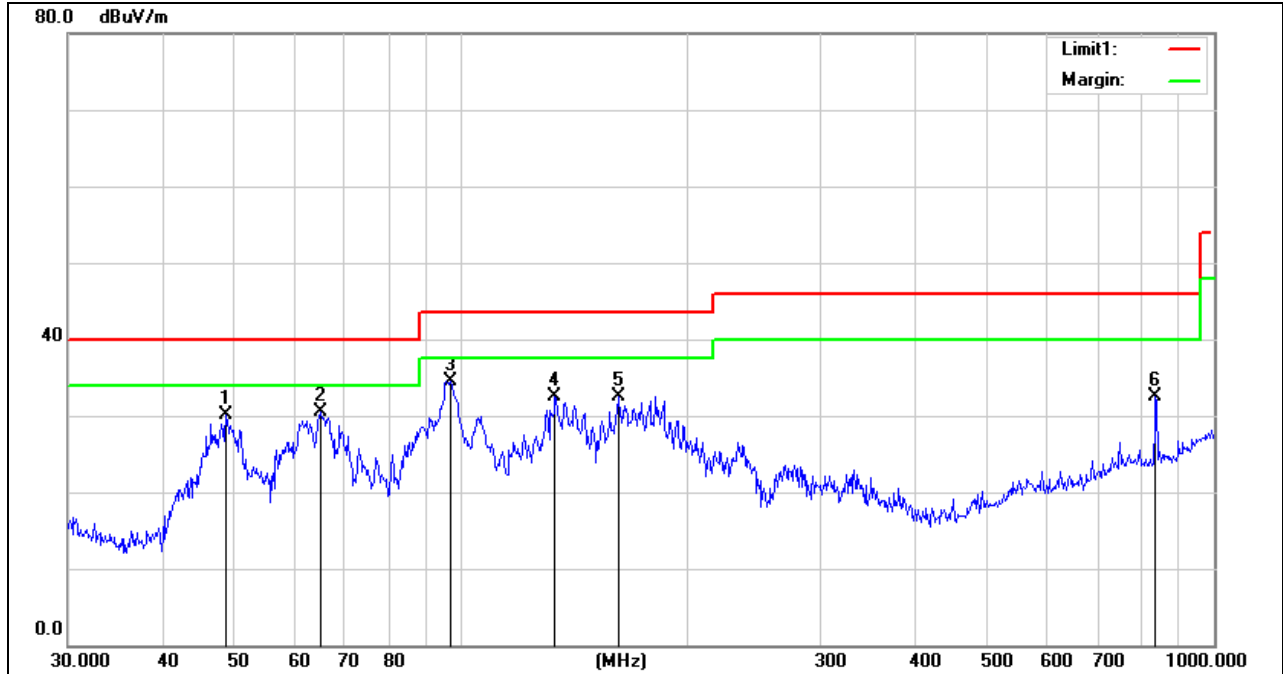

No.	Frequency (MHz)	Reading (dBuV/m)	Correct dB/m	Result (dBuV/m)	Limit (dBuV/m)	Margin (dB)	Remark
1	48.6720	50.86	-20.80	30.06	40.00	-9.94	QP
2	65.1145	54.67	-24.22	30.45	40.00	-9.55	QP
3	96.7750	54.04	-19.52	34.52	43.50	-8.98	QP
4	133.1511	50.07	-17.54	32.53	43.50	-10.97	QP
5	161.4742	51.19	-18.62	32.57	43.50	-10.93	QP
6	836.2441	35.37	-2.89	32.48	46.00	-13.52	QP

Note: Measurement = Reading Level + Correct Factor.



HARMONICS AND SPURIOUS EMISSIONS (VERTICAL)

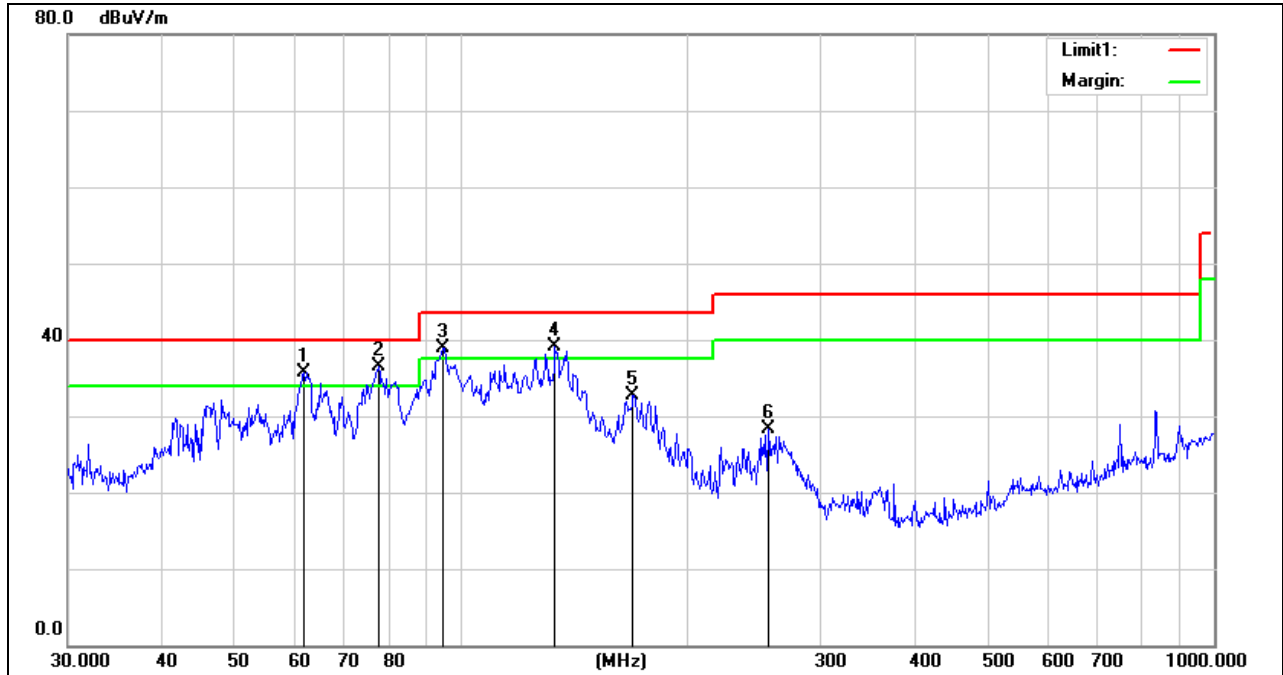

No.	Frequency (MHz)	Reading (dBuV/m)	Correct (dB/m)	Result (dBuV/m)	Limit (dBuV/m)	Margin (dB)	Remark
1	61.7781	60.07	-24.30	35.77	40.00	-4.23	QP
2	77.5926	59.58	-23.03	36.55	40.00	-3.45	QP
3	94.4282	58.72	-19.75	38.97	43.50	-4.53	QP
4	133.1511	56.60	-17.54	39.06	43.50	-4.44	QP
5	169.0054	51.95	-19.24	32.71	43.50	-10.79	QP
6	255.6230	44.00	-15.62	28.38	46.00	-17.62	QP

Note: Measurement = Reading Level + Correct Factor.



9.4. SPURIOUS EMISSIONS (Above 1GHz)

802.11b Low Channel

Frequency (MHz)	Reading (dBµV)	Amplifier (dB)	Loss (dB)	Antenna Factor (dB/m)	Corrected Factor (dB)	Emission Level (dBµV/m)	Limits (dBµV/m)	Margin (dB)	Detector Type	Comment
Low Channel (2412 MHz)										
3264.85	48.37	44.70	6.70	28.20	-9.80	38.57	74.00	-35.43	PK	Vertical
3264.85	37.98	44.70	6.70	28.20	-9.80	28.18	54.00	-25.82	AV	Vertical
3264.85	49.04	44.70	6.70	28.20	-9.80	39.24	74.00	-34.76	PK	Horizontal
3264.85	37.98	44.70	6.70	28.20	-9.80	28.18	54.00	-25.82	AV	Horizontal
4824.28	59.17	44.20	9.04	31.60	-3.56	55.61	74.00	-18.39	PK	Vertical
4824.28	38.59	44.20	9.04	31.60	-3.56	35.03	54.00	-18.97	AV	Vertical
4824.31	58.59	44.20	9.04	31.60	-3.56	55.03	74.00	-18.97	PK	Horizontal
4824.31	38.33	44.20	9.04	31.60	-3.56	34.77	54.00	-19.23	AV	Horizontal
5359.65	46.15	44.20	9.86	32.00	-2.34	43.81	74.00	-30.19	PK	Vertical
5359.65	38.24	44.20	9.86	32.00	-2.34	35.90	54.00	-18.10	AV	Vertical
5359.79	46.16	44.20	9.86	32.00	-2.34	43.82	74.00	-30.18	PK	Horizontal
5359.79	38.44	44.20	9.86	32.00	-2.34	36.10	54.00	-17.90	AV	Horizontal
7235.73	51.00	43.50	11.40	35.50	3.40	54.40	74.00	-19.60	PK	Vertical
7235.73	33.25	43.50	11.40	35.50	3.40	36.65	54.00	-17.35	AV	Vertical
7235.78	51.27	43.50	11.40	35.50	3.40	54.67	74.00	-19.33	PK	Horizontal
7235.83	50.79	43.50	11.40	35.50	3.40	36.02	54.00	-17.98	AV	Horizontal



802.11b Mid Channel

Frequency (MHz)	Reading (dBµV)	Amplifier (dB)	Loss (dB)	Antenna Factor (dB/m)	Corrected Factor (dB)	Emission Level (dBµV/m)	Limits (dBµV/m)	Margin (dB)	Detector Type	Comment
Mid Channel (2437 MHz)										
3264.80	47.84	44.70	6.70	28.20	-9.80	38.04	74.00	-35.96	PK	Vertical
3264.80	37.97	44.70	6.70	28.20	-9.80	28.17	54.00	-25.83	AV	Vertical
3264.77	48.55	44.70	6.70	28.20	-9.80	38.75	74.00	-35.25	PK	Horizontal
3264.77	38.51	44.70	6.70	28.20	-9.80	28.71	54.00	-25.29	AV	Horizontal
4874.47	59.45	44.20	9.04	31.60	-3.56	55.89	74.00	-18.11	PK	Vertical
4874.47	39.06	44.20	9.04	31.60	-3.56	35.50	54.00	-18.50	AV	Vertical
4874.54	58.31	44.20	9.04	31.60	-3.56	54.75	74.00	-19.25	PK	Horizontal
4874.54	38.84	44.20	9.04	31.60	-3.56	35.28	54.00	-18.72	AV	Horizontal
5359.77	46.24	44.20	9.86	32.00	-2.34	43.90	74.00	-30.10	PK	Vertical
5359.77	37.03	44.20	9.86	32.00	-2.34	34.69	54.00	-19.31	AV	Vertical
5359.58	45.49	44.20	9.86	32.00	-2.34	43.15	74.00	-30.85	PK	Horizontal
5359.58	37.59	44.20	9.86	32.00	-2.34	35.25	54.00	-18.75	AV	Horizontal
7310.74	51.07	43.50	11.40	35.50	3.40	54.47	74.00	-19.53	PK	Vertical
7310.74	32.62	43.50	11.40	35.50	3.40	36.02	54.00	-17.98	AV	Vertical
7310.96	51.52	43.50	11.40	35.50	3.40	54.92	74.00	-19.08	PK	Horizontal
7310.96	32.90	43.50	11.40	35.50	3.40	36.30	54.00	-17.70	AV	Horizontal



802.11b High Channel

Frequency (MHz)	Reading (dBµV)	Amplifier (dB)	Loss (dB)	Antenna Factor (dB/m)	Corrected Factor (dB)	Emission Level (dBµV/m)	Limits (dBµV/m)	Margin (dB)	Detector Type	Comment
High Channel (2462 MHz)										
3264.65	49.15	44.70	6.70	28.20	-9.80	39.35	74.00	-34.65	PK	Vertical
3264.65	37.97	44.70	6.70	28.20	-9.80	28.17	54.00	-25.83	AV	Vertical
3264.65	48.84	44.70	6.70	28.20	-9.80	39.04	74.00	-34.96	PK	Horizontal
3264.65	37.91	44.70	6.70	28.20	-9.80	28.11	54.00	-25.89	AV	Horizontal
4924.53	58.22	44.20	9.04	31.60	-3.56	54.66	74.00	-19.34	PK	Vertical
4924.53	38.16	44.20	9.04	31.60	-3.56	34.60	54.00	-19.40	AV	Vertical
4924.54	59.37	44.20	9.04	31.60	-3.56	55.81	74.00	-18.19	PK	Horizontal
4924.54	39.29	44.20	9.04	31.60	-3.56	35.73	54.00	-18.27	AV	Horizontal
5359.67	45.40	44.20	9.86	32.00	-2.34	43.06	74.00	-30.94	PK	Vertical
5359.67	37.30	44.20	9.86	32.00	-2.34	34.96	54.00	-19.04	AV	Vertical
5359.62	45.53	44.20	9.86	32.00	-2.34	43.19	74.00	-30.81	PK	Horizontal
5359.62	37.96	44.20	9.86	32.00	-2.34	35.62	54.00	-18.38	AV	Horizontal
7385.72	51.27	43.50	11.40	35.50	3.40	54.67	74.00	-19.33	PK	Vertical
7385.72	33.29	43.50	11.40	35.50	3.40	36.69	54.00	-17.31	AV	Vertical
7385.83	51.89	43.50	11.40	35.50	3.40	55.29	74.00	-18.71	PK	Horizontal
7385.83	33.78	43.50	11.40	35.50	3.40	37.18	54.00	-16.82	AV	Horizontal

Remark:

- Factor = Antenna Factor + Cable Loss – Pre-amplifier.
- Scan with 802.11b, 802.11g, 802.11n (HT-20) the worst case is 802.11b.
Emission Level = Reading + Factor
Margin = Limit - Emission Level
- The frequency emission of peak points that did not show above the forms are at least 20dB below the limit, the frequency emission is mainly from the environment noise.
- Video bandwidth for average measurements is 1KHz.

10. AC POWER LINE CONDUCTED EMISSIONS

LIMITS

Please refer to FCC §15.207 (a)

FREQUENCY (MHz)	Class A (dBuV)		Class B (dBuV)	
	Quasi-peak	Average	Quasi-peak	Average
0.15 -0.5	79.00	66.00	66 - 56 *	56 - 46 *
0.50 -5.0	73.00	60.00	56.00	46.00
5.0 -30.0	73.00	60.00	60.00	50.00

TEST SETUP AND PROCEDURE

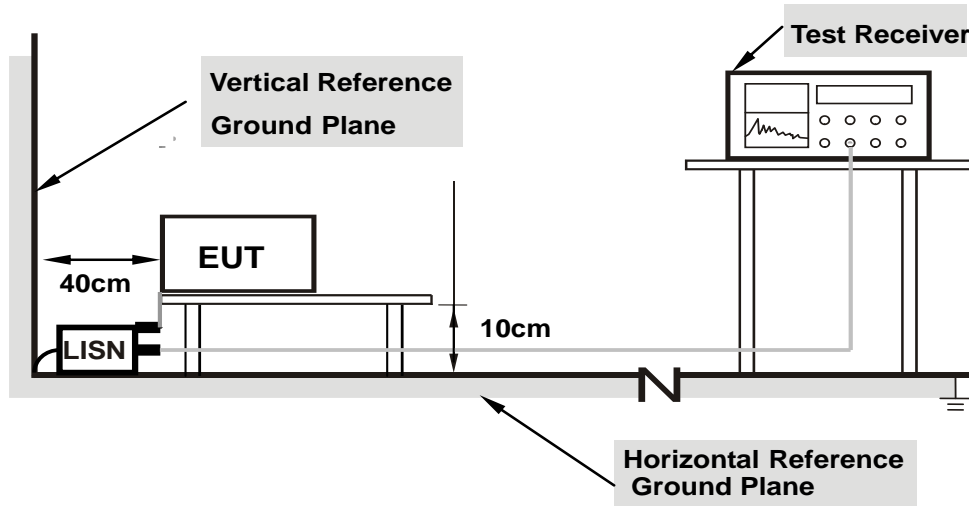

- Note: 1.Support units were connected to second LISN.**
2.Both of LISNs (AMN) are 80 cm from EUT and at least 80 from other units and other metal planes

The EUT is put on a table of non-conducting material that is 10cm high. The vertical conducting wall of shielding is located 40cm to the rear of the EUT. The power line of the EUT is connected to the AC mains through a Artificial Mains Network (A.M.N.). A EMI Measurement Receiver (R&S Test Receiver ESR3) is used to test the emissions from both sides of AC line. According to the requirements in Section 7 and 13 of ANSI C63.10-2013. Conducted emissions from the EUT measured in the frequency range between 0.15 MHz and 30MHz using CISPR Quasi-Peak and average detector mode. The bandwidth of EMI test receiver is set at 9kHz.

The arrangement of the equipment is installed to meet the standards and operating in a manner, which tends to maximize its emission characteristics in a normal application.

TEST ENVIRONMENT

Temperature	23.5°C	Relative Humidity	59%
Atmosphere Pressure	101kPa	Test Voltage	AC 120V/60Hz



TEST RESULTS

LINE N RESULTS

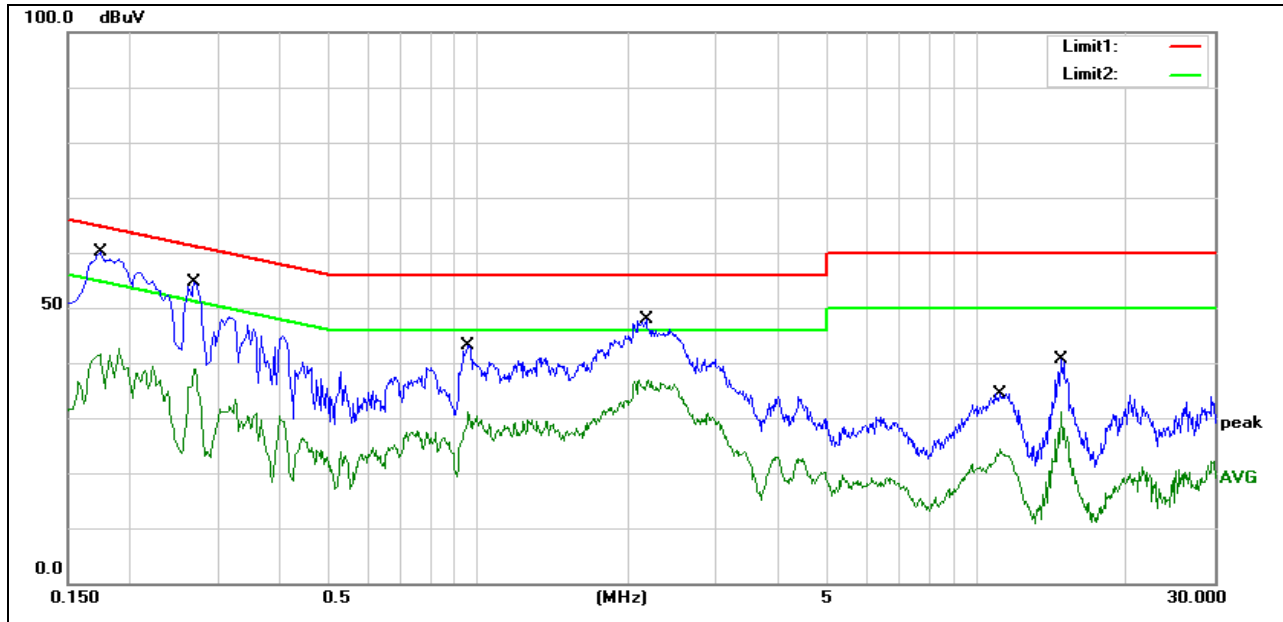

No.	Frequency (MHz)	Reading (dBuV)	Correct dB	Result (dBuV)	Limit (dBuV)	Margin (dB)	Remark
1	0.1740	50.29	9.81	60.10	64.77	-4.67	QP
2	0.1740	30.36	9.81	40.17	54.77	-14.60	AVG
3	0.2700	44.55	10.15	54.70	61.12	-6.42	QP
4	0.2700	28.64	10.15	38.79	51.12	-12.33	AVG
5	0.9500	33.28	9.81	43.09	56.00	-12.91	QP
6	0.9500	21.32	9.81	31.13	46.00	-14.87	AVG
7	2.1740	37.96	9.89	47.85	56.00	-8.15	QP
8	2.1740	26.41	9.89	36.30	46.00	-9.70	AVG
9	11.1940	24.51	9.97	34.48	60.00	-25.52	QP
10	11.1940	14.46	9.97	24.43	50.00	-25.57	AVG
11	14.7900	30.48	10.07	40.55	60.00	-19.45	QP
12	14.7900	16.13	10.07	26.20	50.00	-23.80	AVG

- Note: 1. Result = Reading +Correct Factor.
 2. If QP Result complies with AV limit, AV Result is deemed to comply with AV limit.
 3. Test setup: RBW: 200 Hz (9 kHz—150 kHz), 9 kHz (150 kHz—30 MHz).
 4. Step size: 80Hz (0.009MHz-0.15MHz), 4 kHz (0.15MHz-30MHz), Scan time: auto.



LINE L RESULTS

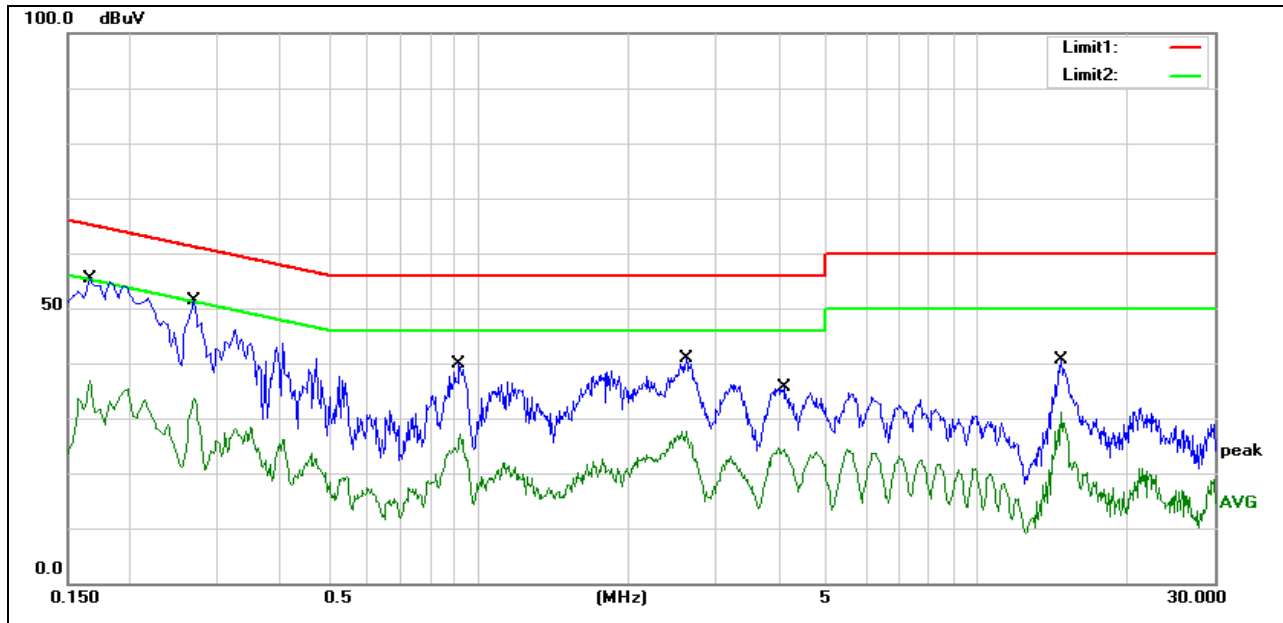

No.	Frequency (MHz)	Reading (dBuV)	Correct dB	Result (dBuV)	Limit (dBuV)	Margin (dB)	Remark
1	0.1660	45.56	9.79	55.35	65.16	-9.81	QP
2	0.1660	26.97	9.79	36.76	55.16	-18.40	AVG
3	0.2700	41.21	10.15	51.36	61.12	-9.76	QP
4	0.2700	23.43	10.15	33.58	51.12	-17.54	AVG
5	0.9180	29.96	9.82	39.78	56.00	-16.22	QP
6	0.9180	17.30	9.82	27.12	46.00	-18.88	AVG
7	2.6100	31.08	9.90	40.98	56.00	-15.02	QP
8	2.6100	17.75	9.90	27.65	46.00	-18.35	AVG
9	4.1020	25.66	9.95	35.61	56.00	-20.39	QP
10	4.1020	13.18	9.95	23.13	46.00	-22.87	AVG
11	14.8020	30.50	10.07	40.57	60.00	-19.43	QP
12	14.8020	21.07	10.07	31.14	50.00	-18.86	AVG

- Note: 1. Result = Reading +Correct Factor.
 2. If QP Result complies with AV limit, AV Result is deemed to comply with AV limit.
 3. Test setup: RBW: 200 Hz (9 kHz—150 kHz), 9 kHz (150 kHz—30 MHz).
 4. Step size: 80Hz (0.009MHz-0.15MHz), 4 kHz (0.15MHz-30MHz), Scan time: auto.



11. ANTENNA REQUIREMENTS

APPLICABLE REQUIREMENTS

Please refer to FCC §15.203

An intentional radiator shall be designed to ensure that no antenna other than that furnished by the responsible party shall be used with the device. The use of a permanently attached antenna or of an antenna that uses a unique coupling to the intentional radiator shall be considered sufficient to comply with the provisions of this section. The manufacturer may design the unit so that a broken antenna can be replaced by the user, but the use of a standard antenna jack or electrical connector is prohibited.

Please refer to FCC §15.247(b)(4)

The conducted output power limit specified in paragraph (b) of this section is based on the use of antennas with directional gains that do not exceed 6 dBi. Except as shown in paragraph (c) of this section, if transmitting antennas of directional gain greater than 6 dBi are used, the conducted output power from the intentional radiator shall be reduced below the stated values in paragraphs (b)(1), (b)(2), and (b)(3) of this section, as appropriate, by the amount in dB that the directional gain of the antenna exceeds 6 dBi.

ANTENNA CONNECTOR

EUT has a PCB Antenna without antenna connector.

ANTENNA GAIN

The antenna gain of EUT is less than 6 dBi.

Test photos

Radiation

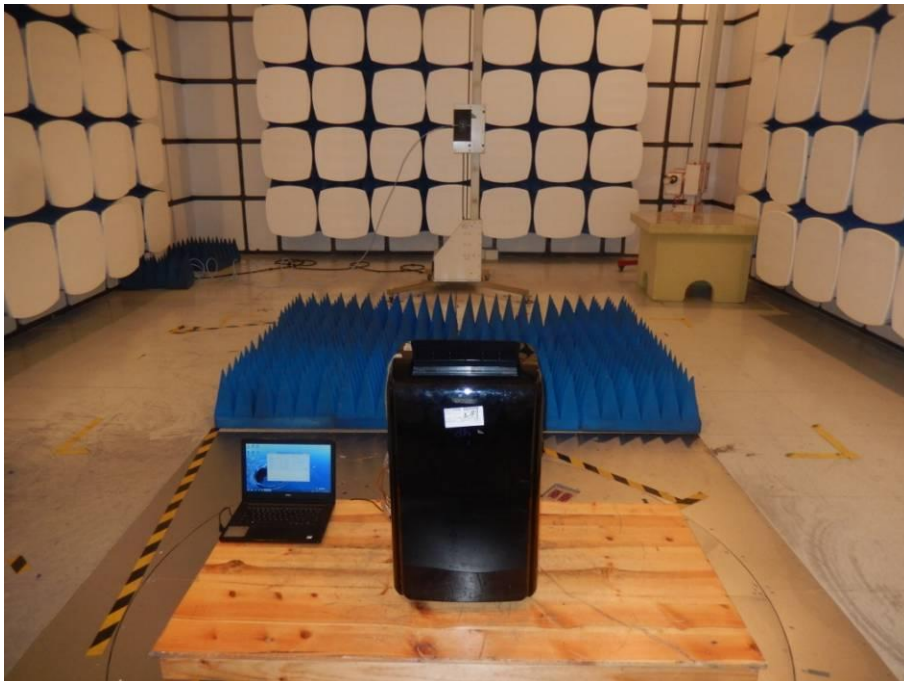
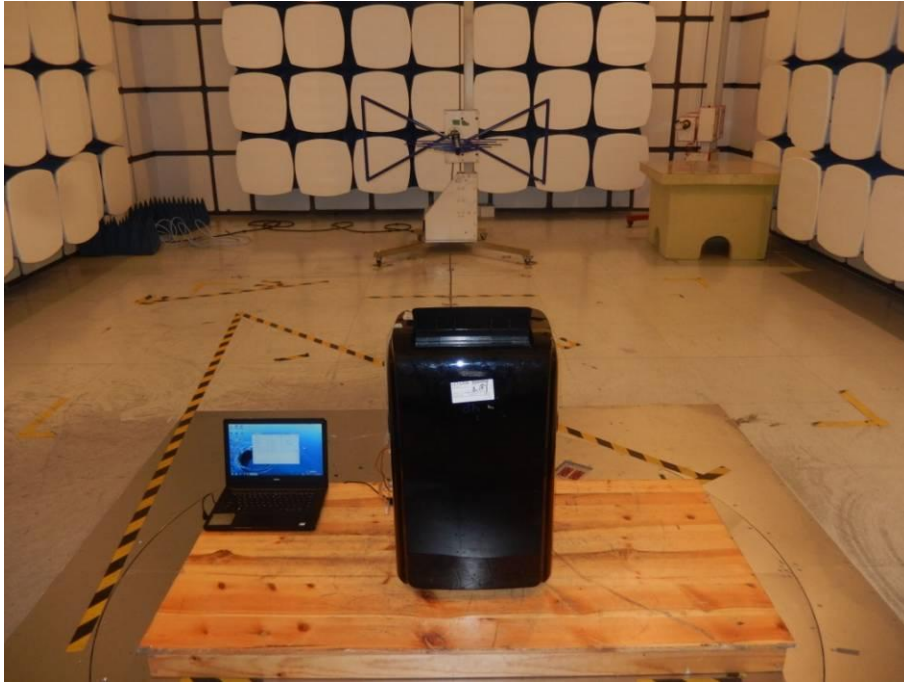

Conduction



END OF REPORT