



# FCC TEST REPORT

**Test report  
On Behalf of  
Shenzhen Glamour Bedding Supplies Co.,Ltd.  
For  
Fitsleep-Hub  
Model No.: HUB, FITSLEEP**

**FCC ID: 2AHH2HUB**

**Prepared for :** Shenzhen Glamour Bedding Supplies Co.,Ltd.  
Floor 1,Building 1,Zhuguang Innovation Science and Technology Park, Zhuguang Road,Nanshan District, Shenzhen, China

**Prepared By :** Shenzhen HUAKE Testing Technology Co., Ltd.  
1F, B2 Building, Junfeng Zhongcheng Zhizao Innovation Park, Fuhai Street, Bao'an District, Shenzhen City, China

**Date of Test:** Sep. 10, 2018 ~ Sep. 21, 2018

**Date of Report:** Sep. 21, 2018

**Report Number:** HK1809141081-2E



### TEST RESULT CERTIFICATION

**Applicant's name** .....: Shenzhen Glamour Bedding Supplies Co.,Ltd.  
**Address** .....: Floor 1,Building 1,Zhuguang Innovation Science and Technology Park, Zhuguang Road,Nanshan District, Shenzhen, China  
**Manufacture's Name**.....: Shenzhen Zowee Technology Co., Ltd.  
**Address** .....: Zowee industrial Park, Tongfuyu industrial Zone, Tangxiachong Songgang Town, Baoan District, Shenzhen, China

**Product description**

Trade Mark: N/A  
 Product name.....: Fitsleep-Hub  
 Model and/or type reference : HUB, FITSLEEP  
**Standards** .....: FCC Rules and Regulations Part 15 Subpart C Section 15.247  
 ANSI C63.10: 2013

This publication may be reproduced in whole or in part for non-commercial purposes as long as the Shenzhen HUAK Testing Technology Co., Ltd. is acknowledged as copyright owner and source of the material. Shenzhen HUAK Testing Technology Co., Ltd. takes no responsibility for and will not assume liability for damages resulting from the reader's interpretation of the reproduced material due to its placement and context.

**Date of Test** .....:   
 Date (s) of performance of tests .....: Sep. 10, 2018 ~ Sep. 21, 2018  
 Date of Issue.....: Sep. 21, 2018  
 Test Result.....: **Pass**

Testing Engineer : Gary Qian  
 (Gary Qian)

Technical Manager : Eden Hu  
 (Eden Hu)

Authorized Signatory : Jason Zhou  
 (Jason Zhou)



## TABLE OF CONTENTS

<b>1. Test Result Summary .....</b>	<b>4</b>
1.1. TEST PROCEDURES AND RESULTS.....	4
1.2. TEST FACILITY .....	4
1.3. MEASUREMENT UNCERTAINTY .....	5
<b>2. EUT Description .....</b>	<b>6</b>
2.1. GENERAL DESCRIPTION OF EUT .....	6
2.2. CARRIER FREQUENCY OF CHANNELS .....	7
2.3. OPERATION OF EUT DURING TESTING .....	7
2.4. DESCRIPTION OF TEST SETUP .....	7
<b>3. General Information .....</b>	<b>8</b>
3.1. TEST ENVIRONMENT AND MODE .....	8
3.2. DESCRIPTION OF SUPPORT UNITS .....	9
<b>4. Test Results and Measurement Data .....</b>	<b>10</b>
4.1. CONDUCTED EMISSION .....	10
4.2. MAXIMUM CONDUCTED OUTPUT POWER .....	14
4.3. EMISSION BANDWIDTH.....	16
4.4. POWER SPECTRAL DENSITY .....	21
4.5. CONDUCTED BAND EDGE AND SPURIOUS EMISSION MEASUREMENT .....	26
4.6. RADIATED SPURIOUS EMISSION MEASUREMENT .....	31
4.7. ANTENNA REQUIREMENT .....	46
4.8. PHOTOGRAPH OF TEST.....	53



# 1. Test Result Summary

## 1.1. TEST PROCEDURES AND RESULTS

Requirement	CFR 47 Section	Result
Antenna requirement	§15.203/§15.247 (c)	PASS
AC Power Line Conducted Emission	§15.207	PASS
Conducted Peak Output Power	§15.247 (b)(3) §2.1046	PASS
6dB Emission Bandwidth	§15.247 (a)(2) §2.1049	PASS
Power Spectral Density	§15.247 (e)	PASS
Band Edge	§15.247(d) §2.1051, §2.1057	PASS
Spurious Emission	§15.205/§15.209 §2.1053, §2.1057	PASS

**Note:**

1. PASS: Test item meets the requirement.
2. Fail: Test item does not meet the requirement.
3. N/A: Test case does not apply to the test object.
4. The test result judgment is decided by the limit of test standard.

## 1.2. TEST FACILITY

Test Firm : Shenzhen HUAKE Testing Technology Co., Ltd.

Address : 1F, B2 Building, Junfeng Zhongcheng Zhizao Innovation Park, Fuhai Street, Bao'an District, Shenzhen City, China



### 1.3. Measurement Uncertainty

The reported uncertainty of measurement  $y \pm U$ , where expanded uncertainty  $U$  is based on a standard uncertainty multiplied by a coverage factor of  $k=2$ , providing a level of confidence of approximately 95 %.

No.	Item	MU
1	Conducted Emission	$\pm 2.56\text{dB}$
2	RF power, conducted	$\pm 0.12\text{dB}$
3	Spurious emissions, conducted	$\pm 0.11\text{dB}$
4	All emissions, radiated(<1G)	$\pm 3.92\text{dB}$
5	All emissions, radiated(>1G)	$\pm 4.28\text{dB}$
6	Temperature	$\pm 0.1^\circ\text{C}$
7	Humidity	$\pm 1.0\%$



## 2. EUT Description

### 2.1. GENERAL DESCRIPTION OF EUT

Equipment	Fitsleep-Hub
Model Name	HUB
Serial No.	FITSLEEP
Model Difference	All model's the function, software and electric circuit are the same, only with a product color and model named different. Test sample model: HUB.
Trade Mark	N/A
FCC ID	<b>2AHH2HUB</b>
Antenna Type	PCB Antenna
Antenna Gain	1dBi
Operation frequency	802.11b/g/n 20:2412~2462 MHz
Number of Channels	802.11b/g/n20: 11CH
Modulation Type	CCK/OFDM/DBPSK/DAPSK
Power Source	DC5V From USB
Power Rating	DC5V From USB



## 2.2. Carrier Frequency of Channels

Channel List for 802.11b/802.11g/802.11n (HT20)							
Channel	Frequency (MHz)	Channel	Frequency (MHz)	Channel	Frequency (MHz)	Channel	Frequency (MHz)
01	2412	04	2427	07	2442	10	2457
02	2417	05	2432	08	2447	11	2462
03	2422	06	2437	09	2452		

**Note:**

*In section 15.31(m), regards to the operating frequency range over 10 MHz, the Lowest frequency, the middle frequency, and the highest frequency of channel were selected to perform the test, and the selected channel see below:*

## 2.3. Operation of EUT during testing

Operating Mode

The mode is used: **Transmitting mode for 802.11b/802.11g/802.11n (HT20)**

Low Channel: 2412MHz

Middle Channel: 2437MHz

High Channel: 2462MHz

## 2.4. DESCRIPTION OF TEST SETUP

Operation of EUT during conducted testing and Radiation testing:

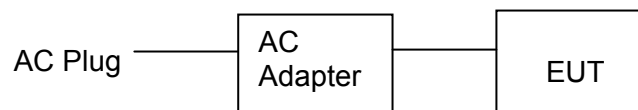

Operation of EUT during Above1GHz Radiation testing:



Adapter information

Model: TX-0502400-AC001

Input: 100-240V AC, 50/60Hz, 0.3A

Output: 5VDC, 2.4A



### 3. Genera Information

#### 3.1. Test environment and mode

Operating Environment:	
Temperature:	25.0 °C
Humidity:	56 % RH
Atmospheric Pressure:	1010 mbar
Test Mode:	
Engineering mode:	Keep the EUT in continuous transmitting by select channel and modulations(The value of duty cycle is 98.46%)
<p>The sample was placed (0.8m below 1GHz, 1.5m above 1GHz) above the ground plane of 3m chamber. Measurements in both horizontal and vertical polarities were performed. During the test, each emission was maximized by: having the EUT continuously working, investigated all operating modes, rotated about all 3 axis (X, Y &amp; Z) and considered typical configuration to obtain worst position, manipulating interconnecting cables, rotating the turntable, varying antenna height from 1m to 4m in both horizontal and vertical polarizations. The emissions worst-case are shown in Test Results of the following pages. For the full battery state and The output power to the maximum state.</p>	

<p>We have verified the construction and function in typical operation. All the test modes were carried out with the EUT in transmitting operation, which was shown in this test report and defined as follows:</p>	
<p><b>Per-scan all kind of data rate in lowest channel, and found the follow list which it was worst case.</b></p>	
Mode	Data rate
802.11b	1Mbps
802.11g	6Mbps
802.11n(H20)	6.5Mbps
Final Test Mode:	
Operation mode:	Keep the EUT in continuous transmitting with modulation
<p>1. For WIFI function, the engineering test program was provided and enabled to make EUT continuous transmit/receive.</p> <p>2. According to ANSI C63.10 standards, the test results are both the “worst case” and “worst setup” 1Mbps for 802.11b, 6Mbps for 802.11g, 6.5Mbps for 802.11n(H20),. Duty cycle setting during the transmission is 98.5% with maximum power setting for all modulations.</p>	





### 3.2. Description of Support Units

The EUT has been tested as an independent unit together with other necessary accessories or support units. The following support units or accessories were used to form a representative test configuration during the tests.

Equipment	Model No.	Serial No.	FCC ID	Trade Name
/	/	/	/	/

**Note:**

- 1. All the equipment/cables were placed in the worst-case configuration to maximize the emission during the test.*
- 2. Grounding was established in accordance with the manufacturer's requirements and conditions for the intended use.*
- 3. For conducted measurements (Output Power, 6dB Emission Bandwidth, Power Spectral Density, Spurious Emissions), the antenna of EUT is connected to the test equipment via temporary antenna connector, the antenna connector is soldered on the antenna port of EUT, and the temporary antenna connector is listed in the Test Instruments.*



## 4. Test Results and Measurement Data

### 4.1. Conducted Emission

#### Test Specification

<b>Test Requirement:</b>	FCC Part15 C Section 15.207														
<b>Test Method:</b>	ANSI C63.10:2013														
<b>Frequency Range:</b>	150 kHz to 30 MHz														
<b>Receiver setup:</b>	RBW=9 kHz, VBW=30 kHz, Sweep time=auto														
<b>Limits:</b>	<table border="1"> <thead> <tr> <th rowspan="2">Frequency range (MHz)</th> <th colspan="2">Limit (dBuV)</th> </tr> <tr> <th>Quasi-peak</th> <th>Average</th> </tr> </thead> <tbody> <tr> <td>0.15-0.5</td> <td>66 to 56*</td> <td>56 to 46*</td> </tr> <tr> <td>0.5-5</td> <td>56</td> <td>46</td> </tr> <tr> <td>5-30</td> <td>60</td> <td>50</td> </tr> </tbody> </table>	Frequency range (MHz)	Limit (dBuV)		Quasi-peak	Average	0.15-0.5	66 to 56*	56 to 46*	0.5-5	56	46	5-30	60	50
Frequency range (MHz)	Limit (dBuV)														
	Quasi-peak	Average													
0.15-0.5	66 to 56*	56 to 46*													
0.5-5	56	46													
5-30	60	50													
<b>Test Setup:</b>	<p><i>Remark</i>  <i>E.U.T: Equipment Under Test</i>  <i>LISN: Line Impedance Stabilization Network</i>  <i>Test table height=0.8m</i></p>														
<b>Test Mode:</b>	Charging + transmitting with modulation														
<b>Test Procedure:</b>	<ol style="list-style-type: none"> <li>1. The E.U.T is connected to the main power through a line impedance stabilization network (L.I.S.N.). This provides a 50ohm/50uH coupling impedance for the measuring equipment.</li> <li>2. The peripheral devices are also connected to the main power through a LISN that provides a 50ohm/50uH coupling impedance with 50ohm termination. (Please refer to the block diagram of the test setup and photographs).</li> <li>3. Both sides of A.C. line are checked for maximum conducted interference. In order to find the maximum emission, the relative positions of equipment and all of the interface cables must be changed according to ANSI C63.10: 2013 on conducted measurement.</li> </ol>														
<b>Test Result:</b>	PASS														

**Test Instruments**

<b>Conducted Emission Shielding Room Test Site (843)</b>				
<b>Equipment</b>	<b>Manufacturer</b>	<b>Model</b>	<b>Serial Number</b>	<b>Calibration Due</b>
Receiver	R&S	ESCI 7	HKE-010	Sep. 27, 2018
LISN	R&S	ENV216	HKE-002	Sep. 27, 2018
Conducted test software	Tonscend	TS+ Rev 2.5.0.0	HKE-081	N/A

**Note:** The calibration interval of the above test instruments is 12 months and the calibrations are traceable to international system unit (SI).



**Test data**

Remark: We tested three Channels in AC 120V/60Hz and AC 240V/60Hz, the worst case was recorded.

Please refer to following diagram for individual

Conducted Emission on Line Terminal of the power line (150 kHz to 30MHz)

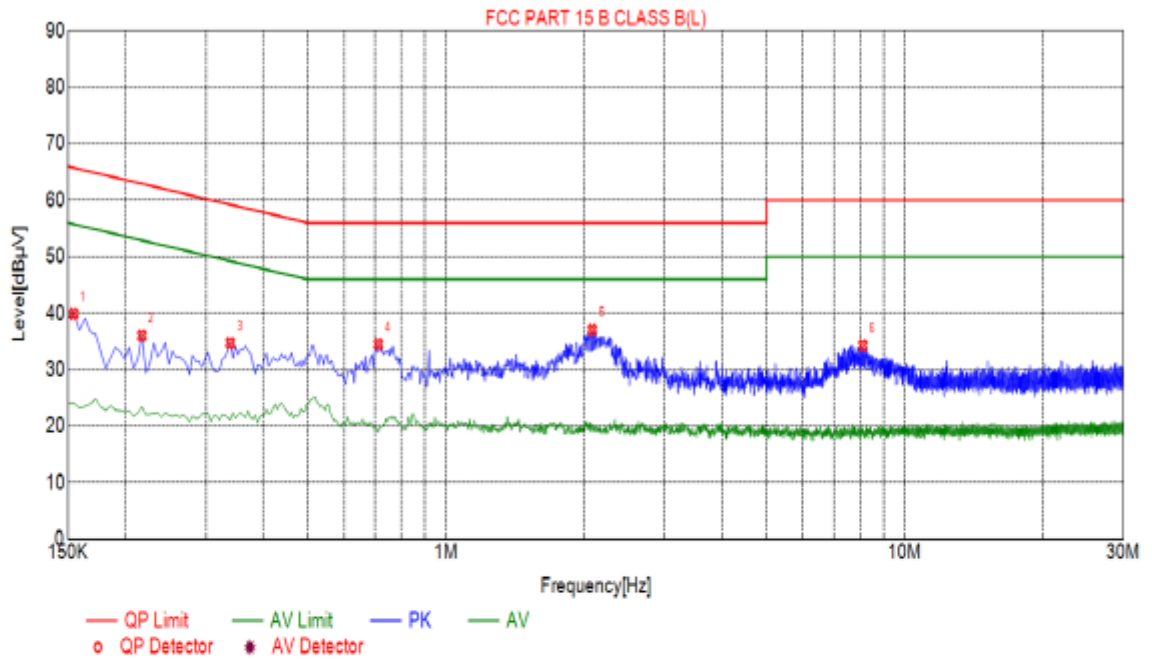

Suspected List						
NO.	Freq. [MHz]	Level [dBµV]	Factor [dB]	Limit [dBµV]	Margin [dB]	Detector
1	0.1545	39.92	10.03	65.81	25.89	PK
2	0.2175	36.04	10.05	62.95	26.91	PK
3	0.3390	34.74	10.03	59.31	24.57	PK
4	0.7125	34.53	10.05	56.00	21.47	PK
5	2.0850	37.06	10.15	56.00	18.94	PK
6	8.1105	34.29	10.14	60.00	25.71	PK

Remark: Transd = Cable lose + Antenna factor - Pre-amplifier; Margin = Limit – Level

**Notes:**

1. An initial pre-scan was performed on the line and neutral lines with peak detector.
2. Quasi-Peak and Average measurement were performed at the frequencies with maximized peak emission.
3. Final Level = Receiver Read level + LISN Factor + Cable Loss
4. If the average limit is met when using a quasi-peak detector receiver, the EUT shall be deemed to meet both limits and measurement with the average detector receiver is unnecessary.



**Conducted Emission on Neutral Terminal of the power line (150 kHz to 30MHz)**

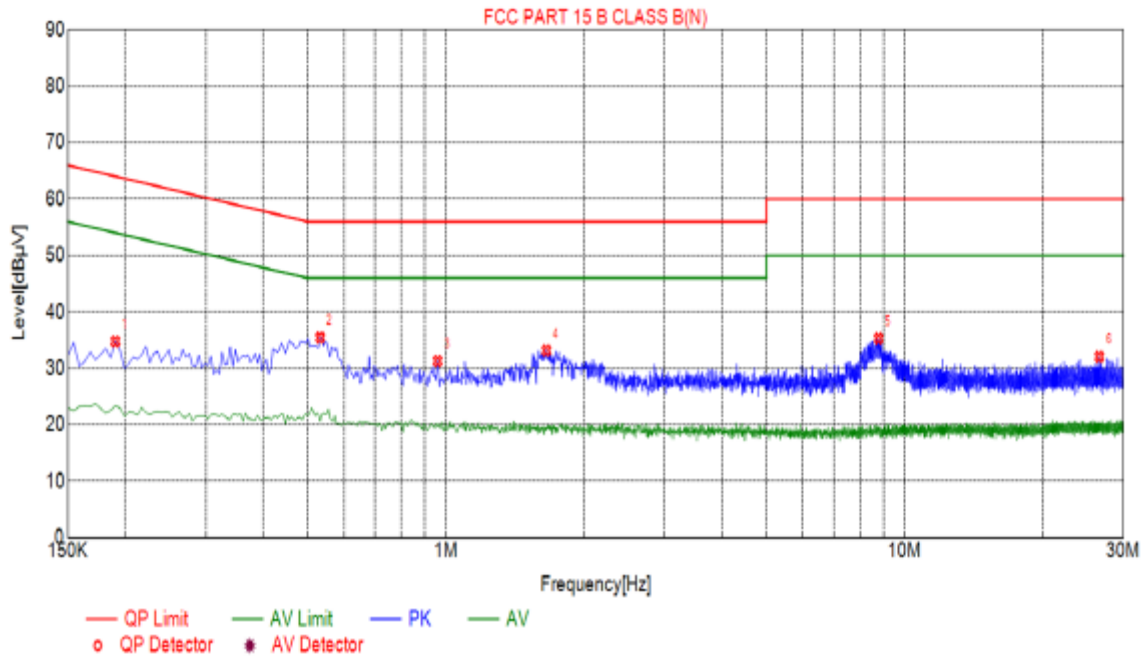

Suspected List						
NO.	Freq. [MHz]	Level [dBμV]	Factor [dB]	Limit [dBμV]	Margin [dB]	Detector
1	0.1905	34.77	10.04	64.10	29.33	PK
2	0.5325	35.44	10.05	56.00	20.56	PK
3	0.9600	31.30	10.06	56.00	24.70	PK
4	1.6575	33.18	10.12	56.00	22.82	PK
5	8.7810	35.28	10.12	60.00	24.72	PK
6	26.5830	32.06	10.26	60.00	27.94	PK

Remark:  $Transd = Cable\ lose + Antenna\ factor - Pre\text{-}amplifier$ ;  $Margin = Limit - Level$

**Notes:**

1. An initial pre-scan was performed on the line and neutral lines with peak detector.
2. Quasi-Peak and Average measurement were performed at the frequencies with maximized peak emission.
3.  $Final\ Level = Receiver\ Read\ level + LISN\ Factor + Cable\ Loss$ .
4. If the average limit is met when using a quasi-peak detector receiver, the EUT shall be deemed to meet both limits and measurement with the average detector receiver is unnecessary.



## 4.2. Maximum Conducted Output Power

### Test Specification

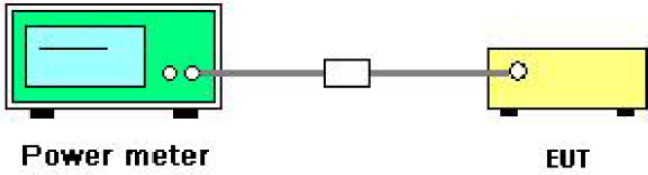
<b>Test Requirement:</b>	FCC Part15 C Section 15.247 (b)(3)
<b>Test Method:</b>	KDB 558074
<b>Limit:</b>	30dBm
<b>Test Setup:</b>	 <p>The diagram shows a green Power meter on the left, connected by a grey cable to a small white attenuator, which is then connected to a yellow EUT on the right. Labels 'Power meter' and 'EUT' are placed below their respective components.</p>
<b>Test Mode:</b>	Transmitting mode with modulation
<b>Test Procedure:</b>	<ol style="list-style-type: none"><li>1. The testing follows the Measurement Procedure of FCC KDB No. 558074 DTS D01 Meas. Guidance v04.</li><li>2. The RF output of EUT was connected to the power meter by RF cable and attenuator. The path loss was compensated to the results for each measurement.</li><li>3. Set to the maximum power setting and enable the EUT transmit continuously.</li><li>4. Measure the Peak output power and record the results in the test report.</li></ol>
<b>Test Result:</b>	PASS

### Test Instruments

RF Test Room				
Equipment	Manufacturer	Model	Serial Number	Calibration Due
Power meter	Agilent	E4417B	HKE-107	Sep. 27, 2018
Power Sensor	Agilent	E9327A	HKE-113	Sep. 27, 2018
RF cable	Times	1-40G	HKE-034	Sep. 27, 2018
RF automatic control unit	Tonscend	JS0806-2	HKE-060	Sep. 27, 2018

**Note:** The calibration interval of the above test instruments is 12 months and the calibrations are traceable to international system unit (SI).

**Test Data**

<b>TX 802.11b Mode</b>			
Test Channe	Frequency	Maximum Peak Conducted Output Power	LIMIT
	(MHz)	(dBm)	dBm
CH01	2412	12.19	30
CH06	2437	12.57	30
CH11	2462	12.92	30
<b>TX 802.11g Mode</b>			
CH01	2412	11.53	30
CH06	2437	11.68	30
CH11	2462	11.92	30
<b>TX 802.11n20 Mode</b>			
CH01	2412	10.33	30
CH06	2437	10.42	30
CH11	2462	10.68	30





**Test data**

Test channel	6dB Emission Bandwidth (MHz)		
	802.11b	802.11g	802.11n(H20)
Lowest	8.479	16.08	16.29
Middle	8.588	16.31	16.30
Highest	8.479	16.34	16.05
Limit:	>500k		
Test Result:	PASS		

Test plots as follows:



### 802.11b Modulation

#### Lowest channel

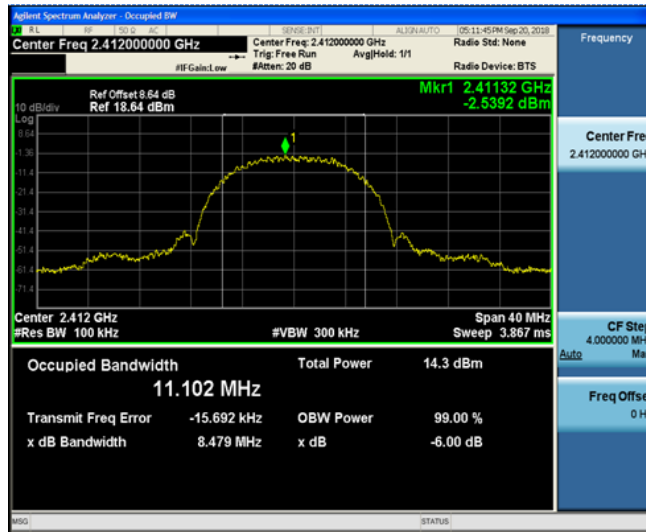

#### Middle channel

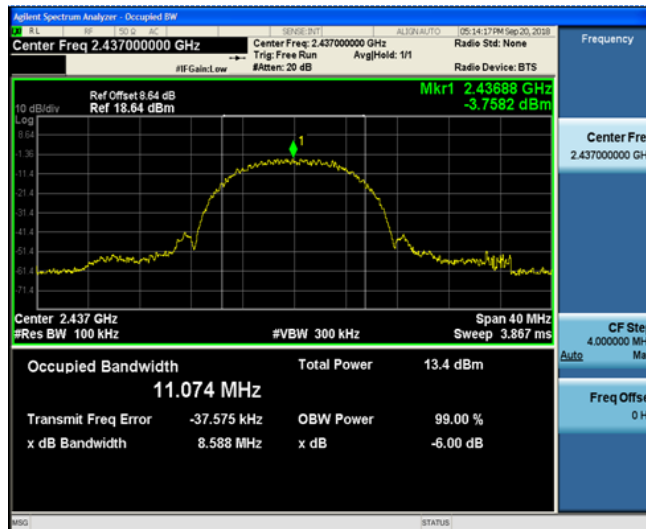

#### Highest channel

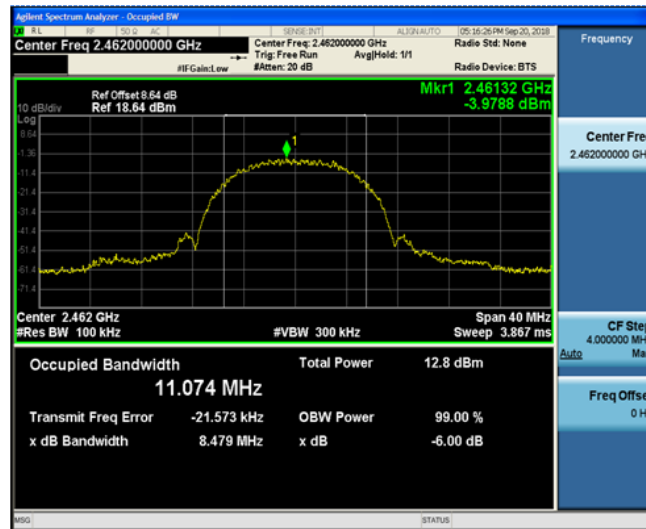



### 802.11g Modulation

#### Lowest channel

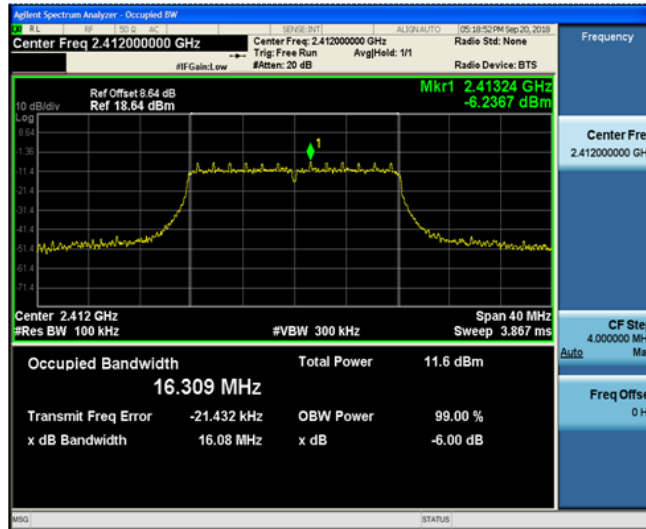

#### Middle channel

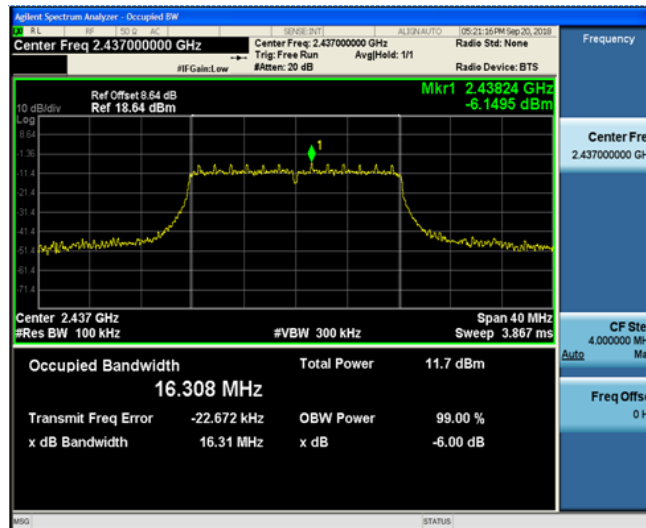

#### Highest channel

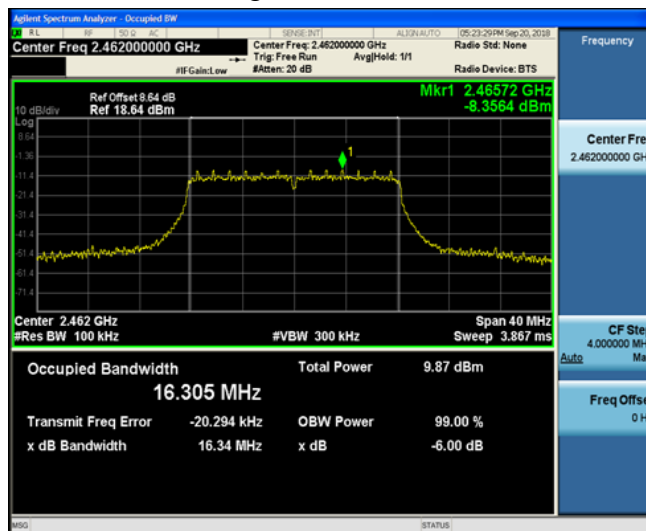



### 802.11n (HT20) Modulation

#### Lowest channel

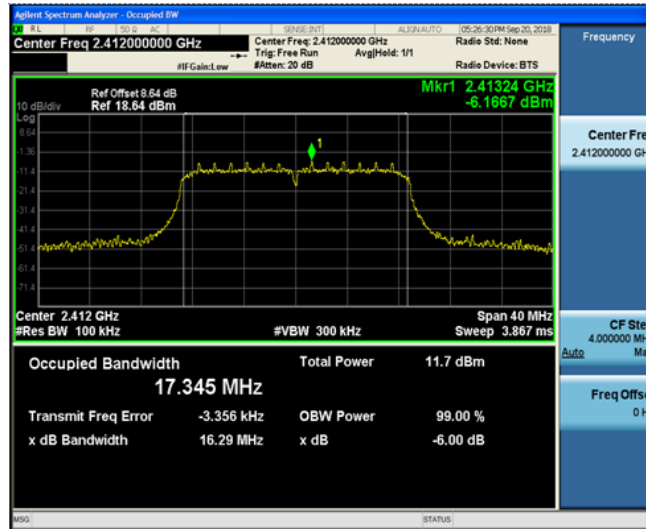

#### Middle channel

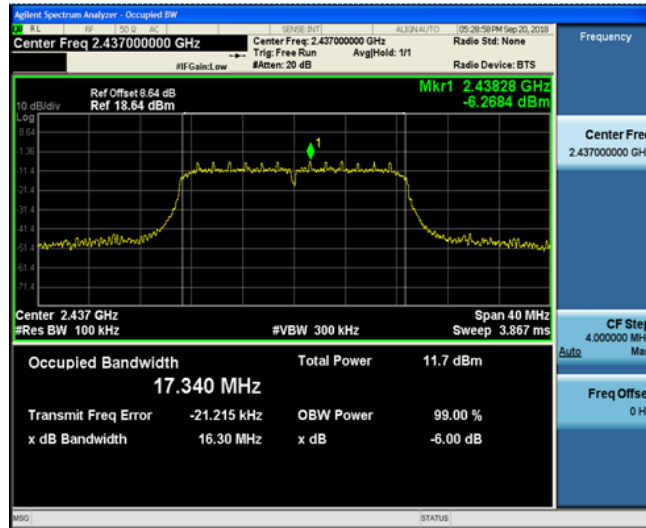

#### Highest channel

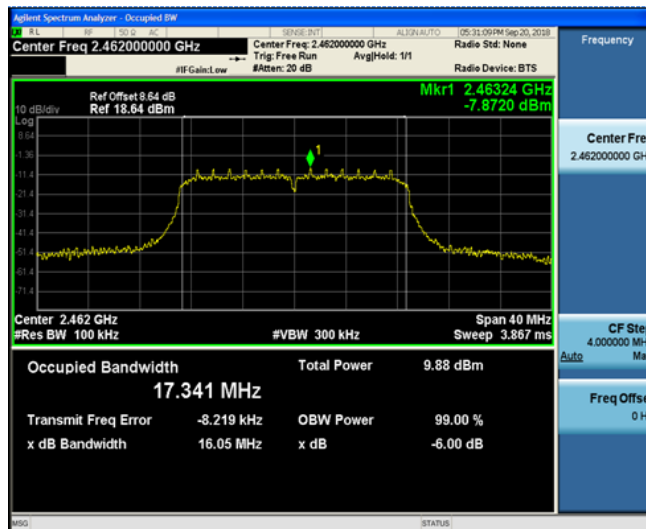



**Test data**

EUT Set Mode	Channel	Result (dBm/30kHz)	Result (dBm/3kHz)
802.11b	Lowest	-7.43	-17.43
	Middle	-8.03	-18.03
	Highest	-8.5	-18.5
802.11g	Lowest	-10.7	-20.7
	Middle	-11.05	-21.05
	Highest	-13.88	-23.88
802.11n(H20)	Lowest	-10.93	-20.93
	Middle	-11.02	-21.02
	Highest	-12.46	-22.46
PSD test result (dBm/3kHz)= PSD test result (dBm/30kHz)-10			
Limit: 8dBm/3kHz			
Test Result:	PASS		

Test plots as follows:



### 802.11b Modulation

#### Lowest channel

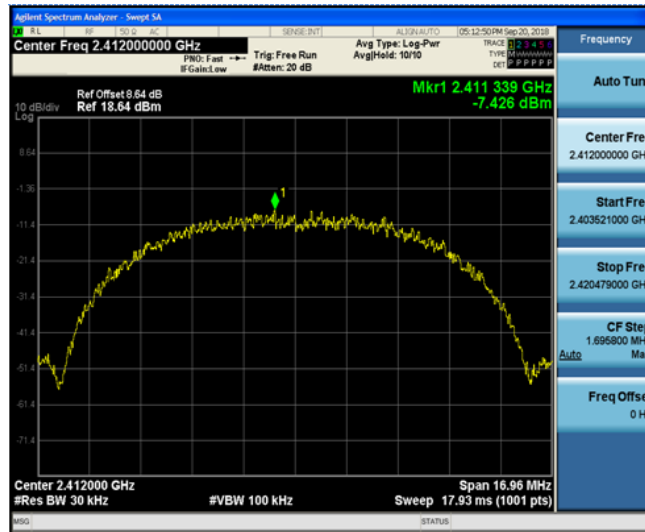

#### Middle channel



#### Highest channel

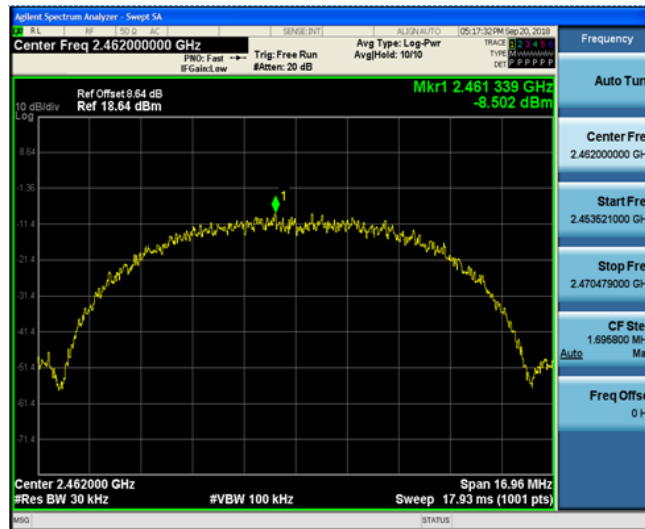



### 802.11g Modulation

#### Lowest channel

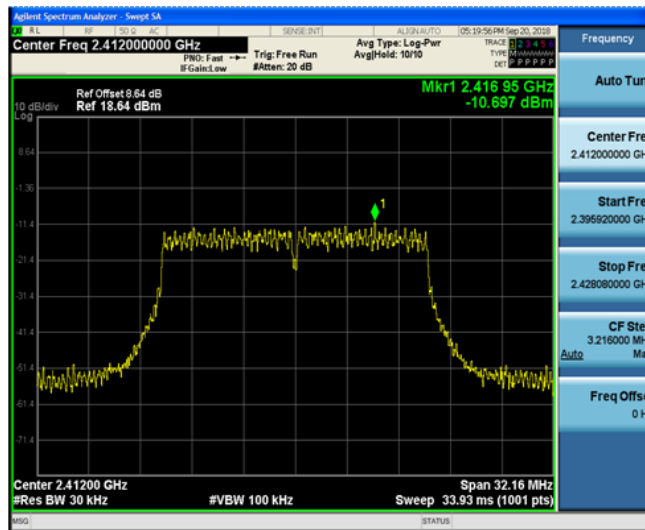

#### Middle channel

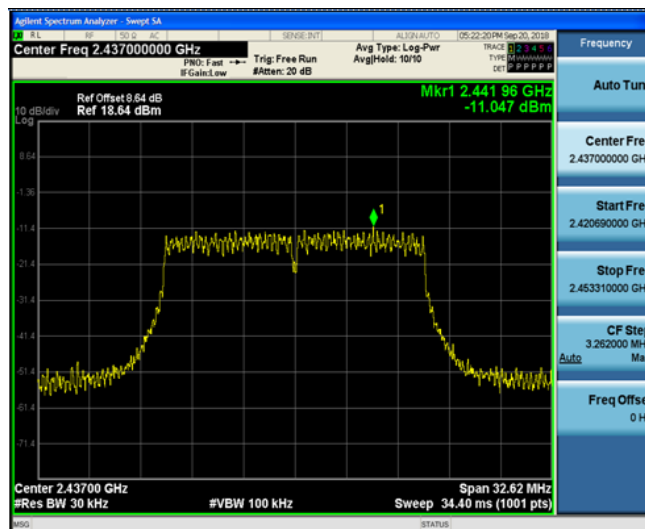

#### Highest channel

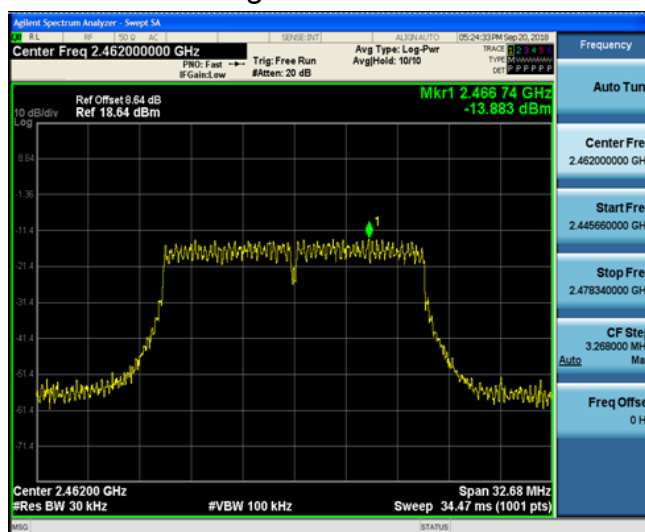





### 802.11n (HT20) Modulation

#### Lowest channel



#### Middle channel

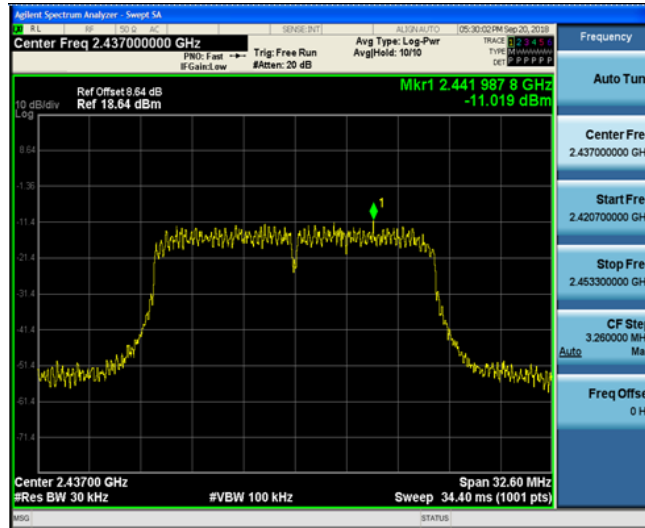

#### Highest channel

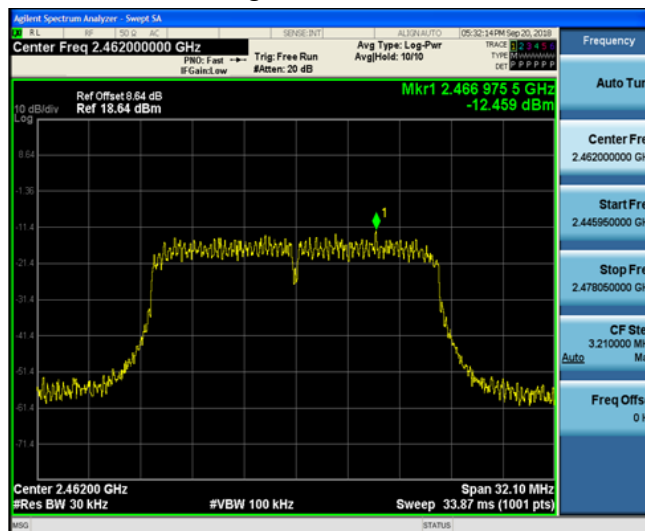



## Conducted Band Edge and Spurious Emission Measurement

### Test Specification

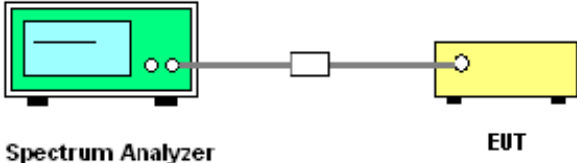
<b>Test Requirement:</b>	FCC Part15 C Section 15.247 (d)
<b>Test Method:</b>	KDB558074
<b>Limit:</b>	In any 100 kHz bandwidth outside of the authorized frequency band, the emissions which fall in the non-restricted bands shall be attenuated at least 20 dB / 30dB relative to the maximum PSD level in 100 kHz by RF conducted measurement and radiated emissions which fall in the restricted bands, as defined in Section 15.205(a), must also comply with the radiated emission limits specified in Section 15.209(a).
<b>Test Setup:</b>	 <p>The diagram illustrates the test setup. On the left is a green Spectrum Analyzer. A cable connects it to a small white rectangular attenuator. Another cable connects the attenuator to a yellow EUT (Equipment Under Test) on the right. Labels 'Spectrum Analyzer' and 'EUT' are placed below their respective components.</p>
<b>Test Mode:</b>	Transmitting mode with modulation
<b>Test Procedure:</b>	<ol style="list-style-type: none"><li>1. The testing follows FCC KDB Publication No. 558074 D01 DTS Meas. Guidance v04.</li><li>2. The RF output of EUT was connected to the spectrum analyzer by RF cable and attenuator. The path loss was compensated to the results for each measurement.</li><li>3. Set to the maximum power setting and enable the EUT transmit continuously.</li><li>4. Set RBW = 100 kHz, VBW=300 kHz, Peak Detector. Unwanted Emissions measured in any 100 kHz bandwidth outside of the authorized frequency band shall be attenuated by at least 20 dB relative to the maximum in-band peak PSD level in 100 kHz when maximum peak conducted output power procedure is used. If the transmitter complies with the conducted power limits based on the use of RMS averaging over a time interval, the attenuation required under this paragraph shall be 30 dB instead of 20 dB per 15.247(d).</li><li>5. Measure and record the results in the test report.</li><li>6. The RF fundamental frequency should be excluded against the limit line in the operating frequency band.</li></ol>
<b>Test Result:</b>	PASS

**Test Instruments**

RF Test Room				
Equipment	Manufacturer	Model	Serial Number	Calibration Due
Spectrum analyzer	Agilent	N9020A	HKE-048	Sep. 27, 2018
Signal generator	Agilent	N5183A	HKE-071	Sep. 27, 2018
RF Cable (9KHz-26.5GHz)	Tonscend	170660	N/A	Sep. 27, 2018
RF automatic control unit	Tonscend	JS0806-2	HKE-060	Sep. 27, 2018

**Note:** The calibration interval of the above test instruments is 12 months and the calibrations are traceable to international system unit (SI).



Test Data

802.11b Modulation

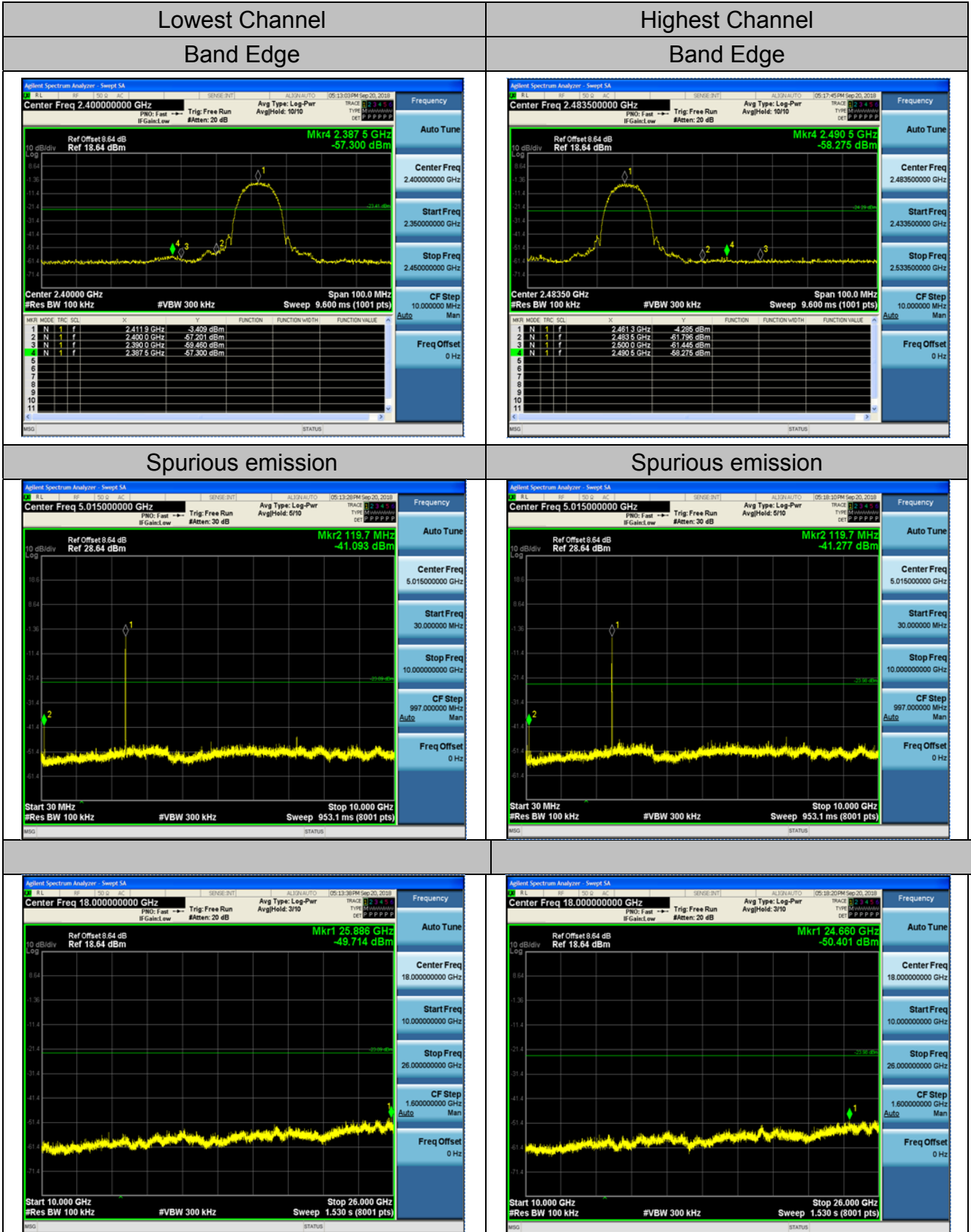



### 802.11g Modulation

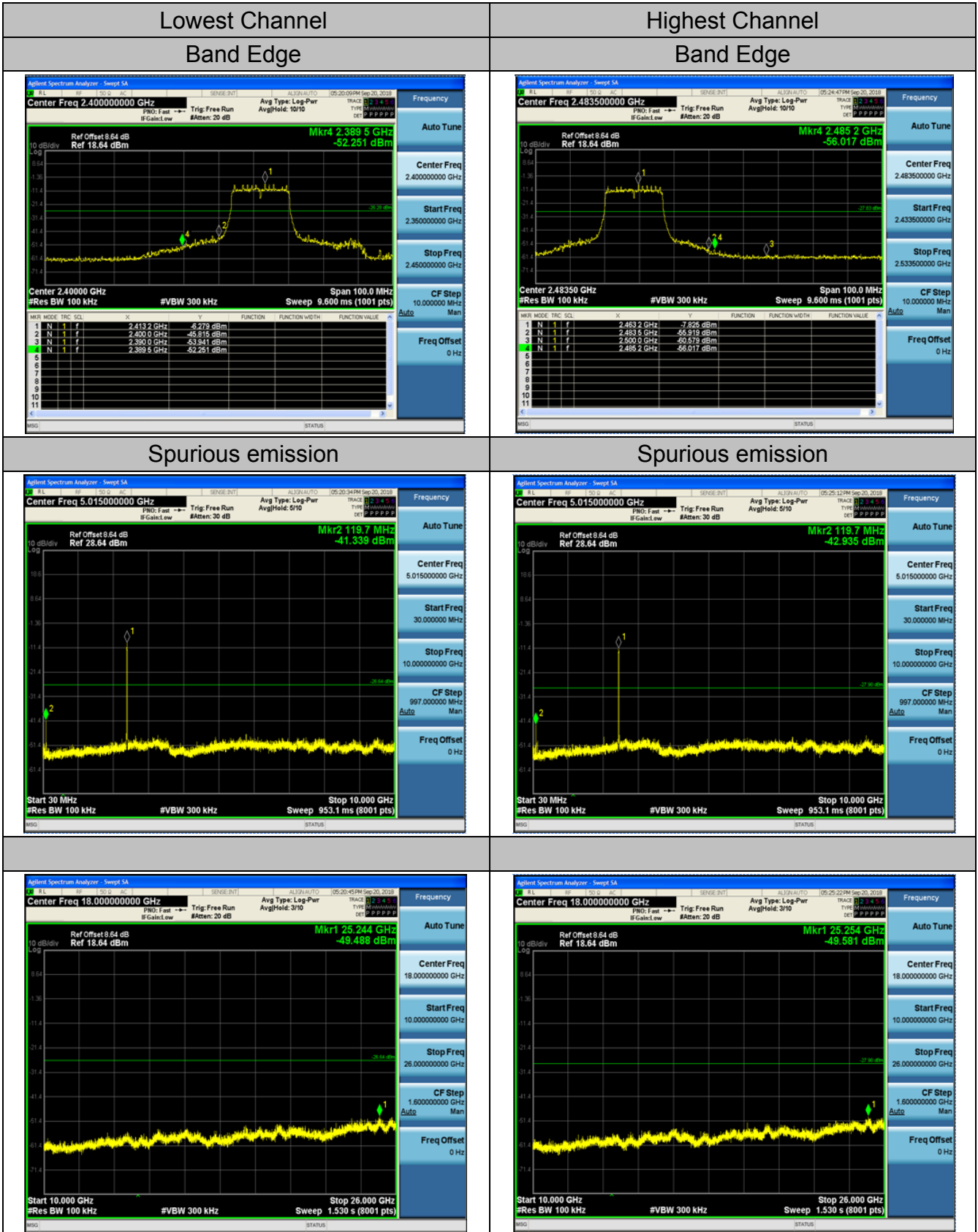



802.11n (HT20) Modulation

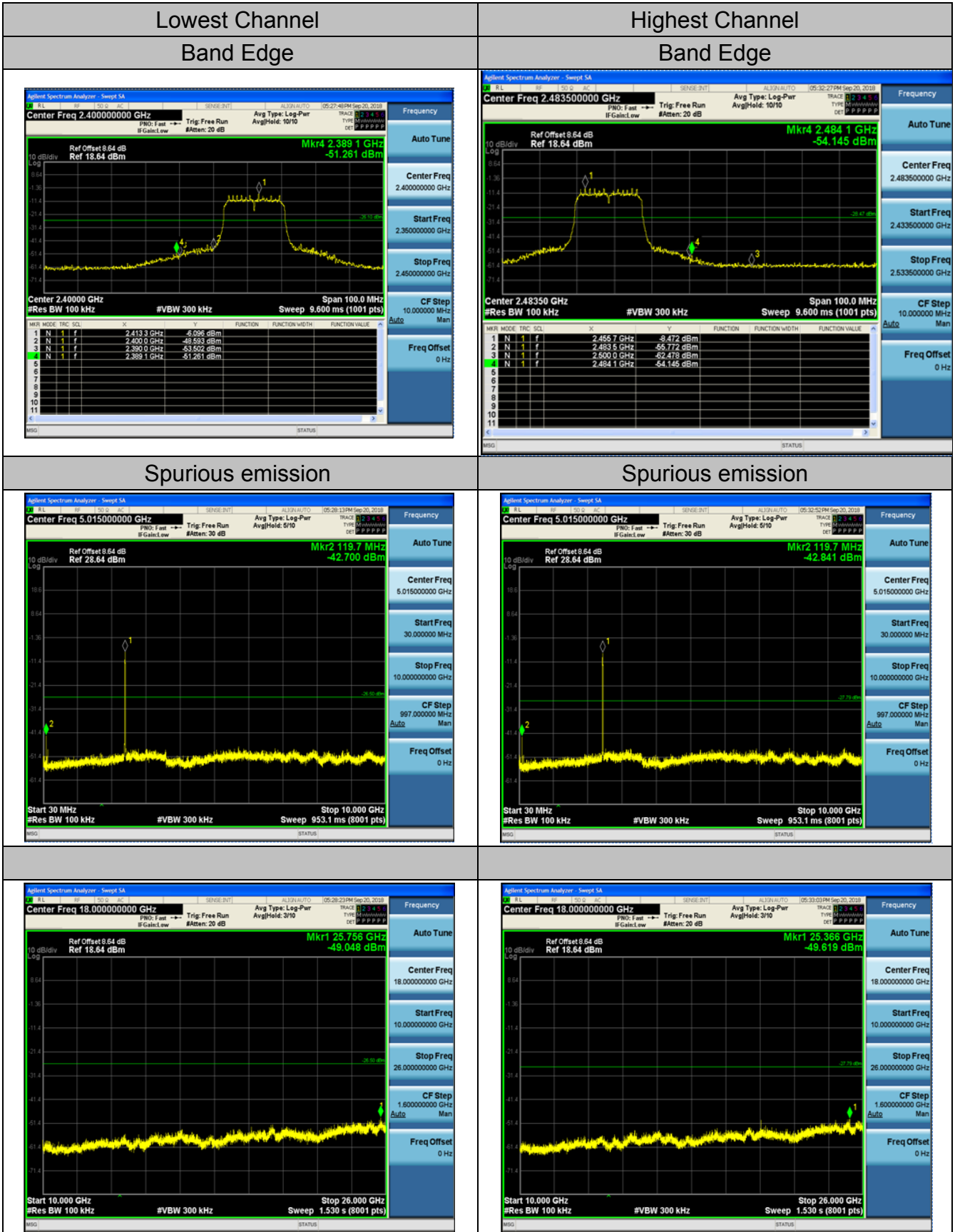



### 4.5. Radiated Spurious Emission Measurement

#### Test Specification

<b>Test Requirement:</b>	FCC Part15 C Section 15.209					
<b>Test Method:</b>	ANSI C63.10: 2013					
<b>Frequency Range:</b>	9 kHz to 25 GHz					
<b>Measurement Distance:</b>	3 m					
<b>Antenna Polarization:</b>	Horizontal & Vertical					
<b>Operation mode:</b>	Transmitting mode with modulation					
<b>Receiver Setup:</b>	Frequency	Detector	RBW	VBW	Remark	
	9kHz- 150kHz	Quasi-peak	200Hz	1kHz	Quasi-peak Value	
	150kHz- 30MHz	Quasi-peak	9kHz	30kHz	Quasi-peak Value	
	30MHz-1GHz	Quasi-peak	100KHz	300KHz	Quasi-peak Value	
	Above 1GHz	Peak	1MHz	3MHz	Peak Value	
		Peak	1MHz	10Hz	Average Value	
<b>Limit:</b>	Frequency	Field Strength (microvolts/meter)	Measurement Distance (meters)			
	0.009-0.490	2400/F(KHz)	300			
	0.490-1.705	24000/F(KHz)	30			
	1.705-30	30	30			
	30-88	100	3			
	88-216	150	3			
	216-960	200	3			
	Above 960	500	3			
	Frequency	Field Strength (microvolts/meter)	Measurement Distance (meters)	Detector		
	Above 1GHz	500	3	Average		
	5000	3	Peak			
<b>Test setup:</b>	For radiated emissions below 30MHz					
	30MHz to 1GHz					

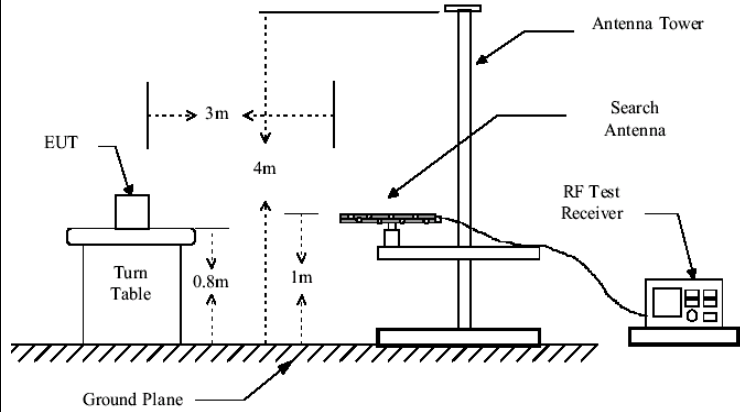

Above 1GHz

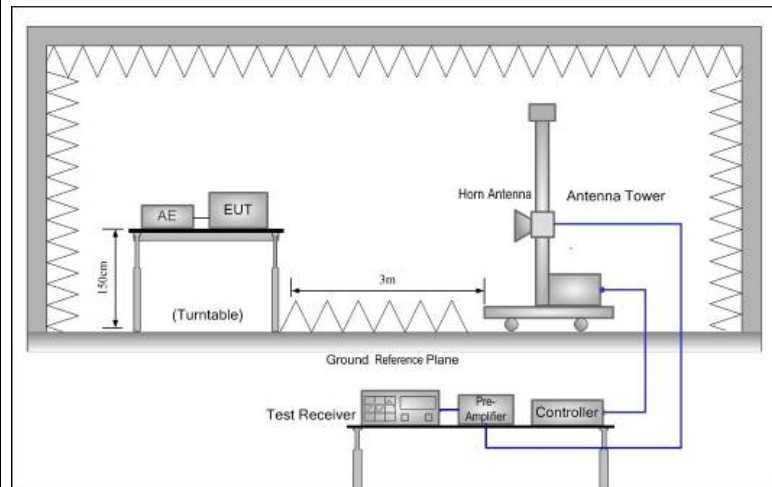

**Test Procedure:**

1. For the radiated emission test below 1GHz:  
 The EUT was placed on a turntable with 0.8 meter above ground. The EUT was set 3 meters from the interference receiving antenna, which was mounted on the top of a variable height antenna tower. The EUT was arranged to its worst case and then tune the antenna tower (from 1 m to 4 m) and turntable (from 0 degree to 360 degrees) to find the maximum reading. A pre-amp and a high PASS filter are used for the test in order to get better signal level.  
 For the radiated emission test above 1GHz:  
 Place the measurement antenna on a turntable with 1.5 meter above ground, which is away from each area of the EUT determined to be a source of emissions at the specified measurement distance, while keeping the measurement antenna aimed at the source of emissions at each frequency of significant emissions, with polarization oriented for maximum response. The measurement antenna may have to be higher or lower than the EUT, depending on the radiation pattern of the emission and staying aimed at the emission source for receiving the maximum signal. The final measurement antenna elevation shall be that which





	<p>maximizes the emissions. The measurement antenna elevation for maximum emissions shall be restricted to a range of heights of from 1 m to 4 m above the ground or reference ground plane.</p> <ol style="list-style-type: none"><li>3. Corrected Reading: Antenna Factor + Cable Loss + Read Level - Preamp Factor = Level</li><li>4. For measurement below 1GHz, If the emission level of the EUT measured by the peak detector is 3 dB lower than the applicable limit, the peak emission level will be reported. Otherwise, the emission measurement will be repeated using the quasi-peak detector and reported.</li><li>5. Use the following spectrum analyzer settings:<ol style="list-style-type: none"><li>(1) Span shall wide enough to fully capture the emission being measured;</li><li>(2) Set RBW=100 kHz for <math>f &lt; 1</math> GHz; <math>VBW \geq RBW</math>; Sweep = auto; Detector function = peak; Trace = max hold;</li><li>(3) Set RBW = 1 MHz, VBW= 3MHz for <math>f \geq 1</math> GHz for peak measurement.</li></ol></li></ol> <p>For average measurement: VBW = 10 Hz, when duty cycle is no less than 98 percent. <math>VBW \geq 1/T</math>, when duty cycle is less than 98 percent where T is the minimum transmission duration over which the transmitter is on and is transmitting at its maximum power control level for the tested mode of operation.</p>
<b>Test results:</b>	PASS

**Test Instruments**

<b>Radiated Emission Test Site (966)</b>				
<b>Name of Equipment</b>	<b>Manufacturer</b>	<b>Model</b>	<b>Serial Number</b>	<b>Calibration Due</b>
Receiver	R&S	ESCI-7	HKE-010	Sep. 27, 2018
Spectrum analyzer	Agilent	N9020A	HKE-048	Sep. 27, 2018
Preamplifier	EMCI	EMC051845 SE	HKE-015	Sep. 27, 2018
Preamplifier	Agilent	83051A	HKE-016	Sep. 27, 2018
Loop antenna	Schwarzbeck	FMZB 1519 B	HKE-014	Sep. 26, 2019
Broadband antenna	Schwarzbeck	VULB 9163	HKE-012	Sep. 26, 2019
Horn antenna	Schwarzbeck	9120D	HKE-013	Sep. 26, 2019
Antenna Mast	Keleto	CC-A-4M	N/A	N/A
Position controller	Taiwan MF	MF7802	HKE-011	Sep. 27, 2018
Radiated test software	Tonscend	TS+ Rev 2.5.0.0	HKE-082	N/A
RF cable (9KHz-1GHz)	Times	381806-001	N/A	N/A
RF cable	Times	1-40G	HKE-034	Sep. 27, 2018

**Note:** The calibration interval of the above test instruments is 12 months and the calibrations are traceable to international system unit (SI).



**Test Data**

**Please refer to following diagram for individual  
Below 1GHz**

**Horizontal**

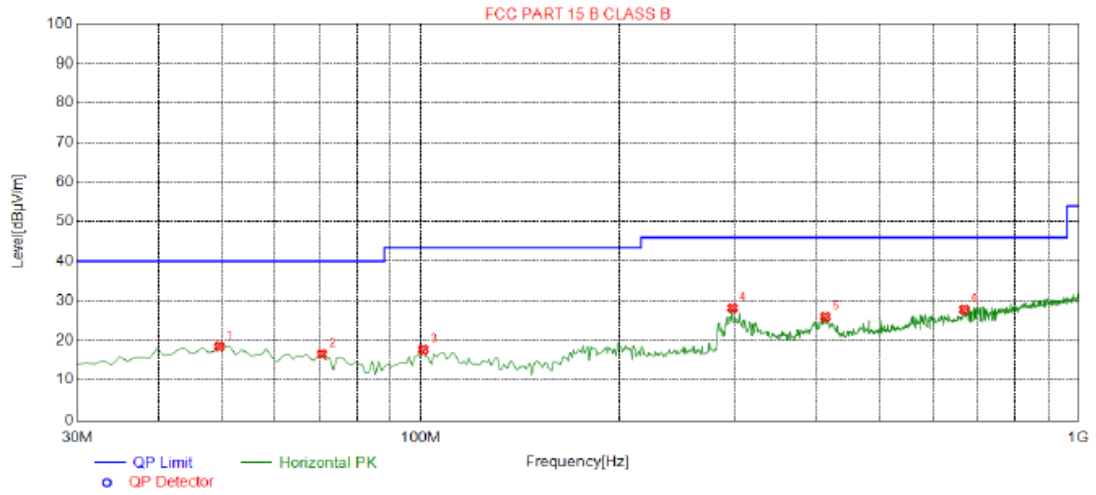

Suspected List								
NO.	Freq. [MHz]	Level [dBµV/m]	Factor [dB]	Limit [dBµV/m]	Margin [dB]	Height [cm]	Angle [°]	Polarity
1	49.4000	18.43	-13.65	40.00	21.57	100	316	Horizontal
2	70.7400	16.49	-17.80	40.00	23.51	100	300	Horizontal
3	100.810	17.68	-15.40	43.50	25.82	100	10	Horizontal
4	297.720	28.20	-12.76	46.00	17.80	100	274	Horizontal
5	412.180	26.00	-10.18	46.00	20.00	100	281	Horizontal
6	670.200	27.81	-4.57	46.00	18.19	100	287	Horizontal

Remark: Transd = Cable lose + Antenna factor - Pre-amplifier; Margin = Limit – Level



Vertical

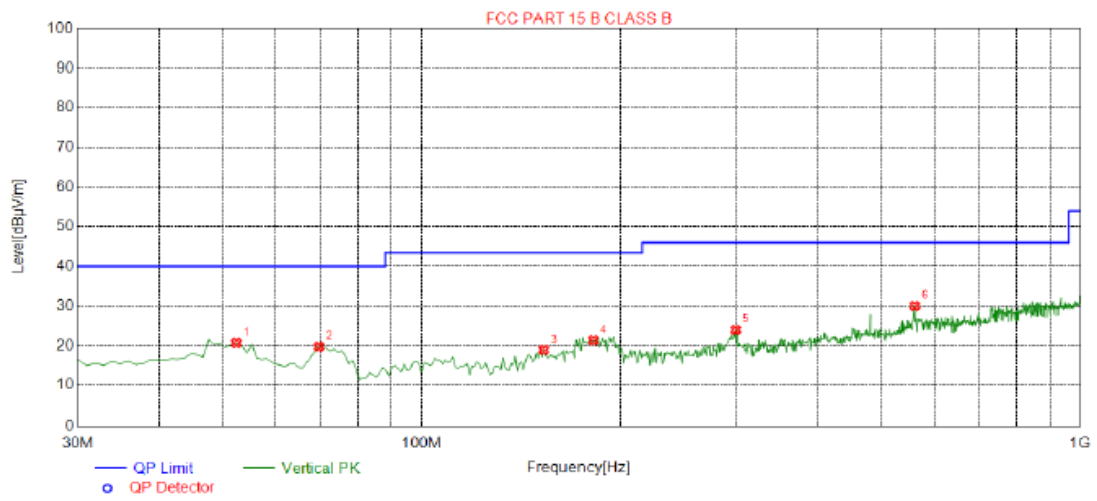

Suspected List								
NO.	Freq. [MHz]	Level [dBµV/m]	Factor [dB]	Limit [dBµV/m]	Margin [dB]	Height [cm]	Angle [°]	Polarity
1	52.3100	20.67	-14.00	40.00	19.33	100	319	Vertical
2	69.7700	19.78	-17.61	40.00	20.22	100	2	Vertical
3	153.190	18.93	-18.71	43.50	24.57	100	300	Vertical
4	182.290	21.38	-16.66	43.50	22.12	100	266	Vertical
5	299.660	24.01	-12.74	46.00	21.99	100	222	Vertical
6	560.590	30.05	-6.66	46.00	15.95	100	1	Vertical

Remark: Transd = Cable lose + Antenna factor - Pre-amplifier; Margin = Limit – Level

**Above 1GHz****RADIATED EMISSION TEST**

LOW CH1 (802.11b Mode)/2412

Horizontal:

Frequency	Reading Result	Factor	Emission Level	Limits	Margin	Detector Type
(MHz)	(dB $\mu$ V)	(dB)	(dB $\mu$ V/m)	(dB $\mu$ V/m)	(dB)	
4824	66.31	-3.64	62.67	74	-11.33	peak
4824	49.11	-3.64	45.47	54	-8.53	AVG
7236	56.36	-0.95	55.41	74	-18.59	peak
7236	43.66	-0.95	42.71	54	-11.29	AVG

Remark: Factor = Antenna Factor + Cable Loss – Pre-amplifier.

Vertical:

Frequency	Reading Result	Factor	Emission Level	Limits	Margin	Detector Type
(MHz)	(dB $\mu$ V)	(dB)	(dB $\mu$ V/m)	(dB $\mu$ V/m)	(dB)	
4824	65.22	-3.64	61.58	74	-12.42	peak
4824	48.03	-3.64	44.39	54	-9.61	AVG
7236	57.20	-0.95	56.25	74	-17.75	peak
7236	45.15	-0.95	44.2	54	-9.8	AVG

Remark: Factor = Antenna Factor + Cable Loss – Pre-amplifier.



MID CH6 (802.11b Mode)/2437

Horizontal:

Frequency	Reading Result	Factor	Emission Level	Limits	Margin	Detector Type
(MHz)	(dB $\mu$ V)	(dB)	(dB $\mu$ V/m)	(dB $\mu$ V/m)	(dB)	
4874	63.31	-3.51	59.8	74	-14.2	peak
4874	49.17	-3.51	45.66	54	-8.34	AVG
7311	57.40	-0.82	56.58	74	-17.42	peak
7311	44.22	-0.82	43.4	54	-10.6	AVG

Remark: Factor = Antenna Factor + Cable Loss – Pre-amplifier.

Vertical:

Frequency	Reading Result	Factor	Emission Level	Limits	Margin	Detector Type
(MHz)	(dB $\mu$ V)	(dB)	(dB $\mu$ V/m)	(dB $\mu$ V/m)	(dB)	
4874	65.23	-3.51	61.72	74	-12.28	peak
4874	47.74	-3.51	44.23	54	-9.77	AVG
7311	57.78	-0.82	56.96	74	-17.04	peak
7311	42.90	-0.82	42.08	54	-11.92	AVG

Remark: Factor = Antenna Factor + Cable Loss – Pre-amplifier.



## HIGH CH11 (802.11b Mode)/2462

Horizontal:

Frequency (MHz)	Reading Result (dB $\mu$ V)	Factor (dB)	Emission Level (dB $\mu$ V/m)	Limits (dB $\mu$ V/m)	Margin (dB)	Detector Type
4924	63.06	-3.43	59.63	74	-14.37	peak
4924	46.24	-3.43	42.81	54	-11.19	AVG
7386	58.43	-0.75	57.68	74	-16.32	peak
7386	43.95	-0.75	43.2	54	-10.8	AVG

Remark: Factor = Antenna Factor + Cable Loss – Pre-amplifier.

Vertical:

Frequency (MHz)	Reading Result (dB $\mu$ V)	Factor (dB)	Emission Level (dB $\mu$ V/m)	Limits (dB $\mu$ V/m)	Margin (dB)	Detector Type
4924	63.09	-3.43	59.66	74	-14.34	peak
4924	47.02	-3.43	43.59	54	-10.41	AVG
7386	56.19	-0.75	55.44	74	-18.56	peak
7386	42.24	-0.75	41.49	54	-12.51	AVG

Remark: Factor = Antenna Factor + Cable Loss – Pre-amplifier.

Remark:

(1) Measuring frequencies from 1 GHz to the 25 GHz.

(2) "F" denotes fundamental frequency; "H" denotes spurious frequency. "E" denotes band edge frequency.

(3) \* denotes emission frequency which appearing within the Restricted Bands specified in provision of 15.205, then the general radiated emission limits in 15.209 apply.

(4) Data of measurement within this frequency range shown "---" in the table above means the reading of emissions are attenuated more than 20dB below the permissible limits or the field strength is too small to be measured.

(5) The IF bandwidth of EMI Test Receiver between 30MHz to 1GHz was 120KHz, 1 MHz for measuring above 1 GHz, below 30MHz was 10KHz.

(6) When the test results of Peak Detected below the limits of Average Detected, the Average Detected is not need completed. For example: Top Channel at Fundamental 73.16dBuV/m(PK Value) &lt;93.98(AV Limit), at harmonic 53.20 dBuV/m(PK Value) &lt;54 dBuV/m(AV Limit), the Average Detected not need to completed.



LOW CH1 (802.11g Mode)/2412

Horizontal:

Frequency	Reading Result	Factor	Emission Level	Limits	Margin	Detector Type
(MHz)	(dB $\mu$ V)	(dB)	(dB $\mu$ V/m)	(dB $\mu$ V/m)	(dB)	
4824	64.41	-3.64	60.77	74	-13.23	peak
4824	49.09	-3.64	45.45	54	-8.55	AVG
7236	58.85	-0.95	57.9	74	-16.1	peak
7236	45.20	-0.95	44.25	54	-9.75	AVG

Remark: Factor = Antenna Factor + Cable Loss – Pre-amplifier.

Vertical:

Frequency	Reading Result	Factor	Emission Level	Limits	Margin	Detector Type
(MHz)	(dB $\mu$ V)	(dB)	(dB $\mu$ V/m)	(dB $\mu$ V/m)	(dB)	
4824	61.76	-3.64	58.12	74	-15.88	peak
4824	46.82	-3.64	43.18	54	-10.82	AVG
7236	59.62	-0.95	58.67	74	-15.33	peak
7236	43.95	-0.95	43	54	-11	AVG

Remark: Factor = Antenna Factor + Cable Loss – Pre-amplifier.





MID CH6 (802.11g Mode)/2437

Horizontal:

Frequency	Reading Result	Factor	Emission Level	Limits	Margin	Detector Type
(MHz)	(dB $\mu$ V)	(dB)	(dB $\mu$ V/m)	(dB $\mu$ V/m)	(dB)	
4874	64.17	-3.51	60.66	74	-13.34	peak
4874	47.47	-3.51	43.96	54	-10.04	AVG
7311	58.86	-0.82	58.04	74	-15.96	peak
7311	45.25	-0.82	44.43	54	-9.57	AVG

Remark: Factor = Antenna Factor + Cable Loss – Pre-amplifier.

Vertical:

Frequency	Reading Result	Factor	Emission Level	Limits	Margin	Detector Type
(MHz)	(dB $\mu$ V)	(dB)	(dB $\mu$ V/m)	(dB $\mu$ V/m)	(dB)	
4874	63.82	-3.51	60.31	74	-13.69	peak
4874	48.51	-3.51	45	54	-9	AVG
7311	56.42	-0.82	55.6	74	-18.4	peak
7311	42.91	-0.82	42.09	54	-11.91	AVG

Remark: Factor = Antenna Factor + Cable Loss – Pre-amplifier.



## HIGH CH11 (802.11g Mode)/2462

Horizontal:

Frequency (MHz)	Reading Result (dB $\mu$ V)	Factor (dB)	Emission Level (dB $\mu$ V/m)	Limits (dB $\mu$ V/m)	Margin (dB)	Detector Type
4924	61.98	-3.43	58.55	74	-15.45	peak
4924	48.12	-3.43	44.69	54	-9.31	AVG
7386	58.27	-0.75	57.52	74	-16.48	peak
7386	42.57	-0.75	41.82	54	-12.18	AVG

Remark: Factor = Antenna Factor + Cable Loss – Pre-amplifier.

Vertical:

Frequency (MHz)	Reading Result (dB $\mu$ V)	Factor (dB)	Emission Level (dB $\mu$ V/m)	Limits (dB $\mu$ V/m)	Margin (dB)	Detector Type
4924	62.91	-3.43	59.48	74	-14.52	peak
4924	47.61	-3.43	44.18	54	-9.82	AVG
7386	57.52	-0.75	56.77	74	-17.23	peak
7386	41.58	-0.75	40.83	54	-13.17	AVG

Remark: Factor = Antenna Factor + Cable Loss – Pre-amplifier.

## Remark:

- (1) Measuring frequencies from 1 GHz to the 25 GHz.
- (2) "F" denotes fundamental frequency; "H" denotes spurious frequency. "E" denotes band edge frequency.
- (3) \* denotes emission frequency which appearing within the Restricted Bands specified in provision of 15.205, then the general radiated emission limits in 15.209 apply.
- (4) Data of measurement within this frequency range shown "---" in the table above means the reading of emissions are attenuated more than 20dB below the permissible limits or the field strength is too small to be measured.
- (5) The IF bandwidth of EMI Test Receiver between 30MHz to 1GHz was 120KHz, 1 MHz for measuring above 1 GHz, below 30MHz was 10KHz.
- (6) When the test results of Peak Detected below the limits of Average Detected, the Average Detected is not need completed. For example: Top Channel at Fundamental 73.16dBuV/m(PK Value) <93.98(AV Limit), at harmonic 53.20 dBuV/m(PK Value) <54 dBuV/m(AV Limit), the Average Detected not need to completed.



LOW CH1 (802.11n/H20 Mode)/2412

Horizontal:

Frequency	Reading Result	Factor	Emission Level	Limits	Margin	Detector Type
(MHz)	(dB $\mu$ V)	(dB)	(dB $\mu$ V/m)	(dB $\mu$ V/m)	(dB)	
4824	63.90	-3.64	60.26	74	-13.74	peak
4824	46.42	-3.64	42.78	54	-11.22	AVG
7236	58.67	-0.95	57.72	74	-16.28	peak
7236	42.96	-0.95	42.01	54	-11.99	AVG

Remark: Factor = Antenna Factor + Cable Loss – Pre-amplifier.

Vertical:

Frequency	Reading Result	Factor	Emission Level	Limits	Margin	Detector Type
(MHz)	(dB $\mu$ V)	(dB)	(dB $\mu$ V/m)	(dB $\mu$ V/m)	(dB)	
4824	63.23	-3.64	59.59	74	-14.41	peak
4824	47.60	-3.64	43.96	54	-10.04	AVG
7236	58.29	-0.95	57.34	74	-16.66	peak
7236	43.98	-0.95	43.03	54	-10.97	AVG

Remark: Factor = Antenna Factor + Cable Loss – Pre-amplifier.



MID CH6 (802.11n/H20 Mode)/2437

Horizontal:

Frequency	Reading Result	Factor	Emission Level	Limits	Margin	Detector Type
(MHz)	(dB $\mu$ V)	(dB)	(dB $\mu$ V/m)	(dB $\mu$ V/m)	(dB)	
4874	62.46	-3.51	58.95	74.00	-15.05	peak
4874	47.38	-3.51	43.87	54.00	-10.13	AVG
7311	57.67	-0.82	56.85	74.00	-17.15	peak
7311	44.57	-0.82	43.75	54.00	-10.25	AVG

Remark: Factor = Antenna Factor + Cable Loss – Pre-amplifier.

Vertical:

Frequency	Reading Result	Factor	Emission Level	Limits	Margin	Detector Type
(MHz)	(dB $\mu$ V)	(dB)	(dB $\mu$ V/m)	(dB $\mu$ V/m)	(dB)	
4874	63.19	-3.51	59.68	74.00	-14.32	peak
4874	46.71	-3.51	43.20	54.00	-10.80	AVG
7311	57.21	-0.82	56.39	74.00	-17.61	peak
7311	42.28	-0.82	41.46	54.00	-12.54	AVG

Remark: Factor = Antenna Factor + Cable Loss – Pre-amplifier.



HIGH CH11 (802.11n/H20 Mode)/2462

Horizontal:

Frequency	Reading Result	Factor	Emission Level	Limits	Margin	Detector Type
(MHz)	(dB $\mu$ V)	(dB)	(dB $\mu$ V/m)	(dB $\mu$ V/m)	(dB)	
4924	62.97	-3.43	59.54	74	-14.46	peak
4924	46.57	-3.43	43.14	54	-10.86	AVG
7386	56.98	-0.75	56.23	74	-17.77	peak
7386	41.33	-0.75	40.58	54	-13.42	AVG

Remark: Factor = Antenna Factor + Cable Loss – Pre-amplifier.

Vertical:

Frequency	Reading Result	Factor	Emission Level	Limits	Margin	Detector Type
(MHz)	(dB $\mu$ V)	(dB)	(dB $\mu$ V/m)	(dB $\mu$ V/m)	(dB)	
4924	63.32	-3.43	59.89	74	-14.11	peak
4924	45.83	-3.43	42.4	54	-11.6	AVG
7386	57.37	-0.75	56.62	74	-17.38	peak
7386	42.79	-0.75	42.04	54	-11.96	AVG

Remark: Factor = Antenna Factor + Cable Loss – Pre-amplifier.

Remark:

- (1) Measuring frequencies from 1 GHz to the 25 GHz.
- (2) "F" denotes fundamental frequency; "H" denotes spurious frequency. "E" denotes band edge frequency.
- (3) \* denotes emission frequency which appearing within the Restricted Bands specified in provision of 15.205, then the general radiated emission limits in 15.209 apply.
- (4) Data of measurement within this frequency range shown "---" in the table above means the reading of emissions are attenuated more than 20dB below the permissible limits or the field strength is too small to be measured.
- (5) The IF bandwidth of EMI Test Receiver between 30MHz to 1GHz was 120KHz, 1 MHz for measuring above 1 GHz, below 30MHz was 10KHz.
- (6) When the test results of Peak Detected below the limits of Average Detected, the Average Detected is not need completed. For example: Top Channel at Fundamental 73.16dBuV/m(PK Value) <93.98(AV Limit), at harmonic 53.20 dBuV/m(PK Value) <54 dBuV/m(AV Limit), the Average Detected not need to completed.

**Test Result of Radiated Spurious at Band edges**

Operation Mode:  
802.11b Mode TX CH Low (2412MHz)

Horizontal

Frequency	Reading Result	Factor	Emission Level	Limits	Margin	Detector Type
(MHz)	(dB $\mu$ V)	(dB)	(dB $\mu$ V/m)	(dB $\mu$ V/m)	(dB)	
2310.00	57.09	-5.81	51.28	74	-22.72	peak
2310.00	/	-5.81	/	54	/	AVG
2390.00	64.01	-5.84	58.17	74	-15.83	peak
2390.00	47.65	-5.84	41.81	54	-12.19	AVG
2400.00	65.47	-5.84	59.63	74	-14.37	peak
2400.00	48.25	-5.84	42.41	54	-11.59	AVG

Remark: Factor = Antenna Factor + Cable Loss – Pre-amplifier.

Vertical:

Frequency	Reading Result	Factor	Emission Level	Limits	Margin	Detector Type
(MHz)	(dB $\mu$ V)	(dB)	(dB $\mu$ V/m)	(dB $\mu$ V/m)	(dB)	
2310.00	57.10	-5.81	51.29	74	-22.71	peak
2310.00	/	-5.81	/	54	/	AVG
2390.00	62.81	-5.84	56.97	74	-17.03	peak
2390.00	47.48	-5.84	41.64	54	-12.36	AVG
2400.00	63.39	-5.84	57.55	74	-16.45	peak
2400.00	48.45	-5.84	42.61	54	-11.39	AVG

Remark: Factor = Antenna Factor + Cable Loss – Pre-amplifier.



Operation Mode: TX CH High (2462MHz)

Horizontal

Frequency	Reading Result	Factor	Emission Level	Limits	Margin	Detector Type
(MHz)	(dB $\mu$ V)	(dB)	(dB $\mu$ V/m)	(dB $\mu$ V/m)	(dB)	
2483.50	57.26	-5.81	51.45	74	-22.55	peak
2483.50	/	-5.81	/	54	/	AVG
2500.00	54.36	-6.06	48.3	74	-25.7	peak
2500.00	/	-6.06	/	54	/	AVG
Remark: Factor = Antenna Factor + Cable Loss – Pre-amplifier.						

Vertical:

Frequency	Reading Result	Factor	Emission Level	Limits	Margin	Detector Type
(MHz)	(dB $\mu$ V)	(dB)	(dB $\mu$ V/m)	(dB $\mu$ V/m)	(dB)	
2483.50	57.85	-5.81	52.04	74	-21.96	peak
2483.50	/	-5.81	/	54	/	AVG
2500.00	55.07	-6.06	49.01	74	-24.99	peak
2500.00	/	-6.06	/	54	/	AVG
Remark: Factor = Antenna Factor + Cable Loss – Pre-amplifier.						
Remark: All the other emissions not reported were too low to read and deemed to comply with FCC limit.						



Operation Mode: 802.11g Mode TX CH Low (2412MHz)

## Horizontal

Frequency	Reading Result	Factor	Emission Level	Limits	Margin	Detector Type
(MHz)	(dB $\mu$ V)	(dB)	(dB $\mu$ V/m)	(dB $\mu$ V/m)	(dB)	
2310.00	56.68	-5.81	50.87	74	-23.13	peak
2310.00	/	-5.81	/	54	/	AVG
2390.00	62.52	-5.84	56.68	74	-17.32	peak
2390.00	46.18	-5.84	40.34	54	-13.66	AVG
2400.00	63.28	-5.84	57.44	74	-16.56	peak
2400.00	47.62	-5.84	41.78	54	-12.22	AVG

Remark: Factor = Antenna Factor + Cable Loss – Pre-amplifier.

## Vertical:

Frequency	Reading Result	Factor	Emission Level	Limits	Margin	Detector Type
(MHz)	(dB $\mu$ V)	(dB)	(dB $\mu$ V/m)	(dB $\mu$ V/m)	(dB)	
2310.00	54.86	-5.81	49.05	74	-24.95	peak
2310.00	/	-5.81	/	54	/	AVG
2390.00	60.57	-5.84	54.73	74	-19.27	peak
2390.00	45.82	-5.84	39.98	54	-14.02	AVG
2400.00	61.74	-5.84	55.9	74	-18.1	peak
2400.00	46.52	-5.84	40.68	54	-13.32	AVG

Remark: Factor = Antenna Factor + Cable Loss – Pre-amplifier.





Operation Mode: TX CH High (2462MHz)

Horizontal

Frequency	Reading Result	Factor	Emission Level	Limits	Margin	Detector Type
(MHz)	(dB $\mu$ V)	(dB)	(dB $\mu$ V/m)	(dB $\mu$ V/m)	(dB)	
2483.50	56.93	-5.65	51.28	74	-22.72	peak
2483.50	/	-5.65	/	54	/	AVG
2500.00	54.28	-5.65	48.63	74	-25.37	peak
2500.00	/	-5.65	/	54	/	AVG

Remark: Factor = Antenna Factor + Cable Loss – Pre-amplifier.

Vertical:

Frequency	Reading Result	Factor	Emission Level	Limits	Margin	Detector Type
(MHz)	(dB $\mu$ V)	(dB)	(dB $\mu$ V/m)	(dB $\mu$ V/m)	(dB)	
2483.50	55.64	-5.65	49.99	74	-24.01	peak
2483.50	/	-5.65	/	54	/	AVG
2500.00	53.32	-5.65	47.67	74	-26.33	peak
2500.00	/	-5.65	/	54	/	AVG

Remark: Factor = Antenna Factor + Cable Loss – Pre-amplifier.

Remark: All the other emissions not reported were too low to read and deemed to comply with FCC limit.



Operation Mode: 802.11n/H20 Mode TX CH Low (2412MHz)

## Horizontal

Frequency	Reading Result	Factor	Emission Level	Limits	Margin	Detector Type
(MHz)	(dB $\mu$ V)	(dB)	(dB $\mu$ V/m)	(dB $\mu$ V/m)	(dB)	
2310.00	58.07	-5.81	52.26	74	-21.74	peak
2310.00	/	-5.81	/	54	/	AVG
2390.00	62.39	-5.84	56.55	74	-17.45	peak
2390.00	46.73	-5.84	40.89	54	-13.11	AVG
2400.00	63.82	-5.84	57.98	74	-16.02	peak
2400.00	47.55	-5.84	41.71	54	-12.29	AVG

Remark: Factor = Antenna Factor + Cable Loss – Pre-amplifier.

## Vertical:

Frequency	Reading Result	Factor	Emission Level	Limits	Margin	Detector Type
(MHz)	(dB $\mu$ V)	(dB)	(dB $\mu$ V/m)	(dB $\mu$ V/m)	(dB)	
2310.00	57.41	-5.81	51.6	74	-22.4	peak
2310.00	/	-5.81	/	54	/	AVG
2390.00	61.68	-5.84	55.84	74	-18.16	peak
2390.00	45.52	-5.84	39.68	54	-14.32	AVG
2400.00	62.43	-5.84	56.59	74	-17.41	peak
2400.00	46.38	-5.84	40.54	54	-13.46	AVG

Remark: Factor = Antenna Factor + Cable Loss – Pre-amplifier.



Operation Mode: TX CH High (2462MHz)

Horizontal

Frequency	Reading Result	Factor	Emission Level	Limits	Margin	Detector Type
(MHz)	(dB $\mu$ V)	(dB)	(dB $\mu$ V/m)	(dB $\mu$ V/m)	(dB)	
2483.50	55.74	-5.65	50.09	74	-23.91	peak
2483.50	/	-5.65	/	54	/	AVG
2500.00	53.32	-5.65	47.67	74	-26.33	peak
2500.00	/	-5.65	/	54	/	AVG

Remark: Factor = Antenna Factor + Cable Loss – Pre-amplifier.

Vertical:

Frequency	Reading Result	Factor	Emission Level	Limits	Margin	Detector Type
(MHz)	(dB $\mu$ V)	(dB)	(dB $\mu$ V/m)	(dB $\mu$ V/m)	(dB)	
2483.50	56.03	-5.65	50.38	74	-23.62	peak
2483.50	/	-5.65	/	54	/	AVG
2500.00	51.89	-5.65	46.24	74	-27.76	peak
2500.00	/	-5.65	/	54	/	AVG

Remark: Factor = Antenna Factor + Cable Loss – Pre-amplifier.

Remark: All the other emissions not reported were too low to read and deemed to comply with FCC limit.



## 4.6. ANTENNA REQUIREMENT

### Standard Applicable

For intentional device, according to FCC 47 CFR Section 15.203, an intentional radiator shall be designed to ensure that no antenna other than that furnished by the responsible party shall be used with the device. And according to FCC 47 CFR Section 15.247, if transmitting antennas of directional gain greater than 6dBi are used, the power shall be reduced by the amount in dB that the directional gain of the antenna exceeds 6dBi.

### Refer to statement below for compliance.

The manufacturer may design the unit so that the user can replace a broken antenna, but the use of a standard antenna jack or electrical connector is prohibited. Further, this requirement does not apply to intentional radiators that must be professionally installed.

### Antenna Connected Construction

The antenna used in this product is a PCB Antenna, The directional gains of antenna used for transmitting is 1dBi.

### WIFI ANTENNA

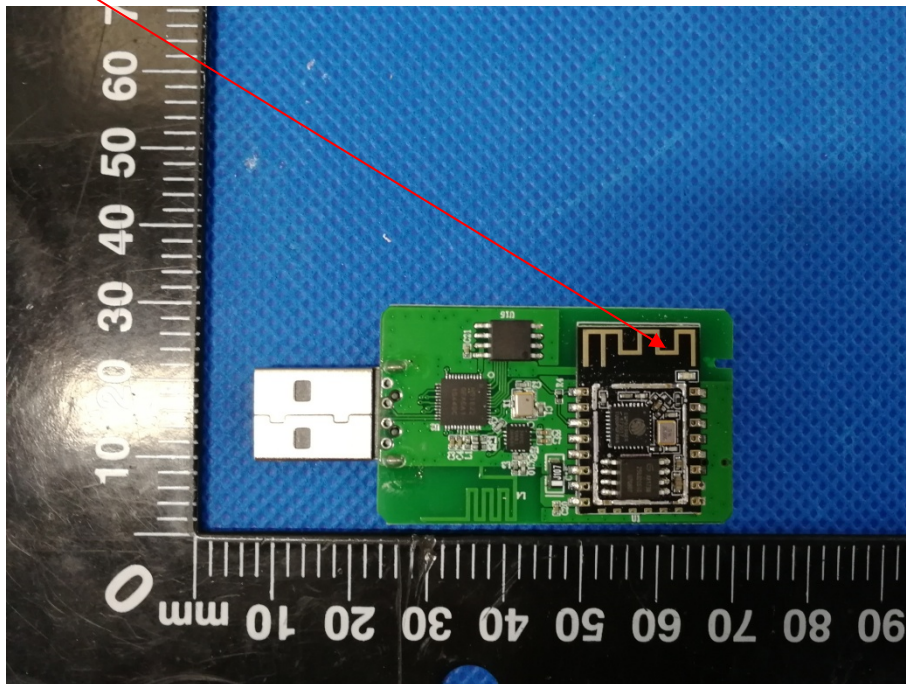

## 4.7. PHOTOGRAPH OF TEST

Radiated Emission

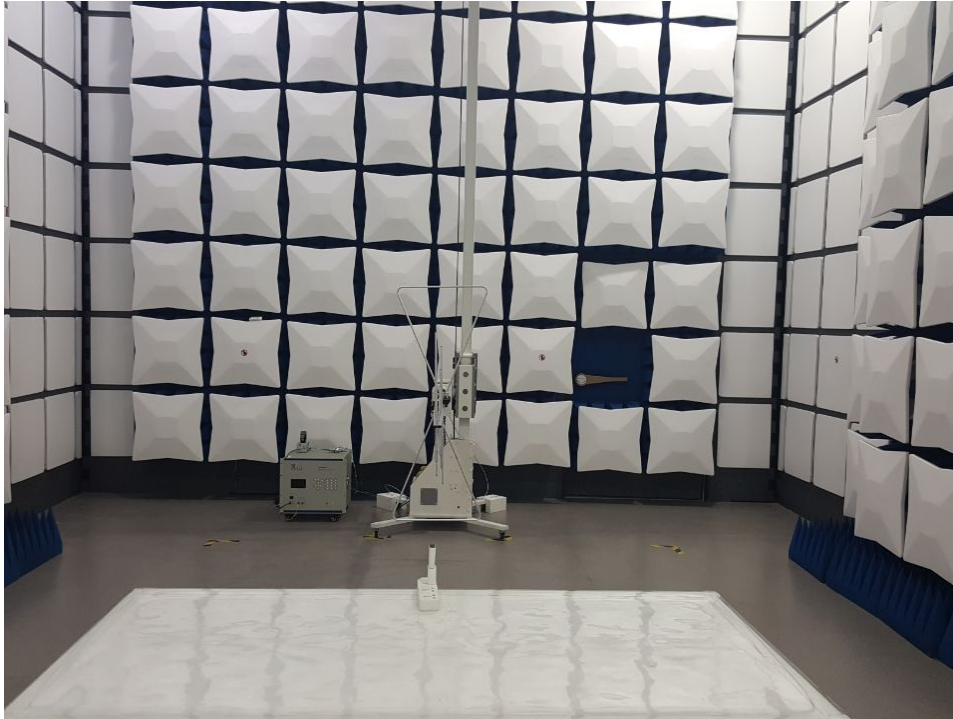



### Conducted Emission

