



Welletronics Communication Technology Limited

ADD: 1st, 2nd, and 3rd floors, No. 8 Tongfu Estate Industrial Zone, Xinshi Community, Dalang Street,
Longhua District, Shenzhen

	GTX03
1.GPS/ BT 2.Antenna Type:Metal frame antenna	
2023-8-9	R:A
RF:	Tel:

GPS/ BT SWR



Antenna size

units mm

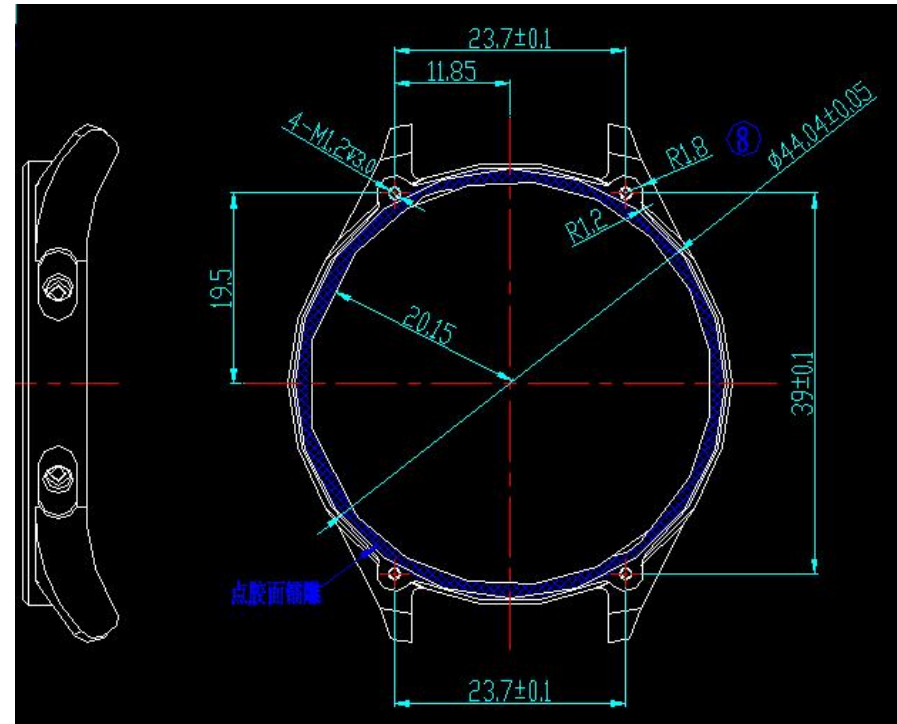
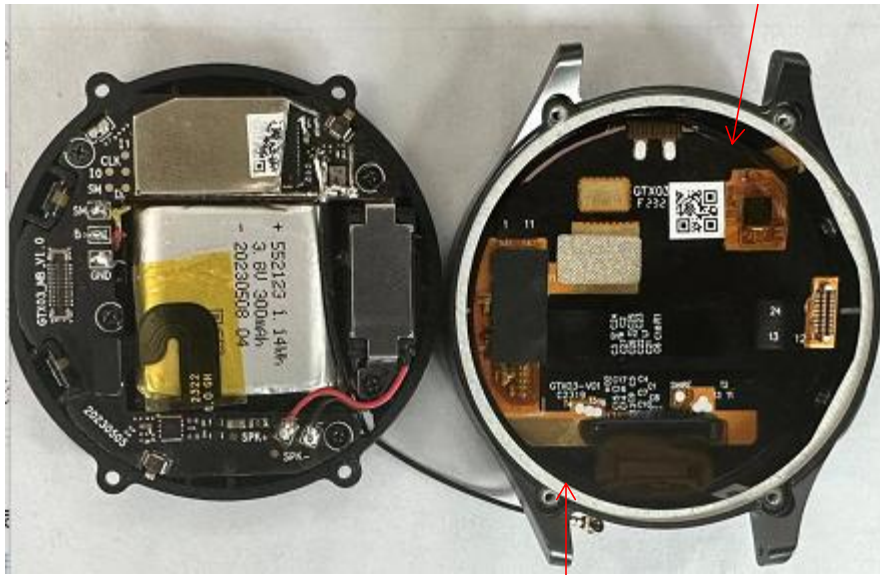

3 GPS /BT

GPS			
Freq (MHz)	Effi dB	Effi (%)	Gain
1550	-7.16	19.24	-1.27
1555	-7.17	19.2	-1.33
1560	-7.19	19.1	-1.48
1565	-7.2	19.03	-1.55
1570	-7.2	19.06	-1.53
1575	-7.18	19.14	-1.53
1580	-7.19	19.11	-1.53
1585	-7.27	18.73	-1.59
1590	-7.31	18.57	-1.58
1595	-7.39	18.23	-1.66
1600	-7.14	19.32	-1.48
BT			
Freq (MHz)	Effi dB	Effi (%)	Gain
2400	-8.41	14.41	-2.74
2410	-8.43	14.37	-2.77
2420	-8.46	14.25	-2.89
2430	-8.5	14.14	-3
2440	-8.49	14.15	-3.03
2450	-8.46	14.25	-3.03
2460	-8.42	14.38	-3.03
2470	-8.36	14.6	-3.01
2480	-8.23	15.03	-2.94
2490	-8.25	14.98	-2.96

BT free space radiation

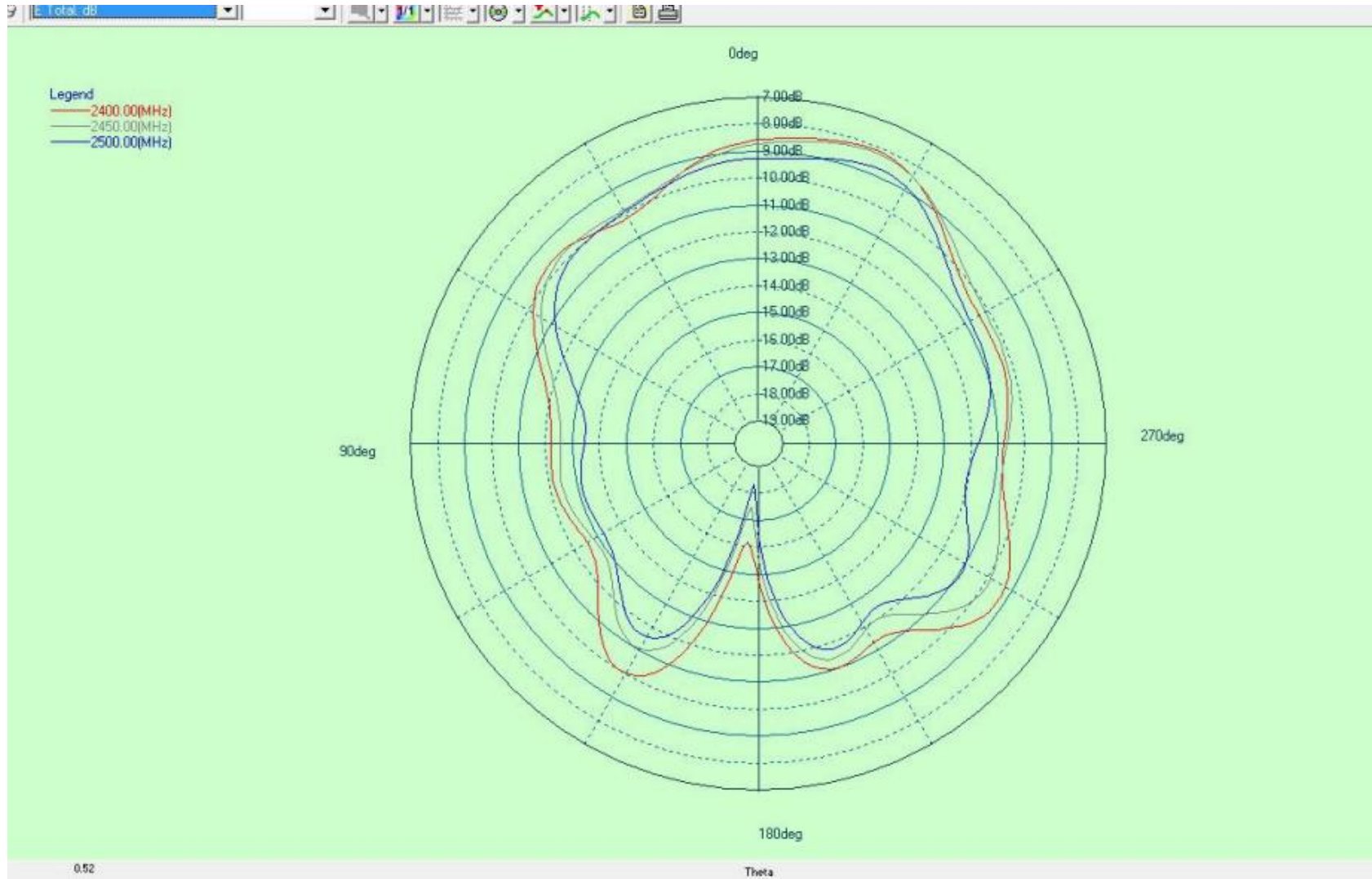

Legend
— 2400.00(MHz)
— 2450.00(MHz)
— 2500.00(MHz)

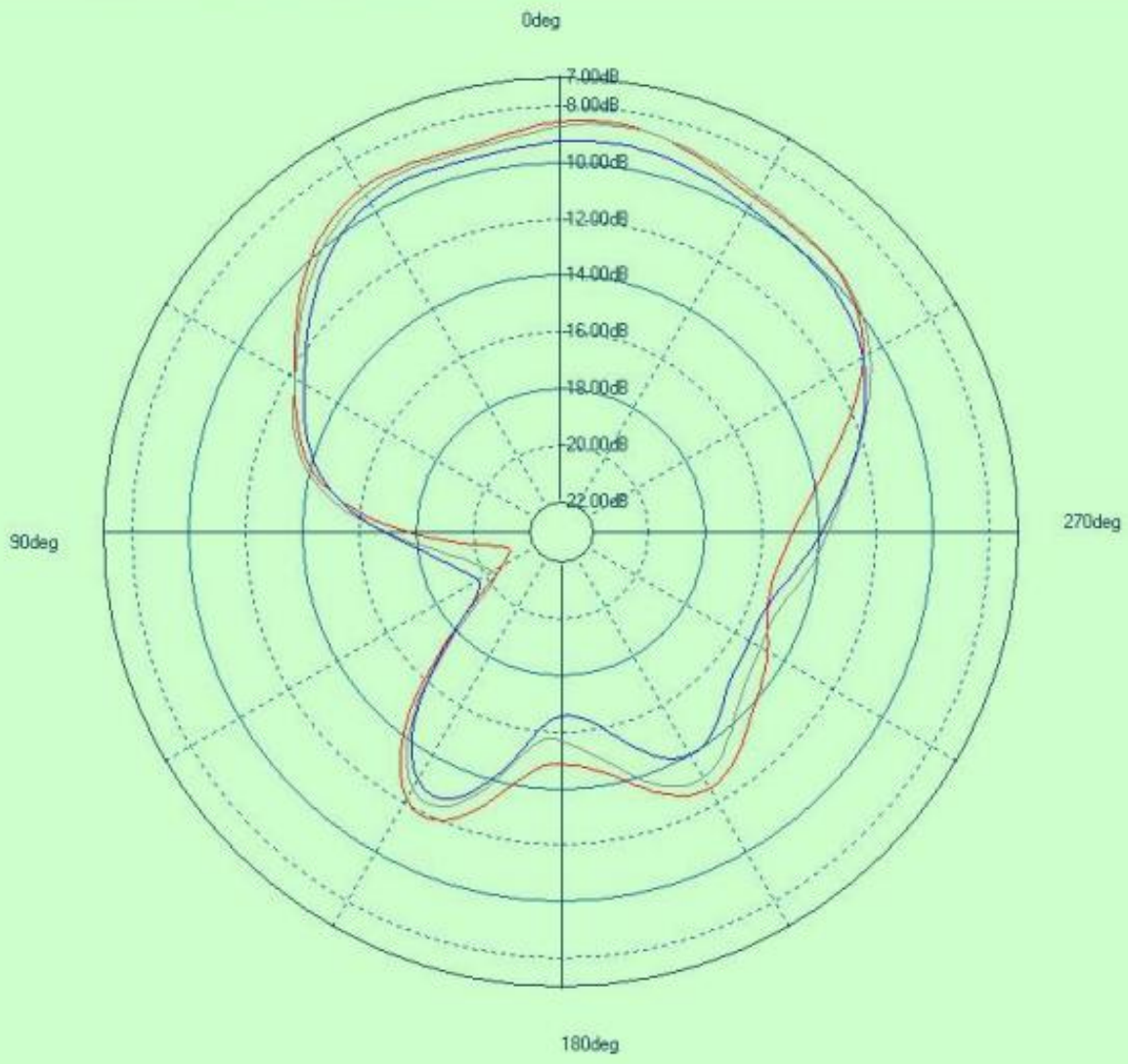

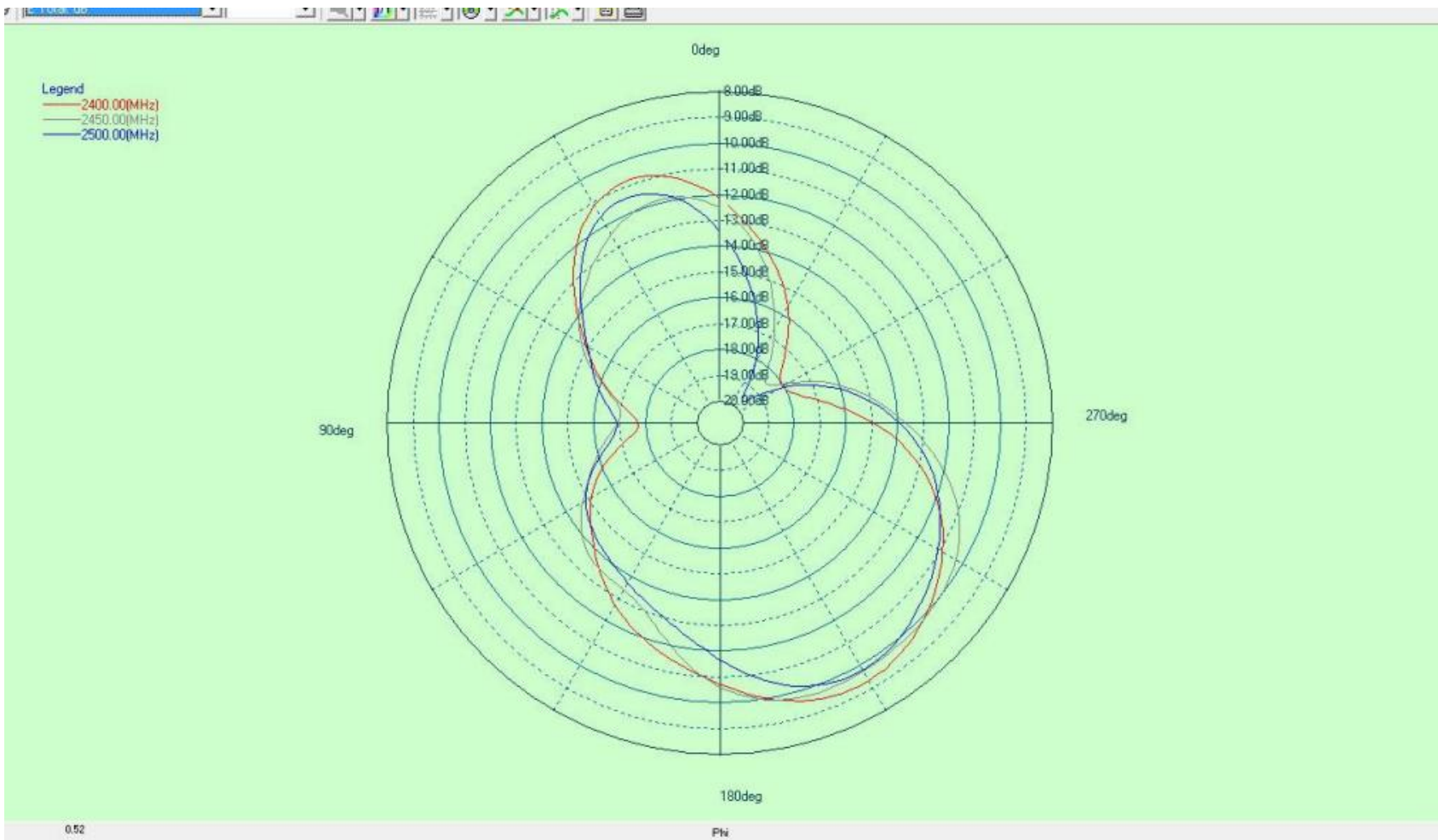

5

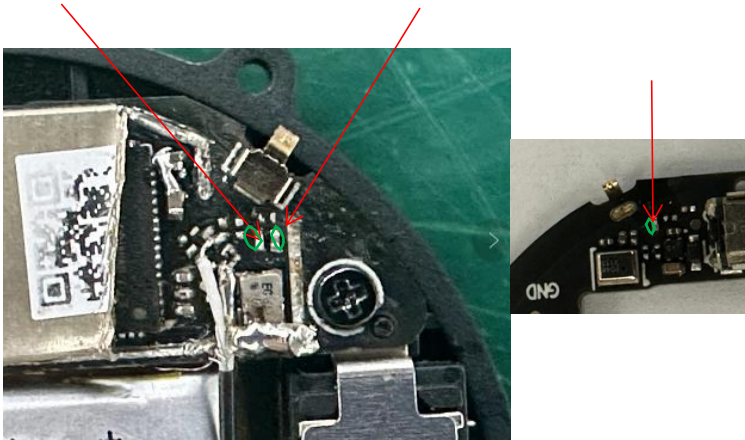
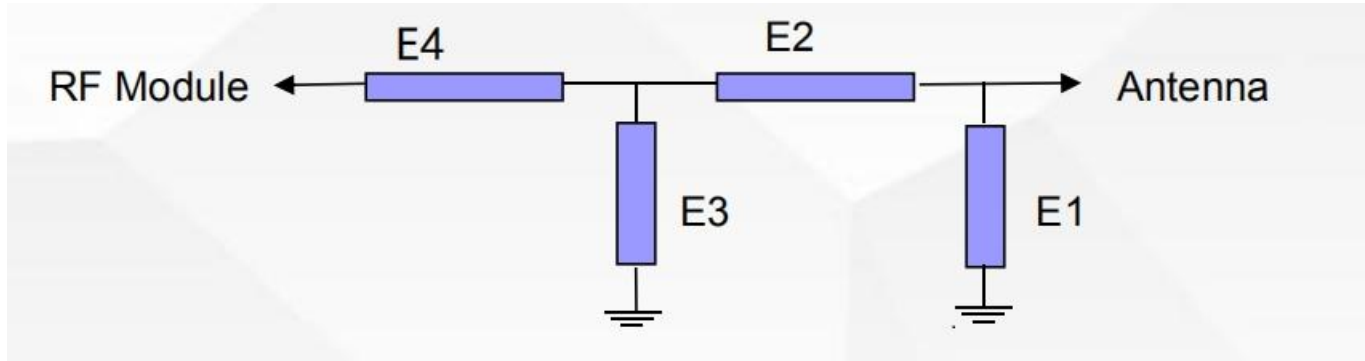

Element	Value
E1	1pF
E2	5.1nH
E3	N/A
E4	

**1st, 2nd, and 3rd floors, No. 8 Tongfu Estate Industrial Zone, Xinshi Community, Dalang Street, Longhua District,
Shenzhen**

Welletronics Communication Technology Co., LTD

Thank you !