

flexLock

Safety locking device



Described product

flexLock

Manufacturer

SICK AG
Erwin-Sick-Str. 1
79183 Waldkirch
Germany

Legal information

This work is protected by copyright. Any rights derived from the copyright shall be reserved for SICK AG. Reproduction of this document or parts of this document is only permissible within the limits of the legal determination of Copyright Law. Any modification, abridgment or translation of this document is prohibited without the express written permission of SICK AG.

The trademarks stated in this document are the property of their respective owner.

© SICK AG. All rights reserved.

Original document

This document is an original document of SICK AG.



Contents

1	About this document.....	5
1.1	Scope.....	5
1.2	Target groups of these operating instructions.....	5
1.3	Additional information.....	5
1.4	Symbols and document conventions.....	5
2	Safety information.....	7
2.1	General safety notes.....	7
2.2	Intended use.....	7
2.3	Improper use.....	7
2.4	Requirements for the qualification of personnel.....	7
3	Product description.....	9
3.1	Design and function.....	9
3.2	Product characteristics.....	9
3.3	Manual unlocking.....	11
4	Project planning.....	13
4.1	Manufacturer of the machine.....	13
4.2	Operator of the machine.....	13
4.3	Design.....	13
4.4	Integration in the electrical control system.....	15
5	Mounting.....	18
5.1	Safety.....	18
5.2	Orientation of the safety switch.....	18
5.3	Mounting several safety switches.....	18
5.4	Mounting the safety switch.....	19
5.5	Mounting the actuator.....	19
6	Electrical installation.....	20
6.1	Safety.....	20
6.2	Notes on cULus.....	21
6.3	Device connection.....	21
6.4	Connection of a safe series connection.....	22
7	Commissioning.....	24
7.1	Teach-in.....	24
7.2	Testing.....	26
7.3	Regular thorough check.....	26
8	Operation.....	28
8.1	Actuating the mechanical unlocking mechanism.....	28
8.2	Preventing unintentional closing of the protective device.....	28

9	Maintenance.....	29
9.1	Cleaning.....	29
10	Troubleshooting.....	30
10.1	Safety.....	30
10.2	LED indicators.....	30
11	Decommissioning.....	34
11.1	Disposal.....	34
12	Technical data.....	35
12.1	Data sheet.....	35
12.2	Connecting cables.....	37
12.3	Safety switch dimensional drawings.....	38
12.4	Actuator dimensional drawings.....	38
12.5	Dimensional drawings of the mounting bracket.....	38
13	Ordering information.....	39
13.1	Scope of delivery.....	39
13.2	Ordering information.....	39
14	Accessories.....	40
14.1	Actuator.....	40
14.2	Connectivity.....	40
15	Annex.....	42
15.1	Compliance with EU directives.....	42
15.2	FCC and IC radio approval.....	43

1 About this document

1.1 Scope

These operating instructions are valid for the flexLock safety locking device.

This document is included with the following SICK part numbers (this document in all available language versions):

8025630

1.2 Target groups of these operating instructions

Some chapters of these operating instructions are intended for certain target groups. However, the entire operating instructions are relevant for intended use of the product.

Table 1: Target groups and selected chapters of these operating instructions

Target group	Chapters of these operating instructions
Project developers (planners, developers, designers)	"Project planning", page 13 "Technical data", page 35
Installers	"Mounting", page 18
Electricians	"Electrical installation", page 20
Safety experts (such as CE authorized representatives, compliance officers, people who test and approve the application)	"Project planning", page 13 "Commissioning", page 24 "Technical data", page 35
Operators	"Troubleshooting", page 30
Maintenance personnel	"Troubleshooting", page 30

1.3 Additional information

www.sick.com

The following information is available on the Internet:

- This document in other languages
- Data sheets and application examples
- CAD data and dimensional drawings
- Certificates (e.g. EU declaration of conformity)
- Guide for Safe Machinery Six steps to a safe machine

1.4 Symbols and document conventions

The following symbols and conventions are used in this document:

Safety notes and other notes



DANGER

Indicates a situation presenting imminent danger, which will lead to death or serious injuries if not prevented.



WARNING

Indicates a situation presenting possible danger, which may lead to death or serious injuries if not prevented.

**CAUTION**

Indicates a situation presenting possible danger, which may lead to moderate or minor injuries if not prevented.

**NOTICE**

Indicates a situation presenting possible danger, which may lead to property damage if not prevented.

**NOTE**

Indicates useful tips and recommendations.

Instructions to action

- ▶ The arrow denotes instructions to action.
- 1. The sequence of instructions for action is numbered.
- 2. Follow the order in which the numbered instructions are given.
- ✓ The check mark denotes the result of an instruction.

LED symbols

These symbols indicate the status of an LED:

- The LED is off.
- ◐ The LED is flashing.
- The LED is illuminated continuously.

2 Safety information

2.1 General safety notes

**DANGER**

If the safety component is integrated incorrectly, the dangerous state may be ended too late.

- ▶ Plan the integration of the safety component in accordance with the machine requirements, see "Project planning", page 13.

2.2 Intended use

The safety locking device is a locking unit with a safety locking function and is suitable for the following applications:

- Temporarily preventing access to a hazardous area
- Monitoring of movable physical guards
- Locking for process protection

In conjunction with a movable physical guard and the machine controller, the safety locking device prevents the protective device from being opened. The locking device remains locked for as long as the hazardous machine function is performed or until the production step has finished.

The product is only suitable for use in industrial environments.

Incorrect use, improper modification of or tampering with the safety locking device will invalidate any warranty from SICK AG; in addition, any responsibility and liability of SICK AG for damage and secondary damage caused by this is excluded.

2.3 Improper use

The safety locking device is not suitable, among other things, for the following ambient conditions:

- Outdoor areas
- Residential areas
- Vacuum
- High pressure
- Strong UV exposure
- Near low-frequency transponders (e.g., RFID)
- Near magnetic fields
- Increased radioactivity (> natural radioactivity)
- High sulfur concentration
- High salt concentration

2.4 Requirements for the qualification of personnel

The safety locking device must be planned in, installed, connected, commissioned, and serviced only by qualified safety personnel.

Project planning

For project planning, a person is considered competent when he/she has expertise and experience in the selection and use of protective devices on machines and is familiar with the relevant technical rules and national work safety regulations.

Mechanical mounting, electrical installation, and commissioning

For the task, a person is considered qualified when he/she has the expertise and experience in the relevant field and is sufficiently familiar with the application of the protective device on the machine to be able to assess whether it is in an operationally safe state.

Operation and maintenance

For operation and maintenance, a person is considered competent when he/she has the expertise and experience in the relevant field and is sufficiently familiar with the application of the protective device on the machine and has been instructed by the machine operator in its operation.

3 Product description

3.1 Design and function

Design

The safety locking device is a locking unit with a safety locking function. The safety locking device comprises a safety switch with transpondermonitoring and a coded actuator.

Function

The safety locking device is used on a movable physical guard. The safety switch is located on the frame of the movable guard, the actuator on the moving part. When the protective device is closed, the actuator is inserted into the safety switch. The safety switch reads the code of the actuator. If the code is valid, the safety locking function can be locked via a signal. The movable guard is held closed.

3.2 Product characteristics

3.2.1 Device overview

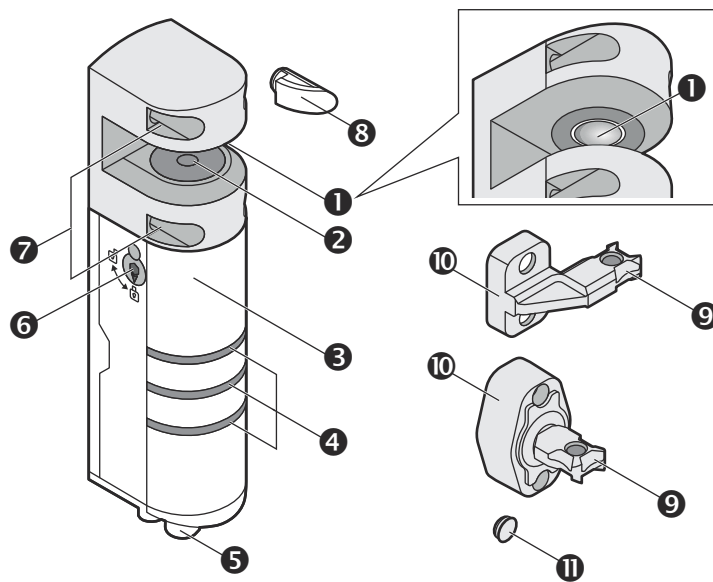

Figure 1: Device overview

- ① Guiding ball
- ② Locking bolt
- ③ Safety switch
- ④ LEDs
- ⑤ Connection
- ⑥ Auxiliary release
- ⑦ Mounting holes of the safety switch
- ⑧ Sealing plug for mounting holes of the safety switch
- ⑨ Actuator tongue
- ⑩ Mounting plate of the actuator
- ⑪ Sealing plug for mounting holes of the actuator

3.2.2 Locking principle

Overview

The method of locking depends on the safety locking device variant selected. There are two variants:

- Power to lock
- Power to release

Important information



DANGER

Hazard due to lack of effectiveness of the protective device

For power to lock variants only: In the event of a voltage drop, the locking device unlocks regardless of whether the dangerous state of the machine has ended.

- ▶ Do not use the safety switch in applications in which the dangerous state cannot be ended immediately (stopping/run-down time).
-

Power to lock

- Lock locking device: voltage at locking device input
- Unlock locking function: no voltage at locking device input

If voltage is interrupted, the locking device is unlocked and protective device can be opened immediately.

Power to release

- Lock locking device: no voltage at locking device input
- Unlock locking device: voltage at locking device input

If the voltage is interrupted, the locking device retains its last state (bistable coil). If the locking device was locked before, the protective device cannot be opened. If the locking device was not locked before, the protective device can be opened.

Only the power to release variants have a mechanical unlocking mechanism.

3.2.3 OSSD

Output signal switching device: signal output for the protective device, which is used for stopping the dangerous movement.

An OSSD is a safety switching output. The functionality of each OSSD is tested periodically. OSSDs are always connected in pairs and must undergo dual-channel analysis for safety reasons. An OSSD pair is formed from 2 OSSDs that are connected and analyzed together.

3.2.4 Switching behavior of the OSSDs

Overview

The safety locking device is available in variants for protecting people or for process protection. The variants differ with regards to the switching behavior of the OSSDs:

Variants for people protection (locking monitoring)

OSSDs go into the ON state as soon as the following requirements are all fulfilled.

- Movable physical guard is closed.
- Locking device is locked.
- There is a valid signal at the inputs In1 and In2.

Variants for process protection (actuator monitoring)

OSSDs go into the ON state as soon as the following requirements are all fulfilled.

- Movable physical guard is closed.
- There is a valid signal at the inputs In1 and In2.

Important information



DANGER

Hazard due to lack of effectiveness of the protective device

- ▶ Do not use variants for process protection in applications in which the dangerous state cannot be ended immediately (stopping/run-down time).

3.2.5 Application diagnostic output

Important information



NOTE

The application diagnostic output cannot be evaluated for a safe series connection with T-connectors.

Switching behavior

The application diagnostic output switches parallel the detection of the actuator. This is not a safety output.

Status of the movable physical guard	Switching behavior of the application diagnostic output
Open	OFF
Closed	ON

3.2.6 Coded actuators

The safety locking device comes with coded actuators with transponders.

- Uniquely coded
Only one actuator is valid at any one time. Actuators need to be taught-in to become valid. Each time a new actuator is taught-in, the previous actuator becomes invalid.
Coding level: High (ISO 14119)
- Universally coded
The device accepts all actuators that are suitable for the device.
Coding level: Low (ISO 14119)

3.3 Manual unlocking

In some situations, it necessary to unlock the locking device manually (e.g. if faults are present). When unlocking, the safe output signal switching devices (OSSD) switch to the OFF status. A stop command must be generated as a result.

After manual unlocking, a function test must be performed (see "Testing", page 26).

3.3.1 Auxiliary release

Using the auxiliary release, the safety locking device can be unlocked manually regardless of the status.

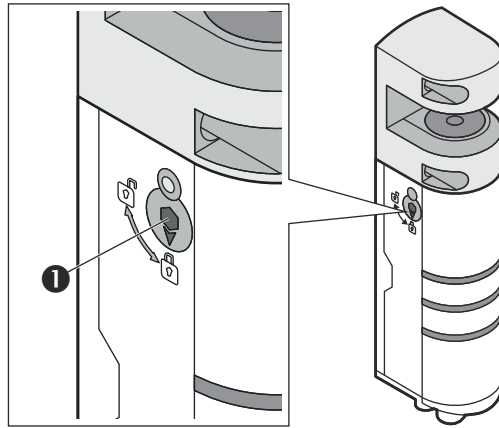

Figure 2: auxiliary release

- ① Auxiliary release

Only the power to release variants have a auxiliary release.

4 Project planning

4.1 Manufacturer of the machine

The manufacturer of the machinery must carry out a risk assessment and apply appropriate protective measures. Further protective measures may be required in addition to the safety locking device.

The device must not be tampered with or changed, except for the procedures described in this document.

The device must not be repaired. Defect devices have to be replaced.

Observe EN ISO 14119 when using interlocking devices in conjunction with physical guards.

4.2 Operator of the machine

Changes to the electrical integration of the device in the machine controller and changes to the mechanical mounting of the device necessitate a new risk assessment. The results of this risk assessment may require the entity operating the machine to meet the obligations of a manufacturer.

The device must not be tampered with or changed, except for the procedures described in this document.

The device must only be repaired. Improper repair can result in the device not providing correct protection.

Restrict access to replacement actuators, so they cannot be used for bypassing.

4.3 Design

4.3.1 Features of the actuator

The actuator is available in different designs.

- Rigid
- Flexible

Table 2: Features of the actuator

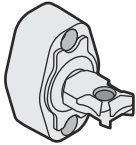
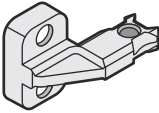
	Flexible	Rigid
		
Alignment of actuator to mounting surface	Straight	Angled
Minimum door radius for door stop above the device	500 mm	800 mm
Minimum door radius for door stop on left or right of device	180 mm	150 mm
Max. horizontal deviation ❶	3 mm	0.5 mm
Max. vertical deviation ❷	3 mm	0.5 mm
Max. offset angle about X-axis ❸	2.5°	0°
Max. offset angle about Y-axis ❹	2.5°	0°

	Flexible	Rigid
Max. offset angle about Z-axis ⑤	2,5°	0°
Rotable and spring loaded actuator	Yes	No

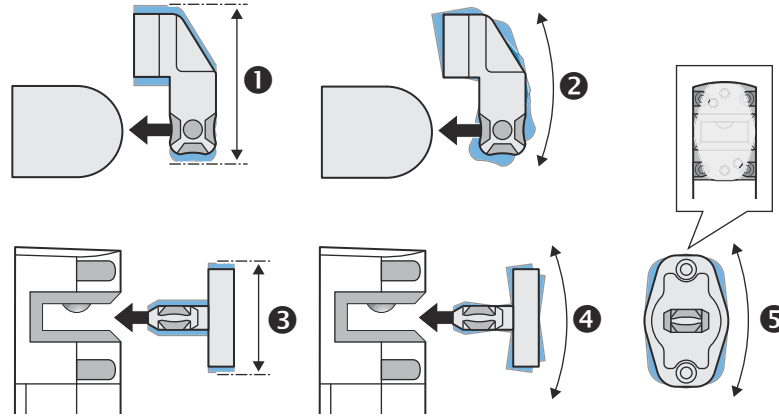

Figure 3: Offsets and offset angle

4.3.2 Actuating direction

The safety locking device can be actuated horizontally within a continuous 180° radius.

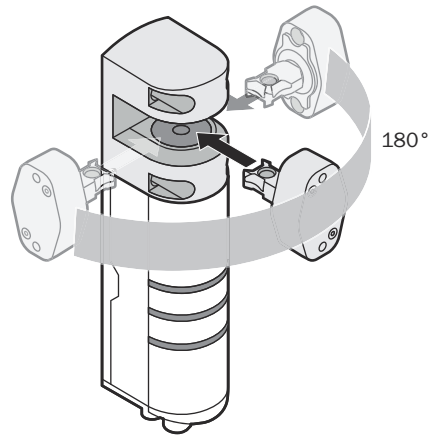

Figure 4: Possible actuating directions

The flexible actuator can only move forwards for actuation.

The rigid actuator can move forwards or sideways for actuation.

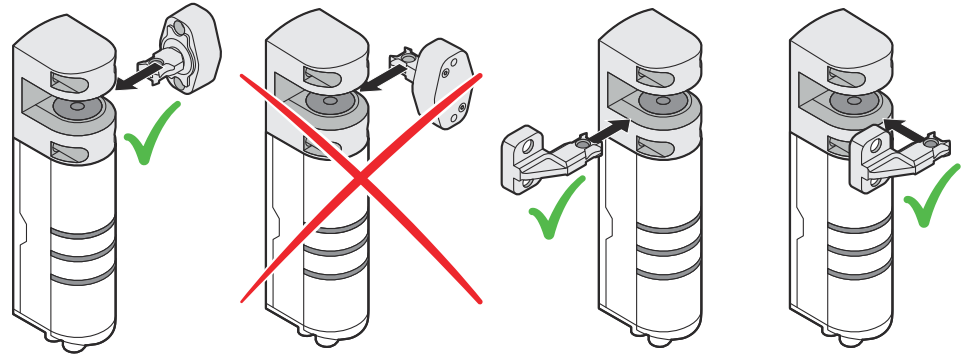

Figure 5: Sideways approach with flexible actuator - Figure 6: Sideways approach with rigid actuator



4.3.3 Measures to protect against unintentional damage

You can use the following measures to avoid unintentional damage to the safety switch:

- Select the mounting location so that the safety switch is protected from impacts and mechanical pressure.
- Fit an additional stop for the door. The safety switch must not be used as a stop.

4.3.4 Measures against tampering

The safety switch must not be defeated (contacts jumpered), rotated away, removed, or rendered ineffective in any other way. You must put measures in place, if necessary, to reduce the possibilities for defeating the device.

4.4 Integration in the electrical control system

You need to take the following into consideration when integrating the safety locking device into the electrical control system.

Requirement for use

- The safety locking device must not be bypassed by electrical means, e.g. by bridging the contacts. You may need to take measures to prevent this.
- The connected controller and all devices responsible for safety must comply with the required performance level and the required category (for example according to ISO 13849-1).
- The overall concept of the control system in which the device is integrated must be validated in accordance with ISO 13849-2.
- The inputs of a connected evaluation unit must be positive-switching (PNP) inputs because the two outputs of the safety switch supply a level of the supply voltage in the switched-ON state.

Generating the signals for the safety locking device

- Only variants for people protection: The locking device may only be unlocked when the dangerous state has ended. Depending on the safety concept, the signal is analyzed, for example, by a safety relay or a safety controller.
- Use control without test pulses. The safety switch generates its own testpulses.

Evaluating the signals from the safety locking device

- In the closed or locked state, the OSSDs signal the ON state with the signal level HIGH (non-isolated). When opened or unlocked or there is a device fault, the OSSDs signal the OFF state with the signal level LOW.
- Downstream control elements must evaluate the output signals of the protective device in such a way that the dangerous state of the machine is safely ended. The machine switches to the safe state if, at any time, at least one OSSD in the OSSD pair switches to the OFF state.

- Switch-on commands that put the machine in a dangerous state may only be activated when the OSSDs of the safety locking device are in the ON state.
- Closing or locking the protective device must not trigger the automated starting of a hazardous machine function. This must occur by means of a separate start command.
- The safety switch tests the OSSDs at regular intervals. To do this, the safety switch switches each OSSD briefly (for max. 300 µs) to the OFF state and checks whether this channel is voltage-free during this time. Make sure that the machine's control does not react to these test pulses and the machine does not switch off.

4.4.1 Safe series connection

Overview

Several safety switches can be connected in series in a safe series connection. The connected devices act like a single device. The type of safe series connection depends on the safety switch variant selected.

The following options are available:

- Safe series connection with Flexi Loop (with diagnostics)
In a series connection with Flexi Loop, the safety switches are connected to Flexi Loop nodes. Each Flexi Loop node evaluates a safety switch and sends the information to the Flexi Soft safety controller.
- Safe series connection with T-connector (without diagnostics)
In a series connection with T-connectors, several safety switches are connected via T-connectors and connected to the safe evaluation unit.
- Safe series connection in control cabinet (with diagnostics)
In a series connection in the control cabinet, the safety switches are led to the control cabinet individually. The OSSDs of the safety switches are connected in series there and evaluated by the evaluation unit. The Aux outputs can be individually connected to the programmable logic controller (PLC).

Safe series connection with T-connectors or in the control cabinet

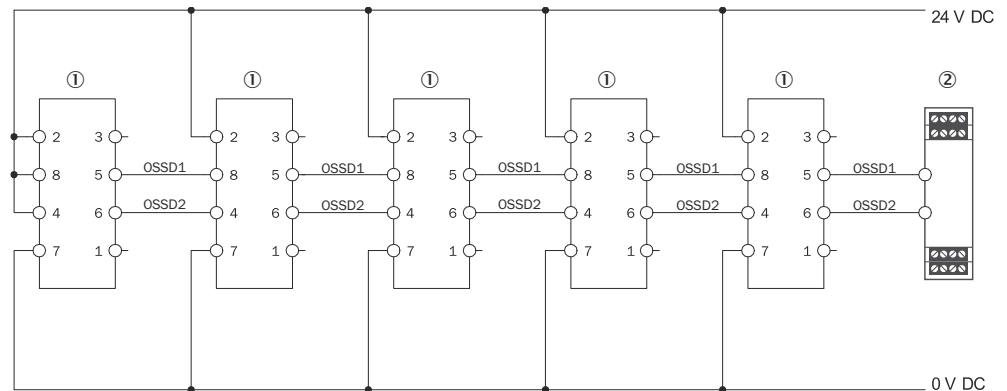

Figure 7: Switching with 5 safety switches connected in series

- ① Safety switch
- ② Safe evaluation unit

The voltage drop in the series connection must be checked so that the defined minimum voltage is still applied to the last safety switch.

For connection cables with a length of 2 m and a cable cross-section of 0.25 mm², the maximum number of safety switches connected in series depends on the voltage as follows:

Table 3: Maximum number of safety switches in a series connection depends on the voltage

Voltage	Connection cables, uniform for the entire series connection	Input voltage at 30th safety switch	Maximum number of safety switches in series connection
24 V	Length: 2 m	19.2 V	4
26 V	Cable cross-section: <ul style="list-style-type: none"> • General: 0,34 mm² • Connection between safety switch and junction: 0,25 mm² 	19.5 V	5

Additional voltage supply

The voltage drop in the safe series connection must be checked so that the defined minimum voltage is still applied to each safety switch. If the defined minimum voltage is no longer applied to a safety switch, a node for voltage supply must be integrated. The node for voltage supply must be integrated in the safe series connection in the direction of the safe evaluation unit, as close as possible to the relevant switch.

Complementary information

Number of safety locking devices in a safe series connection

The maximum number of safety locking devices in a safe series connection depends on the following factors:

- Technical realisation of the safe series connection (T-Connector, Flexi Loop or series connection in the cabinet)
- Applied supply voltage
- Length of cables used
- Cable cross-section of cables used
- Load current
- Required performance level

The number of safety locking devices in a safe series connection affects the response times of the system (see "Data sheet", page 35).

5 Mounting

5.1 Safety



DANGER

Hazard due to unexpected starting of the machine

Death or severe injury

- ▶ Make sure that the dangerous state of the machine is and remains switched off.



NOTICE

If incorrectly installed or if the ambient conditions are not suitable, the safety locking device can be damaged.

- ▶ Arrange the safety switch and actuator so that damage due to unintentional outside influences is prevented.
- ▶ Do not use a safety switch and actuator as a stop.
- ▶ Secure the safety switch and actuator using screws of strength class 8.8 or higher (For stainless steel screws: A2-70 or higher).
- ▶ Secure the fastening materials against loosening, e.g., using a medium-strength, material-bonding screw adhesive.
- ▶ The set-up and mounting of the safety switch and actuator must be stable enough to maintain proper operation.
- ▶ Use only reliable mounting elements that can only be removed with tools.
- ▶ Protect the switch head against damage and ingress of foreign bodies, e.g., chips, sand, abrasives, etc.
- ▶ If an opening is created in the physical guard due to alignment errors, it must not impair the protective function.
- ▶ Checking for environmental influences before using the safety locking device, e.g., UV radiation or corrosion. If necessary, mount device protected.
- ▶ When using a custom bracket: Ensure that the bracket can absorb at least the same level of mechanical forces that the safety locking device can absorb when the locking device is locked.

5.2 Orientation of the safety switch

The safety switch can be mounted in any orientation.

5.3 Mounting several safety switches

If several safety switches are mounted on the machine, they must be mounted at a minimum distance to one another.

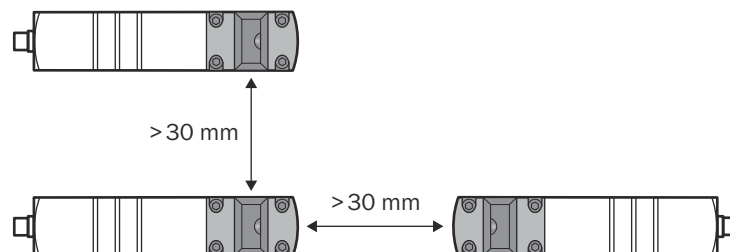

Figure 8: Minimum distance of safety switches

5.4 Mounting the safety switch

Approach

1. Select a position for the safety switch on the fixed part of the protective device. The safety switch must be positioned in such a way that the actuator is inserted into the safety switch when the movable physical guard is closed.
2. Attach the safety switch to the protective device.

Minimum requirements for mounting screws

- Number: 4
 - Size: M5 × 25 (or longer)
 - Strength class: Class 8.8 or higher (For stainless steel screws: A2-70 or higher).
 - Tightening torque: 5 Nm
3. Apply at least a middle strength adhesive screw locker.

5.5 Mounting the actuator

Approach

1. Select a position for the actuator on the movable physical guard. Select the position in such a way, that when the movable guard is closed, the actuator is inserted into the safety switch.
For flexible actuators, the actuator tongue can be rotated in 90° increments if necessary. To do so, press and rotate the actuator tongue in the actuator.
2. Attach the actuator to the movable physical guard.

Minimum requirements on the mounting screws

- Type : Use one ways screws when doing so to make unauthorized removal of the actuator difficult (manipulation protection).
 - Number: 2
 - Size: M5
 - Tightening torque: 5 Nm
3. Apply at least a middle strength adhesive screw locker.

6 Electrical installation

6.1 Safety

Overview

You can directly integrate the safety switch into the machine controller via the safety outputs (OSSDs). The OSSDs indicate the ON state with the HIGH signal level (non-isolated). The OFF state is indicated with the LOW signal level.

Downstream control elements must evaluate the output signals of the protective device in such a way that the dangerous state of the machine is safely ended. Depending on the safety concept, the signal is analyzed by, e.g., safety relays or a safety controller.

Important information



DANGER

Hazard due to electrical voltage

Hazard due to unexpected starting of the machine

- ▶ Make sure that the machine is and remains disconnected from the power supply during the electrical installation.
- ▶ Make sure that the dangerous state of the machine is and remains switched off during electrical installation.
- ▶ Make sure that the outputs of the safety switch have no effect on the machine during electrical installation.



DANGER

Hazard due to lack of effectiveness of the protective device

The dangerous state may not be stopped in the event of non-compliance.

- ▶ Always connect the two OSSDs separately. The two OSSDs must not be connected to each other.
- ▶ Connect the OSSDs such that the machine controller processes both signals separately.

Isolated connection of OSSD1 and OSSD2

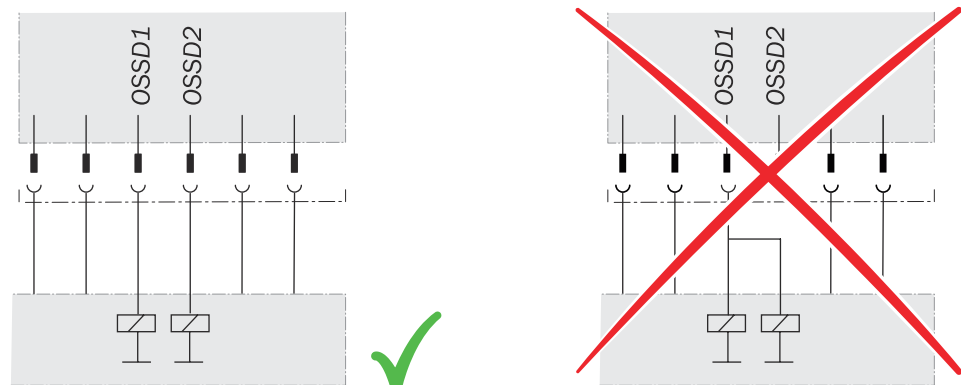

Figure 9: Dual-channel and isolated connection of OSSD1 and OSSD2

Avoiding any potential difference between load and protective device

If you connect loads to the output signal switching devices (switching outputs) that then also switch if controlled with negative voltage (e.g., electro-mechanical contactor without reverse polarity protection diode), you must connect the 0 V connections of these loads and those of the corresponding protective device separately and also directly to the same 0 V terminal strip. In the event of a fault, this is the only way to ensure that there can be no potential difference between the 0 V connections of the loads and those of the corresponding protective device.

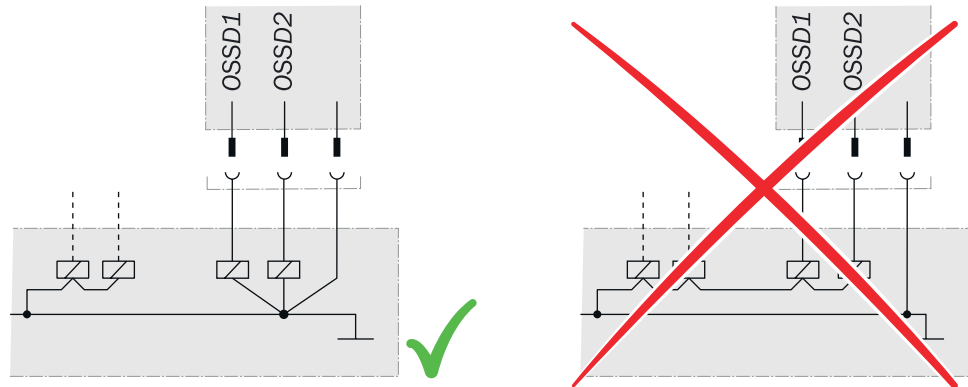

Figure 10: No potential difference between load and protective device

6.2 Notes on cULus

The following conditions must also be fulfilled in order to use and apply the equipment in accordance with UL 60947-5-2 requirements:

- The voltage supply must conform to Class 2 according to UL 508.
- The required fuse protection for each device is 2 A. In a safe series connection, a suitable device fuse protection must be calculated.

6.3 Device connection

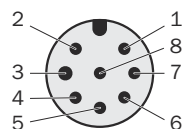

Figure 11: Device connection (male connector, M12, 8-pin, A-coded)

Table 4: Device connection pin assignment (male connector, M12, 8-pin, A-coded)

PIN	Wire color ¹⁾	Designation	Description
1	White	Out AUX	Application diagnostic output (not safe)
2	Brown	+24 V DC	Voltage supply 24 V DC
3	Green	LOCK	Locking device input
4	Yellow	In 2	Enable input for OSSD 2 ²⁾
5	Gray	OSSD 1	OSSD 1 output
6	Pink	OSSD 2	OSSD 2 output
7	Blue	0 V	Voltage supply 0 V DC

PIN	Wire color ¹⁾	Designation	Description
8	Red	In 1	Enable input for OSSD1 ²⁾

1) Applies to the extension cables recommended as accessories.

2) When used as an individual safety locking device or as the first safety locking device in a safe series connection, apply 24 V DC.

6.4 Connection of a safe series connection

Overview

The safe series connection can be implemented using special T-connectors and an end connector. The safe evaluation unit switches off the machine in the following events:

- A protective device is unlocked (only variants with lock monitoring)
- A protective device is opened (only variants with actuator monitoring)
- An error occurs on a safety locking device

Important information



NOTE

- In the case of safety locking devices cascaded with T-connectors, the application diagnostic output (Out AUX) cannot be evaluated.
- Mount the connecting cable so that individual T-connectors (and thus a safety locking device) cannot be easily jumpered.

Connection of the safe series connection (M12, 5-pin)

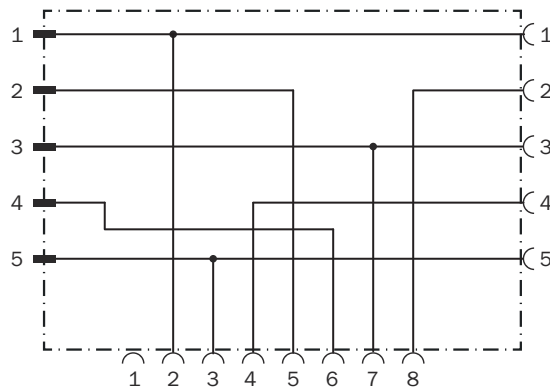

Figure 12: Internal circuitry: T-connector for safe series connection

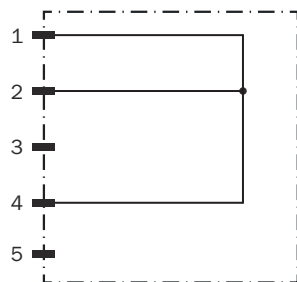

Figure 13: Internal circuitry: end connector for safe series connection

The 5-pin male connector of the last T-connector upstream of the safe evaluation unit is the interface between the safe series connection and the safe evaluation unit.

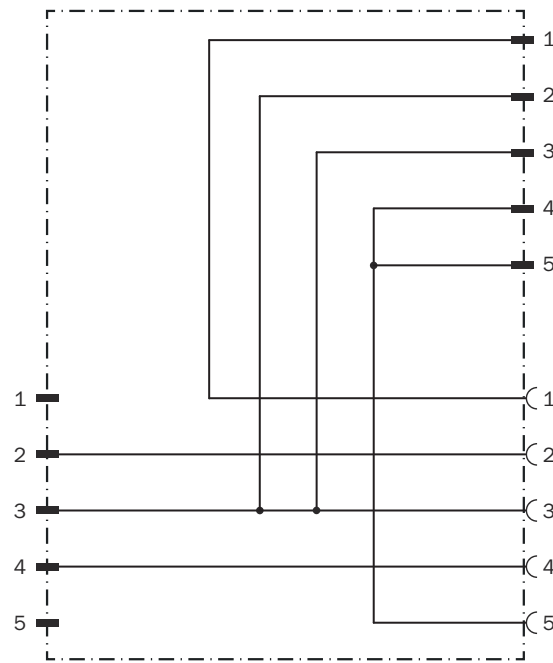

Figure 14: Internal circuitry: nodes for voltage supply

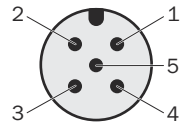

Figure 15: Connection of the safe series connection (M12, 5-pin, A-coded, male connector)

Table 5: Pin assignment connection of the safe series connector (male connector, M12, 5-pin, A-coded)

PIN	Wire color ¹⁾	Designation	Description
1	Brown	+24 V DC	Voltage supply 24 V DC
2	White	OSSD 1	OSSD 1 output
3	Blue	0 V	Voltage supply 0 V DC
4	Black	OSSD 2	OSSD 2 output
5	Gray	Lock	Locking device input

¹⁾ Applies to the extension cables recommended as accessories.

Further topics

- ["Accessories", page 40](#)

7 Commissioning

7.1 Teach-in

7.1.1 Teaching in the first actuator

Important information



NOTE

Safety locking devices in the delivery condition have a teach-in-window of 30 minutes after being switched on. After this, the Safety locking device switches into safe state. For a new teach-in-window the device needs to be restarted (disconnect and restore the voltage supply).



NOTE

The teach-in process is invalid if canceled, e.g. by interruption of the voltage supply or premature removal of the actuator.

The safety locking device then goes into the safe state, and the LEDs indicate the cause of the invalid teach-in process (see "Fault indications during operation", page 32). You can start a new teach-in process after a restart of the device.

Prerequisites

- Device variant is not universally coded. Universally coded devices do not require a teach-in.

Approach

1. Open physical guard.
 2. Connect safety switch to voltage supply (see "Electrical installation", page 20).
- ✓ The start sequence is executed. All LEDs flash with alternating colors. OSSDs are switched off in the meantime.
 - ✓ The following indicators signal that the safety switch is ready for the teach-in sequence.

Table 6: Display before teach-in

STATE LED (red/green)	LOCK LED (green/yellow)	DIAG LED (yellow/red)	Step
● Red	○	● Yellow/red (4 Hz)	Safety switch ready for teach-in sequence

3. Close physical guard.
- ✓ When the protective device is closed and the actuator has reached the required position, the safety switch automatically starts the teach-in sequence after 3 seconds. The individual steps are indicated via the LEDs.

Table 7: Displays of the teach-in sequences

STATE LED (red/green)	LOCK LED (green/yellow)	DIAG LEDs (yellow/red)	Step
● Green (4 Hz)	○	● Yellow/red (4 Hz)	Actuator is being taught-in
● Green (4 Hz)	○	● Yellow (4 Hz)	Actuator was successfully taught-in

4. No later than 5 minutes after successfully teaching in the actuator, disconnect and restore the voltage supply to the safety switch. Otherwise the device will go into safe state.
- ✓ The safety locking device is ready for use.

7.1.2 Teaching in the replacement actuator

Overview

The safety locking device can only be operated using the actuator that was last taught in.

Important information



NOTE

Safety locking devices with an actuator that has already been taught-in have a teach-in readiness of approx. 5 minutes after being switched on. In this time window, the following is true:

- If the actual valid actuator is detected, the teach-in process is canceled. The safety switch returns to normal mode.
- If a deactivated actuator is detected, the teach-in process is canceled. The code of the previous actuator remains active. The safety switch goes into the safe state.
- The device saves the last three deactivated codes only. Actuators that were taught-in at an earlier time can be taught-in again.
- The teach-in process is invalid if canceled, e.g., by interruption of the voltage supply or premature removal of the actuator. The safety locking device then goes into the safe state.

Approach

1. Open physical guard.
2. Disconnect safety switch from voltage supply for at least 3 seconds.
3. Connect safety switch to voltage supply (see ["Electrical installation", page 20](#)).
- ✓ The start sequence is executed. All LEDs flash with alternating colors. OSSDs are switched off in the meantime.
4. Close physical guard.
- ✓ When the protective device is closed and the actuator has reached the required position, the safety switch automatically starts the teach-in sequence. The individual steps are indicated via the LEDs.

Table 8: Displays of the teach-in sequences

STATE LED (red/green)	LOCK LED (green/yellow)	DIAG LEDs (yellow/red)	Step
● Green (4 Hz)	○	● Red/Yellow (4 Hz)	Actuator is being taught-in
● Green (4 Hz)	○	● Yellow (4 Hz)	Actuator was successfully taught-in

5. No later than 5 minutes after successfully teaching in the actuator, disconnect and restore the voltage supply to the safety switch. Otherwise the device goes into safe state. The last actuator remains valid.
- ✓ When the taught-in actuator is in the response range, both OSSDs switch to the ON state and the STATE LED lights up green.

Further topics

- ["Indications when teaching in an actuator", page 31](#)
- ["Fault indications during operation", page 32](#)

7.2 Testing



DANGER

Hazard due to unexpected starting of the machine

Death or severe injury

- ▶ Before carrying out the functional test, make sure that there are no people in the hazardous area.
-

Approach

Check that the device is functioning properly after installation and after every fault. To do this, proceed as follows:

Mechanical functional test

- ▶ Open the protective device and close it again. The components of the safety locking device must not collide with other parts. When the protective device is closed, the actuator must be in a position which enables the lock to be actuated.

Electrical functional test

1. Switch on the supply voltage.
2. Close all protective devices and activate the locks. The machine must not start up on its own.
3. Check the lock. It must not be possible to open the protective device.
4. Start the machine function.
5. Only variants with lock monitoring (people protection): Make sure that the lock cannot be deactivated as long as the dangerous machine function is active.
6. Stop the machine function and deactivate the lock.
7. Check whether the protective device is kept locked until there is no more risk of injury (e.g., due to run-on movements).
8. Check the restart interlock. The machine function must not start while the lock is deactivated.
9. Repeat steps 3 to 8 individually for each protective device.

Complementary information



NOTE

You can simulate an active lock command, by applying the referred voltage to the “Lock input” contact.

- Variant with locking principle power to lock: 24 V DC
 - Variant with locking principle power to release 0 V DC
-

7.3 Regular thorough check

Important information



DANGER

Insufficient checks or incorrect repair

Hazard due to lack of effectiveness of the protective device

- ▶ In the event of wear or damage, replace the entire safety locking device with actuator. Never replace individual parts or assemblies.
 - ▶ Check the safety locking device following the inspection intervals specified in the national rules and regulations.
-

Monitoring

The following checks must be done to ensure permanent and proper function:

- Proper switching function
- Manual unlock function (e.g., auxiliary release)
- Safe mounting of all components
- No damage, contamination, deposits or wear
- No loose plug connectors
- No signs of manipulation of the safety locking device

8 Operation

8.1 Actuating the mechanical unlocking mechanism

Prerequisites

- TX10 Torx screwdriver

Approach

1. Ensure that the actuator is not under strong tensile stress (≤ 20 N).
2. Loosen the retaining screw with the screwdriver.
3. Use the screwdriver to rotate the mechanical unlocking mechanism in the direction of the arrow to the following symbol:



- ✓ The locking device is unlocked.

Complementary information

If a valid actuator is detected and the locking signal is active, the Safety locking device will repeatedly try to activate locking. If locking can't be activated during the next 10 minutes, the safety locking device will change to safe state.

8.1.1 Moving the mechanical unlocking mechanism back after use

Approach

- ▶ Use the screwdriver to move the mechanical unlocking mechanism back to the following symbol:



- ▶ Screw in the retaining screw and seal it (e.g. with locking varnish)
- ▶ Open the protective device and close it again.
- ✓ The safety locking device operates in normal mode again.
- ▶ Carry out a functional test.

8.2 Preventing unintentional closing of the protective device

Overview

For some maintenance work, it is necessary to prevent the movable physical guard from being closing.

Approach

- ▶ Insert and lock the padlock in the latch plate of the actuator.
- ✓ The physical guard can no longer be closed.

9 Maintenance

9.1 Cleaning

**NOTICE**

- ▶ Do not use aggressive cleaning agents (such as isopropanol or spirit).
 - ▶ Do not use any substances that hinder the wetting properties of lacquers.
 - ▶ We recommend anti-static cleaning agents.
-

10 Troubleshooting

10.1 Safety



DANGER

Hazard due to lack of effectiveness of the protective device

Persons and parts of the body to be protected may not be recognized in case of non-observance.

- ▶ Immediately shut the machine down if the behavior of the machine cannot be clearly identified.
- ▶ Immediately put the machine out of operation if you cannot clearly identify or allocate the fault and if you cannot safely remedy the fault.
- ▶ Secure the machine so that it cannot switch on unintentionally.



DANGER

Hazard due to unexpected starting of the machine

- ▶ When any work is taking place, use the protective device to secure the machine or to ensure that the machine is not switched on unintentionally.



DANGER

Hazard due to lack of effectiveness of the protective device

Persons and parts of the body to be protected may not be recognized in case of non-observance.

- ▶ Do not do repair work on device components.
- ▶ Do not make changes to or manipulate device components.
- ▶ Apart from the procedures described in this document, the device components must not be opened.



NOTE

Additional information on troubleshooting can be found at the responsible SICK subsidiary.

10.2 LED indicators

Overview

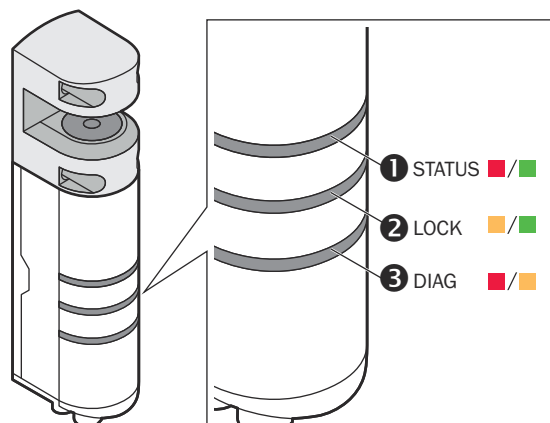

In combination, these LEDs indicate detailed status and error states. In general, the STATUS and LOCK LEDs indicate the following states.

Table 9:  STATUS LED



Display	Status
 Green	Valid actuator detected. OSSD LOW.
 Green	Valid actuator detected. OSSD HIGH.
 Red	No valid actuator detected. OSSD LOW.

Table 10:  LOCK LED











Display	Status
 ○	No active locking signal
 Green	Locking signal active, locking device not locked.
 Green	Locking signal active, locking device locked.
 Yellow	
 Yellow	Meaning depends on the status of other LEDs

Table 11:  DIAG LED

Display	Status
 Yellow	No valid signal at IN 1 and IN 2
 Red  Yellow  Red  Yellow	Meaning depends on the status of other LEDs

Further topics

- ["Indications when teaching in an actuator", page 31](#)
- ["Status indications during operation", page 32](#)
- ["Fault indications during operation", page 32](#)

10.2.1 Indications when teaching in an actuator

Table 12: Status indications during teach-in





























LED indicators			OSSDs	Inputs		Status
STATUS	LOCK	DIAG		LOCK	IN 1/IN 2	
 Red/green (2 Hz)	 Yellow/green (2 Hz)	 Red/yellow (2 Hz)	OFF	Not relevant	Not relevant	Device is being switched on and is performing a self-diagnostic test.
 Red	 ○	 Red/yellow (4 Hz)	OFF	Not relevant	Not relevant	In the delivery condition: No actuator detected. You can start the teach-in.
 Green (4 Hz)	 ○	 Red/yellow (4 Hz)	OFF	Not relevant	Not relevant	Device is teaching in the actuator.
 Green (4 Hz)	 ○	 Yellow (4 Hz)	OFF	Not relevant	Not relevant	Actuator was successfully taught-in. To complete teach-in-process, disconnect and restore the voltage supply.

Table 13: Error indications during teach-in

LED indicators			OSSDs	Inputs		Cause	Troubleshooting
STATUS	LOCK	DIAG		LOCK	IN 1/IN 2		
 Red/green (4 Hz)	○	 Red (4 Hz)	OFF	Not relevant	Not relevant	Teach-in failed. Device was not restarted within the expected time	Disconnect and restore the voltage supply. Repeat the teach-in.
 Red/green (4 Hz)	○	 Red	OFF	Not relevant	Not relevant	Teach-in failed. Actuator was removed too soon.	Disconnect and restore the voltage supply. Repeat the teach-in.



10.2.2 Status indications during operation



















Table 14: Status indications during operation

LED indicators			OSSDs	Inputs		Status
STATUS	LOCK	DIAG		LOCK	IN 1/IN 2	
 Red	 Green (1 Hz)	Not relevant	OFF	Locking requested.	Not relevant	No actuator detected.
 Red	○	Not relevant	OFF	Release requested.	Not relevant	No actuator detected.
 Green (1 Hz)	○	 Yellow	OFF	Release requested.	OFF	Actuator detected. Locking device is unlocked. No valid release signal on IN1 and IN2
 Green (1 Hz)	 Green	 Yellow	OFF	Locking requested.	OFF	Actuator detected. Locking device is locked. No valid release signal on IN1 and IN2
 Green (1 Hz)	○	○	OFF	Release requested.	ON	Actuator detected. Locking device is unlocked.
 Green	 Green	○	ON	Locking requested.	ON	Actuator detected. Locking device is locked.
 Green	○	○	ON	Release requested.	ON	Actuator detected. Locking device is unlocked.
Not relevant	Not relevant	 Yellow	OFF	Not relevant	OFF	No valid release signal on IN1 and IN2

10.2.3 Fault indications during operation

Table 15: Fault indications during operation

LED indicators			OSSDs	Inputs		Cause	Troubleshooting
STATUS	LOCK	DIAG		LOCK	IN 1/IN 2		
 Red (1 Hz)	 Yellow	 Red (1 Hz)	OFF	Not relevant	Not relevant	Device has attempted unsuccessfully to activate or deactivate the safety locking function for 10 minutes.	<ul style="list-style-type: none"> ▶ Make sure, auxiliary release is not active. ▶ Check alignment of the actuator. ▶ Check if the actuator reaches the final position, when the door is closed. ▶ Check if contaminants are blocking the locking pin.

LED indicators			OSSDs	Inputs		Cause	Troubleshooting
STATUS	LOCK	DIAG		LOCK	IN 1/IN 2		
 Red (1 Hz)		 Red (4 Hz)	OFF	Not relevant	Not relevant	External error	<ul style="list-style-type: none"> ▶ Check OSSD-cables for short circuit to 0 V or 24 V or to each other. ▶ Check cables for damage. ▶ Disconnect and restore the voltage supply.
 Red (1 Hz)		 Red (1 Hz)	OFF	Not relevant	Not relevant	Voltage supply too low or too high	<ul style="list-style-type: none"> ▶ Check voltage supply ▶ Disconnect and restore the voltage supply.
 Red	 Yellow (1 Hz)	 Red	OFF	Locking requested.	Not relevant	Actuator was removed while the locking device was active. Actuator is probably damaged.	Replace the actuator.
 Red	Irrelevant	 Yellow (1 Hz)	OFF	Not relevant	Not relevant	Invalid actuator detected.	Use a valid actuator.
 Green (1 Hz)	 Yellow/green (1 Hz)	Irrelevant	Not relevant	Locking requested.	Not relevant	Unable to activate the safety locking function	Check the alignment of the actuator. Check whether the movable physical guard is pulling on the actuator.
 Green (1 Hz)	 Yellow/green (4 Hz)	Irrelevant	Not relevant	Release requested.	Not relevant	Unable to deactivate the safety locking function.	Check the alignment of the actuator. Check whether the movable physical guard is pulling on the actuator.
		 Red	OFF	Not relevant	Not relevant	Internal error	<ul style="list-style-type: none"> ▶ Make sure, that the device is not used improperly. see "Improper use", page 7 ▶ If the problem persists, replace the device.
Irrelevant	Irrelevant	 Red/yellow (1 Hz)	Not relevant	Not relevant	Not relevant	Application diagnostic output error	<ul style="list-style-type: none"> ▶ Check AUX Output for short circuit to 0 V. ▶ Check cabling for damage .

11 Decommissioning

11.1 Disposal

Approach

- ▶ Always dispose of unusable devices in accordance with national waste disposal regulations.



Complementary information

SICK will be glad to help you dispose of these devices on request.

12 Technical data

12.1 Data sheet

Table 16: Features

Principle of operation	Transponder
Frequency band	125 Hz
Actuating force	20 N
Retaining force	30 N
Force against which unlocking is possible	≤ 25 N
Actuating frequency	≤ 1 Hz
Actuation speed of the actuator	≤ 20 m/min
Dwell time between interlocking and unlocking (or vice versa)	1.5 s

Table 17: Locking forces

Locking force F_{Zh} ($F_{Zh} = F_{max} / 1.3$)	
Flexible actuator	3,460 N (EN ISO 14119)
Rigid actuator (frontal)	3,400 N (EN ISO 14119)
Rigid actuator (lateral)	3,060 N (EN ISO 14119)
Locking force F for fault exclusion ($F = F_{max} / 2$) ¹⁾	
Flexible actuator	2,250 N (EN ISO 14119)
Rigid actuator (frontal)	2,210 N (EN ISO 14119)
Rigid actuator (lateral)	1,990 N (EN ISO 14119)

¹⁾ Use these values if your locking function requires Performance Level PL e or if the Application has a long stopping time.

Table 18: Safety-related parameters

Safety integrity level	SIL3 (IEC 61508)
SIL claim limit	SILCL3 (EN 62061)
Category ¹⁾	Category 4 (ISO 13849-1)
Performance level ¹⁾	PL e (ISO 13849-1)
PFH _D (mean probability of a dangerous failure per hour)	6.79 × 10 ⁻⁹ at 40 °C and 0 m above sea level 7.82 × 10 ⁻⁹ at 40 °C and 2,000 m above sea level
T _M (mission time)	20 years (ISO 13849-1)
Type	Type 4 (ISO 14119)
Coding	
FXL1-SPxUxA00	Uniquely coded (high coding level according to ISO 14119)
FXL1-SPxMxA00	Universally coded (low coding level according to ISO 14119)
Safe status when a fault occurs	At least one safety-related semiconductor output (OSSD) is in the OFF state.

¹⁾ Applies to monitoring the door position (interlocking monitoring).
Applies to monitoring the locking function (locking device monitoring).

Table 19: Electrical data

Classification based on cULus	2
Protection class	III (IEC 61140)



Utilization category	DC 13 (IEC 60947-5-3)
Supply voltage U_V	24 V DC (19.2 V DC ... 28.8 V DC) (SELV/PELV) 1)
Current consumption at 24 V (without load)	
FXL1-SPB*****	55 mA
FXL1-SPL*****, locking device unlocked	55 mA
FXL1-SPL*****, locking device locked	115 mA
Peak current consumption at 24 V (without load)	800mA for max. 200 ms ¹⁾
Contamination rating	3 (IEC 60947-1)
Rated insulation voltage U_i	32 V (IEC 60947-1)
Rated impulse withstand voltage U_{imp}	1,500 V (IEC 60947-5-1)
Power-up delay	3 s
Bridging time in case of power outage	FXL1-SPB*****: ≤ 4 ms FXL1-SPL*****: ≤ 2 ms
Response time (required time for OSSDs to switch to OFF-state)	≤ 100 ms ¹⁾
Release time (required time for OSSDs to switch to ON-state)	≤ 350 ms ¹⁾
Risk time ²⁾	150 ms ¹⁾

1) In a safe series connection: Multiple value by the number of devices.

2) The risk time is the time needed to detect internal and external faults. External errors affect the OSSDs (short-circuit to an OSSD and cross-circuit between the two OSSDs). At least one of the two OSSDs is safely switched off during the risk time.

Table 20: Interfaces

System connection	Male connector, M12, 8-pin, A-coded (common male connector for voltage supply and outputs)
-------------------	--

Table 21: Inputs

Input voltage for ON state (HIGH)	24 V (15 V DC ... 28.8 V DC)
Input voltage for OFF state (LOW)	≤ 2 V DC
Input current for ON state (HIGH)	≤ 5 mA
Input current for OFF state (LOW)	≤ 500 μ A

Table 22: Output signal switching devices (OSSDs)

Type of output	2 PNP semiconductors, short-circuit protected, cross-circuit monitored
Output current	
ON state	≤ 100 mA
OFF state	≤ 500 μ A
Output voltage	
ON state	$U_V - 2$ V DC ... U_V
OFF state	≤ 2 V
Capacitive load	≤ 400 nF
Test pulse duration	≤ 300 μ s
Test pulse interval	Typically 40 ms \pm 5 ms

Table 23: Application diagnostic output

Output current	≤ 50 mA
----------------	--------------

Output voltage in OFF state	U _v - 2 V DC ... U _v (max. voltage drop ≤ 2 V DC)
Output voltage in ON state	≤ 2 V DC

Table 24: Mechanical data

Dimensions (W x H x D)	see "Safety switch dimensional drawings", page 38 see "Actuator dimensional drawings", page 38 see "Dimensional drawings of the mounting bracket", page 38
Material	
Safety switch housing	Vistal® (fiberglass-reinforced thermoplastic)
Ball bracket	Stainless steel
Latch plate of the actuator	Stainless steel
Plug connector	Stainless steel
Weight	
Power to release safety switch	480 g
Power to lock safety switch	535 g
Flexible actuator	90 g
Rigid actuator	75 g
Mechanical service life	1 × 10 ⁶ switching operations

Table 25: Ambient data

Enclosure rating	IP 65 (IEC 60529) IP 67 (IEC 60529) IP 69K (IEC 20653)
Ambient operating temperature	-20 °C ... +55 °C
Storage temperature	-25 °C ... +70 °C
Relative humidity	10 - 95% at 40 °C (IEC 60068)
Vibration resistance	1 mm / 10 Hz ... 55 Hz (IEC 60068-2-6)
Shock resistance	30 g, 11 ms (EN 60068-2-27)
EMC	In accordance with IEC/EN 61326-3-1, IEC/EN 60947-5-2, IEC/EN 60947-5-3 and EN 300330

12.2 Connecting cables

Requirements for the connecting cables

Recommended cable type = LIYY 8 x 0.25 mm² or 5 x 0.34 mm²

Maximum cable lengths

Table 26: Maximum cable lengths

Number of safety locking devices	Possible output current per OSSD (mA)	Possible output current AUX (mA)	Max. length of entire cable from the last safety locking device to the controller (m)
4	100	50	10
5	5	5	8

12.3 Safety switch dimensional drawings

12.4 Actuator dimensional drawings

12.5 Dimensional drawings of the mounting bracket

13 Ordering information

13.1 Scope of delivery

- Safety switch
- Sealing plug for secure mounting
- Safety note
- Operating instructions for download: www.sick.com

13.2 Ordering information

Table 27: Ordering data for power to release safety switch

Function of the OSSDs	Coding	Unlocking options	Type code	Part number
Locking device monitoring	Uniquely coded	<ul style="list-style-type: none"> • Mechanical unlocking mechanism 	FXL1-SPBUSA00	1101320
Locking device monitoring	Universally coded	<ul style="list-style-type: none"> • Mechanical unlocking mechanism 	FXL1-SPBMSA00	1101321

Table 28: Ordering data for power to lock safety switch

Function of the OSSDs	Coding	Type code	Part number
Locking device monitoring	Uniquely coded	FXL1-SPLUSA00	1101322
Locking device monitoring	Universally coded	FXL1-SPLMSA00	1101323
Actuator monitoring	Uniquely coded	FXL1-SPLUAA00	1101324
Actuator monitoring	Universally coded	FXL1-SPLMAA00	1101325

14 Accessories

14.1 Actuator

Table 29: Actuator flexLock

Description	Type code	Part number
Actuator, flexible	FXL1-AF1	1101326
Actuator, rigid	FXL1-AR1	1101327

14.2 Connectivity

M12 connecting cable, 8-pin (0.25 mm²)

Table 30: Ordering information for M12 connecting cable, 8-pin (0.25 mm²) ¹⁾

Part	Type code	Part number
Female connector, straight, 2.5 m cable, flying leads	YF2A18-025UA5XLEAX	2099229
Female connector, straight, 5 m cable, flying leads	YF2A18-050UA5XLEAX	2095653
Female connector, straight, 7.5 m cable, flying leads	YF2A18-075UA5XLEAX	2099230
Female connector, straight, 10 m cable, flying leads	YF2A18-100UA5XLEAX	2095654
Female connector, straight, 15 m cable, flying leads	YF2A18-150UA5XLEAX	2095679
Female connector, straight, 20 m cable, flying leads	YF2A18-200UA5XLEAX	2095680
Female connector, straight, 30 m cable, flying leads	YF2A18-300UA5XLEAX	2095681
Female connector, angled, 2 m cable, flying leads	YG2A18-020UA5XLEAX	2095779
Female connector, angled, 5 m cable, flying leads	YG2A18-050UA5XLEAX	2095780
Female connector, angled, 10 m cable, flying leads	YG2A18-100UA5XLEAX	2095781

M12 connection cable, 5-pin (0.34 mm²)

Table 31: Ordering information for M12 connection cable, 5-pin (0.34 mm²) ²⁾

Part	Type code	Part number
Female connector, straight, 0.6 m cable, male connector, straight	YF2A15-C60UB5M2A15	2096006
Female connector, straight, 1 m cable, male connector, straight	YF2A15-010UB5M2A15	2096007
Female connector, straight, 2 m cable, male connector, straight	YF2A15-020UB5M2A15	2096009
Female connector, straight, 5 m cable, male connector, straight	YF2A15-050UB5M2A15	2096010
Female connector, straight, 10 m cable, male connector, straight	YF2A15-100UB5M2A15	2096011
Female connector, straight, 15 m cable, male connector, straight	YF2A15-100UB5M2A15	2096171

¹⁾ Ambient operating temperature: Down to -30 °C with fixed installation.

M12 connection cable, 8-pin (0.25 mm²)Table 32: Ordering information for M12 connection cable, 8-pin (0.25 mm²)³⁾

Part	Type code	Part number
Female connector, straight, 0.6 m cable, straight male connector	YF2A18-C60UA5M2A18	2096031
Female connector, straight, 1 m cable, straight male connector	YF2A18-010UA5M2A18	2096032
Female connector, straight, 20 m cable, straight male connector	YF2A18-020UA5M2A18	2096033
Female connector, straight, 1 m cable, straight male connector	YF2A18-050UA5M2A18	2096034
Female connector, straight, 10 m cable, straight male connector	YF2A18-100UA5M2A18	2096035

Distributor

Table 33: Ordering information for distributor

Part	Type code	Part number
T-connector	STR1-XXA	5339609

Terminator plug

Table 34: Ordering information for terminator plug

Part	Type code	Part number
End connector for series connection	MLP1-XXT	1078201

Nodes for voltage supply

Table 35: Ordering information Nodes for voltage supply

Part	Type code	Part number
Nodes for voltage supply	MLP1-XXN	1078202

2) Ambient operating temperature: Down to -30 °C with fixed installation.

3) Ambient operating temperature: Down to -30 °C with fixed installation.

15 Annex

15.1 Compliance with EU directives

EU declaration of conformity (extract)

The undersigned, representing the manufacturer, herewith declares that the product is in conformity with the provisions of the following EU directive(s) (including all applicable amendments), and that the standards and/or technical specifications stated in the EU declaration of conformity have been used as a basis for this.

Complete EU declaration of conformity for download

You can call up the EU declaration of conformity and the current operating instructions for the protective device by entering the part number in the search field at www.sick.com (part number: see the type label entry in the "Ident. no." field).

15.2 FCC and IC radio approval

- FCC ID: 2AHDRFXL1
- IC: 21147FXL1

The device fulfills the EMC requirements for use in the USA and Canada, in accordance with the following extracts from the relevant approvals:

FCC § 15.19

This device complies with Part 15 of the FCC rules. Operation is subject to the following two conditions:

- This device may not cause harmful interference, and
- this device must accept any interference received, including interference that may cause undesired operation.

FCC §15.21 (warning statement)

[Any] changes or modifications not expressly approved by the party responsible for compliance could void the user's authority to operate the equipment.

IC

This device complies with Industry Canada's licence-exempt RSSs. Operation is subject to the following two conditions:

- This device may not cause interference; and
- This device must accept any interference, including interference that may cause undesired operation of the device.

Le présent appareil est conforme aux CNR d'Industrie Canada applicables aux appareils radio exempts de licence. L'exploitation est autorisée aux deux conditions suivantes :

- l'appareil ne doit pas produire de brouillage;
- l'utilisateur de l'appareil doit accepter tout brouillage radioélectrique subi, même si le brouillage est susceptible d'en compromettre le fonctionnement.

Australia

Phone +61 (3) 9457 0600
1800 33 48 02 – tollfree
E-Mail sales@sick.com.au

Austria

Phone +43 (0) 2236 62288-0
E-Mail office@sick.at

Belgium/Luxembourg

Phone +32 (0) 2 466 55 66
E-Mail info@sick.be

Brazil

Phone +55 11 3215-4900
E-Mail comercial@sick.com.br

Canada

Phone +1 905.771.1444
E-Mail cs.canada@sick.com

Czech Republic

Phone +420 234 719 500
E-Mail sick@sick.cz

Chile

Phone +56 (2) 2274 7430
E-Mail chile@sick.com

China

Phone +86 20 2882 3600
E-Mail info.china@sick.net.cn

Denmark

Phone +45 45 82 64 00
E-Mail sick@sick.dk

Finland

Phone +358-9-25 15 800
E-Mail sick@sick.fi

France

Phone +33 1 64 62 35 00
E-Mail info@sick.fr

Germany

Phone +49 (0) 2 11 53 010
E-Mail info@sick.de

Greece

Phone +30 210 6825100
E-Mail office@sick.com.gr

Hong Kong

Phone +852 2153 6300
E-Mail ghk@sick.com.hk

Hungary

Phone +36 1 371 2680
E-Mail ertekesites@sick.hu

India

Phone +91-22-6119 8900
E-Mail info@sick-india.com

Israel

Phone +972 97110 11
E-Mail info@sick-sensors.com

Italy

Phone +39 02 27 43 41
E-Mail info@sick.it

Japan

Phone +81 3 5309 2112
E-Mail support@sick.jp

Malaysia

Phone +603-8080 7425
E-Mail enquiry.my@sick.com

Mexico

Phone +52 (472) 748 9451
E-Mail mexico@sick.com

Netherlands

Phone +31 (0) 30 229 25 44
E-Mail info@sick.nl

New Zealand

Phone +64 9 415 0459
0800 222 278 – tollfree
E-Mail sales@sick.co.nz

Norway

Phone +47 67 81 50 00
E-Mail sick@sick.no

Poland

Phone +48 22 539 41 00
E-Mail info@sick.pl

Romania

Phone +40 356-17 11 20
E-Mail office@sick.ro

Russia

Phone +7 495 283 09 90
E-Mail info@sick.ru

Singapore

Phone +65 6744 3732
E-Mail sales.gsg@sick.com

Slovakia

Phone +421 482 901 201
E-Mail mail@sick-sk.sk

Slovenia

Phone +386 591 78849
E-Mail office@sick.si

South Africa

Phone +27 10 060 0550
E-Mail info@sickautomation.co.za

South Korea

Phone +82 2 786 6321/4
E-Mail infokorea@sick.com

Spain

Phone +34 93 480 31 00
E-Mail info@sick.es

Sweden

Phone +46 10 110 10 00
E-Mail info@sick.se

Switzerland

Phone +41 41 619 29 39
E-Mail contact@sick.ch

Taiwan

Phone +886-2-2375-6288
E-Mail sales@sick.com.tw

Thailand

Phone +66 2 645 0009
E-Mail marcom.th@sick.com

Turkey

Phone +90 (216) 528 50 00
E-Mail info@sick.com.tr

United Arab Emirates

Phone +971 (0) 4 88 65 878
E-Mail contact@sick.ae

United Kingdom

Phone +44 (0)17278 31121
E-Mail info@sick.co.uk

USA

Phone +1 800.325.7425
E-Mail info@sick.com

Vietnam

Phone +65 6744 3732
E-Mail sales.gsg@sick.com

Detailed addresses and further locations at www.sick.com