

FCC CERTIFICATION TEST REPORT

FOR

Applicant	:	Shenzhen Tomtop Technology Co., Ltd.
Address	:	G-4 Zone 5/F, No.1 Exchange Square, Huanan City, Pinghu Town, Longgang Dist, Shenzhen, Guangdong, China
Equipment under Test	:	Koogeek Lightbulb LB1
Model No.	:	LB1X (X=blank or A-Z, A-Z representative different appearance and colour)
Trade Mark	:	Koogeek
FCC ID	:	2AHDILB1
Manufacturer	:	Shenzhen Bright Lighting Technology Co., Ltd
Address	:	Bldg 18 Shancheng Industrial Park Shiyan Town Baoan District Shenzhen, Guangdong 518108 CHINA

Issued By: Dongguan Dongdian Testing Service Co., Ltd.

Add: No. 17, Zongbu Road 2, Songshan Lake Sci&Tech, Industry Park, Dongguan City, Guangdong Province, China, 523808

Tel: +86-0769-22891499 [Http://www.dgddt.com](http://www.dgddt.com)

TABLE OF CONTENTS

	Test report declares.....	4
1.	Summary of test results	5
2.	General test information.....	6
2.1.	Description of EUT	6
2.2.	Accessories of EUT.....	6
2.3.	Assistant equipment used for test.....	6
2.4.	Block diagram of EUT configuration for test	6
2.5.	Deviations of test standard	7
2.6.	Test environment conditions	7
2.7.	Test laboratory.....	7
2.8.	Measurement uncertainty	8
3.	Equipment used during test	9
4.	6dB Bandwidth and 99% Bandwidth.....	10
4.1.	Block diagram of test setup.....	10
4.2.	Limits	10
4.3.	Test Procedure.....	10
4.4.	Test Result.....	11
4.5.	Original test data	11
5.	Conducted Peak Output Power	16
5.1.	Block diagram of test setup.....	16
5.2.	Limits	16
5.3.	Test Procedure.....	16
5.4.	Test Result.....	16
6.	Power Spectral Density	17
6.1.	Block diagram of test setup.....	17
6.2.	Limits	17
6.3.	Test Procedure.....	17
6.4.	Test Result.....	17
6.5.	Original test data	18
6.6.	Band Edge and Spurious Emissions (Conducted).....	22
6.7.	Block diagram of test setup.....	22
6.8.	Limits	22
6.9.	Test Procedure.....	22
6.10.	Test Result.....	23
6.11.	Original test data	23
7.	Radiated Spurious Emissions	50
7.1.	Block diagram of test setup.....	50

7.2.	Limit	51
7.3.	Test Procedure.....	52
7.4.	Test result	53
8.	Radiated Band Edge Compliance.....	57
8.1.	Block diagram of test setup	57
8.2.	Limit	57
8.3.	Test Procedure.....	57
8.4.	Test result	57
9.	Power Line Conducted Emission	74
9.1.	Block diagram of test setup	74
9.2.	Power Line Conducted Emission Limits(Class B).....	74
9.3.	Test Procedure.....	74
9.4.	Test Result.....	75
10.	Antenna Requirements	78
10.1.	Limit	78
10.2.	Result.....	78
11.	Test setup photograph	79
12.	Photos of the EUT	81

TEST REPORT DECLARE

Applicant	:	Shenzhen Tomtop Technology Co., Ltd.
Address	:	G-4 Zone 5/F, No.1 Exchange Square, Huanan City, Pinghu Town, Longgang Dist, Shenzhen, Guangdong, China
Equipment under Test	:	Koogeek Lightbulb LB1
Model No	:	LB1X (X=blank or A-Z, A-Z representative different appearance and colour)
Trade Mark	:	Koogeek
Manufacturer	:	Shenzhen Bright Lighting Technology Co., Ltd
Address	:	Bldg 18 Shancheng Industrial Park Shiyan Town Baoan District Shenzhen, Guangdong 518108 CHINA

Test Standard Used: FCC Rules and Regulations Part 15 Subpart C

Test procedure used: ANSI C63.10:2013, ANSI C63.4:2014, KDB558074 D01 DTS Meas Guidance V03r02

We Declare:

The equipment described above is tested by Dongguan Dongdian Testing Service Co., Ltd and in the configuration tested the equipment complied with the standards specified above. The test results are contained in this test report and Dongguan Dongdian Testing Service Co., Ltd is assumed of full responsibility for the accuracy and completeness of these tests.

After test and evaluation, our opinion is that the equipment provided for test compliance with the requirement of the above FCC standards.

Report No:	DDT-R17Q0116-9E2		
Date of Receipt:	Mar. 9, 2017	Date of Test:	Mar. 9, 2017 ~ Apr. 17, 2017

Prepared By:



Leo Liu/Engineer



Kevin. eng/EMC Manager

Note: This report applies to above tested sample only. This report shall not be reproduced in parts without written approval of Dongguan Dongdian Testing Service Co., Ltd.

1. Summary of test results

The EUT have been tested according to the applicable standards as referenced below.		
Description of Test Item	Standard	Results
6dB Bandwidth and 99% Bandwidth	FCC Part 15: 15.247 RSS-247 Issue 1 clause 5.2 KDB558074	PASS
Conducted Peak Output Power	FCC Part 15: 15.247 RSS-247 Issue 1 clause 5.4 KDB558074	PASS
Power Spectral Density	FCC Part 15: 15.247 RSS-247 Issue 1 clause 5.2 KDB558074	PASS
Band-edge and Spurious Emissions (Conducted)	FCC Part 15: 15.247 RSS-247 Issue 1 clause 5.5 KDB558074	PASS
Radiated Spurious Emissions	FCC Part 15: 15.209 FCC Part 15: 15.247 RSS-Gen Issue 4 clause 7.2.2 RSS-Gen Issue 4 clause 7.2.5 RSS-247 Issue 1 clause 5.2 ANSI C63.10: 2013 ANSI C63.4:2014 KDB558074	PASS
Radiated Band Edge Compliance	FCC Part 15: 15.209 FCC Part 15: 15.247 ANSI C63.10: 2013 ANSI C63.4:2014 KDB558074	PASS
Power Line Conducted Emission	FCC Part 15: 15.207 RSS-Gen Issue 4 clause 7.2.4 ANSI C63.10: 2013 ANSI C63.4:2014	PASS
Antenna requirement	FCC Part 15: 15.203 RSS-Gen Issue 4 clause 7.1.2	PASS

2. General test information

2.1. Description of EUT

EUT* Name	: Koogeek Lightbulb LB1
Model Number	: LB1X (X=blank or A-Z, A-Z representative different appearance and colour)
EUT function description	: Please reference user manual of this device
Power supply	: AC 120V/60Hz
Radio Technology	: IEEE802.11b/g/n
FCC Operation frequency	: IEEE 802.11b: 2412MHz—2462MHz IEEE 802.11g: 2412MHz—2462MHz IEEE 802.11n HT20: 2412MHz—2462MHz IEEE 802.11n HT40:2422MHz—2452MHz
Modulation	: IEEE 802.11b: DSSS(CCK,DQPSK,DBPSK) IEEE 802.11g: OFDM(64QAM, 16QAM, QPSK, BPSK) IEEE 802.11n HT20, HT40: OFDM (64QAM, 16QAM, QPSK,BPSK)
Channels	: Channel: 11 (for 802.11b/g/n H20), Channel: 7 (for 802.11n H40)
Antenna Type	: Integrated antenna, antenna peak gain: 0dBi
Sample Type	: Series production

Note1: EUT is the ab.of equipment under test.

Channle information							
CH	Frequency	CH	Frequency	CH	Frequency	CH	Frequency
1	2412	5	2432	9	2452	/	/
2	2417	6	2437	10	2457	/	/
3	2422	7	2442	11	2462	/	/
4	2427	8	2447	/	/	/	/

2.2. Accessories of EUT

Description of Accessories	Brand	Model number	Parameter	Remark
N/A	N/A	N/A	N/A	N/A

2.3. Assistant equipment used for test

Description of Assistant equipment	Manufacturer	Model number or Type	EMC Compliance	SN
Notebook	DELL	Latitude D610	FCC DOC	00045-534-136-300

2.4. Block diagram of EUT configuration for test

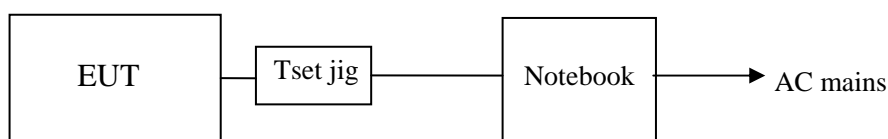

EUT was connected to control to a special test jig provided by manufacturer which has a standard usb port connector to connect to Notebook, and the Notebook will run a special test software provided by manufacturer to control EUT work in Continuous TX mode (>98% duty cycle), and select test channel, wireless mode and data rate.

Tested mode, channel, and data rate information			
Mode	data rate (Mbps) (see Note)	Channel	Frequency (MHz)
IEEE 802.11b	11	LCH :CH1	2412
	11	MCH: CH6	2437
	11	HCH: CH11	2462
IEEE 802.11g	54	LCH :CH1	2412
	54	MCH: CH6	2437
	54	HCH: CH11	2462
IEEE 802.11n HT20	MSC0	LCH :CH1	2412
	MSC0	MCH: CH6	2437
	MSC0	HCH: CH11	2462
IEEE 802.11n HT40	MCS 7	LCH :CH3	2422
	MCS 7	MCH: CH6	2437
	MCS 7	HCH: CH9	2452
Note: According exploratory test, EUT will have maximum output power in those data rate, so those data rate were used for all test.			

2.5. Deviations of test standard

No Deviation

2.6. Test environment conditions

During the measurement the environmental conditions were within the listed ranges:

Temperature range:	21-25°C
Humidity range:	40-75%
Pressure range:	86-106kPa

2.7. Test laboratory

Dongguan Dongdian Testing Service Co., Ltd

Add: No. 17, Zongbu Road 2, Songshan Lake Sci&Tech, Industry Park, Dongguan City, Guangdong Province, China, 523808 Tel: +86-0769-22891499 <http://www.dgddt.com>

FCC Registration Number: 270092 Industry Canada site registration number: 10288A-1

2.8. Measurement uncertainty

Test Item	Uncertainty
Bandwidth	1.1%
Peak Output Power(Conducted)(Spectrum analyzer)	0.86dB(10 MHz \leq f < 3.6GHz);
	1.38dB(3.6GHz \leq f < 8GHz)
Peak Output Power(Conducted)(Power Sensor)	0.74dB
Power Spectral Density	0.74dB(10 MHz \leq f < 3.6GHz);
	1.38dB(3.6GHz \leq f < 8GHz)
Frequencies Stability	6.7 x 10 ⁻⁸ (Antenna couple method)
	5.5 x 10 ⁻⁸ (Conducted method)
Conducted spurious emissions	0.86dB(10 MHz \leq f < 3.6GHz);
	1.40dB(3.6GHz \leq f < 8GHz)
	1.66dB(8GHz \leq f < 22GHz)
Uncertainty for radio frequency (RBW<20KHz)	3×10 ⁻⁸
Temperature	0.4℃
Humidity	2%
Uncertainty for Radiation Emission test (30MHz-1GHz)	4.70 dB (Antenna Polarize: V)
	4.84 dB (Antenna Polarize: H)
Uncertainty for Radiation Emission test (1GHz-26GHz)	4.10dB(1-6GHz)
	4.40dB (6GHz-18Gz)
	3.54dB (18GHz-26Gz)
Uncertainty for Power line conduction emission test	3.32dB (150KHz-30MHz)
Note: This uncertainty represents an expanded uncertainty expressed at approximately the 95% confidence level using a coverage factor of k=2.	

3. Equipment used during test

Equipment	Manufacturer	Model No.	Serial No.	Last Cal.	Cal. Interval
RF Connected test					
Spectrum analyzer	R&S	FSU26	1166.1660.26	2016/10/16	1Year
Vertor Signal Generator	Agilent	E8267D	MY52098743	2016/10/20	1Year
Vector Signal Generator	Agilent	N5182A	MY48180737	2016/07/05	1Year
Power Sensor	Agilent	U2021XA	MY55150010	2016/04/18	1Year
Power Sensor	Agilent	U2021XA	MY55150011	2016/04/19	1Year
DC Power Source	MATRIS	MPS-3005L-3	D813058W	2016/10/24	1Year
Attenuator	Mini-Circuits	BW-S10W2	101109	2016/08/18	1Year
RF Cable	Micable	C10-01-01-1	100309	2016/08/18	1Year
Temp&Humi Programmable Chamber	Dongguan Bell	BE-TH-150M3	201208153364	2016/09/23	1Year
Test Software	JS Tonscend	JS1120-2	Ver.2.5	N/A	N/A
USB Data acquisition	Agilent	U2531A	TW55043503	N/A	N/A
Auto control Unit	JS Tonscend	JS0806-2	158060010	N/A	N/A
RE/RF in chamber					
EMI Test Receiver	R&S	ESU8	100316	2016/10/16	1Year
Spectrum analyzer	R&S	FSU26	1166.1660.26	2016/10/16	1Year
Trilog Broadband Antenna	Schwarzbeck	VULB9163	9163-462	2016/10/27	1 Year
Active Loop antenna	Schwarzbeck	FMZB-1519	1519-038	2016/10/27	1 Year
Double Ridged Horn Antenna	R&S	HF907	100276	2016/10/12	1 Year
Pre-amplifier	A.H.	PAM-0118	360	2016/10/16	1 Year
RF Cable	HUBSER	CP-X2	W11.03	2016/10/16	1Year
RF Cable	HUBSER	CP-X1	W12.02	2016/10/16	1 Year
MI Cable	HUBSER	C10-01-01-1M	1091629	2016/10/16	1 Year
Test software	Audix	E3	V 6.11111b	/	/
Conducted disturbance at mains terminals/Telecommunication port					
Test Receiver	R&S	ESU8	100316	2016/10/16	1 Year
LISN 1	R&S	ENV216	101109	2016/10/16	1 Year
LISN 2	R&S	ESH2-Z5	100309	2016/10/16	1 Year
8 Line ISN	R&S	ENY81	100063	2016/10/16	1Year
Pulse Limiter	R&S	ESH3-Z2	101242	2016/10/16	1 Year
CE Cable 1	HUBSER	ESU8/RF2	W10.01	2016/10/16	1 Year
Test software	Audix	E3	V 6.11111b	/	/

4. 6dB Bandwidth and 99% Bandwidth

4.1. Block diagram of test setup

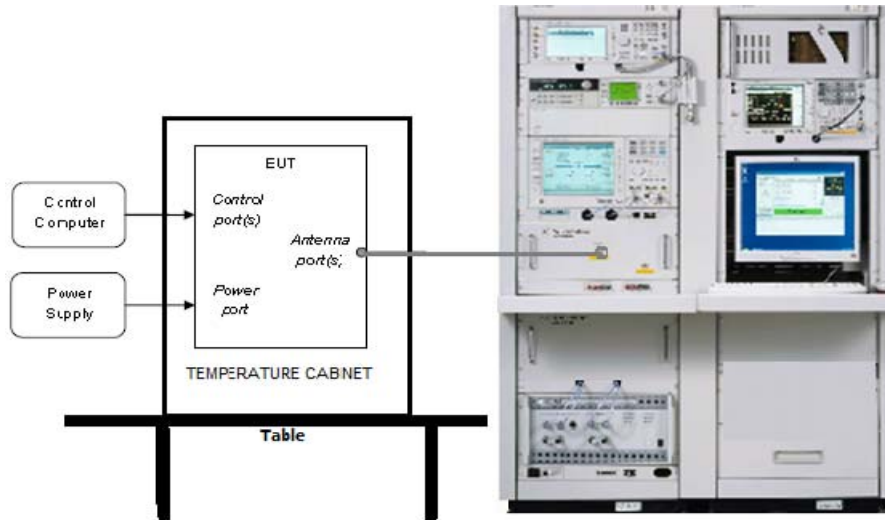

4.2. Limits

For direct sequence systems, the minimum 6dB bandwidth shall be at least 500 KHz

4.3. Test Procedure

- (1) Connect EUT's antenna output to spectrum analyzer by RF cable.
- (2) Set the spectrum analyzer as follows:

RBW:	100KHz
VBW:	300KHz
Detector Mode:	Peak
Sweep time:	auto
Trace mode	Max hold

- (3) Allow the trace to stabilize, measure the maximum width of the emission that is constrained by the frequencies associated with the two outermost amplitude points (upper and lower frequencies) that are attenuated by 6 dB relative to the maximum level measured in the fundamental emission.

4.4. Test Result

EUT Set Mode	CH or Frequency	6 dB bandwidth	99% dB bandwidth
		Result (MHz)	Result (MHz)
Antenna 1			
11b	CH1	9.560	13.960
	CH6	9.120	14.000
	CH11	8.720	13.800
11g	CH1	15.160	16.320
	CH6	15.160	16.320
	CH11	15.160	16.200
11n HT 20	CH1	16.040	17.440
	CH6	15.160	17.480
	CH11	15.160	17.440
11n HT 40	CH3	34.000	35.680
	CH6	35.280	35.840
	CH9	35.360	35.840
Limit: >500KHz		Conclusion: PASS	

4.5. Original test data

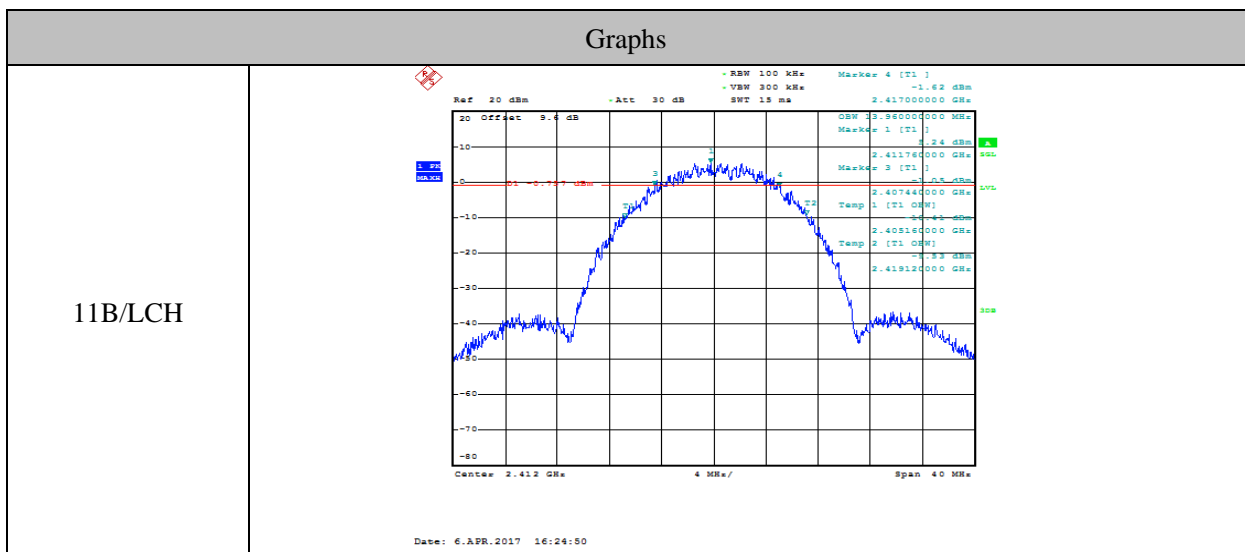

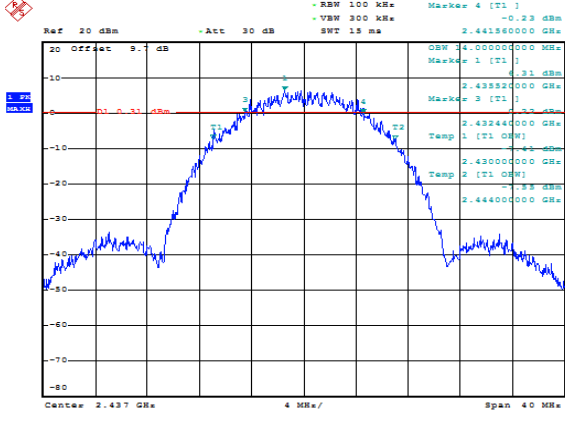
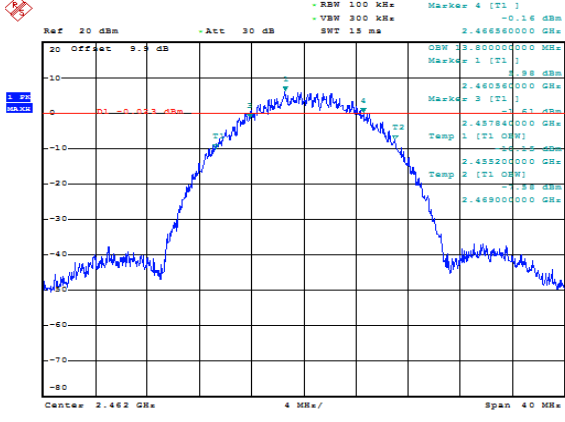
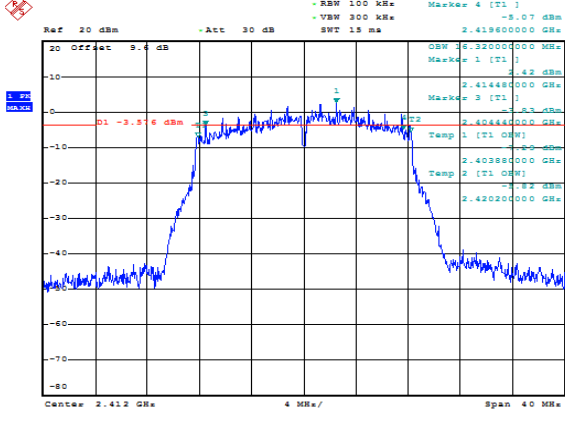
<p>11B/MCH</p>	 <p>Ref 20 dBm Offset 9.7 dB -Att 30 dB -RBW 100 KHz -VBW 300 KHz SWT 15 ms</p> <p>OSW 2.40000000 GHz -0.23 dBm Marker 1 [T1] 2.431 dBm Marker 3 [T1] 2.43244000 GHz Temp 1 [T1 OFF] 2.43244000 GHz Temp 2 [T1 OFF] 2.43000000 GHz Marker 4 [T1] 2.44156000 GHz</p> <p>Center 2.437 GHz 4 MHz/ Span 40 MHz</p> <p>Date: 6.APR.2017 16:27:21</p>
<p>11B/HCH</p>	 <p>Ref 20 dBm Offset 9.5 dB -Att 30 dB -RBW 100 KHz -VBW 300 KHz SWT 15 ms</p> <p>OSW 2.46556000 GHz -0.16 dBm Marker 1 [T1] 2.46056000 GHz Marker 3 [T1] 2.45784000 GHz Temp 1 [T1 OFF] 2.45784000 GHz Temp 2 [T1 OFF] 2.45820000 GHz Marker 4 [T1] 2.46900000 GHz</p> <p>Center 2.462 GHz 4 MHz/ Span 40 MHz</p> <p>Date: 6.APR.2017 16:29:30</p>
<p>11G/LCH</p>	 <p>Ref 20 dBm Offset 9.4 dB -Att 30 dB -RBW 100 KHz -VBW 300 KHz SWT 15 ms</p> <p>OSW 2.41960000 GHz -3.07 dBm Marker 1 [T1] 2.4142 dBm Marker 3 [T1] 2.40444000 GHz Temp 1 [T1 OFF] 2.40388000 GHz Temp 2 [T1 OFF] 2.42020000 GHz</p> <p>Center 2.412 GHz 4 MHz/ Span 40 MHz</p> <p>Date: 6.APR.2017 16:32:05</p>

<p>11G/MCH</p>	<p>Ref 20 dBm -Att 30 dB -RBW 100 kHz Marker 4 [T1] -4.43 dBm -VBW 300 kHz 2.44460000 GHz SWT 15 ms</p> <p>OSW 6.32000000 MHz Marker 1 [T1] 2.86 dBm 2.43572000 GHz Marker 3 [T1] -3.039 dBm 2.44284000 GHz Temp 1 [T1 ON] -60 dBm 2.42884000 GHz Temp 2 [T1 ON] -71 dBm 2.44516000 GHz</p> <p>Center 2.437 GHz 4 MHz/ Span 40 MHz</p> <p>Date: 6.APR.2017 16:34:31</p>
<p>11G/HCH</p>	<p>Ref 20 dBm -Att 30 dB -RBW 100 kHz Marker 4 [T1] -6.02 dBm -VBW 300 kHz 2.46960000 GHz SWT 15 ms</p> <p>OSW 6.20000000 MHz Marker 1 [T1] 2.62 dBm 2.46448000 GHz Marker 3 [T1] -3.379 dBm 2.46444000 GHz Temp 1 [T1 ON] -60 dBm 2.43396000 GHz Temp 2 [T1 ON] -71 dBm 2.47016000 GHz</p> <p>Center 2.462 GHz 4 MHz/ Span 40 MHz</p> <p>Date: 6.APR.2017 16:36:34</p>
<p>11N20SISO/LCH</p>	<p>Ref 20 dBm -Att 30 dB -RBW 100 kHz Marker 4 [T1] -4.01 dBm -VBW 300 kHz 2.42048000 GHz SWT 15 ms</p> <p>OSW 7.44000000 MHz Marker 1 [T1] 2.29 dBm 2.41328000 GHz Marker 3 [T1] -3.721 dBm 2.40444000 GHz Temp 1 [T1 ON] -60 dBm 2.40332000 GHz Temp 2 [T1 ON] -71 dBm 2.42076000 GHz</p> <p>Center 2.412 GHz 4 MHz/ Span 40 MHz</p> <p>Date: 6.APR.2017 16:39:08</p>

11N20SISO/MCH

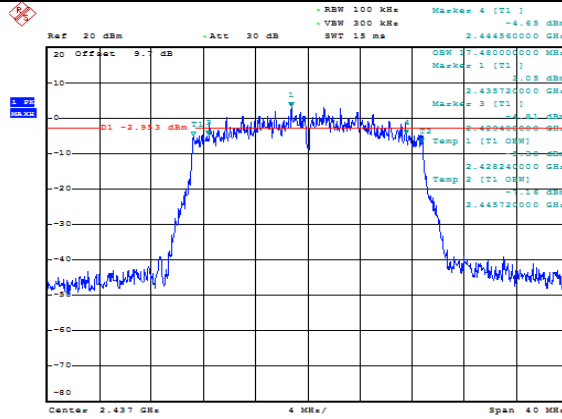

Date: 6.APR.2017 16:42:52

11N20SISO/HCH

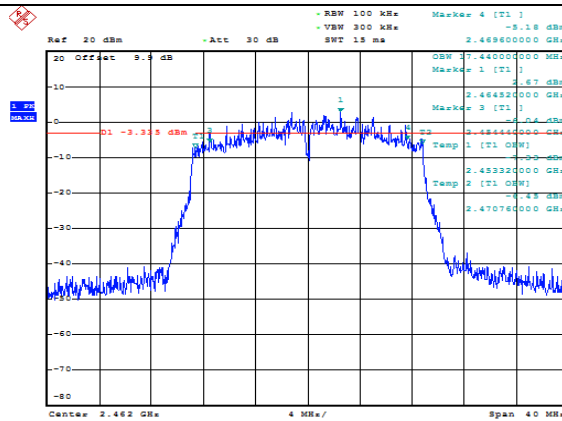

Date: 6.APR.2017 16:44:58

11N40SISO/LCH

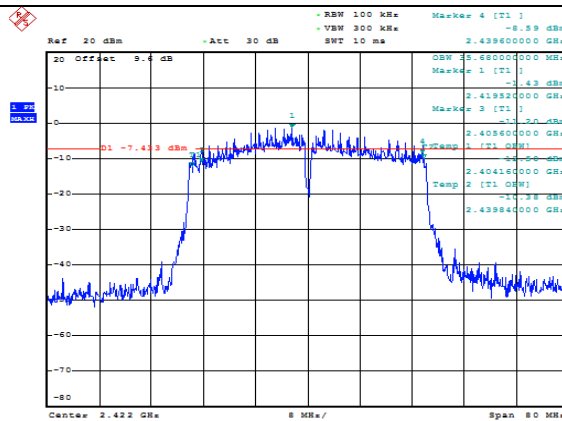

Date: 6.APR.2017 16:47:29

11N40SISO/MCH

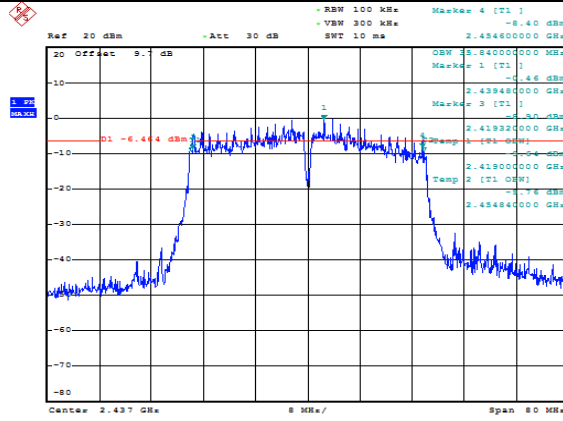

Date: 6.APR.2017 16:50:05

11N40SISO/HCH

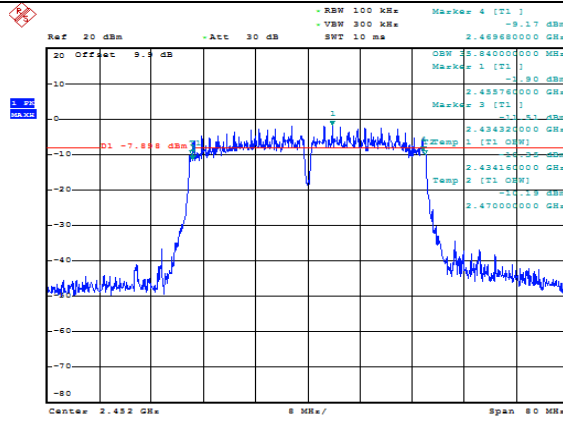

Date: 6.APR.2017 16:52:06

5. Conducted Peak Output Power

5.1. Block diagram of test setup

Same as section 4.1

5.2. Limits

For systems using digital modulation in the 902-928 MHz, 2400-2483.5 MHz, and 5725-5850 MHz bands: 1 Watt. If transmitting antennas of directional gain greater than 6 dBi are used, the conducted output power from the intentional radiator shall be reduced below the stated values as appropriate, by the amount in dB that the directional gain of the antenna exceeds 6 dBi.

5.3. Test Procedure

- (1) Connect each EUT's antenna output to power sensor by RF cable and attenuator
- (2) Measure the peak output power of each antenna port by power sensor.

5.4. Test Result

EUT Set Mode	CH	Result Peak
		(dBm)
11b	CH1	14.7
	CH6	15.77
	CH11	15.31
11g	CH1	11.69
	CH6	12.4
	CH11	12.07
11n HT20	CH1	11.38
	CH6	12.28
	CH11	12.02
11n HT40	CH3	9.22
	CH6	9.75
	CH9	9.66
Limit: 30dBm (Peak power)		Conclusion: PASS

6. Power Spectral Density

6.1. Block diagram of test setup

Same as section 4.1

6.2. Limits

For digitally modulated systems, the power spectral density conducted from the intentional radiator to the antenna shall not be greater than 8dBm in any 3 kHz band during any time interval of continuous transmission.

6.3. Test Procedure

(1) Connect EUT's antenna output to spectrum analyzer by RF cable.

(2) Set the spectrum analyzer as follows:

Center frequency	DTS Channel center frequency
RBW:	$3 \text{ kHz} \leq \text{RBW} \leq 100 \text{ kHz}$
VBW:	$\geq 3\text{RBW}$
Span	1.5times the DTS bandwidth
Detector Mode:	PK
Sweep time:	auto
Trace mode	Max hold

(3) Allow the trace to stabilize, use the peak marker function to determine the maximum amplitude level within the RBW.

(4) If measured value exceeds limit, reduce RBW (no less than 3 kHz) and repeat.

6.4. Test Result

EUT Set Mode	CH or Frequency	Result(dBm)
11b	CH1	7.68
	CH6	6.60
	CH11	3.07
11g	CH1	-2.62
	CH6	-2.13
	CH11	-2.16
11n HT 20	CH1	-2.45
	CH6	-1.02
	CH11	-1.45
11n HT 40	CH3	-5.75
	CH6	-6.11
	CH9	-6.31
Limit: <8dBm/3KHz		Conclusion: PASS

6.5. Original test data

Graphs	
11B/LCH	<p>Ref: 20 dBm, Att: 30 dB, RBW: 30 kHz, VSW: 100 kHz, SWT: 30 ms, Marker 1 [T1]: 7.68 dBm, 2.41200000 GHz</p> <p>Offset: 9.4 dB</p> <p>Center: 2.412 GHz, 1.912 MHz/, Span: 19.12 MHz</p> <p>Date: 6.APR.2017 16:25:04</p>
11B/MCH	<p>Ref: 20 dBm, Att: 30 dB, RBW: 100 kHz, VSW: 300 kHz, SWT: 15 ms, Marker 1 [T1]: 6.60 dBm, 2.435520000 GHz</p> <p>Offset: 9.7 dB</p> <p>Center: 2.437 GHz, 4 MHz/, Span: 40 MHz</p> <p>Date: 6.APR.2017 16:28:19</p>
11B/HCH	<p>Ref: 20 dBm, Att: 30 dB, RBW: 30 kHz, VSW: 100 kHz, SWT: 30 ms, Marker 1 [T1]: 3.07 dBm, 2.459244480 GHz</p> <p>Offset: 9.4 dB</p> <p>Center: 2.462 GHz, 1.744 MHz/, Span: 17.44 MHz</p> <p>Date: 6.APR.2017 16:30:14</p>

<p>11G/LCH</p>	<p>Ref 20 dBm - Att 30 dB - RBW 30 kHz - VBW 100 kHz - SWT 35 ms - Masker 1 [T1] -2.62 dBm 2.412636720 GHz</p> <p>20 Offset 9.4 dB</p> <p>Center 2.412 GHz 3.032 MHz/ Span 30.32 MHz</p> <p>Date: 6.APR.2017 16:32:49</p>
<p>11G/MCH</p>	<p>Ref 20 dBm - Att 30 dB - RBW 30 kHz - VBW 100 kHz - SWT 35 ms - Masker 1 [T1] -2.13 dBm 2.437636720 GHz</p> <p>20 Offset 9.1 dB</p> <p>Center 2.437 GHz 3.032 MHz/ Span 30.32 MHz</p> <p>Date: 6.APR.2017 16:35:15</p>
<p>11G/HCH</p>	<p>Ref 20 dBm - Att 30 dB - RBW 30 kHz - VBW 100 kHz - SWT 35 ms - Masker 1 [T1] -2.16 dBm 2.462636720 GHz</p> <p>20 Offset 9.4 dB</p> <p>Center 2.462 GHz 3.032 MHz/ Span 30.32 MHz</p> <p>Date: 6.APR.2017 16:37:18</p>

<p>11N20SISO/LCH</p>	<p>Ref 20 dBm - Att 30 dB - RBW 30 kHz - VSW 100 kHz - SWT 40 ms - Masker 1 [T1] -2.45 dBm 2.410716800 GHz</p> <p>20 Offset 9.4 dB</p> <p>Center 2.412 GHz 3.08 MHz/ Span 3.08 MHz</p> <p>Date: 6.APR.2017 16:39:52</p>
<p>11N20SISO/MC H</p>	<p>Ref 20 dBm - Att 30 dB - RBW 30 kHz - VSW 100 kHz - SWT 35 ms - Masker 1 [T1] -1.02 dBm 2.435726560 GHz</p> <p>20 Offset 9.1 dB</p> <p>Center 2.437 GHz 3.32 MHz/ Span 3.32 MHz</p> <p>Date: 6.APR.2017 16:49:36</p>
<p>11N20SISO/HCH</p>	<p>Ref 20 dBm - Att 30 dB - RBW 30 kHz - VSW 100 kHz - SWT 35 ms - Masker 1 [T1] -1.45 dBm 2.460726560 GHz</p> <p>20 Offset 9.4 dB</p> <p>Center 2.462 GHz 3.32 MHz/ Span 3.32 MHz</p> <p>Date: 6.APR.2017 16:45:41</p>

<p>11N40SISO/LCH</p>	<p>Ref 20 dBm - Att 30 dB - RBW 30 kHz - Masker 1 [T1] -5.79 dBm - VSW 100 kHz - SWT 80 ms 2.41696000 GHz</p> <p>20 Offset 9.4 dB</p> <p>Center 2.422 GHz 6.8 MHz/ Span 6.8 MHz</p> <p>Date: 6.APR.2017 16:48:19</p>
<p>11N40SISO/MC H</p>	<p>Ref 20 dBm - Att 30 dB - RBW 30 kHz - Masker 1 [T1] -6.11 dBm - VSW 100 kHz - SWT 80 ms 2.431990240 GHz</p> <p>20 Offset 9.1 dB</p> <p>Center 2.437 GHz 10.56 MHz/ Span 10.56 MHz</p> <p>Date: 6.APR.2017 16:50:49</p>
<p>11N40SISO/HCH</p>	<p>Ref 20 dBm - Att 30 dB - RBW 30 kHz - Masker 1 [T1] -6.31 dBm - VSW 100 kHz - SWT 80 ms 2.460769280 GHz</p> <p>20 Offset 9.4 dB</p> <p>Center 2.452 GHz 10.72 MHz/ Span 10.72 MHz</p> <p>Date: 6.APR.2017 16:59:20</p>

6.6. Band Edge and Spurious Emissions (Conducted)

6.7. Block diagram of test setup

Same as section 4.1

6.8. Limits

In any 100kHz bandwidth outside the frequency bands in which the spread spectrum intentional radiator is operating, the radio frequency power that is produced by the intentional radiator shall be at least 30dB below that in the 100kHz bandwidth within the band that contains the highest level of the desired power.

6.9. Test Procedure

(1) Connect EUT's antenna output to spectrum analyzer by RF cable.

(2) Establish a reference level by using the following procedure:

Center frequency	DTS Channel center frequency
RBW:	100KHz
VBW:	300KHz
Span	1.5times the DTS bandwidth
Detector Mode:	Peak
Sweep time:	auto
Trace mode	Max hold

(3) Allow the trace to stabilize, use the peak marker function to determine the maximum peak power level to establish the reference level.

(4) Set the spectrum analyzer as follows:

RBW:	100KHz
VBW:	300KHz
Span	Encompass frequency range to be measured
Number of measurement points	$\geq \text{span}/\text{RBW}$
Detector Mode:	Peak
Sweep time:	auto
Trace mode	Max hold

(5) Allow the trace to stabilize, use the peak marker function to determine the maximum amplitude of all unwanted emissions outside of the authorized frequency band

6.10. Test Result

EUT Set Mode	CH or Frequency	Result (dBm)	EUT Set Mode	CH or Frequency	Result (dBm)
11b	CH1	PASS	11n HT 20	CH1	PASS
	CH6	PASS		CH6	PASS
	CH11	PASS		CH11	PASS
11g	CH1	PASS	11n HT 40	CH3	PASS
	CH6	PASS		CH6	PASS
	CH11	PASS		CH9	PASS

6.11. Original test data

Band Edge:

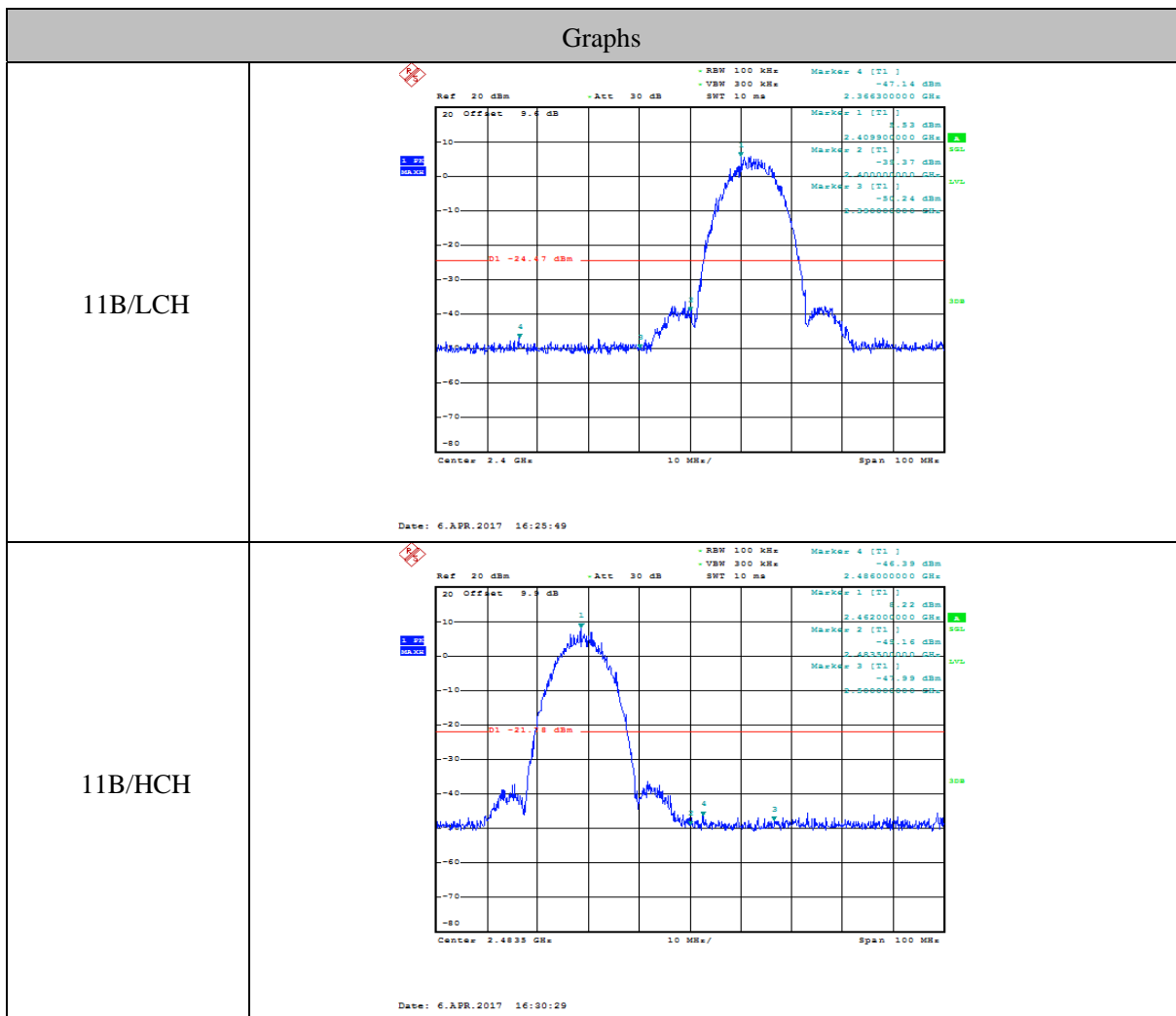

<p>11G/LCH</p>	<p>Ref 20 dBm -Att 30 dB -RBW 100 kHz Marker 4 [T1] -46.98 dBm -VSW 300 kHz 2.388900000 GHz SWT 10 ms</p> <p>Marker 1 [T1] -46.98 dBm Marker 2 [T1] -46.30 dBm Marker 3 [T1] -46.61 dBm Marker 4 [T1] -46.84 dBm</p> <p>D1 -27.42 dBm</p> <p>Center 2.4 GHz 10 MHz/ Span 100 MHz</p> <p>Date: 6.APR.2017 16:33:04</p>
<p>11G/HCH</p>	<p>Ref 20 dBm -Att 30 dB -RBW 100 kHz Marker 4 [T1] -46.80 dBm -VSW 300 kHz 2.483500000 GHz SWT 10 ms</p> <p>Marker 1 [T1] -46.80 dBm Marker 2 [T1] -46.78 dBm Marker 3 [T1] -46.34 dBm</p> <p>D1 -27.4 dBm</p> <p>Center 2.4835 GHz 10 MHz/ Span 100 MHz</p> <p>Date: 6.APR.2017 16:37:33</p>
<p>11N20SISO/LCH</p>	<p>Ref 20 dBm -Att 30 dB -RBW 100 kHz Marker 4 [T1] -46.07 dBm -VSW 300 kHz 2.378900000 GHz SWT 10 ms</p> <p>Marker 1 [T1] -46.07 dBm Marker 2 [T1] -46.23 dBm Marker 3 [T1] -46.84 dBm</p> <p>D1 -27.43 dBm</p> <p>Center 2.4 GHz 10 MHz/ Span 100 MHz</p> <p>Date: 6.APR.2017 16:40:06</p>

<p>11N20SISO/HCH</p>	<p>Ref 20 dBm -Att 30 dB -RBW 100 kHz -VSM 300 kHz SWT 10 ms</p> <p>Marker 4 [T1] -45.88 dBm 2.483900000 GHz</p> <p>Marker 1 [T1] -1.34 dBm 2.483200000 GHz</p> <p>Marker 2 [T1] -46.81 dBm 2.483200000 GHz</p> <p>Marker 3 [T1] -44.67 dBm 2.483200000 GHz</p> <p>01 -27.06 dBm</p> <p>Center 2.4835 GHz 10 MHz/ Span 100 MHz</p> <p>Date: 6.APR.2017 16:45:56</p>
<p>11N40SISO/LCH</p>	<p>Ref 20 dBm -Att 30 dB -RBW 100 kHz -VSM 300 kHz SWT 10 ms</p> <p>Marker 4 [T1] -41.86 dBm 2.487000000 GHz</p> <p>Marker 1 [T1] -1.74 dBm 2.419500000 GHz</p> <p>Marker 2 [T1] -41.88 dBm 2.420000000 GHz</p> <p>Marker 3 [T1] -1.07 dBm 2.420000000 GHz</p> <p>01 -30.14 dBm</p> <p>Center 2.4 GHz 10 MHz/ Span 100 MHz</p> <p>Date: 6.APR.2017 16:48:28</p>
<p>11N40SISO/HCH</p>	<p>Ref 20 dBm -Att 30 dB -RBW 100 kHz -VSM 300 kHz SWT 10 ms</p> <p>Marker 4 [T1] -41.86 dBm 2.487000000 GHz</p> <p>Marker 1 [T1] -1.93 dBm 2.484500000 GHz</p> <p>Marker 2 [T1] -44.55 dBm 2.483500000 GHz</p> <p>Marker 3 [T1] -44.84 dBm 2.483500000 GHz</p> <p>01 -31.93 dBm</p> <p>Center 2.4835 GHz 10 MHz/ Span 100 MHz</p> <p>Date: 6.APR.2017 16:53:35</p>

Spurious Emissions

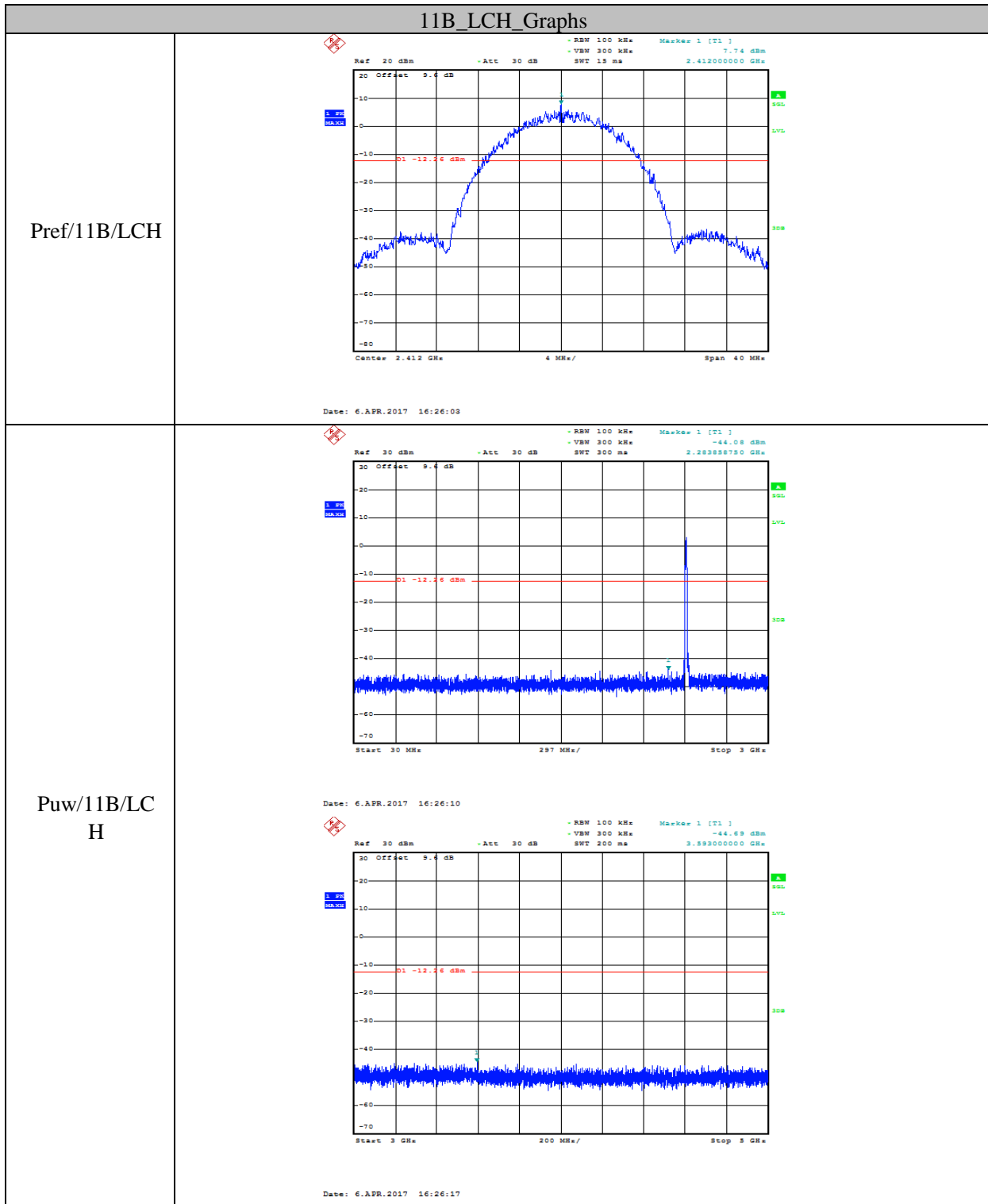

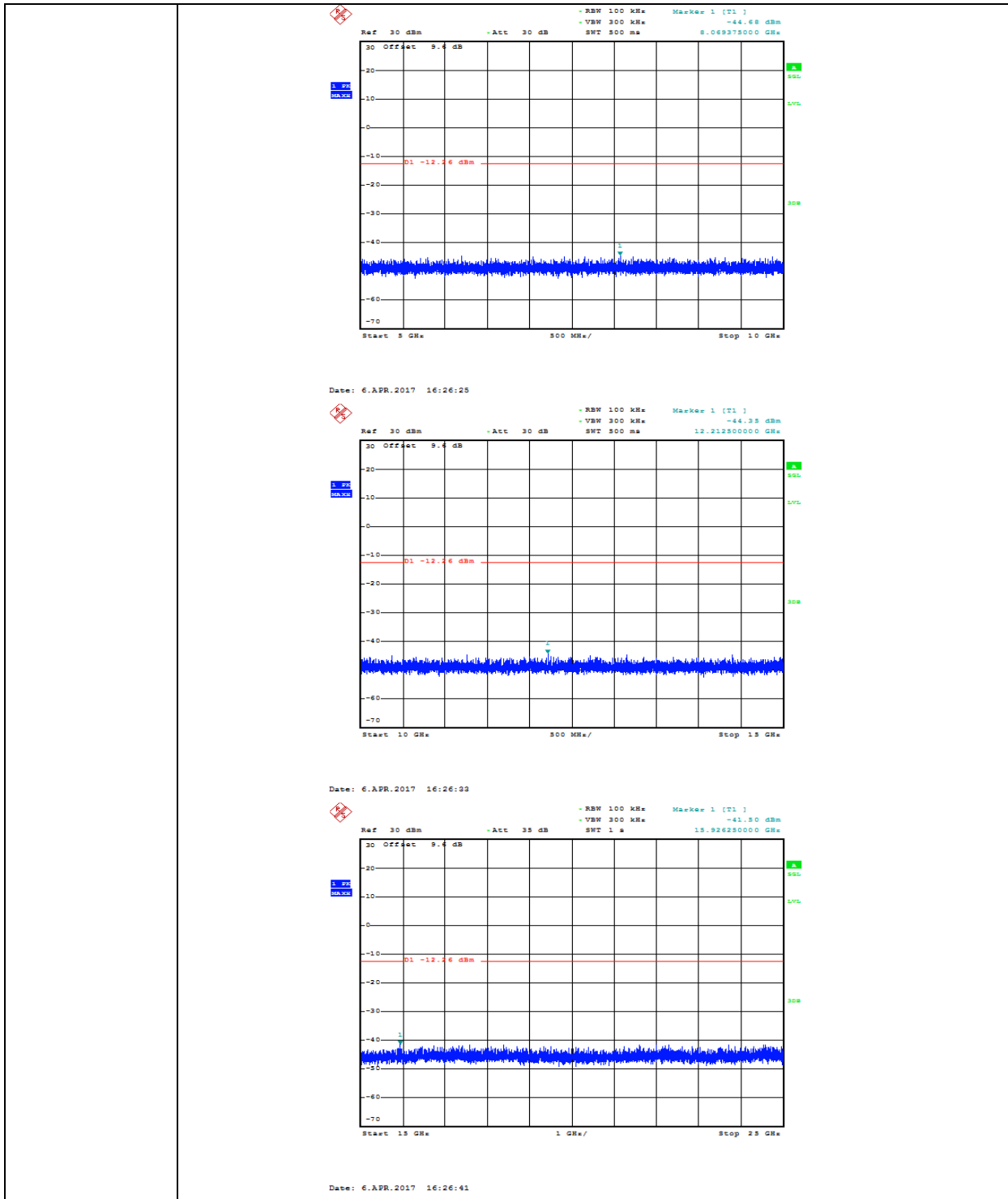

11B_MCH_Graphs

Pref/11B/MCH

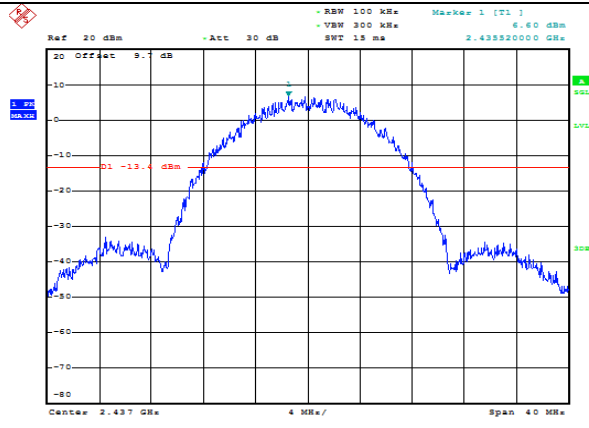

Date: 6.APR.2017 16:28:19

Puw/11B/MCH

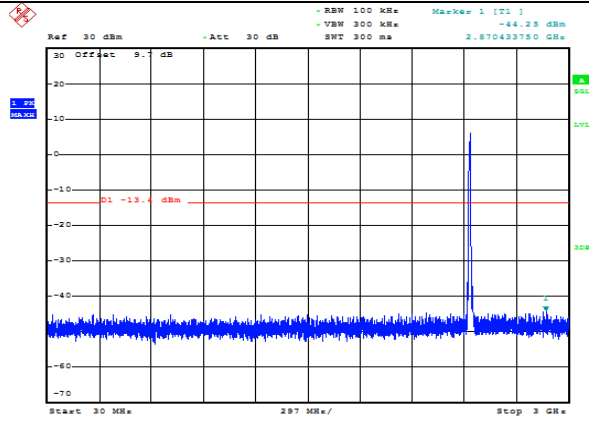

Date: 6.APR.2017 16:28:26

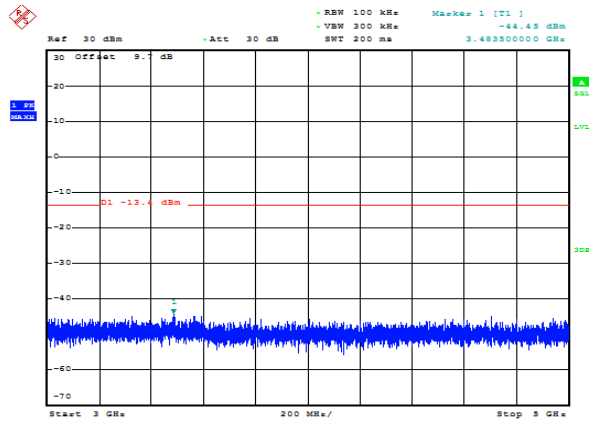

Date: 6.APR.2017 16:28:33

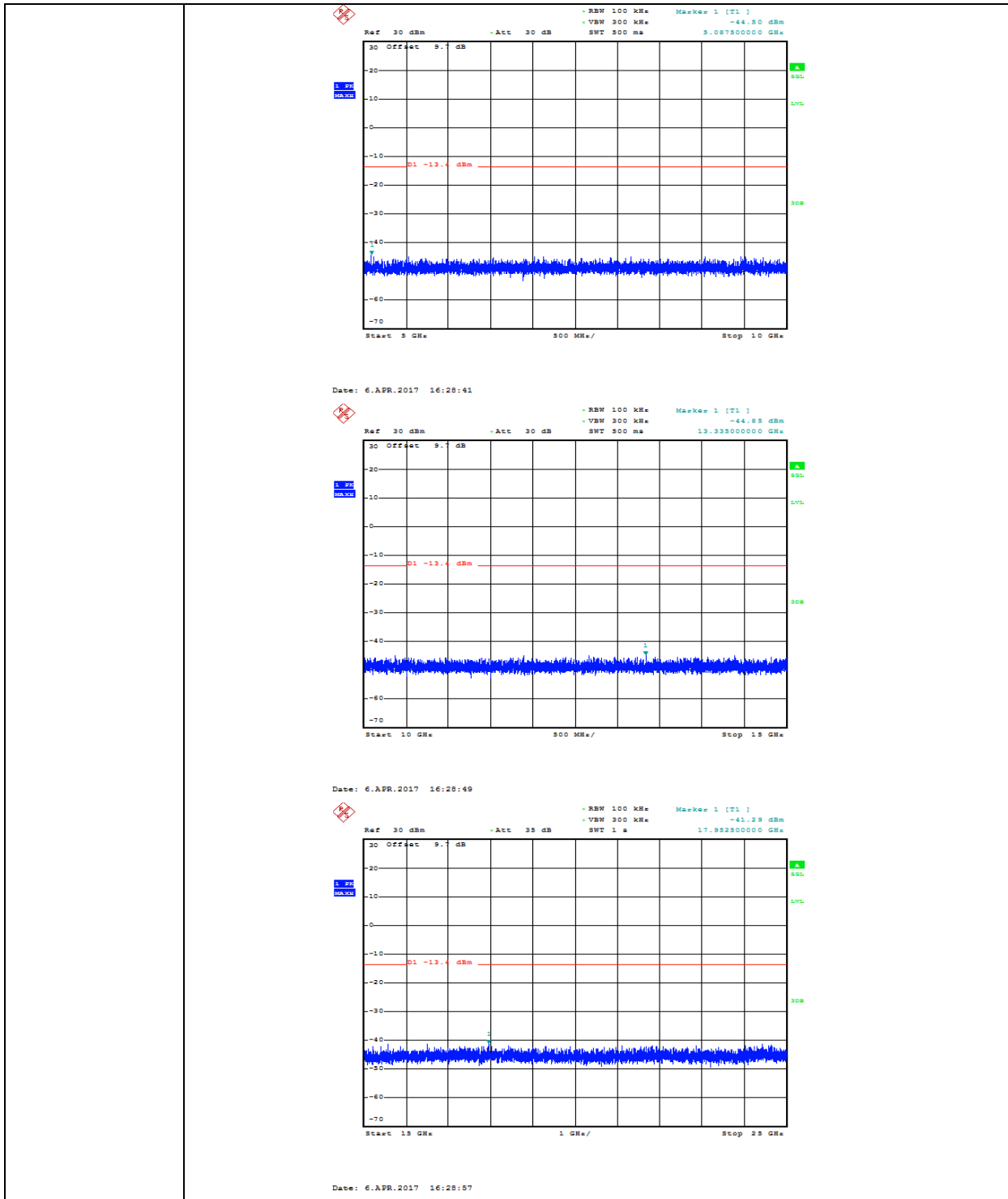

11B_HCH_Graphs

Pref/11B/HCH

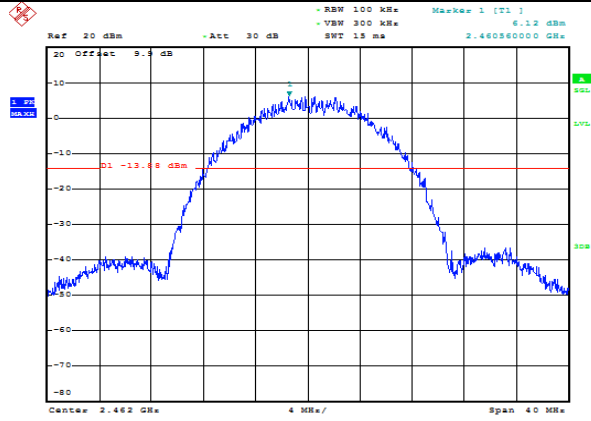

Date: 6.APR.2017 16:30:49

Puw/11B/HC
H

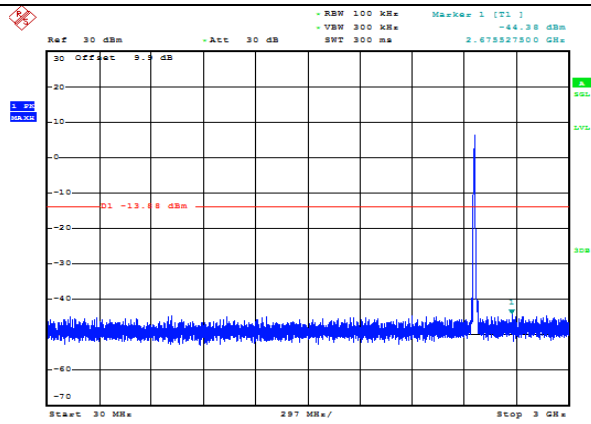

Date: 6.APR.2017 16:30:50

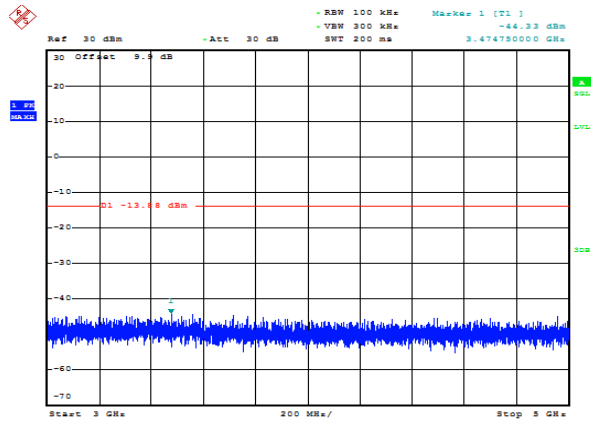

Date: 6.APR.2017 16:30:57

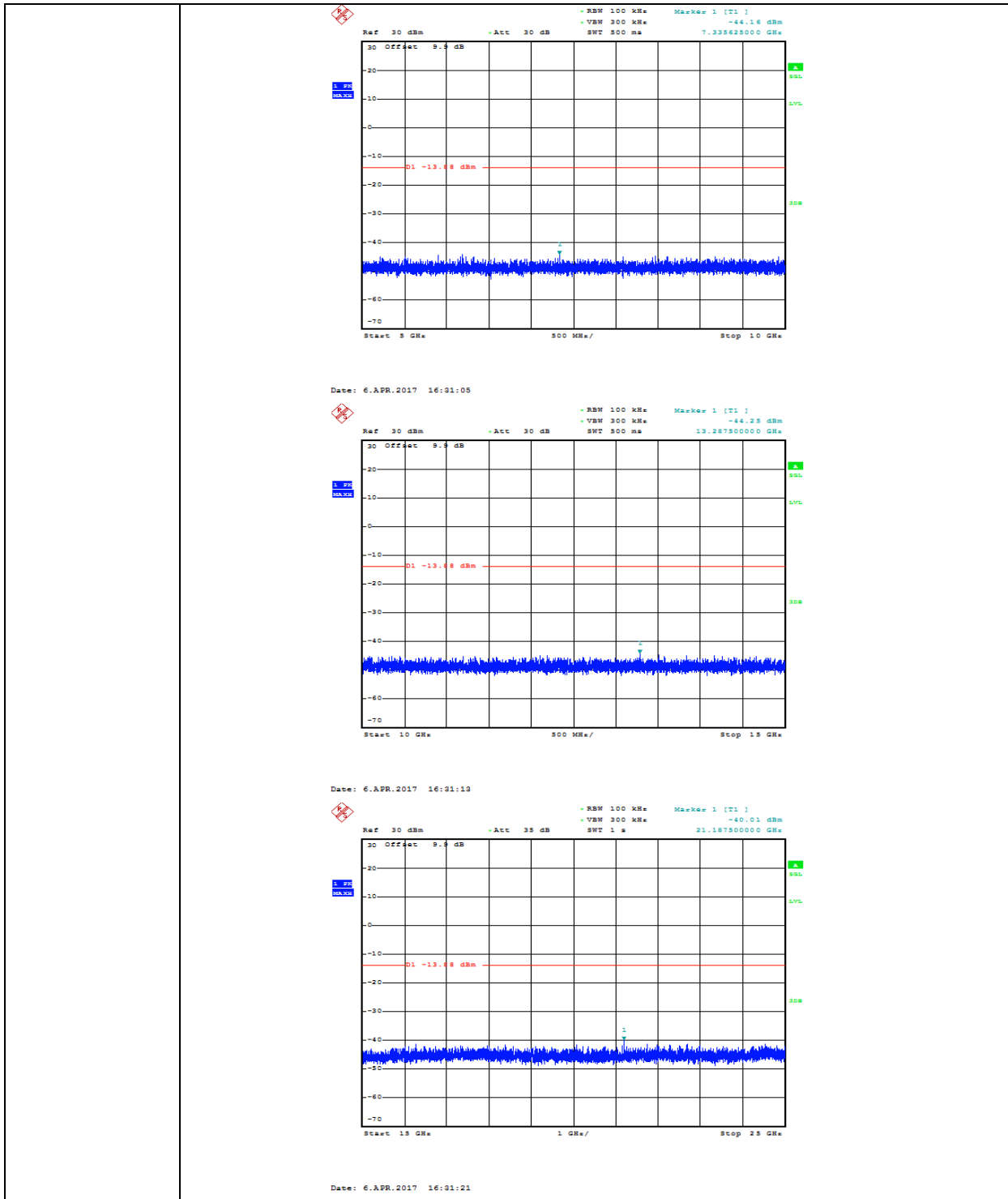

11G_LCH_Graphs

Pref/11G/LCH

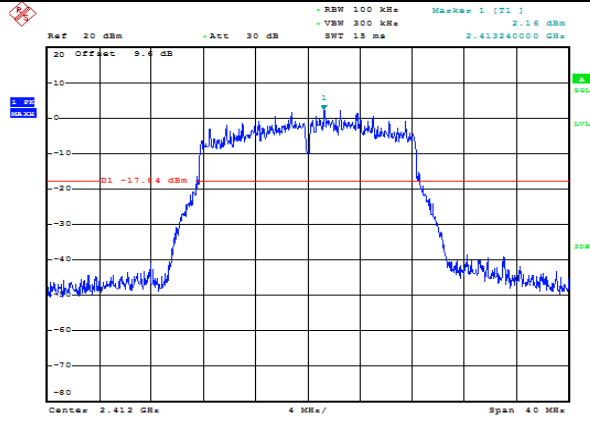

Date: 6.APR.2017 16:33:19

Puw/11G/LC
H

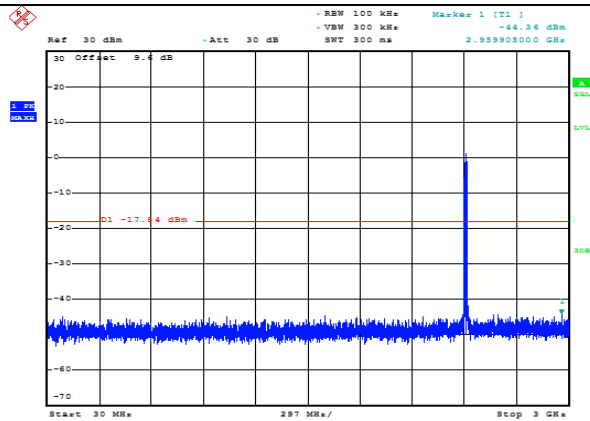

Date: 6.APR.2017 16:33:25

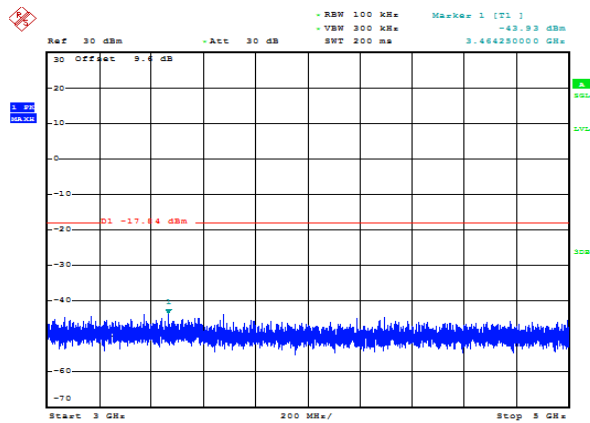

Date: 6.APR.2017 16:33:32

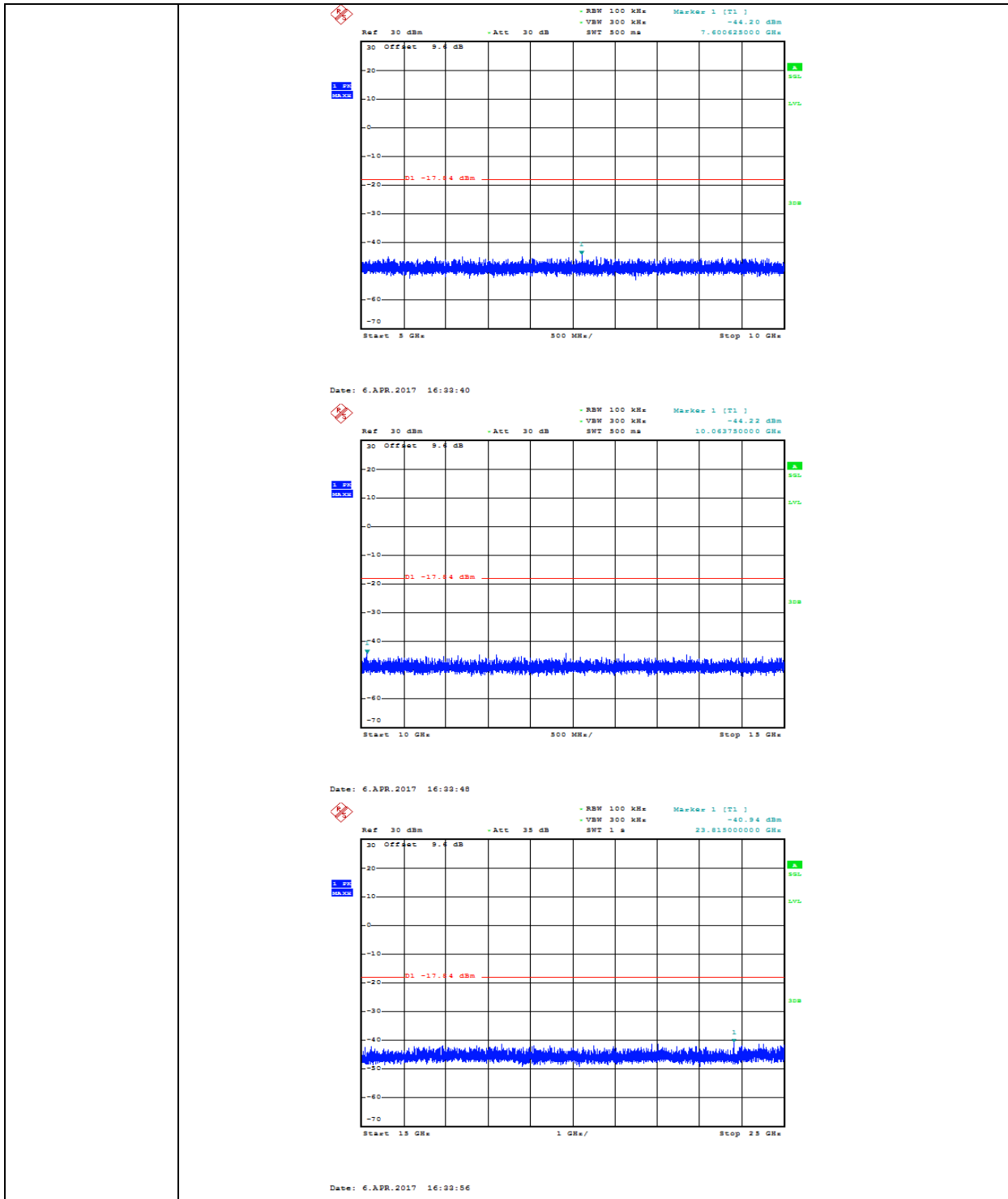

11G_MCH_Graphs

Pref/11G/MCH

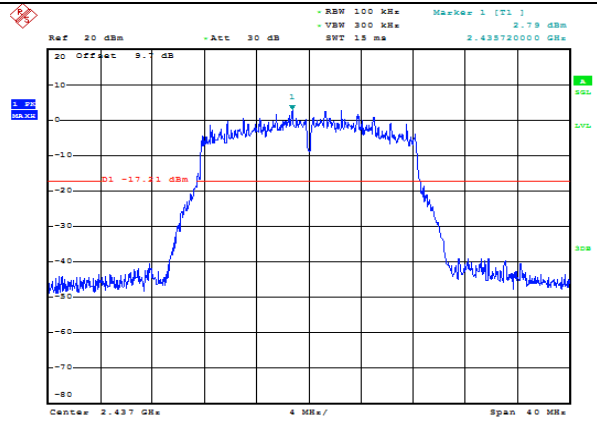

Date: 6.APR.2017 16:35:29

Puw/11G/MCH

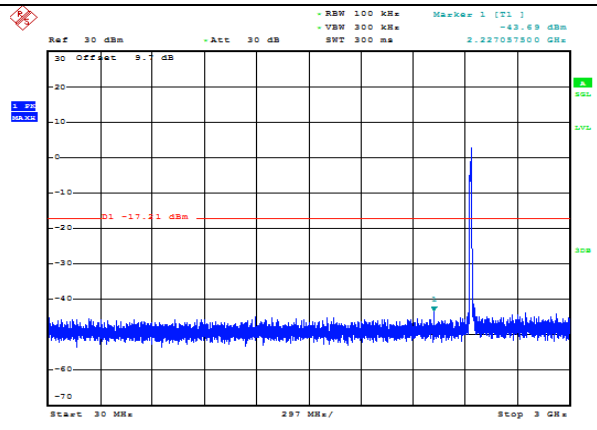

Date: 6.APR.2017 16:35:36

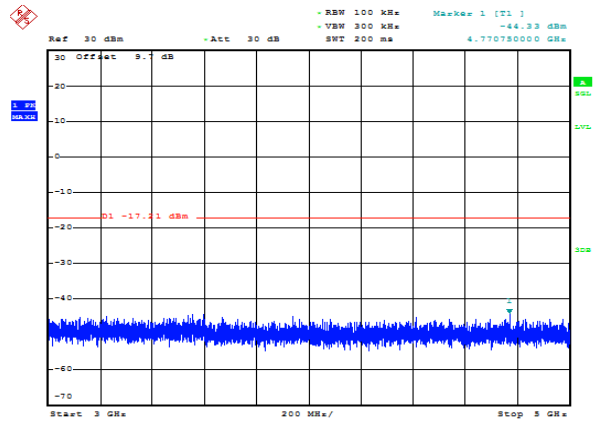

Date: 6.APR.2017 16:35:43

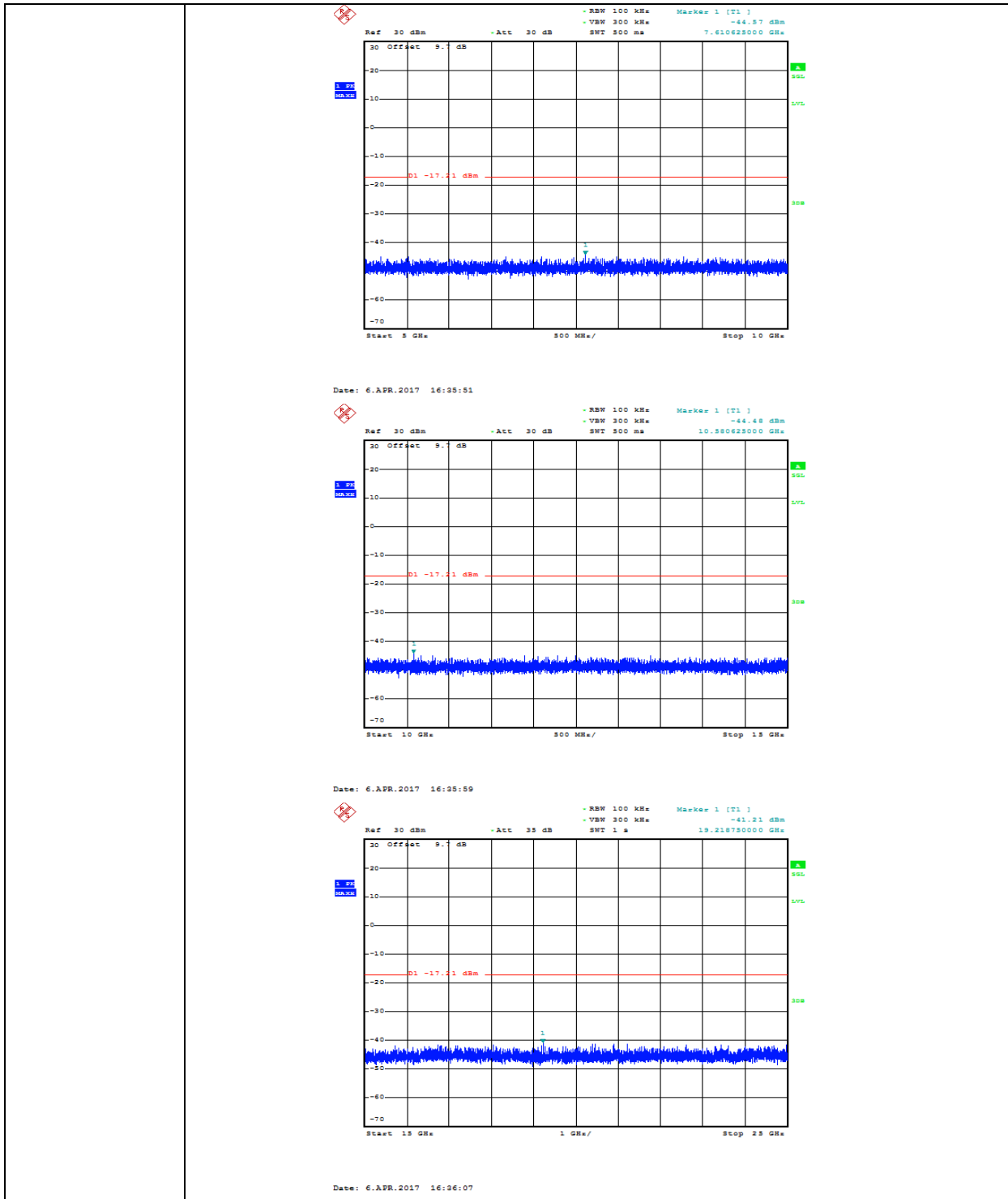

11G_HCH_Graphs

Pref/11G/HCH

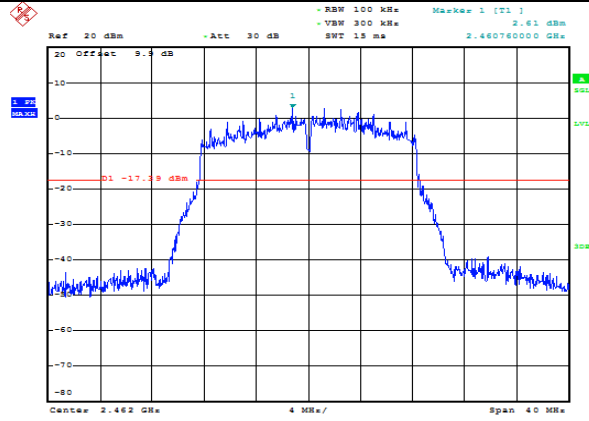

Date: 6.APR.2017 16:37:48

Puw/11G/HCH

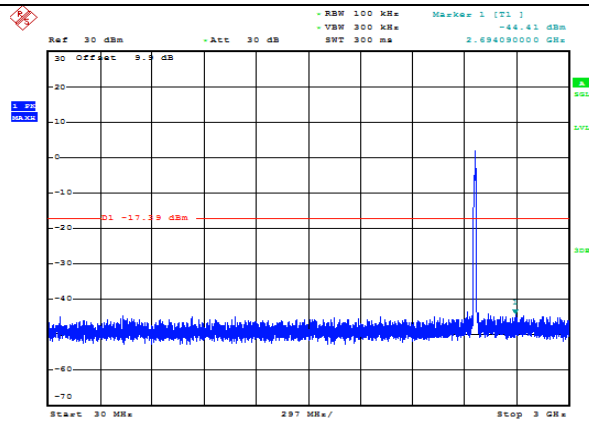

Date: 6.APR.2017 16:37:55

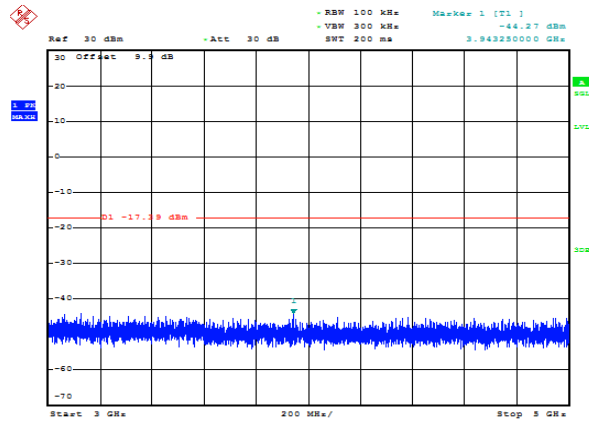

Date: 6.APR.2017 16:38:01

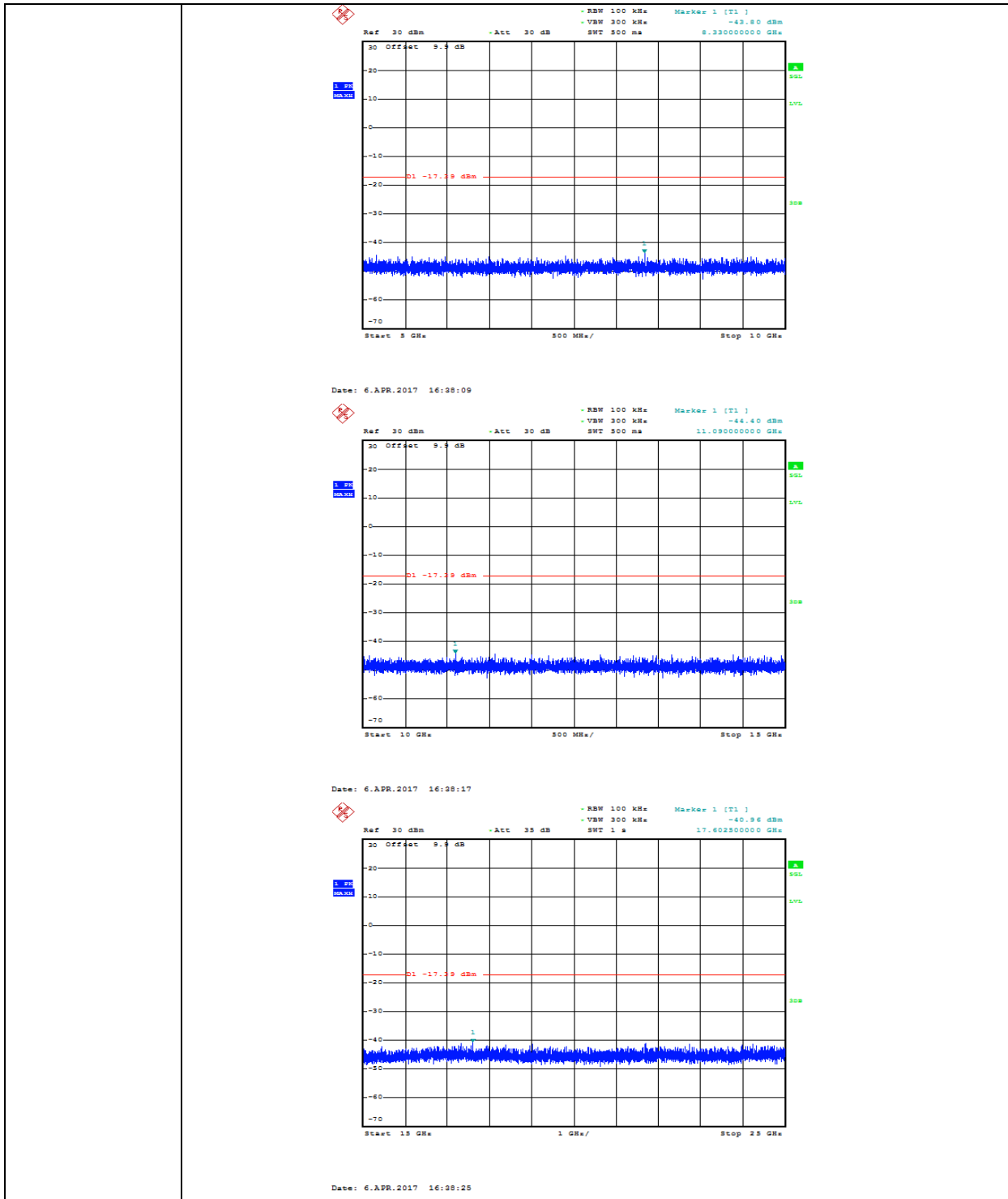

11N20SISO_LCH_Graphs

Pref/11N20SI
SO/LCH

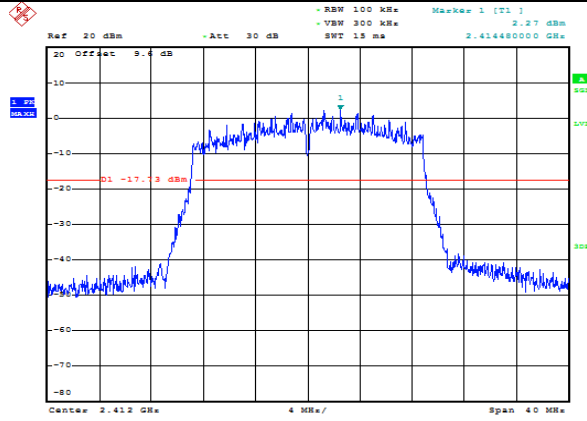

Date: 6.APR.2017 16:40:21

/11N20SISO/
LCH

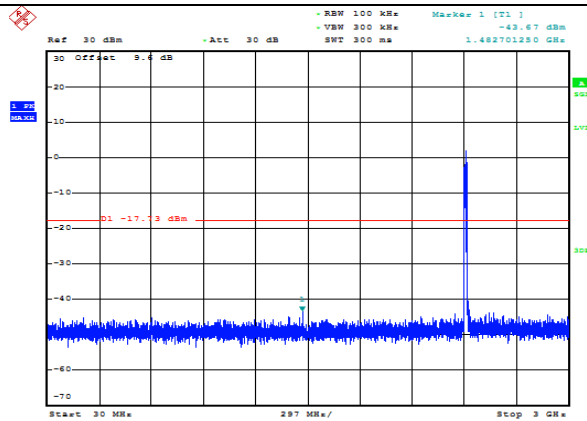

Date: 6.APR.2017 16:40:28

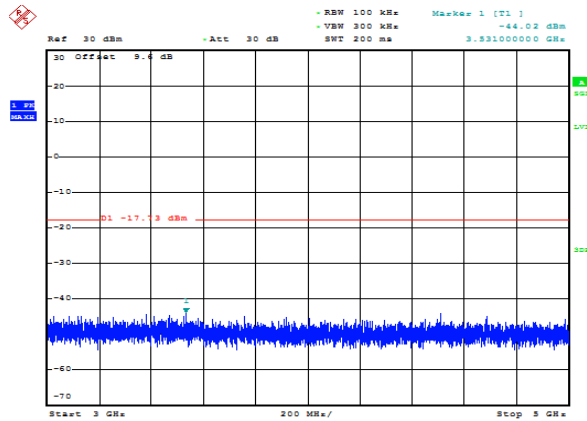

Date: 6.APR.2017 16:40:34

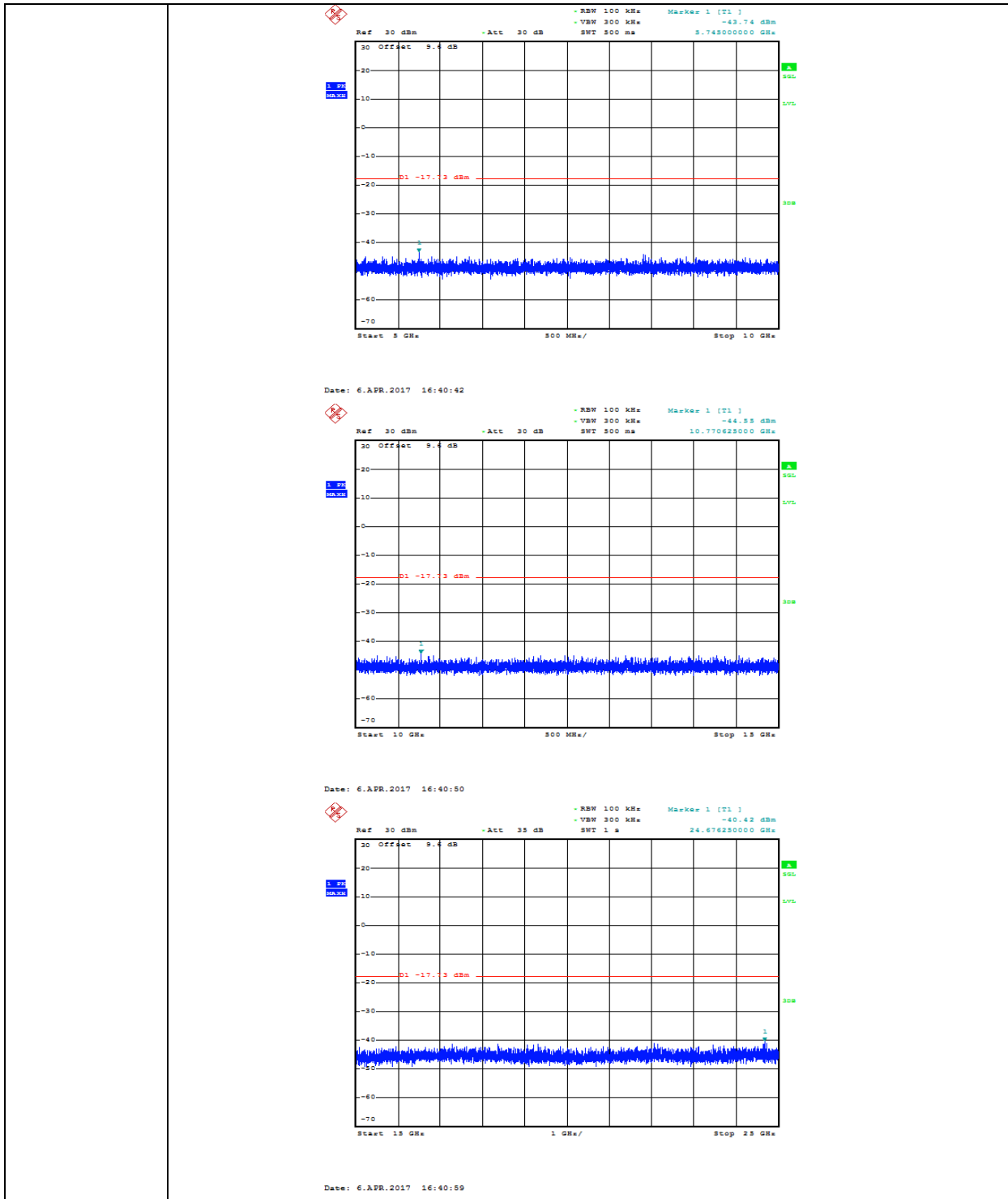

11N20SISO_MCH_Graphs

Pref/11N20SI
SO/MCH

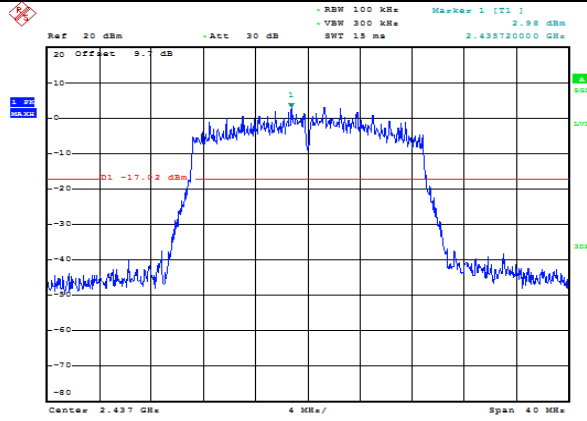

Date: 6.APR.2017 16:40:50

Puw/11N20S
ISO/MCH

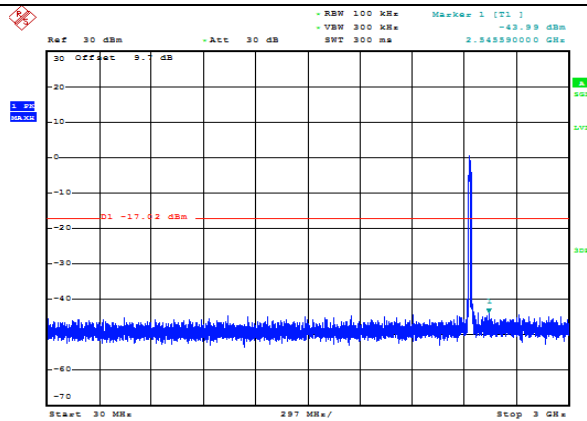

Date: 6.APR.2017 16:40:57

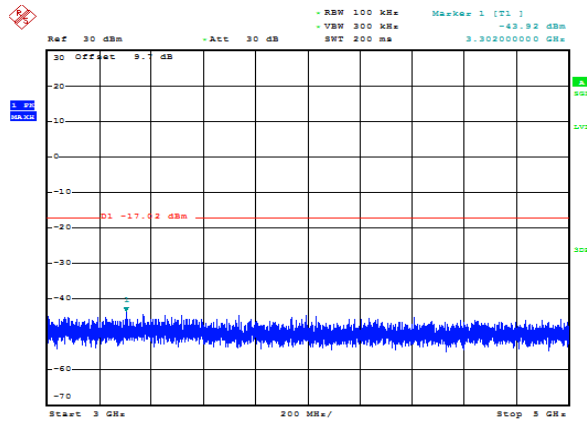

Date: 6.APR.2017 16:44:09



11N20SISO_HCH_Graphs

Pref/11N20SI
SO/HCH

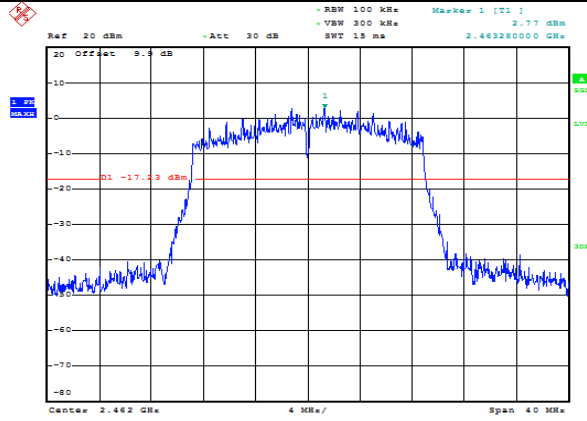

Date: 6.APR.2017 16:46:11

Puw/11N20S
ISO/HCH

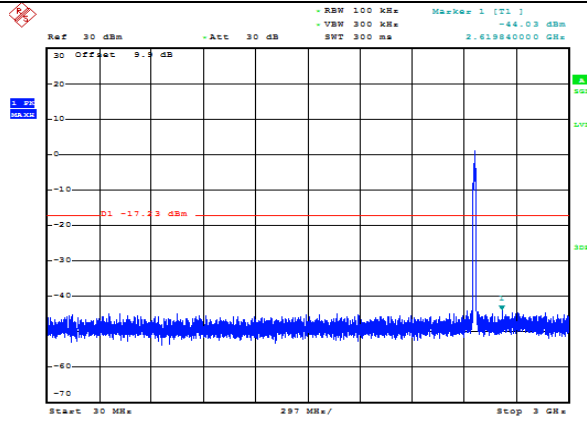

Date: 6.APR.2017 16:46:18

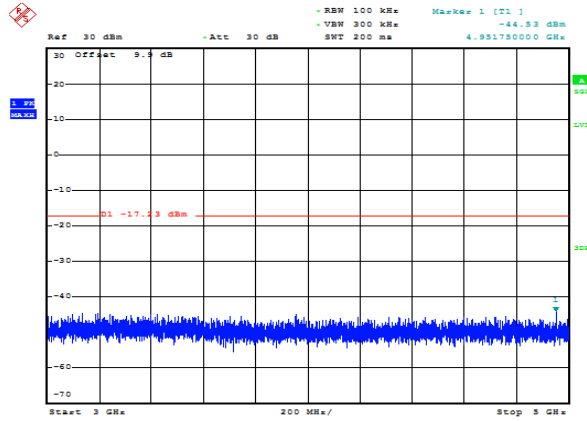

Date: 6.APR.2017 16:46:24

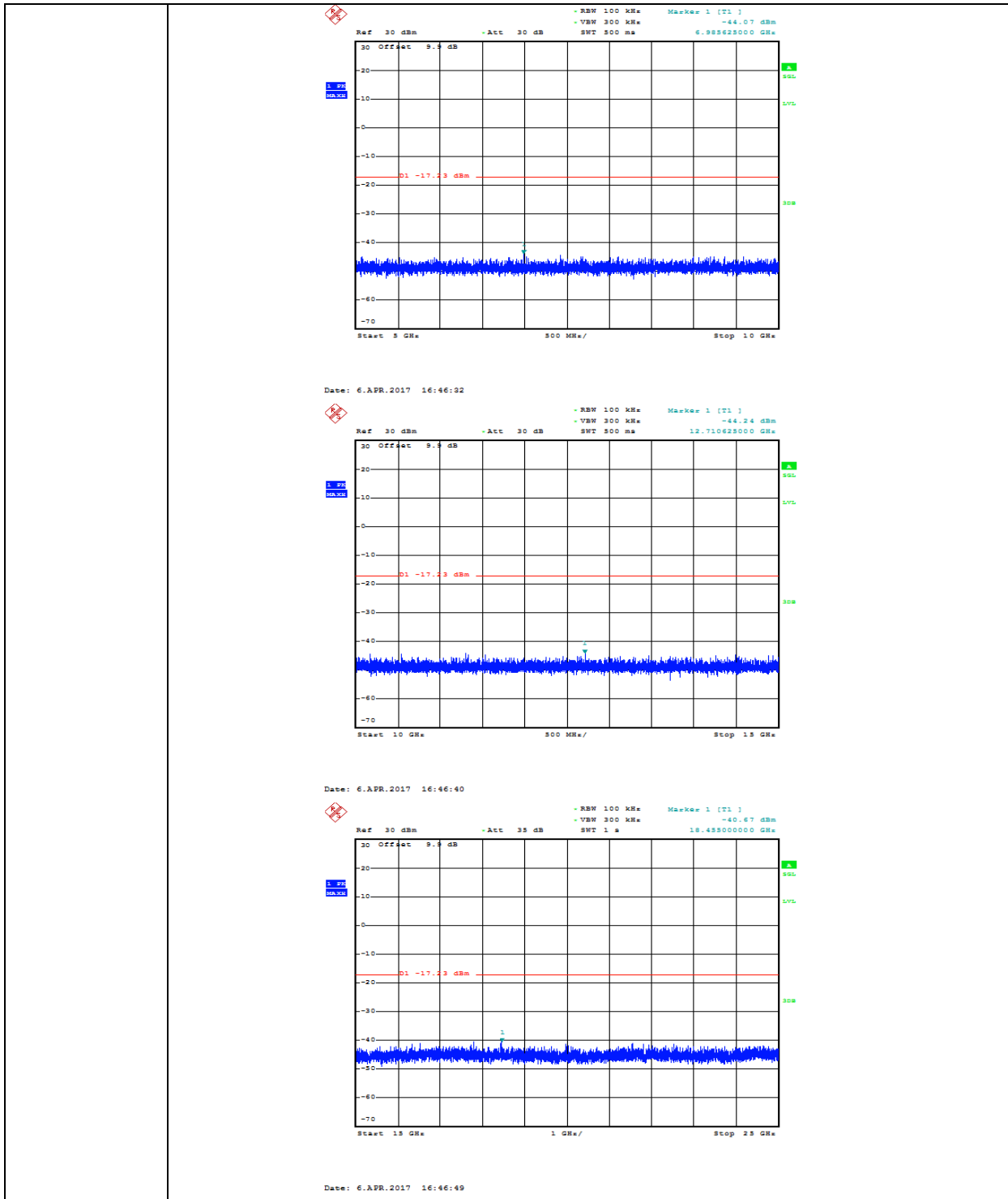

11N40SISO_LCH_Graphs

Pref/11N40SI
SO/LCH

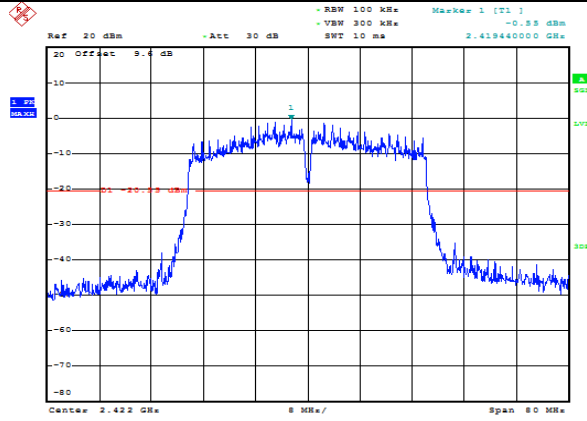

Date: 6.APR.2017 16:48:42

Puw/11N40S
ISO/LCH

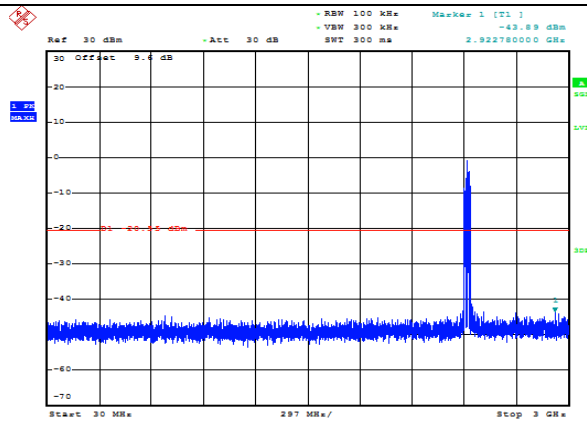

Date: 6.APR.2017 16:48:50

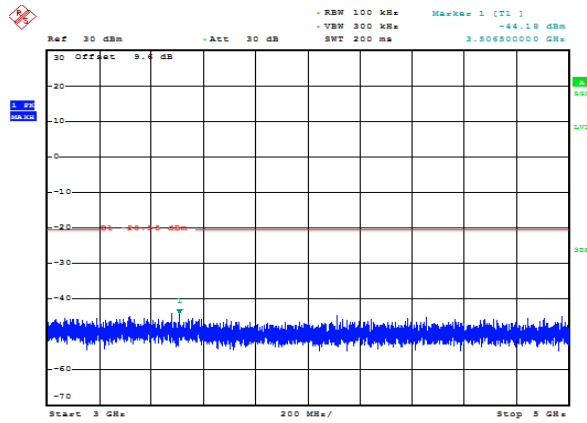

Date: 6.APR.2017 16:48:56

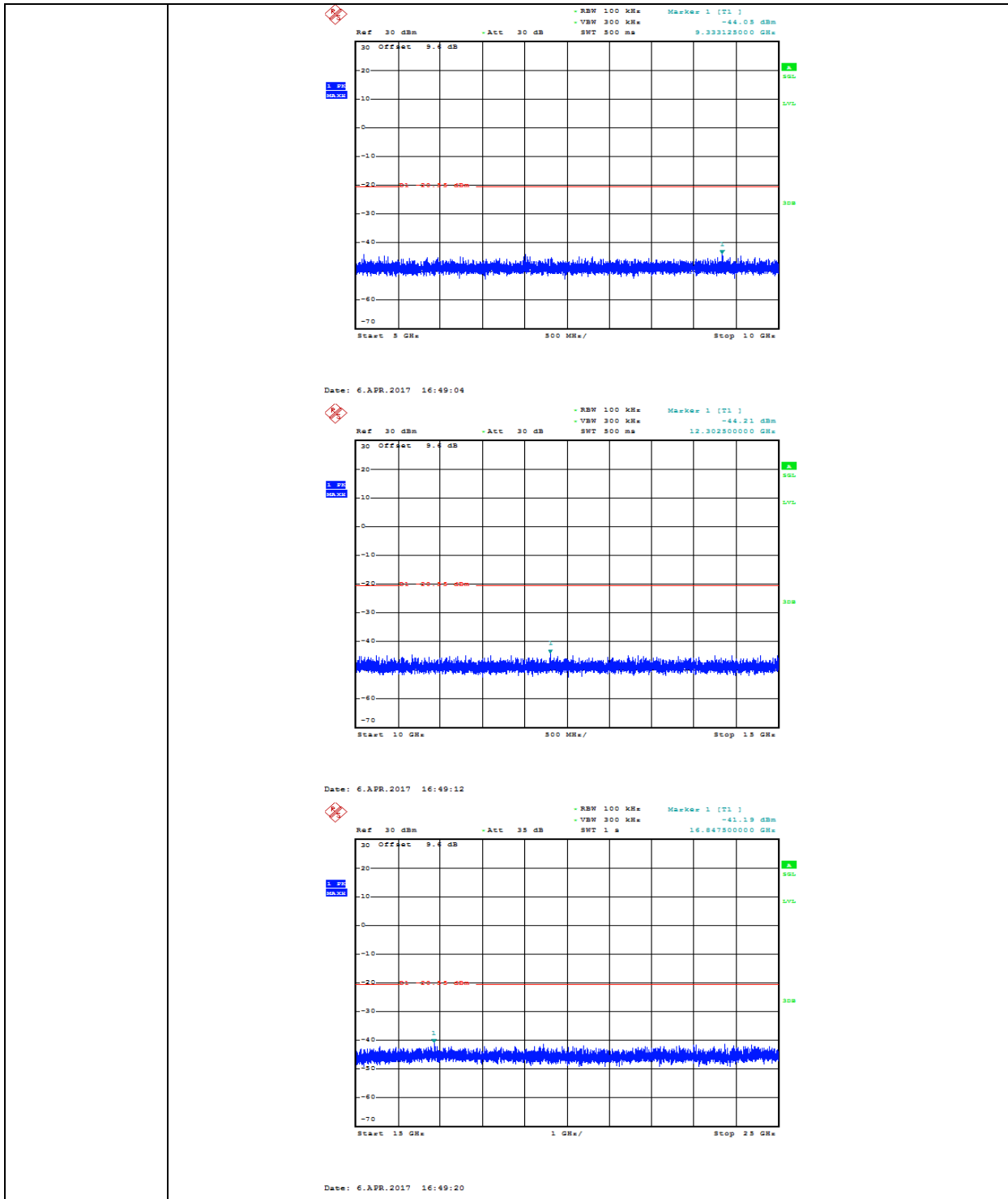

11N40SISO_MCH_Graphs

Pref/11N40SI
SO/MCH

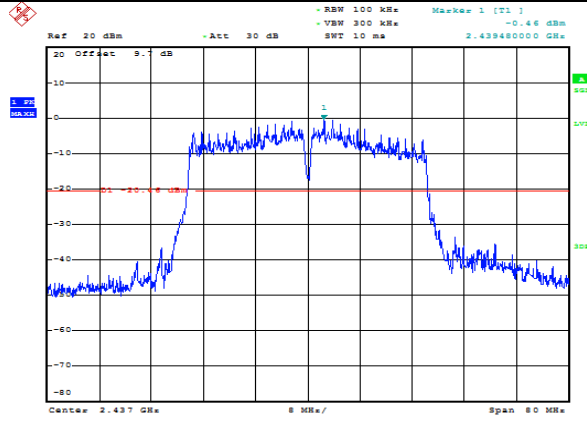

Date: 6.APR.2017 16:51:04

Puw/11N40S
ISO/MCH

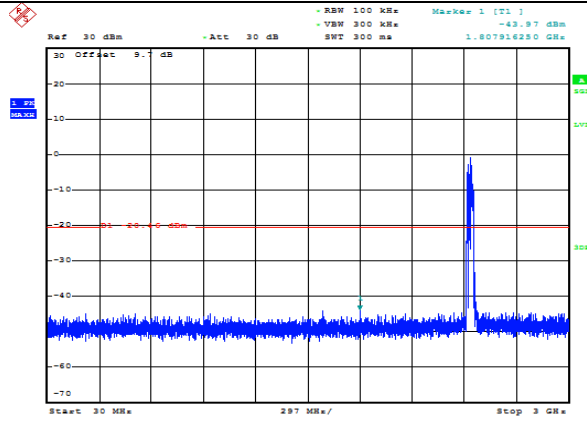

Date: 6.APR.2017 16:51:11

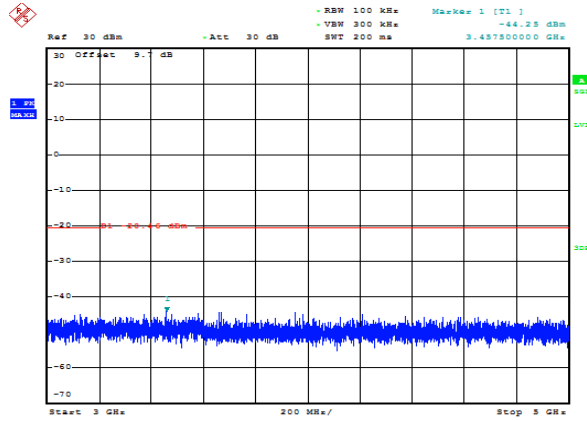

Date: 6.APR.2017 16:51:17

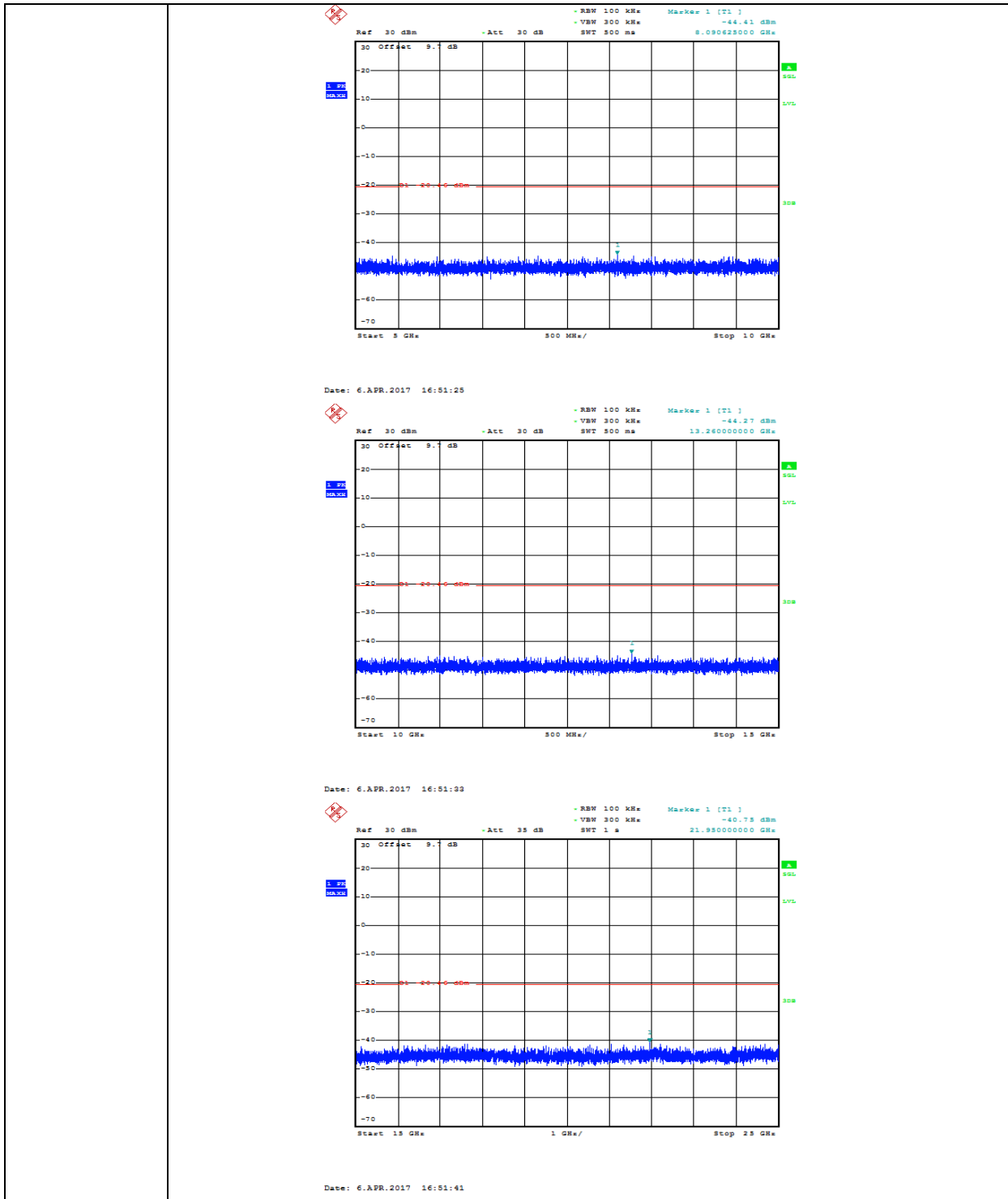

11N40SISO_HCH_Graphs

Pref/11N40SI
SO/HCH

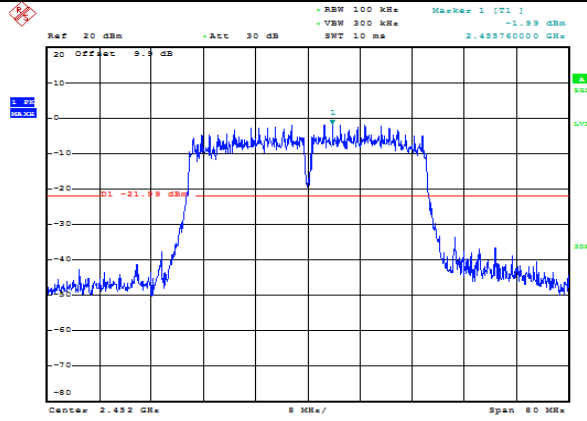

Date: 6.APR.2017 16:50:50

Puw/11N40S
ISO/HCH

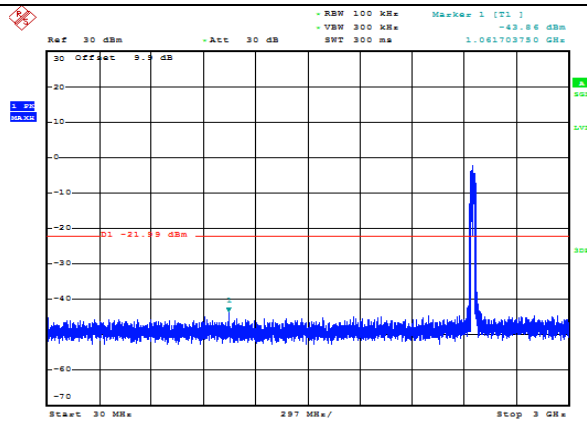

Date: 6.APR.2017 16:50:57

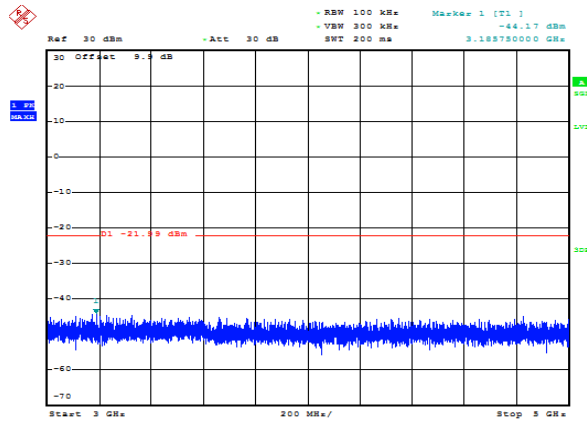

Date: 6.APR.2017 16:54:09



7. Radiated Spurious Emissions

7.1. Block diagram of test setup

In 3m Anechoic Chamber Test Setup Diagram for 9KHz-30MHz

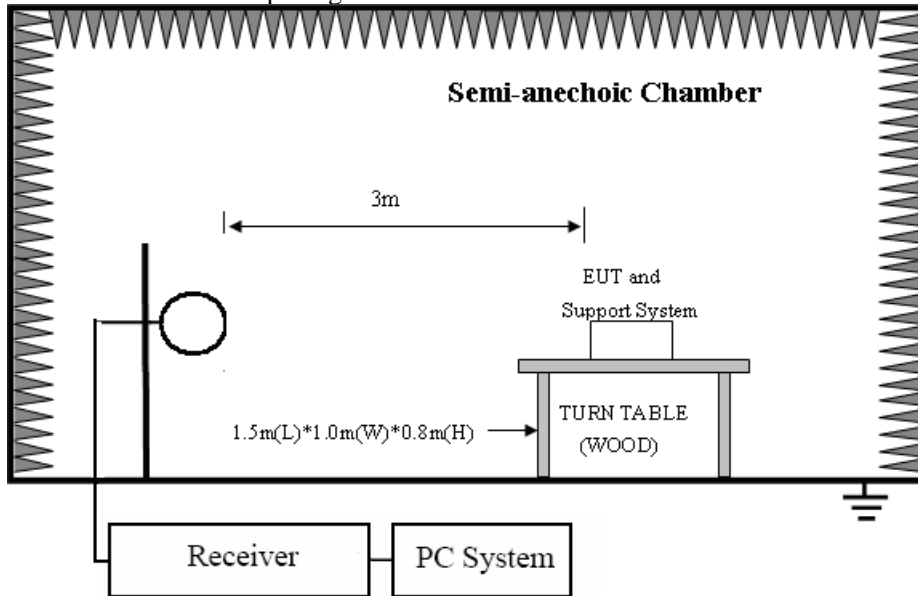

In 3m Anechoic Chamber Test Setup Diagram for 30MHz-1GHz

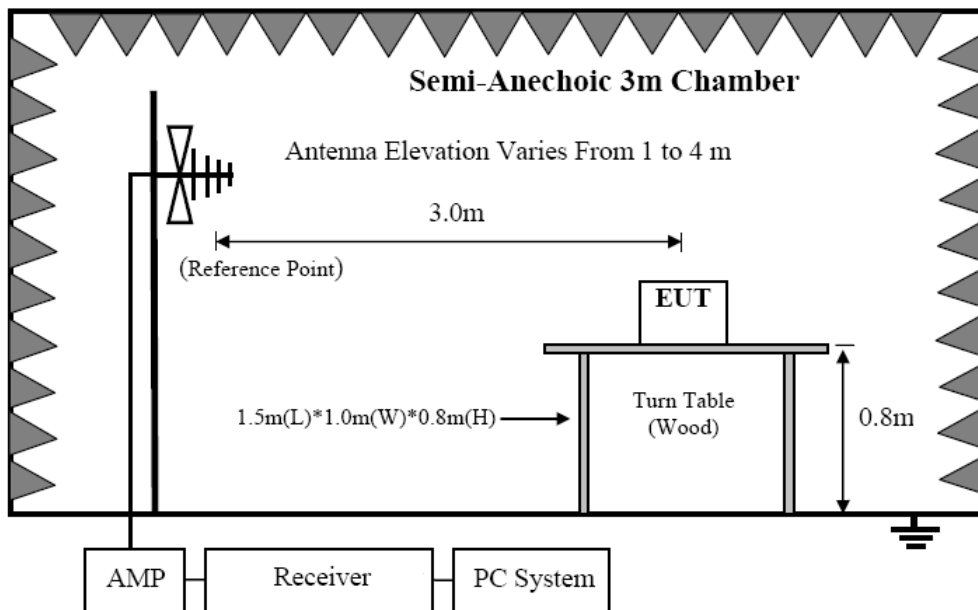

In 3m Anechoic Chamber Test Setup Diagram for frequency above 1GHz

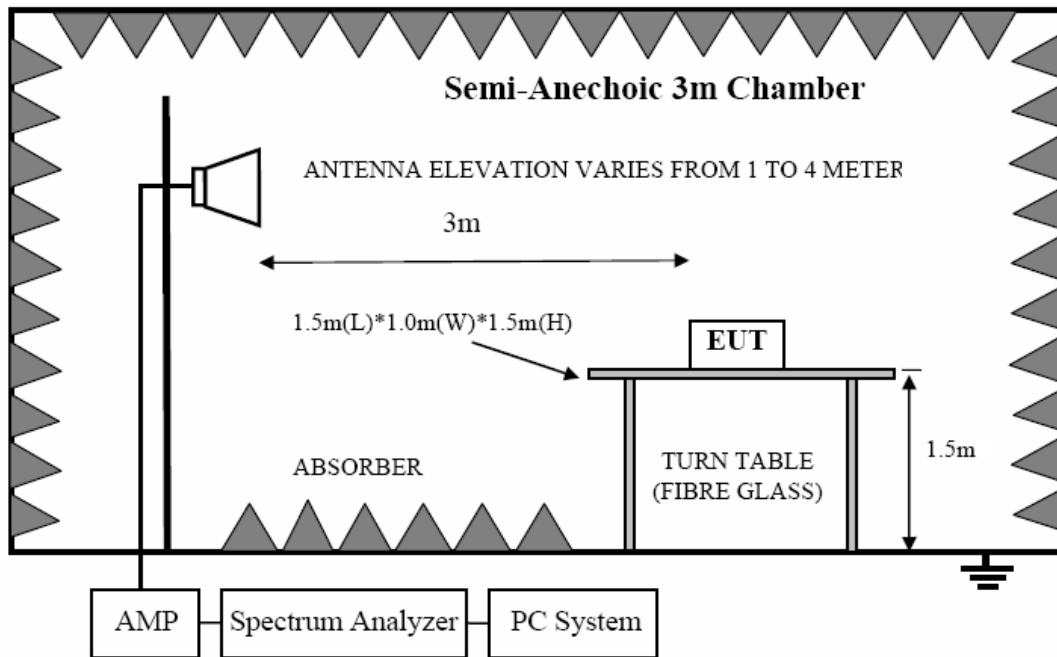

Note: For harmonic emissions test a appropriate high pass filter was inserted in the input port of AMP.

7.2. Limit

8.2.1 FCC 15.205 Restricted frequency band

MHz	MHz	MHz	GHz
0.090 - 0.110	16.42 - 16.423	399.9 - 410	4.5 - 5.15
¹ 0.495 - 0.505	16.69475 - 16.69525	608 - 614	5.35 - 5.46
2.1735 - 2.1905	16.80425 - 16.80475	960 - 1240	7.25 - 7.75
4.125 - 4.128	25.5 - 25.67	1300 - 1427	8.025 - 8.5
4.17725 - 4.17775	37.5 - 38.25	1435 - 1626.5	9.0 - 9.2
4.20725 - 4.20775	73 - 74.6	1645.5 - 1646.5	9.3 - 9.5
6.215 - 6.218	74.8 - 75.2	1660 - 1710	10.6 - 12.7
6.26775 - 6.26825	108 - 121.94	1718.8 - 1722.2	13.25 - 13.4
6.31175 - 6.31225	123 - 138	2200 - 2300	14.47 - 14.5
8.291 - 8.294	149.9 - 150.05	2310 - 2390	15.35 - 16.2
8.362 - 8.366	156.52475 - 156.52525	2483.5 - 2500	17.7 - 21.4
8.37625 - 8.38675	156.7 - 156.9	2690 - 2900	22.01 - 23.12
8.41425 - 8.41475	162.0125 - 167.17	3260 - 3267	23.6 - 24.0
12.29 - 12.293	167.72 - 173.2	3332 - 3339	31.2 - 31.8
12.51975 - 12.52025	240 - 285	3345.8 - 3358	36.43 - 36.5
12.57675 - 12.57725	322 - 335.4	3600 - 4400	(²)

8.2.2 FCC 15.209 Limit.

FREQUENCY MHz	DISTANCE Meters	FIELD STRENGTHS LIMIT	
		μV/m	dB(μV)/m
0.009 ~ 0.490	300	2400/F(KHz)	67.6-20log(F)
0.490 ~ 1.705	30	24000/F(KHz)	87.6-20log(F)
1.705 ~ 30.0	30	30	29.54
30 ~ 88	3	100	40.0
88 ~ 216	3	150	43.5

216 ~ 960	3	200	46.0
960 ~ 1000	3	500	54.0
Above 1000	3	74.0 dB(μ V)/m (Peak) 54.0 dB(μ V)/m (Average)	

Note: (1)The emission limits shown in the above table are based on measurements employing a CISPR QP detector except for the frequency bands 9-90KHz, 110-490KHz and above 1000MHz.Radiated emissions limits in these three bands are based on measurements employing an average detector.

(2) At frequencies below 30MHz, measurement may be performed at a distance closer then that specified, and the limit at closer measurement distance can be extrapolated by below formula:

$$\text{Limit}_{3m}(\text{dBuV/m}) = \text{Limit}_{30m}(\text{dBuV/m}) + 40\text{Log}(30m/3m)$$

8.2.3 Limit for this EUT

All the emissions appearing within 15.205 restricted frequency bands shall not exceed the limits shown in 15.209, all the other emissions shall be at least 20dB below the fundamental emissions, or comply with 15.209 limits.

7.3. Test Procedure

(1) EUT height should be 0.8m for below 1GHz at a semi - anechoic chamber while EUT height should be 1.5m for above 1GHz at full chamber or semi - anechoic chamber ground with absorbers.

(2) The antenna used as below table.

Test frequency range	Test antenna used	Measuring distance
9KHz-30MHz	Active Loop antenna	3 m
30MHz-1GHz	Trilog Broadband Antenna	3 m
1GHz-18GHz	Double Ridged Horn Antenna(1GHz-18GHz)	3 m
18GHz-40GHz	Horn Antenna(18GHz-40GHz)	1 m

According ANSI C63.10:2013 clause 6.4.4.2 and 6.5.3, for measurements below 30 MHz, the loop antenna was positioned with its plane vertical from the EUT and rotated about its vertical axis for maximum response at each azimuth position around the EUT. And the loop antenna also be positioned with its plane horizontal at the specified distance from the EUT. The center of the loop is 1 m above the ground. for measurement above 30MHz, the Trilog Broadband Antenna or Horn Antenna was located 3m from EUT, Measurements were made with the antenna positioned in both the horizontal and vertical planes of Polarization, and the measurement antenna was varied from 1 m to 4 m. in height above the reference ground plane to obtain the maximum signal strength.

(3) Below pre-scan procedure was first performed in order to find prominent frequency spectrum radiated emissions from 9KHz to 25GHz:

(a) Scanning the peak frequency spectrum with the antenna specified in step (3), and the EUT was rotated 360 degree, the antenna height was varied from 1m to 4m(Except loop antenna, it's fixed 1m above ground.)

- (b) Change work frequency or channel of device if practicable.
- (c) Change modulation type of device if practicable.
- (d) Change power supply range from 85% to 115% of the rated supply voltage
- (e) Rotated EUT though three orthogonal axes to determine the attitude of EUT arrangement produces highest emissions.

Spectrum frequency from 9KHz to 25GHz (tenth harmonic of fundamental frequency) was investigated, and no any obvious emission were detected from 18GHz to 25GHz, so below final test was performed with frequency range from 9KHz to 18GHz.

- (4) For final emissions measurements at each frequency of interest, the EUT was rotated and the antenna height was varied between 1m and 4m in order to maximize the emission. Measurements in both horizontal and vertical polarities were made and the data was recorded. In order to find the maximum emission, the relative positions of equipments and all of the interface cables were changed according to ANSI C63.10 2013 on Radiated Emission test.
- (5) The emissions from 9KHz to 1GHz were measured based on CISPR QP detector except for the frequency bands 9-90KHz, 110-490KHz, for emissions from 9KHz-90KHz,110KHz-490KHz and above 1GHz were measured based on average detector, for emissions above 1GHz, peak emissions also be measured and need comply with Peak limit.
- (6) The emissions from 9KHz to 1GHz, QP or average values were measured with EMI receiver with below RBW

Frequency band	RBW
9KHz-150KHz	200Hz
150KHz-30MHz	9KHz
30MHz-1GHz	120KHz

- (7) For emissions above 1GHz, both Peak and Average level were measured with Spectrum Analyzer, and the RBW is set at 1MHz, VBW is set at 3MHz for Peak measure; RMS detector RBW 1MHz VBW 3MHz for Average measure(according ANSI C63.10:2013 clause 4.2.3.2.3 procedure for average measure).

7.4. Test result

PASS. (See below detailed test result)

All the emissions except fundamental emission from 9KHz to 25GHz were comply with 15.209 limit.

Note1: According exploratory test no any obvious emission were detected from 9kHz to 30MHz and 18GHz to 25GHz, so the final test was performed with frequency range from 30MHz to 18GHz and recorded in below.

Note2: For emissions below 1GHz, according exploratory explorer test, when change Tx mode and channel, have no distinct influence on emissions level, so for emissions below 1GHz, the final test was only performed with EUT working in 11b, Tx CH6 mode.

Radiated Emission test (below 1GHz)

TR-4-E-009 Radiated Emission Test Result

Test Site	: DDT 3m Chamber	D:\2017 RE1# Report Data\17Q00116-9\RE.EM6
Test Date	: 2017-03-09	Tested By : Jerry
EUT	: Koogeek Lightbulb LB1	Model Number : LB1
Power Supply	: AC 120V/60Hz	Test Mode : Lighting(100%)
Condition	: Temp:24.5°C,Humi:55%, Press:100.1kPa	Antenna/Distance : 2016 VULB9163 1#/3m/VERTICAL
Memo	:	

Data: 5

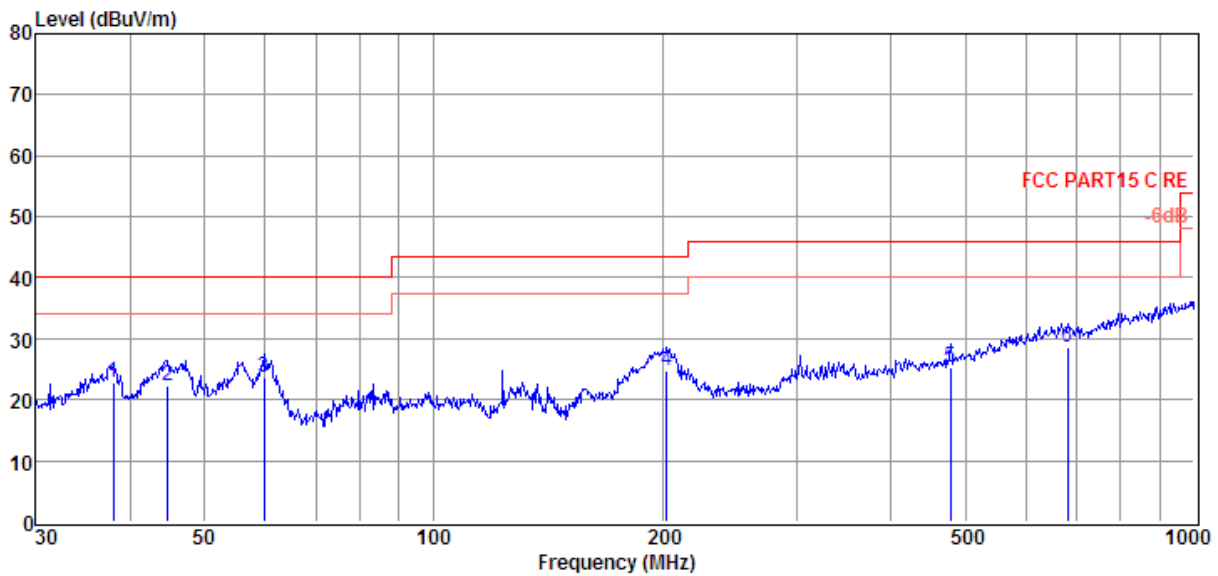

Item (Mark)	Freq. (MHz)	Read Level (dBμV)	Antenna Factor (dB/m)	Cable Loss (dB)	Result Level (dBμV/m)	Limit Line (dBμV/m)	Over Limit (dB)	Detector	Polarization
1	37.95	7.08	12.10	3.77	22.95	40.00	-17.05	QP	VERTICAL
2	44.74	6.22	12.32	3.84	22.38	40.00	-17.62	QP	VERTICAL
3	59.86	7.94	11.70	3.98	23.62	40.00	-16.38	QP	VERTICAL
4	202.81	9.33	10.47	4.91	24.71	43.50	-18.79	QP	VERTICAL
5	478.85	2.06	17.04	6.09	25.19	46.00	-20.81	QP	VERTICAL
6	682.35	1.90	19.88	6.77	28.55	46.00	-17.45	QP	VERTICAL

- Note: 1. Result Level = Read Level + Antenna Factor + Cable loss.
 2. If Peak Result complies with QP limit, QP Result is deemed to comply with QP limit.
 3. Test setup: RBW: 120 kHz, VBW: 300 kHz, Sweep time: auto.

TR-4-E-009 Radiated Emission Test Result

Test Site : DDT 3m Chamber D:\2017 RE1# Report Data\17Q00116-9\RE.EM6
Test Date : 2017-03-09 **Tested By** : Jerry
EUT : Koogeek Lightbulb LB1 **Model Number** : LB1
Power Supply : AC 120V/60Hz **Test Mode** : Lighting(100%)
Condition : Temp:24.5°C,Humi:55%,
Antenna/Distance : 2016 VULB9163 1#/3m/HORIZONTAL
 Press:100.1kPa
Memo :

Data: 6

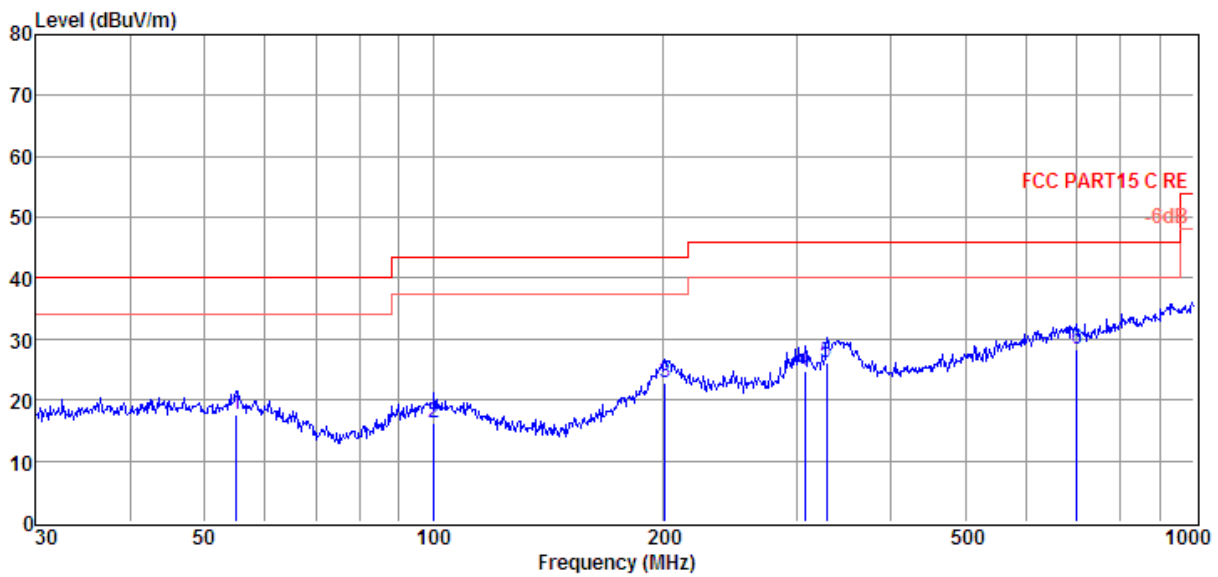

Item (Mark)	Freq. (MHz)	Read Level (dBµV)	Antenna Factor (dB/m)	Cable Loss (dB)	Result Level (dBµV/m)	Limit Line (dBµV/m)	Over Limit (dB)	Detector	Polarization
1	55.03	1.91	11.65	3.93	17.49	40.00	-22.51	QP	HORIZONTAL
2	100.23	0.02	11.98	4.30	16.30	43.50	-27.20	QP	HORIZONTAL
3	201.39	7.48	10.38	4.90	22.76	43.50	-20.74	QP	HORIZONTAL
4	307.83	5.84	13.56	5.41	24.81	46.00	-21.19	QP	HORIZONTAL
5	329.04	6.77	13.88	5.50	26.15	46.00	-19.85	QP	HORIZONTAL
6	701.76	1.72	19.86	6.84	28.42	46.00	-17.58	QP	HORIZONTAL

- Note: 1. Result Level = Read Level + Antenna Factor + Cable loss.
 2. If Peak Result complies with QP limit, QP Result is deemed to comply with QP limit.
 3. Test setup: RBW: 120 kHz, VBW: 300 kHz, Sweep time: auto.

Radiated Emission test (above 1GHz)

Freq (MHz)	Read level (dB μ V)	Antenna Factor (dB/m)	PRM Factor (dB)	Cable Loss (dB)	Result Level (dB μ V/m)	Limit (dB μ V/m)	Margin (dB)	Detector type	Polarization
11b CH1									
1570.26	42.77	26.00	29.10	5.00	44.67	74.00	-29.33	Peak	VERTICAL
2036.37	41.51	28.27	29.01	5.56	46.33	74.00	-27.67	Peak	VERTICAL
2425.03	41.80	29.91	29.50	6.06	48.27	74.00	-25.73	Peak	VERTICAL
3474.97	39.03	31.89	29.59	7.28	48.61	74.00	-25.39	Peak	VERTICAL
4190.15	37.64	33.56	29.08	7.83	49.95	74.00	-24.05	Peak	VERTICAL
6324.71	36.38	35.53	29.51	9.85	52.25	74.00	-21.75	Peak	VERTICAL
1525.20	42.50	25.74	29.12	4.94	44.06	74.00	-29.94	Peak	HORIZONTAL
2032.14	41.60	28.25	29.01	5.53	46.37	74.00	-27.63	Peak	HORIZONTAL
2419.99	42.13	29.89	29.50	6.06	48.58	74.00	-25.42	Peak	HORIZONTAL
3105.88	39.15	31.74	30.13	6.88	47.64	74.00	-26.36	Peak	HORIZONTAL
3994.46	37.16	33.38	29.05	7.61	49.10	74.00	-24.90	Peak	HORIZONTAL
6285.38	36.19	35.46	29.46	9.83	52.02	74.00	-21.98	Peak	HORIZONTAL
11b CH6									
1534.75	42.22	25.80	29.11	4.96	43.87	74.00	-30.13	Peak	VERTICAL
2049.11	41.65	28.33	29.02	5.56	46.52	74.00	-27.48	Peak	VERTICAL
2445.28	41.33	29.99	29.57	6.08	47.83	74.00	-26.17	Peak	VERTICAL
3920.40	38.06	33.17	29.08	7.55	49.70	74.00	-24.30	Peak	VERTICAL
5513.62	35.12	34.71	29.26	9.20	49.77	74.00	-24.23	Peak	VERTICAL
7255.12	36.94	36.41	30.54	10.65	53.46	74.00	-20.54	Peak	VERTICAL
1573.53	42.65	26.02	29.09	5.00	44.58	74.00	-29.42	Peak	HORIZONTAL
2049.11	41.56	28.33	29.02	5.56	46.43	74.00	-27.57	Peak	HORIZONTAL
2445.28	42.65	29.99	29.57	6.08	49.15	74.00	-24.85	Peak	HORIZONTAL
3312.68	39.43	31.83	29.93	7.11	48.44	74.00	-25.56	Peak	HORIZONTAL
4678.35	37.09	33.76	29.29	8.35	49.91	74.00	-24.09	Peak	HORIZONTAL
7346.21	36.83	36.48	30.61	10.72	53.42	74.00	-20.58	Peak	HORIZONTAL
11b CH11									
1557.25	42.66	25.93	29.10	4.98	44.47	74.00	-29.53	Peak	VERTICAL
2040.61	42.83	28.29	29.02	5.56	47.66	74.00	-26.34	Peak	VERTICAL
2414.96	42.77	29.87	29.48	6.06	49.22	74.00	-24.78	Peak	VERTICAL
3105.88	39.75	31.74	30.13	6.88	48.24	74.00	-25.76	Peak	VERTICAL
4368.08	37.54	33.70	29.14	8.00	50.10	74.00	-23.90	Peak	VERTICAL
5807.83	37.06	34.89	29.21	9.50	52.24	74.00	-21.76	Peak	VERTICAL
2036.37	42.95	28.27	29.01	5.56	47.77	74.00	-26.23	Peak	HORIZONTAL
2425.03	42.14	29.91	29.50	6.06	48.61	74.00	-25.39	Peak	HORIZONTAL
3361.26	39.42	31.85	29.86	7.15	48.56	74.00	-25.44	Peak	HORIZONTAL
4856.78	37.56	33.73	29.33	8.54	50.50	74.00	-23.50	Peak	HORIZONTAL
6233.32	37.72	35.38	29.40	9.80	53.50	74.00	-20.50	Peak	HORIZONTAL

Note: 1.30MHz~25GHz: (Scan with 11b mode, 11g mode, 11n HT20 mode, and 11n HT40 mode, the worst case is 11b mode)

2. Result Level = Read Level + Antenna Factor + Cable loss - PRM Factor.

3. Test setup: RBW: 1 MHz, VBW: 3 MHz, Sweep time: auto.

8. Radiated Band Edge Compliance

8.1. Block diagram of test setup

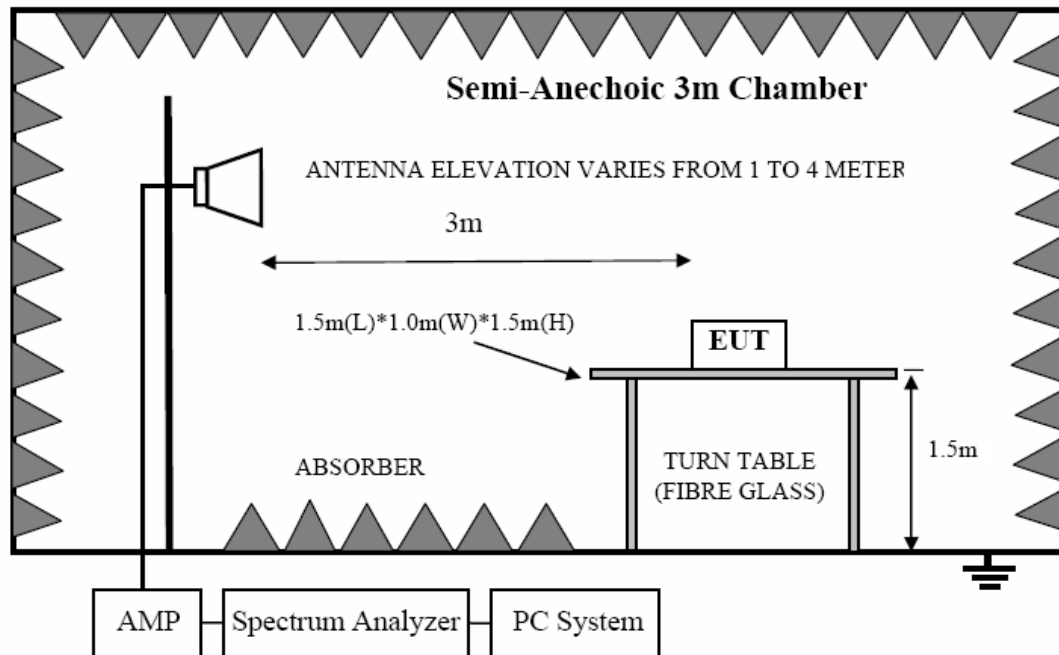

8.2. Limit

All restricted frequency bands shall not exceed the limits shown in 15.209, all the other emissions outside operation frequency band 2400MHz to 2483.5MHz shall be at least 20dB below the fundamental emissions, or comply with RSS-Gen Issue 3 clause 7.2.5 (Same as FCC 15.209) limits.

8.3. Test Procedure

Same with clause 8.3 except change investigated frequency range from 2100MHz to 2450MHz and 2450MHz to 2500MHz.

Remark: All restriction band have been tested, and only the worse case is shown in report.

8.4. Test result

PASS. (See below detailed test result)

TR-4-E-009 Radiated Emission Test Result

Test Site : DDT 3m Chamber	D:\2017 RE1# Report Data\17Q0116-9\RF.EM6
Test Date : 2017-04-08	Tested By : Jerry
EUT : Koogeek Lightbulb LB1	Model Number : LB1
Power Supply : AC 120V/60Hz	Test Mode : 11b CH1
Condition : Temp:24.5°C,Humi:55%, Press:100.1kPa	Antenna/Distance : 2016 HF907/3m/HORIZONTAL
Memo :	

Data: 39

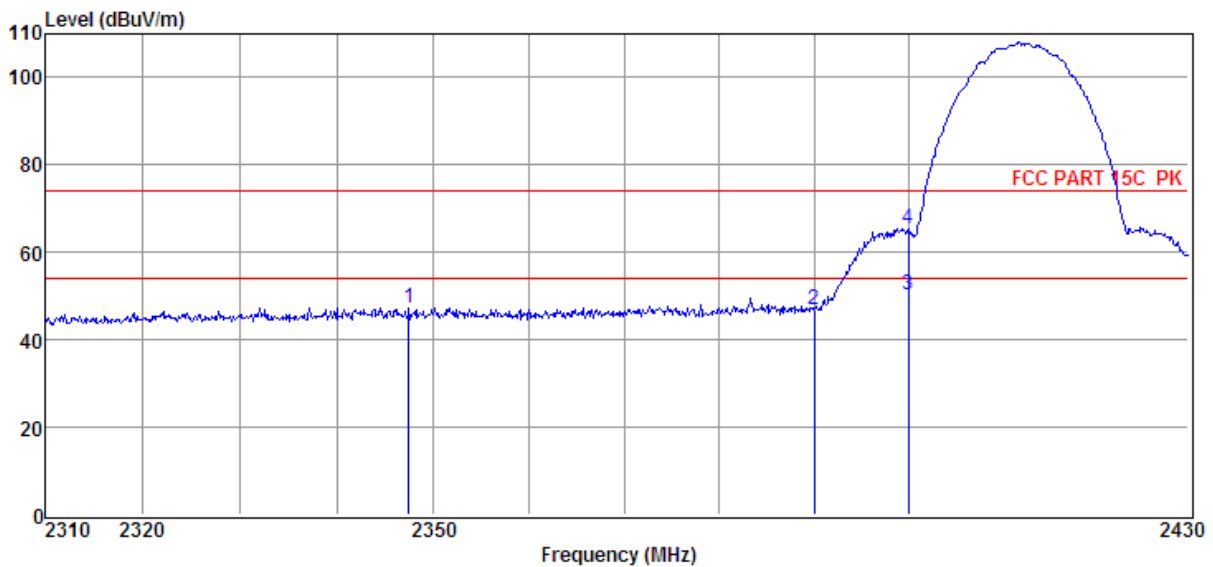

Item (Mark)	Freq. (MHz)	Read Level (dBμV)	Antenna Factor (dB/m)	PRM Factor dB	Cable Loss dB	Result Level (dBμV/m)	Limit Line (dBμV/m)	Over Limit (dB)	Detector	Polarization
1	2347.50	41.13	29.61	29.33	5.96	47.37	74.00	-26.63	Peak	HORIZONTAL
2	2390.00	40.37	29.78	29.41	6.01	46.75	74.00	-27.25	Peak	HORIZONTAL
3	2400.00	44.03	29.82	29.44	6.03	50.44	54.00	-3.56	Average	HORIZONTAL
4	2400.00	59.13	29.82	29.44	6.03	65.54	74.00	-8.46	Peak	HORIZONTAL

Note: 1. Result Level = Read Level + Antenna Factor + Cable loss - PRM Factor.
 2. If Peak Result complies with AV limit, AV Result is deemed to comply with AV limit.
 3. Test setup: RBW: 1 MHz, VBW: 3 MHz, Sweep time: auto.

TR-4-E-009 Radiated Emission Test Result

Test Site : DDT 3m Chamber D:\2017 RE1# Report Data\17Q0116-9\RF.EM6
Test Date : 2017-04-08 **Tested By** : Jerry
EUT : Koogeek Lightbulb LB1 **Model Number** : LB1
Power Supply : AC 120V/60Hz **Test Mode** : 11b CH1
Condition : Temp:24.5°C,Humi:55%,
 Press:100.1kPa **Antenna/Distance** : 2016 HF907/3m/VERTICAL
Memo :

Data: 40

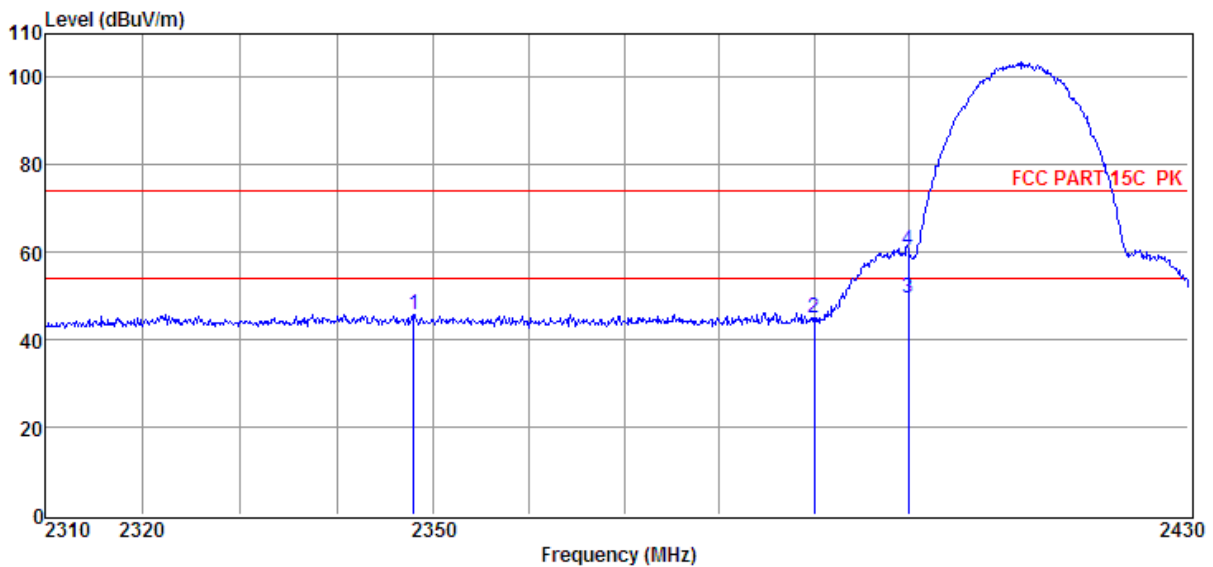

Item (Mark)	Freq. (MHz)	Read Level (dBμV)	Antenna Factor (dB/m)	PRM Factor (dB)	Cable Loss (dB)	Result Level (dBμV/m)	Limit Line (dBμV/m)	Over Limit (dB)	Detector	Polarization
1	2347.98	39.58	29.61	29.33	5.96	45.82	74.00	-28.18	Peak	VERTICAL
2	2390.00	38.67	29.78	29.41	6.01	45.05	74.00	-28.95	Peak	VERTICAL
3	2400.00	43.15	29.82	29.44	6.03	49.56	54.00	-4.44	Average	VERTICAL
4	2400.00	54.03	29.82	29.44	6.03	60.44	74.00	-13.56	Peak	VERTICAL

- Note: 1. Result Level = Read Level + Antenna Factor + Cable loss - PRM Factor.
 2. If Peak Result complies with AV limit, AV Result is deemed to comply with AV limit.
 3. Test setup: RBW: 1 MHz, VBW: 3 MHz, Sweep time: auto.

TR-4-E-009 Radiated Emission Test Result

Test Site : DDT 3m Chamber D:\2017 RE1# Report Data\17Q0116-9\RF.EM6
Test Date : 2017-04-08 **Tested By** : Jerry
EUT : Koogeek Lightbulb LB1 **Model Number** : LB1
Power Supply : AC 120V/60Hz **Test Mode** : 11b CH11
Condition : Temp:24.5°C,Humi:55%,
 Press:100.1kPa **Antenna/Distance** : 2016 HF907/3m/VERTICAL
Memo :

Data: 45

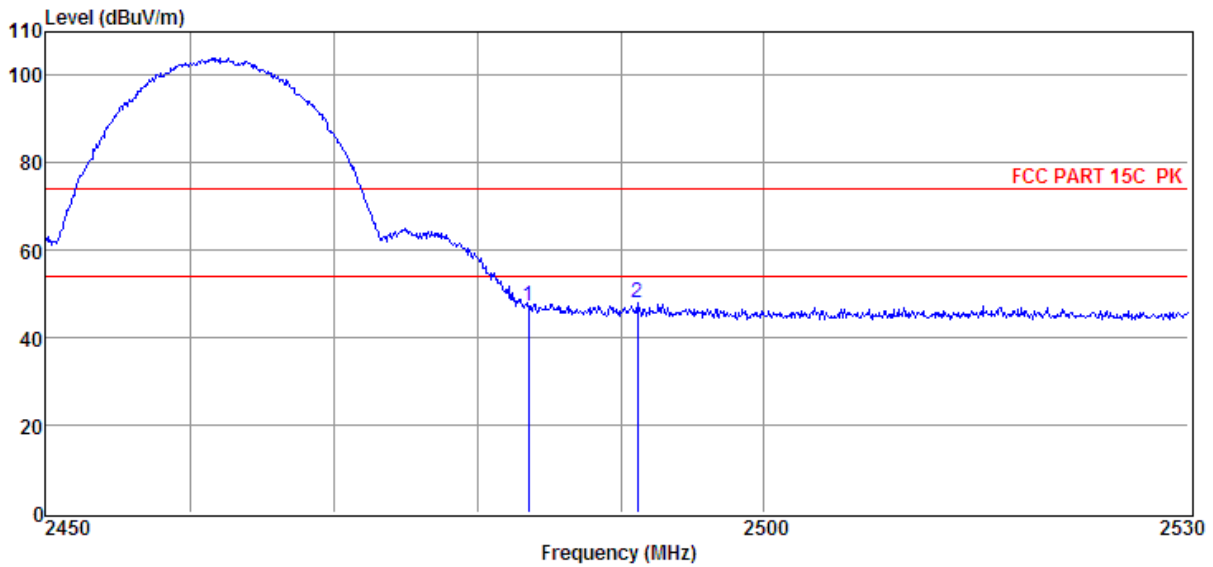

Item (Mark)	Freq. (MHz)	Read Level (dBμV)	Antenna Factor (dB/m)	PRM Factor dB	Cable Loss dB	Result Level (dBμV/m)	Limit Line (dBμV/m)	Over Limit (dB)	Detector	Polarization
1	2483.50	40.85	30.14	29.71	6.15	47.43	74.00	-26.57	Peak	VERTICAL
2	2491.12	41.42	30.17	29.73	6.15	48.01	74.00	-25.99	Peak	VERTICAL

- Note: 1. Result Level = Read Level + Antenna Factor + Cable loss - PRM Factor.
 2. If Peak Result complies with AV limit, AV Result is deemed to comply with AV limit.
 3. Test setup: RBW: 1 MHz, VBW: 3 MHz, Sweep time: auto.

TR-4-E-009 Radiated Emission Test Result

Test Site : DDT 3m Chamber D:\2017 RE1# Report Data\17Q0116-9\RF.EM6
Test Date : 2017-04-08 **Tested By** : Jerry
EUT : Koogeek Lightbulb LB1 **Model Number** : LB1
Power Supply : AC 120V/60Hz **Test Mode** : 11b CH11
Condition : Temp:24.5°C,Humi:55%,
 Press:100.1kPa **Antenna/Distance** : 2016 HF907/3m/HORIZONTAL
Memo :

Data: 46

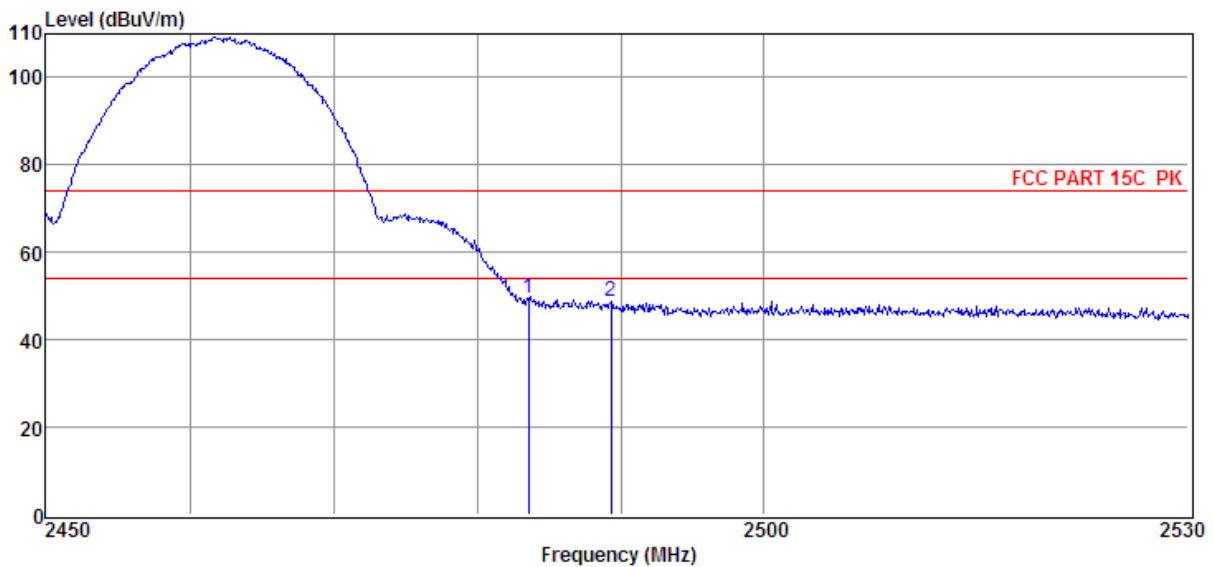

Item (Mark)	Freq. (MHz)	Read Level (dBμV)	Antenna Factor (dB/m)	PRM Factor dB	Cable Loss dB	Result Level (dBμV/m)	Limit Line (dBμV/m)	Over Limit (dB)	Detector	Polarization
1	2483.50	42.87	30.14	29.71	6.15	49.45	74.00	-24.55	Peak	HORIZONTAL
2	2489.28	42.37	30.16	29.73	6.15	48.95	74.00	-25.05	Peak	HORIZONTAL

Note: 1. Result Level = Read Level + Antenna Factor + Cable loss - PRM Factor.
 2. If Peak Result complies with AV limit, AV Result is deemed to comply with AV limit.
 3. Test setup: RBW: 1 MHz, VBW: 3 MHz, Sweep time: auto.

TR-4-E-009 Radiated Emission Test Result

Test Site : DDT 3m Chamber D:\2017 RE1# Report Data\17Q0116-9\RF.EM6
Test Date : 2017-04-08 **Tested By** : Jerry
EUT : Koogeek Lightbulb LB1 **Model Number** : LB1
Power Supply : AC 120V/60Hz **Test Mode** : 11g CH1
Condition : Temp:24.5°C,Humi:55%,
 Press:100.1kPa **Antenna/Distance** : 2016 HF907/3m/HORIZONTAL
Memo :

Data: 47

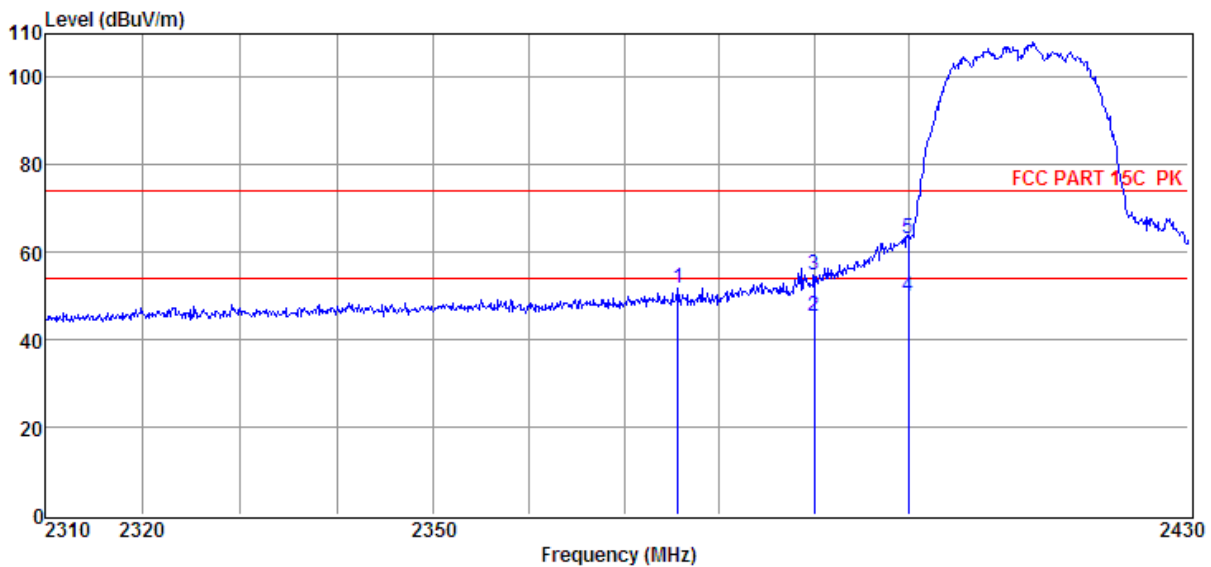

Item (Mark)	Freq. (MHz)	Read Level (dBμV)	Antenna Factor (dB/m)	PRM Factor (dB)	Cable Loss (dB)	Result Level (dBμV/m)	Limit Line (dBμV/m)	Over Limit (dB)	Detector	Polarization
1	2375.61	45.31	29.72	29.38	6.01	51.66	74.00	-22.34	Peak	HORIZONTAL
2	2390.00	39.15	29.78	29.41	6.01	45.53	54.00	-8.47	Average	HORIZONTAL
3	2390.00	48.35	29.78	29.41	6.01	54.73	74.00	-19.27	Peak	HORIZONTAL
4	2400.00	43.58	29.82	29.44	6.03	49.99	54.00	-4.01	Average	HORIZONTAL
5	2400.00	56.68	29.82	29.44	6.03	63.09	74.00	-10.91	Peak	HORIZONTAL

- Note: 1. Result Level = Read Level + Antenna Factor + Cable loss - PRM Factor.
 2. If Peak Result complies with AV limit, AV Result is deemed to comply with AV limit.
 3. Test setup: RBW: 1 MHz, VBW: 3 MHz, Sweep time: auto.

TR-4-E-009 Radiated Emission Test Result

Test Site : DDT 3m Chamber D:\2017 RE1# Report Data\17Q0116-9\RF.EM6
Test Date : 2017-04-08 **Tested By** : Jerry
EUT : Koogeek Lightbulb LB1 **Model Number** : LB1
Power Supply : AC 120V/60Hz **Test Mode** : 11g CH1
Condition : Temp:24.5°C,Humi:55%,
 Press:100.1kPa **Antenna/Distance** : 2016 HF907/3m/VERTICAL
Memo :

Data: 48

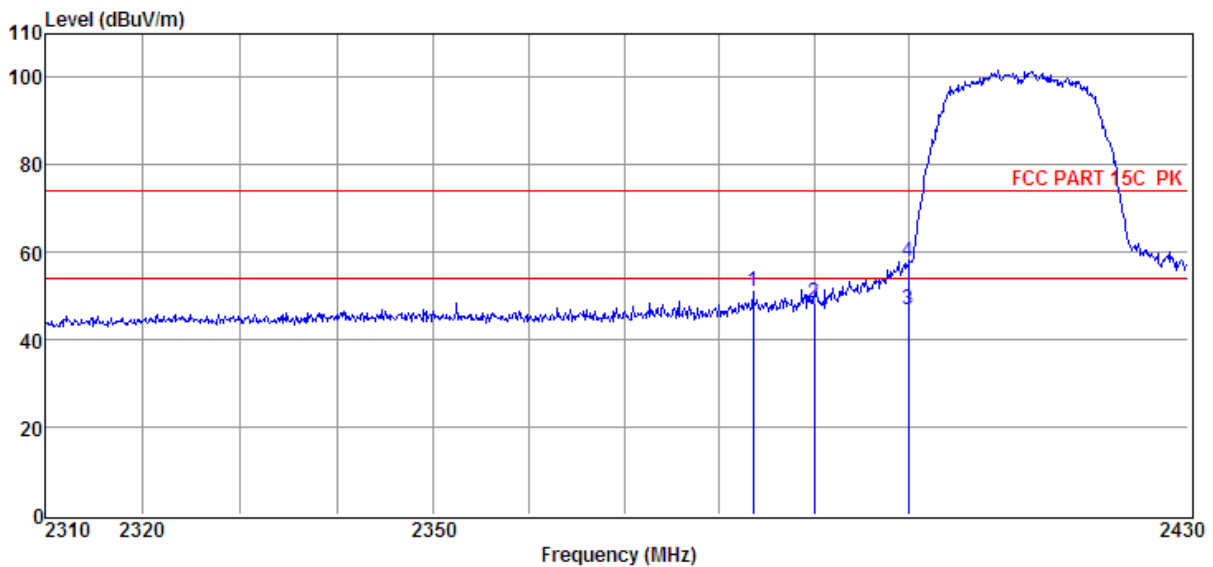

Item (Mark)	Freq. (MHz)	Read Level (dBμV)	Antenna Factor (dB/m)	PRM Factor (dB)	Cable Loss (dB)	Result Level (dBμV/m)	Limit Line (dBμV/m)	Over Limit (dB)	Detector	Polarization
1	2383.56	44.69	29.75	29.41	6.01	51.04	74.00	-22.96	Peak	VERTICAL
2	2390.00	41.87	29.78	29.41	6.01	48.25	74.00	-25.75	Peak	VERTICAL
3	2400.00	40.58	29.82	29.44	6.03	46.99	54.00	-7.01	Average	VERTICAL
4	2400.00	51.30	29.82	29.44	6.03	57.71	74.00	-16.29	Peak	VERTICAL

Note: 1. Result Level = Read Level + Antenna Factor + Cable loss - PRM Factor.
 2. If Peak Result complies with AV limit, AV Result is deemed to comply with AV limit.
 3. Test setup: RBW: 1 MHz, VBW: 3 MHz, Sweep time: auto.

TR-4-E-009 Radiated Emission Test Result

Test Site : DDT 3m Chamber D:\2017 RE1# Report Data\17Q0116-9\RF.EM6
Test Date : 2017-04-08 **Tested By** : Jerry
EUT : Koogeek Lightbulb LB1 **Model Number** : LB1
Power Supply : AC 120V/60Hz **Test Mode** : 11g CH11
Condition : Temp:24.5°C,Humi:55%,
 Press:100.1kPa **Antenna/Distance** : 2016 HF907/3m/VERTICAL
Memo :

Data: 49

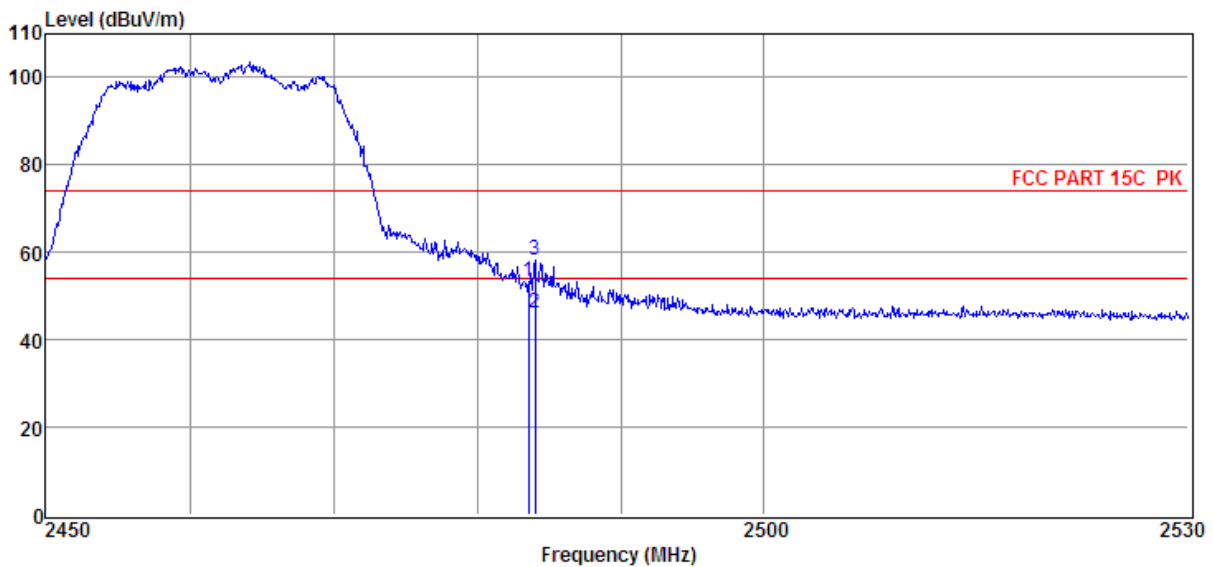

Item (Mark)	Freq. (MHz)	Read Level (dBμV)	Antenna Factor (dB/m)	PRM Factor (dB)	Cable Loss (dB)	Result Level (dBμV/m)	Limit Line (dBμV/m)	Over Limit (dB)	Detector	Polarization
1	2483.50	46.58	30.14	29.71	6.15	53.16	74.00	-20.84	Peak	VERTICAL
2	2483.93	39.64	30.14	29.71	6.15	46.22	54.00	-7.78	Average	VERTICAL
3	2483.93	51.69	30.14	29.71	6.15	58.27	74.00	-15.73	Peak	VERTICAL

Note: 1. Result Level = Read Level + Antenna Factor + Cable loss - PRM Factor.
 2. If Peak Result complies with AV limit, AV Result is deemed to comply with AV limit.
 3. Test setup: RBW: 1 MHz, VBW: 3 MHz, Sweep time: auto.

TR-4-E-009 Radiated Emission Test Result

Test Site : DDT 3m Chamber D:\2017 RE1# Report Data\17Q0116-9\RF.EM6
Test Date : 2017-04-08 **Tested By** : Jerry
EUT : Koogeek Lightbulb LB1 **Model Number** : LB1
Power Supply : AC 120V/60Hz **Test Mode** : 11g CH11
Condition : Temp:24.5°C,Humi:55%,
 Press:100.1kPa **Antenna/Distance** : 2016 HF907/3m/HORIZONTAL
Memo :

Data: 50

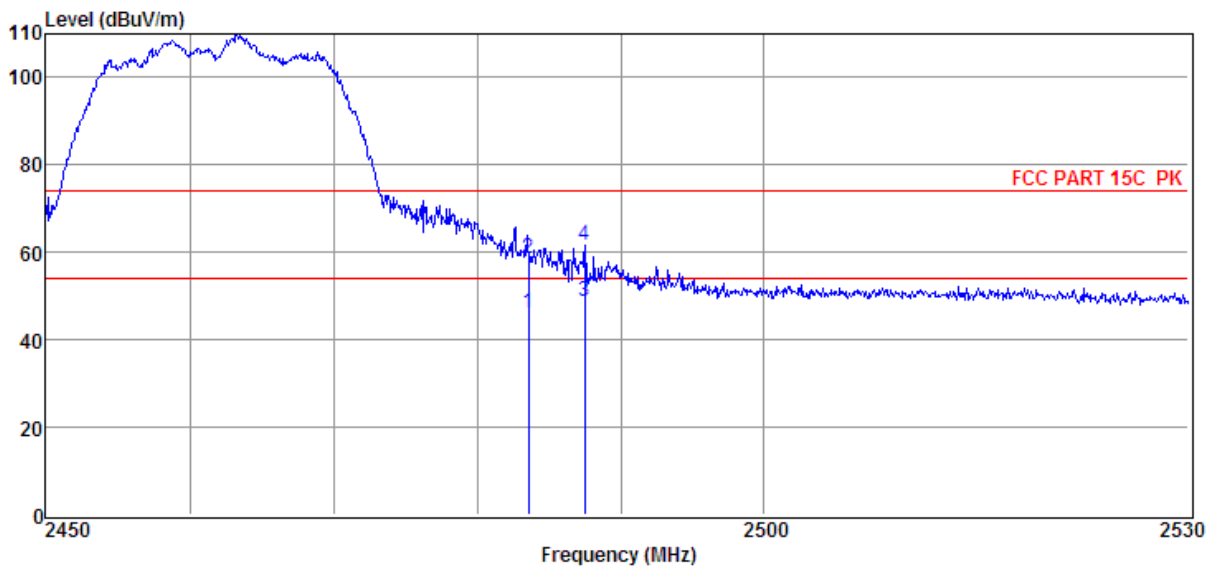

Item (Mark)	Freq. (MHz)	Read Level (dBμV)	Antenna Factor (dB/m)	PRM Factor (dB)	Cable Loss (dB)	Result Level (dBμV/m)	Limit Line (dBμV/m)	Over Limit (dB)	Detector	Polarization
1	2483.50	39.64	30.14	29.71	6.15	46.22	54.00	-7.78	Average	HORIZONTAL
2	2483.50	51.94	30.14	29.71	6.15	58.52	74.00	-15.48	Peak	HORIZONTAL
3	2487.44	42.24	30.15	29.71	6.15	48.83	54.00	-5.17	Average	HORIZONTAL
4	2487.44	54.98	30.15	29.71	6.15	61.57	74.00	-12.43	Peak	HORIZONTAL

- Note: 1. Result Level = Read Level + Antenna Factor + Cable loss - PRM Factor.
 2. If Peak Result complies with AV limit, AV Result is deemed to comply with AV limit.
 3. Test setup: RBW: 1 MHz, VBW: 3 MHz, Sweep time: auto.

TR-4-E-009 Radiated Emission Test Result

Test Site : DDT 3m Chamber D:\2017 RE1# Report Data\17Q0116-9\RF.EM6
Test Date : 2017-04-08 **Tested By** : Jerry
EUT : Koogeek Lightbulb LB1 **Model Number** : LB1
Power Supply : AC 120V/60Hz **Test Mode** : 11HT20 CH1
Condition : Temp:24.5°C,Humi:55%,
 Press:100.1kPa **Antenna/Distance** : 2016 HF907/3m/HORIZONTAL
Memo :

Data: 51

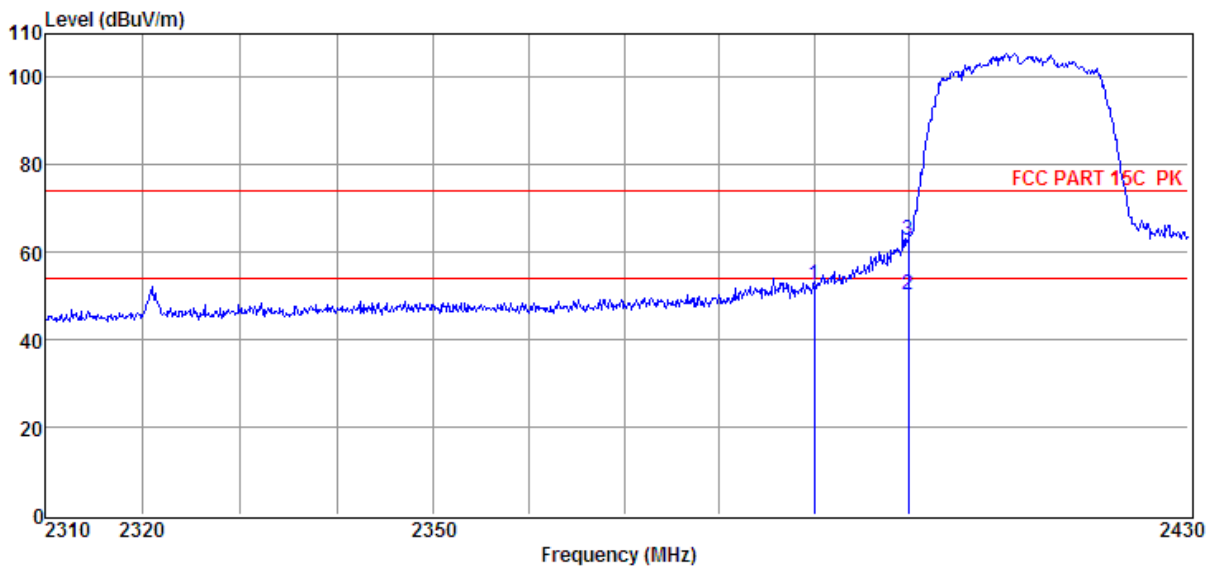

Item (Mark)	Freq. (MHz)	Read Level (dBμV)	Antenna Factor (dB/m)	PRM Factor (dB)	Cable Loss (dB)	Result Level (dBμV/m)	Limit Line (dBμV/m)	Over Limit (dB)	Detector	Polarization
1	2390.00	46.30	29.78	29.41	6.01	52.68	74.00	-21.32	Peak	HORIZONTAL
2	2400.00	43.69	29.82	29.44	6.03	50.10	54.00	-3.90	Average	HORIZONTAL
3	2400.00	56.48	29.82	29.44	6.03	62.89	74.00	-11.11	Peak	HORIZONTAL

- Note: 1. Result Level = Read Level + Antenna Factor + Cable loss - PRM Factor.
 2. If Peak Result complies with AV limit, AV Result is deemed to comply with AV limit.
 3. Test setup: RBW: 1 MHz, VBW: 3 MHz, Sweep time: auto.

TR-4-E-009 Radiated Emission Test Result

Test Site : DDT 3m Chamber D:\2017 RE1# Report Data\17Q0116-9\RF.EM6
Test Date : 2017-04-08 **Tested By** : Jerry
EUT : Koogeek Lightbulb LB1 **Model Number** : LB1
Power Supply : AC 120V/60Hz **Test Mode** : 11HT20 CH1
Condition : Temp:24.5°C,Humi:55%,
 Press:100.1kPa **Antenna/Distance** : 2016 HF907/3m/VERTICAL
Memo :

Data: 52

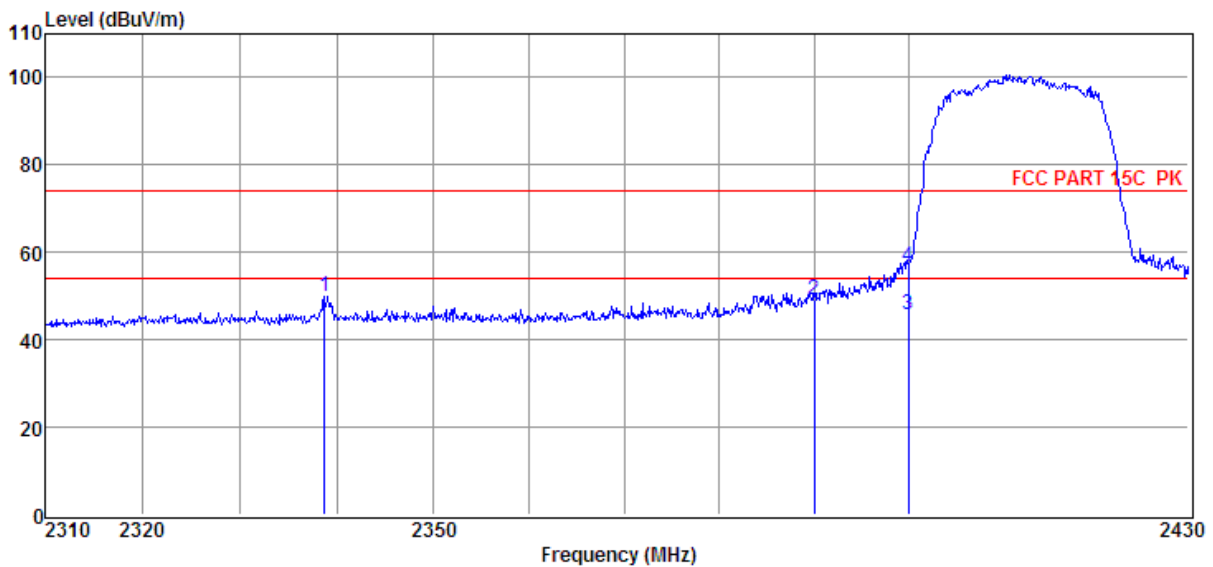

Item (Mark)	Freq. (MHz)	Read Level (dBμV)	Antenna Factor (dB/m)	PRM Factor (dB)	Cable Loss (dB)	Result Level (dBμV/m)	Limit Line (dBμV/m)	Over Limit (dB)	Detector	Polarization
1	2338.72	43.85	29.57	29.32	5.94	50.04	74.00	-23.96	Peak	VERTICAL
2	2390.00	42.80	29.78	29.41	6.01	49.18	74.00	-24.82	Peak	VERTICAL
3	2400.00	39.29	29.82	29.44	6.03	45.70	54.00	-8.30	Average	VERTICAL
4	2400.00	50.47	29.82	29.44	6.03	56.88	74.00	-17.12	Peak	VERTICAL

Note: 1. Result Level = Read Level + Antenna Factor + Cable loss - PRM Factor.
 2. If Peak Result complies with AV limit, AV Result is deemed to comply with AV limit.
 3. Test setup: RBW: 1 MHz, VBW: 3 MHz, Sweep time: auto.

TR-4-E-009 Radiated Emission Test Result

Test Site : DDT 3m Chamber D:\2017 RE1# Report Data\17Q0116-9\RF.EM6
Test Date : 2017-04-08 **Tested By** : Jerry
EUT : Koogeek Lightbulb LB1 **Model Number** : LB1
Power Supply : AC 120V/60Hz **Test Mode** : 11HT20 CH11
Condition : Temp:24.5°C,Humi:55%,
 Press:100.1kPa **Antenna/Distance** : 2016 HF907/3m/VERTICAL
Memo :

Data: 53

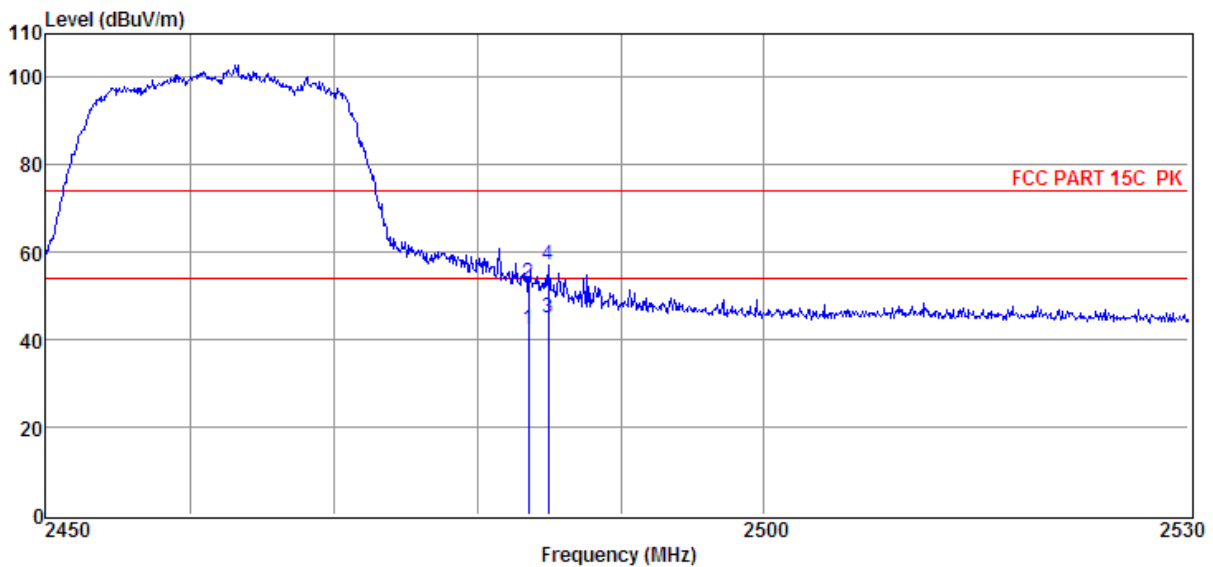

Item (Mark)	Freq. (MHz)	Read Level (dBμV)	Antenna Factor (dB/m)	PRM Factor (dB)	Cable Loss (dB)	Result Level (dBμV/m)	Limit Line (dBμV/m)	Over Limit (dB)	Detector	Polarization
1	2483.50	35.91	30.14	29.71	6.15	42.49	54.00	-11.51	Average	VERTICAL
2	2483.50	46.46	30.14	29.71	6.15	53.04	74.00	-20.96	Peak	VERTICAL
3	2484.88	38.49	30.14	29.71	6.15	45.07	54.00	-8.93	Average	VERTICAL
4	2484.88	50.32	30.14	29.71	6.15	56.90	74.00	-17.10	Peak	VERTICAL

Note: 1. Result Level = Read Level + Antenna Factor + Cable loss - PRM Factor.
 2. If Peak Result complies with AV limit, AV Result is deemed to comply with AV limit.
 3. Test setup: RBW: 1 MHz, VBW: 3 MHz, Sweep time: auto.

TR-4-E-009 Radiated Emission Test Result

Test Site : DDT 3m Chamber D:\2017 RE1# Report Data\17Q0116-9\RF.EM6
Test Date : 2017-04-08 **Tested By** : Jerry
EUT : Koogeek Lightbulb LB1 **Model Number** : LB1
Power Supply : AC 120V/60Hz **Test Mode** : 11HT20 CH11
Condition : Temp:24.5°C,Humi:55%,
 Press:100.1kPa **Antenna/Distance** : 2016 HF907/3m/HORIZONTAL
Memo :

Data: 54

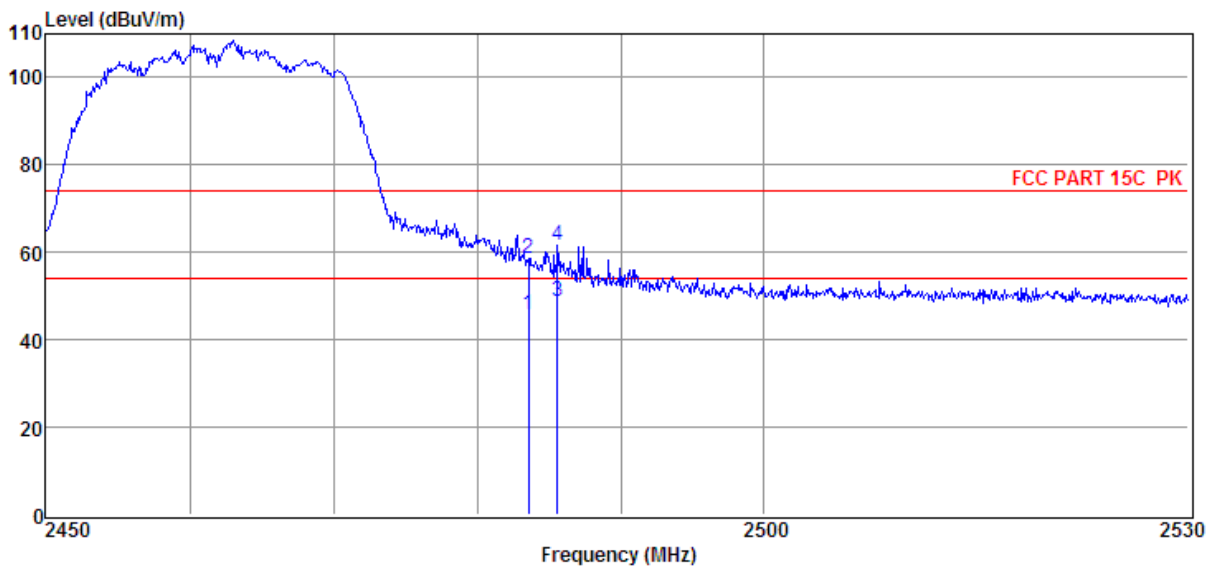

Item (Mark)	Freq. (MHz)	Read Level (dBμV)	Antenna Factor (dB/m)	PRM Factor (dB)	Cable Loss (dB)	Result Level (dBμV/m)	Limit Line (dBμV/m)	Over Limit (dB)	Detector	Polarization
1	2483.50	39.28	30.14	29.71	6.15	45.86	54.00	-8.14	Average	HORIZONTAL
2	2483.50	51.87	30.14	29.71	6.15	58.45	74.00	-15.55	Peak	HORIZONTAL
3	2485.52	42.12	30.15	29.71	6.15	48.71	54.00	-5.29	Average	HORIZONTAL
4	2485.52	55.19	30.15	29.71	6.15	61.78	74.00	-12.22	Peak	HORIZONTAL

Note: 1. Result Level = Read Level + Antenna Factor + Cable loss - PRM Factor.
 2. If Peak Result complies with AV limit, AV Result is deemed to comply with AV limit.
 3. Test setup: RBW: 1 MHz, VBW: 3 MHz, Sweep time: auto.

TR-4-E-009 Radiated Emission Test Result

Test Site : DDT 3m Chamber D:\2017 RE1# Report Data\17Q0116-9\RF.EM6
Test Date : 2017-04-08 **Tested By** : Jerry
EUT : Koogeek Lightbulb LB1 **Model Number** : LB1
Power Supply : AC 120V/60Hz **Test Mode** : 11HT40 CH3
Condition : Temp:24.5°C,Humi:55%,
 Press:100.1kPa **Antenna/Distance** : 2016 HF907/3m/HORIZONTAL
Memo :

Data: 55

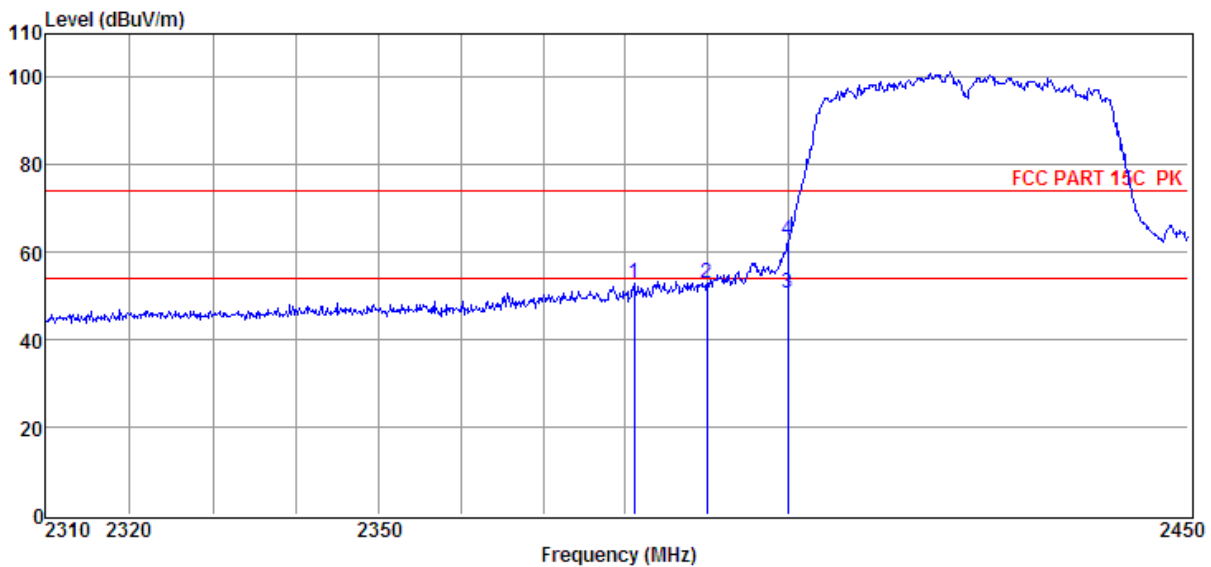

Item (Mark)	Freq. (MHz)	Read Level (dBμV)	Antenna Factor (dB/m)	PRM Factor (dB)	Cable Loss (dB)	Result Level (dBμV/m)	Limit Line (dBμV/m)	Over Limit (dB)	Detector	Polarization
1	2381.07	46.59	29.74	29.39	6.01	52.95	74.00	-21.05	Peak	HORIZONTAL
2	2390.00	46.72	29.78	29.41	6.01	53.10	74.00	-20.90	Peak	HORIZONTAL
3	2400.00	44.27	29.82	29.44	6.03	50.68	54.00	-3.32	Average	HORIZONTAL
4	2400.00	56.43	29.82	29.44	6.03	62.84	74.00	-11.16	Peak	HORIZONTAL

- Note: 1. Result Level = Read Level + Antenna Factor + Cable loss - PRM Factor.
 2. If Peak Result complies with AV limit, AV Result is deemed to comply with AV limit.
 3. Test setup: RBW: 1 MHz, VBW: 3 MHz, Sweep time: auto.

TR-4-E-009 Radiated Emission Test Result

Test Site : DDT 3m Chamber D:\2017 RE1# Report Data\17Q0116-9\RF.EM6
Test Date : 2017-04-08 **Tested By** : Jerry
EUT : Koogeek Lightbulb LB1 **Model Number** : LB1
Power Supply : AC 120V/60Hz **Test Mode** : 11HT40 CH3
Condition : Temp:24.5°C,Humi:55%,
 Press:100.1kPa **Antenna/Distance** : 2016 HF907/3m/VERTICAL
Memo :

Data: 56

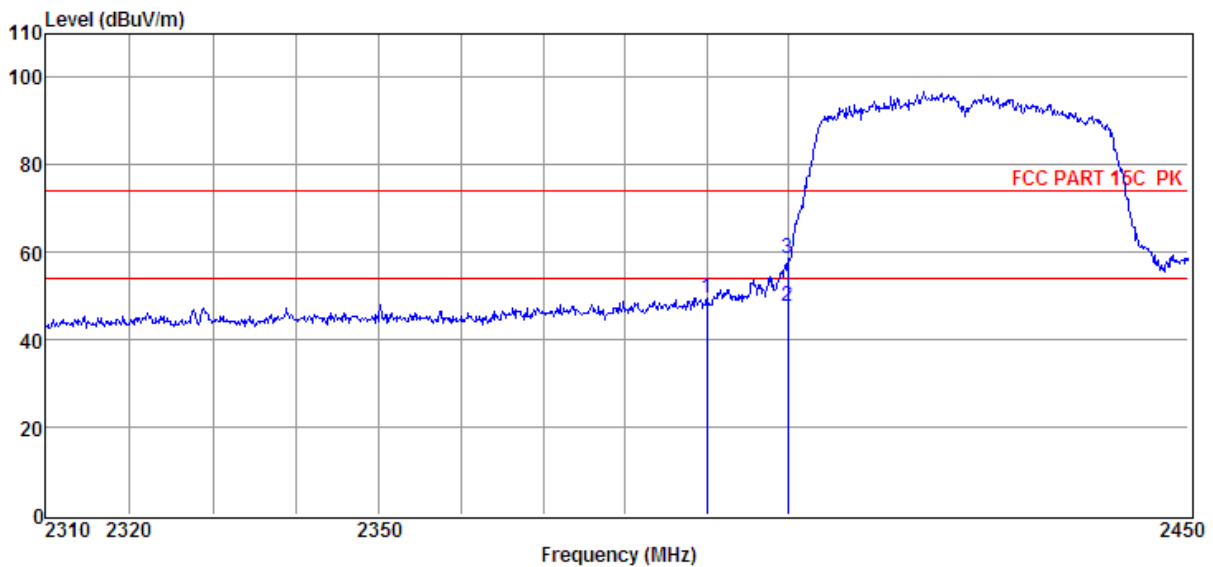

Item (Mark)	Freq. (MHz)	Read Level (dBμV)	Antenna Factor (dB/m)	PRM Factor (dB)	Cable Loss (dB)	Result Level (dBμV/m)	Limit Line (dBμV/m)	Over Limit (dB)	Detector	Polarization
1	2390.00	43.23	29.78	29.41	6.01	49.61	74.00	-24.39	Peak	VERTICAL
2	2400.00	41.28	29.82	29.44	6.03	47.69	54.00	-6.31	Average	VERTICAL
3	2400.00	52.03	29.82	29.44	6.03	58.44	74.00	-15.56	Peak	VERTICAL

- Note: 1. Result Level = Read Level + Antenna Factor + Cable loss - PRM Factor.
 2. If Peak Result complies with AV limit, AV Result is deemed to comply with AV limit.
 3. Test setup: RBW: 1 MHz, VBW: 3 MHz, Sweep time: auto.

TR-4-E-009 Radiated Emission Test Result

Test Site : DDT 3m Chamber D:\2017 RE1# Report Data\17Q0116-9\RF.EM6
Test Date : 2017-04-08 **Tested By** : Jerry
EUT : Koogeek Lightbulb LB1 **Model Number** : LB1
Power Supply : AC 120V/60Hz **Test Mode** : 11HT40 CH9
Condition : Temp:24.5°C,Humi:55%,
 Press:100.1kPa **Antenna/Distance** : 2016 HF907/3m/VERTICAL
Memo :

Data: 57

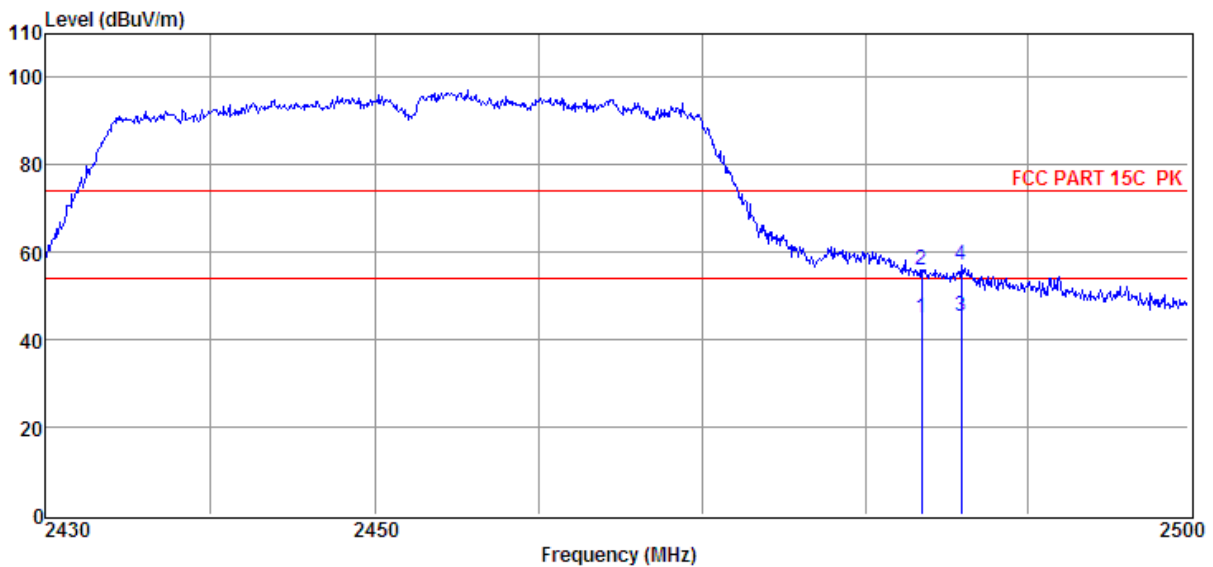

Item (Mark)	Freq. (MHz)	Read Level (dBμV)	Antenna Factor (dB/m)	PRM Factor (dB)	Cable Loss (dB)	Result Level (dBμV/m)	Limit Line (dBμV/m)	Over Limit (dB)	Detector	Polarization
1	2483.50	38.44	30.14	29.71	6.15	45.02	54.00	-8.98	Average	VERTICAL
2	2483.50	49.33	30.14	29.71	6.15	55.91	74.00	-18.09	Peak	VERTICAL
3	2485.91	38.64	30.15	29.71	6.15	45.23	54.00	-8.77	Average	VERTICAL
4	2485.91	50.43	30.15	29.71	6.15	57.02	74.00	-16.98	Peak	VERTICAL

Note: 1. Result Level = Read Level + Antenna Factor + Cable loss - PRM Factor.
 2. If Peak Result complies with AV limit, AV Result is deemed to comply with AV limit.
 3. Test setup: RBW: 1 MHz, VBW: 3 MHz, Sweep time: auto.

TR-4-E-009 Radiated Emission Test Result

Test Site : DDT 3m Chamber D:\2017 RE1# Report Data\17Q0116-9\RF.EM6
Test Date : 2017-04-08 **Tested By** : Jerry
EUT : Koogeek Lightbulb LB1 **Model Number** : LB1
Power Supply : AC 120V/60Hz **Test Mode** : 11HT40 CH9
Condition : Temp:24.5°C,Humi:55%,
 Press:100.1kPa **Antenna/Distance** : 2016 HF907/3m/HORIZONTAL
Memo :

Data: 58

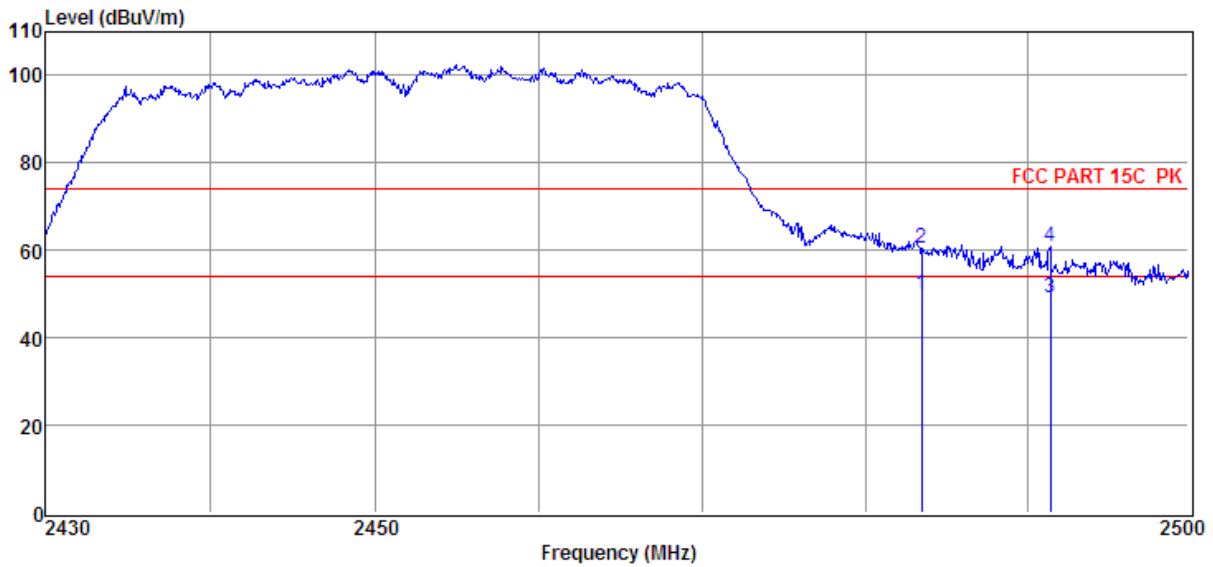

Item (Mark)	Freq. (MHz)	Read Level (dBμV)	Antenna Factor (dB/m)	PRM Factor (dB)	Cable Loss (dB)	Result Level (dBμV/m)	Limit Line (dBμV/m)	Over Limit (dB)	Detector	Polarization
1	2483.50	43.27	30.14	29.71	6.15	49.85	54.00	-4.15	Average	HORIZONTAL
2	2483.50	54.06	30.14	29.71	6.15	60.64	74.00	-13.36	Peak	HORIZONTAL
3	2491.42	42.59	30.17	29.73	6.15	49.18	54.00	-4.82	Average	HORIZONTAL
4	2491.42	54.27	30.17	29.73	6.15	60.86	74.00	-13.14	Peak	HORIZONTAL

Note: 1. Result Level = Read Level + Antenna Factor + Cable loss - PRM Factor.
 2. If Peak Result complies with AV limit, AV Result is deemed to comply with AV limit.
 3. Test setup: RBW: 1 MHz, VBW: 3 MHz, Sweep time: auto.

9. Power Line Conducted Emission

9.1. Block diagram of test setup

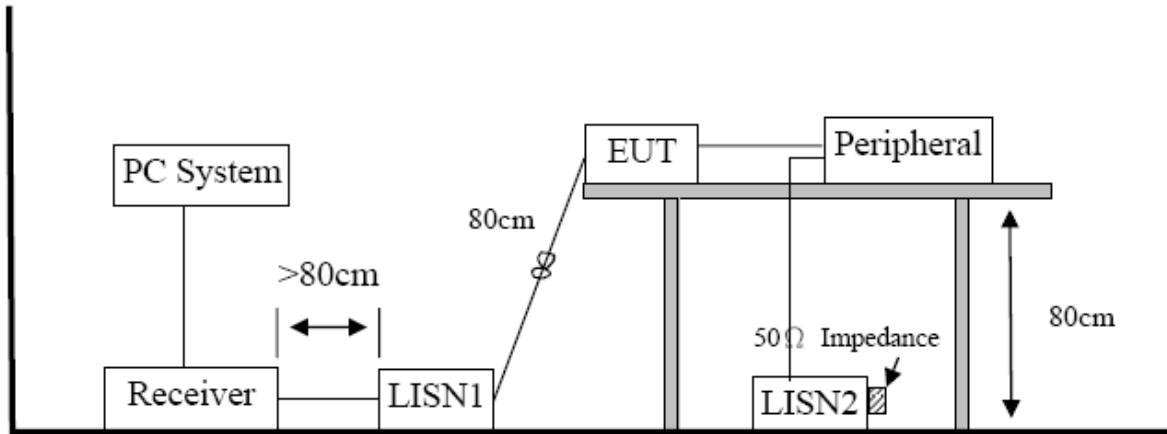

9.2. Power Line Conducted Emission Limits(Class B)

Frequency	Quasi-Peak Level dB(μ V)	Average Level dB(μ V)
150kHz ~ 500kHz	66 ~ 56*	56 ~ 46*
500kHz ~ 5MHz	56	46
5MHz ~ 30MHz	60	50

Note 1: * Decreasing linearly with logarithm of frequency.

Note 2: The lower limit shall apply at the transition frequencies.

9.3. Test Procedure

The EUT and Support equipment, if needed, were put placed on a non-metallic table, 80cm above the ground plane.

All I/O cables were positioned to simulate typical actual usage as per ANSI C63.4.

All support equipment power received from a second LISN.

Emissions were measured on each current carrying line of the EUT using an EMI Test Receiver connected to the LISN powering the EUT.

The Receiver scanned from 150 kHz to 30MHz for emissions in each of the test modes.

During the above scans, the emissions were maximized by cable manipulation.

After the preliminary scan, we found the test mode producing the highest emission level.

The EUT configuration and worse cable configuration of the above highest emission levels were recorded for reference of the final test.

EUT and support equipment were set up on the test bench as per the configuration with highest emission

level in the preliminary test.

A scan was taken on both power lines, Neutral and Line, recording at least the six highest emissions.

Emission frequency and amplitude were recorded into a computer in which correction factors were used to calculate the emission level and compare reading to the applicable limit.

The test data of the worst-case condition(s) was recorded.

The bandwidth of test receiver is set at 9 KHz.

9.4. Test Result

PASS. (See below detailed test result)

Note1: All emissions not reported below are too low against the prescribed limits.

Note2: “----” means peak detection; “-----” mans average detection

TR-4-E-010 Conducted Emission Test Result

Test Site	: DDT 1# Shield Room	E:\2017 CE report data\17Q0116-9\CE.EM6
Test Date	: 2017-03-09	Tested By : Jerry
EUT	: Koogeeek Lightbulb LB1	Model Number : LB1
Power Supply	: AC 120V/60Hz	Test Mode : Lighting (100%)
Condition	: Temp:24.5°C,Humi:55%, Press:100.1kPa	LISN : 2016 ENV216/NEUTRAL

Data: 18

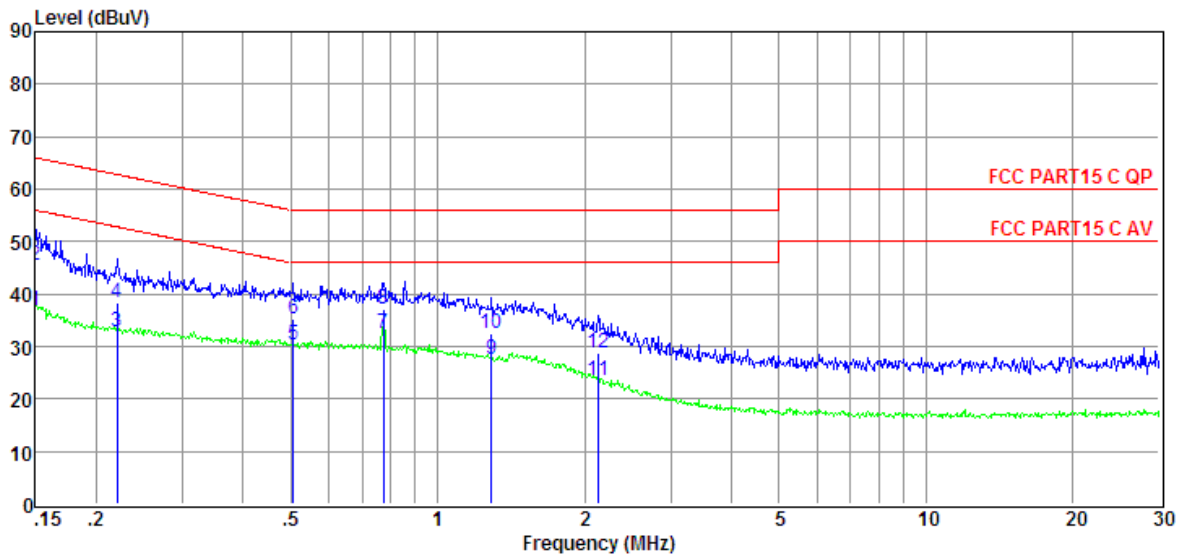

Item (Mark)	Freq. (MHz)	Read Level (dBμV)	LISN Factor (dB)	Cable Loss (dB)	Pulse Limiter Factor (dB)	Result Level (dBμV)	Limit Line (dBμV)	Over Limit (dB)	Detector	Phase
1	0.15	17.30	9.61	0.02	9.86	36.79	56.00	-19.21	Average	NEUTRAL
2	0.15	25.95	9.61	0.02	9.86	45.44	66.00	-20.56	QP	NEUTRAL
3	0.22	13.35	9.61	0.02	9.86	32.84	52.79	-19.95	Average	NEUTRAL
4	0.22	18.93	9.61	0.02	9.86	38.42	62.79	-24.37	QP	NEUTRAL
5	0.51	10.91	9.61	0.02	9.86	30.40	46.00	-15.60	Average	NEUTRAL
6	0.51	15.79	9.61	0.02	9.86	35.28	56.00	-20.72	QP	NEUTRAL
7	0.78	12.97	9.61	0.03	9.86	32.47	46.00	-13.53	Average	NEUTRAL
8	0.78	17.64	9.61	0.03	9.86	37.14	56.00	-18.86	QP	NEUTRAL
9	1.29	8.13	9.61	0.03	9.86	27.63	46.00	-18.37	Average	NEUTRAL
10	1.29	13.12	9.61	0.03	9.86	32.62	56.00	-23.38	QP	NEUTRAL
11	2.13	4.02	9.63	0.04	9.87	23.56	46.00	-22.44	Average	NEUTRAL
12	2.13	9.29	9.63	0.04	9.87	28.83	56.00	-27.17	QP	NEUTRAL

- Note: 1. Result Level = Read Level + LISN Factor + Pulse Limiter Factor + Cable loss.
 2. If QP Result complies with AV limit, AV Result is deemed to comply with AV limit.
 3. Test setup: RBW: 200 Hz (9 kHz—150 kHz), 9 kHz (150 kHz—30 MHz).
 4. Step size: 80Hz (0.009MHz-0.15MHz), 4 kHz (0.15MHz-30MHz), Scan time: auto.

TR-4-E-010 Conducted Emission Test Result

Test Site	: DDT 1# Shield Room	E:\2017 CE report data\17Q0116-9\CE.EM6
Test Date	: 2017-03-09	Tested By : Jerry
EUT	: Koogeeek Lightbulb LB1	Model Number : LB1
Power Supply	: AC 120V/60Hz	Test Mode : Lighting (100%)
Condition	: Temp:24.5°C,Humi:55%, Press:100.1kPa	LISN : 2016 ENV216/LINE

Data: 20

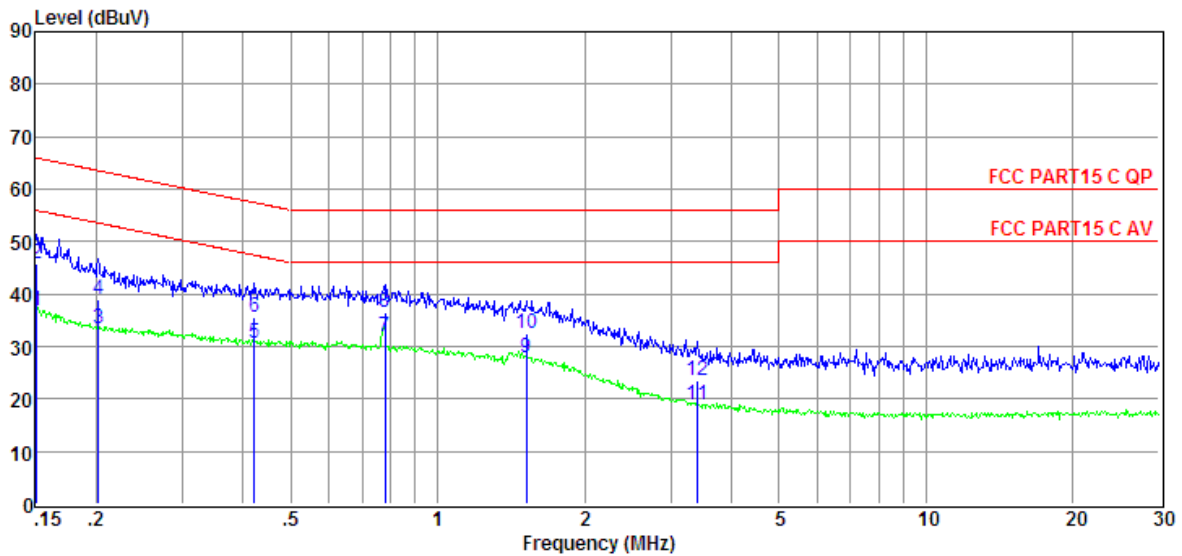

Item (Mark)	Freq. (MHz)	Read Level (dBμV)	LISN Factor (dB)	Cable Loss (dB)	Pulse Limiter Factor (dB)	Result Level (dBμV)	Limit Line (dBμV)	Over Limit (dB)	Detector	Phase
1	0.15	17.33	9.61	0.02	9.86	36.82	55.96	-19.14	Average	LINE
2	0.15	26.24	9.61	0.02	9.86	45.73	65.96	-20.23	QP	LINE
3	0.20	13.90	9.61	0.02	9.86	33.39	53.54	-20.15	Average	LINE
4	0.20	19.42	9.61	0.02	9.86	38.91	63.54	-24.63	QP	LINE
5	0.42	11.14	9.61	0.02	9.86	30.63	47.42	-16.79	Average	LINE
6	0.42	16.12	9.61	0.02	9.86	35.61	57.42	-21.81	QP	LINE
7	0.78	12.46	9.61	0.03	9.86	31.96	46.00	-14.04	Average	LINE
8	0.78	16.99	9.61	0.03	9.86	36.49	56.00	-19.51	QP	LINE
9	1.52	8.21	9.62	0.04	9.86	27.73	46.00	-18.27	Average	LINE
10	1.52	12.93	9.62	0.04	9.86	32.45	56.00	-23.55	QP	LINE
11	3.40	-0.54	9.64	0.05	9.87	19.02	46.00	-26.98	Average	LINE
12	3.40	4.09	9.64	0.05	9.87	23.65	56.00	-32.35	QP	LINE

- Note: 1. Result Level = Read Level + LISN Factor + Pulse Limiter Factor + Cable loss.
 2. If QP Result complies with AV limit, AV Result is deemed to comply with AV limit.
 3. Test setup: RBW: 200 Hz (9 kHz—150 kHz), 9 kHz (150 kHz—30 MHz).
 4. Step size: 80Hz (0.009MHz-0.15MHz), 4 kHz (0.15MHz-30MHz), Scan time: auto

10. Antenna Requirements

10.1. Limit

For intentional device, according to FCC 47 CFR Section 15.203, an intentional radiator shall be designed to ensure that no antenna other than that furnished by the responsible party shall be used with the device. And according to FCC 47 CFR Section 15.247 (b), if transmitting antennas of directional gain greater than 6dBi are used, the power shall be reduced by the amount in dB that the directional gain of the antenna exceeds 6dBi.

10.2. Result

The antennas used for this product are Integrated antenna, the maximum peak gain of the transmit antenna is only 0dBi.

11. Test setup photograph

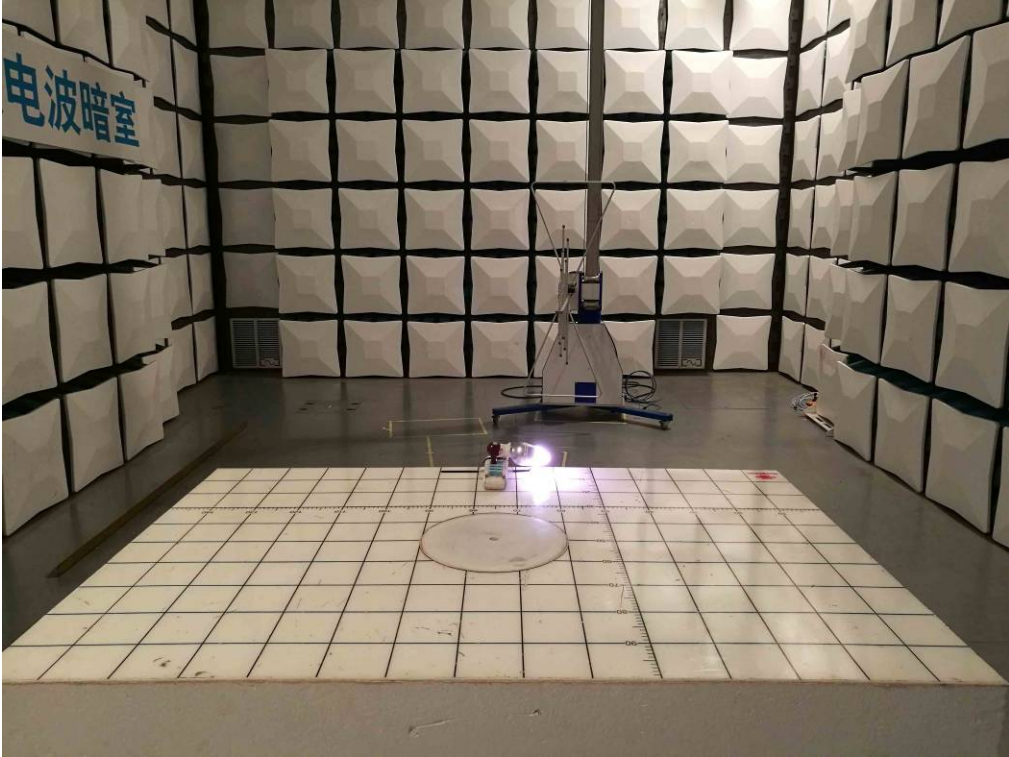

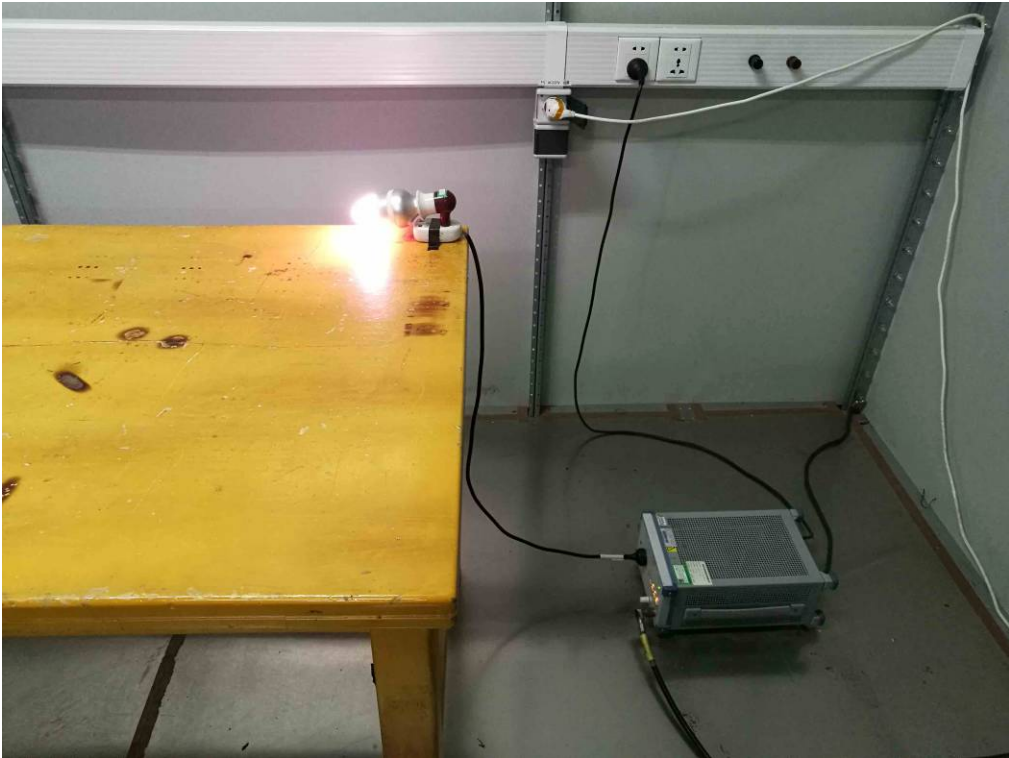

12. Photos of the EUT



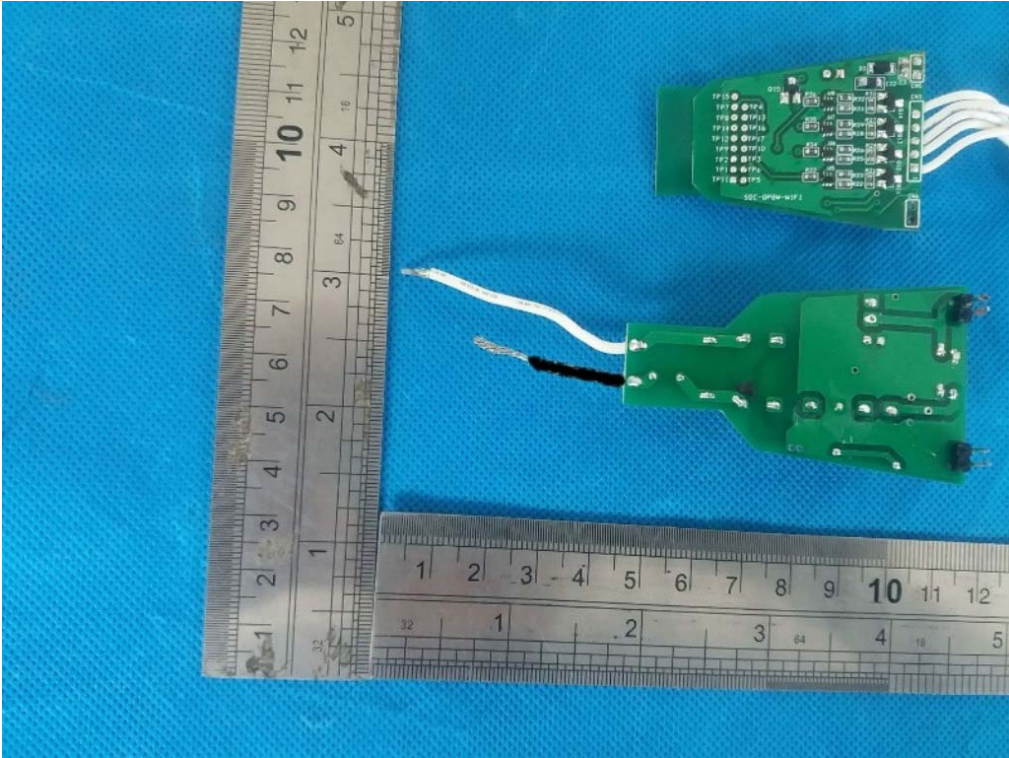
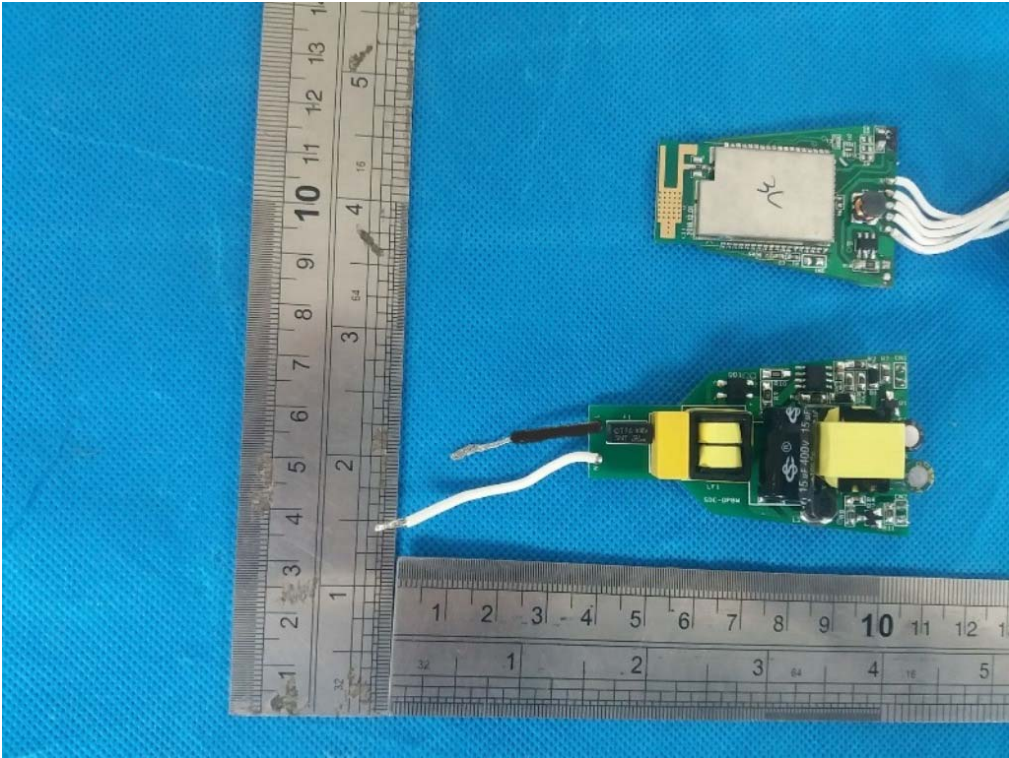

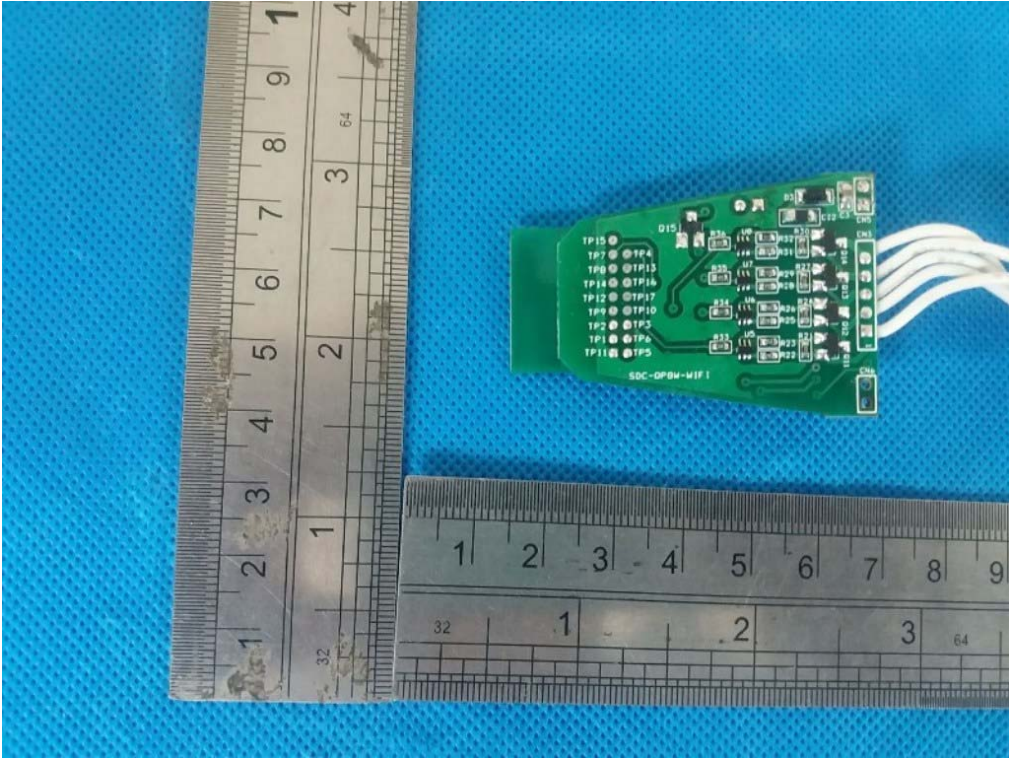
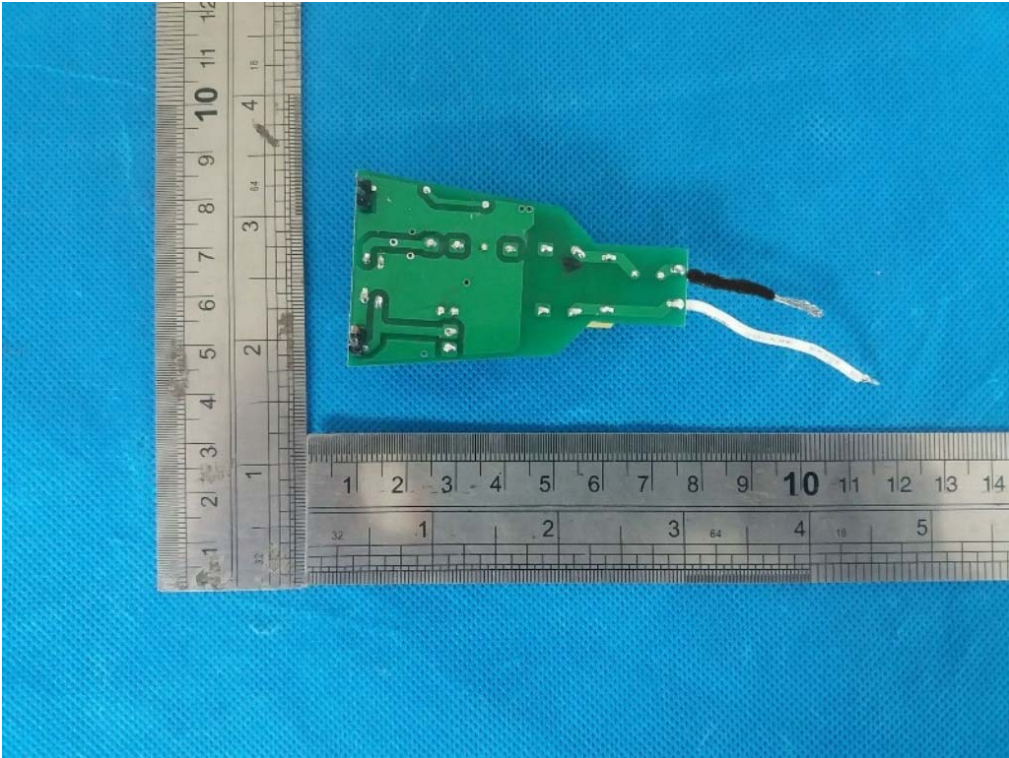

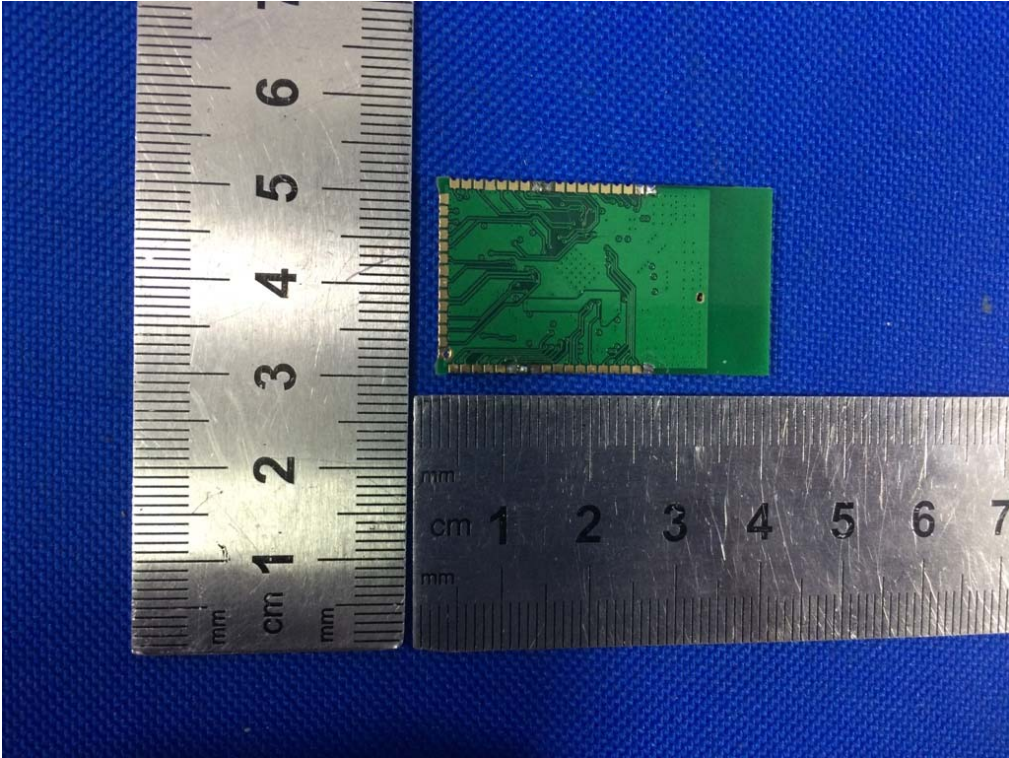
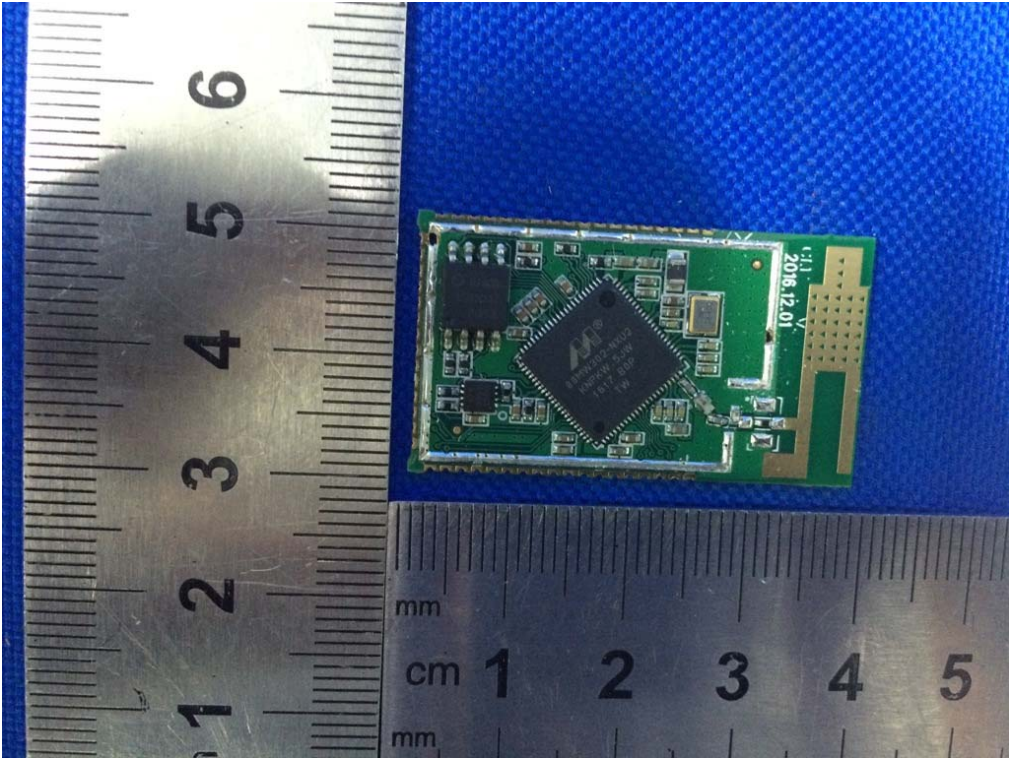

END OF REPORT