

## TEST REPORT

**Product Name** : Wireless 802.11AC Dual band  
**USB Adapter**  
**Trade mark** : N/A  
**Model/Type reference** : DC29  
**Serial Number** : N/A  
**Report Number** : EED32100268702  
**FCC ID** : 2AHDI-DC29  
**Date of Issue** : Nov. 29, 2016  
**Test Standards** : 47 CFR Part 15 Subpart E (2015)  
**Test result** : PASS

Prepared for:

**Shenzhen TOMTOP Technology Co., Ltd**  
**G-4 Zone 5/F, No.1 Exchange Square, Huanan City, Pinghu Town,**  
**Longgang Dist, Shenzhen, China**

Prepared by:

**Centre Testing International Group Co., Ltd.**  
**Hongwei Industrial Zone, Bao'an 70 District,**  
**Shenzhen, Guangdong, China**

**TEL: +86-755-3368 3668**

**FAX: +86-755-3368 3385**

Tested By:

*Tom chen*

Tom chen (Test Project)

Compiled by:

*Kevin lan*

Kevin lan (Project Engineer)

Reviewed by:

*Kevin yang*

Kevin yang (Reviewer)

Approved by:

*Sheek Luo*

Sheek Luo (Lab supervisor)

Date:  
Report Seal

Nov. 29, 2016

Check No.: 2457586783

## 2 Version

Version No.	Date	Description
00	Nov. 29, 2016	Original

### 3 Test Summary

Test Item	Test Requirement	Test method	Result
Antenna Requirement	47 CFR Part 15 Subpart C Section 15.203	ANSI C63.10-2013	PASS
AC Power Line Conducted Emission	47 CFR Part 15 Subpart E Section 15.407 (b)(6)	ANSI C63.10-2013	PASS
Conducted Output Power and transmit power control mechanism	47 CFR Part 15 Subpart E Section 15.407 (a)(1)(2)(4)(h)(1)	ANSI C63.10-2013	PASS
Emission Bandwidth	47 CFR Part 15 Subpart E Section 15.407 (a)(1)(2)	ANSI C63.10-2013	PASS
Peak Power Spectral Density	47 CFR Part 15 Subpart E Section 15.407 (a)(1)(2)(5)	ANSI C63.10-2013	PASS
Frequency stability	47 CFR Part 15 Subpart E Section 15.407 (g)	ANSI C63.10-2013	PASS
Operation in the absence of information to the transmit	47 CFR Part 15 Subpart E Section 15.407 (c)	47 CFR Part 15 Subpart E	PASS
Unwanted Emissions that fall Outside of the Restricted Bands	47 CFR Part 15 Subpart E Section 15.407 (b)(1)(2)(3)(5)	ANSI C63.10-2013	PASS
Unwanted Emissions in the Restricted Bands	47 CFR Part 15 Subpart E Section 15.407 (b)(6)(7)(8)	ANSI C63.10-2013	PASS
Restricted bands around fundamental frequency (Radiated Emission)	47 CFR Part 15 Subpart E Section 15.407 (b)(6)(7)(8)	ANSI C63.10-2013	PASS

**Remark:**

The tested sample and the sample information are provided by the client.

Tx: In this whole report Tx (or tx) means Transmitter.

Rx: In this whole report Rx (or rx) means Receiver.

RF: In this whole report RF means Radiated Frequency.

CH: In this whole report CH means channel.

Volt: In this whole report Volt means Voltage.

Temp: In this whole report Temp means Temperature.

Humid: In this whole report Humid means humidity.

Press: In this whole report Press means Pressure.

N/A: In this whole report not application.

## 4 Content

<b>1 COVER PAGE</b> .....	<b>1</b>
<b>2 VERSION</b> .....	<b>2</b>
<b>3 TEST SUMMARY</b> .....	<b>3</b>
<b>4 CONTENT</b> .....	<b>4</b>
<b>5 TEST REQUIREMENT</b> .....	<b>5</b>
5.1 TEST SETUP.....	5
5.1.1 For Conducted test setup.....	5
5.1.2 For Radiated Emissions test setup.....	5
5.1.3 For Conducted Emissions test setup.....	6
5.2 TEST ENVIRONMENT.....	6
5.3 TEST CONDITION.....	6
<b>6 GENERAL INFORMATION</b> .....	<b>8</b>
6.1 CLIENT INFORMATION.....	8
6.2 GENERAL DESCRIPTION OF EUT.....	8
6.3 PRODUCT SPECIFICATION SUBJECTIVE TO THIS STANDARD.....	8
6.4 DESCRIPTION OF SUPPORT UNITS.....	9
6.5 TEST LOCATION.....	9
6.6 TEST FACILITY.....	10
6.7 DEVIATION FROM STANDARDS.....	11
6.8 ABNORMALITIES FROM STANDARD CONDITIONS.....	11
6.9 OTHER INFORMATION REQUESTED BY THE CUSTOMER.....	11
6.10 MEASUREMENT UNCERTAINTY (95% CONFIDENCE LEVELS, K=2).....	11
<b>7 EQUIPMENT LIST</b> .....	<b>12</b>
<b>8 RADIO TECHNICAL REQUIREMENTS SPECIFICATION</b> .....	<b>14</b>
Appendix A): Emission Bandwidth.....	15
Appendix B): Maximum Conduct Output Power.....	27
Appendix C): Power Spectral Density.....	52
Appendix D): Band Edge Measurements.....	65
Appendix E): Frequency Stability.....	75
Appendix F): Antenna Requirement.....	78
Appendix G): Operation in the absence of information to the transmit.....	79
Appendix H): AC Power Line Conducted Emission.....	80
Appendix I): Restricted bands around fundamental frequency (Radiated Emission).....	85
Appendix J): Unwanted Emissions in the Restricted Bands (Radiated Emission).....	99
Appendix K): Unwanted Emissions that fall Outside of the Restricted Bands.....	131
<b>PHOTOGRAPHS OF TEST SETUP</b> .....	<b>147</b>
<b>PHOTOGRAPHS OF EUT CONSTRUCTIONAL DETAILS</b> .....	<b>150</b>

## 5 Test Requirement

### 5.1 Test setup

#### 5.1.1 For Conducted test setup

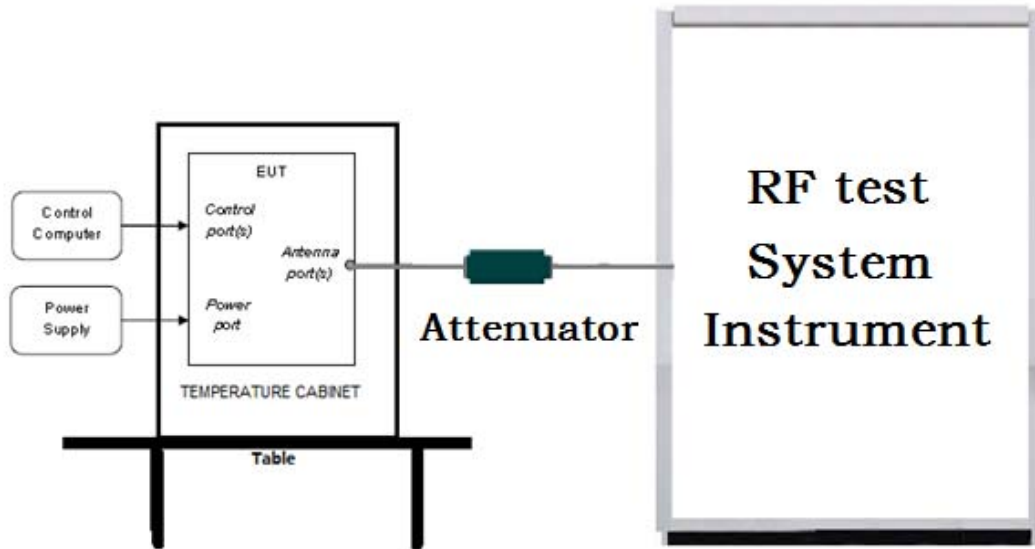

#### 5.1.2 For Radiated Emissions test setup

Radiated Emissions setup:

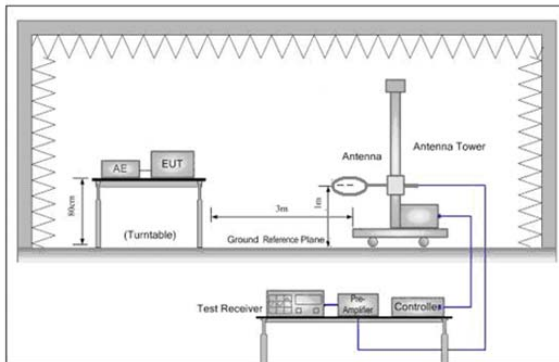

Figure 1. Below 30MHz

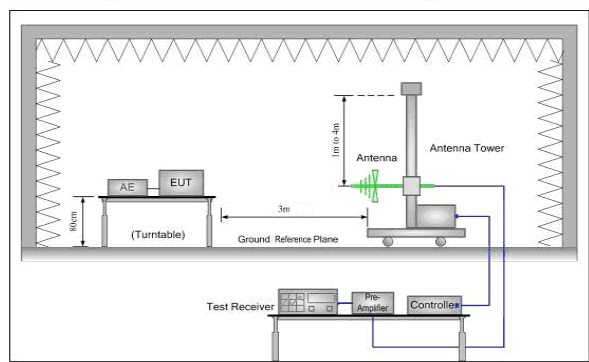

Figure 2. 30MHz to 1GHz

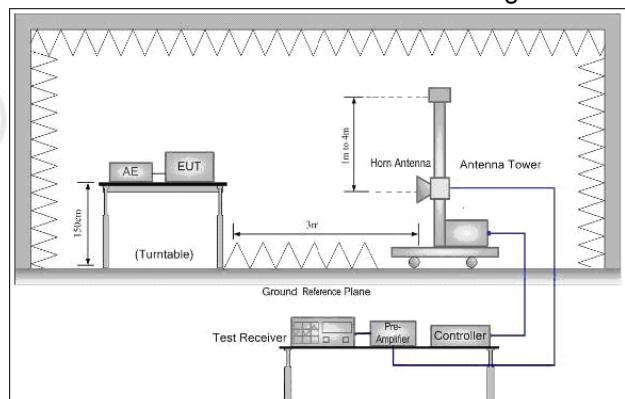
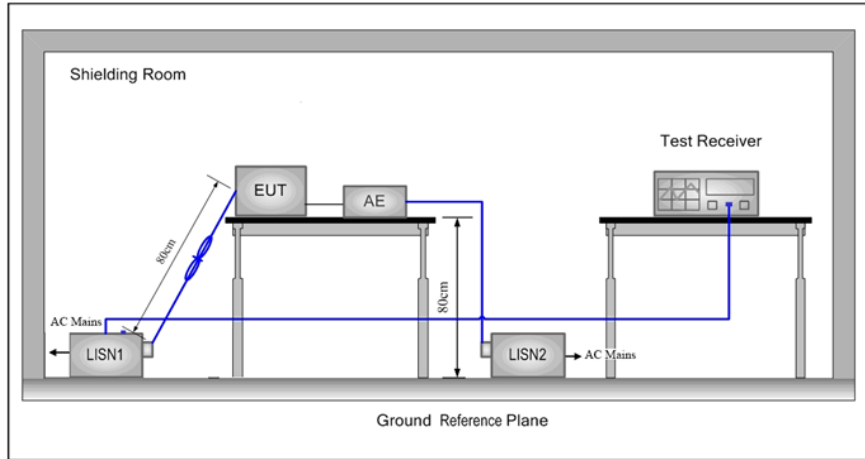

Figure 3. Above 1GHz

**5.1.3 For Conducted Emissions test setup**  
**Conducted Emissions setup**



**5.2 Test Environment**

<b>Operating Environment:</b>	
Temperature:	23°C
Humidity:	52% RH
Atmospheric Pressure:	1010mbar

**5.3 Test Condition**

**Test channel:**

Test Mode	Tx/Rx	RF Channel		
		Low(L)	Middle(M)	High(H)
802.11a/n/ac(20M)	5150MHz ~5250 MHz	Channel 36	Channel 44	Channel 48
		5180MHz	5220MHz	5240MHz
802.11n/ac(40M)	5150MHz ~5250 MHz	Channel 38	N/A	Channel 46
		5190MHz	N/A	5230MHz
802.11ac(80M)	5150MHz ~5250 MHz	N/A	Channel 42	N/A
		N/A	5210MHz	N/A
802.11a/n/ac(20M)	5725MHz ~5850 MHz	Channel 149	Channel 157	Channel 165
		5745MHz	5785MHz	5825MHz
802.11n/ac(40M)	5725MHz ~5850 MHz	Channel 151	N/A	Channel 159
		5755MHz	N/A	5795MHz
802.11ac(80M)	5725MHz ~5850 MHz	N/A	Channel 155	N/A
		N/A	5775MHz	N/A

Test mode:

**Pre-scan under all rate at lowest channel 1 for antenna 1**

Mode	<b>802.11a for 5150MHz ~5250 MHz</b>							
Data Rate	MCS0	MCS1	MCS2	MCS3	MCS4	MCS5	MCS6	MCS7
Power(dBm)	10.83	10.75	10.68	10.82	10.79	10.80	10.78	10.77
Mode	<b>802.11n (20M) for 5150MHz ~5250 MHz</b>							
Data Rate	MCS0	MCS1	MCS2	MCS3	MCS4	MCS5	MCS6	MCS7
Power(dBm)	10.71	10.70	10.67	10.67	10.62	10.65	10.68	10.63
Mode	<b>802.11ac (20M) for 5150MHz ~5250 MHz</b>							
Data Rate	MCS0	MCS1	MCS2	MCS3	MCS4	MCS5	MCS6	MCS7
Power(dBm)	10.07	10.04	10.05	10.01	9.88	9.97	10.03	10.04
Mode	<b>802.11n(40M) for 5150MHz ~5250 MHz</b>							
Data Rate	MCS0	MCS1	MCS2	MCS3	MCS4	MCS5	MCS6	MCS7
Power(dBm)	9.96	9.94	9.93	9.87	9.88	9.81	9.95	9.91
Mode	<b>802.11ac (40M) for 5150MHz ~5250 MHz</b>							
Data Rate	MCS0	MCS1	MCS2	MCS3	MCS4	MCS5	MCS6	MCS7
Power(dBm)	9.47	9.45	9.42	9.44	9.40	9.42	9.46	9.38
Mode	<b>802.11ac(80M)for 5150MHz ~5250 MHz</b>							
Data Rate	MCS0	MCS1	MCS2	MCS3	MCS4	MCS5	MCS6	MCS7
Power(dBm)	9.29	9.20	9.23	9.27	9.21	9.16	9.22	9.24
Mode	<b>802.11a for 5725MHz ~5850 MHz</b>							
Data Rate	MCS0	MCS1	MCS2	MCS3	MCS4	MCS5	MCS6	MCS7
Power(dBm)	7.37	7.28	7.22	7.33	7.30	7.33	7.25	7.32
Mode	<b>802.11n (20M) for 5725MHz ~5850 MHz</b>							
Data Rate	MCS0	MCS1	MCS2	MCS3	MCS4	MCS5	MCS6	MCS7
Power(dBm)	7.14	7.05	7.04	7.12	7.12	7.10	7.11	7.12
Mode	<b>802.11ac (20M) for 5725MHz ~5850 MHz</b>							
Data Rate	MCS0	MCS1	MCS2	MCS3	MCS4	MCS5	MCS6	MCS7
Power(dBm)	8.01	7.91	7.93	7.94	7.90	7.88	7.89	7.95
Mode	<b>802.11n (40M) for 5725MHz ~5850 MHz</b>							
Data Rate	MCS0	MCS1	MCS2	MCS3	MCS4	MCS5	MCS6	MCS7
Power(dBm)	8.74	8.65	8.70	8.73	8.69	8.56	8.65	8.68
Mode	<b>802.11ac (40M) for 5725MHz ~5850 MHz</b>							
Data Rate	MCS0	MCS1	MCS2	MCS3	MCS4	MCS5	MCS6	MCS7
Power(dBm)	7.57	7.31	7.24	7.26	7.28	7.25	7.31	7.32
Mode	<b>802.11ac(80M)for 5725MHz ~5850 MHz</b>							
Data Rate	MCS0	MCS1	MCS2	MCS3	MCS4	MCS5	MCS6	MCS7
Power(dBm)	7.84	7.80	8.75	7.78	7.82	7.81	7.71	7.80

Through Pre-scan, MCS0 is the worst case of 802.11a (20M) for 5150MHz ~5250 MHz; MCS0 is the worst case of 802.11n (20M) for 5150MHz ~5250 MHz; MCS0 is the worst case of 802.11ac (20M) for 5150MHz ~5250 MHz; MCS0 is the worst case of 802.11n(40M) for 5150MHz ~5250 MHz; MCS0 is the worst case of 802.11ac (40M) for 5150MHz ~5250 MHz; MCS0 is the worst case of 802.11ac(80M)for 5150MHz ~5250 MHz; MCS0 is the worst case of 802.11a (20M) for 5725MHz ~5850 MHz; MCS0 is the worst case of 802.11n (20M) for 5725MHz ~5850 MHz; MCS0 is the worst case of 802.11ac (20M) for 5725MHz ~5850 MHz; MCS0 is the worst case of 802.11n (40M) for 5725MHz ~5850 MHz; MCS0 is the worst case of 802.11ac (40M) for 5725MHz ~5850 MHz; MCS0 is the worst case of 802.11ac(80M)for 5725MHz ~5850 MHz;

## 6 General Information

### 6.1 Client Information

Applicant:	Shenzhen TOMTOP Technology Co., Ltd.
Address of Applicant:	G-4 Zone 5/F, No.1 Exchange Square, Huanan City, Pinghu Town, Longgang Dist, Shenzhen, China.
Manufacturer:	Winstars Technology Limited
Address of Manufacturer:	Block 4, TaiSong Industrial Park, DaLang Street, LongHua Town, Bao'an district, Shenzhen, China

### 6.2 General Description of EUT

Product Name:	Wireless 802.11AC Dual band USB Adapter
Model No.(EUT):	DC29
Trade Mark:	N/A
EUT Supports Radios application:	WiFi : 2.4G: b/g/n(20M/40M) 2412-2462MHz 5G: U-NII-1: 5.15-5.25GHz; U-NII-3: 5.725-5.850GHz 802.11a; 802.11n(20MHz/40MHz); 802.11ac(20MHz/40MHz/80MHz)
Power Supply:	DC 5V
Sample Received Date:	Oct. 12, 2016
Sample tested Date:	Oct. 12, 2016 to Nov. 29, 2016

### 6.3 Product Specification subjective to this standard

Operation Frequency:	IEEE 802.11a/n/ac(20M): 5150MHz ~5250 MHz IEEE802.11n/ac(40M): 5150MHz ~5250 MHz IEEE802.11ac(80M): 5150MHz ~5250 MHz IEEE 802.11a/n/ac(20M): 5725MHz ~5850 MHz IEEE802.11n/ac(40M): 5725MHz ~5850 MHz IEEE802.11ac(80M): 5725MHz ~5850 MHz
Channel Numbers:	IEEE 802.11a/n/ac(20M): 5150MHz ~5250MHz/ 4 channel IEEE 802.11n/ac(40M): 5150MHz ~5250MHz/ 2 channel IEEE 802.11ac(80M): 5150MHz ~5250MHz/ 1 channel IEEE 802.11a/n/ac(20M): 5725MHz ~5850MHz/ 5 channel IEEE 802.11n/ac(40M): 5725MHz ~5850MHz/ 2 channel IEEE 802.11ac(80M): 5725MHz ~5850MHz/ 1 channel
Type of Modulation:	DSSS, OFDM
Sample Type:	Portable production
Test Power Grade:	(manufacturer declare )2.4G WIFI:33; 5G WIFI: 35
Test Software of EUT:	(manufacturer declare ) REALTEK
Antenna Type and Gain:	Integral Antenna and 3dBi
Test Voltage:	AC 120V/60Hz, AC 240V/50Hz
Power Supply:	DC 5V



## Operation Frequency each of channel

For 802.11a/n/ac( 20M) Operation in the 5150MHz ~5250 MHz band			
Channel	Frequency	Channel	Frequency
36	5180MHz	44	5220MHz
40	5200MHz	48	5240MHz
For 802.11a/n/ac( 20M) Operation in the 5725MHz ~5850 MHz band			
Channel	Frequency	Channel	Frequency
149	5745MHz	162	5805MHz
153	5765MHz	165	5825MHz
157	5785MHz	NA	NA

For 802.11n/ac(40M) Operation in the 5150MHz ~5250 MHz band			
Channel	Frequency	Channel	Frequency
38	5190MHz	46	5230MHz
For 802.11n/ac(40M) Operation in the 5725MHz ~5850 MHz band			
Channel	Frequency	Channel	Frequency
151	5755MHz	159	5795MHz

For 802.11ac(80M) Operation in the 5150MHz ~5250 MHz band			
Channel	Frequency	NA	NA
42	5210MHz	NA	NA
For 802.11ac(80M) Operation in the 5725MHz ~5850 MHz band			
Channel	Frequency	NA	NA
155	5775MHz	NA	NA

## 6.4 Description of Support Units

The EUT has been tested with associated equipment below.  
support equipment

Description	Manufacturer	Model No.	SN	Supplied by
Laptop	Lenovo	E46L	EB22995690	CTI
Mouse	L.Selectron	OP-200	NA	CTI

## 6.5 Test Location

All tests were performed at:

Centre Testing International Group Co., Ltd.

Hongwei Industrial Zone, Bao'an 70 District, Shenzhen, Guangdong, China 518101

Telephone: +86 (0) 755 3368 3668 Fax:+86 (0) 755 3368 3385

No tests were sub-contracted.

## 6.6 Test Facility

The test facility is recognized, certified, or accredited by the following organizations:

### **CNAS-Lab Code: L1910**

Centre Testing International Group Co., Ltd. has been assessed and proved to be in compliance with CNAS-CL01 Accreditation Criteria for Testing and Calibration Laboratories (identical to ISO/IEC 17025: 2005 General Requirements) for the Competence of Testing and Calibration Laboratories..

### **A2LA-Lab Cert. No. 3061.01**

Centre Testing International Group Co., Ltd. EMC Laboratory has been accredited by A2LA for technical competence in the field of electrical testing, and proved to be in compliance with ISO/IEC 17025: 2005 General Requirements for the Competence of Testing and Calibration Laboratories and any additional program requirements in the identified field of testing.

### **FCC-Registration No.: 886427**

Centre Testing International Group Co., Ltd. EMC Laboratory has been registered and fully described in a report filed with the FCC (Federal Communications Commission). The acceptance letter from the FCC is maintained in our files. Registration 886427.

### **IC-Registration No.: 7408A-2**

The 3m Alternate Test Site of Centre Testing International Group Co., Ltd. has been registered by Certification and Engineering Bureau of Industry Canada for the performance of radiated measurements with Registration No. 7408A-2 .

### **IC-Registration No.: 7408B-1**

The 10m Alternate Test Site of Centre Testing International Group Co., Ltd. has been registered by Certification and Engineering Bureau of Industry Canada for the performance of radiated measurements with Registration No. 7408B-1.

### **NEMKO-Aut. No.: ELA503**

Centre Testing International Group Co., Ltd. has been assessed the quality assurance system, the testing facilities, qualifications and testing practices of the relevant parts of the organization. The quality assurance system of the Laboratory has been validated against ISO/IEC 17025 or equivalent. The laboratory also fulfils the conditions described in Nemko Document NLA-10.

### **VCCI**

The Radiation 3 &10 meters site of Centre Testing International Group Co., Ltd. has been registered in accordance with the Regulations for Voluntary Control Measures with Registration No.: R-4096.

Main Ports Conducted Interference Measurement of Centre Testing International Group Co., Ltd. has been registered in accordance with the Regulations for Voluntary Control Measures with Registration No.: C-4563.

Telecommunication Ports Conducted Disturbance Measurement of Centre Testing International Group Co., Ltd. has been registered in accordance with the Regulations for Voluntary Control Measures with Registration No.: T-2146.

The Radiation 3 meters site of Centre Testing International Group Co., Ltd. has been registered in accordance with the Regulations for Voluntary Control Measures with Registration No.: G-758

## 6.7 Deviation from Standards

None.

## 6.8 Abnormalities from Standard Conditions

None.

## 6.9 Other Information Requested by the Customer

None.

## 6.10 Measurement Uncertainty (95% confidence levels, k=2)

No.	Item	Measurement Uncertainty
1	Radio Frequency	$7.9 \times 10^{-8}$
2	RF power, conducted	0.31dB (30MHz-1GHz)
		0.57dB (1GHz-18GHz)
3	Radiated Spurious emission test	4.5dB (30MHz-1GHz)
		4.8dB (1GHz-12.75GHz)
4	Conduction emission	3.6dB (9kHz to 150kHz)
		3.2dB (150kHz to 30MHz)
5	Temperature test	0.64°C
6	Humidity test	2.8%
7	DC power voltages	0.025%

## 7 Equipment List

RF test system					
Equipment	Manufacturer	Model No.	Serial Number	Cal. Date (mm-dd-yyyy)	Cal. Due date (mm-dd-yyyy)
Signal Generator	Keysight	E8257D	MY53401106	04-01-2016	03-31-2017
Communication test set test set	Agilent	N4010A	MY51400230	04-01-2016	03-31-2017
Spectrum Analyzer	Keysight	N9010A	MY54510339	04-01-2016	03-31-2017
Signal Generator	Keysight	N5182B	MY53051549	04-01-2016	03-31-2017
High-pass filter	Sinoscite	FL3CX03WG18 NM12-0398-002	---	01-12-2016	01-11-2017
High-pass filter	MICRO-TRONICS	SPA-F-63029-4	---	01-12-2016	01-11-2017
DC Power	Keysight	E3642A	MY54436035	04-01-2016	03-31-2017
PC-1	Lenovo	R4960d	---	04-01-2016	03-31-2017
power meter & power sensor	R&S	OSP120	101374	04-01-2016	03-31-2017
RF control unit	JS Tonscend	JS0806-2	158060006	04-01-2016	03-31-2017
BT&WI-FI Automatic test software	JS Tonscend	JS1120-2	---	04-01-2016	03-31-2017

Conducted disturbance Test					
Equipment	Manufacturer	Model No.	Serial Number	Cal. date (mm-dd-yyyy)	Cal. Due date (mm-dd-yyyy)
Receiver	R&S	ESCI	100009	06-16-2016	06-15-2017
Temperature/ Humidity Indicator	TAYLOR	1451	1905	04-27-2016	04-26-2017
Communication test set	Agilent	E5515C	GB47050534	04-01-2016	03-31-2017
Communication test set	R&S	CMW500	152394	04-01-2016	03-31-2017
LISN	R&S	ENV216	100098	06-16-2016	06-15-2017
LISN	schwarzbeck	NNLK8121	8121-529	06-16-2016	06-15-2017
Voltage Probe	R&S	ESH2-Z3	--	07-09-2014	07-07-2017
Current Probe	R&S	EZ17	100106	06-16-2016	06-15-2017
ISN	TESEQ GmbH	ISN T800	30297	01-29-2015	01-27-2017

3M Semi/full-anechoic Chamber					
Equipment	Manufacturer	Model No.	Serial Number	Cal. date (mm-dd-yyyy)	Cal. Due date (mm-dd-yyyy)
3M Chamber & Accessory Equipment	TDK	SAC-3	---	06-05-2016	06-05-2019
TRILOG Broadband Antenna	SCHWARZBEC K	VULB9163	9163-484	05-23-2016	05-22-2017
Microwave Preamplifier	Agilent	8449B	3008A02425	02-04-2016	02-03-2017
Horn Antenna	ETS-LINDGREN	3117	00057407	07-20-2015	07-18-2018
Loop Antenna	ETS	6502	00071730	07-30-2015	07-28-2017
Microwave Preamplifier	A.H.SYSTEMS	PAP-1840-60	6041.6042	06-30-2015	06-28-2018
Horn Antenna	A.H.SYSTEMS	SAS-574	374	06-30-2015	06-28-2018
Spectrum Analyzer	R&S	FSP40	100416	06-16-2016	06-15-2017
Receiver	R&S	ESCI	100435	06-16-2016	06-15-2017
Multi device Controller	matur	NCD/070/10711 112	---	01-12-2016	01-11-2017
LISN	schwarzbeck	NNBM8125	81251547	06-16-2016	06-15-2017
LISN	schwarzbeck	NNBM8125	81251548	06-16-2016	06-15-2017
Signal Generator	Agilent	E4438C	MY45095744	04-01-2016	03-31-2017
Signal Generator	Keysight	E8257D	MY53401106	04-01-2016	03-31-2017
Temperature/ Humidity Indicator	TAYLOR	1451	1905	04-27-2016	04-26-2017
Communication test set	Agilent	E5515C	GB47050534	04-01-2016	03-31-2017
Cable line	Fulai(7M)	SF106	5219/6A	01-12-2016	01-11-2017
Cable line	Fulai(6M)	SF106	5220/6A	01-12-2016	01-11-2017
Cable line	Fulai(3M)	SF106	5216/6A	01-12-2016	01-11-2017
Cable line	Fulai(3M)	SF106	5217/6A	01-12-2016	01-11-2017
Communication test set	R&S	CMW500	152394	04-01-2016	03-31-2017
High-pass filter	Sinoscite	FL3CX03WG18 NM12-0398-002	---	01-12-2016	01-11-2017
High-pass filter	MICRO-TRONICS	SPA-F-63029-4	---	01-12-2016	01-11-2017
band rejection filter	Sinoscite	FL5CX01CA09 CL12-0395-001	---	01-12-2016	01-11-2017
band rejection filter	Sinoscite	FL5CX01CA08 CL12-0393-001	---	01-12-2016	01-11-2017
band rejection filter	Sinoscite	FL5CX02CA04 CL12-0396-002	---	01-12-2016	01-11-2017
band rejection filter	Sinoscite	FL5CX02CA03 CL12-0394-001	---	01-12-2016	01-11-2017

## 8 Radio Technical Requirements Specification

### Reference documents for testing:

No.	Identity	Document Title
1	FCC Part15E (2015)	Subpart C-Intentional Radiators
2	ANSI C63.10-2013	American National Standard for Testing Unlicensed Wireless Devices
3	KDB789033 D02 General UNII Test Procedures New Rules v01r03	Guidelines for compliance testing of unlicensed national information infrastructure (U-NII) device part 15 subpart E
4	KDB 662911 D01 Multiple Transmitter Output v02r01	Emissions Testing of Transmitters with Multiple Outputs in the Same Band
5	KDB 644545 D03 v01	Guidance for IEEE 802.11ac

### Test Results List:

Test Requirement	Test method	Test item	Verdict	Note
Part15E Section 15.407 (a)(1)(2)	KDB789033	Emission Bandwidth and Occupied Bandwidth	PASS	Appendix A)
Part15E Section 15.407 (a)(1)(2)(4)(h)(1)	KDB789033 / KDB 662911	Conducted Output Power and transmit power control mechanism	PASS	Appendix B)
Part15E Section 15.407 (a)(1)(2)(5)	KDB789033 / KDB 662911	Power Spectral Density	PASS	Appendix C)
Part15E Section 15.407 (b)(1)to(6)	KDB789033 / KDB 662911	Band Edge Measurements	PASS	Appendix D)
Part15E Section 15.407 (g)	KDB789033	Frequency stability	PASS	Appendix E)
Part15C Section 15.203	ANSI C63.10	Antenna Requirement	PASS	Appendix F)
Part15E Section 15.407 (c)	Section 15.407	Operation in the absence of information to the transmit	PASS	Appendix G)
Part15E Section 15.407 (b)(6)	ANSI C63.10	AC Power Line Conducted Emission	PASS	Appendix H)
Part15E Section 15.407 (b)(6)(7)(8)	KDB789033	Restricted bands around fundamental frequency (Radiated Emission)	PASS	Appendix I)
Part15E Section 15.407 (b)(6)(7)(8)	KDB789033	Unwanted Emissions in the Restricted Bands	PASS	Appendix J)
Part15E Section 15.407 (b)(1)(2)(3)(5)	KDB789033	Unwanted Emissions that fall Outside of the Restricted Bands	PASS	Appendix K)

## Appendix A): Emission Bandwidth

### Result Table

Test Mode	Antenna	Channel	EBW[MHz]	OBW[MHz]	Verdict
11A	Ant1	5180	21.15	17.728	PASS
11A	Ant1	5200	20.77	17.707	PASS
11A	Ant1	5240	21.22	17.672	PASS
11A	Ant1	5745	17.56	17.634	PASS
11A	Ant1	5785	17.54	17.636	PASS
11A	Ant1	5825	17.28	17.649	PASS
11A	Ant2	5180	21.82	17.879	PASS
11A	Ant2	5200	21.92	17.828	PASS
11A	Ant2	5240	21.71	17.790	PASS
11A	Ant2	5745	17.29	17.687	PASS
11A	Ant2	5785	17.56	17.676	PASS
11A	Ant2	5825	17.56	17.705	PASS
11N20MIMO	Ant1	5180	21.20	17.689	PASS
11N20MIMO	Ant2	5180	21.31	17.732	PASS
11N20MIMO	Ant1	5200	21.00	17.731	PASS
11N20MIMO	Ant2	5200	21.01	17.704	PASS
11N20MIMO	Ant1	5240	21.17	17.694	PASS
11N20MIMO	Ant2	5240	21.00	17.654	PASS
11N20MIMO	Ant1	5745	17.63	17.658	PASS
11N20MIMO	Ant2	5745	17.34	17.631	PASS
11N20MIMO	Ant1	5785	17.56	17.629	PASS
11N20MIMO	Ant2	5785	17.57	17.643	PASS
11N20MIMO	Ant1	5825	17.56	17.594	PASS
11N20MIMO	Ant2	5825	17.20	17.654	PASS
11N40MIMO	Ant1	5190	42.40	36.426	PASS
11N40MIMO	Ant2	5190	41.54	36.316	PASS
11N40MIMO	Ant1	5230	43.35	36.269	PASS
11N40MIMO	Ant2	5230	40.98	36.307	PASS
11N40MIMO	Ant1	5755	36.31	36.301	PASS
11N40MIMO	Ant2	5755	35.54	36.250	PASS
11N40MIMO	Ant1	5795	35.66	36.270	PASS
11AC20MIMO	Ant1	5180	21.25	17.718	PASS
11AC20MIMO	Ant2	5180	20.86	17.699	PASS
11AC20MIMO	Ant1	5200	20.76	17.683	PASS
11AC20MIMO	Ant2	5200	20.85	17.700	PASS
11AC20MIMO	Ant1	5240	21.25	17.686	PASS
11AC20MIMO	Ant2	5240	21.24	17.709	PASS
11AC20MIMO	Ant1	5745	17.30	17.666	PASS
11AC20MIMO	Ant2	5745	17.57	17.639	PASS
11AC20MIMO	Ant1	5785	17.57	17.640	PASS
11AC20MIMO	Ant2	5785	17.55	17.621	PASS
11AC20MIMO	Ant1	5825	17.53	17.641	PASS

11AC20MIMO	Ant2	5825	17.60	17.659	PASS
11AC40MIMO	Ant1	5190	41.42	36.298	PASS
11AC40MIMO	Ant2	5190	42.51	36.342	PASS
11AC40MIMO	Ant1	5230	42.26	36.316	PASS
11AC40MIMO	Ant2	5230	41.69	36.232	PASS
11AC40MIMO	Ant1	5755	35.50	36.282	PASS
11AC40MIMO	Ant2	5755	35.94	36.217	PASS
11AC40MIMO	Ant1	5795	36.35	36.277	PASS
11AC40MIMO	Ant2	5795	36.31	36.249	PASS
11AC80MIMO	Ant1	5210	81.08	75.410	PASS
11AC80MIMO	Ant2	5210	84.02	75.447	PASS
11AC80MIMO	Ant1	5775	75.11	75.630	PASS
11AC80MIMO	Ant2	5775	73.82	75.639	PASS



**Test Graph**

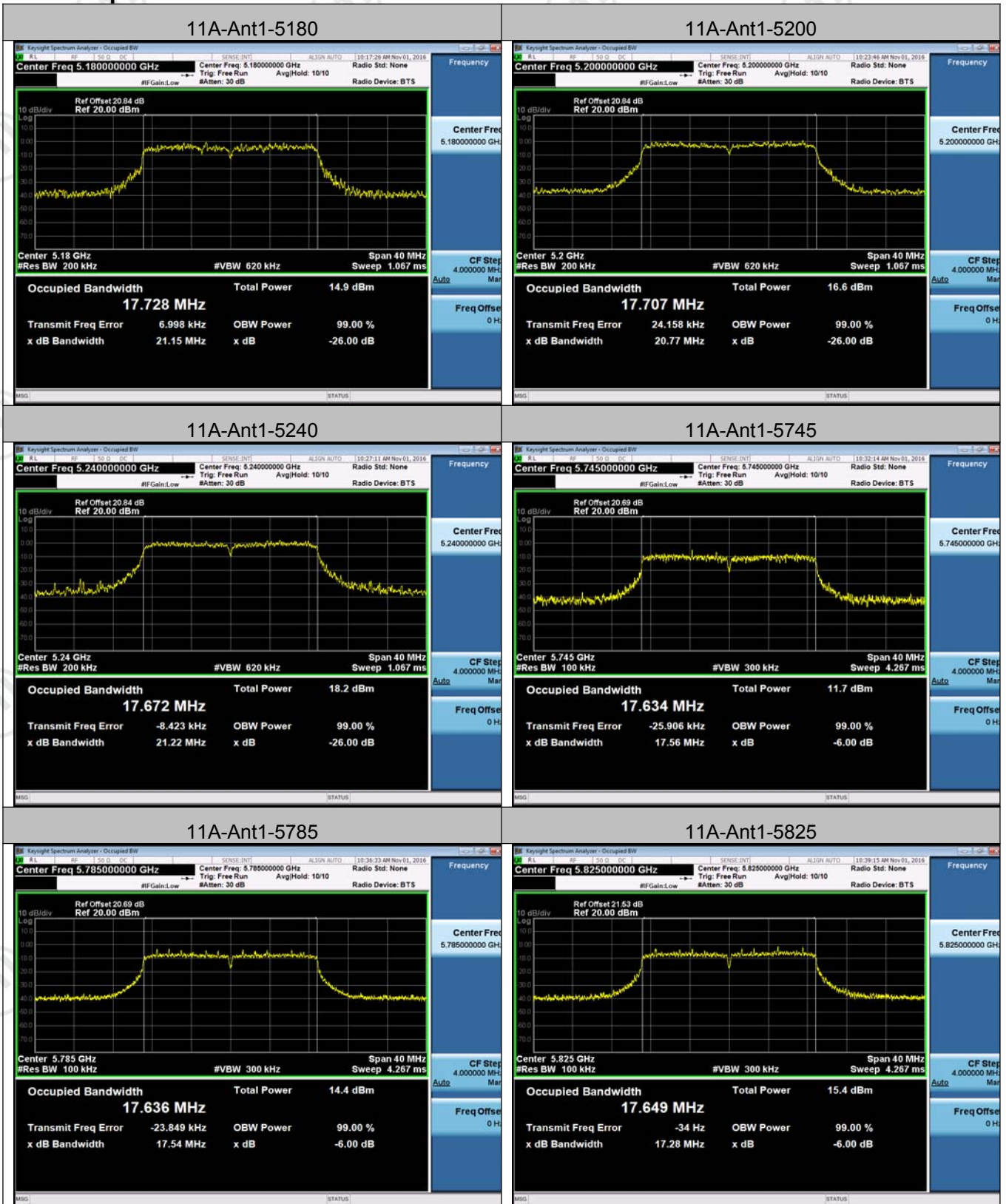

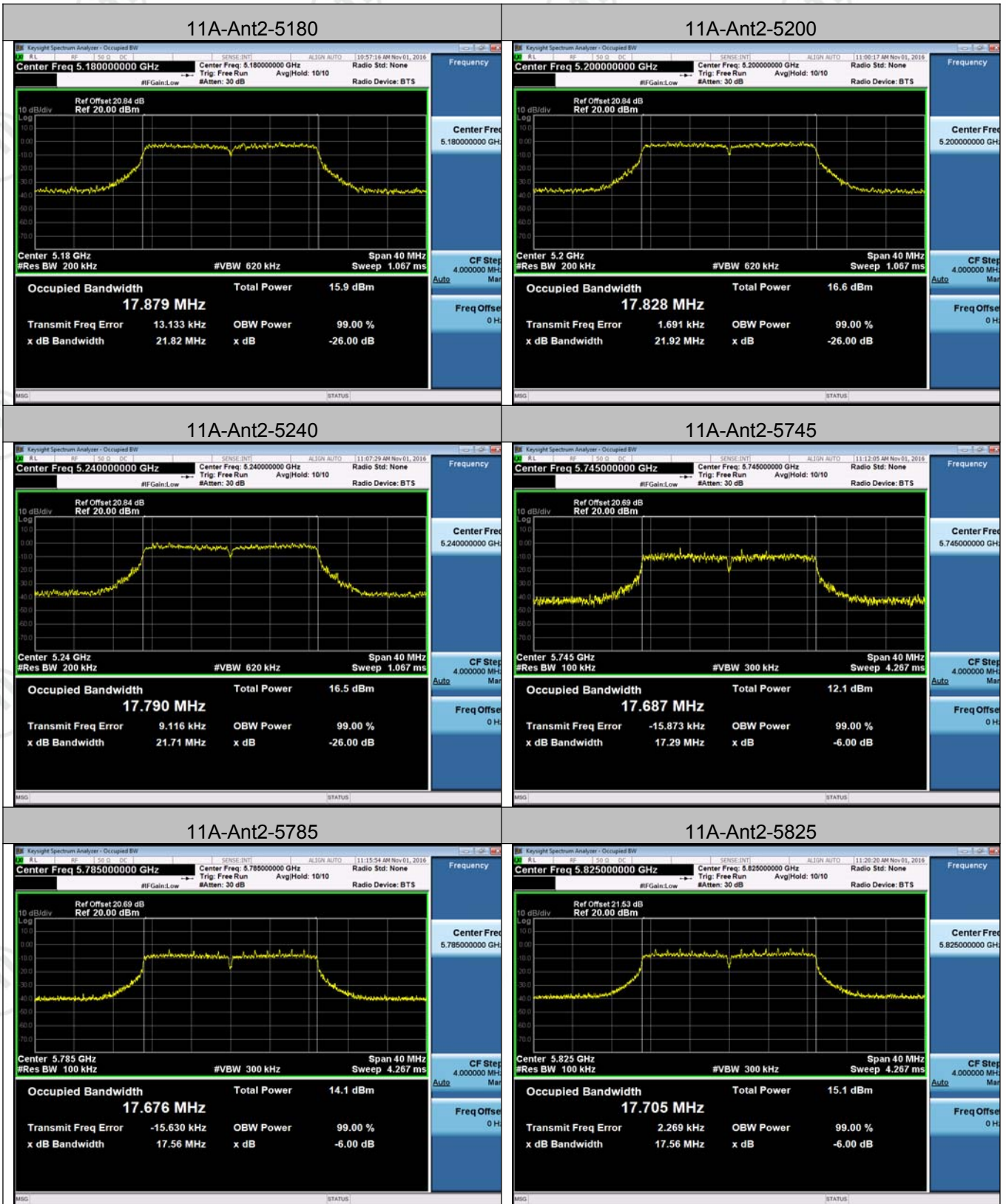

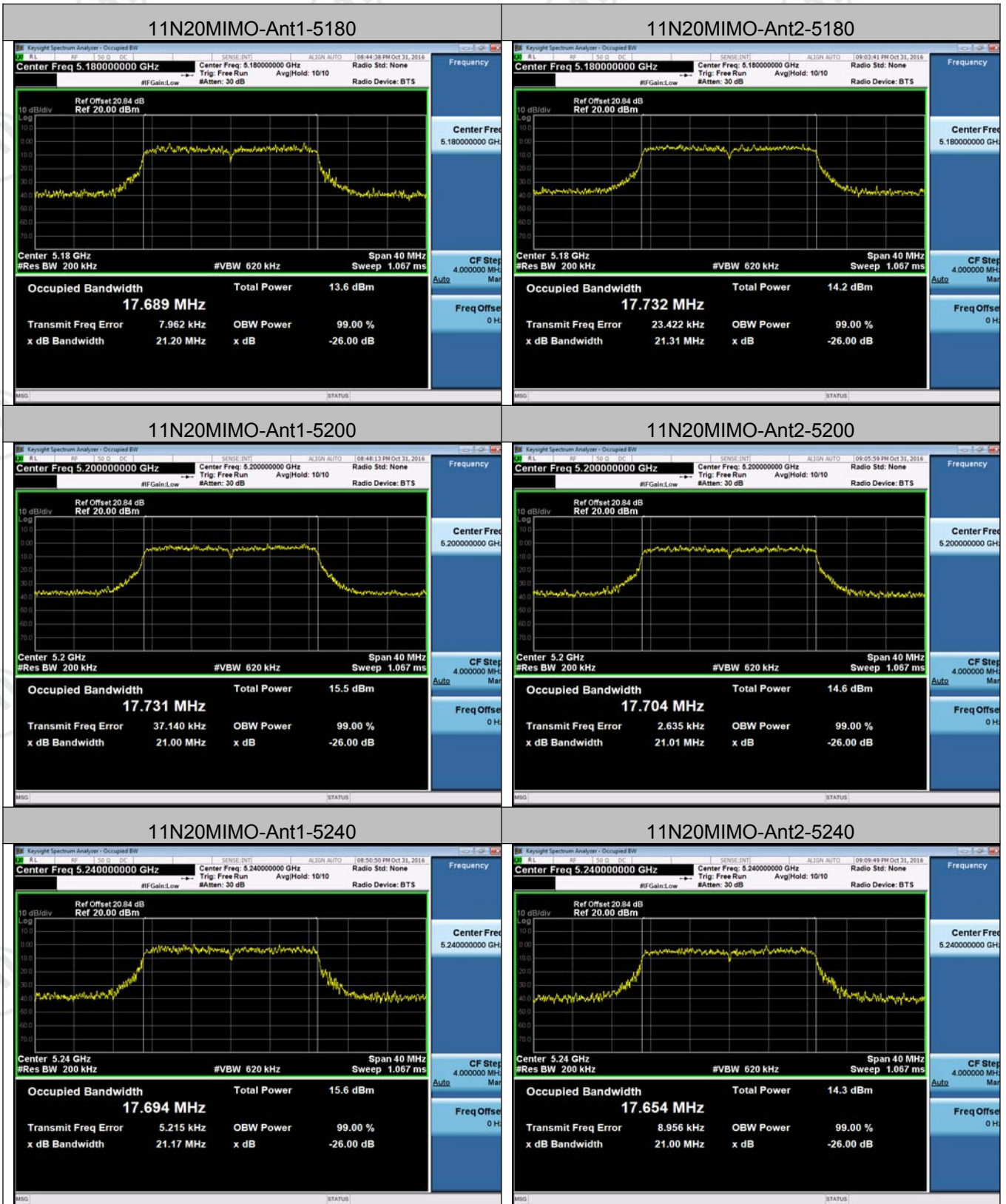

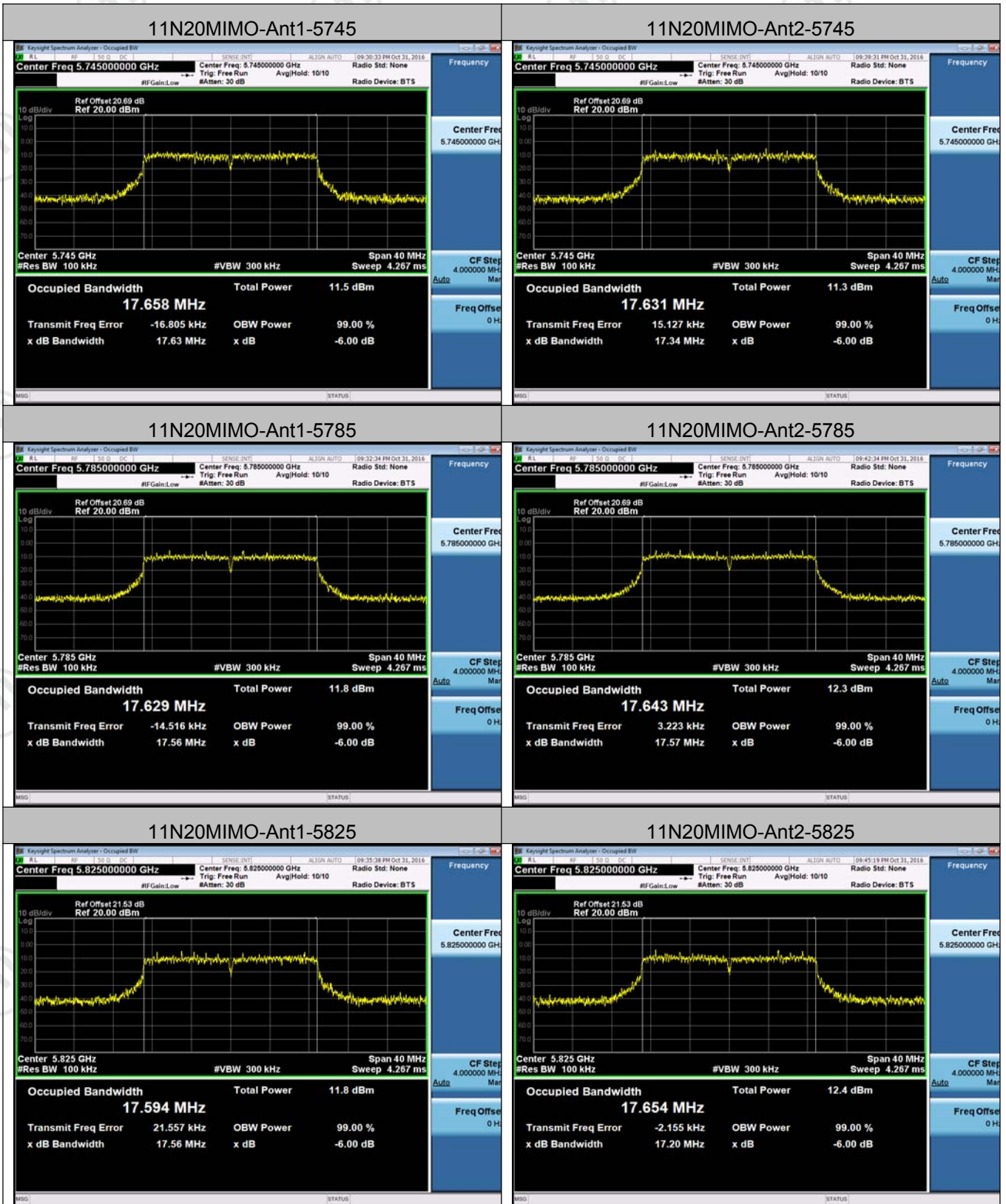

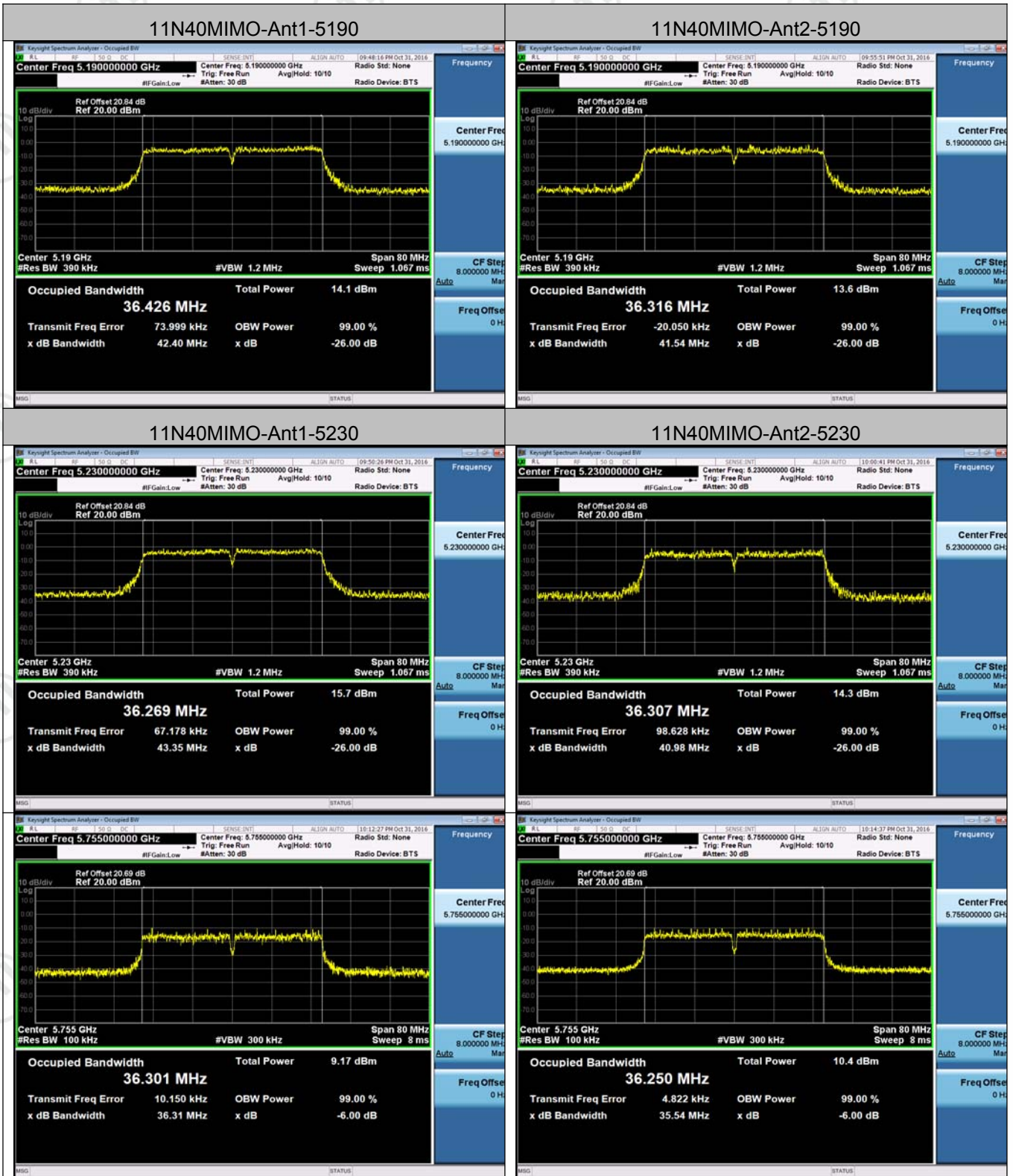

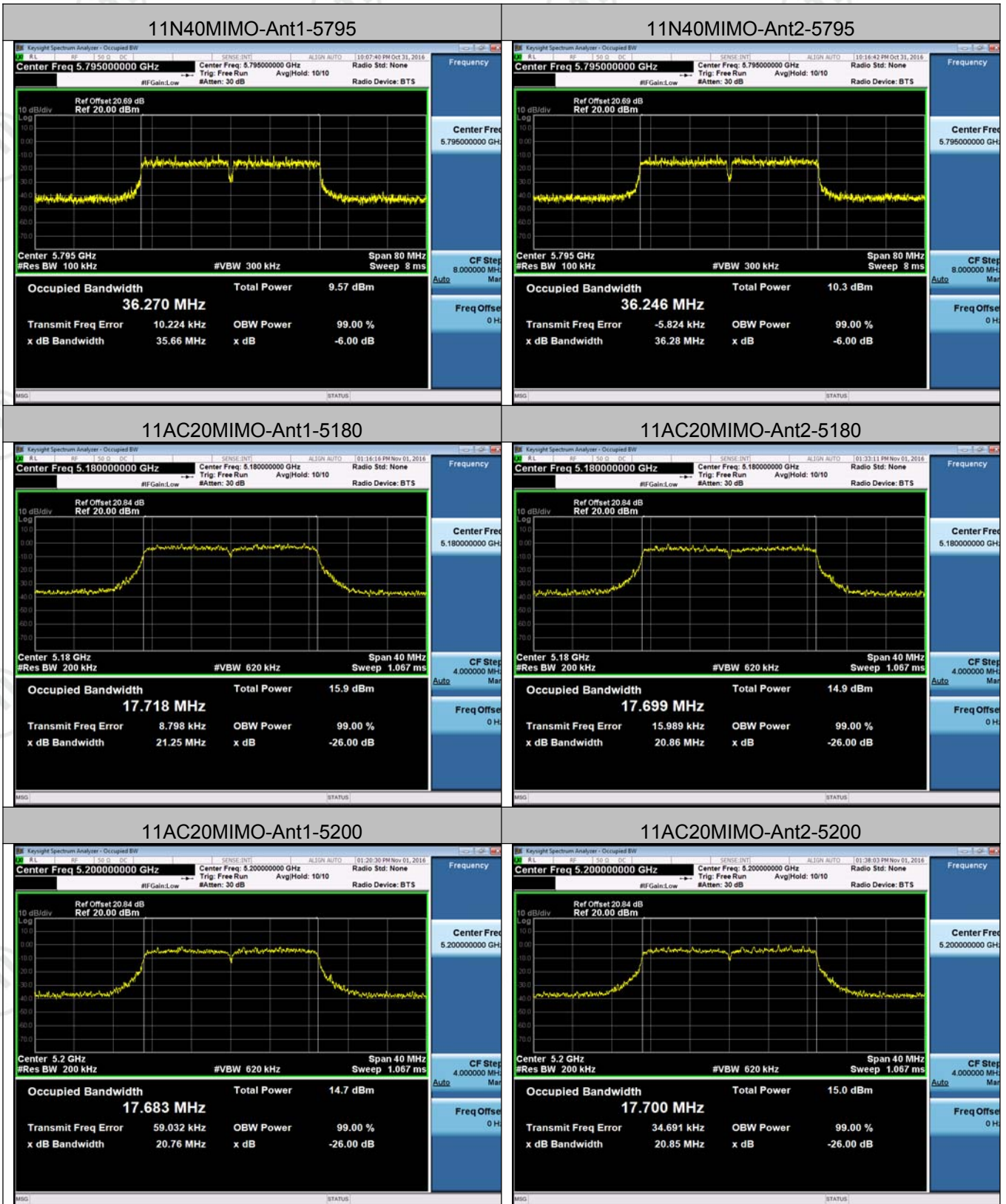

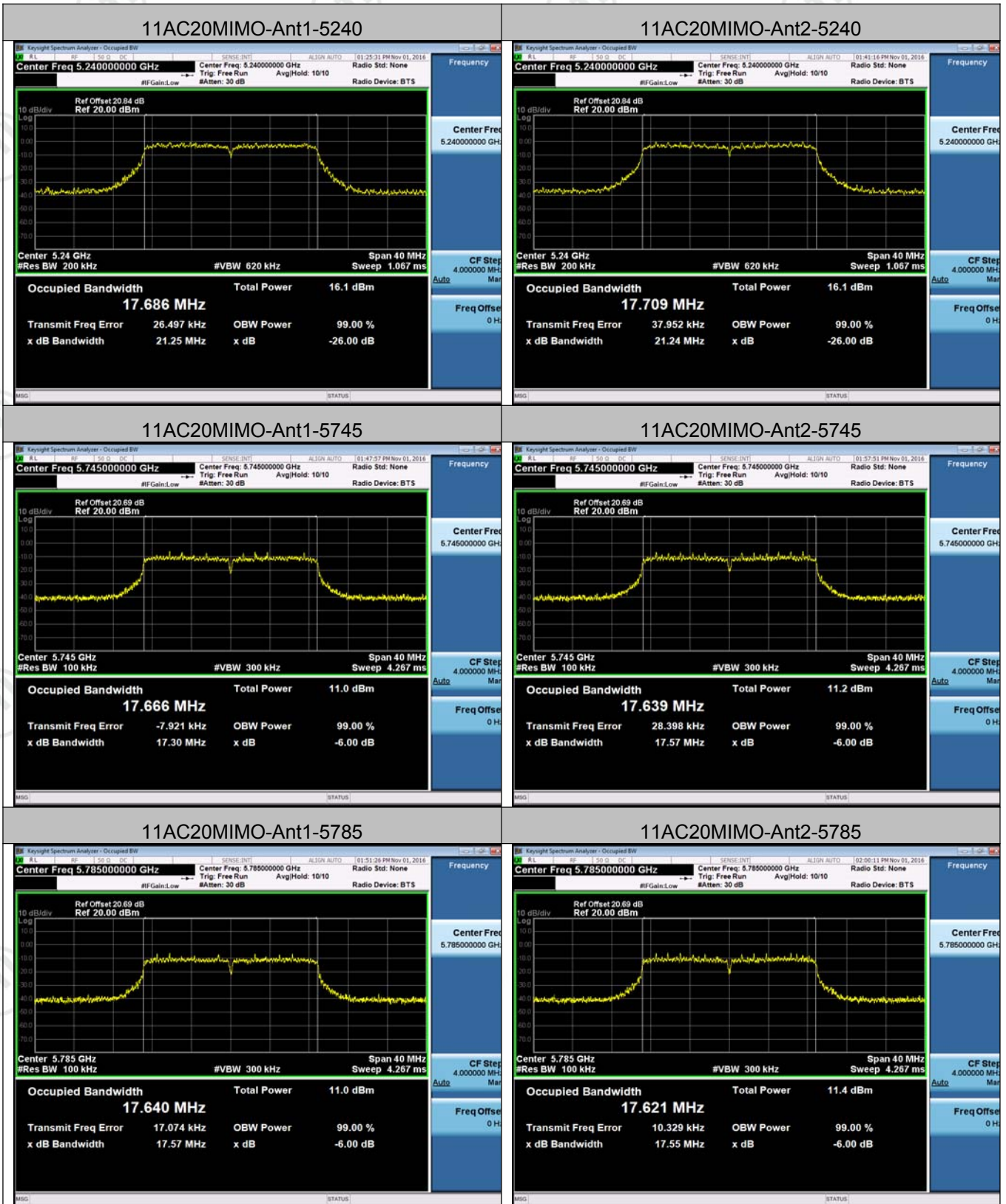

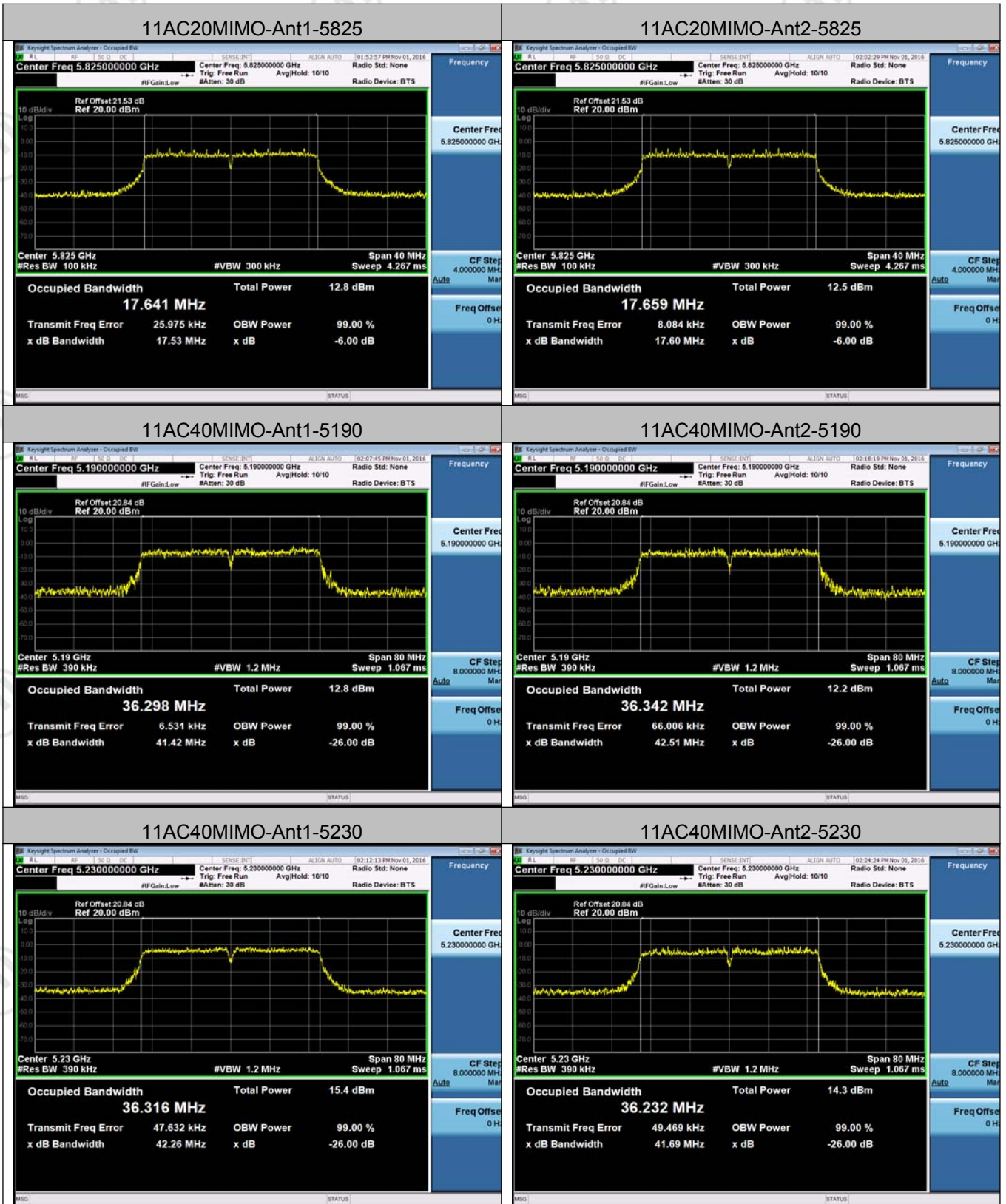



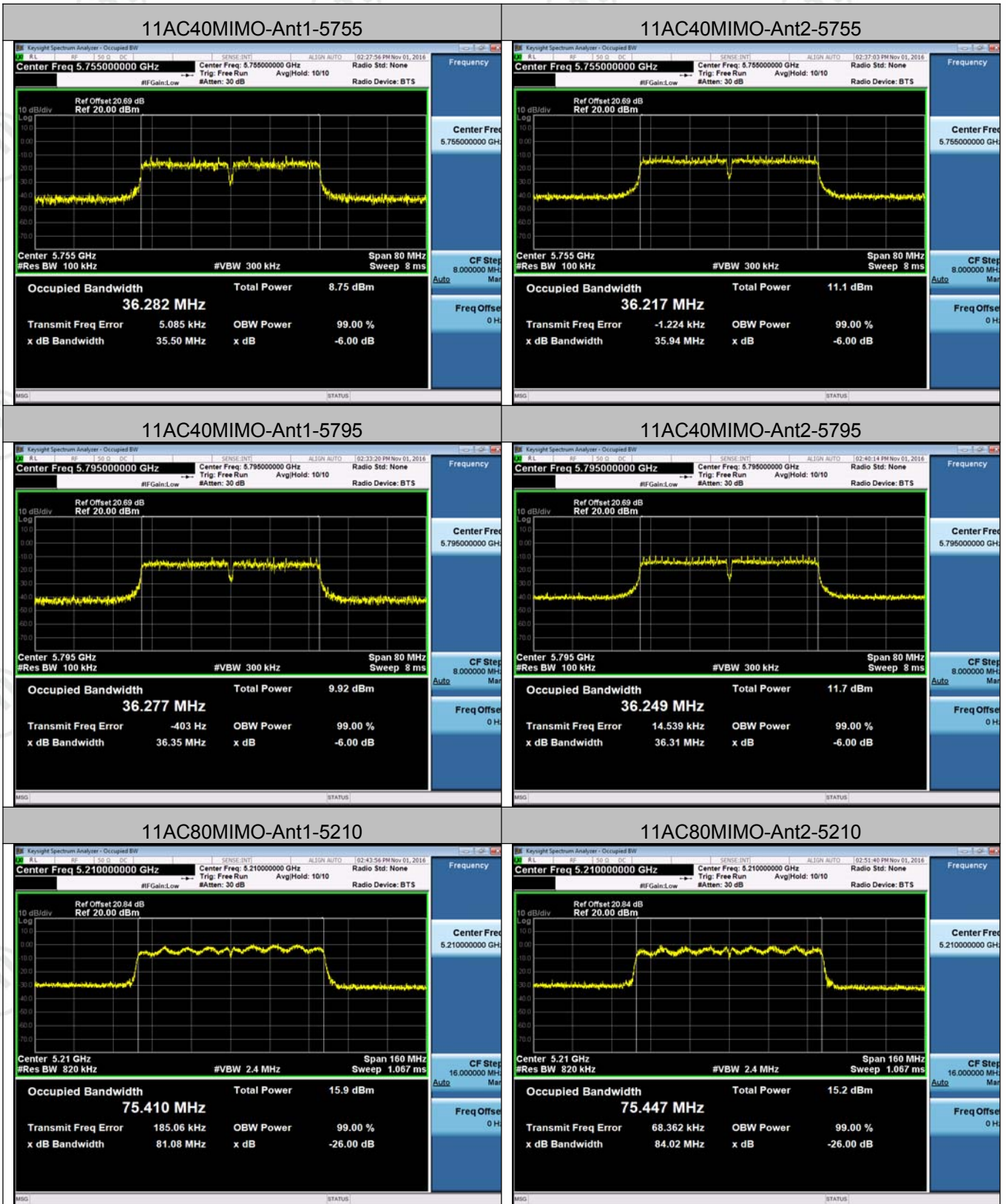

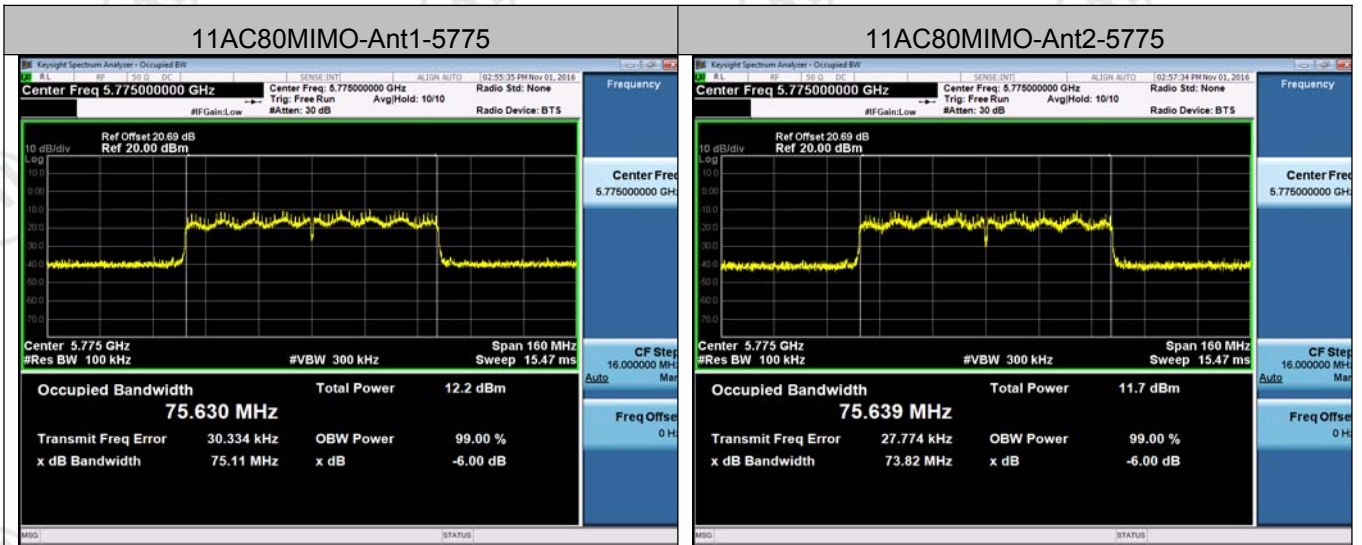

## Appendix B): Maximum Conduct Output Power

### Directional Antenna Gain

The TX chains are correlated, the antenna gain is equal among the chains.

Employs an antenna that operates simultaneously on multiple directional beams using the same frequency channels. No carrier aggregation techniques.

The directional gainis:

Antenna 0 Gain(dBi)	Antenna 0 Gain(dBi)	Correlated Chains Directional Gain(dBi)
3	3	6.01

### Duty Cycle

Test Mode	Channel	Duty Cycle[%]	Verdict
11ASISO	5200	100	PASS
11ASISO	5785	100	PASS
11N20SISO	5200	100	PASS
11N20SISO	5785	100	PASS
11N40SISO	5190	100	PASS
11N40SISO	5755	100	PASS
11N20MIMO	5200	100	PASS
11N20MIMO	5785	100	PASS
11N40MIMO	5190	100	PASS
11N40MIMO	5755	100	PASS
11AC20SISO	5200	100	PASS
11AC20SISO	5785	100	PASS
11AC40SISO	5190	100	PASS
11AC40SISO	5755	100	PASS
11AC80SISO	5210	100	PASS
11AC80SISO	5775	100	PASS
11AC20MIMO	5200	100	PASS
11AC20MIMO	5785	100	PASS
11AC40MIMO	5190	100	PASS
11AC40MIMO	5755	100	PASS
11AC80MIMO	5210	100	PASS
11AC80MIMO	5775	100	PASS

Duty Cycle Test Graph

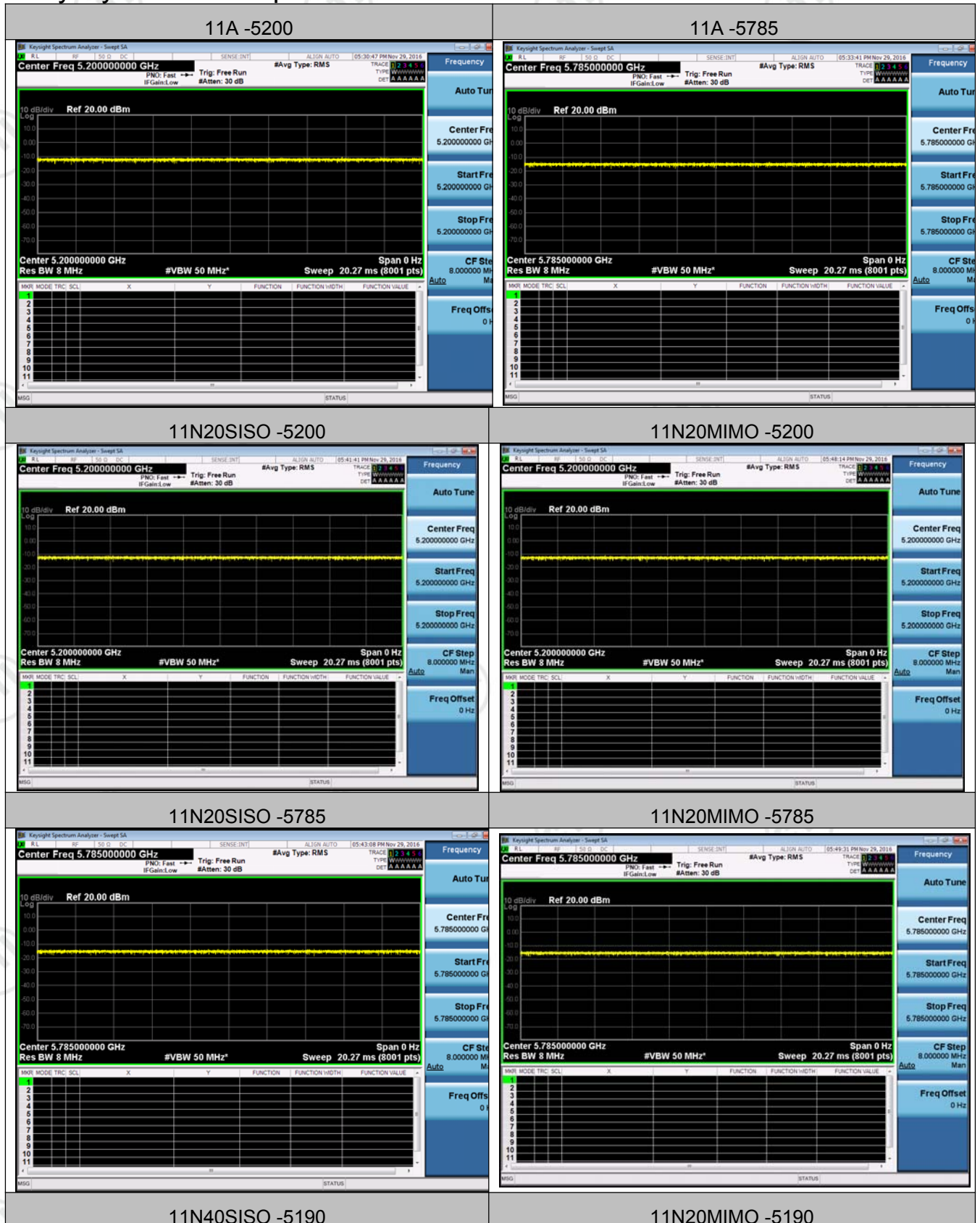

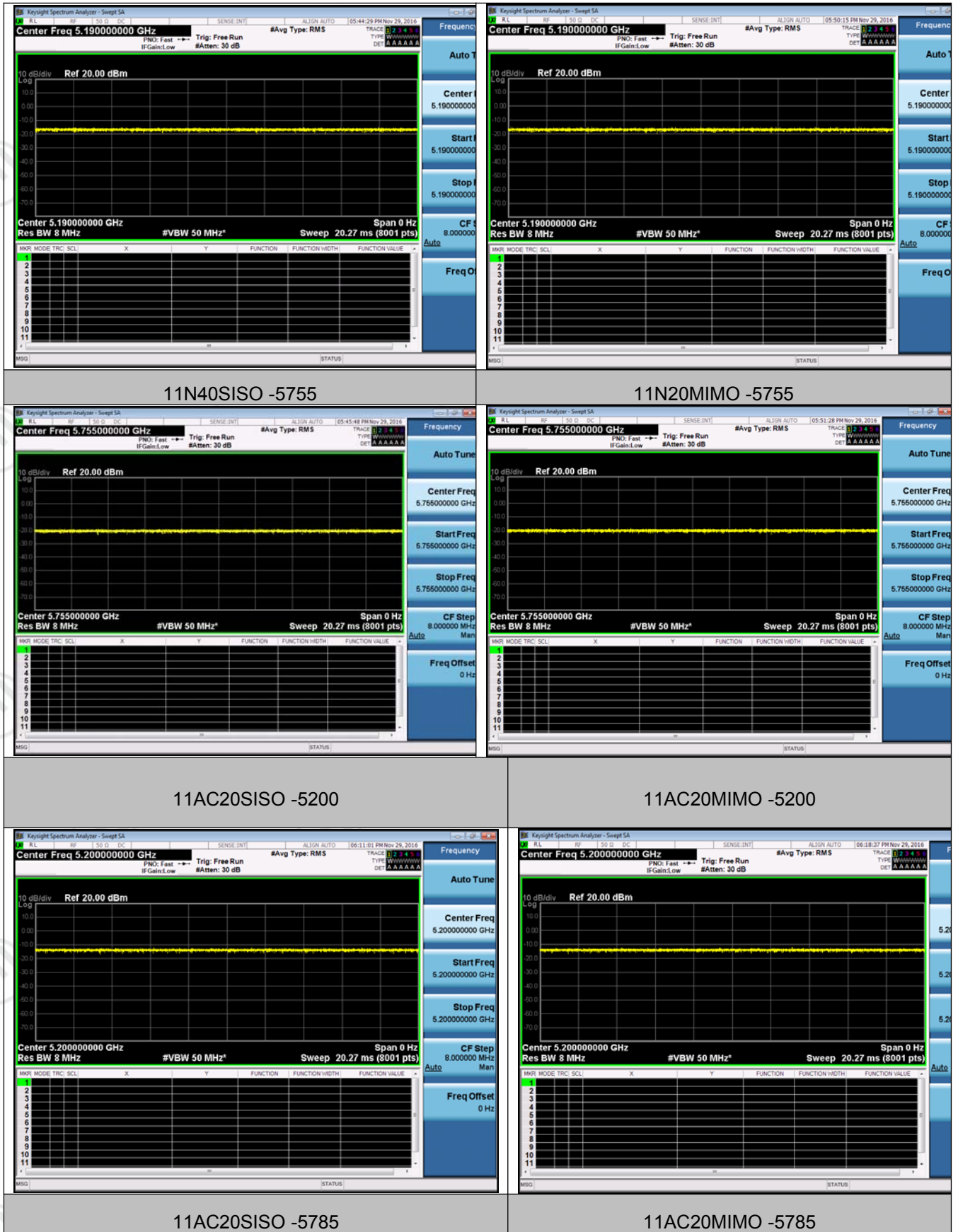

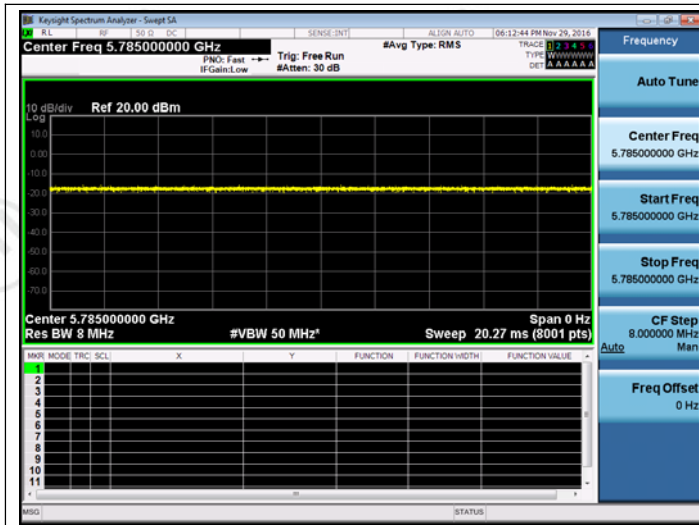

11AC40SISO -5190



11AC40MIMO -5190

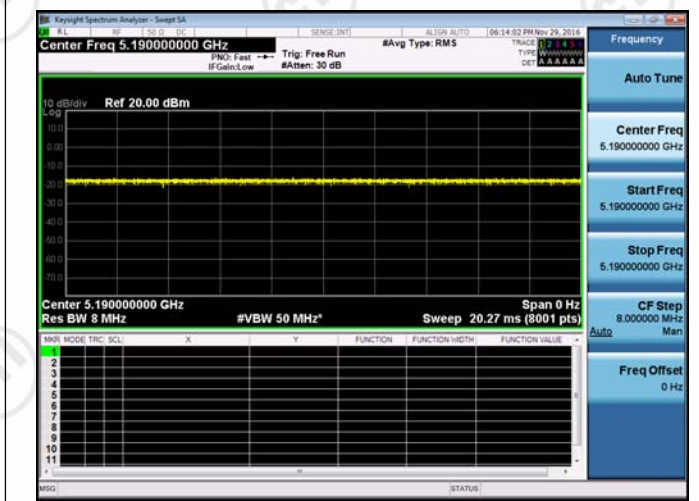

11AC40SISO -5755

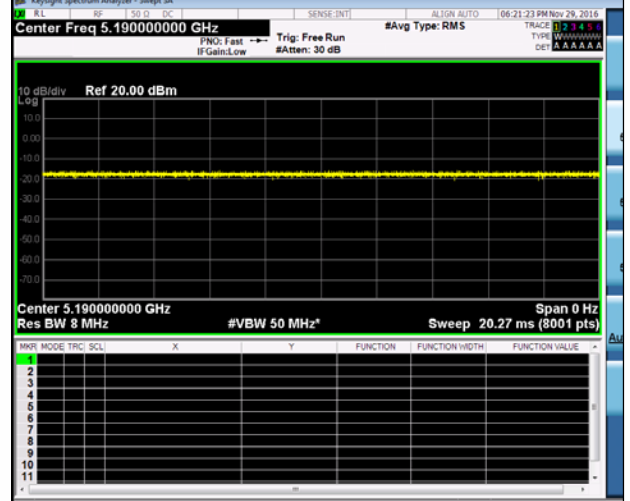

11AC40MIMO -5755

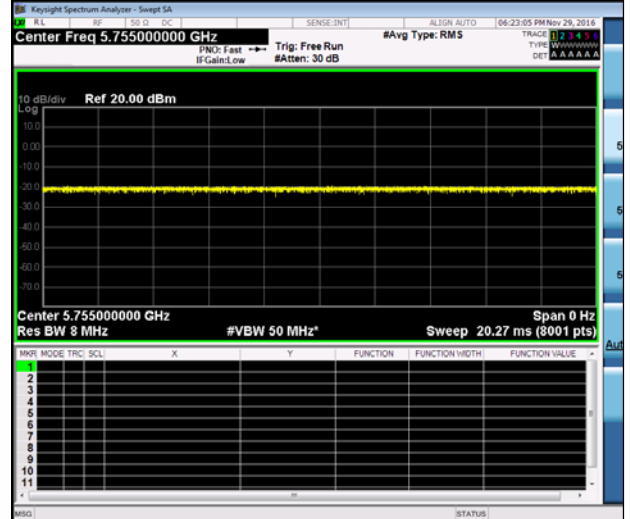
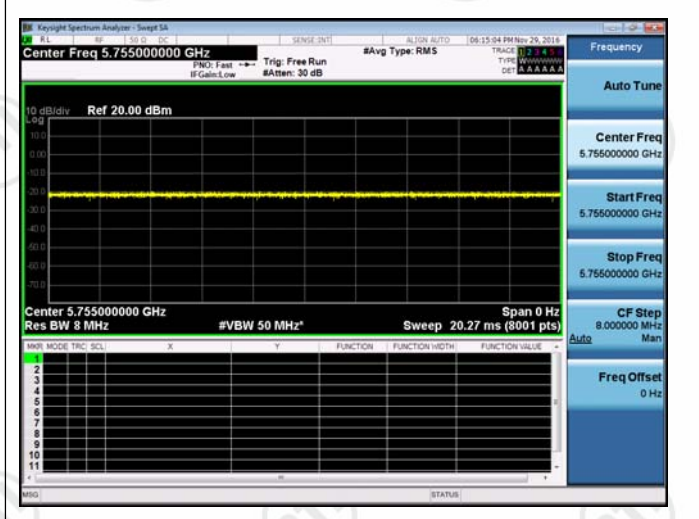

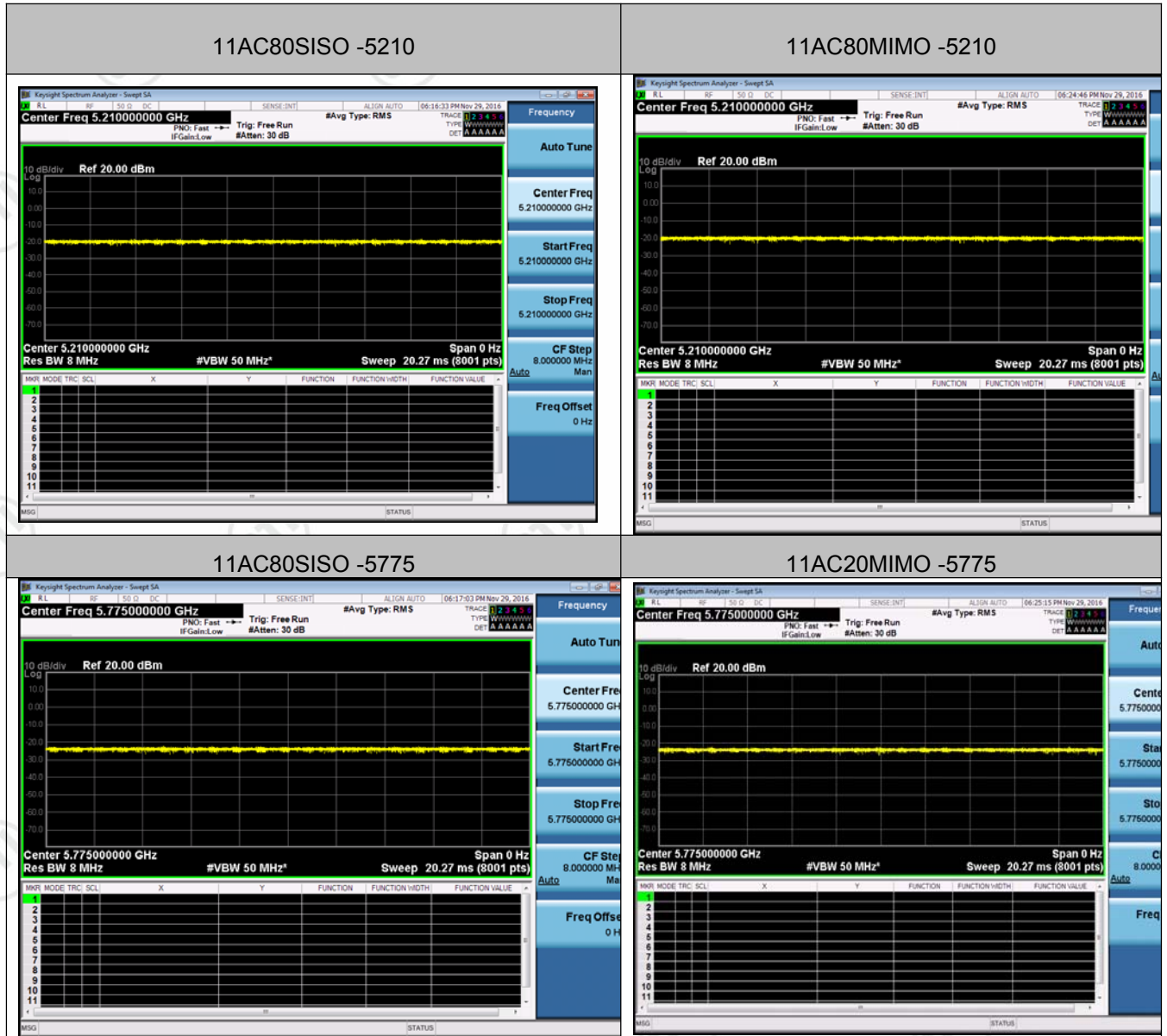

Test Mode	Antenna	Channel	Meas.Level [dBm]	Av.Power [dBm]	Verdict
11A	Ant1	5180	10.83	10.83	PASS
11A	Ant1	5200	11.69	11.69	PASS
11A	Ant1	5240	13.36	13.36	PASS
11A	Ant1	5745	7.37	7.37	PASS
11A	Ant1	5785	8.75	8.75	PASS
11A	Ant1	5825	10.31	10.31	PASS
11A	Ant2	5180	9.46	9.46	PASS
11A	Ant2	5200	10.03	10.03	PASS
11A	Ant2	5240	11.37	11.37	PASS
11A	Ant2	5745	7.08	7.08	PASS
11A	Ant2	5785	7.18	7.18	PASS
11A	Ant2	5825	8.23	8.23	PASS
11N20SISO	Ant1	5180	10.71	10.71	PASS
11N20SISO	Ant1	5200	11.22	11.22	PASS
11N20SISO	Ant1	5240	12.92	12.92	PASS
11N20SISO	Ant1	5745	7.14	7.14	PASS
11N20SISO	Ant1	5785	8.01	8.01	PASS
11N20SISO	Ant1	5825	9.85	9.85	PASS
11N20SISO	Ant2	5180	10.28	10.28	PASS
11N20SISO	Ant2	5200	11.15	11.15	PASS
11N20SISO	Ant2	5240	12.83	12.83	PASS
11N20SISO	Ant2	5745	7.15	7.15	PASS
11N20SISO	Ant2	5785	8.01	8.01	PASS
11N20SISO	Ant2	5825	9.4	9.4	PASS
11N20MIMO	Ant1	5180	11.48	11.48	PASS
11N20MIMO	Ant2	5180	11.01	11.01	PASS
11N20MIMO	Ant 1+2	5180	14.26	14.26	PASS
11N20MIMO	Ant1	5200	11.65	11.65	PASS
11N20MIMO	Ant2	5200	11.35	11.35	PASS
11N20MIMO	Ant 1+2	5200	14.51	14.51	PASS
11N20MIMO	Ant1	5240	13.14	13.14	PASS
11N20MIMO	Ant2	5240	13.57	13.57	PASS
11N20MIMO	Ant 1+2	5240	16.37	16.37	PASS
11N20MIMO	Ant1	5745	7.12	7.12	PASS
11N20MIMO	Ant2	5745	7.52	7.52	PASS
11N20MIMO	Ant 1+2	5745	10.33	10.33	PASS
11N20MIMO	Ant1	5785	6.55	6.55	PASS
11N20MIMO	Ant2	5785	7.24	7.24	PASS
11N20MIMO	Ant 1+2	5785	9.92	9.92	PASS
11N20MIMO	Ant1	5825	8.6	8.6	PASS
11N20MIMO	Ant2	5825	8.31	8.31	PASS
11N20MIMO	Ant 1+2	5825	11.47	11.47	PASS
11N40SISO	Ant1	5190	9.96	9.96	PASS



11N40SISO	Ant1	5230	11.59	11.59	PASS
11N40SISO	Ant1	5795	7.54	7.54	PASS
11N40SISO	Ant1	5755	8.74	8.74	PASS
11N40SISO	Ant2	5190	9.53	9.53	PASS
11N40SISO	Ant2	5230	11.23	11.23	PASS
11N40SISO	Ant2	5755	7.95	7.95	PASS
11N40SISO	Ant2	5795	7.61	7.61	PASS
11N40MIMO	Ant1	5190	9.32	9.32	PASS
11N40MIMO	Ant2	5190	9.6	9.6	PASS
11N40MIMO	Ant 1+2	5190	12.47	12.47	PASS
11N40MIMO	Ant1	5230	10.98	10.98	PASS
11N40MIMO	Ant2	5230	10.35	10.35	PASS
11N40MIMO	Ant 1+2	5230	13.69	13.69	PASS
11N40MIMO	Ant1	5755	6.44	6.44	PASS
11N40MIMO	Ant2	5755	6.48	6.48	PASS
11N40MIMO	Ant 1+2	5755	9.47	9.47	PASS
11N40MIMO	Ant1	5795	6.57	6.57	PASS
11N40MIMO	Ant2	5795	6.19	6.19	PASS
11N40MIMO	Ant 1+2	5795	9.39	9.39	PASS
11AC20SISO	Ant1	5180	10.07	10.07	PASS
11AC20SISO	Ant2	5180	10.23	10.23	PASS
11AC20SISO	Ant1	5200	10.69	10.69	PASS
11AC20SISO	Ant2	5200	10.38	10.38	PASS
11AC20SISO	Ant1	5240	12.45	12.45	PASS
11AC20SISO	Ant2	5240	12.28	12.28	PASS
11AC20SISO	Ant1	5745	8.01	8.01	PASS
11AC20SISO	Ant2	5745	8.38	8.38	PASS
11AC20SISO	Ant1	5785	7.47	7.47	PASS
11AC20SISO	Ant2	5785	7.3	7.3	PASS
11AC20SISO	Ant1	5825	8.51	8.51	PASS
11AC20SISO	Ant2	5825	8.43	8.43	PASS
11AC20MIMO	Ant1	5180	11.1	11.1	PASS
11AC20MIMO	Ant2	5180	10.41	10.41	PASS
11AC20MIMO	Ant 1+2	5180	13.78	13.78	PASS
11AC20MIMO	Ant1	5200	11.83	11.83	PASS
11AC20MIMO	Ant2	5200	10.84	10.84	PASS
11AC20MIMO	Ant 1+2	5200	14.37	14.37	PASS
11AC20MIMO	Ant1	5240	13.3	13.3	PASS
11AC20MIMO	Ant2	5240	13.85	13.85	PASS
11AC20MIMO	Ant 1+2	5240	16.59	16.59	PASS
11AC20MIMO	Ant1	5745	7.34	7.34	PASS
11AC20MIMO	Ant2	5745	7.75	7.75	PASS
11AC20MIMO	Ant 1+2	5745	10.56	10.56	PASS
11AC20MIMO	Ant1	5785	8.3	8.3	PASS
11AC20MIMO	Ant2	5785	7.63	7.63	PASS

11AC20MIMO	Ant 1+2	5785	10.99	10.99	PASS
11AC20MIMO	Ant1	5825	9.8	9.8	PASS
11AC20MIMO	Ant2	5825	10.23	10.23	PASS
11AC20MIMO	Ant 1+2	5825	13.03	13.03	PASS
11AC40SISO	Ant1	5190	9.47	9.47	PASS
11AC40SISO	Ant2	5190	9.8	9.8	PASS
11AC40SISO	Ant1	5755	7.57	7.57	PASS
11AC40SISO	Ant2	5755	7.57	7.57	PASS
11AC40SISO	Ant1	5795	8.67	8.67	PASS
11AC40SISO	Ant2	5795	7.69	7.69	PASS
11AC40MIMO	Ant1	5190	8.97	8.97	PASS
11AC40MIMO	Ant2	5190	8.72	8.72	PASS
11AC40MIMO	Ant 1+2	5190	11.86	11.86	PASS
11AC40MIMO	Ant1	5230	10.72	10.72	PASS
11AC40MIMO	Ant2	5230	9.72	9.72	PASS
11AC40MIMO	Ant 1+2	5230	13.26	13.26	PASS
11AC40MIMO	Ant1	5755	6.42	6.42	PASS
11AC40MIMO	Ant2	5755	6.35	6.35	PASS
11AC40MIMO	Ant 1+2	5755	9.40	9.40	PASS
11AC40MIMO	Ant1	5795	7.28	7.28	PASS
11AC40MIMO	Ant2	5795	6.89	6.89	PASS
11AC40MIMO	Ant 1+2	5795	10.10	10.10	PASS
11AC80SISO	Ant1	5210	9.29	9.29	PASS
11AC80SISO	Ant2	5210	9.06	9.06	PASS
11AC80SISO	Ant1	5775	7.84	7.84	PASS
11AC80SISO	Ant2	5775	7.64	7.64	PASS
11AC80MIMO	Ant1	5210	7.9	7.9	PASS
11AC80MIMO	Ant2	5210	7.05	7.05	PASS
11AC80MIMO	Ant 1+2	5210	10.51	10.51	PASS
11AC80MIMO	Ant1	5775	4.44	4.44	PASS
11AC80MIMO	Ant2	5775	4.68	4.68	PASS
11AC80MIMO	Ant 1+2	5775	7.49	7.49	PASS

**Test Graph**

