

# VC320 All-in-one Portable Conference Camera

## Package Contents

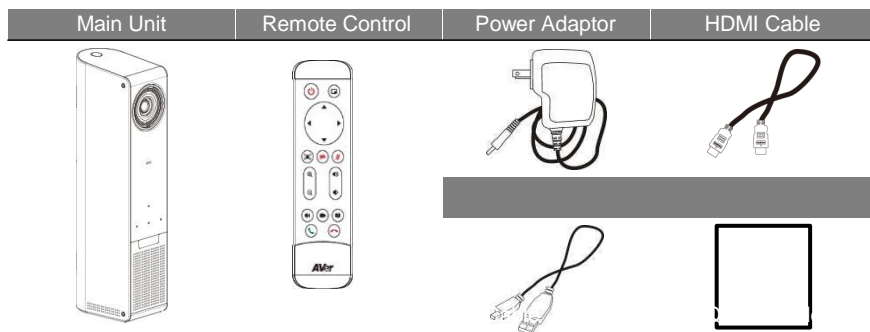

## Overview

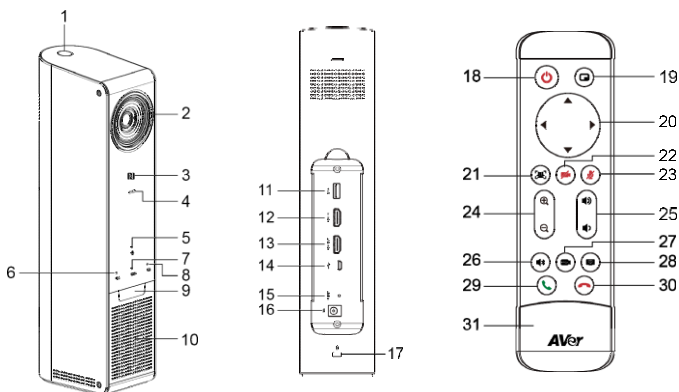

- 1 Power on/off button & LED
- 2 Camera with  $\pm 10$  degree tilting
- 3 NFC
- 4 Microphone
- 5 Mute and mute LED
- 6 Bluetooth and status LED
- 7 USB and status LED
- 8 Presentation and status LED
- 9 IR receiver
- 10 Speaker

- 11 2.1A
- 12 HDMI input
- 13 HDMI output
- 14 USB to PC/Mac
- 15 Reset
- 16 Power
- 17 Kensington lock

- 18 Power
- 19 Layout
- 20 Pan and tilt
- 21 EZCrop
- 22 Camera privacy shutter
- 23 Mute microphone
- 24 Zoom in and out
- 25 Volume up and down
- 26 Bluetooth mode
- 27 Video conference mode
- 28 Presentation mode
- 29 Make/Answer call
- 30 Hang up call
- 31 Battery compartment cover

## Installation Steps

1. VC320 comes with rechargeable battery, connect external power, charge 8 hours till LED steady orange
2. Connect USB
3. Connect HDMI if you want to use Presentation mode. Select TV source to correct HDMI.

## Start using VC320

1. Press power button, when VC320 is ready, LED turns green/blue and a tone is played.
2. Select usage mode by pressing mode button on unit or remote control. Follow instructions.
3. Video conference mode: Open PC or Mac communication app, select VC320 camera and audio.
4. Bluetooth mode: connect to mobile device by NFC or hold Bluetooth over 3 seconds for pairing to new device (enable Bluetooth on mobile device, scan, select AVer handsfree). A paired tone will be played.
5. Presentation mode: display HDMI input on TV. You can combine it with Bluetooth and Video conference mode.

In Bluetooth mode, users can turn on NFC function on mobile device, touch VC320 N logo to pair to VC320.

## Quick Reference

Camera Electronic Pan and Tilt  on remote control or push camera upward/downward

manually 

 In Video Conference mode, EZCrop automatically crops camera video to fill faces detected into frame, drawing wide with 4 faces, effect after EZCrop\*\*

 In Video Conference mode, Camera Privacy Shutter stops live camera, similar to close camera shutter.

 In Video Conference and Presentation modes, Layout switches or mixes HDMI or camera input(s) to HDMI or USB output for best local and remote collaboration usage scenario.

 Power LED: blinking amber: charging; steady amber: charge complete; blink green/blue: powering up; steady green/blue: powered up

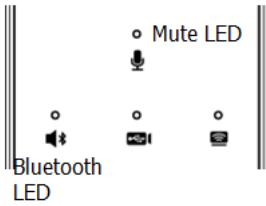

Mute, Bluetooth, Video Conference, Presentation buttons are capacitor touch sensitive

Status LEDs are right above the button

Mute: blue: unmute; red: mute

Bluetooth: white: on; blinking white: pairing; dark: off

Video conference: white: on; dark: off

Presentation: blue on; dark off

**Note:**

VC320 is a Plug-n-Play Conference Camera for small, huddle to mid conference room. The system requires no special drivers. But we highly recommend installing the AVer PTZ app for the best user experience.

Please visit [averusa.com/video-collaboration](https://www.averusa.com/video-collaboration) for more information.

VC320 contains built-in Li-ion rechargeable battery and Bluetooth radio; please reference safety instruction and FCC conditions on [averusa.com/video-collaboration](https://www.averusa.com/video-collaboration).

## **Federal Communication Commission Interference Statement**



This device complies with Part 15 of the FCC Rules. Operation is subject to the following two conditions: (1) This device may not cause harmful interference, and (2) this device must accept any interference received, including interference that may cause undesired operation.

This equipment has been tested and found to comply with the limits for a Class B digital device, pursuant to Part 15 of the FCC Rules. These limits are designed to provide reasonable protection against harmful interference in a residential installation. This equipment generates, uses and can radiate radio frequency energy and, if not installed and used in accordance with the instructions, may cause harmful interference to radio communications. However, there is no guarantee that interference will not occur in a particular installation. If this equipment does cause harmful interference to radio or television reception, which can be determined by turning the equipment off and on, the user is encouraged to try to correct the interference by one of the following measures:

- Reorient or relocate the receiving antenna.
- Increase the separation between the equipment and receiver.
- Connect the equipment into an outlet on a circuit different from that to which the receiver is connected.
- Consult the dealer or an experienced radio/TV technician for help.

**FCC Caution:** Any changes or modifications not expressly approved by the party responsible for compliance could void the user's authority to operate this equipment.

This transmitter must not be co-located or operating in conjunction with any other antenna or transmitter.

### **Radiation Exposure Statement:**

This equipment complies with FCC radiation exposure limits set forth for an uncontrolled environment. This equipment should be installed and operated with minimum distance 20cm between the radiator & your body.

### **Industry Canada statement:**

This device complies with ISSED's licence-exempt RSSs. Operation is subject to the following two conditions: (1) This device may not cause harmful interference, and (2) this device must accept any interference received, including interference that may cause undesired operation.

Le présent appareil est conforme aux CNR d' ISSED applicables aux appareils radio exempts de licence. L'exploitation est autorisée aux deux conditions suivantes : (1) le dispositif ne doit pas produire de brouillage préjudiciable, et (2) ce dispositif doit accepter tout brouillage reçu, y compris un brouillage susceptible de provoquer un fonctionnement indésirable.

### **Radiation Exposure Statement:**

This equipment complies with ISSED radiation exposure limits set forth for an uncontrolled environment. This equipment should be installed and operated with minimum distance 20cm between the radiator & your body.

### **Déclaration d'exposition aux radiations:**

Cet équipement est conforme aux limites d'exposition aux rayonnements ISSED établies pour un environnement non contrôlé. Cet équipement doit être installé et utilisé avec un minimum de 20 cm de distance entre la source de rayonnement et votre corps.

#### 低功率電波輻射性電機管理辦法

第十二條經型式認證合格之低功率射頻電機，非經許可，公司、商號或使用者均不得擅自變更頻率、加大功率或變更原設計之特性及功能。

第十四條低功率射頻電機之使用不得影響飛航安全及干擾合法通信；經發現有干擾現象時，應立即停用，並改善至無干擾時方得繼續使用。

前項合法通信，指依電信法規定作業之無線電通信。

低功率射頻電機須忍受合法通信或工業、科學及醫療用電波輻射性電機設備之干擾。

この装置は、クラスB情報技術装置です。この装置は、家庭環境で使用することを目的としていますが、この装置がラジオやテレビジョン受信機に近接して使用されると、受信障害を引き起こすことがあります。取扱説明書に従って正しい取り扱いをして下さい。V C C I - B

#### CAUTION

Risk of explosion if battery is replaced by an incorrect type.

Dispose of used batteries in a safe and proper manner.

