

FCC ID: 2AHDGPW00U  
Report No.: T190322W01-RP3-1

ISED: 21367-PW00U  
Ref. No.: T190315W01-RP3

Page: 1 / 87  
Rev.: 01

# RADIO TEST REPORT

## FCC 47 CFR PART 15 SUBPART C

### INDUSTRY CANADA RSS-247

Test Standard	FCC Part 15.247 IC RSS-247 issue 2 and IC RSS-GEN issue 5
Brand name	AVer Dual Band Wirelss Dongle
Product name	AVer
Model No.	PW00U
Test Result	Pass
Statements of Conformity	Determination of compliance is based on the results of the compliance measurement, not taking into account measurement instrumentation uncertainty.

The test Result was tested by Compliance Certification Services Inc. The test data, data evaluation, test procedures, and equipment configurations shown in this report were given in ANSI C63.10: 2013 and compliance standards.

The test results of this report relate only to the tested sample (EUT) identified in this report.

The test Report of full or partial shall not copy. Without written approval of Compliance Certification Services Inc. (Wugu Laboratory).

Approved by:

Tested by:



Kevin Tsai  
Deputy Manager

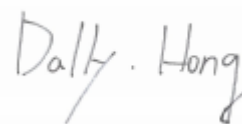

Dally Hong  
Engineer

Unless otherwise stated the results shown in this test report refer only to the sample(s) tested and such sample(s) are retained for 90 days only.  
除非另有說明，此報告結果僅對測試之樣品負責，同時此樣品僅保留90天。本報告未經本公司書面許可，不可部分複製。

This document is issued by the Company subject to its General Conditions of Service printed overleaf, available on request or accessible at [www.sgs.com/terms\\_and\\_conditions.htm](http://www.sgs.com/terms_and_conditions.htm) and for electronic format documents, subject to Terms and Conditions for Electronic Documents at [www.sgs.com/terms\\_e-document.htm](http://www.sgs.com/terms_e-document.htm). Attention is drawn to the limitation of liability, indemnification and jurisdiction issues defined therein. Any holder of this document is advised that information contained hereon reflects the Company's findings at the time of its intervention only and within the limits of Client's instructions, if any. The Company's sole responsibility is to its Client and this document does not exonerate parties to a transaction from exercising all their rights and obligations under the transaction documents. This document cannot be reproduced except in full, without prior written approval of the Company. Any unauthorized alteration, forgery or falsification of the content or appearance of this document is unlawful and offenders may be prosecuted to the fullest extent of the law.

## Revision History

Rev.	Issue Date	Revisions	Effect Page	Revised By
00	June 17, 2019	Initial Issue	ALL	May Lin
01	June 26, 2019	See the following Note Rev. (01)	P.49-50	May Lin

*Rev (01):*

1. *Revised the test limit.*

## Table of contents

<b>1.</b>	<b>GENERAL INFORMATION.....</b>	<b>4</b>
1.1	EUT INFORMATION.....	4
1.2	EUT CHANNEL INFORMATION.....	5
1.3	ANTENNA INFORMATION.....	5
1.4	MEASUREMENT UNCERTAINTY .....	6
1.5	FACILITIES AND TEST LOCATION.....	7
1.6	INSTRUMENT CALIBRATION .....	8
1.7	SUPPORT AND EUT ACCESSORIES EQUIPMENT .....	9
1.8	TEST METHODOLOGY AND APPLIED STANDARDS.....	9
<b>2.</b>	<b>TEST SUMMERY .....</b>	<b>10</b>
<b>3.</b>	<b>DESCRIPTION OF TEST MODES.....</b>	<b>11</b>
3.1	THE WORST MODE OF OPERATING CONDITION .....	11
3.2	THE WORST MODE OF MEASUREMENT.....	12
<b>4.</b>	<b>EUT DUTY CYCLE .....</b>	<b>13</b>
<b>5.</b>	<b>TEST RESULT .....</b>	<b>14</b>
5.1	AC POWER LINE CONDUCTED EMISSION.....	14
5.2	6dB BANDWIDTH AND OCCUPIED BANDWIDTH(99%).....	17
5.3	OUTPUT POWER MEASUREMENT .....	27
5.4	POWER SPECTRAL DENSITY .....	30
5.5	CONDUCTED BANDEGE AND SPURIOUS EMISSION.....	36
5.6	RADIATION BANDEGE AND SPURIOUS EMISSION.....	49
	APPENDIX-A TEST PHOTO.....	A-1
	APPENDIX 1 - PHOTOGRAPHS OF EUT	

## 1. GENERAL INFORMATION

### 1.1 EUT INFORMATION

Applicant	AVer Information Inc. 8F., No.157, Da-An Rd., Tucheng Dist, New Taipei City, Taiwan		
Manufacturer	AVer Information Inc. 8F., No.157, Da-An Rd., Tucheng Dist, New Taipei City, Taiwan		
Equipment	AVer Dual Band Wirelss Dongle		
Model Name	PW00U		
Model Discrepancy	N/A		
Trade Name	AVer		
Received Date	March 15, 2019		
Date of Test	March 26 ~ June 14, 2019		
Output Power(W)	<b>Mode</b>	<b>Output Power (W)</b>	<b>EIRP Output Power (W)</b>
	IEEE 802.11b Mode	0.2938	0.7638
	IEEE 802.11g Mode	0.2541	0.6607
	IEEE 802.11n HT20 Mode	0.2692	0.6998
	IEEE 802.11n HT40 Mode	0.2710	0.7047
Power Supply	Power form host device.		

## 1.2 EUT CHANNEL INFORMATION

Frequency Range	802.11b/g/n HT20: 2412MHz ~ 2462MHz 802.11n HT40: 2422MHz ~ 2452MHz
Modulation Type	1. IEEE 802.11b Mode: DSSS(DBPSK/DQPSK/CCK) 2. IEEE 802.11g Mode: OFDM (BPSK/QPSK/16QAM/64QAM) 3. IEEE 802.11n HT20 Mode : OFDM (BPSK/QPSK/16QAM/64QAM) 4. IEEE 802.11n HT40 Mode : OFDM (BPSK/QPSK/16QAM/64QAM)
Number of channels	1. IEEE 802.11b Mode: 11 Channels 2. IEEE 802.11g Mode: 11 Channels 3. IEEE 802.11n HT20 Mode : 11 Channels 4. IEEE 802.11n HT40 Mode : 7 Channels

### Remark:

Refer as ANSI C63.10: 2013 clause 5.6.1 Table 4 and RSS-GEN Table 1 for test channels.

Number of frequencies to be tested		
Frequency range in which device operates	Number of frequencies	Location in frequency range of operation
<input type="checkbox"/> 1 MHz or less	1	Middle
<input type="checkbox"/> 1 MHz to 10 MHz	2	1 near top and 1 near bottom
<input checked="" type="checkbox"/> More than 10 MHz	3	1 near top, 1 near middle, and 1 near bottom

## 1.3 ANTENNA INFORMATION

Antenna Type	<input checked="" type="checkbox"/> PIFA <input type="checkbox"/> PCB <input type="checkbox"/> Dipole <input type="checkbox"/> Coils
Antenna Gain	Gain: 4.15 dBi
Antenna Connector	N/A

## 1.4 MEASUREMENT UNCERTAINTY

PARAMETER	UNCERTAINTY
AC Powerline Conducted Emission	+/- 1.2575
Emission bandwidth, 20dB bandwidth	+/- 0.0014
RF output power, conducted	+/- 1.14
Power density, conducted	+/- 1.40
3M Semi Anechoic Chamber / 30M~200M	+/- 4.12
3M Semi Anechoic Chamber / 200M~1000M	+/- 4.68
3M Semi Anechoic Chamber / 1G~8G	+/- 5.18
3M Semi Anechoic Chamber / 8G~18G	+/- 5.47
3M Semi Anechoic Chamber / 18G~26G	+/- 3.81
3M Semi Anechoic Chamber / 26G~40G	+/- 3.87

**Remark:**

1. This uncertainty represents an expanded uncertainty expressed at approximately the 95% confidence level using a coverage factor of  $k=2$
2. ISO/IEC 17025 requires that an estimate of the measurement uncertainties associated with the emissions test results be included in the report.

## 1.5 FACILITIES AND TEST LOCATION

All measurement facilities used to collect the measurement data are located at  
No.11, Wugong 6th Rd., Wugu Dist., New Taipei City 24891, Taiwan. (R.O.C.)

Test site	Test Engineer	Remark
AC Conduction Room	Dally Hong	-
Radiation	Dally Hong	-
RF Conducted	Dally Hong	-

**Remark:** The sites are constructed in conformance with the requirements of ANSI C63.7, ANSI C63.4 and CISPR Publication 22.

## 1.6 INSTRUMENT CALIBRATION

RF Conducted Test Site					
Equipment	Manufacturer	Model	S/N	Cal Date	Cal Due
Coaxial Cable	Woken	WC12	CC001	06/29/2018	06/28/2019
Power Meter	Anritsu	ML2495A	1149001	02/12/2019	02/11/2020
Power Seneor	Anritsu	MA2491A	030982	02/12/2019	02/11/2020
Signal Analyzer	R&S	FSV 40	101073	09/27/2018	09/26/2019
3M 966 Chamber Test Site					
Equipment	Manufacturer	Model	S/N	Cal Date	Cal Due
Band Reject Filters	MICRO TRONICS	BRM 50702	120	02/26/2019	02/25/2020
Bilog Antenna	Sunol Sciences	JB3	A030105	07/13/2018	07/12/2019
Cable	HUBER SUHNER	SUCOFLEX 104PEA	25157	02/26/2019	02/25/2020
Cable	HUBER SUHNER	SUCOFLEX 104PEA	20995	02/26/2019	02/25/2020
Digital Thermo- Hygro Meter	WISEWIND	1206	D07	01/30/2019	01/29/2020
Double Ridged Guide Horn Antenna	ETC	MCTD 1209	DRH13M02003	08/20/2018	08/19/2019
Pre-Amplifier	EMEC	EM330	060609	02/26/2019	02/25/2020
Pre-Amplifier	HP	8449B	3008A00965	02/26/2019	02/25/2020
PSA Series Spectrum Analyzer	Agilent	E4446A	MY46180323	05/31/2018	05/30/2019
Antenna Tower	CCS	CC-A-1F	N/A	N.C.R	N.C.R
Controller	CCS	CC-C-1F	N/A	N.C.R	N.C.R
Turn Table	CCS	CC-T-1F	N/A	N.C.R	N.C.R
Software	e3 6.11-20180413				
AC line Conduction Test Room					
Equipment	Manufacturer	Model	S/N	Cal Date	Cal Due
CABLE	EMCI	CFD300-NL	CERF	06/29/2018	06/28/2019
EMI Test Receiver	R&S	ESCI	100064	07/24/2018	07/23/2019
LISN	SCHWARZBECK	NSLK 8127	8127-541	01/31/2019	01/30/2020
LISN	SCHAFFNER	NNB 41	03/10013	02/13/2019	02/12/2020
Software	EZ-EMC(CCS-3A1-CE-五股)				

**Remark:** Each piece of equipment is scheduled for calibration once a year.



## 1.7 SUPPORT AND EUT ACCESSORIES EQUIPMENT

EUT Accessories Equipment					
No.	Equipment	Brand	Model	Series No.	FCC ID
	N/A				

Support Equipment					
No.	Equipment	Brand	Model	Series No.	FCC ID
1	NB(L)	Toshiba	PORTEGE R30-A	N/A	PD97260H

## 1.8 TEST METHODOLOGY AND APPLIED STANDARDS

The test methodology, setups and results comply with all requirements in accordance with ANSI C63.10:2013, FCC Part 2, FCC Part 15.247, KDB 558074 D01, RSS-247 Issue 2 and RSS-GEN Issue 5.

## 2. TEST SUMMERY

FCC Standard Section	IC Standard Section	Report Section	Test Item	Result
15.203	-	1.3	Antenna Requirement	Pass
15.207(a)	RSS-GEN 8.8	5.1	AC Conducted Emission	Pass
15.247(a)(2)	RSS-247(5.2)(a)	5.2	6 dB Bandwidth	Pass
-	RSS-GEN 6.6	5.2	Occupied Bandwidth (99%)	Pass
15.247(b)(3)	RSS-247(5.4)(d)	5.3	Output Power Measurement	Pass
15.247(e)	RSS-247(5.2)(b)	5.4	Power Spectral Density	Pass
15.247(d)	RSS-247(5.5)	5.5	Conducted Band Edge	Pass
15.247(d)	RSS-247(5.5)	5.5	Conducted Spurious Emission	Pass
15.247(d)	RSS-GEN 8.9, 8.10	5.6	Radiation Band Edge	Pass
15.247(d)	RSS-GEN 8.9, 8.10	5.6	Radiation Spurious Emission	Pass

### 3. DESCRIPTION OF TEST MODES

#### 3.1 THE WORST MODE OF OPERATING CONDITION

<p>Operation mode</p>	<p>IEEE 802.11b Mode: 1Mbps            IEEE 802.11g Mode: 6Mbps            IEEE 802.11n HT20 Mode: MCS0            IEEE 802.11n HT40 Mode: MCS0</p>
<p>Test Channel Frequencies</p>	<p><b>IEEE 802.11b Mode :</b>            1. Lowest Channel : 2412MHz            2. Middle Channel : 2437MHz            3. Highest Channel : 2462MHz  <b>IEEE 802.11g Mode :</b>            1. Lowest Channel : 2412MHz            2. Middle Channel : 2437MHz            3. Highest Channel : 2462MHz  <b>IEEE 802.11n HT20 Mode :</b>            1. Lowest Channel : 2412MHz            2. Middle Channel : 2437MHz            3. Highest Channel : 2462MHz  <b>IEEE 802.11n HT40 Mode :</b>            1. Lowest Channel : 2422MHz            2. Middle Channel : 2437MHz            3. Highest Channel : 2452MHz</p>
<p>Operation Transmitter</p>	<p>IEEE 802.11b Mode : 1T1R            IEEE 802.11g Mode : 1T1R            IEEE 802.11n HT20 Mode : 1T1R            IEEE 802.11n HT40 Mode : 1T1R</p>

**Remark:**

1. EUT pre-scanned data rate of output power for each mode, the worst data rate were recorded in this report.

### 3.2 THE WORST MODE OF MEASUREMENT

AC Power Line Conducted Emission	
Test Condition	AC Power line conducted emission for line and neutral
Power supply Mode	Mode 1: EUT power by host system.
Worst Mode	<input checked="" type="checkbox"/> Mode 1 <input type="checkbox"/> Mode 2 <input type="checkbox"/> Mode 3 <input type="checkbox"/> Mode 4

Radiated Emission Measurement Above 1G	
Test Condition	Band edge, Emission for Unwanted and Fundamental
Power supply Mode	Mode 1: EUT power by host system.
Power supply Mode	<input checked="" type="checkbox"/> Mode 1 <input type="checkbox"/> Mode 2 <input type="checkbox"/> Mode 3 <input type="checkbox"/> Mode 4
Worst Position	<input type="checkbox"/> Placed in fixed position. <input type="checkbox"/> Placed in fixed position at X-Plane (E2-Plane) <input checked="" type="checkbox"/> Placed in fixed position at Y-Plane (E1-Plane) <input type="checkbox"/> Placed in fixed position at Z-Plane (H-Plane)
Worst Polarity	<input checked="" type="checkbox"/> Horizontal <input type="checkbox"/> Vertical

Radiated Emission Measurement Below 1G	
Test Condition	Radiated Emission Below 1G
Power supply Mode	Mode 1: EUT power by host system.
Worst Mode	<input checked="" type="checkbox"/> Mode 1 <input type="checkbox"/> Mode 2 <input type="checkbox"/> Mode 3 <input type="checkbox"/> Mode 4

*Remark:*

1. The worst mode was record in this test report.
2. EUT pre-scanned in three axis, X, Y, Z and two polarity, Horizontal and Vertical for radiated measurement. The worst case (Y-Plane and Horizontal) were recorded in this report
3. For below 1G, AC power line conducted emission and radiation emission were performed the EUT transmit at the highest output power channel as worse case.

### 4. EUT DUTY CYCLE

Duty Cycle			
Configuration	TX ON (ms)	TX ALL (ms)	Duty Cycle (%)
802.11b	1.0000	1.0000	100.00%
802.11g	1.0000	1.0000	100.00%
802.11n HT20	1.0000	1.0000	100.00%
802.11n HT40	1.0000	1.0000	100.00%

<p style="text-align: center;"><b>802.11b</b></p> <p><b>Copyright 2000-2012 Agilent Technologies</b></p>	<p style="text-align: center;"><b>802.11g</b></p> <p><b>Illegal parameter value</b></p>
<p style="text-align: center;"><b>802.11n HT20</b></p> <p><b>Illegal parameter value</b></p>	<p style="text-align: center;"><b>802.11n HT40</b></p> <p><b>Copyright 2000-2012 Agilent Technologies</b></p>

## 5. TEST RESULT

### 5.1 AC POWER LINE CONDUCTED EMISSION

#### 5.1.1 Test Limit

According to §15.207(a) and RSS-GEN section 8.8,

Frequency Range (MHz)	Limits(dBµV)	
	Quasi-peak	Average
0.15 to 0.50	66 to 56*	56 to 46*
0.50 to 5	56	46
5 to 30	60	50

\* Decreases with the logarithm of the frequency.

#### 5.1.2 Test Procedure

Test method Refer as ANSI C63.10: 2013 clause 6.2,

1. The EUT was placed on a non-conducted table, which is 0.8m above horizontal ground plane and 0.4m above vertical ground plane.
2. EUT connected to the line impedance stabilization network (LISN)
3. Receiver set RBW of 9kHz and Detector Peak, and note as quasi-peak and average.
4. Maximum procedure was performed on the six highest emissions to ensure EUT compliance.
5. Recorded Line for Neutral and Line.

#### 5.1.3 Test Setup

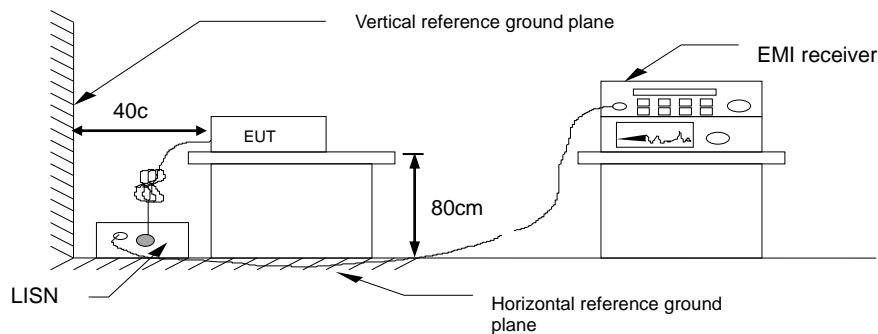

#### 5.1.4 Test Result

**Pass.**

### Test Data

Test Mode:	Mode 1	Temp/Hum	24(°C) / 50%RH
Phase:	Line	Test Date	March 26, 2019
		Test Engineer	Dally Hong

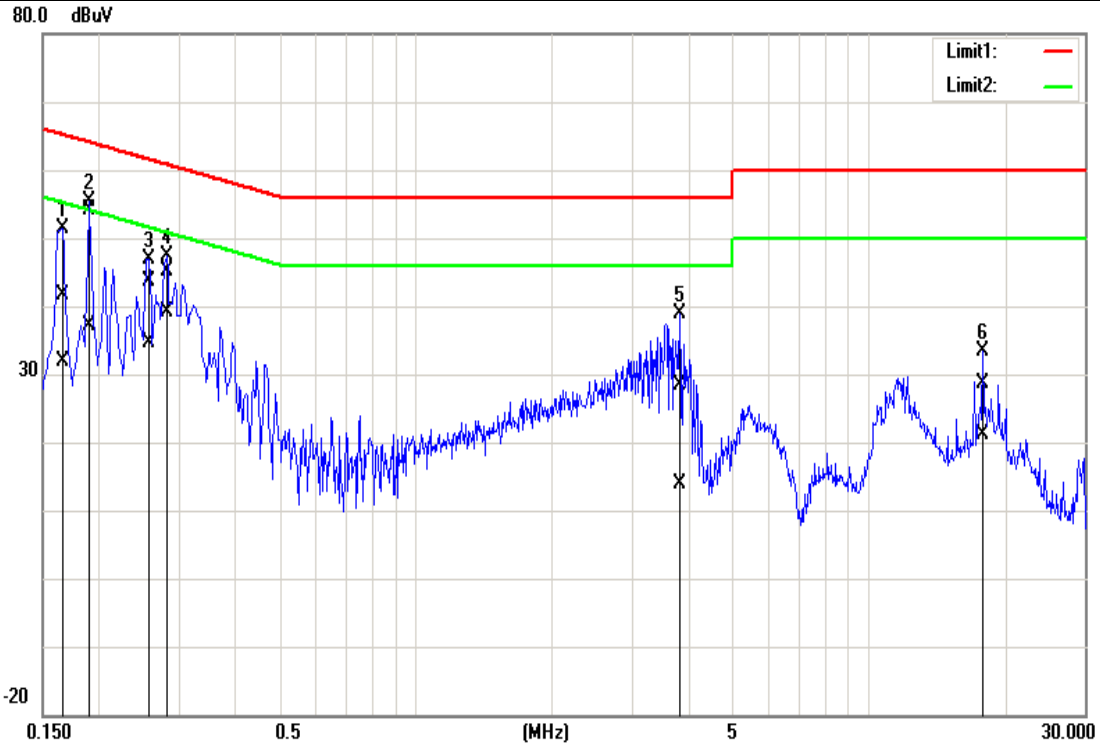

Frequency (MHz)	Quasi Peak reading (dBuV)	Average reading (dBuV)	Correction factor (dB)	Quasi Peak result (dBuV)	Average result (dBuV)	Quasi Peak limit (dBuV)	Average limit (dBuV)	Quasi Peak margin (dB)	Average margin (dB)	Remark
0.1660	41.55	31.65	0.16	41.71	31.81	65.16	55.16	-23.45	-23.35	Pass
0.1900	53.93	37.00	0.15	54.08	37.15	64.04	54.04	-9.96	-16.89	Pass
0.2580	43.47	34.48	0.15	43.62	34.63	61.50	51.50	-17.88	-16.87	Pass
0.2820	44.96	39.01	0.15	45.11	39.16	60.76	50.76	-15.65	-11.60	Pass
3.8300	28.05	13.49	0.27	28.32	13.76	56.00	46.00	-27.68	-32.24	Pass
17.9060	28.07	20.53	0.65	28.72	21.18	60.00	50.00	-31.28	-28.82	Pass

Test Mode:	Mode 1	Temp/Hum	24(°C) / 50%RH
Phase:	Neutral	Test Date	March 26, 2019
		Test Engineer	Dally Hong

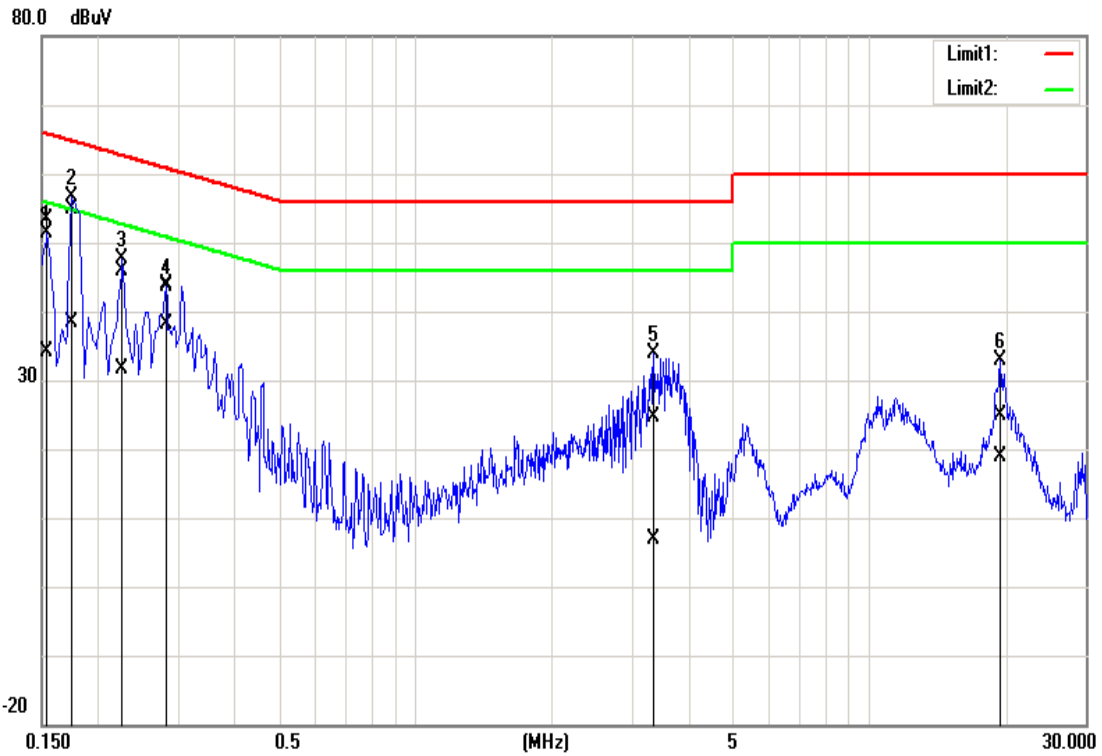

Frequency (MHz)	Quasi Peak reading (dBuV)	Average reading (dBuV)	Correction factor (dB)	Quasi Peak result (dBuV)	Average result (dBuV)	Quasi Peak limit (dBuV)	Average limit (dBuV)	Quasi Peak margin (dB)	Average margin (dB)	Remark
0.1540	53.23	33.94	0.10	53.33	34.04	65.78	55.78	-12.45	-21.74	Pass
0.1740	54.84	38.35	0.10	54.94	38.45	64.77	54.77	-9.83	-16.32	Pass
0.2260	45.79	31.53	0.10	45.89	31.63	62.60	52.60	-16.71	-20.97	Pass
0.2820	43.85	38.05	0.10	43.95	38.15	60.76	50.76	-16.81	-12.61	Pass
3.3580	24.35	6.80	0.19	24.54	6.99	56.00	46.00	-31.46	-39.01	Pass
19.4980	24.25	18.37	0.54	24.79	18.91	60.00	50.00	-35.21	-31.09	Pass



## 5.2 6dB BANDWIDTH AND OCCUPIED BANDWIDTH(99%)

### 5.2.1 Test Limit

According to §15.247(a)(2) and RSS-247 section 5.2(a),

#### 6 dB Bandwidth :

Limit	Shall be at least 500kHz
-------	--------------------------

Occupied Bandwidth(99%) : For reporting purposes only.

### 5.2.2 Test Procedure

Test method Refer as KDB 558074 D01 and ANSI C63.10: 2013 clause 6.9.2,

1. The EUT RF output connected to the spectrum analyzer by RF cable.
2. Setting maximum power transmit of EUT
3. SA set RBW = 100KHz , VBW = 300KHz and Detector = Peak, to measurement 6dB Bandwidth
4. SA set RBW = 1% ~ 5% OBW, VBW = three times the RBW and Detector = Peak, to measurement 99% Bandwidth
5. Measure and record the result of 6 dB Bandwidth and 99% Bandwidth. in the test report.

### 5.2.3 Test Setup



### 5.2.4 Test Result

Test mode: IEEE 802.11b Mode / 2412-2462 MHz				
Channel	Frequency (MHz)	OBW(99%) (MHz)	6dB BW (MHz)	6dB limit (kHz)
Low	2412	15.8031	10.1304	≥500
Mid	2437	15.7597	10.1304	
High	2462	15.8465	10.1304	

Test mode: IEEE 802.11g Mode / 2412-2462 MHz				
Channel	Frequency (MHz)	OBW(99%) (MHz)	6dB BW (MHz)	6dB limit (kHz)
Low	2412	17.4963	16.5652	≥500
Mid	2437	17.4529	16.5217	
High	2462	17.2793	16.5217	

Test mode: IEEE 802.11n HT20 Mode / 2412-2462 MHz				
Channel	Frequency (MHz)	OBW(99%) (MHz)	6dB BW (MHz)	6dB limit (kHz)
Low	2412	18.3646	17.7826	≥500
Mid	2437	18.2778	17.6957	
High	2462	18.2344	17.7391	

Test mode: IEEE 802.11n HT40 Mode / 2422-2452 MHz				
Channel	Frequency (MHz)	OBW(99%) (MHz)	6dB BW (MHz)	6dB limit (kHz)
Low	2422	39.8263	36.406	≥500
Mid	2437	39.8263	36.406	
High	2452	39.5947	36.406	

## Test Data

### 6dB BANDWIDTH

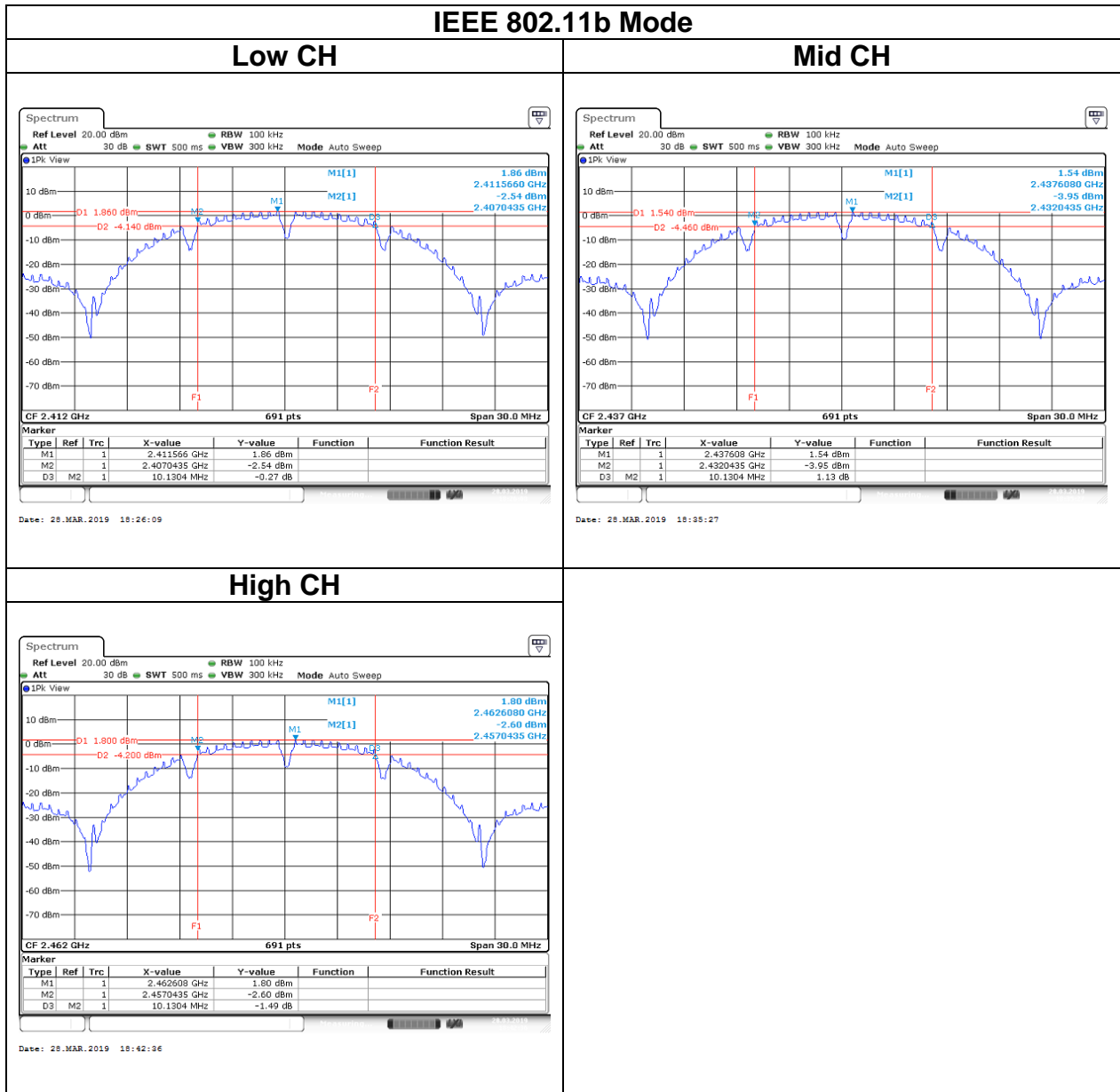

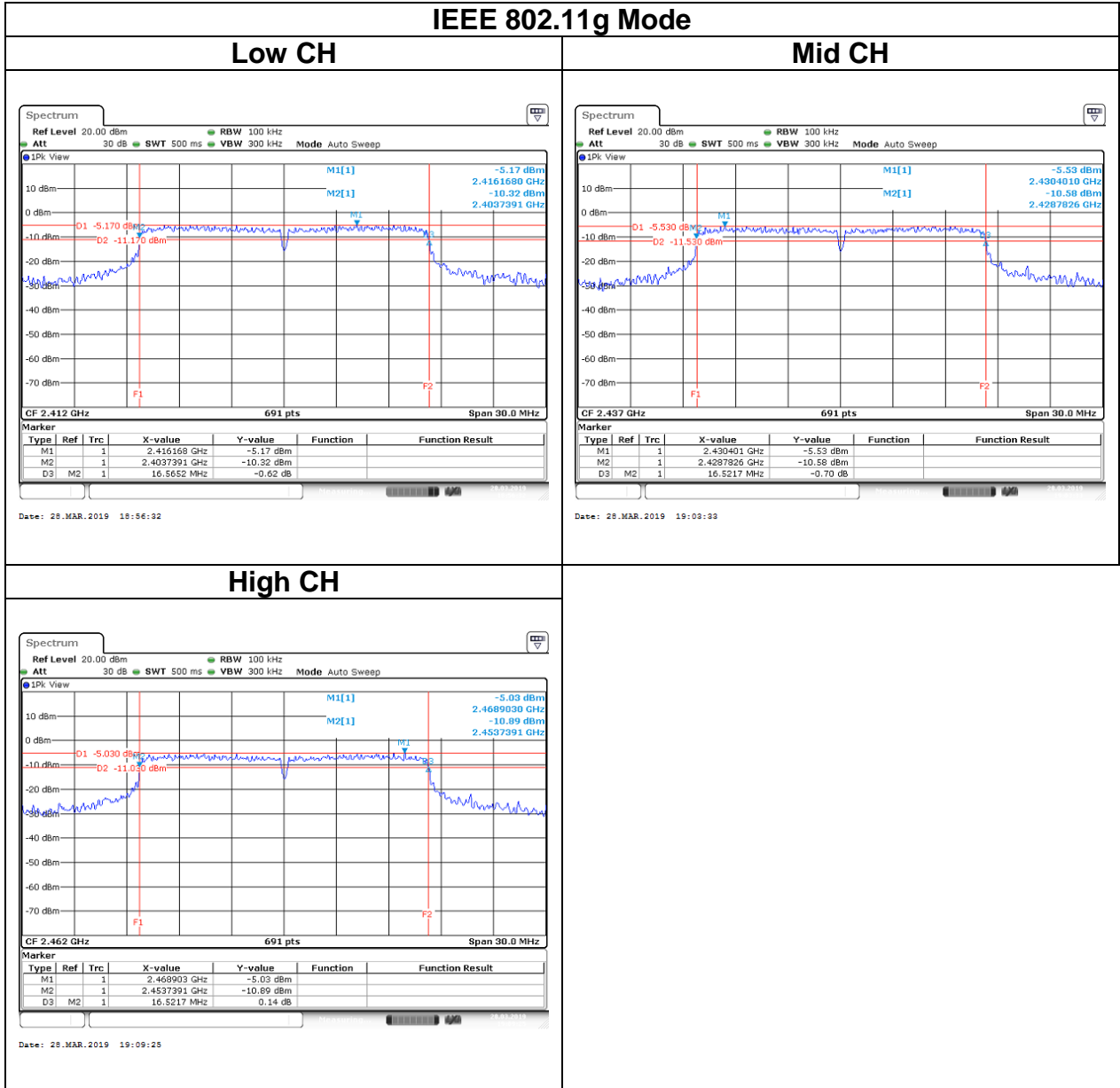

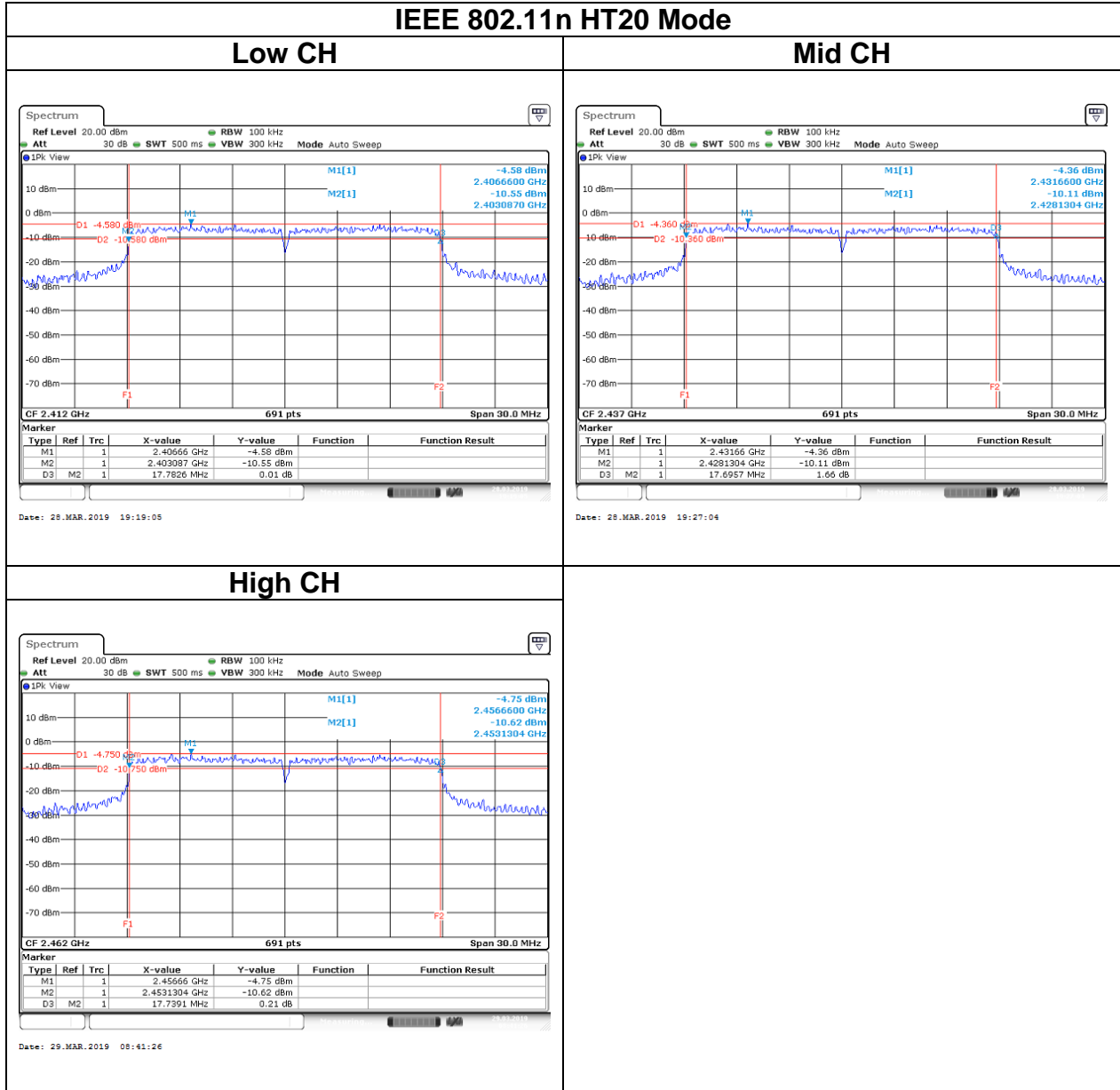

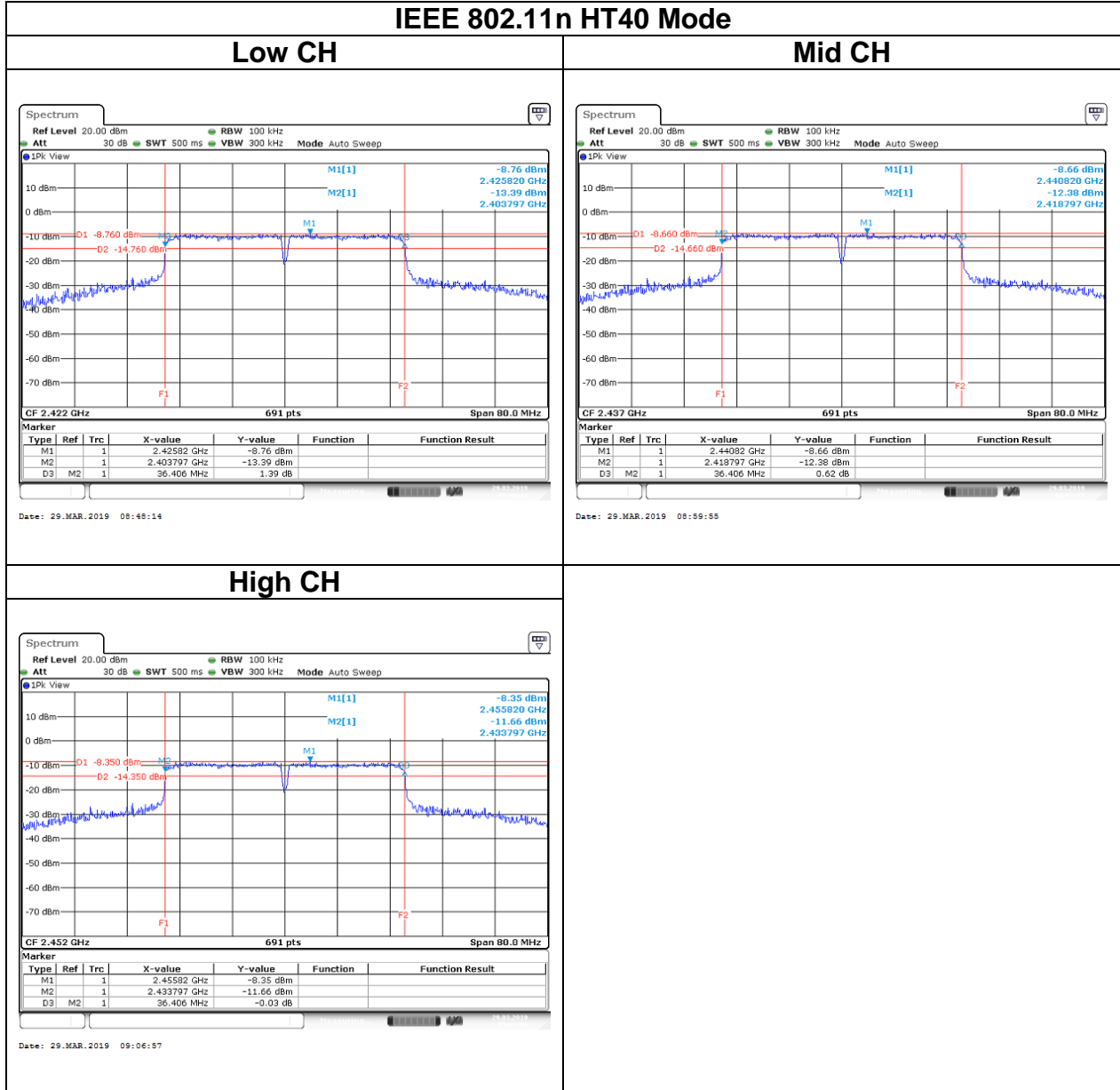

## Test Data

### BANDWIDTH (99%)

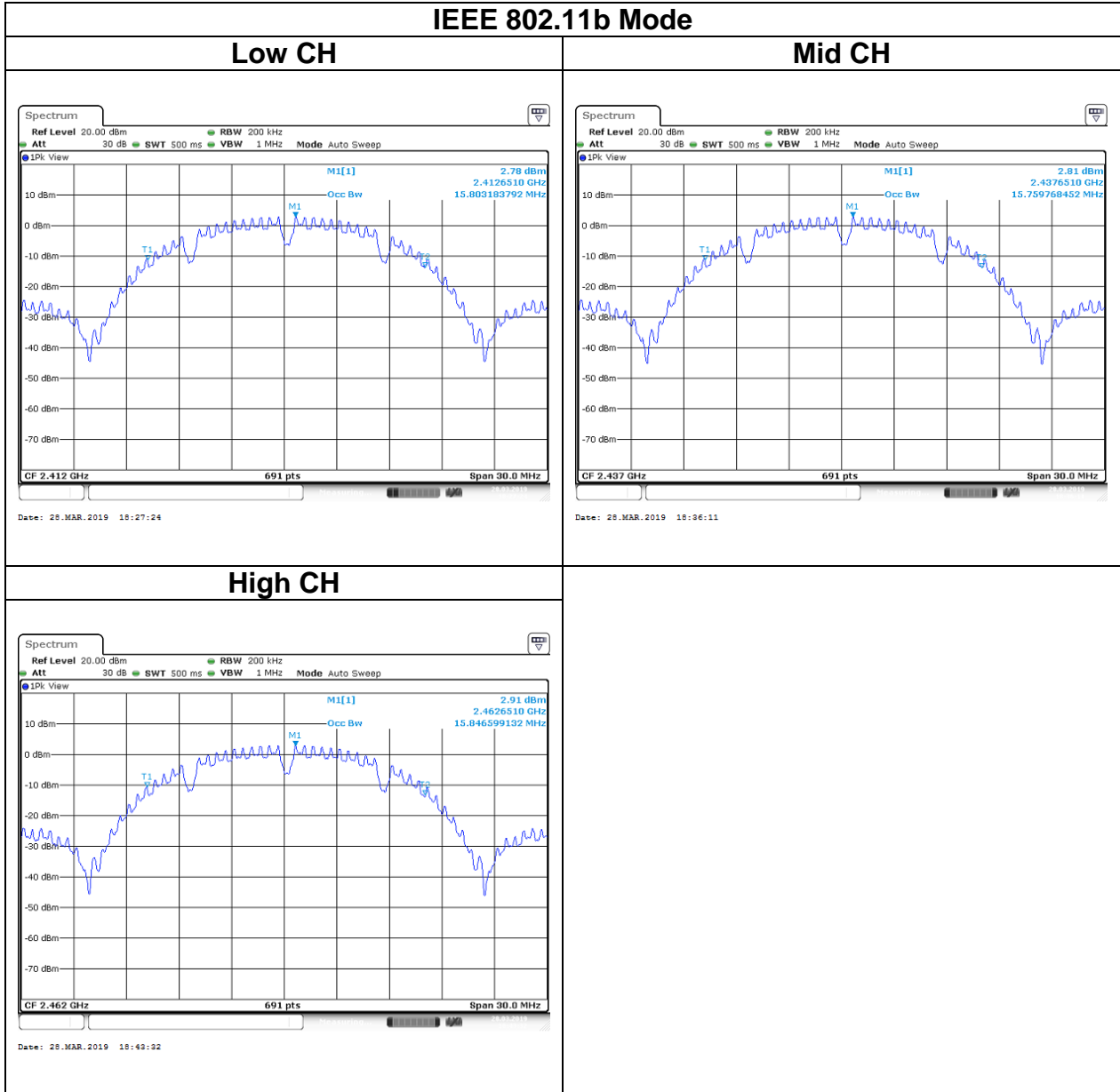

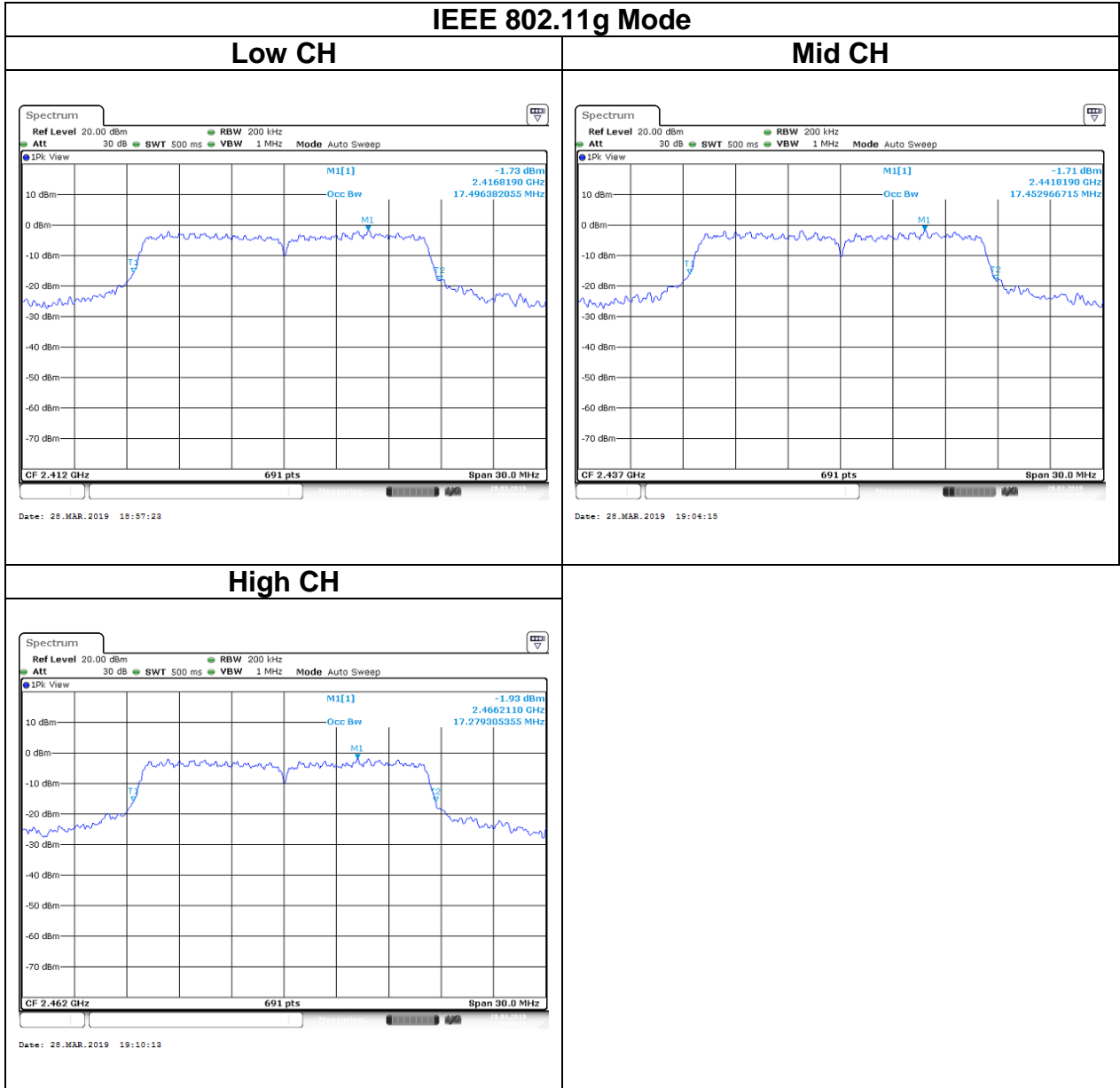



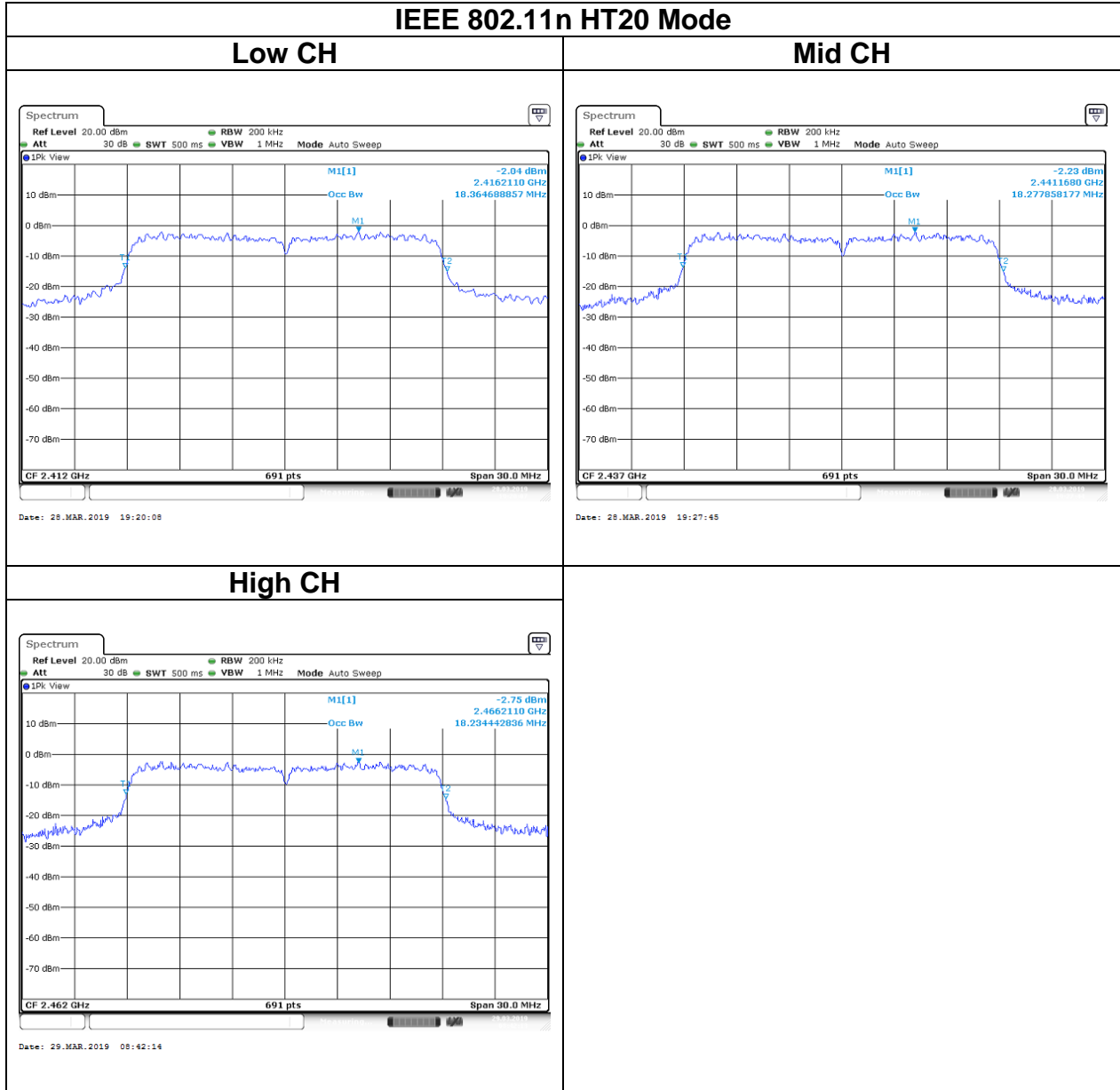

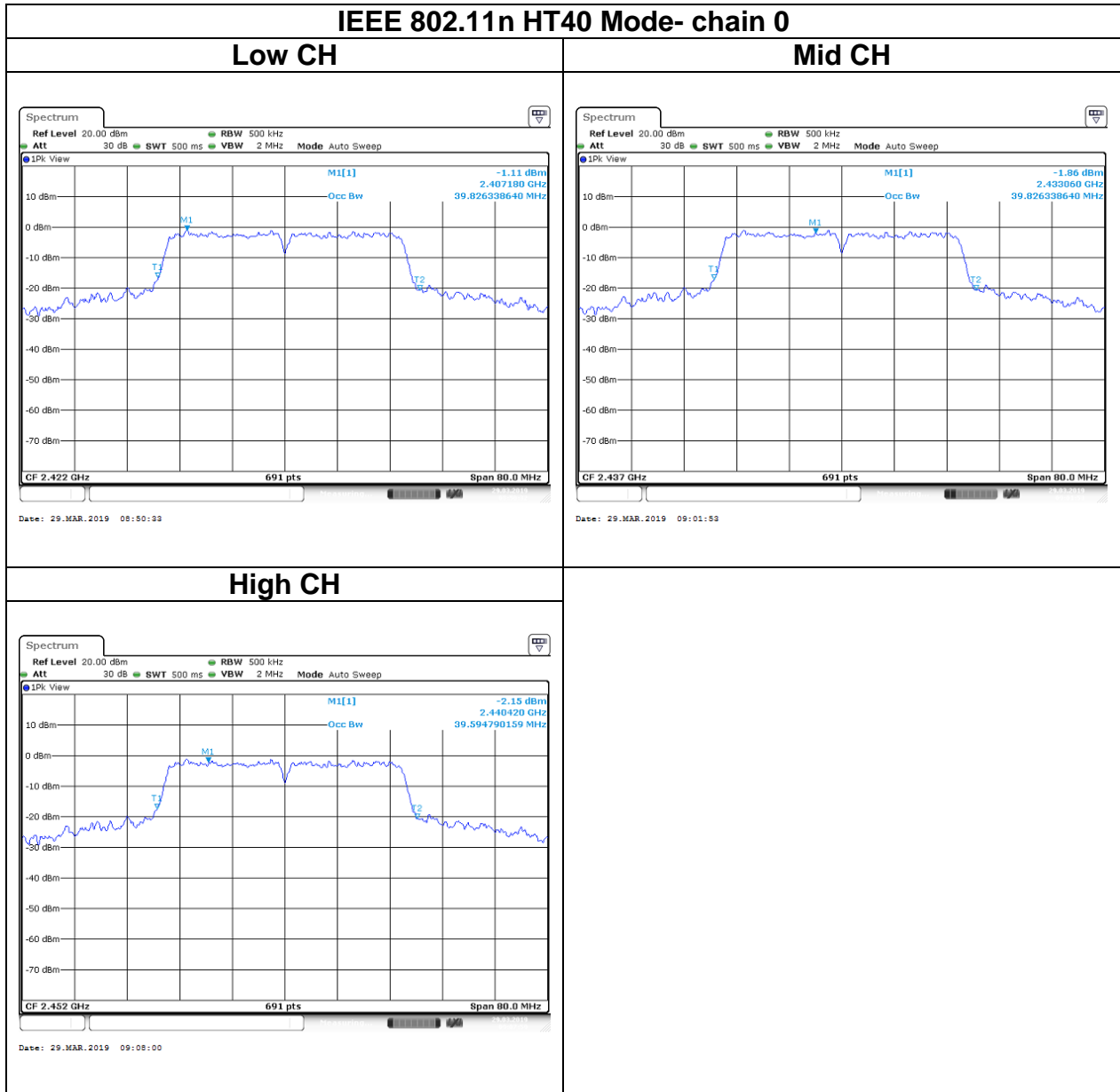

## 5.3 OUTPUT POWER MEASUREMENT

### 5.3.1 Test Limit

According to §15.247(b)(3) and RSS-247 section 5.4(d),

#### Peak output power :

For systems using digital modulation in the 2400-2483.5 MHz: 1 Watt (30 dBm) and the e.i.r.p. shall not exceed 4Watt (36 dBm), base on the use of antennas with directional gain not exceed 6 dBi If transmitting antennas of directional gain greater than 6dBi are used the peak output power the conducted output power from the intentional radiator shall be reduced by the amount in dB that the directional gain of the antenna exceeds 6 dBi. In case of point-to-point operation, the limit has to be reduced by 1dB for every 3 dB that the directional gain of the antenna exceeds 6 dBi.

Limit	<input checked="" type="checkbox"/> Antenna not exceed 6 dBi : 30dBm <input type="checkbox"/> Antenna with DG greater than 6 dBi : [Limit = 30 – (DG – 6)] <input type="checkbox"/> Point-to-point operation :
-------	---

Average output power : For reporting purposes only.

### 5.3.2 Test Procedure

Test method Refer as KDB 558074 D01.

1. The EUT RF output connected to the power meter by RF cable.
2. Setting maximum power transmit of EUT.
3. The path loss was compensated to the results for each measurement.
4. Measure and record the result of Peak output power and Average output power. in the test report.

### 5.3.3 Test Setup

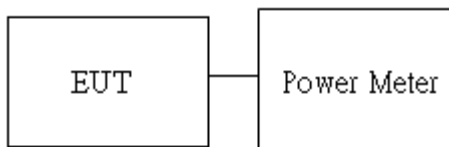

### 5.3.4 Test Result

#### Peak output power :

Wifi 2.4G										
Config	CH	Freq. (MHz)	power set	PK Power (dBm)	EIRP PK Power (dBm)	PK Power (W)	EIRP PK Power (W)	DG (dBi)	Limit (dBm)	EIRP Limit (dBm)
IEEE 802.11b Data rate: 1Mbps	Low	2412	63	24.05	28.20	0.2541	0.6607	4.15	30	36
	Mid	2437	63	24.68	28.83	0.2938	0.7638			
	High	2462	63	24.42	28.57	0.2767	0.7194			
IEEE 802.11g Data rate: 6Mbps	Low	2412	63	24.02	28.17	0.2523	0.6561			
	Mid	2437	63	24.05	28.20	0.2541	0.6607			
	High	2462	63	23.96	28.11	0.2489	0.6471			
IEEE 802.11n HT20 Data rate: MCS0	Low	2412	63	24.19	28.34	0.2624	0.6823			
	Mid	2437	63	24.30	28.45	0.2692	0.6998			
	High	2462	63	24.00	28.15	0.2512	0.6531			
IEEE 802.11n HT40 Data rate: MCS0	Low	2422	63	24.33	28.48	0.2710	0.7047			
	Mid	2437	63	24.09	28.24	0.2564	0.6668			
	High	2452	63	24.18	28.33	0.2618	0.6808			

Report No.: T190322W01-RP3-1

Ref. No.: T190315W01-RP3

**Average output power :**

Wifi 2.4G			
Config	CH	Freq. (MHz)	AV Power (dBm)
IEEE 802.11b Data rate: 1Mbps	Low	2412	22.62
	Mid	2437	23.44
	High	2462	23.12
IEEE 802.11g Data rate: 6Mbps	Low	2412	19.63
	Mid	2437	19.69
	High	2462	19.67
IEEE 802.11n 20MHz Data rate: MCS8	Low	2412	20.00
	Mid	2437	20.06
	High	2462	19.99
IEEE 802.11n 40MHz Data rate: MCS8	Low	2422	20.22
	Mid	2437	19.97
	High	2452	20.03

## 5.4 POWER SPECTRAL DENSITY

### 5.4.1 Test Limit

According to §15.247(e) and RSS-247 section 5.2(b),

For digitally modulated systems, the power spectral density conducted from the intentional radiator to the antenna shall not be greater than 8 dBm in any 3 kHz band during any time interval of continuous transmission.

Limit	<input checked="" type="checkbox"/> Antenna not exceed 6 dBi : 8dBm <input type="checkbox"/> Antenna with DG greater than 6 dBi : [ Limit = 8 – (DG – 6) ] <input type="checkbox"/> Point-to-point operation :
-------	---

### 5.4.2 Test Procedure

Test method Refer as KDB 558074 D01.

1. The EUT RF output connected to the spectrum analyzer by RF cable.
2. Setting maximum power transmit of EUT
3. SA set RBW = 3kHz, VBW = 30kHz, Span = 1.5 times DTS Bandwidth (6 dB BW), Detector = Peak, Sweep Time = Auto and Trace = Max hold.
4. The path loss was compensated to the results for each measurement by SA.
5. Mark the maximum level.
6. Measure and record the result of power spectral density. in the test report.

### 5.4.3 Test Setup

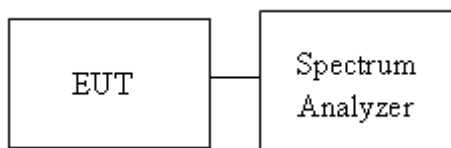

Report No.: T190322W01-RP3-1

Ref. No.: T190315W01-RP3

#### 5.4.4 Test Result

Test mode: IEEE 802.11b Mode / 2412-2462 MHz			
Channel	Frequency (MHz)	PPSD (dBm)	Limit (dBm)
Low	2412	-7.5	8
Mid	2437	-7.43	
High	2462	-7.42	

Test mode: IEEE 802.11g Mode / 2412-2462 MHz			
Channel	Frequency (MHz)	PPSD (dBm)	Limit (dBm)
Low	2412	-8.37	8
Mid	2437	-8.39	
High	2462	-8.76	

Test mode: IEEE 802.11n HT20 Mode / 2412-2462 MHz			
Channel	Frequency (MHz)	PPSD (dBm)	Limit (dBm)
Low	2412	-7.93	8
Mid	2437	-7.48	
High	2462	-7.45	

Test mode: IEEE 802.11n HT40 Mode / 2422-2452 MHz			
Channel	Frequency (MHz)	PPSD (dBm)	Limit (dBm)
Low	2422	-9.03	8
Mid	2437	-9.21	
High	2452	-9.28	

## Test Data

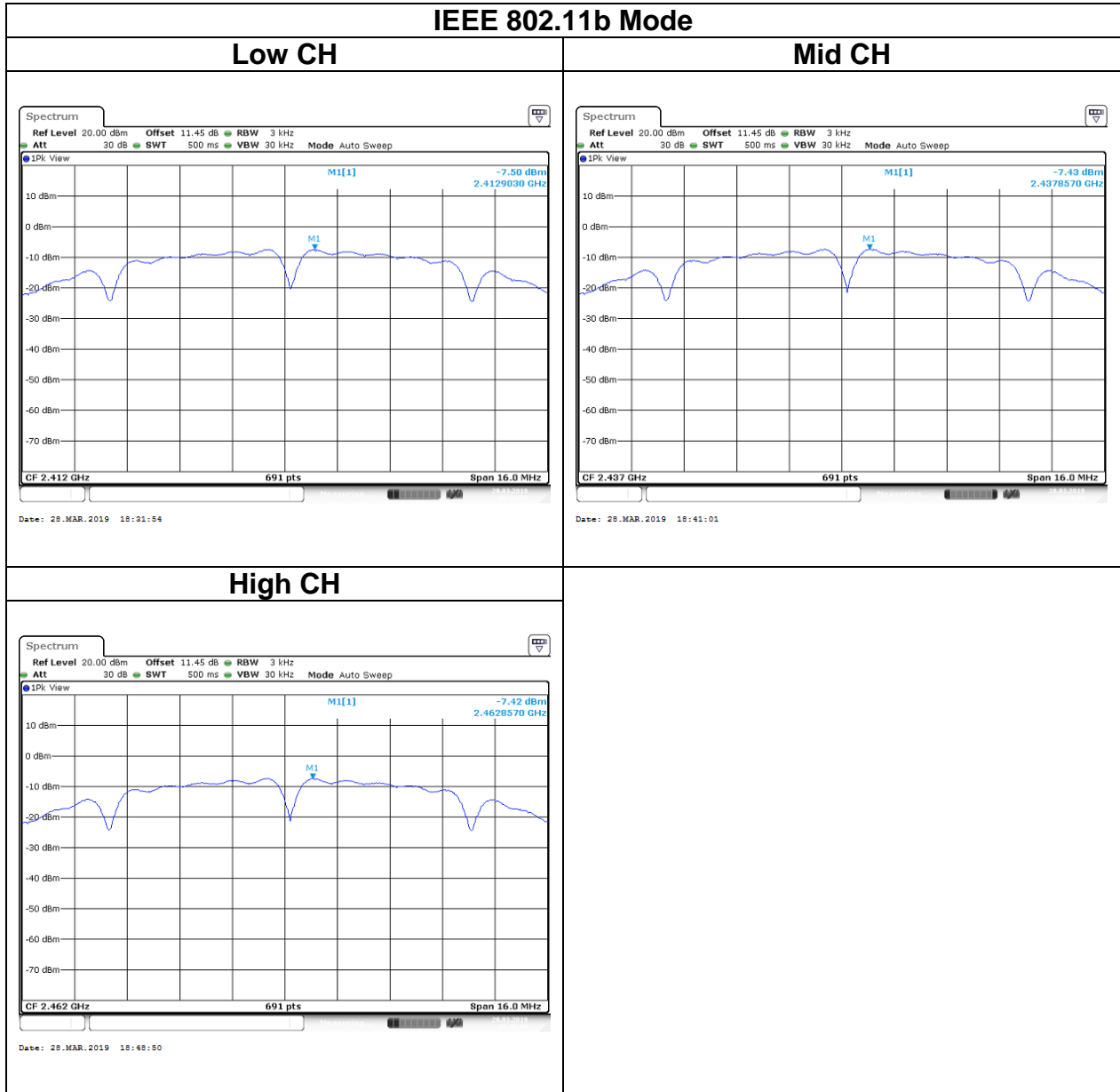



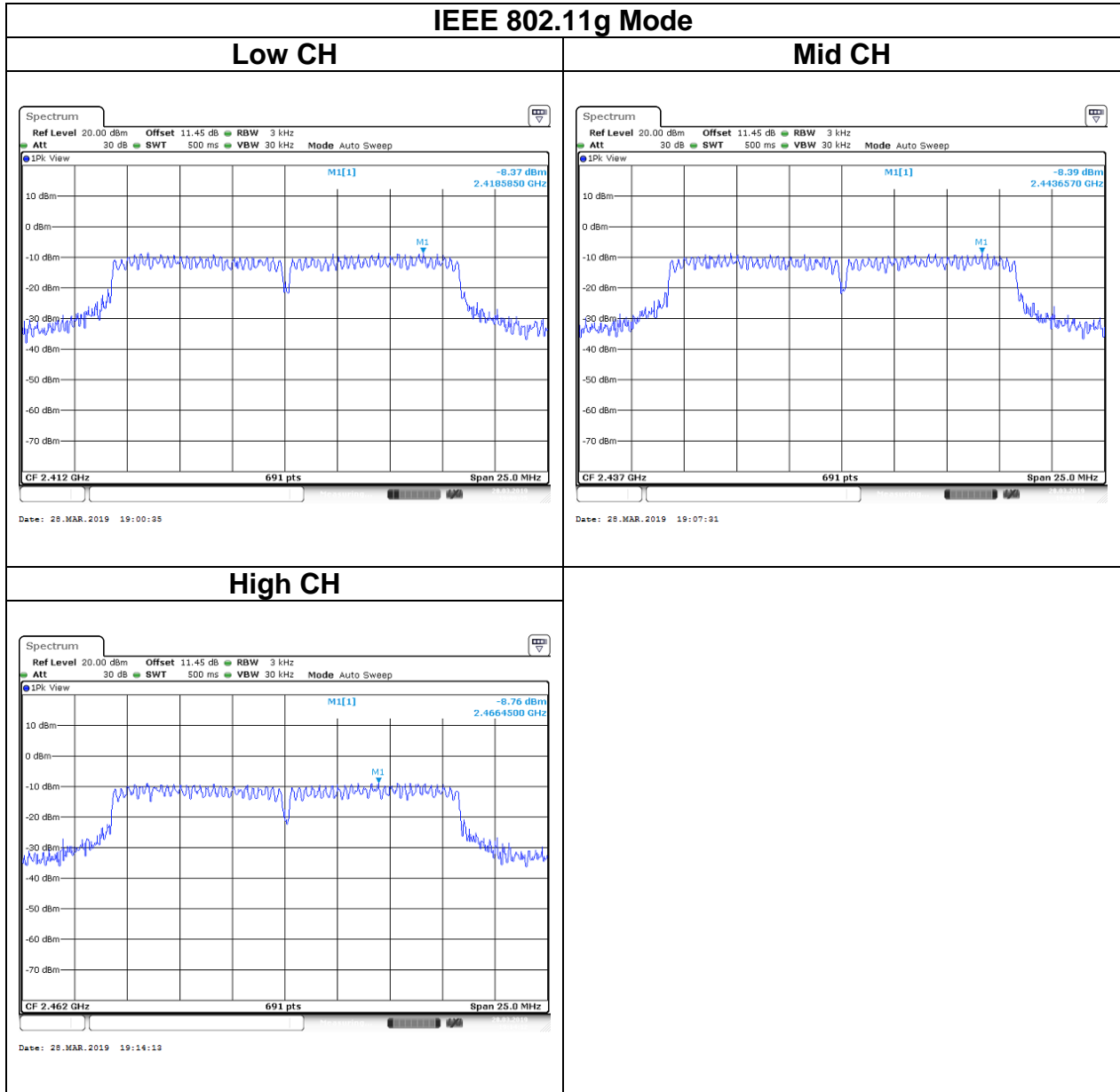

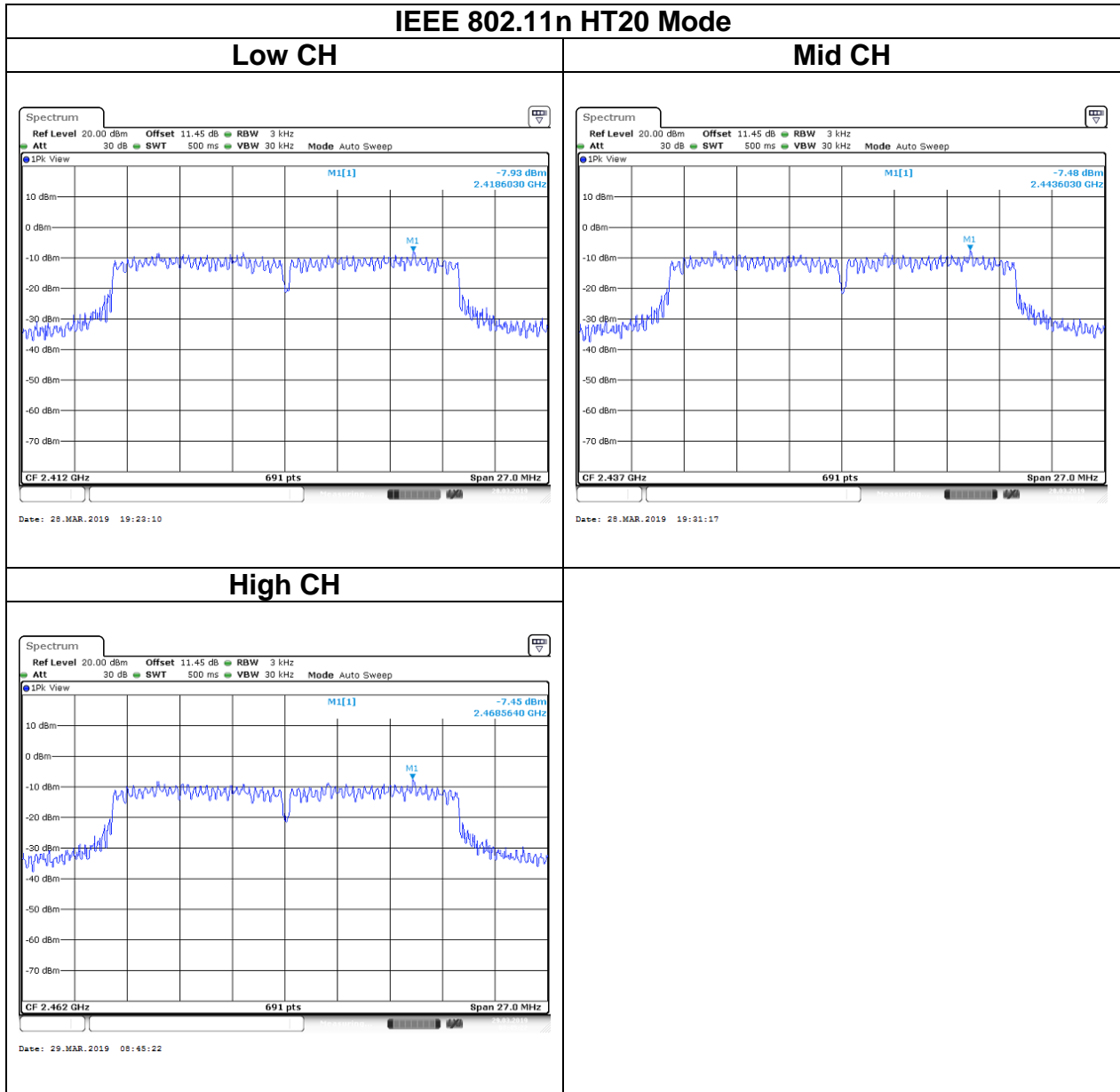

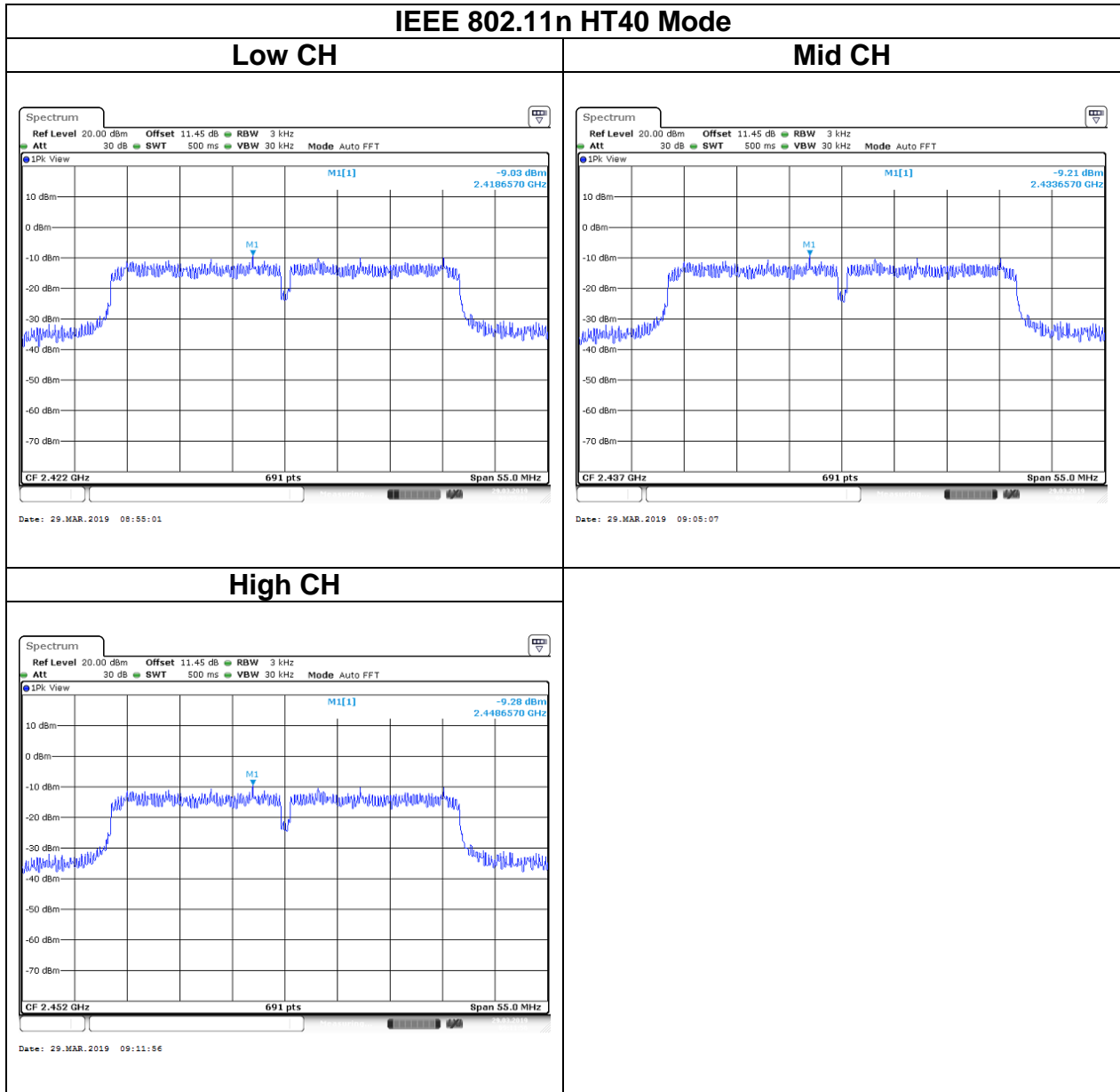

## 5.5 CONDUCTED BANDEDGE AND SPURIOUS EMISSION

### 5.5.1 Test Limit

According to §15.247(d) and RSS-247 section 5.5,

**FCC:** In any 100 kHz bandwidth outside the authorized frequency band,

Non-restricted bands shall be attenuated at least 20 dB/30 dB relative to the maximum PSD level in 100 kHz by RF conducted or a radiated measurement which fall in the restricted bands, as defined in §15.205(a), must also comply with the radiated emission limits specified in §15.209(a).

**IC:** In any 100 kHz bandwidth outside the frequency band in which the spread spectrum or digitally modulated device is operating, the RF power that is produced shall be at least 20 dB below that in the 100 kHz bandwidth within the band that contains the highest level of the desired power, based on either an RF conducted or a radiated measurement, provided that the transmitter demonstrates compliance with the peak conducted power limits. If the transmitter complies with the conducted power limits based on the use of root-mean-square averaging over a time interval, as permitted under section 5.4(d), the attenuation required shall be 30 dB instead of 20 dB. Attenuation below the general field strength limits specified in RSS-Gen is not required.

### 5.5.2 Test Procedure

Test method Refer as KDB 558074 D01.

1. EUT RF output port connected to the SA by RF cable, and the path loss was compensated to result.
2. SA setting, RBW=100kHz, VBW=300kHz, Detector=Peak, Trace mode = max hold, SWT = Auto.
3. In any 100 kHz bandwidth outside the authorized frequency band, shall be attenuated at least 20 dB relative to the maximum in-band peak PSD level in 100 kHz when conducted power procedure is used. If the transmitter complies with the conducted power limits based on the use of RMS averaging over a time interval, the attenuation required under this paragraph shall be 30 dB instead of 20 dB.

### 5.5.3 Test Setup

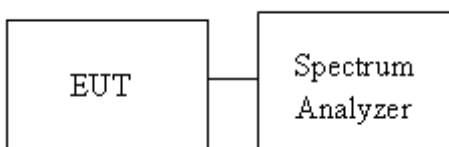

## 5.5.4 Test Result

### Test Data

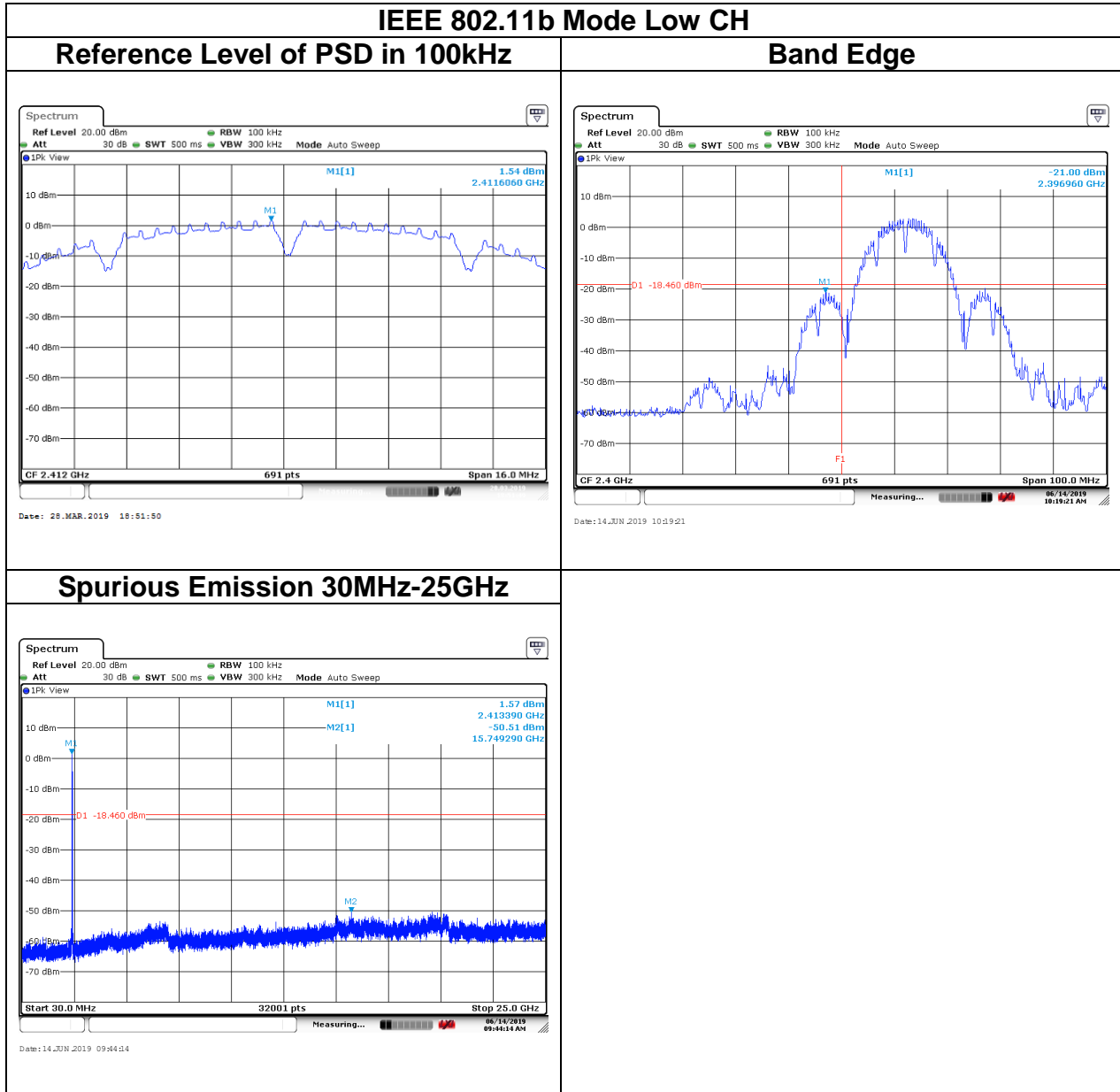

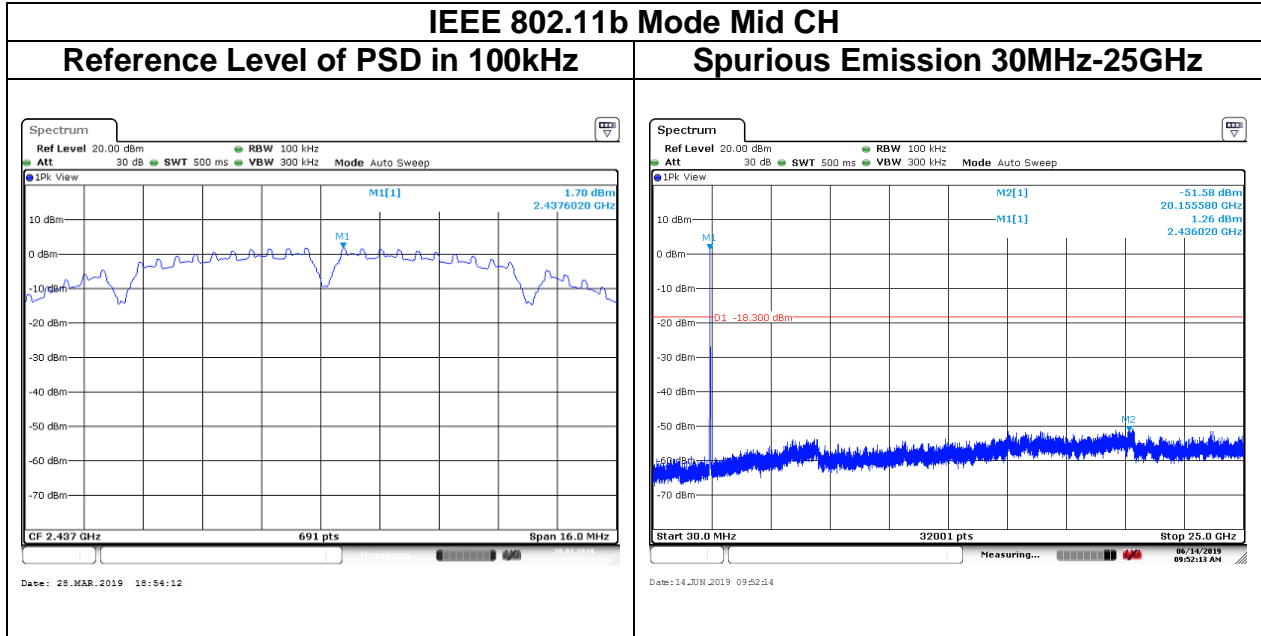

## IEEE 802.11b Mode High CH

### Reference Level of PSD in 100kHz

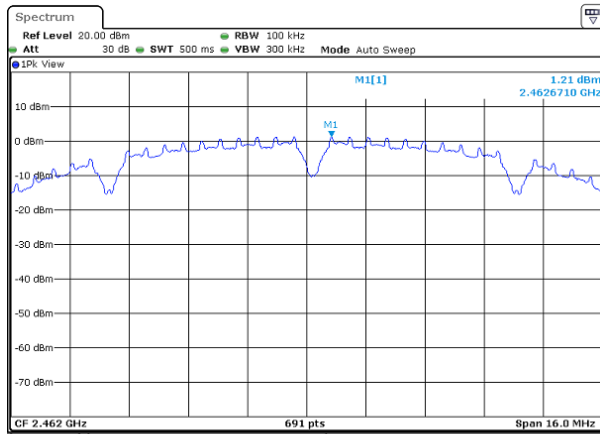

Date: 28.MAR.2019 18:46:26

### Band Edge

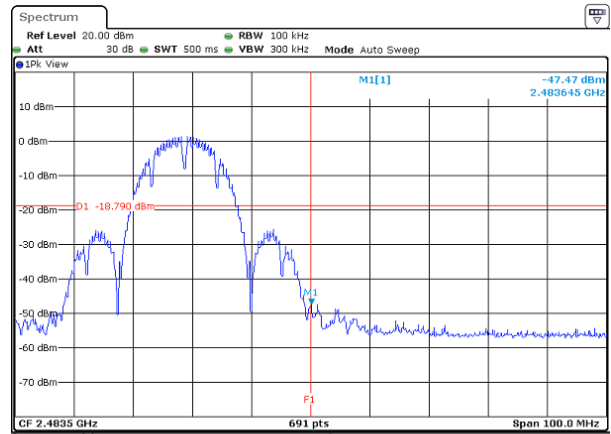

Date: 28.MAR.2019 18:50:01

### Spurious Emission 30MHz-25GHz

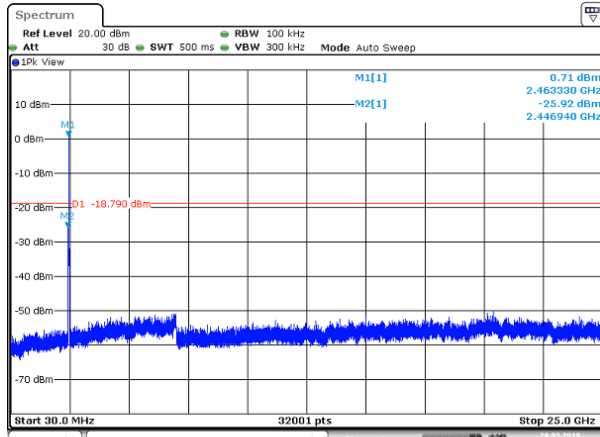

Date: 28.MAR.2019 18:47:23

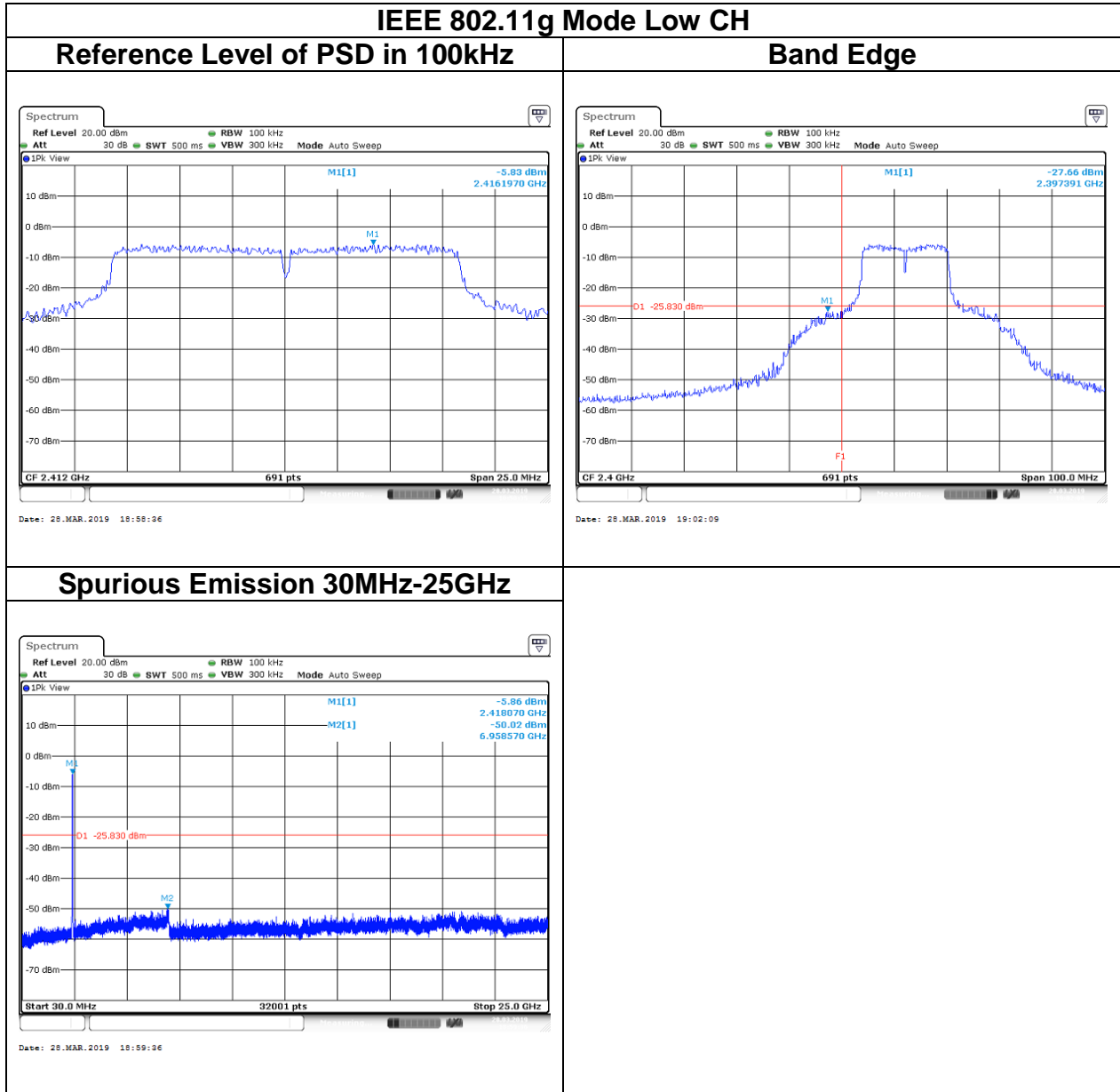



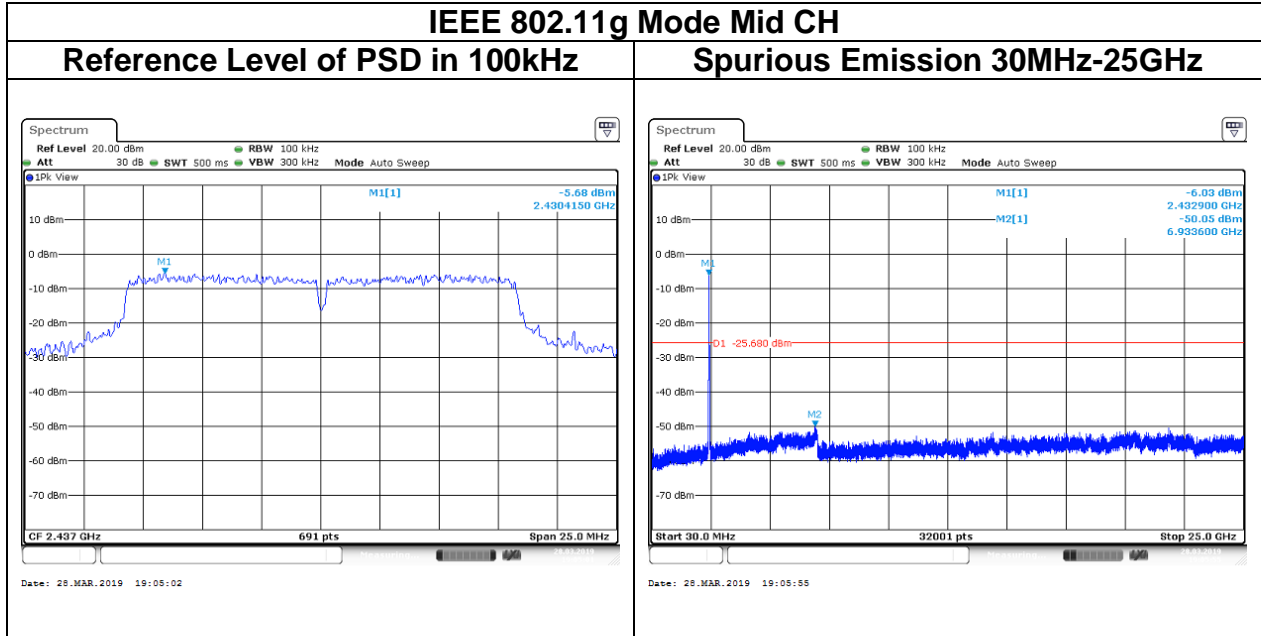

## IEEE 802.11g Mode High CH

### Reference Level of PSD in 100kHz

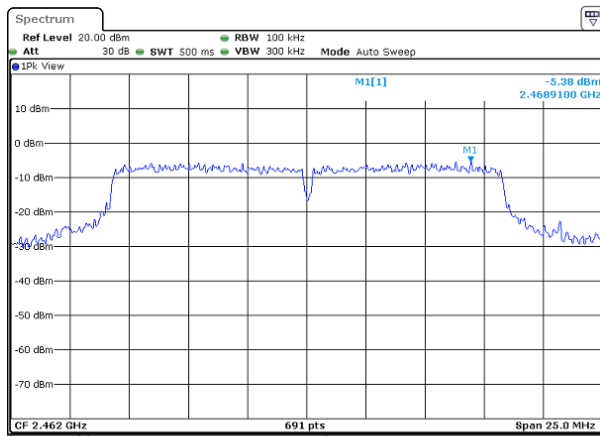

### Band Edge

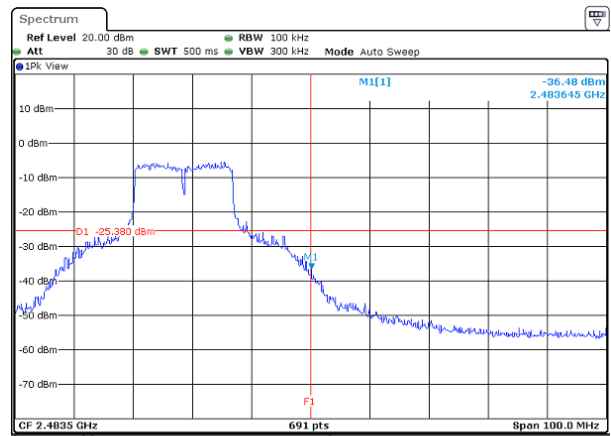

### Spurious Emission 30MHz-25GHz

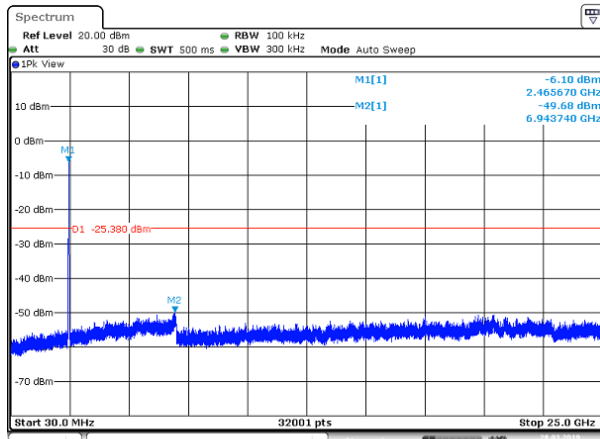

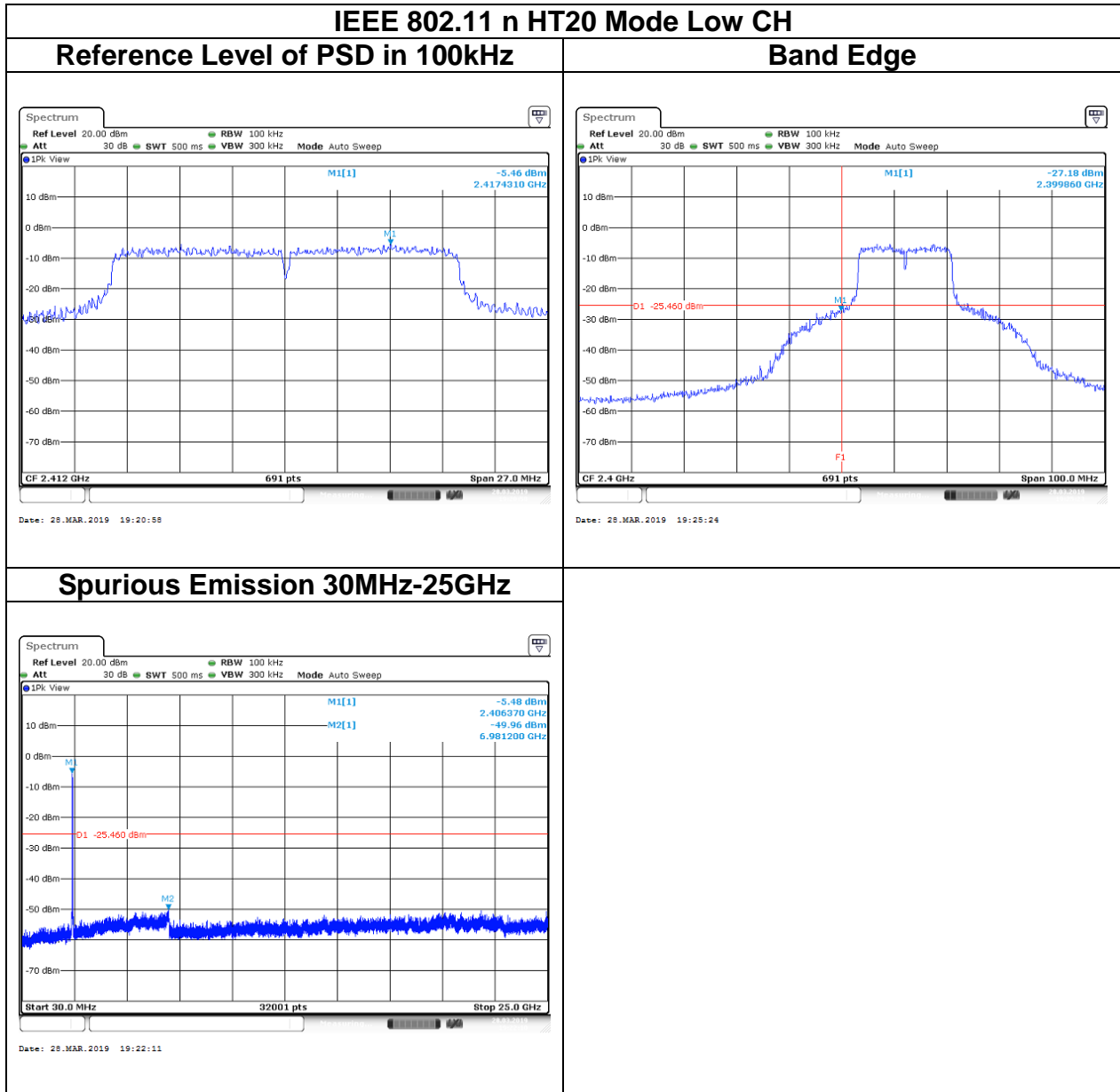

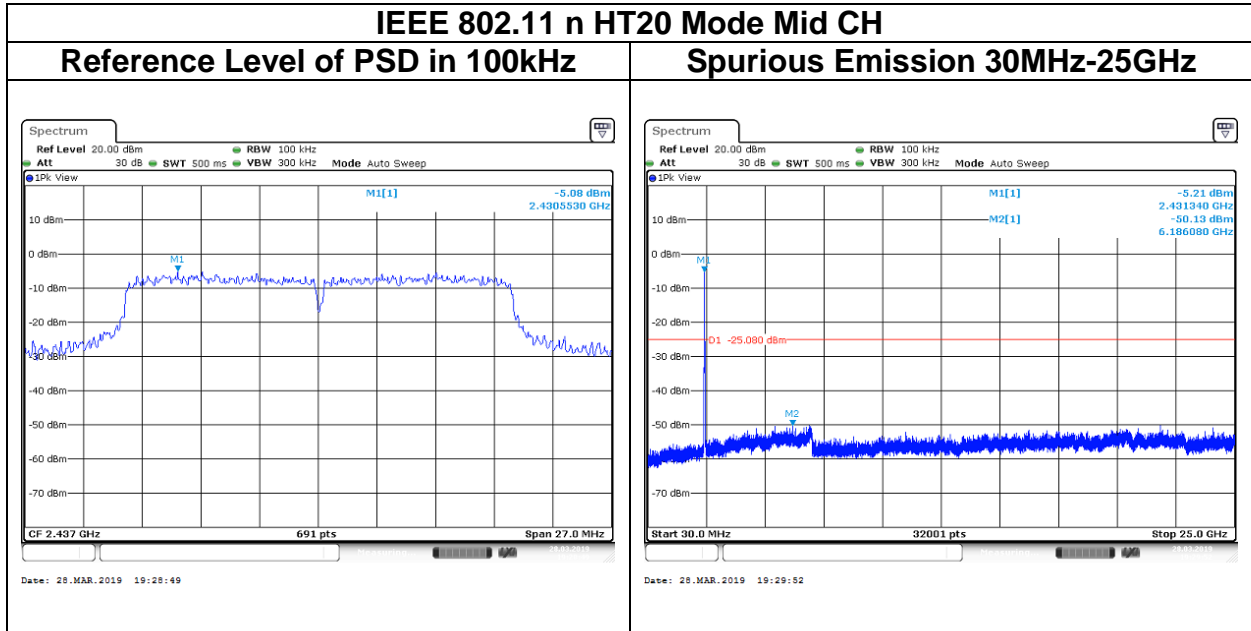

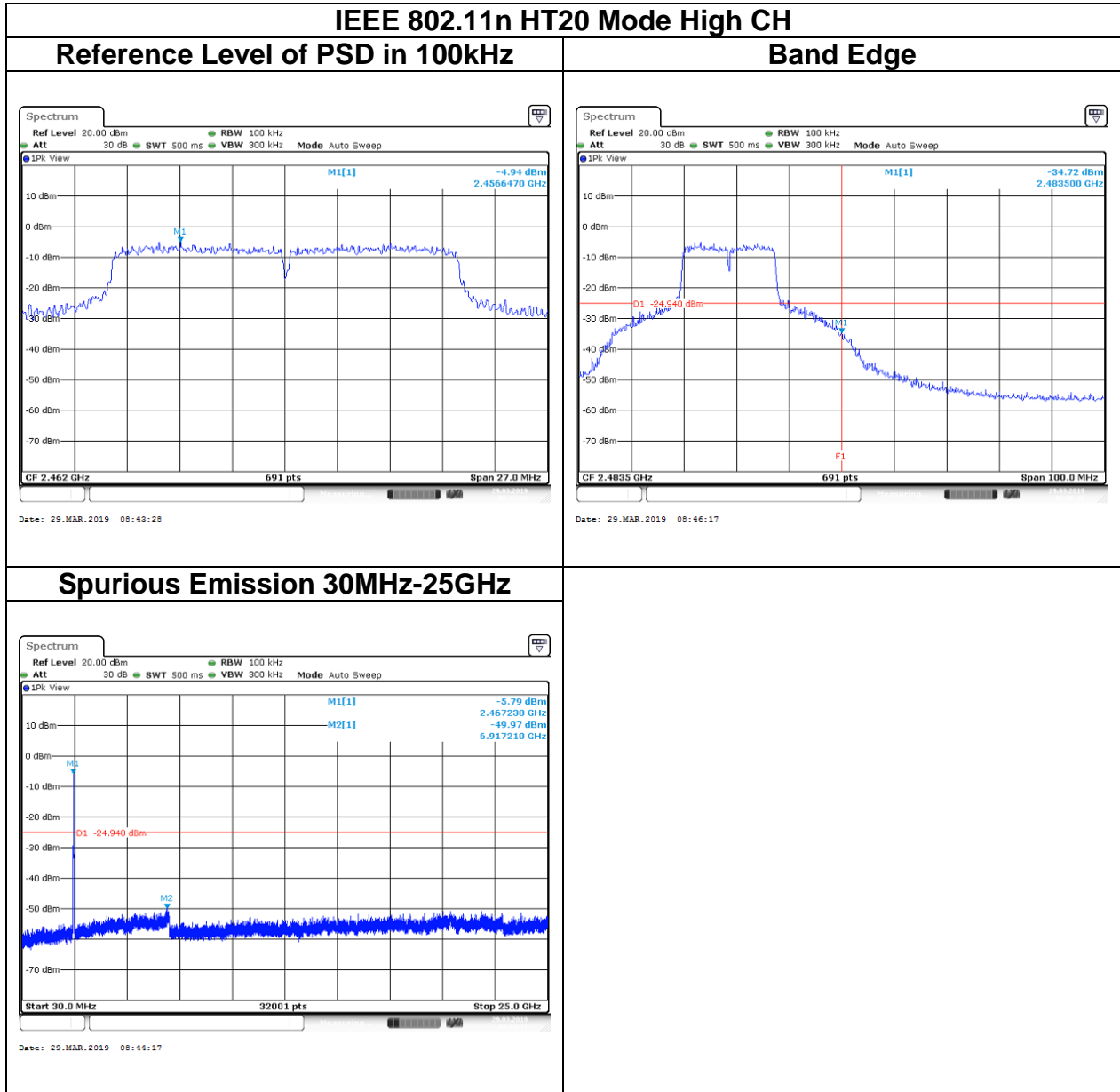

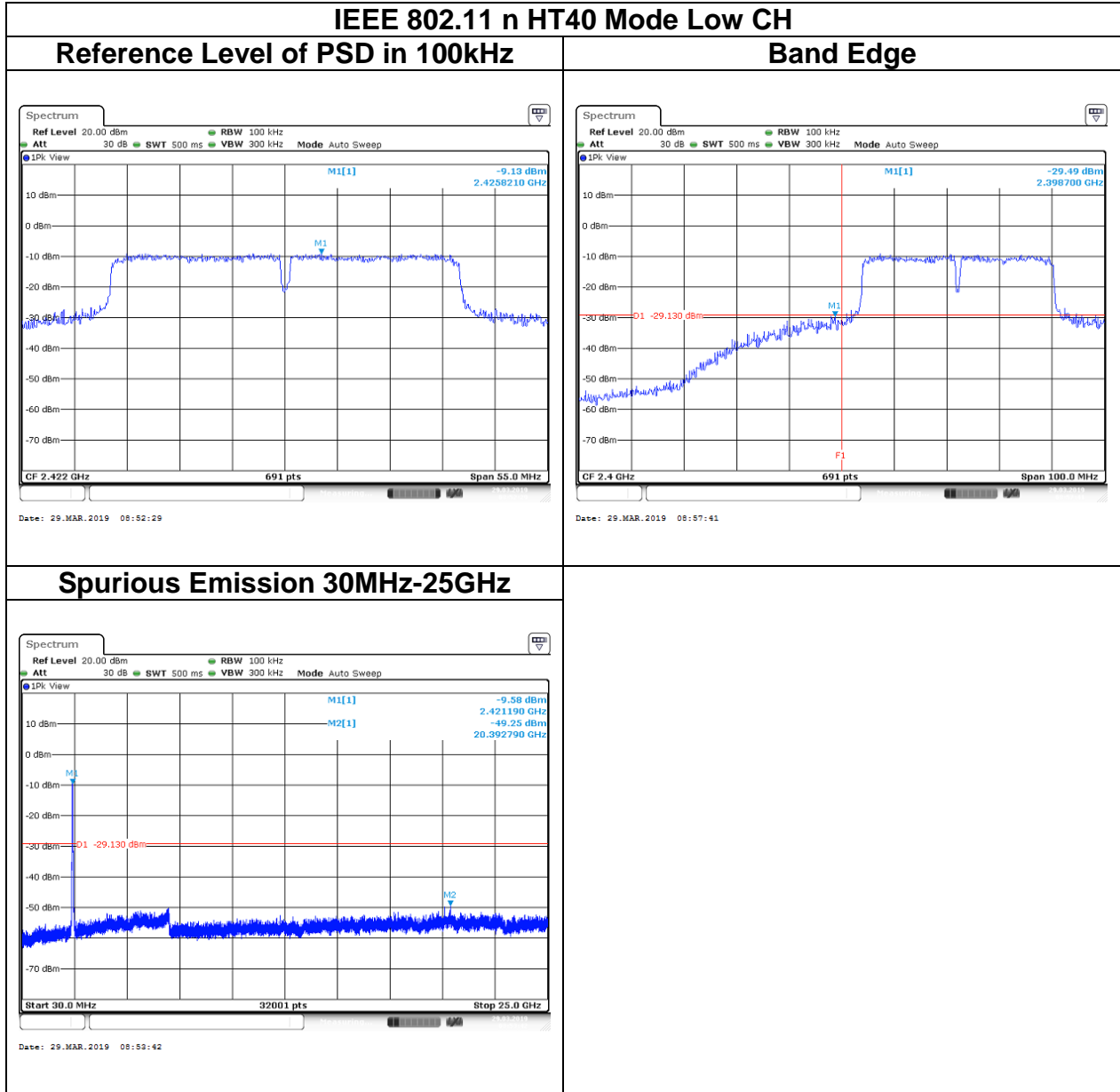

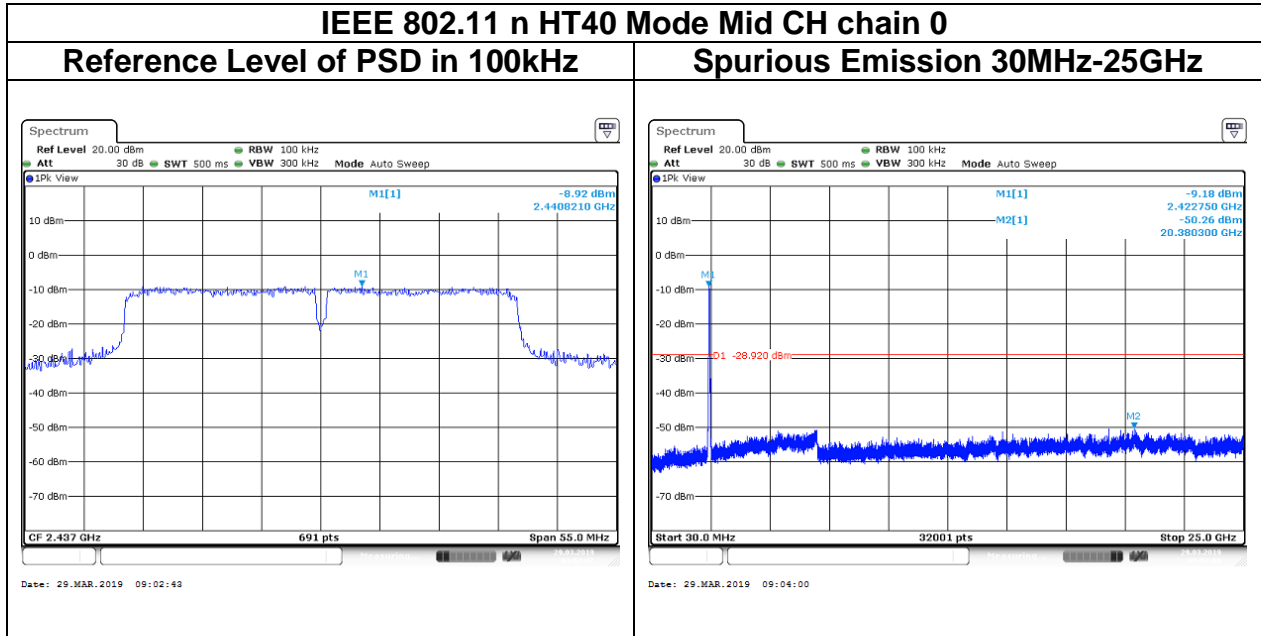

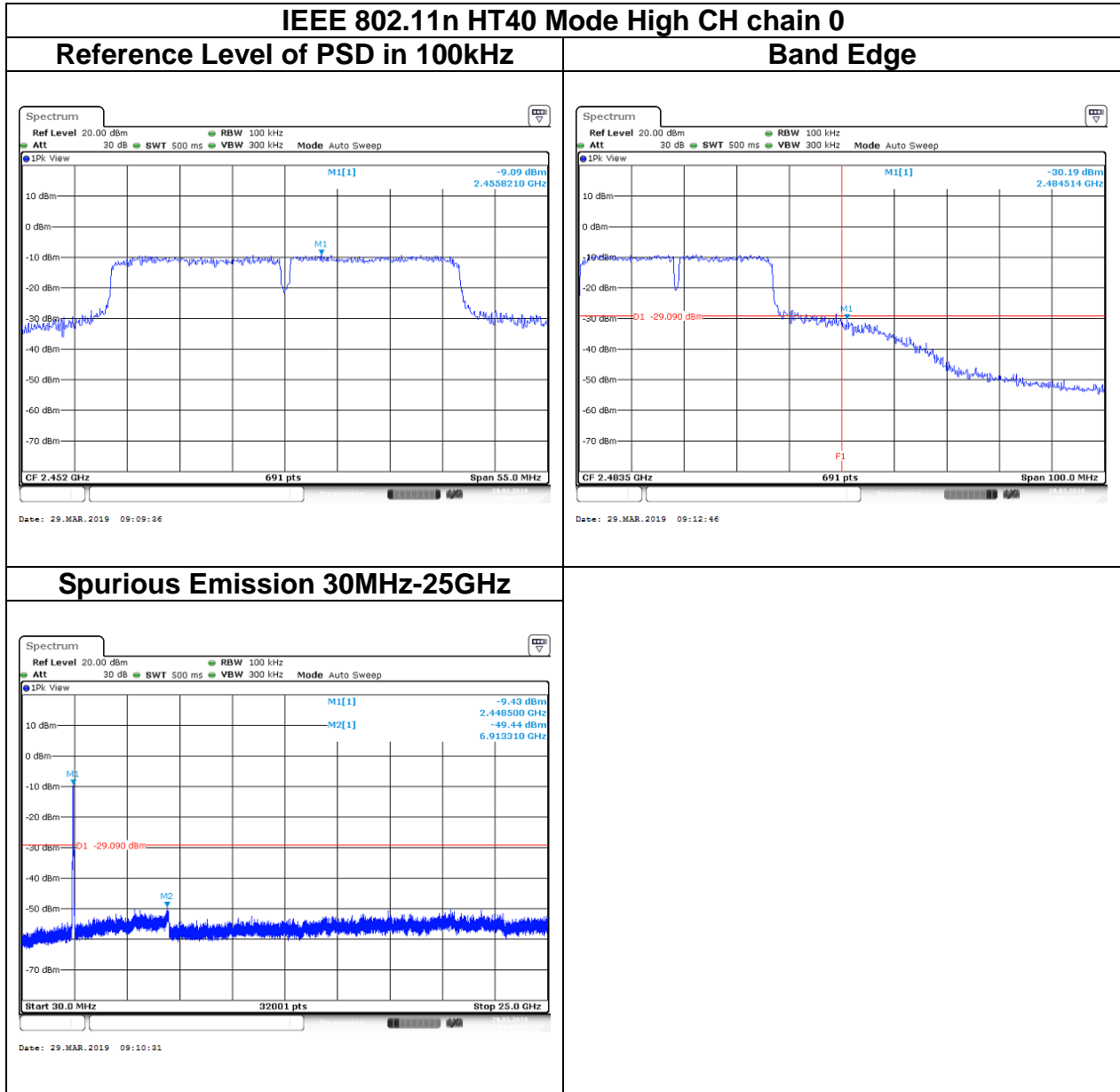



## 5.6 RADIATION BANDEDGE AND SPURIOUS EMISSION

### 5.6.1 Test Limit

FCC according to §15.247(d), §15.209 and §15.205,

IC according to RSS-247 section 5.5, RSS-Gen, Section 8.9 and 8.10

In any 100 kHz bandwidth outside the authorized frequency band, all harmonic and spurious must be least 20 dB below the highest emission level with the authorized frequency band. Radiation emission which fall in the restricted bands must also follow the FCC section 15.209 as below limit in table.

#### FCC

##### Below 30 MHz

Frequency	Field Strength (microvolts/m)	Magnetic H-Field (microamperes/m)	Measurement Distance (metres)
9-490 kHz	2,400/F (F in kHz)	2,400/F (F in kHz)	300
490-1,705 kHz	24,000/F (F in kHz)	24,000/F (F in kHz)	30
1.705-30 MHz	30	N/A	30

##### Above 30 MHz

Frequency	Field Strength (microvolts/m)	Measurement Distance (metres)
30-88	100	3
88-216	150	3
216-960	200	3
Above 960	500	3

**IC**
**RSS-Gen Table 3 and Table 5 – General Field Strength Limits for Transmitters and Receivers at Frequencies Above 30 MHz (Note)**

Frequency (MHz)	Field Strength microvolts/m at 3 metres (watts, e.i.r.p.)	
	Transmitters	Receivers
30-88	100 (3 nW)	100 (3 nW)
88-216	150 (6.8 nW)	150 (6.8 nW)
216-960	200 (12 nW)	200 (12 nW)
Above 960	500 (75 nW)	500 (75 nW)

**Note:** Measurements for compliance with the limits in table 3 may be performed at distances other than 3 metres, in accordance with Section 6.6.

**RSS-Gen Table 6: General Field Strength Limits for Transmitters at Frequencies Below 30 MHz (Transmit)**

Frequency	Magnetic field strength (H-Field) ( $\mu\text{A/m}$ )	Measurement Distance (m)
9-490 kHz <sup>Note</sup>	6.37/F (F in kHz)	300
490-1,705 kHz	63.7/F (F in kHz)	30
1.705-30 MHz	0.08	30

**Note:** The emission limits for the ranges 9-90 kHz and 110-490 kHz are based on measurements employing a linear average detector..

### 5.6.2 Test Procedure

Test method Refer as KDB 558074 D01.

1. The EUT is placed on a turntable, Above 1 GHz is 1.5m and below 1 GHz is 0.8m above ground plane. The EUT Configured un accordance with ANSI C63.10: 2013, and the EUT set in a continuous mode.

2. The turntable shall be rotated for 360 degrees to determine the position of maximum emission level. And EUT is set 3m away from the receiving antenna, which is scanned from 1m to 4m above the ground plane to find out the highest emissions. Measurement are made polarized in both the vertical and the horizontal positions with antenna.

3. Span shall wide enough to full capture the emission measured. The SA from 9kHz to 26.5GHz set to the low, Mid and High channels with the EUT transmit.

Note: No emission found between lowest internal used/generated frequency to 30MHz (9KHz~30MHz)

Remark:

Although these tests were performed other than open area test site, adequate comparison measurements were confirmed against 30 m open are test site. Therefore sufficient tests were made to demonstrate that the alternative site produces results that correlate with the ones of tests made in an open field based on KDB 414788.

4. The SA setting following :

(1) Below 1G : RBW = 100kHz, VBW ≥ 3 RBW, Sweep = Auto, Detector = Peak, Trace = Max hold.

(2) Above 1G :

(2.1) For Peak measurement : RBW = 1MHz, VBW ≥ 3 RBW, Sweep = Auto, Detector = Peak, Trace = Max hold.

(2.2) For Average measurement : RBW = 1MHz, VBW

·If Duty Cycle ≥ 98%, VBW=10Hz.

·If Duty Cycle < 98%, VBW=1/T.

Configuration	Duty Cycle (%)	T(ms)	1/T (kHz)	VBW Setting
802.11b	100%	1.0000	-	10
802.11g	100%	1.0000	-	10
802.11n HT20	100%	1.0000	-	10
802.11n HT40	100%	1.0000	-	10

## 5.6.3 Test Setup

### 9kHz ~ 30MHz

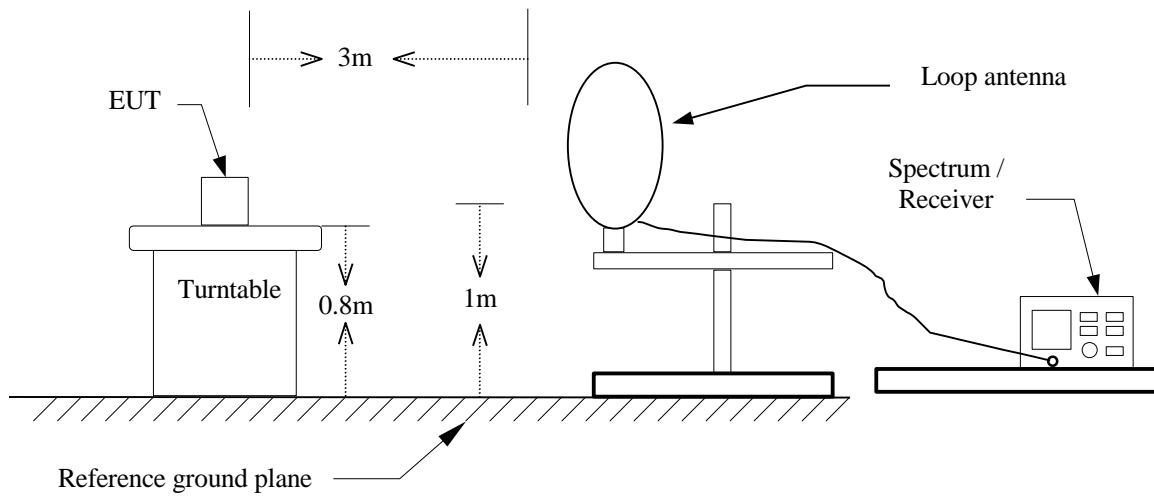

### 30MHz ~ 1GHz

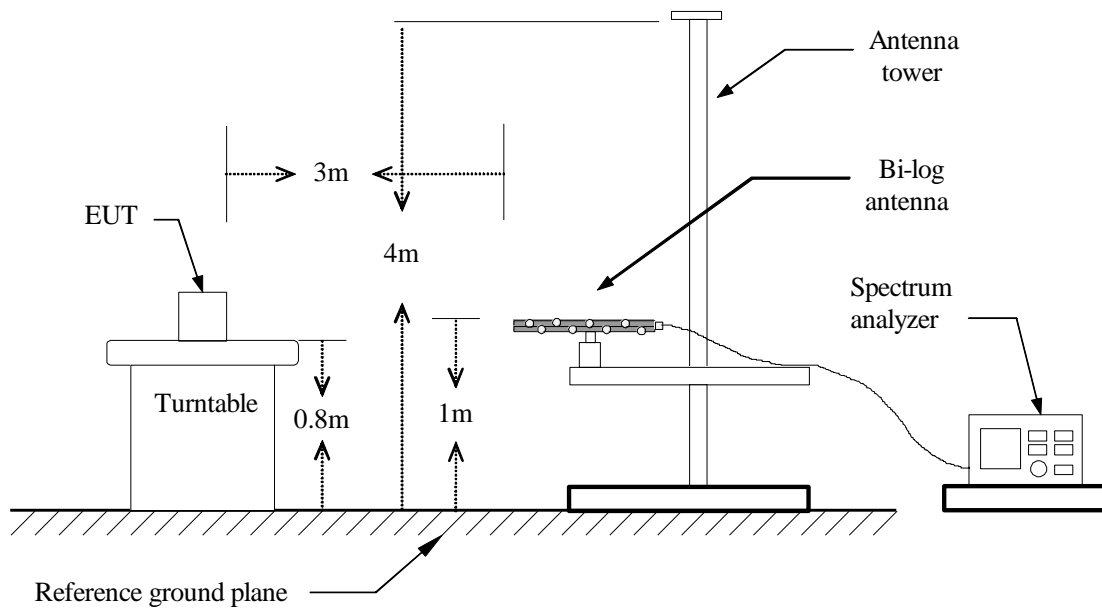

## Above 1 GHz

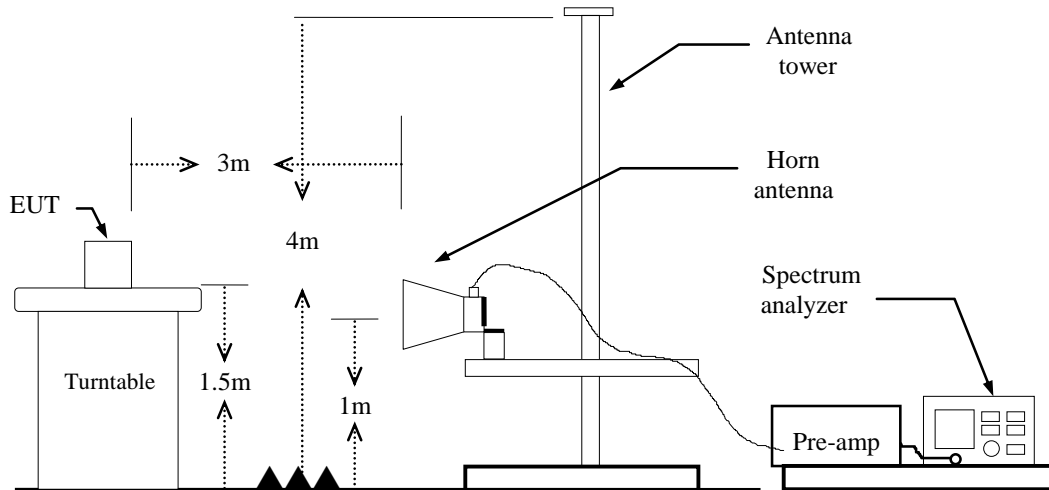

### 5.6.4 Test Result

#### Band Edge Test Data

Test Mode	IEEE 802.11b Low CH	Temp/Hum	24(°C)/ 60%RH
Test Item	Band Edge	Test Date	April 08, 2019
Polarize	Horizontal	Test Engineer	Dally Hong

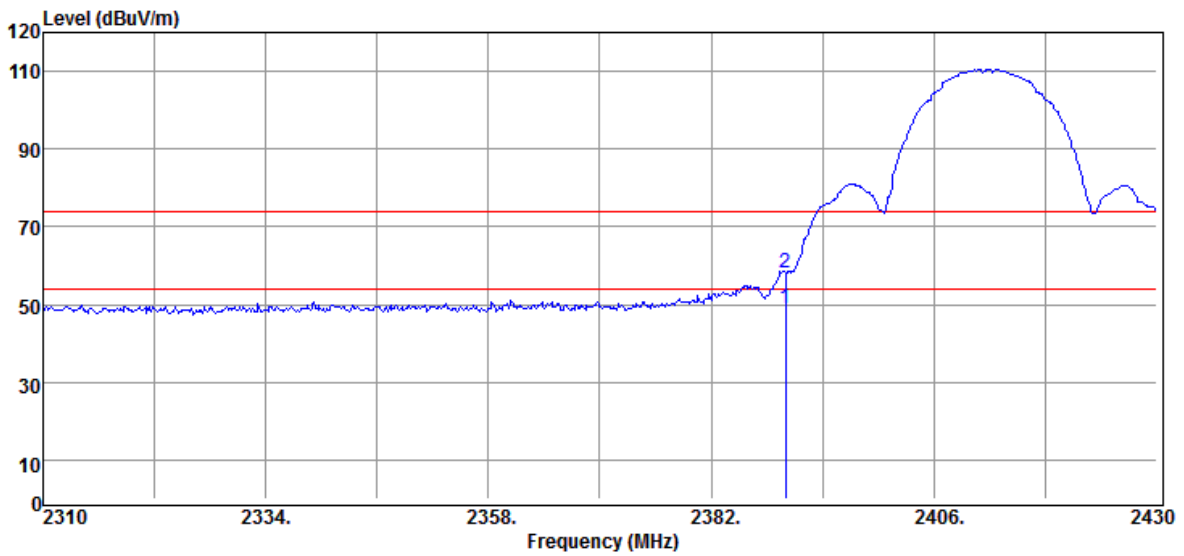

Frequency (MHz)	Reading (dBuV)	Correct Factor (dB/m)	Result (dBuV/m)	Limit (dBuV/m)	Margin (dB)	Remark
2390.00	52.15	-3.33	48.82	54.00	-5.18	Average
2390.00	61.58	-3.33	58.25	74.00	-15.75	Peak

Test Mode	IEEE 802.11b High CH	Temp/Hum	24(°C)/ 60%RH
Test Item	Band Edge	Test Date	April 08, 2019
Polarize	Horizontal	Test Engineer	Dally Hong

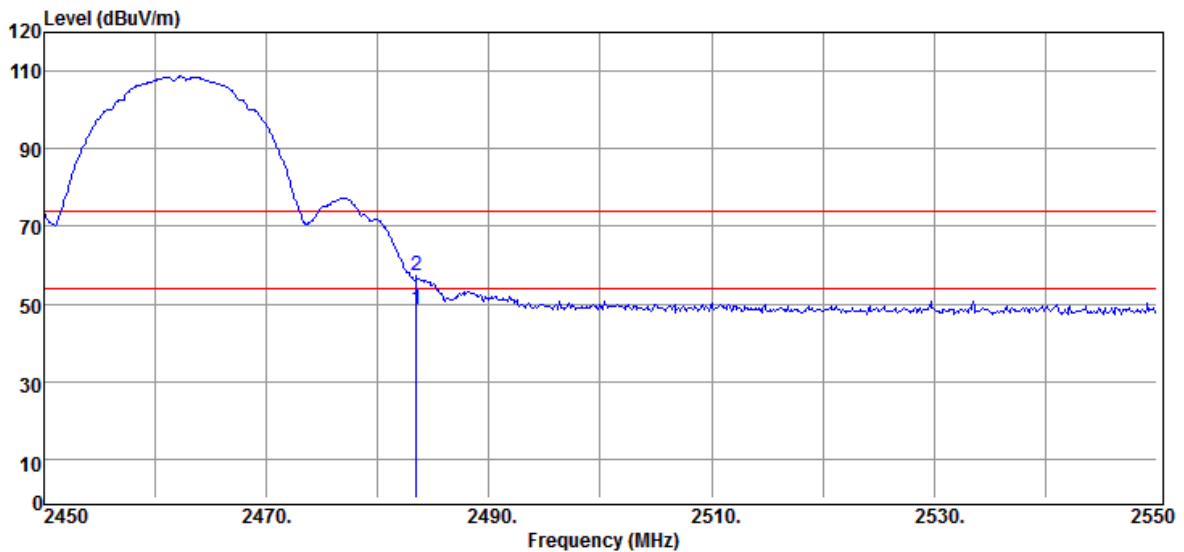

Frequency (MHz)	Reading (dBuV)	Correct Factor (dB/m)	Result (dBuV/m)	Limit (dBuV/m)	Margin (dB)	Remark
2483.50	51.26	-2.72	48.54	54.00	-5.46	Average
2483.50	59.84	-2.72	57.12	74.00	-16.88	Peak

Test Mode	IEEE 802.11g Low CH	Temp/Hum	24(°C)/ 60%RH
Test Item	Band Edge	Test Date	April 08, 2019
Polarize	Horizontal	Test Engineer	Dally Hong

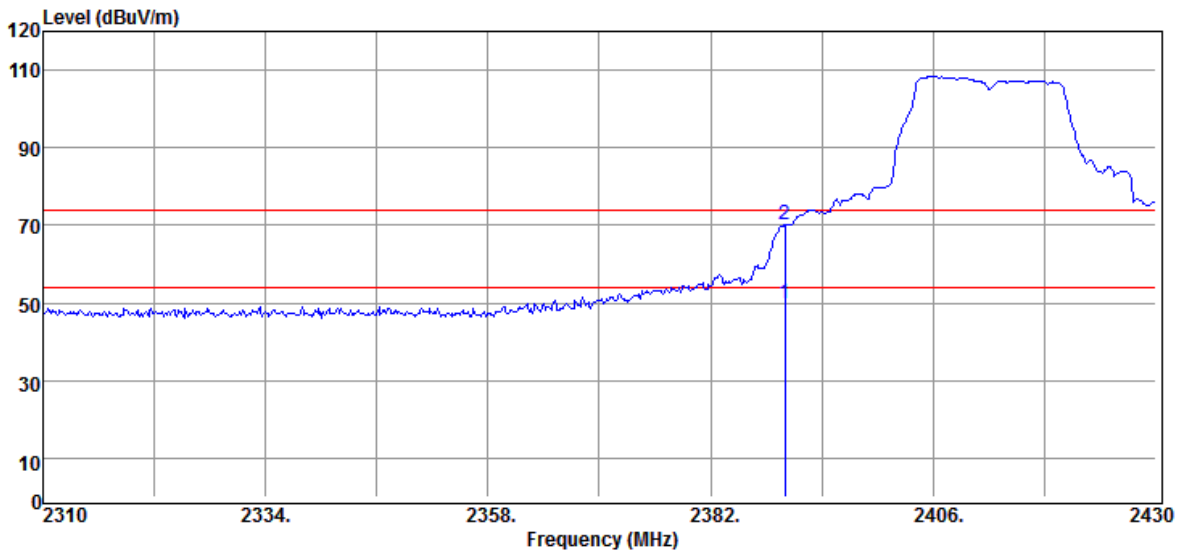

Frequency (MHz)	Reading (dBuV)	Correct Factor (dB/m)	Result (dBuV/m)	Limit (dBuV/m)	Margin (dB)	Remark
2390.00	53.22	-3.33	49.89	54.00	-4.11	Average
2390.00	73.41	-3.33	70.08	74.00	-3.92	Peak



Test Mode	IEEE 802.11g High CH	Temp/Hum	24(°C)/ 60%RH
Test Item	Band Edge	Test Date	April 08, 2019
Polarize	Horizontal	Test Engineer	Dally Hong

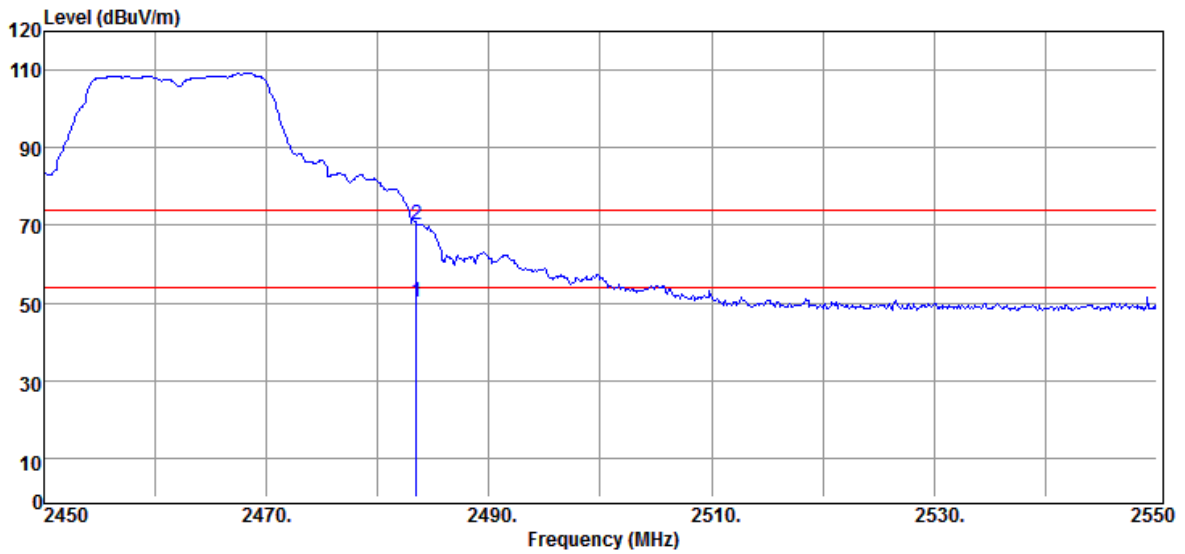

Frequency (MHz)	Reading (dBuV)	Correct Factor (dB/m)	Result (dBuV/m)	Limit (dBuV/m)	Margin (dB)	Remark
2483.50	53.02	-2.72	50.30	54.00	-3.70	Average
2483.50	72.86	-2.72	70.14	74.00	-3.86	Peak

Test Mode	IEEE 802.11n HT20 Low CH	Temp/Hum	24(°C)/ 60%RH
Test Item	Band Edge	Test Date	April 08, 2019
Polarize	Horizontal	Test Engineer	Dally Hong

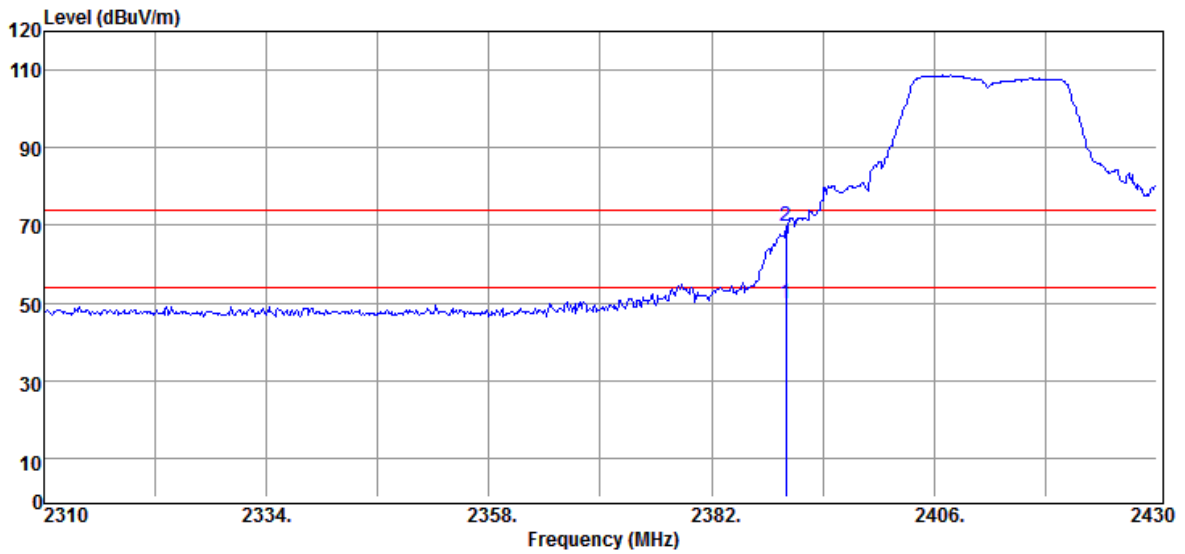

Frequency (MHz)	Reading (dBuV)	Correct Factor (dB/m)	Result (dBuV/m)	Limit (dBuV/m)	Margin (dB)	Remark
2390.00	53.17	-3.33	49.84	54.00	-4.16	Average
2390.00	73.24	-3.33	69.91	74.00	-4.09	Peak

Test Mode	IEEE 802.11n HT20 High CH	Temp/Hum	24(°C)/ 60%RH
Test Item	Band Edge	Test Date	April 08, 2019
Polarize	Horizontal	Test Engineer	Dally Hong

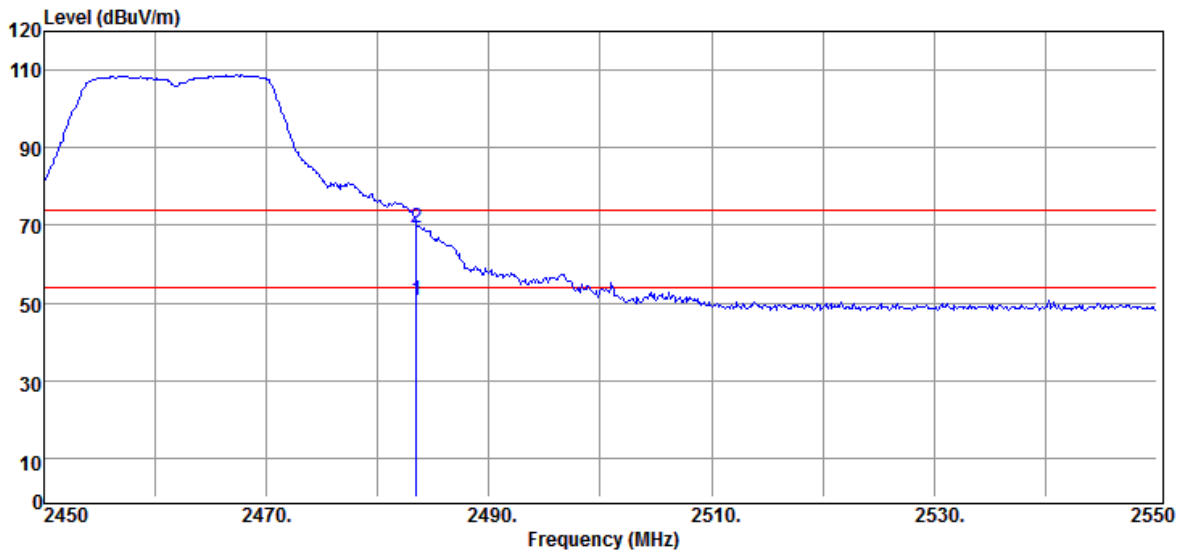

Frequency (MHz)	Reading (dBuV)	Correct Factor (dB/m)	Result (dBuV/m)	Limit (dBuV/m)	Margin (dB)	Remark
2483.50	53.39	-2.72	50.67	54.00	-3.33	Average
2483.50	72.04	-2.72	69.32	74.00	-4.68	Peak

Test Mode	IEEE 802.11n HT40 Low CH	Temp/Hum	24(°C)/ 60%RH
Test Item	Band Edge	Test Date	April 08, 2019
Polarize	Horizontal	Test Engineer	Dally Hong

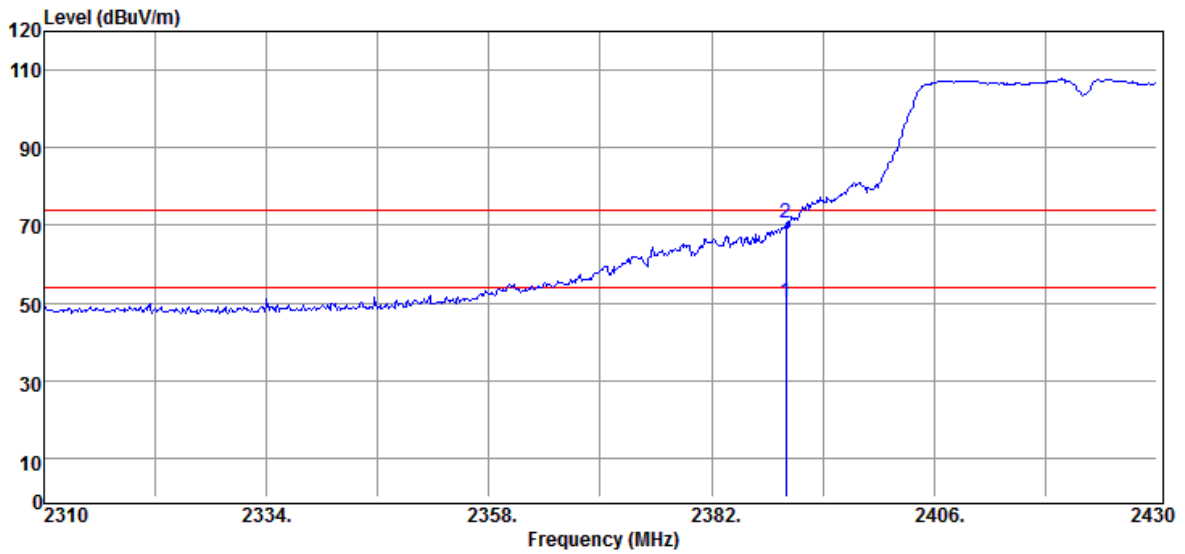

Frequency (MHz)	Reading (dBuV)	Correct Factor (dB/m)	Result (dBuV/m)	Limit (dBuV/m)	Margin (dB)	Remark
2390.00	53.68	-3.33	50.35	54.00	-3.65	Average
2390.00	73.77	-3.33	70.44	74.00	-3.56	Peak

Test Mode	IEEE 802.11n HT40 High CH	Temp/Hum	24(°C)/ 60%RH
Test Item	Band Edge	Test Date	April 08, 2019
Polarize	Horizontal	Test Engineer	Dally Hong

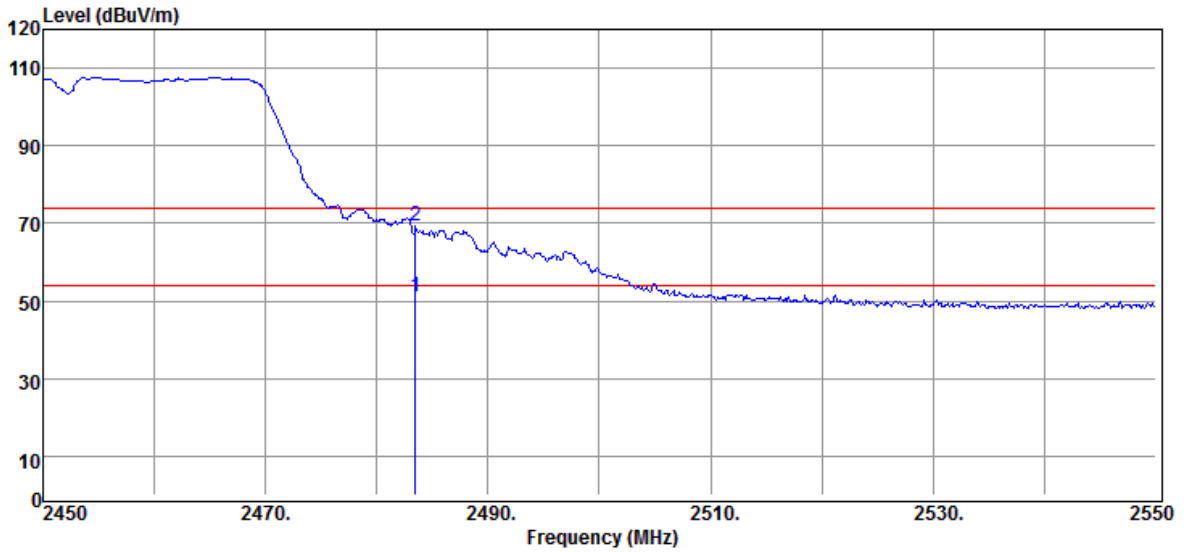

Frequency (MHz)	Reading (dBuV)	Correct Factor (dB/m)	Result (dBuV/m)	Limit (dBuV/m)	Margin (dB)	Remark
2483.50	53.62	-2.72	50.90	54.00	-3.10	Average
2483.50	72.09	-2.72	69.37	74.00	-4.63	Peak

**Below 1G Test Data**

Test Mode	Mode 1	Temp/Hum	22(°C)/ 60%RH
Test Item	30MHz-1GHz	Test Date	April 12, 2019
Polarize	Vertical	Test Engineer	Dally Hong
Detector	Peak	Test Voltage	

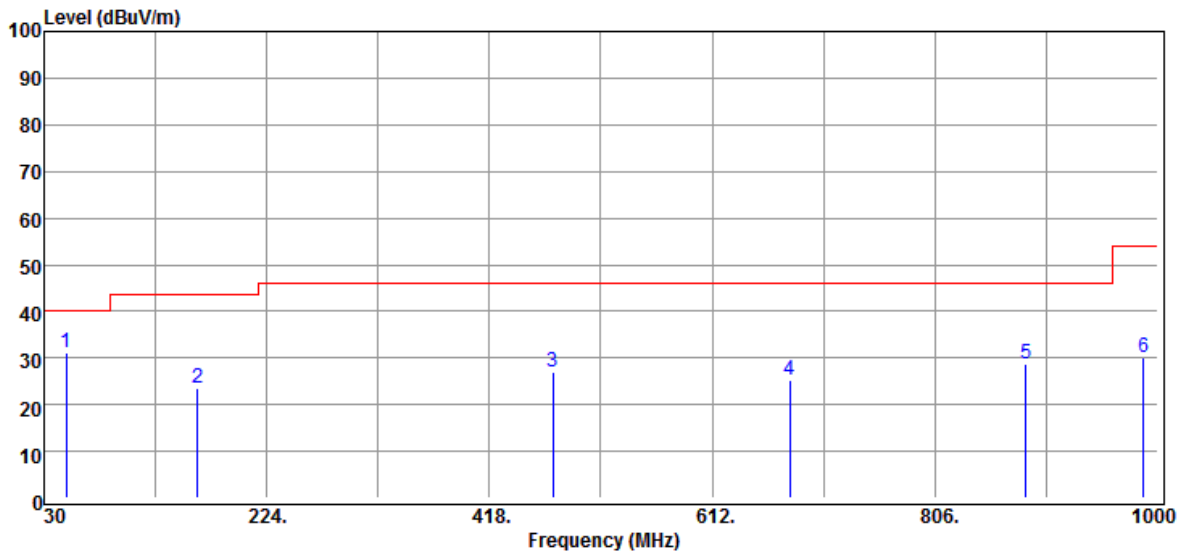

Frequency (MHz)	Reading (dBuV)	Correct Factor (dB/m)	Result (dBuV/m)	Limit (dBuV/m)	Margin (dB)	Remark
49.40	46.12	-14.98	31.14	40.00	-8.86	Peak
163.86	33.85	-10.24	23.61	43.50	-19.89	Peak
473.29	30.28	-3.23	27.05	46.00	-18.95	Peak
679.90	25.58	-0.24	25.34	46.00	-20.66	Peak
885.54	24.78	3.79	28.57	46.00	-17.43	Peak
987.39	24.72	5.46	30.18	54.00	-23.82	Peak

Note: No emission found between lowest internal used/generated frequency to 30MHz(9KHz~30MHz)

Test Mode	Mode 1	Temp/Hum	22(°C)/ 60%RH
Test Item	30MHz-1GHz	Test Date	April 12, 2019
Polarize	Horizontal	Test Engineer	Dally Hong
Detector	Peak	Test Voltage	

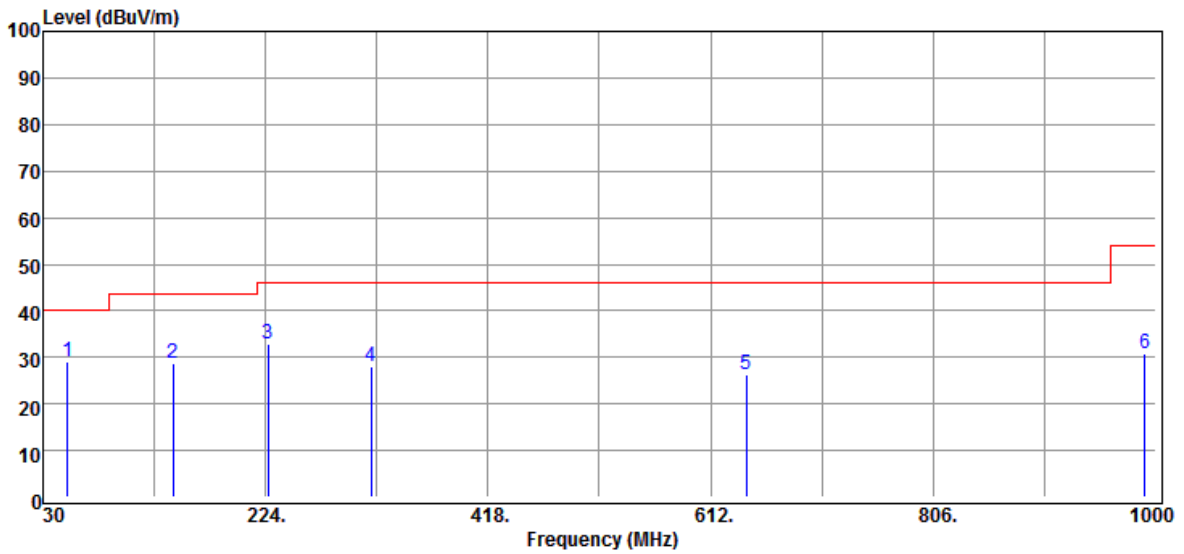

Frequency (MHz)	Reading (dBuV)	Correct Factor (dB/m)	Result (dBuV/m)	Limit (dBuV/m)	Margin (dB)	Remark
51.34	44.48	-15.57	28.91	40.00	-11.09	Peak
143.49	38.74	-9.86	28.88	43.50	-14.62	Peak
225.94	44.10	-11.07	33.03	46.00	-12.97	Peak
316.15	35.78	-7.59	28.19	46.00	-17.81	Peak
643.04	26.67	-0.30	26.37	46.00	-19.63	Peak
990.30	25.42	5.31	30.73	54.00	-23.27	Peak

Note: No emission found between lowest internal used/generated frequency to 30MHz(9KHz~30MHz)

**Above 1G Test Data**

Test Mode	IEEE 802.11b Low CH	Temp/Hum	23(°C)/ 63%RH
Test Item	Harmonic	Test Date	April 08, 2019
Polarize	Vertical	Test Engineer	Dally Hong
Detector	Peak and Average	Test Voltage	

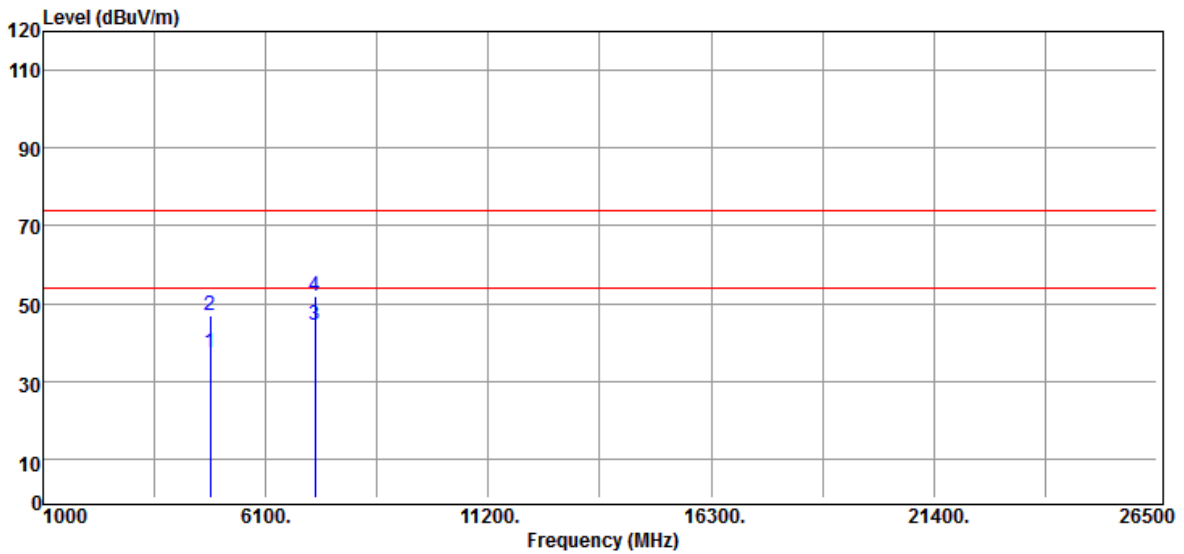

Frequency (MHz)	Reading (dBuV)	Correct Factor (dB/m)	Result (dBuV/m)	Limit (dBuV/m)	Margin (dB)	Remark
4824.00	34.51	2.75	37.26	54.00	-16.74	Average
4824.00	43.97	2.75	46.72	74.00	-27.28	Peak
7236.00	34.15	10.15	44.30	54.00	-9.70	Average
7236.00	41.78	10.15	51.93	74.00	-22.07	Peak
N/A						

**Remark:**

1. Measuring frequencies from 1 GHz to the 10th harmonic of highest fundamental frequency.



Test Mode	IEEE 802.11b Low CH	Temp/Hum	23(°C)/ 63%RH
Test Item	Harmonic	Test Date	April 08, 2019
Polarize	Horizontal	Test Engineer	Dally Hong
Detector	Peak and Average	Test Voltage	

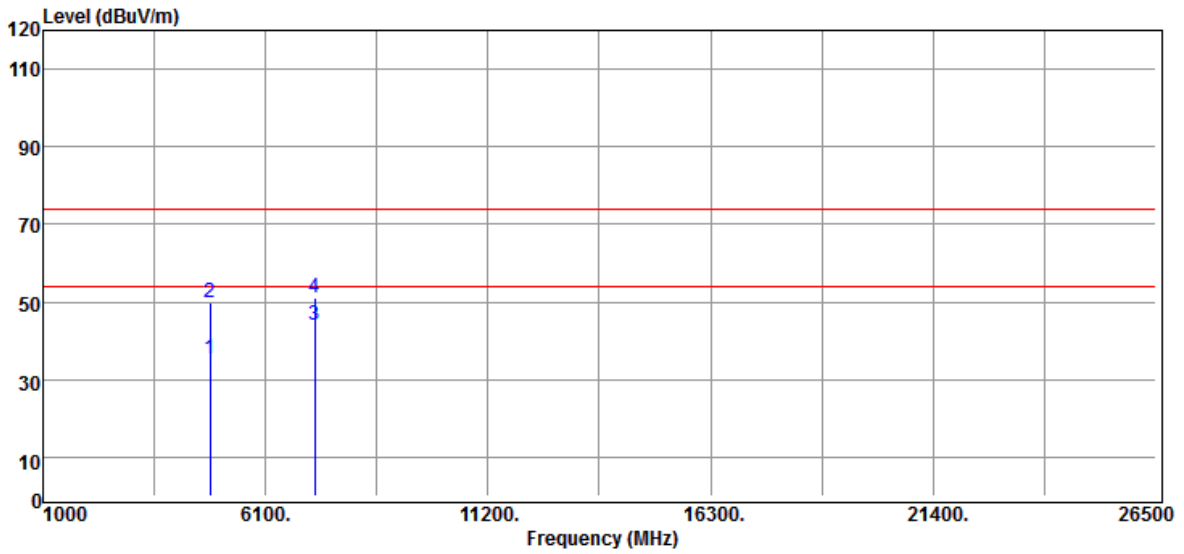

Frequency (MHz)	Reading (dBuV)	Correct Factor (dB/m)	Result (dBuV/m)	Limit (dBuV/m)	Margin (dB)	Remark
4824.00	32.65	2.75	35.40	54.00	-18.60	Average
4824.00	47.22	2.75	49.97	74.00	-24.03	Peak
7236.00	33.67	10.15	43.82	54.00	-10.18	Average
7236.00	40.81	10.15	50.96	74.00	-23.04	Peak
N/A						

**Remark:**

- Measuring frequencies from 1 GHz to the 10th harmonic of highest fundamental frequency.

Test Mode	IEEE 802.11b Mid CH	Temp/Hum	23(°C)/ 63%RH
Test Item	Harmonic	Test Date	April 08, 2019
Polarize	Vertical	Test Engineer	Dally Hong
Detector	Peak	Test Voltage	

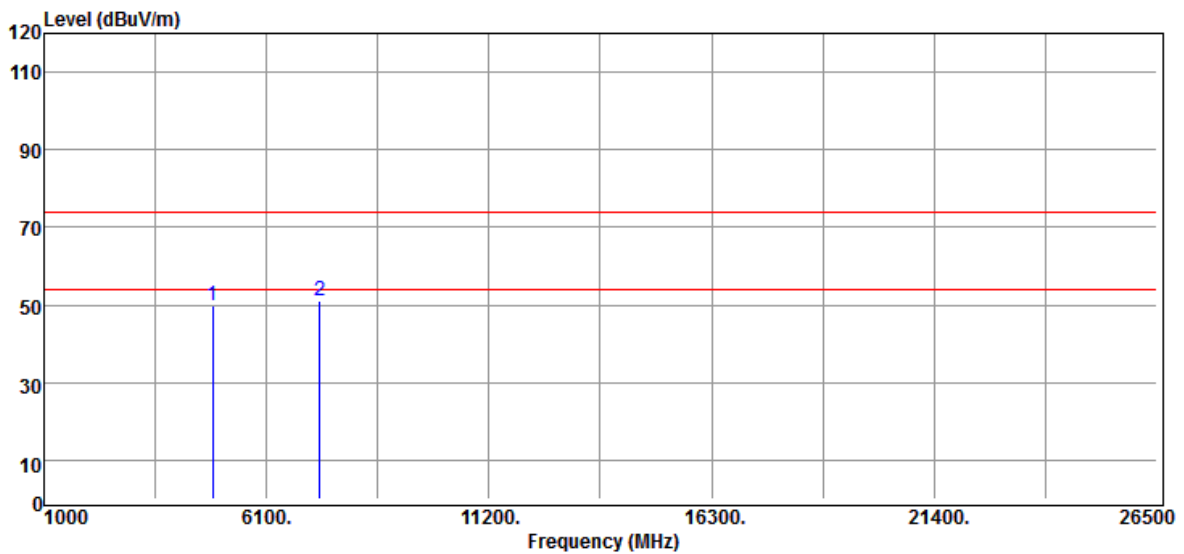

Frequency (MHz)	Reading (dBuV)	Correct Factor (dB/m)	Result (dBuV/m)	Limit (dBuV/m)	Margin (dB)	Remark
4874.00	46.88	2.95	49.83	74.00	-24.17	Peak
7311.00	40.80	10.20	51.00	74.00	-23.00	Peak
N/A						

**Remark:**

1. Measuring frequencies from 1 GHz to the 10th harmonic of highest fundamental frequency.
2. For above 1GHz, the EUT peak value was under average limit, therefore the Average value compliance with the average limit

Test Mode	IEEE 802.11b Mid CH	Temp/Hum	23(°C)/ 63%RH
Test Item	Harmonic	Test Date	April 08, 2019
Polarize	Horizontal	Test Engineer	Dally Hong
Detector	Peak and Average	Test Voltage	

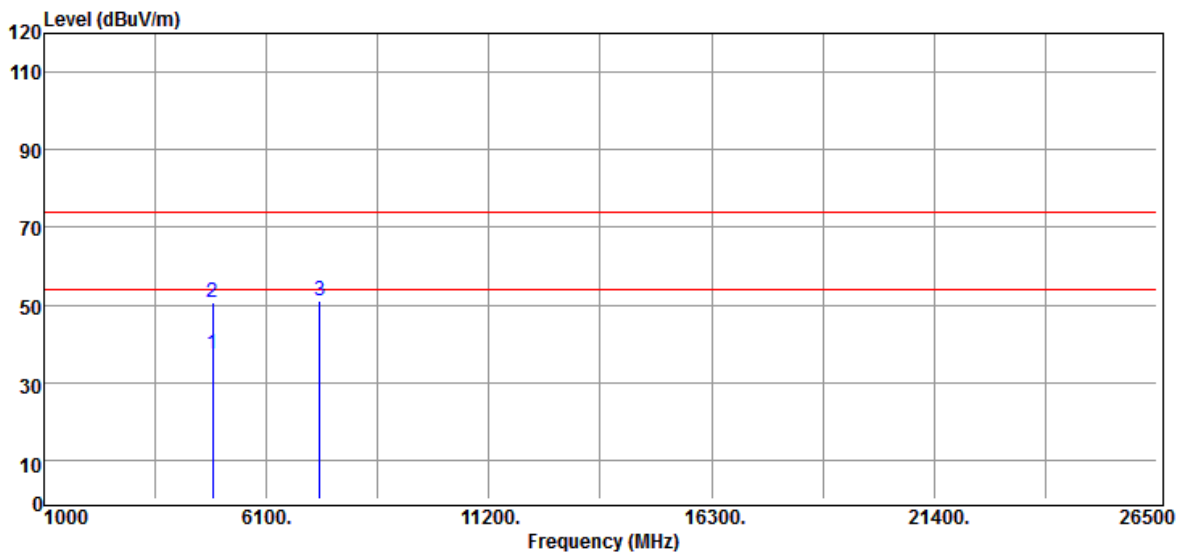

Frequency (MHz)	Reading (dBuV)	Correct Factor (dB/m)	Result (dBuV/m)	Limit (dBuV/m)	Margin (dB)	Remark
4874.00	34.53	2.95	37.48	54.00	-16.52	Average
4874.00	47.86	2.95	50.81	74.00	-23.19	Peak
7311.00	40.72	10.20	50.92	74.00	-23.08	Peak
N/A						

**Remark:**

- Measuring frequencies from 1 GHz to the 10th harmonic of highest fundamental frequency.

Test Mode	IEEE 802.11b High CH	Temp/Hum	23(°C)/ 63%RH
Test Item	Harmonic	Test Date	April 08, 2019
Polarize	Vertical	Test Engineer	Dally Hong
Detector	Peak and Average	Test Voltage	

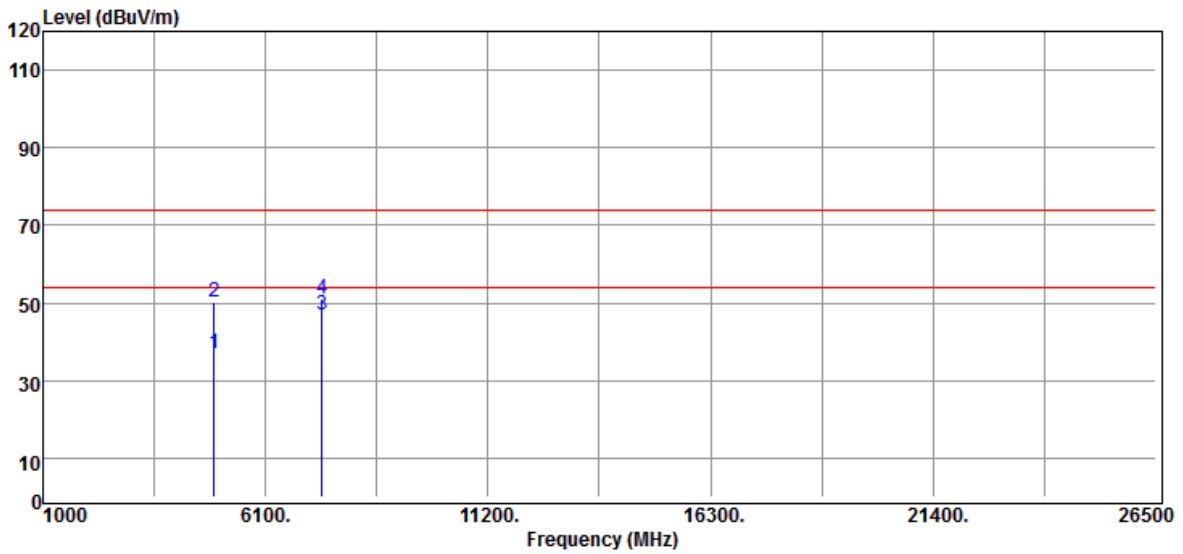

Frequency (MHz)	Reading (dBuV)	Correct Factor (dB/m)	Result (dBuV/m)	Limit (dBuV/m)	Margin (dB)	Remark
4924.00	33.77	3.34	37.11	54.00	-16.89	Average
4924.00	46.72	3.34	50.06	74.00	-23.94	Peak
7386.00	36.19	10.75	46.94	54.00	-7.06	Average
7386.00	40.30	10.75	51.05	74.00	-22.95	Peak
N/A						

**Remark:**

- Measuring frequencies from 1 GHz to the 10th harmonic of highest fundamental frequency.

Test Mode	IEEE 802.11b High CH	Temp/Hum	23(°C)/ 63%RH
Test Item	Harmonic	Test Date	April 08, 2019
Polarize	Horizontal	Test Engineer	Dally Hong
Detector	Peak and Average	Test Voltage	

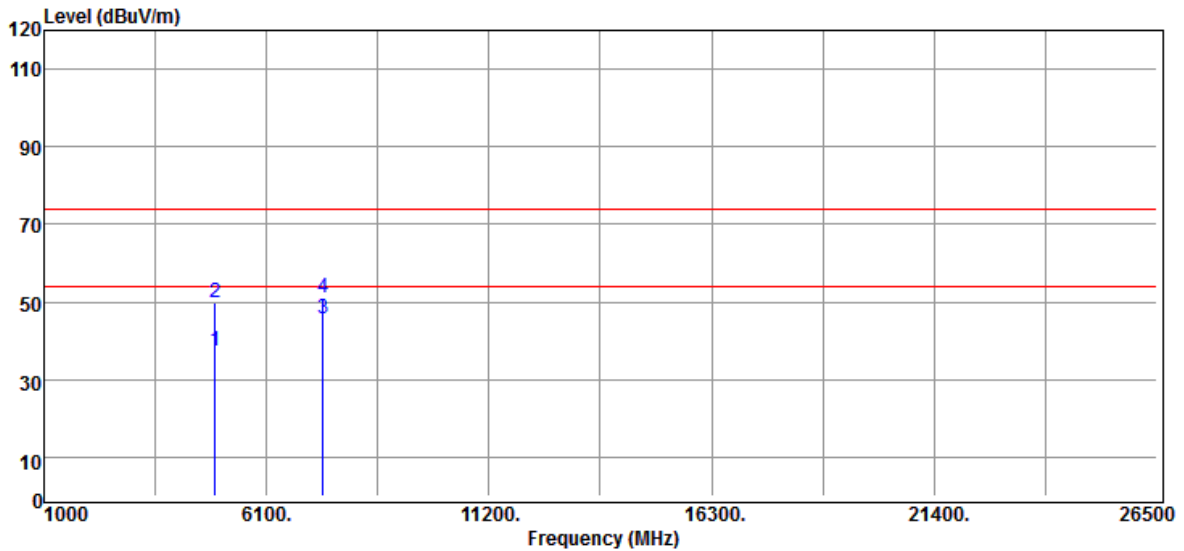

Frequency (MHz)	Reading (dBuV)	Correct Factor (dB/m)	Result (dBuV/m)	Limit (dBuV/m)	Margin (dB)	Remark
4924.00	33.94	3.34	37.28	54.00	-16.72	Average
4924.00	46.65	3.34	49.99	74.00	-24.01	Peak
7386.00	34.85	10.75	45.60	54.00	-8.40	Average
7386.00	40.32	10.75	51.07	74.00	-22.93	Peak
N/A						

**Remark:**

- Measuring frequencies from 1 GHz to the 10th harmonic of highest fundamental frequency.

Test Mode	IEEE 802.11g Low CH	Temp/Hum	23(°C)/ 63%RH
Test Item	Harmonic	Test Date	April 08, 2019
Polarize	Vertical	Test Engineer	Dally Hong
Detector	Peak and Average	Test Voltage	

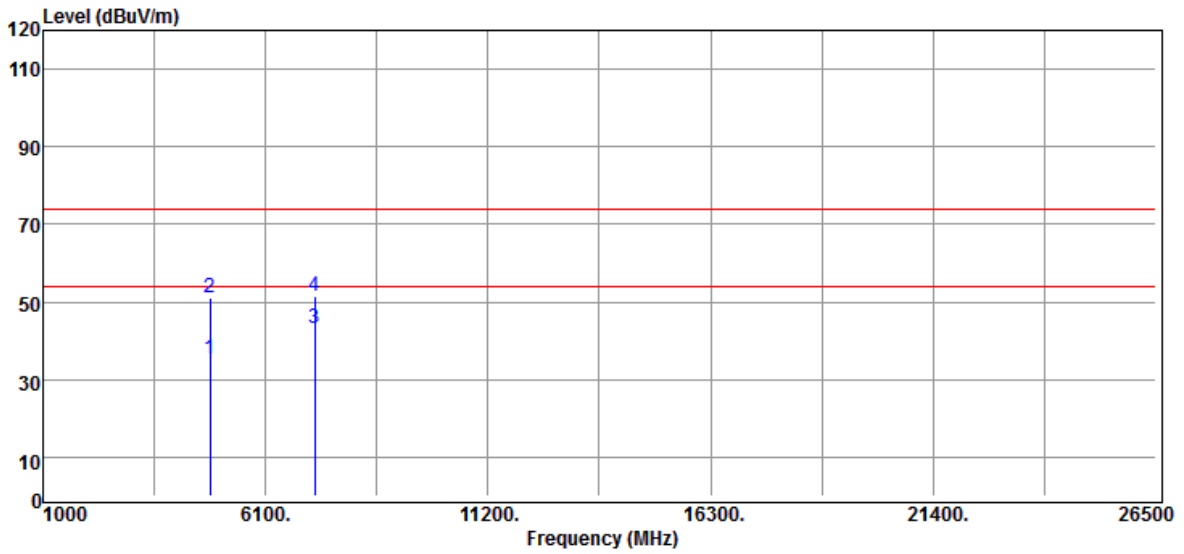

Frequency (MHz)	Reading (dBuV)	Correct Factor (dB/m)	Result (dBuV/m)	Limit (dBuV/m)	Margin (dB)	Remark
4824.00	32.51	2.75	35.26	54.00	-18.74	Average
4824.00	48.37	2.75	51.12	74.00	-22.88	Peak
7236.00	33.20	10.15	43.35	54.00	-10.65	Average
7236.00	41.15	10.15	51.30	74.00	-22.70	Peak
N/A						

**Remark:**

- Measuring frequencies from 1 GHz to the 10th harmonic of highest fundamental frequency.

Test Mode	IEEE 802.11g Low CH	Temp/Hum	23(°C)/ 63%RH
Test Item	Harmonic	Test Date	April 08, 2019
Polarize	Horizontal	Test Engineer	Dally Hong
Detector	Peak and Average	Test Voltage	

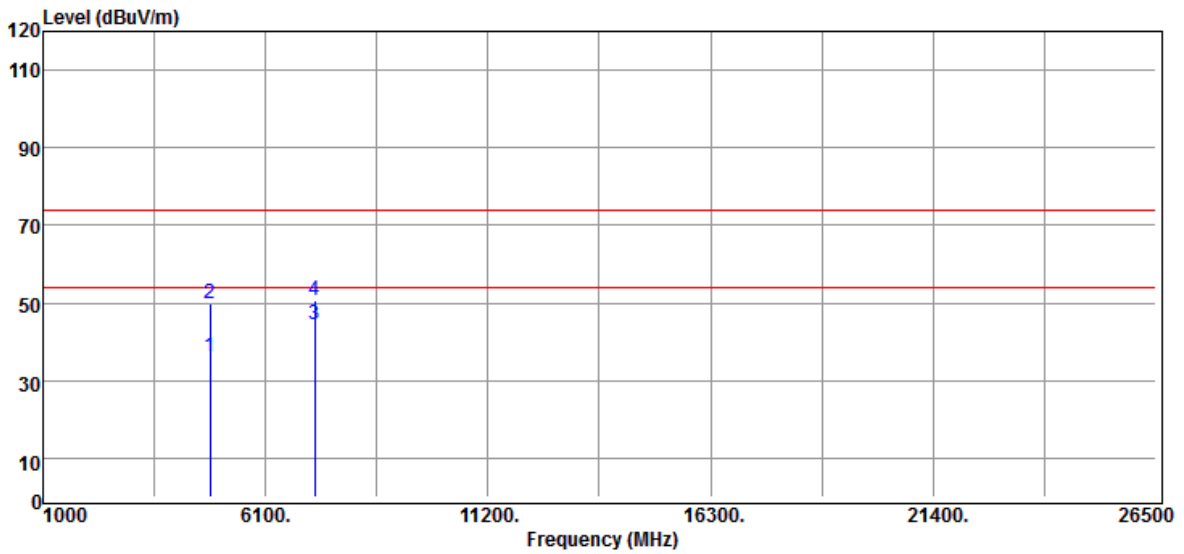

Frequency (MHz)	Reading (dBuV)	Correct Factor (dB/m)	Result (dBuV/m)	Limit (dBuV/m)	Margin (dB)	Remark
4824.00	33.52	2.75	36.27	54.00	-17.73	Average
4824.00	46.99	2.75	49.74	74.00	-24.26	Peak
7236.00	34.15	10.15	44.30	54.00	-9.70	Average
7236.00	40.46	10.15	50.61	74.00	-23.39	Peak
N/A						

**Remark:**

1. Measuring frequencies from 1 GHz to the 10th harmonic of highest fundamental frequency.

Test Mode	IEEE 802.11g Mid CH	Temp/Hum	23(°C)/ 63%RH
Test Item	Harmonic	Test Date	April 08, 2019
Polarize	Vertical	Test Engineer	Dally Hong
Detector	Peak	Test Voltage	

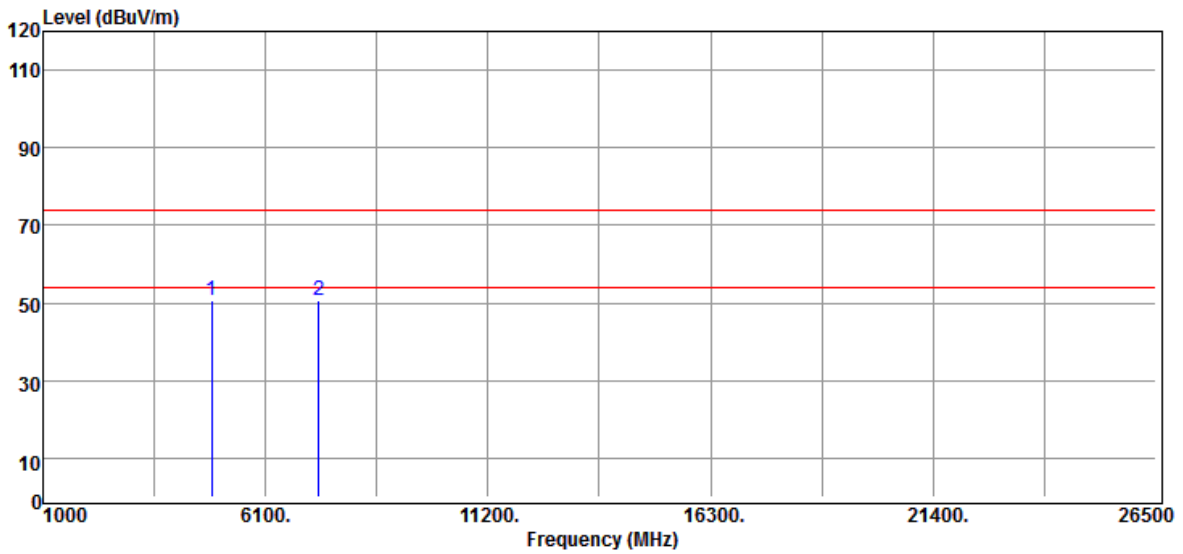

Frequency (MHz)	Reading (dBuV)	Correct Factor (dB/m)	Result (dBuV/m)	Limit (dBuV/m)	Margin (dB)	Remark
4874.00	47.53	2.95	50.48	74.00	-23.52	Peak
7311.00	40.25	10.20	50.45	74.00	-23.55	Peak
N/A						

**Remark:**

1. Measuring frequencies from 1 GHz to the 10th harmonic of highest fundamental frequency.
2. For above 1GHz, the EUT peak value was under average limit, therefore the Average value compliance with the average limit



Test Mode	IEEE 802.11g Mid CH	Temp/Hum	23(°C)/ 63%RH
Test Item	Harmonic	Test Date	April 08, 2019
Polarize	Horizontal	Test Engineer	Dally Hong
Detector	Peak and Average	Test Voltage	

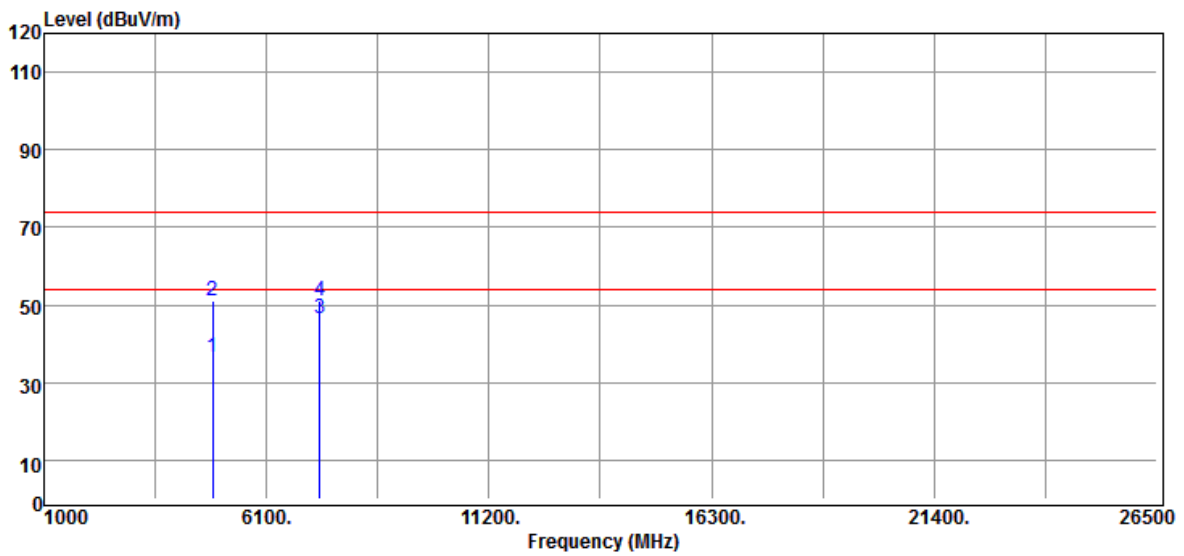

Frequency (MHz)	Reading (dBuV)	Correct Factor (dB/m)	Result (dBuV/m)	Limit (dBuV/m)	Margin (dB)	Remark
4874.00	33.53	2.95	36.48	54.00	-17.52	Average
4874.00	48.11	2.95	51.06	74.00	-22.94	Peak
7311.00	36.25	10.20	46.45	54.00	-7.55	Average
7311.00	40.97	10.20	51.17	74.00	-22.83	Peak
N/A						

**Remark:**

- Measuring frequencies from 1 GHz to the 10th harmonic of highest fundamental frequency.

Test Mode	IEEE 802.11g High CH	Temp/Hum	23(°C)/ 63%RH
Test Item	Harmonic	Test Date	April 08, 2019
Polarize	Vertical	Test Engineer	Dally Hong
Detector	Peak	Test Voltage	

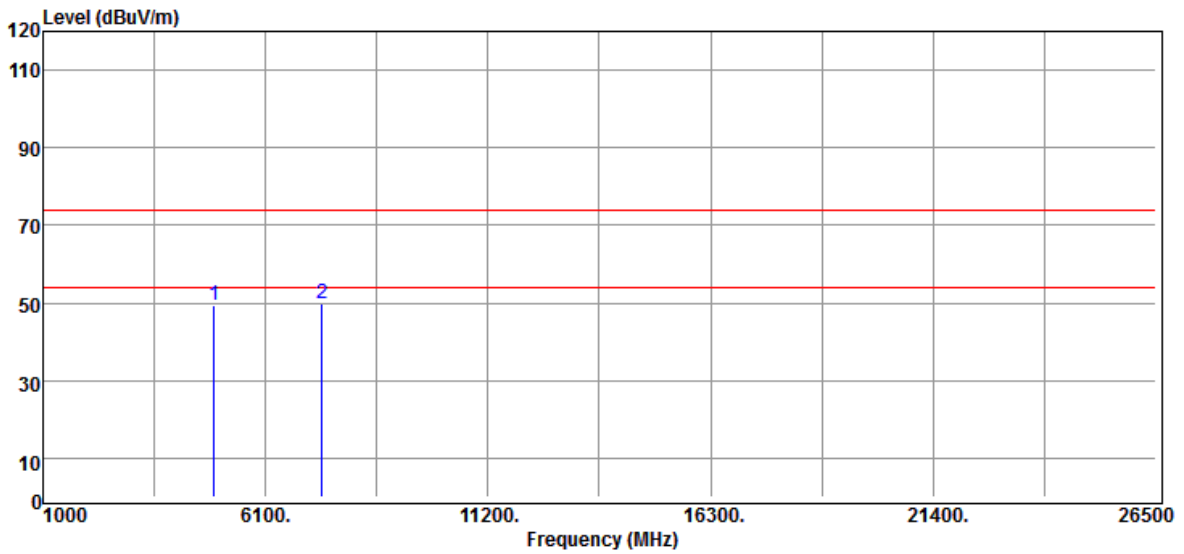

Frequency (MHz)	Reading (dBuV)	Correct Factor (dB/m)	Result (dBuV/m)	Limit (dBuV/m)	Margin (dB)	Remark
4924.00	45.96	3.34	49.30	74.00	-24.70	Peak
7386.00	39.25	10.75	50.00	74.00	-24.00	Peak
N/A						

**Remark:**

1. Measuring frequencies from 1 GHz to the 10th harmonic of highest fundamental frequency.
2. For above 1GHz, the EUT peak value was under average limit, therefore the Average value compliance with the average limit

Test Mode	IEEE 802.11g High CH	Temp/Hum	23(°C)/ 63%RH
Test Item	Harmonic	Test Date	April 08, 2019
Polarize	Horizontal	Test Engineer	Dally Hong
Detector	Peak	Test Voltage	

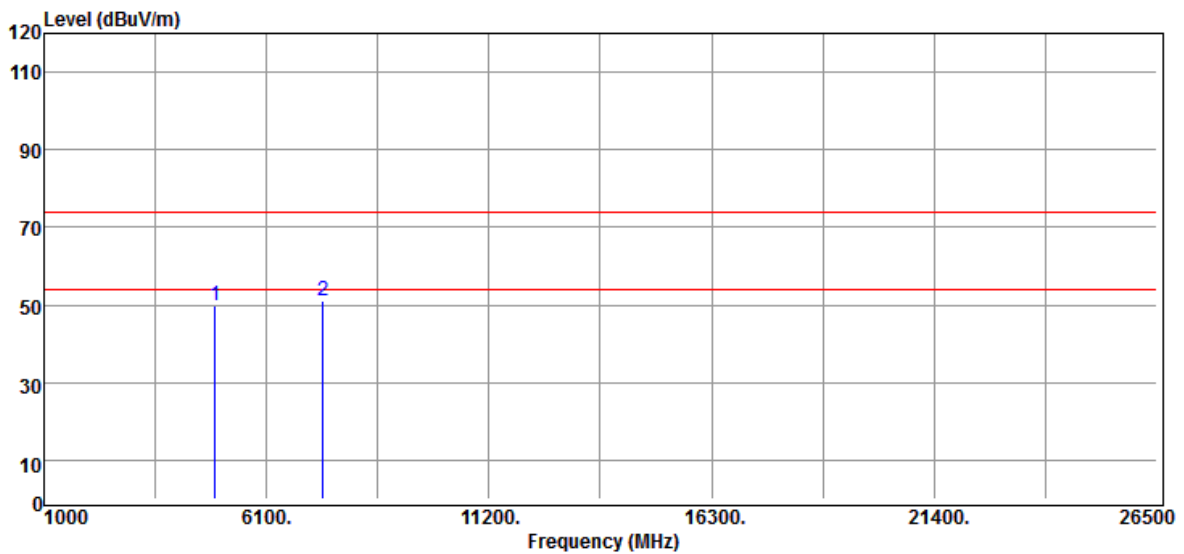

Frequency (MHz)	Reading (dBuV)	Correct Factor (dB/m)	Result (dBuV/m)	Limit (dBuV/m)	Margin (dB)	Remark
4924.00	46.54	3.34	49.88	74.00	-24.12	Peak
7386.00	40.19	10.75	50.94	74.00	-23.06	Peak
N/A						

**Remark:**

1. Measuring frequencies from 1 GHz to the 10th harmonic of highest fundamental frequency.
2. For above 1GHz, the EUT peak value was under average limit, therefore the Average value compliance with the average limit

Test Mode	IEEE 802.11n HT20 Low CH	Temp/Hum	23(°C)/ 63%RH
Test Item	Harmonic	Test Date	April 08, 2019
Polarize	Vertical	Test Engineer	Dally Hong
Detector	Peak	Test Voltage	

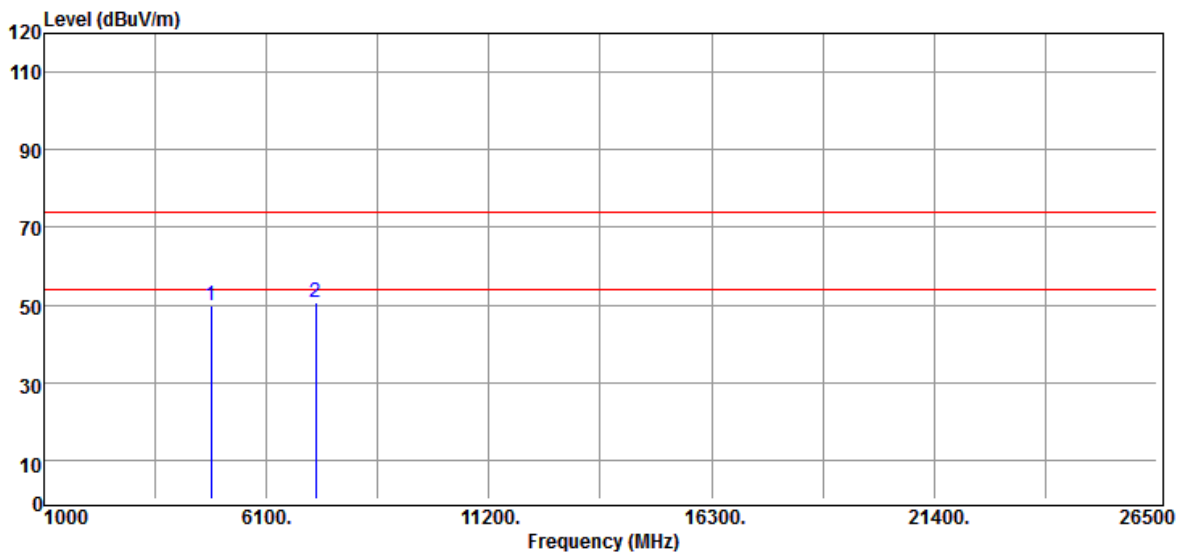

Frequency (MHz)	Reading (dBuV)	Correct Factor (dB/m)	Result (dBuV/m)	Limit (dBuV/m)	Margin (dB)	Remark
4824.00	46.97	2.75	49.72	74.00	-24.28	Peak
7236.00	40.34	10.15	50.49	74.00	-23.51	Peak
N/A						

**Remark:**

1. Measuring frequencies from 1 GHz to the 10th harmonic of highest fundamental frequency.
2. For above 1GHz, the EUT peak value was under average limit, therefore the Average value compliance with the average limit

Test Mode	IEEE 802.11n HT20 Low CH	Temp/Hum	23(°C)/ 63%RH
Test Item	Harmonic	Test Date	April 08, 2019
Polarize	Horizontal	Test Engineer	Dally Hong
Detector	Peak	Test Voltage	

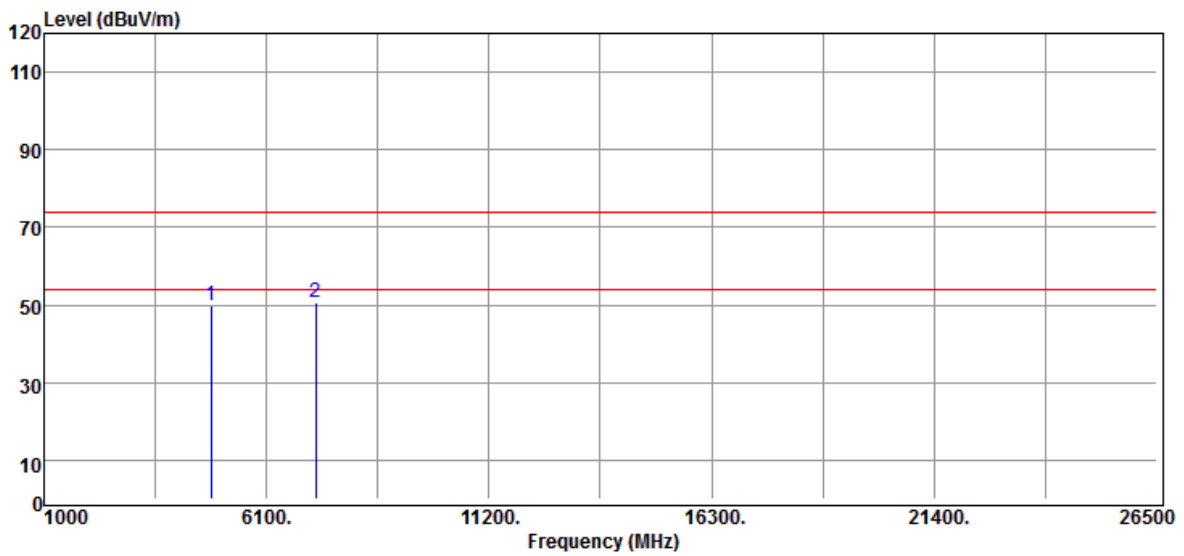

Frequency (MHz)	Reading (dBuV)	Correct Factor (dB/m)	Result (dBuV/m)	Limit (dBuV/m)	Margin (dB)	Remark
4824.00	46.90	2.75	49.65	74.00	-24.35	Peak
7236.00	40.56	10.15	50.71	74.00	-23.29	Peak
N/A						

**Remark:**

1. Measuring frequencies from 1 GHz to the 10th harmonic of highest fundamental frequency.
2. For above 1GHz, the EUT peak value was under average limit, therefore the Average value compliance with the average limit

Test Mode	IEEE 802.11n HT20 Mid CH	Temp/Hum	23(°C)/ 63%RH
Test Item	Harmonic	Test Date	April 08, 2019
Polarize	Vertical	Test Engineer	Dally Hong
Detector	Peak and Average	Test Voltage	

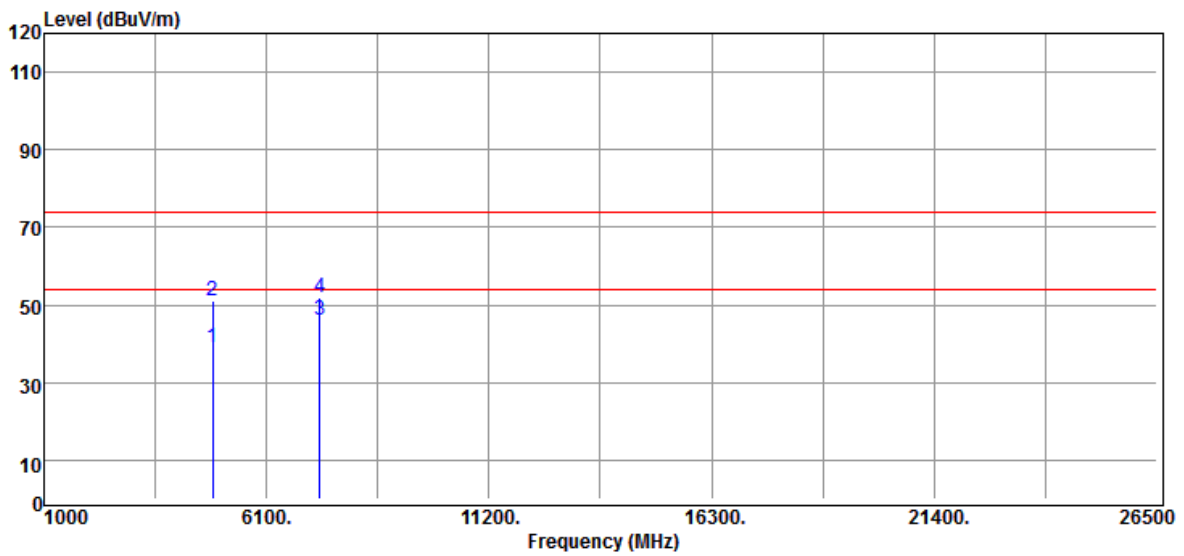

Frequency (MHz)	Reading (dBuV)	Correct Factor (dB/m)	Result (dBuV/m)	Limit (dBuV/m)	Margin (dB)	Remark
4874.00	36.26	2.95	39.21	54.00	-14.79	Average
4874.00	47.95	2.95	50.90	74.00	-23.10	Peak
7311.00	35.95	10.20	46.15	54.00	-7.85	Average
7311.00	41.72	10.20	51.92	74.00	-22.08	Peak
N/A						

**Remark:**

- Measuring frequencies from 1 GHz to the 10th harmonic of highest fundamental frequency.

Test Mode	IEEE 802.11n HT20 Mid CH	Temp/Hum	23(°C)/ 63%RH
Test Item	Harmonic	Test Date	April 08, 2019
Polarize	Horizontal	Test Engineer	Dally Hong
Detector	Peak and Average	Test Voltage	

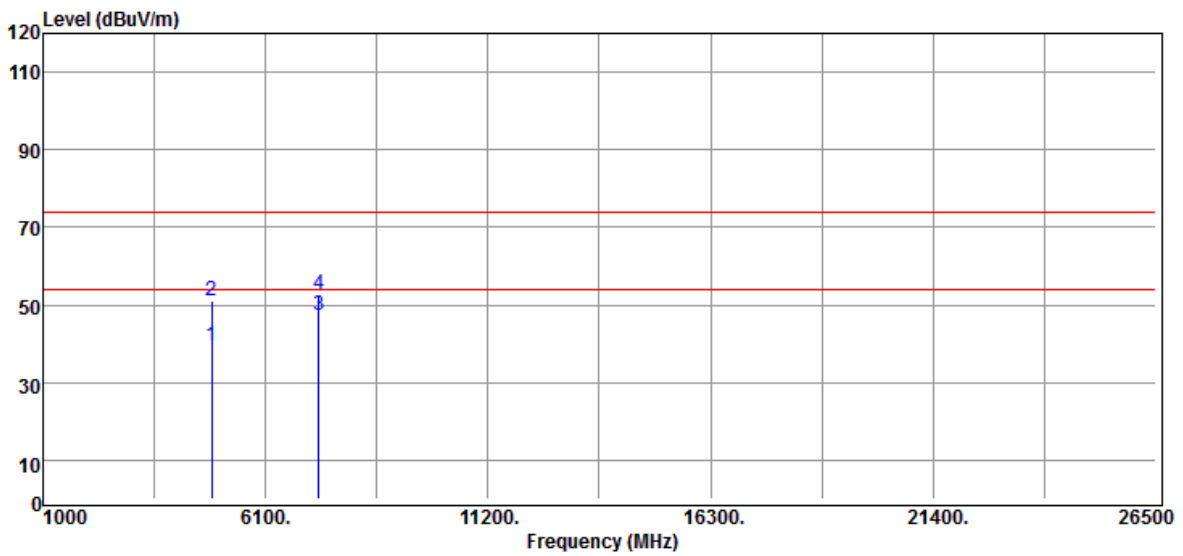

Frequency (MHz)	Reading (dBuV)	Correct Factor (dB/m)	Result (dBuV/m)	Limit (dBuV/m)	Margin (dB)	Remark
4874.00	36.53	2.95	39.48	54.00	-14.52	Average
4874.00	48.16	2.95	51.11	74.00	-22.89	Peak
7311.00	37.05	10.20	47.25	54.00	-6.75	Average
7311.00	42.43	10.20	52.63	74.00	-21.37	Peak
N/A						

**Remark:**

- Measuring frequencies from 1 GHz to the 10th harmonic of highest fundamental frequency.

Test Mode	IEEE 802.11n HT20 High CH	Temp/Hum	23(°C)/ 63%RH
Test Item	Harmonic	Test Date	April 08, 2019
Polarize	Vertical	Test Engineer	Dally Hong
Detector	Peak	Test Voltage	

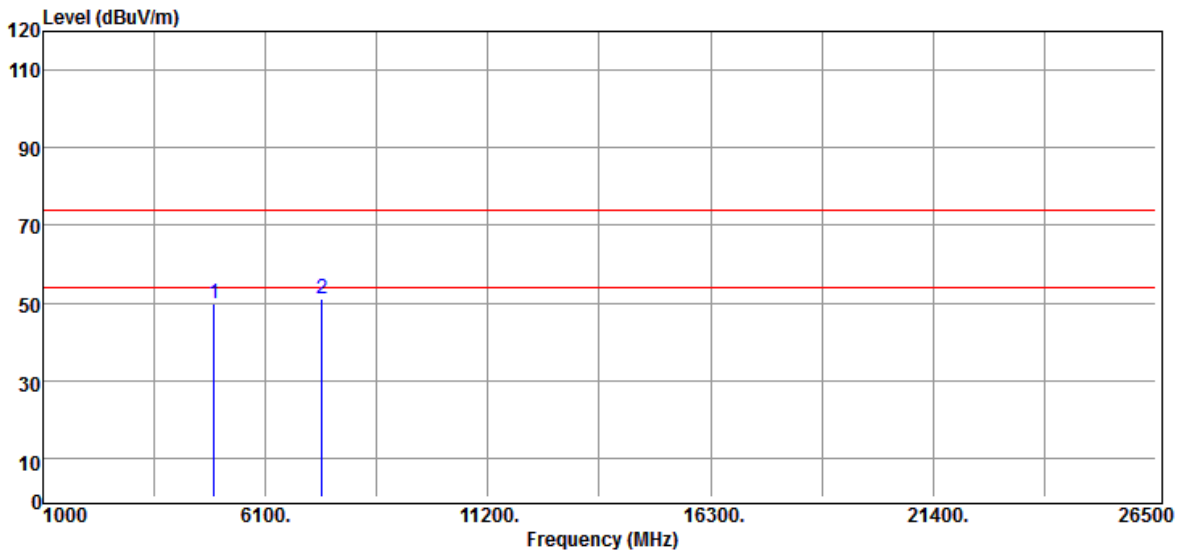

Frequency (MHz)	Reading (dBuV)	Correct Factor (dB/m)	Result (dBuV/m)	Limit (dBuV/m)	Margin (dB)	Remark
4924.00	46.38	3.34	49.72	74.00	-24.28	Peak
7386.00	40.30	10.75	51.05	74.00	-22.95	Peak
N/A						

**Remark:**

1. Measuring frequencies from 1 GHz to the 10th harmonic of highest fundamental frequency.
2. For above 1GHz, the EUT peak value was under average limit, therefore the Average value compliance with the average limit



Test Mode	IEEE 802.11n HT20 High CH	Temp/Hum	23(°C)/ 63%RH
Test Item	Harmonic	Test Date	April 08, 2019
Polarize	Horizontal	Test Engineer	Dally Hong
Detector	Peak	Test Voltage	

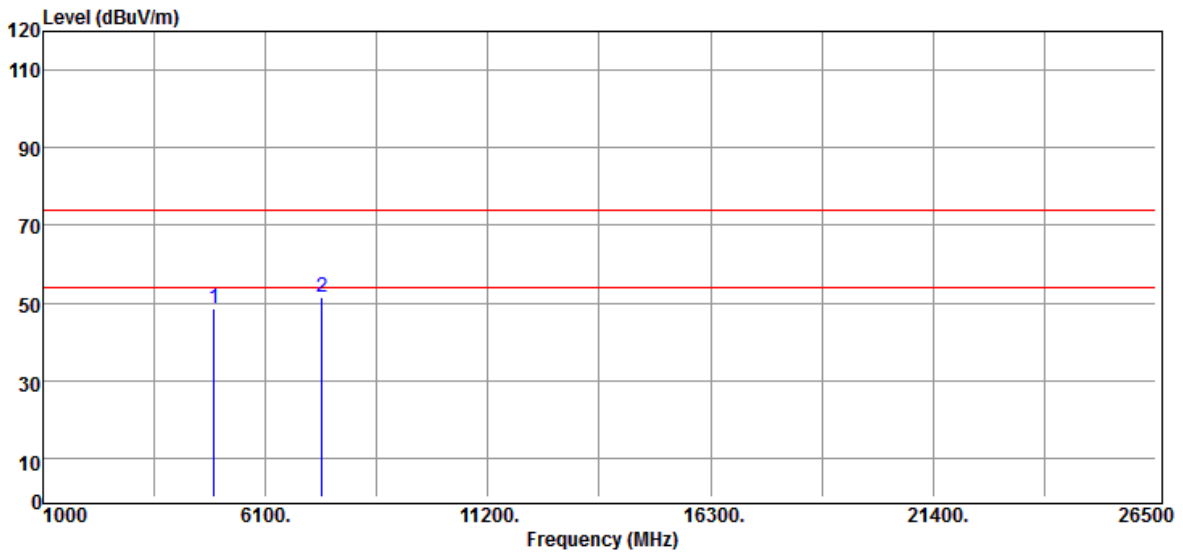

Frequency (MHz)	Reading (dBuV)	Correct Factor (dB/m)	Result (dBuV/m)	Limit (dBuV/m)	Margin (dB)	Remark
4924.00	45.33	3.34	48.67	74.00	-25.33	Peak
7386.00	40.93	10.75	51.68	74.00	-22.32	Peak
N/A						

**Remark:**

1. Measuring frequencies from 1 GHz to the 10th harmonic of highest fundamental frequency.
2. For above 1GHz, the EUT peak value was under average limit, therefore the Average value compliance with the average limit

Test Mode	IEEE 802.11n HT40 Low CH	Temp/Hum	24(°C)/ 63%RH
Test Item	Harmonic	Test Date	April 09, 2019
Polarize	Vertical	Test Engineer	Dally Hong
Detector	Peak and Average	Test Voltage	

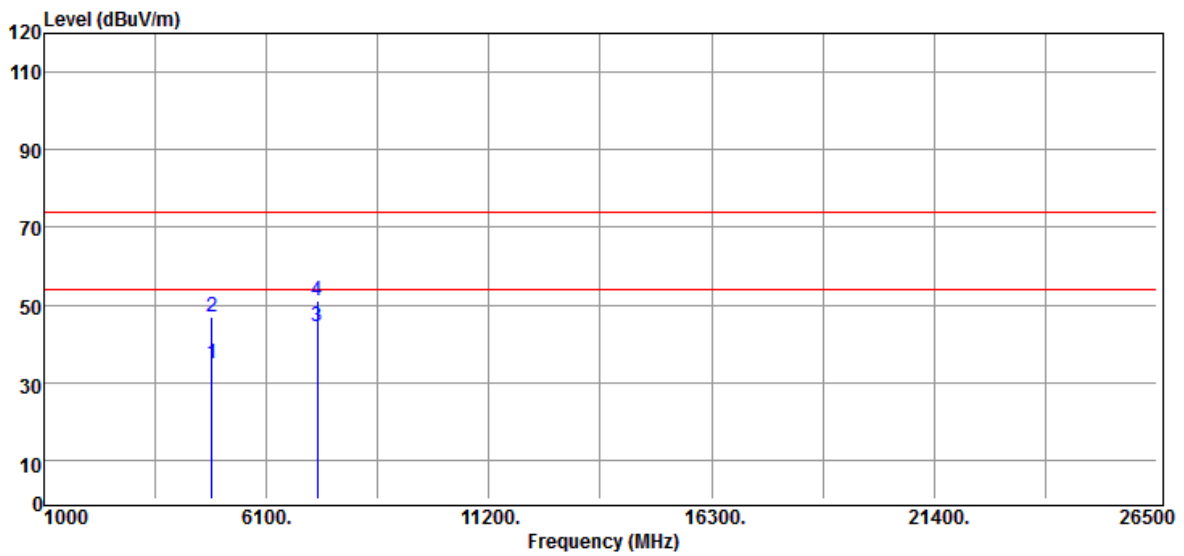

Frequency (MHz)	Reading (dBuV)	Correct Factor (dB/m)	Result (dBuV/m)	Limit (dBuV/m)	Margin (dB)	Remark
4844.00	32.15	2.73	34.88	54.00	-19.12	Average
4844.00	44.32	2.73	47.05	74.00	-26.95	Peak
7266.00	34.57	10.02	44.59	54.00	-9.41	Average
7266.00	41.26	10.02	51.28	74.00	-22.72	Peak
N/A						

**Remark:**

- Measuring frequencies from 1 GHz to the 10th harmonic of highest fundamental frequency.

Test Mode	IEEE 802.11n HT40 Low CH	Temp/Hum	24(°C)/ 63%RH
Test Item	Harmonic	Test Date	April 09, 2019
Polarize	Horizontal	Test Engineer	Dally Hong
Detector	Peak and Average	Test Voltage	

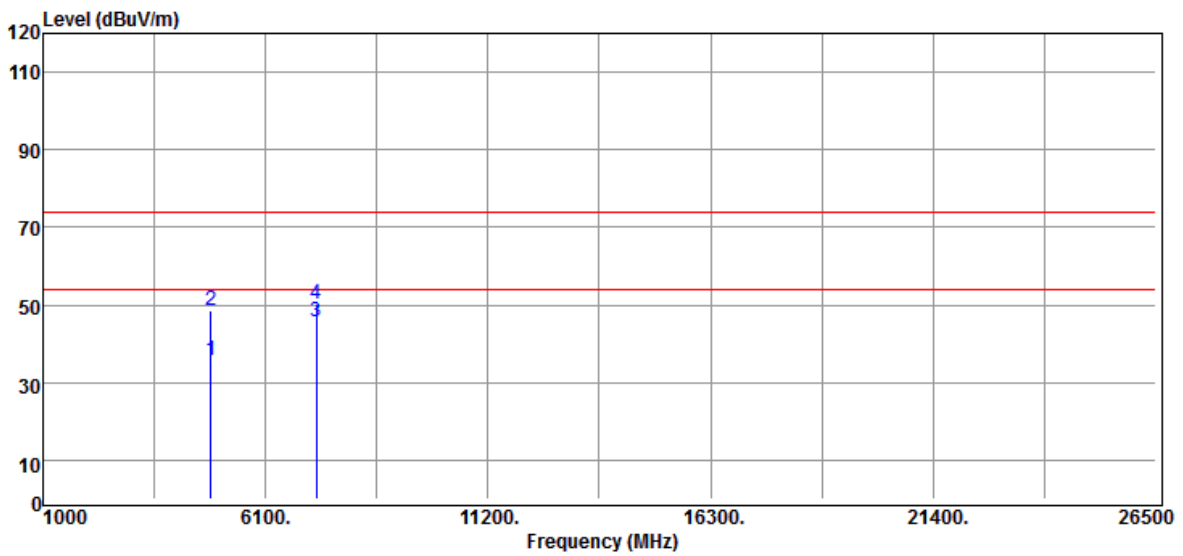

Frequency (MHz)	Reading (dBuV)	Correct Factor (dB/m)	Result (dBuV/m)	Limit (dBuV/m)	Margin (dB)	Remark
4844.00	32.95	2.73	35.68	54.00	-18.32	Average
4844.00	45.84	2.73	48.57	74.00	-25.43	Peak
7266.00	35.48	10.02	45.50	54.00	-8.50	Average
7266.00	40.14	10.02	50.16	74.00	-23.84	Peak
N/A						

**Remark:**

- Measuring frequencies from 1 GHz to the 10th harmonic of highest fundamental frequency.

Test Mode	IEEE 802.11n HT40 Mid CH	Temp/Hum	24(°C)/ 63%RH
Test Item	Harmonic	Test Date	April 09, 2019
Polarize	Vertical	Test Engineer	Dally Hong
Detector	Peak and Average	Test Voltage	

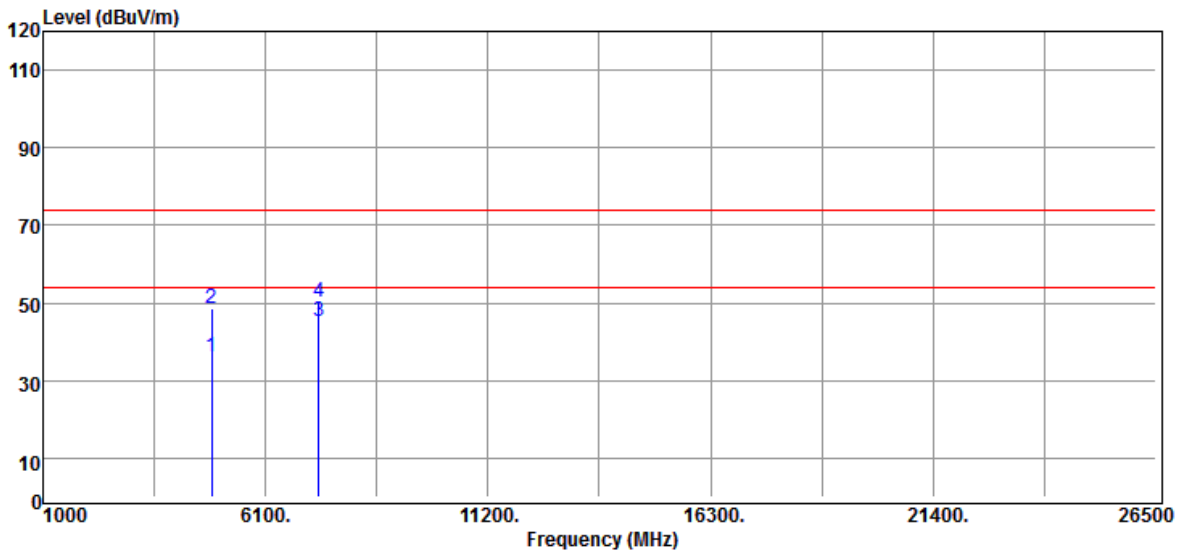

Frequency (MHz)	Reading (dBuV)	Correct Factor (dB/m)	Result (dBuV/m)	Limit (dBuV/m)	Margin (dB)	Remark
4874.00	33.20	2.95	36.15	54.00	-17.85	Average
4874.00	45.54	2.95	48.49	74.00	-25.51	Peak
7311.00	35.25	10.20	45.45	54.00	-8.55	Average
7311.00	40.11	10.20	50.31	74.00	-23.69	Peak
N/A						

**Remark:**

- Measuring frequencies from 1 GHz to the 10th harmonic of highest fundamental frequency.

Test Mode	IEEE 802.11n HT40 Mid CH	Temp/Hum	24(°C)/ 63%RH
Test Item	Harmonic	Test Date	April 09, 2019
Polarize	Horizontal	Test Engineer	Dally Hong
Detector	Peak and Average	Test Voltage	

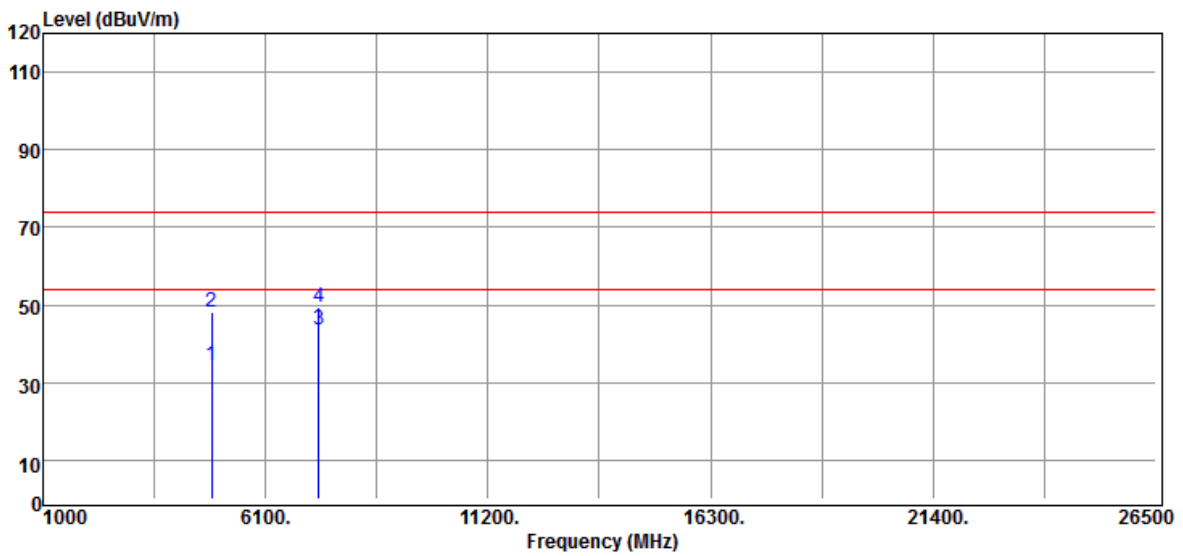

Frequency (MHz)	Reading (dBuV)	Correct Factor (dB/m)	Result (dBuV/m)	Limit (dBuV/m)	Margin (dB)	Remark
4874.00	31.60	2.95	34.55	54.00	-19.45	Average
4874.00	45.11	2.95	48.06	74.00	-25.94	Peak
7311.00	33.25	10.20	43.45	54.00	-10.55	Average
7311.00	39.23	10.20	49.43	74.00	-24.57	Peak
N/A						

**Remark:**

1. Measuring frequencies from 1 GHz to the 10th harmonic of highest fundamental frequency.

Test Mode	IEEE 802.11n HT40 High CH	Temp/Hum	24(°C)/ 63%RH
Test Item	Harmonic	Test Date	April 09, 2019
Polarize	Vertical	Test Engineer	Dally Hong
Detector	Peak and Average	Test Voltage	

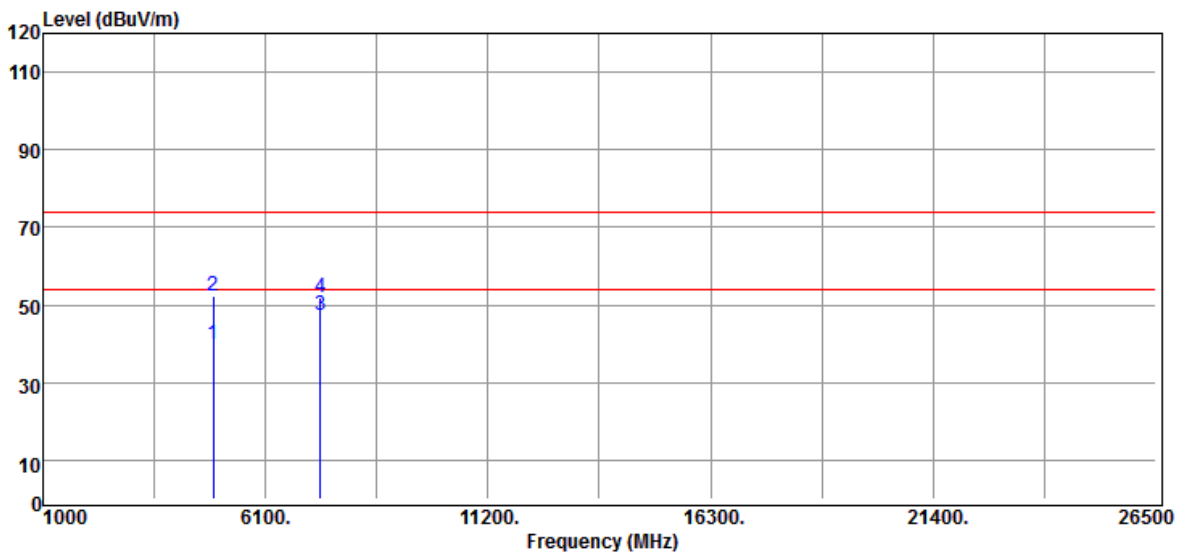

Frequency (MHz)	Reading (dBuV)	Correct Factor (dB/m)	Result (dBuV/m)	Limit (dBuV/m)	Margin (dB)	Remark
4904.00	36.57	3.13	39.70	54.00	-14.30	Average
4904.00	49.12	3.13	52.25	74.00	-21.75	Peak
7356.00	36.24	10.98	47.22	54.00	-6.78	Average
7356.00	40.92	10.98	51.90	74.00	-22.10	Peak
N/A						

**Remark:**

- Measuring frequencies from 1 GHz to the 10th harmonic of highest fundamental frequency.

Test Mode	IEEE 802.11n HT40 High CH	Temp/Hum	24(°C)/ 63%RH
Test Item	Harmonic	Test Date	April 09, 2019
Polarize	Horizontal	Test Engineer	Dally Hong
Detector	Peak and Average	Test Voltage	

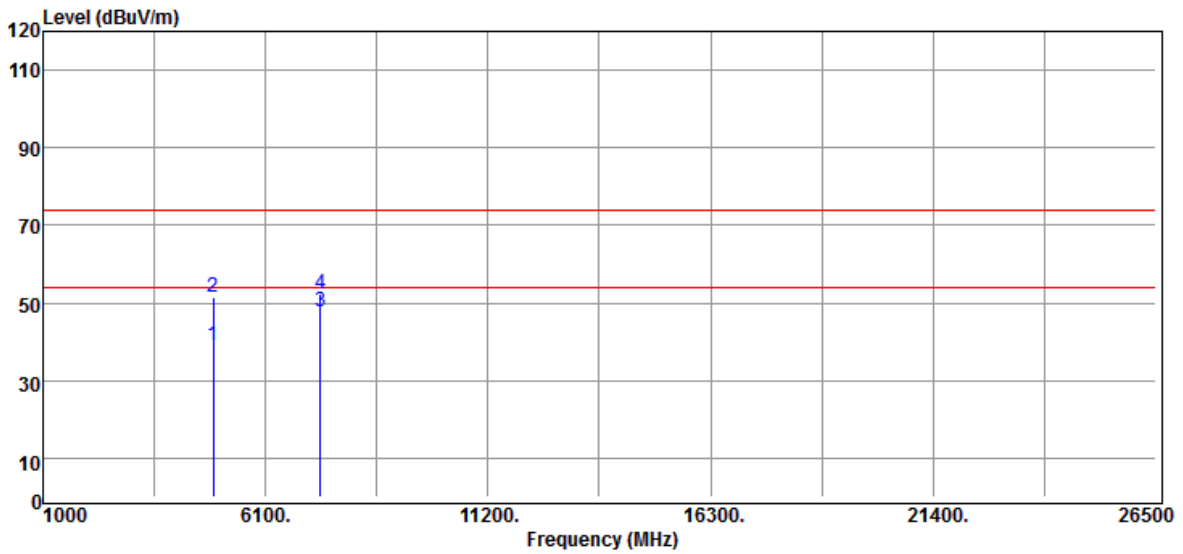

Frequency (MHz)	Reading (dBuV)	Correct Factor (dB/m)	Result (dBuV/m)	Limit (dBuV/m)	Margin (dB)	Remark
4904.00	35.97	3.13	39.10	54.00	-14.90	Average
4904.00	48.16	3.13	51.29	74.00	-22.71	Peak
7356.00	36.84	10.98	47.82	54.00	-6.18	Average
7356.00	41.25	10.98	52.23	74.00	-21.77	Peak
N/A						

**Remark:**

- Measuring frequencies from 1 GHz to the 10th harmonic of highest fundamental frequency.

- End of Test Report -