



Test report No. : 4789349230-US-R0-V0
Page : 1 of 56
Issued date : Mar. 26, 2020
FCC ID : 2AHDGFONE540

RADIO TEST REPORT

Product : FONE540 Conference Speakerphone
Model Name : FONE540 BT
FCC ID : 2AHDGFONE540
Test Regulation : FCC 47 CFR Part 15 Subpart C (Section 15.247)
Received Date : Jan. 15, 2020
Test Date : Jan. 31, 2020 ~ Mar 26, 2020
Issued Date : Mar. 26, 2020

Applicant : AVer Information Inc.
8F, No.157, Da-An Rd., Tucheng Dist., New Taipei City
23673, Taiwan

Issued By : Underwriters Laboratories Taiwan Co., Ltd.
Building B and Building E, No. 372-7, Sec. 4, Zhongxing Rd.,
Zhudong Township, Hsinchu County, Taiwan



The results reported herein have been performed in accordance with the laboratory's terms of accreditation. This report shall not be reproduced except in full without the written approval of the Laboratory. The results in this report are responsible of the test sample(s) provided by the client only and are not to be used to indicate applicability to other similar products.

Underwriters Laboratories Taiwan Co., Ltd.

Building B and Building E, No. 372-7, Sec. 4, Zhongxing Rd., Zhudong Township, Hsinchu County, Taiwan
Telephone :+886-2-7737-3000
Facsimile (FAX) :+886-3-583-7948

Doc No: 17-EM-F0876 / 5.0



Table Of Contents

1. Attestation of Test Results	4
2. Summary of Test Results	5
3. Test Methodology and Reference Procedures.....	6
4. Facilities and Accreditation.....	6
5. Measurement Uncertainty	7
6. Equipment under Test	8
6.1. Description of EUT.....	8
6.2. Channel List.....	9
6.3. Test Condition.....	9
6.4. Description Of Available Antennas	10
6.5. Test Mode Applicability and Tested Channel Detail.....	10
7. Test Equipment.....	11
8. Description of Test Setup.....	13
9. Test Results.....	14
9.1. Channel Bandwidth.....	14
9.2. Conducted output power	16
9.3. Hopping Channel Separation	18
9.4. Number of Hopping Frequency Used	20
9.5. Dwell Time on Each Channel	22
9.6. Conducted Out of Band Emission.....	27
9.7. Radiated Spurious Emission	32
9.8. AC Power Line Conducted Emission	45
Appendix I Radiated Band Edge Measurement	51
Appendix II Radiated Spurious Emission Measurement	55

Underwriters Laboratories Taiwan Co., Ltd.

Building B and Building E, No. 372-7, Sec. 4, Zhongxing Rd., Zhudong Township, Hsinchu County, Taiwan

Telephone :+886-2-7737-3000

Facsimile (FAX) :+886-3-583-7948

Doc No: 17-EM-F0876 / 5.0



1. Attestation of Test Results

APPLICANT: AVer Information Inc.
 8F, No.157, Da-An Rd., Tucheng Dist., New Taipei City 23673,
 Taiwan

MANUFACTURER AVer Information Inc.
 8F, No.157, Da-An Rd., Tucheng Dist., New Taipei City 23673,
 Taiwan

EUT DESCRIPTION: FONE540 Conference Speakerphone

BRAND: 

MODEL: FONE540 BT

SAMPLE STAGE: Engineering sample

DATE of TESTED: Jan. 31, 2020 ~ Mar 26, 2020

APPLICABLE STANDARDS	
STANDARD	Test Results
FCC 47 CFR PART 15 Subpart C (Section 15.247)	PASS

Underwriters Laboratories Taiwan Co., Ltd. tested the above equipment in accordance with the requirements set forth in the above standards. All indications of Pass/Fail in this report are opinions expressed by Underwriters Laboratories Taiwan Co., Ltd. based on interpretations and/or observations of test results. The test results show that the equipment tested is capable of demonstrating compliance with the requirements as documented in this report.

Note: The results documented in this report apply only to the tested sample, under the conditions and modes of operation as described herein. This document may not be altered or revised in any way unless done so by Underwriters Laboratories Taiwan Co., Ltd. and all revisions are duly noted in the revisions section. Any alteration of this document not carried out by Underwriters Laboratories Taiwan Co., Ltd. will constitute fraud and shall nullify the document. This report must not be used by the client to claim product certification, approval, or endorsement by NVLAP, NIST, any agency of the Federal Government, or any agency of any government.

Prepared By:

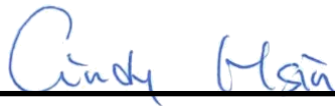

Cindy Hsin
 Project Handler

Date : Mar. 26, 2020

Approved and Authorized By:

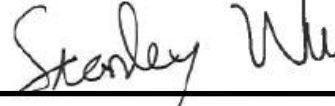

Stanley Wu
 Senior Project Engineer

Date : Mar. 26, 2020

Underwriters Laboratories Taiwan Co., Ltd.

Building B and Building E, No. 372-7, Sec. 4, Zhongxing Rd., Zhudong Township, Hsinchu County, Taiwan
 Telephone :+886-2-7737-3000
 Facsimile (FAX) :+886-3-583-7948



2. Summary of Test Results

Summary of Test Results		
FCC Clause	Test Items	Result
15.247(a)(1) (iii)	Number of Hopping Frequency Used	PASS
15.247(a)(1) (iii)	Dwell Time on Each Channel	PASS
15.247(a)(1)	1. Hopping Channel Separation 2. Spectrum Bandwidth of a Frequency Hopping Sequence Spread Spectrum System	PASS
15.247(b)	Conducted Output Power	PASS
15.247(d)	Antenna Port Emission	PASS
15.205 / 15.209 / 15.247(d)	Radiated Emissions and Band Edge Measurement	PASS
15.207	AC Power Conducted Emission	PASS
15.203	Antenna Requirement	PASS

Note:

1. For the Radiated Band Edge test plots were recorded in Appendix I, the Radiated Emissions test plots were recorded in Appendix II.

Underwriters Laboratories Taiwan Co., Ltd.

Building B and Building E, No. 372-7, Sec. 4, Zhongxing Rd., Zhudong Township, Hsinchu County, Taiwan

Telephone :+886-2-7737-3000

Facsimile (FAX) :+886-3-583-7948

Doc No: 17-EM-F0876 / 5.0



3. Test Methodology and Reference Procedures

The tests documented in this report were performed in accordance with 47 CFR FCC Part 2, KDB558074 D01 Meas Guidance v05r02, KDB414788 D01 Radiated Test Site v01r01, ANSI C63.10-2013.

4. Facilities and Accreditation

Test Location	Underwriters Laboratories Taiwan Co., Ltd.
Address	Building B and Building E, No. 372-7, Sec. 4, Zhongxing Rd., Zhudong Township, Hsinchu County, Taiwan
Accreditation Certificate	Underwriters Laboratories Taiwan Co., Ltd. is accredited by TAF, Laboratory Code 3398. The full scope of accreditation can be viewed at http://accreditation.taftw.org.tw/taf/public/basic/viewApplyItems.action?unitNo=3398

Underwriters Laboratories Taiwan Co., Ltd.

Building B and Building E, No. 372-7, Sec. 4, Zhongxing Rd., Zhudong Township, Hsinchu County, Taiwan

Telephone :+886-2-7737-3000

Facsimile (FAX) :+886-3-583-7948



5. Measurement Uncertainty

For statement of conformity, accuracy method (Section 8.2.4 and 8.2.5 of ISO Guide 98-4) was applied as decision rule for measurement in this test report.

The following uncertainties have been calculated to provide a confidence level of 95 % using a coverage factor $k=2$.

Test Item	Measurement Frequency Range	K	U(dB)
Conducted disturbance at mains terminals ports	0.15MHz ~ 30MHz	2	1.7
RF Conducted	9 kHz - 40GHz	2	1.0
Radiated disturbance below 30MHz	9 kHz - 30MHz	2	2.2
Radiated disturbance below 1 GHz	30MHz ~ 1GHz	2	5.3
Radiated disturbance above 1GHz	1GHz ~ 40GHz	2	4.8

Underwriters Laboratories Taiwan Co., Ltd.

Building B and Building E, No. 372-7, Sec. 4, Zhongxing Rd., Zhudong Township, Hsinchu County, Taiwan

Telephone :+886-2-7737-3000

Facsimile (FAX) :+886-3-583-7948

Doc No: 17-EM-F0876 / 5.0



6. Equipment under Test

6.1. Description of EUT

Product	FONE540 Conference Speakerphone
Brand Name	
Model Name	FONE540 BT
Operating Frequency	2402MHz ~ 2480MHz
Modulation	GFSK, $\pi/4$ -DQPSK and 8DPSK
Transfer Rate	Up to 3 Mbps
Number of Channel	79
Maximum Output Power	6.77 dBm
Normal Voltage	12Vdc for adapter
Hardware Version	B
Software Version	0.0.7000.14

Note:

1. The EUT contains following accessory devices

Product	Brand	Model	Description
Power adapter	APD	DA-60N12	I/P:100-240Vac,50/60Hz O/P: 12Vdc, 5A
Power cord	PHINO	PHS-301	Length:1.8m, w/o ferrite core
USB 2.0 cable	N/A	FAAF-A342T	Length:4.9m
3.5 mm Audio Cable	N/A	M-3522	Length:1m
AVerlink Wireless Dongle	Aver	U020-W	N/A

2. The above EUT information is declared by manufacturer and for more detailed features description, please refer the manufacturer's or user's manual.

Underwriters Laboratories Taiwan Co., Ltd.

Building B and Building E, No. 372-7, Sec. 4, Zhongxing Rd., Zhudong Township, Hsinchu County, Taiwan
Telephone :+886-2-7737-3000
Facsimile (FAX) :+886-3-583-7948



6.2. Channel List

79 channels are provided for BT-EDR mode:

Channel	Freq. (MHz)	Channel	Freq. (MHz)	Channel	Freq. (MHz)	Channel	Freq. (MHz)
0	2402	20	2422	40	2442	60	2462
1	2403	21	2423	41	2443	61	2463
2	2404	22	2424	42	2444	62	2464
3	2405	23	2425	43	2445	63	2465
4	2406	24	2426	44	2446	64	2466
5	2407	25	2427	45	2447	65	2467
6	2408	26	2428	46	2448	66	2468
7	2409	27	2429	47	2449	67	2469
8	2410	28	2430	48	2450	68	2470
9	2411	29	2431	49	2451	69	2471
10	2412	30	2432	50	2452	70	2472
11	2413	31	2433	51	2453	71	2473
12	2414	32	2434	52	2454	72	2474
13	2415	33	2435	53	2455	73	2475
14	2416	34	2436	54	2456	74	2476
15	2417	35	2437	55	2457	75	2477
16	2418	36	2438	56	2458	76	2478
17	2419	37	2439	57	2459	77	2479
18	2420	38	2440	58	2460	78	2480
19	2421	39	2441	59	2461	-	-

6.3. Test Condition

Test Item	Test Site No.	Environmental Condition	Input Power	Test Date	Tested by
Antenna Port Conducted Measurement	SR4	21 ~ 24°C / 60 ~ 64%RH	120Vac / 60 Hz	Jan. 31, 2020 ~ Mar. 26, 2020	Howard Kao
Radiated Spurious Emission	966-2	23 ~ 25°C / 67 ~ 69%RH	120Vac / 60 Hz	Feb. 11, 2020 ~ Feb. 17, 2020	Will Chen
AC power Line Conducted Emission	SR1	24°C / 64%RH	120Vac / 60 Hz	Feb. 17, 2020	Will Chen

FCC Test Firm Registration Number: 498077

Underwriters Laboratories Taiwan Co., Ltd.

Building B and Building E, No. 372-7, Sec. 4, Zhongxing Rd., Zhudong Township, Hsinchu County, Taiwan

Telephone :+886-2-7737-3000

Facsimile (FAX) :+886-3-583-7948

Doc No: 17-EM-F0876 / 5.0



6.4. Description Of Available Antennas

Antenna	Brand Name	Model Name	Antenna Type	Antenna Gain(dBi)
Chain(0)	Joymax	TBF-A030MPAX-174H015	PCB	3.51

Note: The above antenna information was provided from customer and for more detailed features description, please refer the manufacturer's specification or user's manual.

6.5. Test Mode Applicability and Tested Channel Detail

Test item	Modulation Type	Available Channel	Test Channel	Packet Type
Radiated Emissions (Above 1GHz)	GFSK	0 to 78	0,39,78	DH5
	8DPSK	0 to 78	0,39,78	3DH5
Radiated Emissions (Below 1GHz)	GFSK	0 to 78	39	DH5
AC Power Line Conducted Emission	GFSK	0 to 78	39	DH5
Antenna Port Conducted Measurement	GFSK	0 to 78	0,39,78	DH5
	8DPSK	0 to 78	0,39,78	3DH5

Note:

1. Pre-Scan has been conducted to determine the worst-case mode from all possible combinations between available modulations, data rates and antenna ports (if EUT with antenna diversity architecture).
2. For below 1 GHz radiated emission and AC power line conducted emission have performed all modes of operation were investigated and the worst-case emissions are reported.
3. For Antenna Port Conducted Measurement, this item includes all test value of each mode, but only includes spectrum plot of worst value of each mode.
4. The fundamental of the EUT was investigated in three orthogonal axes X/Y/Z, it was determined that X axis was worst-case. Therefore, all final radiated testing was performed with the EUT in X axis.
5. For below 30MHz testing, investigation was done on three antenna orientations (parallel, perpendicular, and ground-parallel), parallel and perpendicular are the worst orientations, therefore testing was performed on these two orientations only.
6. For AC power line conducted emissions, the pre-scan has been determined by AC power 120Vac/60Hz (worst case)

Underwriters Laboratories Taiwan Co., Ltd.

Building B and Building E, No. 372-7, Sec. 4, Zhongxing Rd., Zhudong Township, Hsinchu County, Taiwan
Telephone :+886-2-7737-3000
Facsimile (FAX) :+886-3-583-7948



7. Test Equipment

Test Equipment List					
Equipment	Manufacturer	Model No.	Serial No.	Cal. Date	Cal. Interval
Radiated Spurious Emission					
Spectrum Analyzer	Keysight	N9010A	MY56070827	Nov. 13, 2019	1 year
EMI Test Receiver	Rohde & Schwarz	ESR7	101754	Dec. 17, 2019	1 year
Loop Antenna	ETS lindgren	6502	00213440	Dec. 19, 2019	1 year
Trilog-Broadband Antenna with 5dB Attenuator	Schwarzbeck & EMCI	VULB 9168 & N-6-05	774 & AT-N0538	Jan. 3, 2020	1 year
Horn Antenna (1-18 GHz)	Schwarzbeck	BBHA 9120 D	01690	Jan. 3, 2020	1 year
Horn Antenna(18-40 GHz)	Schwarzbeck	BBHA 9170	781	Dec. 27, 2019	1 year
Preamplifier (30-1000 MHz)	EMCI	EMC330E	980405	Feb. 4, 2020	1 year
Preamplifier (1-18 GHz)	EMCI	EMC051835BE	980406	Feb. 4, 2020	1 year
Preamplifier (18-40GHz)	EMCI	EMC184040SEE	980426	May. 8, 2019	1 year
Cables	Hanyitek	K1K50-UP0264-K1K50-2500	170214-4 & 170425-2	Jan. 8, 2020	1 year
Cables	Hanyitek	K1K50-UP0264-K1K50-2500	170214-1 & 170214-2	Jan. 8, 2020	1 year

Underwriters Laboratories Taiwan Co., Ltd.

Building B and Building E, No. 372-7, Sec. 4, Zhongxing Rd., Zhudong Township, Hsinchu County, Taiwan

Telephone :+886-2-7737-3000

Facsimile (FAX) :+886-3-583-7948

Doc No: 17-EM-F0876 / 5.0



Test report No. : 4789349230-US-R0-V0
Page : 12 of 56
Issued date : Mar. 26, 2020
FCC ID : 2AHDGFONE540

Test Equipment List					
Equipment	Manufacturer	Model No.	Serial No.	Cal. Date	Cal. Interval
Antenna Port Conducted Measurement					
Spectrum Analyzer	Keysight	N9010A	MY56070834	Nov. 6, 2019	1 year
Spectrum Analyzer	Rohde & Schwarz	FSV40	101490	Sep. 24, 2019	1 year
Pulse Power Sensor	Anrisu	MA2411B	1531202	Dec. 23, 2019	1 year
Power Meter	Anrisu	ML2495A	1645002	Dec. 23, 2019	1 year
AC power Line Conducted Emission					
EMI Test Receiver	Rohde & Schwarz	ESR7	101753	Nov. 19, 2019	1 year
Two-Line V-Network	Rohde & Schwarz	ENV216	102136	Aug. 8, 2019	1 year
Impuls-Begrenzer Pulse Limiter	Rohde & Schwarz	ESH3-Z2	102219-Qt	Aug. 6, 2019	1 year
Cables	HARBOUR INDUSTRIES	LL142	170205-5000-1	Jan. 15, 2020	1 year

UL Software		
Description	Name	Version
Radiated measurement	EZ_EMCC	1.1.4.2
AC power Line Conducted Emission	EZ_EMCC	1.1.4.2

Underwriters Laboratories Taiwan Co., Ltd.

Building B and Building E, No. 372-7, Sec. 4, Zhongxing Rd., Zhudong Township, Hsinchu County, Taiwan

Telephone :+886-2-7737-3000

Facsimile (FAX) :+886-3-583-7948

Doc No: 17-EM-F0876 / 5.0



8. Description of Test Setup

Support Equipment

Equipment	Mfr/Brand	Model/Type No.	Series No.	Note
Notebook	DELL	Latitude E5470	3JFKWF2	N/A
Speaker	SONY	SRS-XB10	6007730	N/A
FONE540 Conference Speakerphone	AVer	FONE540 BT	N/A	N/A
AUX Audio Cable	SONY	N/A	N/A	1.5m length with ferrite core
RJ45 Cable	N/A	N/A	N/A	1m length, non-shielded
RJ45 Cable	N/A	N/A	N/A	10m length, non-shielded

Test Setup

Controlled using a bespoke application (CSR BlueSuite v2.6.6) on a test Notebook. The application was used to enable a continuous transmission mode and to select the test channels, data rates, modulation schemes and power setting as required.

Setup Diagram for Test

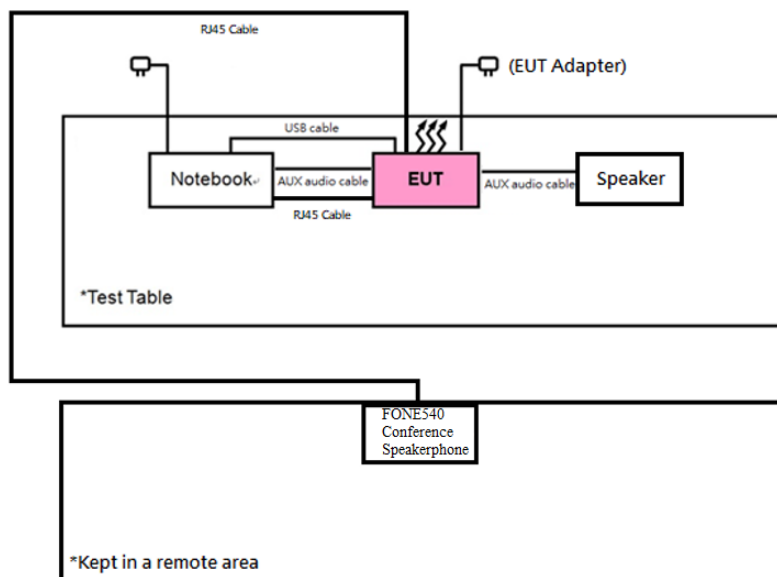

Underwriters Laboratories Taiwan Co., Ltd.

Building B and Building E, No. 372-7, Sec. 4, Zhongxing Rd., Zhudong Township, Hsinchu County, Taiwan

Telephone :+886-2-7737-3000

Facsimile (FAX) :+886-3-583-7948

Doc No: 17-EM-F0876 / 5.0



9. Test Results

9.1. Channel Bandwidth

Requirements

For frequency hopping system operating in the 2400-2483.5MHz, If the 20dB bandwidth of hopping channel is greater than 25kHz, two-thirds 20dB bandwidth of hopping channel shall be a minimum limit for the hopping channel separation.

Test procedure

- Check the calibration of the measuring instrument using either an internal calibrator or a known signal from an external generator.
- Turn on the EUT and connect it to measurement instrument. Then set it to any one convenient frequency within its operating range. Set a reference level on the measuring instrument equal to the highest peak value.
- Measure the frequency difference of two frequencies that were attenuated 20dB from the reference level. Record the frequency difference as the emission bandwidth.
- Repeat above procedures until all frequencies measured were complete.

Test Setup

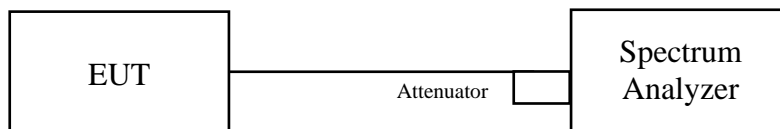

The loss between RF output port of the EUT and the input port of the Spectrum Analyzer has been taken into consideration.

Underwriters Laboratories Taiwan Co., Ltd.

Building B and Building E, No. 372-7, Sec. 4, Zhongxing Rd., Zhudong Township, Hsinchu County, Taiwan

Telephone :+886-2-7737-3000

Facsimile (FAX) :+886-3-583-7948

Doc No: 17-EM-F0876 / 5.0



Test Data

Channel	Frequency (MHz)	20dB Bandwidth (MHz)	
		GFSK	8DPSK
0	2402	0.8987	1.2634
39	2441	0.8987	1.2634
78	2480	0.8987	1.2634

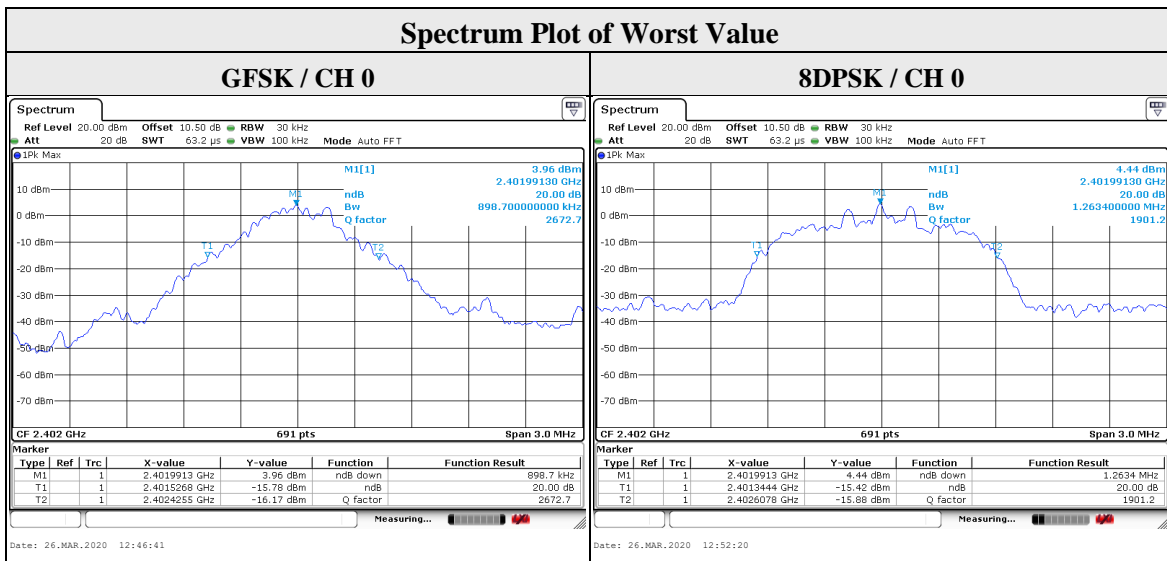

Underwriters Laboratories Taiwan Co., Ltd.

Building B and Building E, No. 372-7, Sec. 4, Zhongxing Rd., Zhudong Township, Hsinchu County, Taiwan

Telephone : +886-2-7737-3000

Facsimile (FAX) : +886-3-583-7948



9.2. Conducted output power

Requirements

The Maximum Output Power Measurement is 125mW.

Test Procedure

A peak power sensor was used on the output port of the EUT. A power meter was used to read the response of the peak power sensor. Record the power level.

Test Setup

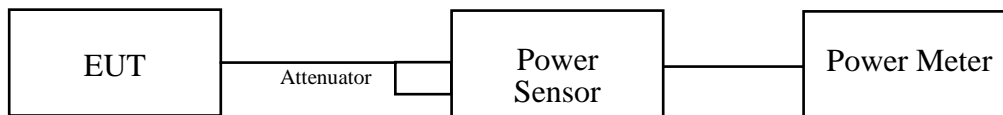

The loss between RF output port of the EUT and the input port of the Power Meter has been taken into consideration.



Test Data

Peak Power

Channel	Frequency (MHz)	Output Power (mW)		Output Power (dBm)		Power Limit (mW)	Pass / Fail
		GFSK	8DPSK	GFSK	8DPSK		
0	2402	3.81	4.68	5.81	6.7	125	Pass
39	2441	4.06	4.75	6.08	6.77	125	Pass
78	2480	3.42	4.20	5.34	6.23	125	Pass

Average Power (Reference Only)

Channel	Frequency (MHz)	Output Power (mW)		Output Power (dBm)	
		GFSK	8DPSK	GFSK	8DPSK
0	2402	3.49	2.65	5.43	4.23
39	2441	3.75	2.80	5.74	4.47
78	2480	3.14	2.37	4.97	3.74

Underwriters Laboratories Taiwan Co., Ltd.

Building B and Building E, No. 372-7, Sec. 4, Zhongxing Rd., Zhudong Township, Hsinchu County, Taiwan

Telephone :+886-2-7737-3000

Facsimile (FAX) :+886-3-583-7948

Doc No: 17-EM-F0876 / 5.0



9.3. Hopping Channel Separation

Requirements

At least 25kHz or two-third of 20dB hopping channel bandwidth (whichever is greater).

Test procedure

- a. Check the calibration of the measuring instrument using either an internal calibrator or a known signal from an external generator.
- b. Turn on the EUT and connect it to measurement instrument. Then set it to any one convenient frequency within its operating range.
- c. By using the MaxHold function record the separation of two adjacent channels.
- d. Measure the frequency difference of these two adjacent channels by SA MARK function. And then plot the result on SA screen.

Test Setup

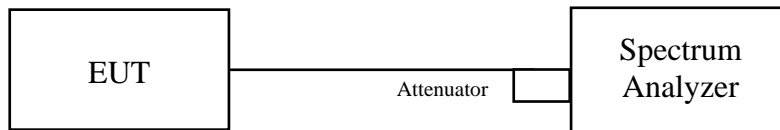

The loss between RF output port of the EUT and the input port of the Spectrum Analyzer has been taken into consideration.



Test Data

Mode	Channel	Frequency (MHz)	Adjacent Hopping Channel Separation (MHz)	Limit (MHz)	Result
GFSK	0	2402	1.00	0.599	PASS
	39	2441	1.00	0.599	PASS
	78	2480	1.00	0.599	PASS
8DPSK	0	2402	1.00	0.842	PASS
	39	2441	1.00	0.842	PASS
	78	2480	1.00	0.842	PASS

Note: Limit (MHz) = two/three of 20dB Bandwidth

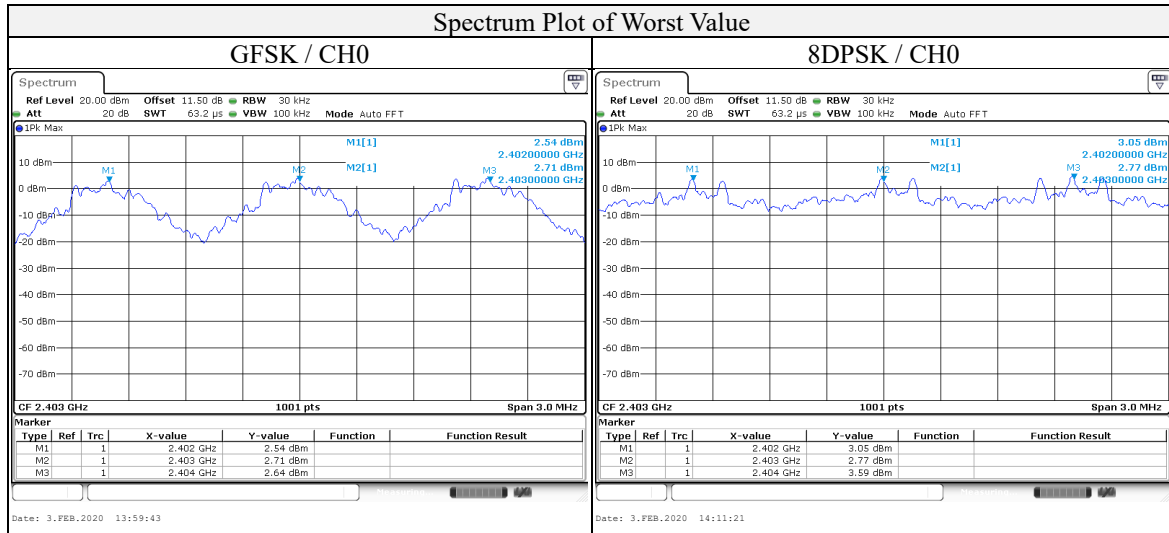

Underwriters Laboratories Taiwan Co., Ltd.

Building B and Building E, No. 372-7, Sec. 4, Zhongxing Rd., Zhudong Township, Hsinchu County, Taiwan

Telephone :+886-2-7737-3000

Facsimile (FAX) :+886-3-583-7948

Doc No: 17-EM-F0876 / 5.0



9.4. Number of Hopping Frequency Used

Requirements

At least 15 channels frequencies, and should be equally spaced.

Test procedure

- Check the calibration of the measuring instrument (SA) using either an internal calibrator or a known signal from an external generator.
- Turn on the EUT and connect its antenna terminal to measurement via a low loss cable. Then set it to any one measured frequency within its operating range and make sure the instrument is operated in its linear range.
- Set the SA on MaxHold Mode, and then keep the EUT in hopping mode. Record all the signals from each channel until each one has been recorded.
- Set the SA on View mode and then plot the result on SA screen.
- Repeat above procedures until all frequencies measured were complete.

Test Setup

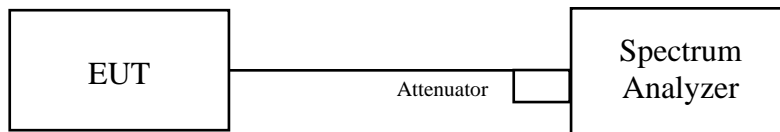

The loss between RF output port of the EUT and the input port of the Spectrum Analyzer has been taken into consideration.

Underwriters Laboratories Taiwan Co., Ltd.

Building B and Building E, No. 372-7, Sec. 4, Zhongxing Rd., Zhudong Township, Hsinchu County, Taiwan

Telephone :+886-2-7737-3000

Facsimile (FAX) :+886-3-583-7948

Doc No: 17-EM-F0876 / 5.0



Test Data

There are 79 hopping frequencies in the hopping mode. On the plots, it shows that the hopping frequencies are equally spaced.

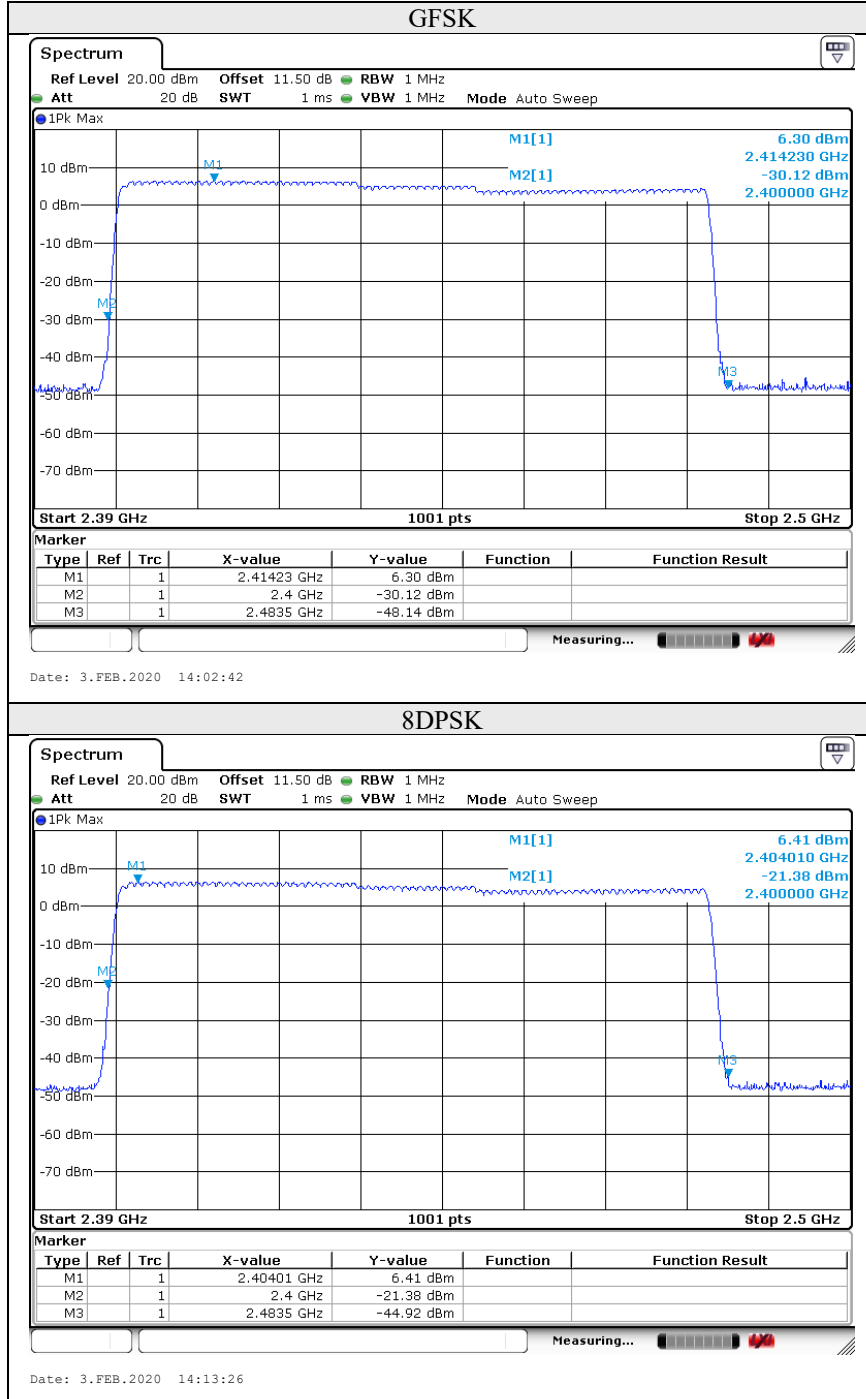

Underwriters Laboratories Taiwan Co., Ltd.

Building B and Building E, No. 372-7, Sec. 4, Zhongxing Rd., Zhudong Township, Hsinchu County, Taiwan

Telephone :+886-2-7737-3000

Facsimile (FAX) :+886-3-583-7948



9.5. Dwell Time on Each Channel

Requirements

The average time of occupancy on any channel shall not be greater than 0.4 seconds within a period of 0.4 seconds multiplied by the number of hopping channels employed.

Test procedure

- Check the calibration of the measuring instrument (SA) using either an internal calibrator or a known signal from an external generator.
- Turn on the EUT and connect its antenna terminal to measurement via a low loss cable. Then set it to any one measured frequency within its operating range and make sure the instrument is operated in its linear range.
- Adjust the center frequency of SA on any frequency be measured and set SA to zero span mode. And then, set RBW and VBW of spectrum analyzer to proper value.
- Measure the time duration of one transmission on the measured frequency. And then plot the result with time difference of this time duration.
- Repeat above procedures until all different time-slot modes have been completed.
- Measure the maximum time duration of one single pulse.

A Period Time = (channel number)*0.4

For normal mode:

DH1 Time Slot: Reading * (1600/2)*31.6/(channel number)

DH3 Time Slot: Reading * (1600/4)*31.6/(channel number)

DH5 Time Slot: Reading * (1600/6)*31.6/(channel number)

For AFH mode:

DH1 Time Slot: Reading * (800/2)*31.6/(channel number)

DH3 Time Slot: Reading * (800/4)*31.6/(channel number)

DH5 Time Slot: Reading * (800/6)*31.6/(channel number)

Test Setup

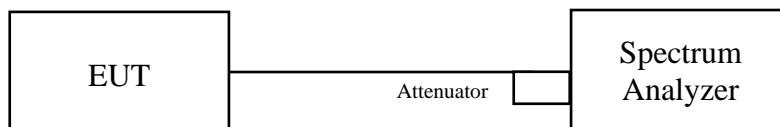

The loss between RF output port of the EUT and the input port of the Spectrum Analyzer has been taken into consideration.

Underwriters Laboratories Taiwan Co., Ltd.

Building B and Building E, No. 372-7, Sec. 4, Zhongxing Rd., Zhudong Township, Hsinchu County, Taiwan

Telephone :+886-2-7737-3000

Facsimile (FAX) :+886-3-583-7948



Test Data

Normal Mode

GFSK

Modulation	Channel	Frequency (MHz)	Length of transmission time (msec)	Result (msec)	Limit (msec)	Result
DH1	39	2441	0.440	140.800	400	PASS
DH3	39	2441	1.700	272.000	400	PASS
DH5	39	2441	2.950	314.667	400	PASS

8DPSK

Modulation	Channel	Frequency (MHz)	Length of transmission time (msec)	Result (msec)	Limit (msec)	Result
3DH1	39	2441	0.460	147.200	400	PASS
3DH3	39	2441	1.720	275.200	400	PASS
3DH5	39	2441	2.960	315.733	400	PASS

Note :

1. In normal mode:

DH1 hopping rate is 1600 hops/s with 2 slots in 79 hopping channels. With channel hopping rate $(1600 / 2 / 79)$ in Occupancy Time Limit (0.4×79) (s), Hops Over Occupancy Time comes to $(1600 / 2 / 79) \times (0.4 \times 79) = 320.08$ hops.

DH3 hopping rate is 1600 hops/s with 4 slots in 79 hopping channels. With channel hopping rate $(1600 / 4 / 79)$ in Occupancy Time Limit (0.4×79) (s), Hops Over Occupancy Time comes to $(1600 / 4 / 79) \times (0.4 \times 79) = 160$ hops.

DH5 hopping rate is 1600 hops/s with 6 slots in 79 hopping channels. With channel hopping rate $(1600 / 6 / 79)$ in Occupancy Time Limit (0.4×79) (s), Hops Over Occupancy Time comes to $(1600 / 6 / 79) \times (0.4 \times 79) = 106.67$ hops.

2. Dwell time (ms) = Hops Over Occupancy Time (hops) x Length of transmission time (ms).

Underwriters Laboratories Taiwan Co., Ltd.

Building B and Building E, No. 372-7, Sec. 4, Zhongxing Rd., Zhudong Township, Hsinchu County, Taiwan

Telephone :+886-2-7737-3000

Facsimile (FAX) :+886-3-583-7948

Doc No: 17-EM-F0876 / 5.0



AFH Mode

GFSK

Modulation	Channel	Frequency (MHz)	Length of transmission time (msec)	Result (msec)	Limit (msec)	Result
DH1	39	2441	0.440	70.400	400	PASS
DH3	39	2441	1.700	136.000	400	PASS
DH5	39	2441	2.950	157.333	400	PASS

8DPSK

Modulation	Channel	Frequency (MHz)	Length of transmission time (msec)	Result (msec)	Limit (msec)	Result
3DH1	39	2441	0.460	73.600	400	PASS
3DH3	39	2441	1.720	137.600	400	PASS
3DH5	39	2441	2.960	157.867	400	PASS

Note :

1. In AFH (adaptive frequency hopping) mode:

DH1 hopping rate is 800 hops/s with 2 slots in 20 hopping channels. With channel hopping rate $(800 / 2 / 20)$ in Occupancy Time Limit (0.4×20) (s), Hops Over Occupancy Time comes to $(800 / 2 / 20) \times (0.4 \times 20) = 160$ hops.

DH3 hopping rate is 800 hops/s with 4 slots in 20 hopping channels. With channel hopping rate $(800 / 4 / 20)$ in Occupancy Time Limit (0.4×20) (s), Hops Over Occupancy Time comes to $(800 / 4 / 20) \times (0.4 \times 20) = 80$ hops.

DH5 hopping rate is 800 hops/s with 6 slots in 20 hopping channels. With channel hopping rate $(800 / 6 / 20)$ in Occupancy Time Limit (0.4×20) (s), Hops Over Occupancy Time comes to $(800 / 6 / 20) \times (0.4 \times 20) = 53.33$ hops.

2. Dwell time (ms) = Hops Over Occupancy Time (hops) x Length of transmission time (ms).

Underwriters Laboratories Taiwan Co., Ltd.

Building B and Building E, No. 372-7, Sec. 4, Zhongxing Rd., Zhudong Township, Hsinchu County, Taiwan

Telephone :+886-2-7737-3000

Facsimile (FAX) :+886-3-583-7948

Doc No: 17-EM-F0876 / 5.0



GFSK

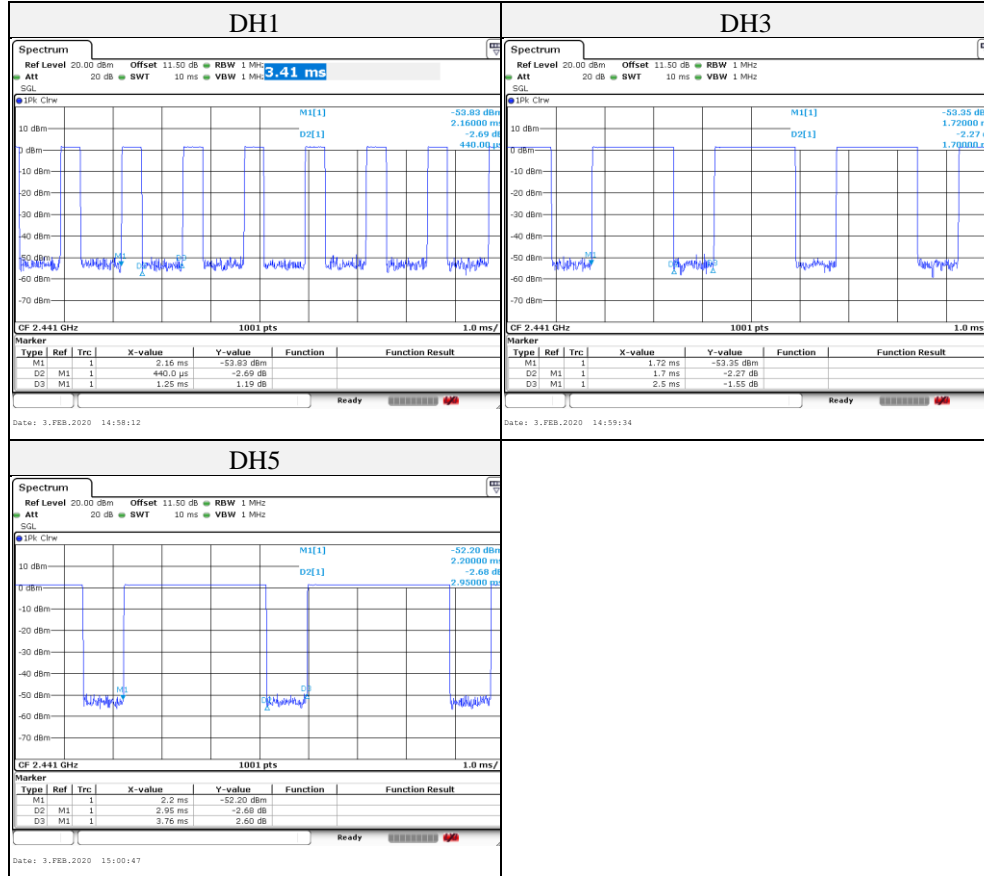

Underwriters Laboratories Taiwan Co., Ltd.

Building B and Building E, No. 372-7, Sec. 4, Zhongxing Rd., Zhudong Township, Hsinchu County, Taiwan

Telephone : +886-2-7737-3000

Facsimile (FAX) : +886-3-583-7948

Doc No: 17-EM-F0876 / 5.0



8DPSK

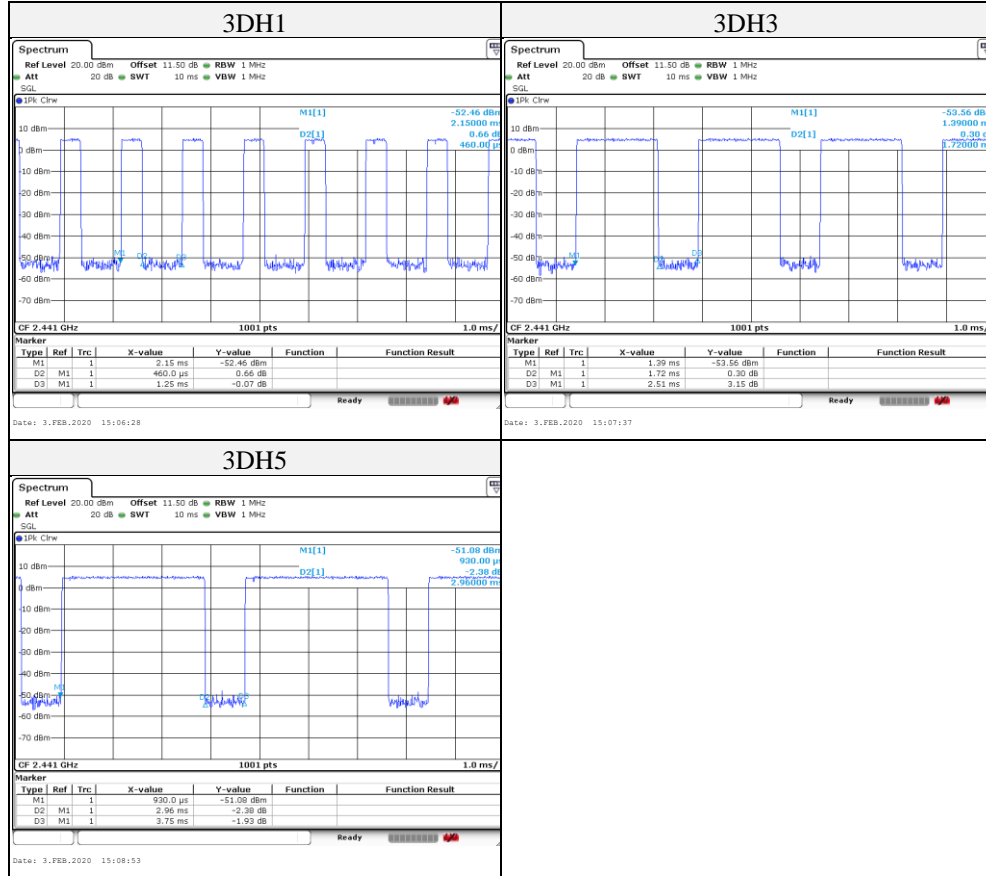

Underwriters Laboratories Taiwan Co., Ltd.

Building B and Building E, No. 372-7, Sec. 4, Zhongxing Rd., Zhudong Township, Hsinchu County, Taiwan

Telephone : +886-2-7737-3000

Facsimile (FAX) : +886-3-583-7948

Doc No: 17-EM-F0876 / 5.0



9.6. Conducted Out of Band Emission

Requirements

In any 100 kHz bandwidth outside the frequency band in which the spread spectrum or digitally modulated intentional radiator is operating, the radio frequency power that is produced by the intentional radiator shall be at least 20 dB below that in the 100 kHz bandwidth within the band that contains the highest level of the desired power, based on either an RF conducted or a radiated measurement, provided the transmitter demonstrates compliance with the peak conducted power limits. If the transmitter complies with the conducted power limits based on the use of RMS averaging over a time interval, as permitted under paragraph (b) (3) of this section, the attenuation required under this paragraph shall be 30 dB instead of 20 dB. Attenuation below the general limits specified in §15.209 (a) is not required.

Test procedure

The transmitter output was connected to the spectrum analyzer via a low loss cable. Set both RBW and VBW of spectrum analyzer to 100 kHz and 300 kHz with suitable frequency span including 100 MHz bandwidth from band edge. The band edges was measured and recorded.

Test Setup

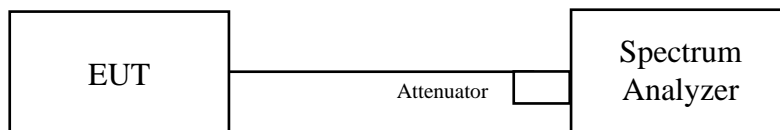

The loss between RF output port of the EUT and the input port of the Spectrum Analyzer has been taken into consideration.

Underwriters Laboratories Taiwan Co., Ltd.

Building B and Building E, No. 372-7, Sec. 4, Zhongxing Rd., Zhudong Township, Hsinchu County, Taiwan
Telephone :+886-2-7737-3000
Facsimile (FAX) :+886-3-583-7948



Test Data

GFSK

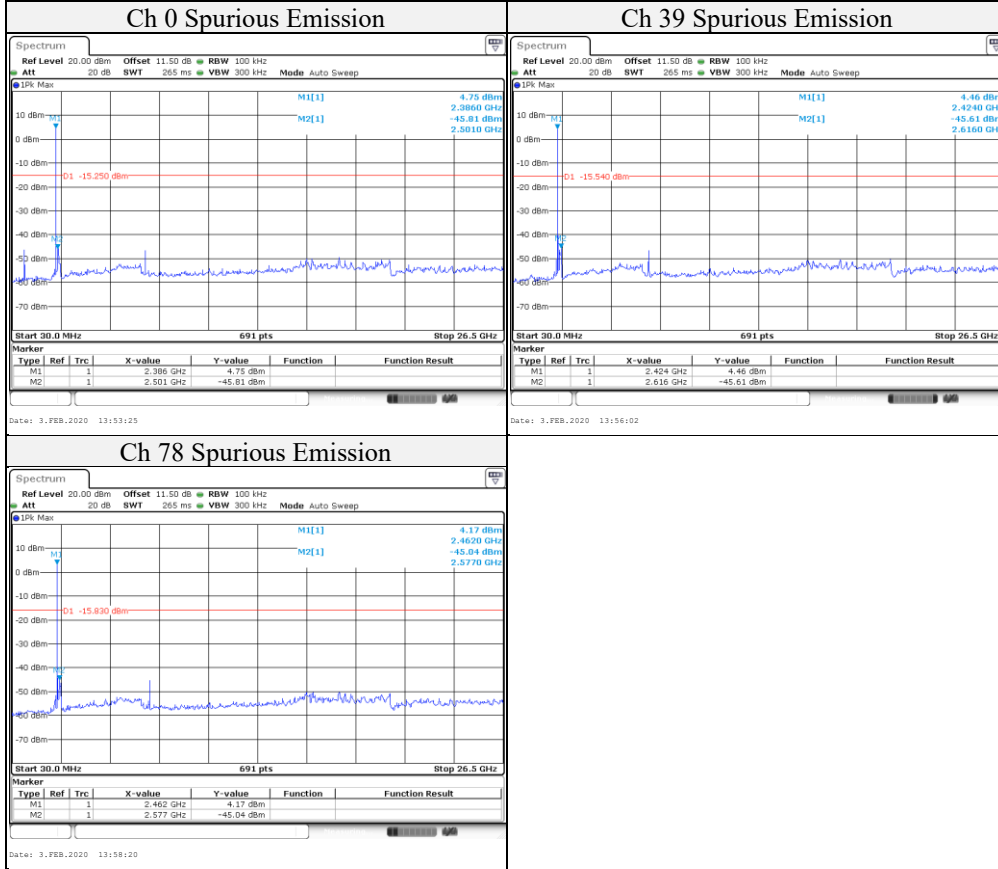

Underwriters Laboratories Taiwan Co., Ltd.

Building B and Building E, No. 372-7, Sec. 4, Zhongxing Rd., Zhudong Township, Hsinchu County, Taiwan

Telephone :+886-2-7737-3000

Facsimile (FAX) :+886-3-583-7948

Doc No: 17-EM-F0876 / 5.0

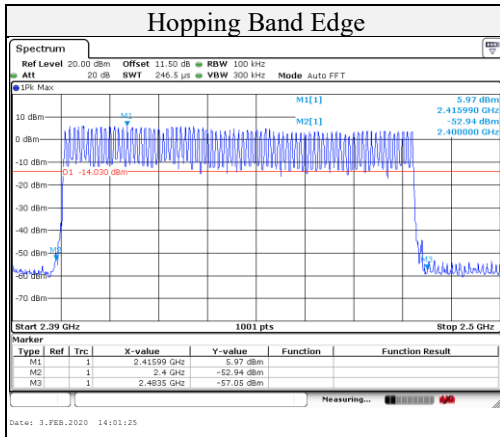
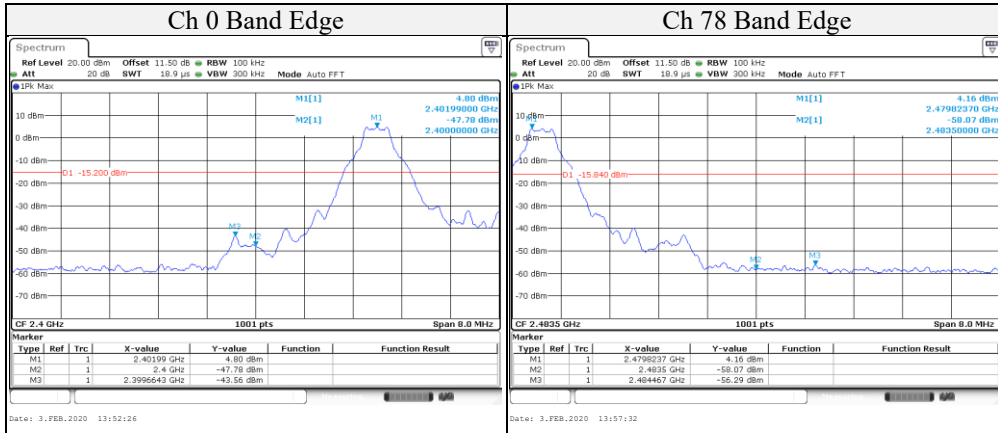

Underwriters Laboratories Taiwan Co., Ltd.

Building B and Building E, No. 372-7, Sec. 4, Zhongxing Rd., Zhudong Township, Hsinchu County, Taiwan

Telephone : +886-2-7737-3000

Facsimile (FAX) : +886-3-583-7948



8DPSK

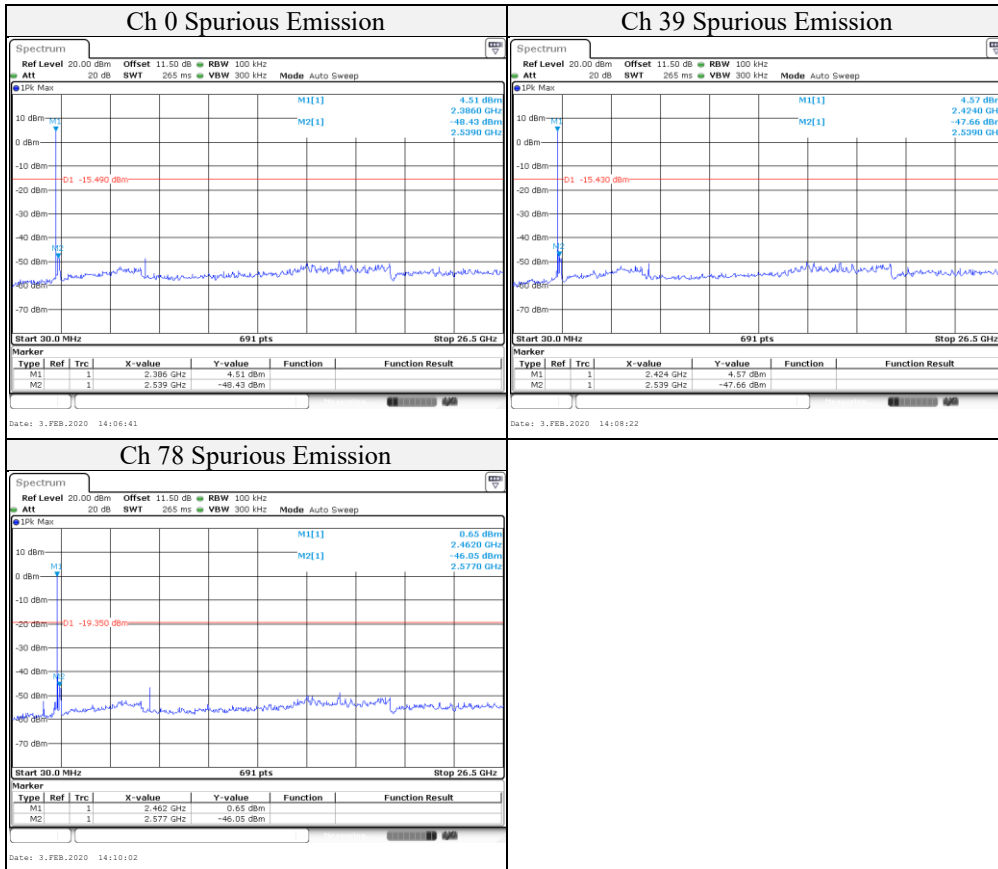

Underwriters Laboratories Taiwan Co., Ltd.

Building B and Building E, No. 372-7, Sec. 4, Zhongxing Rd., Zhudong Township, Hsinchu County, Taiwan

Telephone : +886-2-7737-3000

Facsimile (FAX) : +886-3-583-7948

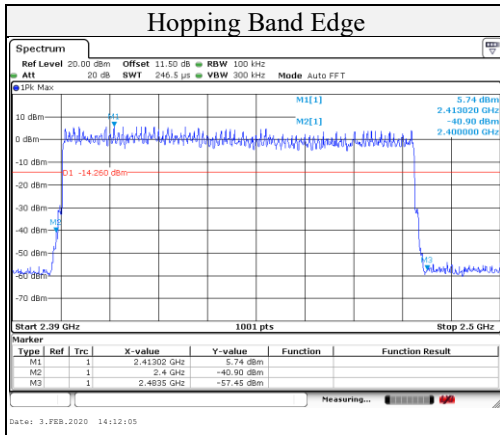
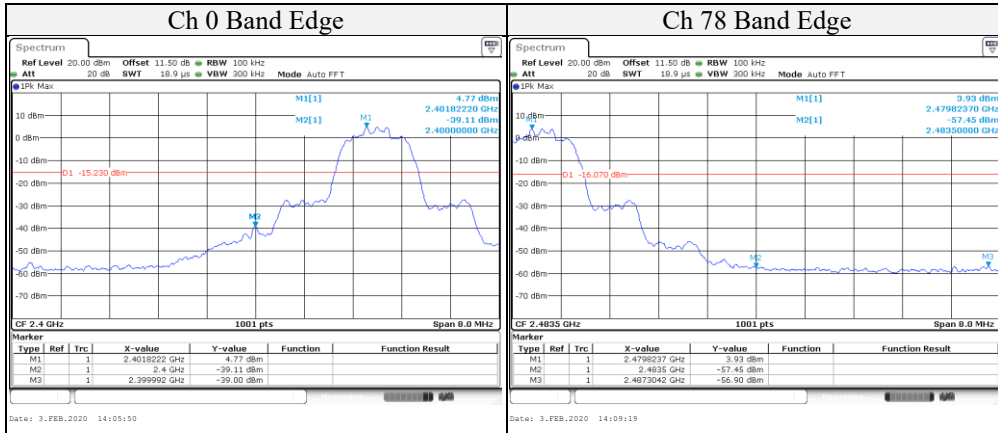



9.7. Radiated Spurious Emission

Requirements

Radiated emissions which fall in the restricted bands must comply with the radiated emission limits specified as below table. Other emissions shall be at least 20dB below the highest level of the desired power:

Frequency(MHz)	Field strength (microvolts/meter)	Measurement distance (meters)
0.009-0.490	2400/F(kHz)	300
0.490-1.705	24000/F(kHz)	30
1.705-30.0	30	30
30-88	100	3
88-216	150	3
216-960	200	3
Above 960	500	3

NOTE:

1. The lower limit shall apply at the transition frequencies.
2. Emission level (dBuV/m) = 20 log Emission level (uV/m).
3. For frequencies above 1000MHz, the field strength limits are based on average detector, however, the peak field strength of any emission shall not exceed the maximum permitted average limits, specified above by more than 20dB under any condition of modulation.

Underwriters Laboratories Taiwan Co., Ltd.

Building B and Building E, No. 372-7, Sec. 4, Zhongxing Rd., Zhudong Township, Hsinchu County, Taiwan

Telephone :+886-2-7737-3000

Facsimile (FAX) :+886-3-583-7948

Doc No: 17-EM-F0876 / 5.0



Test Procedures

[For 9 kHz ~ 30 MHz]

- a. The EUT was placed on the top of a rotating table 0.8 meters above the ground at a 3 meter chamber room. The table was rotated 360 degrees to determine the position of the highest radiation.
- b. The EUT was set 3 meters away from the interference-receiving antenna, which was mounted on the top of a variable-height antenna tower.
- c. Parallel, perpendicular, and ground-parallel orientations of the antenna are set to make the measurement.
- d. For each suspected emission, the EUT was arranged to its worst case and the rotatable table was turned from 0 degrees to 360 degrees to find the maximum reading.
- e. For measurement below 30MHz, the initial step in collecting conducted emission data is a spectrum analyzer peak detector mode pre-scanning the measurement frequency range. Significant peaks are then marked and then Quasi Peak detector mode re-measured. If the emission level of the EUT measured by the peak detector is lower than the applicable limit, the peak emission level will be reported. Otherwise, the emission measurement will be repeated using the quasi-peak detector and reported.

NOTE:

1. The resolution bandwidth and video bandwidth of test receiver/spectrum analyzer is 9kHz at frequency below 30MHz.

[For above 30 MHz]

- a. The EUT was placed on the top of a rotating table 0.8 meters (for 30MHz ~ 1GHz) / 1.5 meters (for above 1GHz) above the ground at 3 meter chamber room for test. The table was rotated 360 degrees to determine the position of the highest radiation.
- b. The EUT was set 3 meters away from the interference-receiving antenna, which was mounted on the top of a variable-height antenna tower.
- c. The height of antenna is varied from one meter to four meters above the ground to determine the maximum value of the field strength. Both horizontal and vertical polarizations of the antenna are set to make the measurement.
- d. For each suspected emission, the EUT was arranged to its worst case and then the antenna was tuned to heights from 1 meter to 4 meters and the rotatable table was turned from 0 degrees to 360 degrees to find the maximum reading.
- e. For measurement below 1GHz, the initial step in collecting conducted emission data is a spectrum analyzer peak detector mode pre-scanning the measurement frequency range. Significant peaks are then marked and then Quasi Peak detector mode re-measured. If the emission level of the EUT measured by the peak detector is lower than the applicable limit, the peak emission level will be reported. Otherwise, the emission measurement will be repeated using the quasi-peak detector and reported.
- f. The test-receiver system was set to peak and average detects function and specified bandwidth with maximum hold mode when the test frequency is above 1 GHz. If the peak reading value also meets average limit, measurement with the average detector is unnecessary.

Underwriters Laboratories Taiwan Co., Ltd.

Building B and Building E, No. 372-7, Sec. 4, Zhongxing Rd., Zhudong Township, Hsinchu County, Taiwan

Telephone :+886-2-7737-3000

Facsimile (FAX) :+886-3-583-7948

Doc No: 17-EM-F0876 / 5.0

Note:

- The resolution bandwidth and video bandwidth of test receiver/spectrum analyzer is 120kHz for Quasi-peak detection (QP) at frequency below 1GHz.
- The resolution bandwidth of test receiver/spectrum analyzer is 1 MHz and the video bandwidth is 3 MHz for Peak detection (PK) at frequency above 1GHz.
- The resolution bandwidth of test receiver/spectrum analyzer is 1MHz and the video bandwidth is $\geq 1/T$ (Duty cycle < 98%) or 10Hz (Duty cycle $\geq 98\%$) for Average detection (AV) at frequency above 1GHz.

Configuration	Average	
	RBW	VBW
Bluetooth	1MHz	1 kHz

Note:

- The GFSK Duty cycle = $(2.95/3.76)*100\% = 78.46\% < 98\%$, so video bandwidth is $1/2.95=0.34$ kHz. Therefore VBW configuration is 1 kHz for testing.
- The 8DPSK Duty cycle = $(2.96/3.75)*100\% = 78.93\% < 98\%$, so video bandwidth is $1/2.96=0.34$ kHz. Therefore VBW configuration is 1 kHz for testing.
- Refer to section 9.5 for duty cycle plots.

- All modes of operation were investigated (includes all external accessories) and the worst-case emissions are reported.

Test Setup

<Frequency Range 9 kHz ~ 30 MHz>

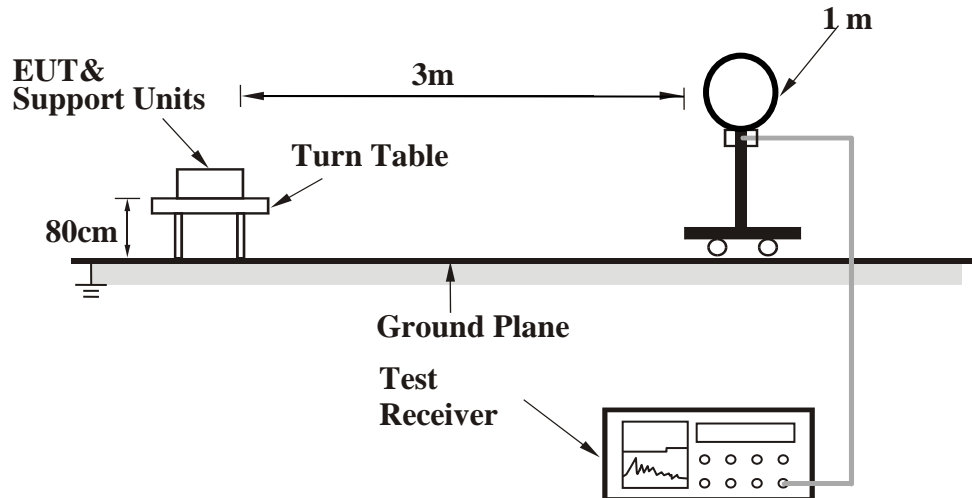

Underwriters Laboratories Taiwan Co., Ltd.

<Frequency Range 30 MHz ~ 1 GHz >

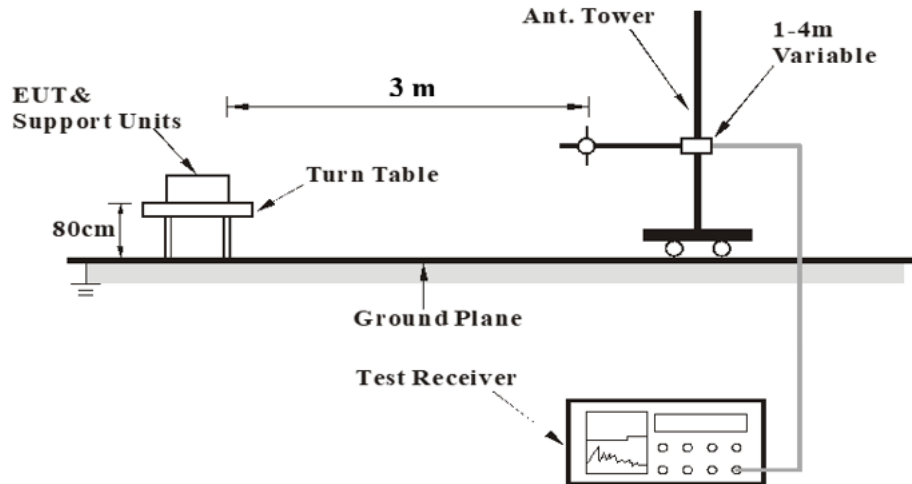

<Frequency Range above 1 GHz>

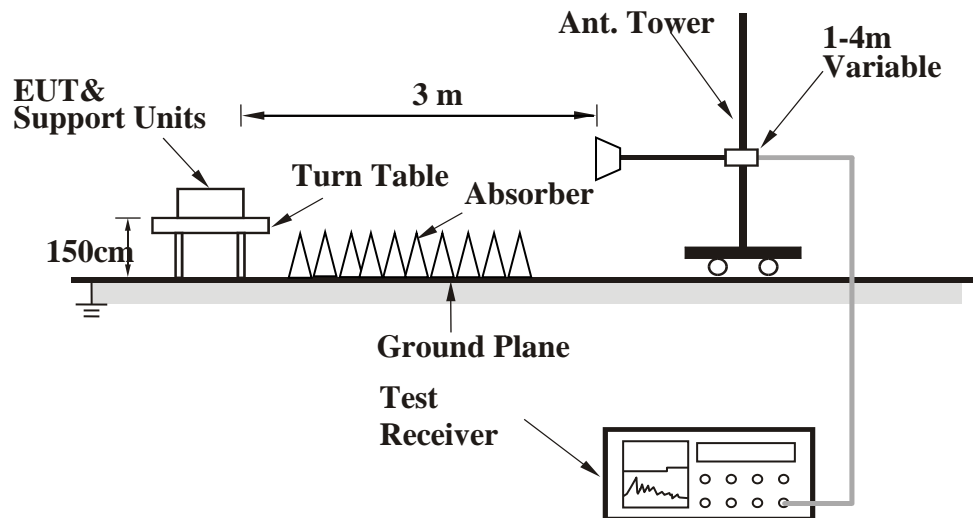

For the actual test configuration, please refer to the Setup Configurations.



Test Data

Above 1GHz Data

GFSK

EUT Test Condition		Measurement Detail	
Channel	Channel 0	Frequency Range	1 GHz ~ 25 GHz

Antenna Polarity & Test Distance: Horizontal at 3 m							
Notation	Frequency	Reading	Correct	Result	Limit	Margin	Remark
	(MHz)	(dBuV/m)	dB/m	(dBuV/m)	(dBuV/m)	(dB)	
-	2349.600	54.38	-6.82	47.56	74.00	-26.44	peak
@	2402.000	106.49	-6.87	99.62	-	-	peak
-	2489.600	53.66	-7.14	46.52	74.00	-27.48	peak
-	2323.800	42.80	-6.80	36.00	54.00	-18.00	AVG
@	2402.000	106.25	-6.87	99.38	-	-	AVG
-	2490.200	41.09	-7.14	33.95	54.00	-20.05	AVG
*	4804.000	52.80	-2.00	50.80	74.00	-23.20	peak
#	7206.000	49.18	4.30	53.48	79.62	-26.14	peak
Antenna Polarity & Test Distance: Vertical at 3 m							
Notation	Frequency	Reading	Correct	Result	Limit	Margin	Remark
	(MHz)	(dBuV/m)	dB/m	(dBuV/m)	(dBuV/m)	(dB)	
-	2323.400	53.94	-6.80	47.14	74.00	-26.86	peak
@	2402.000	106.07	-6.87	99.20	-	-	peak
-	2495.600	53.16	-7.15	46.01	74.00	-27.99	peak
-	2324.000	42.72	-6.80	35.92	54.00	-18.08	AVG
@	2402.000	105.82	-6.87	98.95	-	-	AVG
-	2495.800	41.06	-7.15	33.91	54.00	-20.09	AVG
*	4804.000	51.54	-2.00	49.54	74.00	-24.46	peak
#	7206.000	50.65	4.30	54.95	79.20	-24.25	peak

Remarks:

1. Result value (dBuV/m) = Reading value (dBuV/m) + Correction Factor (dB/m).
2. Margin(dB) = Result value (dBuV/m) - Limit value (dBuV/m).
3. Correction Factor (dB/m) = Antenna Factor (dBuV/m) + Cable Loss (dB) - Preamp Factor (dB).
4. "@": Fundamental Frequency.
5. "#": The radiated frequency is out of the restricted band.
6. "*": The peak result complies with AVG limit, AVG result is deemed to comply with AVG limit.
7. The other emission levels were very low against the limit.

Underwriters Laboratories Taiwan Co., Ltd.

Building B and Building E, No. 372-7, Sec. 4, Zhongxing Rd., Zhudong Township, Hsinchu County, Taiwan
Telephone :+886-2-7737-3000
Facsimile (FAX) :+886-3-583-7948



EUT Test Condition		Measurement Detail	
Channel	Channel 39	Frequency Range	1 GHz ~ 25 GHz

Antenna Polarity & Test Distance: Horizontal at 3 m							
Notation	Frequency	Reading	Correct	Result	Limit	Margin	Remark
	(MHz)	(dBuV/m)	dB/m	(dBuV/m)	(dBuV/m)	(dB)	
-	2337.200	55.38	-6.80	48.58	74.00	-25.42	peak
@	2441.000	107.43	-7.07	100.36	-	-	peak
-	2497.600	53.46	-7.15	46.31	74.00	-27.69	peak
-	2337.000	48.24	-6.80	41.44	54.00	-12.56	AVG
@	2441.000	107.13	-7.07	100.06	-	-	AVG
-	2493.000	41.92	-7.15	34.77	54.00	-19.23	AVG
*	4882.000	49.44	-1.86	47.58	74.00	-26.42	peak
-	7323.000	51.18	4.62	55.80	74.00	-18.20	peak
-	7323.000	46.88	4.62	51.50	54.00	-2.50	AVG
Antenna Polarity & Test Distance: Vertical at 3 m							
Notation	Frequency	Reading	Correct	Result	Limit	Margin	Remark
	(MHz)	(dBuV/m)	dB/m	(dBuV/m)	(dBuV/m)	(dB)	
-	2362.600	54.22	-6.84	47.38	74.00	-26.62	peak
@	2441.000	106.44	-7.07	99.37	-	-	peak
-	2494.400	53.65	-7.15	46.50	74.00	-27.50	peak
-	2337.000	48.79	-6.80	41.99	54.00	-12.01	AVG
@	2441.000	106.17	-7.07	99.10	-	-	AVG
-	2493.000	41.73	-7.15	34.58	54.00	-19.42	AVG
*	4882.000	49.71	-1.86	47.85	74.00	-26.15	peak
-	7323.000	51.73	4.62	56.35	74.00	-17.65	peak
-	7323.000	48.56	4.62	53.18	54.00	-0.82	AVG

Remarks:

1. Result value (dBuV/m) = Reading value (dBuV/m) + Correction Factor (dB/m).
2. Margin(dB) = Result value (dBuV/m) - Limit value (dBuV/m).
3. Correction Factor (dB/m) = Antenna Factor (dBuV/m) + Cable Loss (dB) - Preamp Factor (dB).
4. "@": Fundamental Frequency.
5. "* *": The peak result complies with AVG limit, AVG result is deemed to comply with AVG limit.
6. The other emission levels were very low against the limit.

Underwriters Laboratories Taiwan Co., Ltd.

Building B and Building E, No. 372-7, Sec. 4, Zhongxing Rd., Zhudong Township, Hsinchu County, Taiwan

Telephone :+886-2-7737-3000

Facsimile (FAX) :+886-3-583-7948

Doc No: 17-EM-F0876 / 5.0



EUT Test Condition		Measurement Detail	
Channel	Channel 78	Frequency Range	1 GHz ~ 25 GHz

Antenna Polarity & Test Distance: Horizontal at 3 m							
Notation	Frequency	Reading	Correct	Result	Limit	Margin	Remark
	(MHz)	(dBuV/m)	dB/m	(dBuV/m)	(dBuV/m)	(dB)	
-	2323.800	56.17	-6.80	49.37	74.00	-24.63	peak
@	2480.000	105.12	-7.14	97.98	-	-	peak
-	2483.500	52.94	-7.14	45.80	74.00	-28.20	peak
-	2324.000	50.08	-6.80	43.28	54.00	-10.72	AVG
@	2480.000	104.78	-7.14	97.64	-	-	AVG
-	2483.500	41.93	-7.14	34.79	54.00	-19.21	AVG
*	4960.000	52.14	-1.81	50.33	74.00	-23.67	peak
*	7440.000	47.53	4.79	52.32	74.00	-21.68	peak
Antenna Polarity & Test Distance: Vertical at 3 m							
Notation	Frequency	Reading	Correct	Result	Limit	Margin	Remark
	(MHz)	(dBuV/m)	dB/m	(dBuV/m)	(dBuV/m)	(dB)	
-	2324.000	56.91	-6.80	50.11	74.00	-23.89	peak
@	2480.000	104.22	-7.14	97.08	-	-	peak
-	2487.200	53.83	-7.14	46.69	74.00	-27.31	peak
-	2324.000	49.71	-6.80	42.91	54.00	-11.09	AVG
@	2480.000	103.88	-7.14	96.74	-	-	AVG
-	2483.500	41.78	-7.14	34.64	54.00	-19.36	AVG
*	4960.000	50.98	-1.81	49.17	74.00	-24.83	peak
*	7440.000	48.79	4.79	53.58	74.00	-20.42	peak

Remarks:

1. Result value (dBuV/m) = Reading value (dBuV/m) + Correction Factor (dB/m).
2. Margin(dB) = Result value (dBuV/m) - Limit value (dBuV/m).
3. Correction Factor (dB/m) = Antenna Factor (dBuV/m) + Cable Loss (dB) - Preamp Factor (dB).
4. "@": Fundamental Frequency.
5. "* *": The peak result complies with AVG limit, AVG result is deemed to comply with AVG limit.
6. The other emission levels were very low against the limit.

Underwriters Laboratories Taiwan Co., Ltd.

Building B and Building E, No. 372-7, Sec. 4, Zhongxing Rd., Zhudong Township, Hsinchu County, Taiwan
Telephone :+886-2-7737-3000
Facsimile (FAX) :+886-3-583-7948



8DPSK

EUT Test Condition		Measurement Detail	
Channel	Channel 0	Frequency Range	1 GHz ~ 25 GHz

Antenna Polarity & Test Distance: Horizontal at 3 m							
Notation	Frequency	Reading	Correct	Result	Limit	Margin	Remark
	(MHz)	(dBuV/m)	dB/m	(dBuV/m)	(dBuV/m)	(dB)	
-	2376.000	54.68	-6.84	47.84	74.00	-26.16	peak
@	2402.000	105.53	-6.87	98.66	-	-	peak
-	2486.200	54.12	-7.14	46.98	74.00	-27.02	peak
-	2324.000	41.80	-6.80	35.00	54.00	-19.00	AVG
@	2402.000	102.03	-6.87	95.16	-	-	AVG
-	2492.000	41.29	-7.14	34.15	54.00	-19.85	AVG
*	4804.000	45.70	-2.00	43.70	74.00	-30.30	peak
#	7206.000	46.26	4.30	50.56	78.66	-28.10	peak
Antenna Polarity & Test Distance: Vertical at 3 m							
Notation	Frequency	Reading	Correct	Result	Limit	Margin	Remark
	(MHz)	(dBuV/m)	dB/m	(dBuV/m)	(dBuV/m)	(dB)	
-	2344.060	54.26	-6.81	47.45	74.00	-26.55	peak
@	2402.000	104.11	-6.87	97.24	-	-	peak
-	2485.167	53.54	-7.14	46.40	74.00	-27.60	peak
-	2324.020	41.77	-6.80	34.97	54.00	-19.03	AVG
@	2402.000	100.67	-6.87	93.80	-	-	AVG
-	2496.973	41.14	-7.14	34.00	54.00	-20.00	AVG
*	4804.000	47.06	-2.00	45.06	74.00	-28.94	peak
#	7206.000	47.98	4.30	52.28	77.24	-24.96	peak

Remarks:

1. Result value (dBuV/m) = Reading value (dBuV/m) + Correction Factor (dB/m).
2. Margin(dB) = Result value (dBuV/m) - Limit value (dBuV/m).
3. Correction Factor (dB/m) = Antenna Factor (dBuV/m) + Cable Loss (dB) - Preamp Factor (dB).
4. "@": Fundamental Frequency.
5. "#": The radiated frequency is out of the restricted band.
6. "*": The peak result complies with AVG limit, AVG result is deemed to comply with AVG limit.
7. The other emission levels were very low against the limit.

Underwriters Laboratories Taiwan Co., Ltd.

Building B and Building E, No. 372-7, Sec. 4, Zhongxing Rd., Zhudong Township, Hsinchu County, Taiwan
Telephone :+886-2-7737-3000
Facsimile (FAX) :+886-3-583-7948



EUT Test Condition		Measurement Detail	
Channel	Channel 39	Frequency Range	1 GHz ~ 25 GHz

Antenna Polarity & Test Distance: Horizontal at 3 m							
Notation	Frequency	Reading	Correct	Result	Limit	Margin	Remark
	(MHz)	(dBuV/m)	dB/m	(dBuV/m)	(dBuV/m)	(dB)	
-	2337.200	55.43	-6.80	48.63	74.00	-25.37	peak
@	2441.000	107.05	-7.07	99.98	-	-	peak
-	2490.600	53.29	-7.14	46.15	74.00	-27.85	peak
-	2337.000	45.66	-6.80	38.86	54.00	-15.14	AVG
@	2441.000	103.89	-7.07	96.82	-	-	AVG
-	2493.000	41.38	-7.15	34.23	54.00	-19.77	AVG
*	4882.000	43.13	-1.86	41.27	74.00	-32.73	peak
*	7323.000	49.00	4.62	53.62	74.00	-20.38	peak
Antenna Polarity & Test Distance: Vertical at 3 m							
Notation	Frequency	Reading	Correct	Result	Limit	Margin	Remark
	(MHz)	(dBuV/m)	dB/m	(dBuV/m)	(dBuV/m)	(dB)	
-	2337.400	54.67	-6.80	47.87	74.00	-26.13	peak
@	2441.000	105.32	-7.07	98.25	-	-	peak
-	2498.200	54.38	-7.15	47.23	74.00	-26.77	peak
-	2337.000	44.63	-6.80	37.83	54.00	-16.17	AVG
@	2441.000	102.20	-7.07	95.13	-	-	AVG
-	2493.000	41.19	-7.15	34.04	54.00	-19.96	AVG
*	4882.000	45.43	-1.86	43.57	74.00	-30.43	peak
-	7323.000	52.03	4.62	56.65	74.00	-17.35	peak
-	7323.000	44.39	4.62	49.01	54.00	-4.99	AVG

Remarks:

1. Result value (dBuV/m) = Reading value (dBuV/m) + Correction Factor (dB/m).
2. Margin(dB) = Result value (dBuV/m) - Limit value (dBuV/m).
3. Correction Factor (dB/m) = Antenna Factor (dBuV/m) + Cable Loss (dB) - Preamp Factor (dB).
4. "@": Fundamental Frequency.
5. "* *": The peak result complies with AVG limit, AVG result is deemed to comply with AVG limit.
6. The other emission levels were very low against the limit.

Underwriters Laboratories Taiwan Co., Ltd.

Building B and Building E, No. 372-7, Sec. 4, Zhongxing Rd., Zhudong Township, Hsinchu County, Taiwan
Telephone :+886-2-7737-3000
Facsimile (FAX) :+886-3-583-7948



EUT Test Condition		Measurement Detail	
Channel	Channel 78	Frequency Range	1 GHz ~ 25 GHz

Antenna Polarity & Test Distance: Horizontal at 3 m							
Notation	Frequency	Reading	Correct	Result	Limit	Margin	Remark
	(MHz)	(dBuV/m)	dB/m	(dBuV/m)	(dBuV/m)	(dB)	
-	2324.200	54.87	-6.80	48.07	74.00	-25.93	peak
@	2480.000	103.82	-7.14	96.68	-	-	peak
-	2483.500	54.50	-7.14	47.36	74.00	-26.64	peak
-	2324.000	45.71	-6.80	38.91	54.00	-15.09	AVG
@	2480.000	100.21	-7.14	93.07	-	-	AVG
-	2483.500	41.98	-7.14	34.84	54.00	-19.16	AVG
*	4960.000	46.80	-1.81	44.99	74.00	-29.01	peak
*	7440.000	46.02	4.79	50.81	74.00	-23.19	peak
Antenna Polarity & Test Distance: Vertical at 3 m							
Notation	Frequency	Reading	Correct	Result	Limit	Margin	Remark
	(MHz)	(dBuV/m)	dB/m	(dBuV/m)	(dBuV/m)	(dB)	
-	2376.400	55.15	-6.84	48.31	74.00	-25.69	peak
@	2480.000	101.97	-7.14	94.83	-	-	peak
-	2496.200	54.71	-7.14	47.57	74.00	-26.43	peak
-	2324.000	44.62	-6.80	37.82	54.00	-16.18	AVG
@	2480.000	98.33	-7.14	91.19	-	-	AVG
-	2483.500	41.61	-7.14	34.47	54.00	-19.53	AVG
*	4960.000	46.88	-1.81	45.07	74.00	-28.93	peak
*	7440.000	48.87	4.79	53.66	74.00	-20.34	peak

Remarks:

1. Result value (dBuV/m) = Reading value (dBuV/m) + Correction Factor (dB/m).
2. Margin(dB) = Result value (dBuV/m) - Limit value (dBuV/m).
3. Correction Factor (dB/m) = Antenna Factor (dBuV/m) + Cable Loss (dB) - Preamp Factor (dB).
4. "@": Fundamental Frequency.
5. "* *": The peak result complies with AVG limit, AVG result is deemed to comply with AVG limit.
6. The other emission levels were very low against the limit.

Underwriters Laboratories Taiwan Co., Ltd.

Building B and Building E, No. 372-7, Sec. 4, Zhongxing Rd., Zhudong Township, Hsinchu County, Taiwan
Telephone :+886-2-7737-3000
Facsimile (FAX) :+886-3-583-7948



9 kHz ~ 30 MHz Data

For 9 kHz to 30 MHz radiated emission have performed all modes of operation were investigated. The amplitude of spurious emissions attenuated more than 20 dB below the permissible value is not required to be report.

No non-compliance noted:

KDB 414788 D01 OATS and Chamber Correlation Justification

- Base on FCC 15.31 (f) (2): measurements may be performed at a distance closer than that specified in the regulations; however, an attempt should be made to avoid making measurements in the near field.

- OATs and chamber correlation testing had been performed and chamber measured test results is the worst case test result.

Although these tests were performed other than open area test site, adequate comparison measurements were confirmed against 30m open area test site. Therefore sufficient tests were made to demonstrate that the alternative site produces results that correlate with the ones of tests made in an open field based on KDB 414788.

Underwriters Laboratories Taiwan Co., Ltd.

Building B and Building E, No. 372-7, Sec. 4, Zhongxing Rd., Zhudong Township, Hsinchu County, Taiwan

Telephone :+886-2-7737-3000

Facsimile (FAX) :+886-3-583-7948



30 MHz ~ 1 GHz Data

GFSK

EUT Test Condition		Measurement Detail	
Channel	Channel 39	Frequency Range	30 MHz ~ 1 GHz

Horizontal

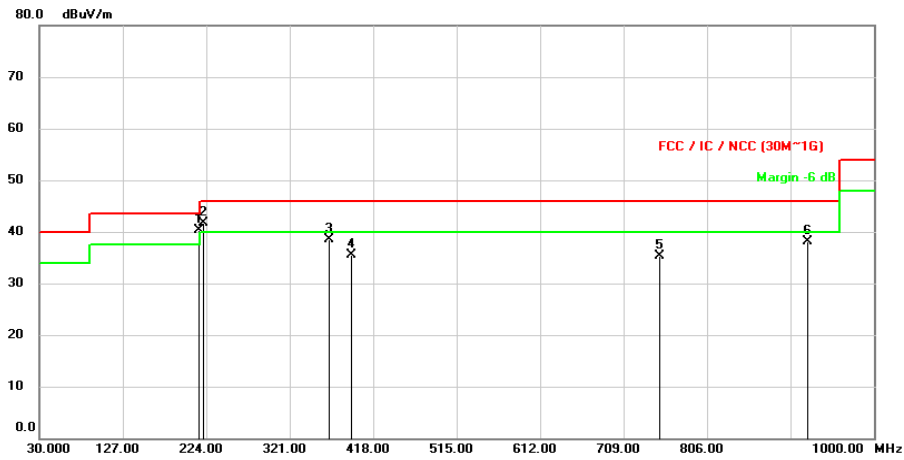

Vertical

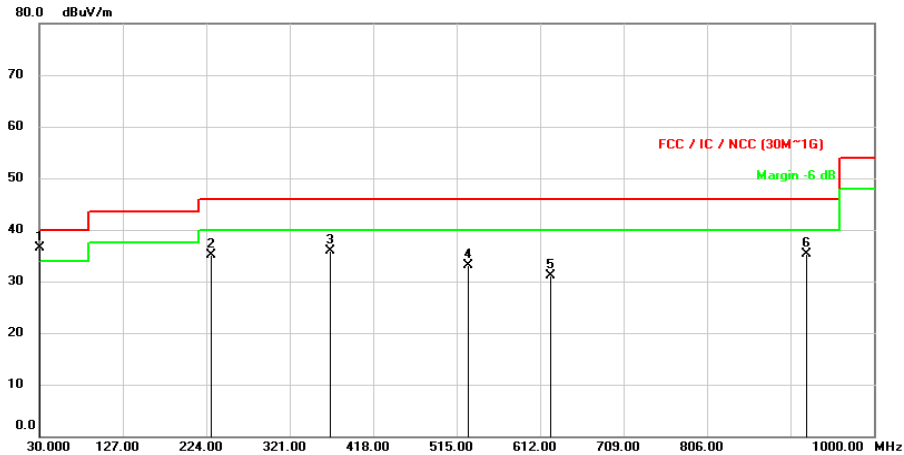

Underwriters Laboratories Taiwan Co., Ltd.

Building B and Building E, No. 372-7, Sec. 4, Zhongxing Rd., Zhudong Township, Hsinchu County, Taiwan

Telephone : +886-2-7737-3000

Facsimile (FAX) : +886-3-583-7948

Doc No: 17-EM-F0876 / 5.0



Antenna Polarity & Test Distance: Horizontal at 3 m							
Notation	Frequency	Reading	Correct	Result	Limit	Margin	Remark
	(MHz)	(dBuV/m)	dB/m	(dBuV/m)	(dBuV/m)	(dB)	
-	214.6557	57.93	-17.53	40.40	43.50	-3.10	peak
-	221.5749	58.98	-17.32	41.66	46.00	-4.34	peak
-	366.4930	50.66	-12.08	38.58	46.00	-7.42	peak
-	393.1356	47.33	-11.76	35.57	46.00	-10.43	peak
-	750.0310	39.26	-4.02	35.24	46.00	-10.76	peak
-	921.6563	39.94	-1.79	38.15	46.00	-7.85	peak

Antenna Polarity & Test Distance: Vertical at 3 m							
Notation	Frequency	Reading	Correct	Result	Limit	Margin	Remark
	(MHz)	(dBuV/m)	dB/m	(dBuV/m)	(dBuV/m)	(dB)	
-	30.0000	52.58	-15.99	36.59	40.00	-3.41	peak
-	230.0140	51.56	-16.54	35.02	46.00	-10.98	peak
-	367.9803	47.88	-12.04	35.84	46.00	-10.16	peak
-	527.9657	41.36	-8.20	33.16	46.00	-12.84	peak
-	624.9980	37.16	-6.01	31.15	46.00	-14.85	peak
-	920.6540	37.04	-1.81	35.23	46.00	-10.77	peak

Remarks:

1. Result value (dBuV/m) = Reading value (dBuV/m) + Correction Factor (dB/m).
2. Margin(dB) = Result value (dBuV/m) - Limit value (dBuV/m).
3. Correction Factor (dB/m) = Antenna Factor (dBuV/m) + Cable Loss (dB) - Preamp Factor (dB).
4. The peak result complies with QP limit, QP result is deemed to comply with QP limit.
5. The other emission levels were very low against the limit.

Underwriters Laboratories Taiwan Co., Ltd.

Building B and Building E, No. 372-7, Sec. 4, Zhongxing Rd., Zhudong Township, Hsinchu County, Taiwan

Telephone :+886-2-7737-3000

Facsimile (FAX) :+886-3-583-7948

Doc No: 17-EM-F0876 / 5.0



9.8. AC Power Line Conducted Emission

Requirements

Frequency (MHz)	Conducted limit (dB μ V)	
	Quasi-peak	Average
0.15 - 0.5	66 - 56	56 - 46
0.50 - 5.0	56	46
5.0 - 30	60	50

Note:

1. The lower limit shall apply at the transition frequencies.
2. The limit decreases in line with the logarithm of the frequency in the range of 0.15 to 0.50MHz.

Test Procedures

- a. The EUT was placed 0.4 meters from the conducting wall of the shielded room with EUT being connected to the power mains through a line impedance stabilization network (LISN). Other support units were connected to the power mains through another LISN. The two LISNs provide 50 ohm/ 50uH of coupling impedance for the measuring instrument.
- b. Both lines of the power mains connected to the EUT were checked for maximum conducted interference.
- c. The frequency range from 150kHz to 30MHz was searched. Emission levels under (Limit - 20dB) was not recorded.

NOTE:

1. The resolution bandwidth and video bandwidth of test receiver is 9kHz for quasi-peak detection (QP) and average detection (AV) at frequency 0.15MHz-30MHz.

Underwriters Laboratories Taiwan Co., Ltd.

Building B and Building E, No. 372-7, Sec. 4, Zhongxing Rd., Zhudong Township, Hsinchu County, Taiwan

Telephone :+886-2-7737-3000

Facsimile (FAX) :+886-3-583-7948

Doc No: 17-EM-F0876 / 5.0



Test Setup

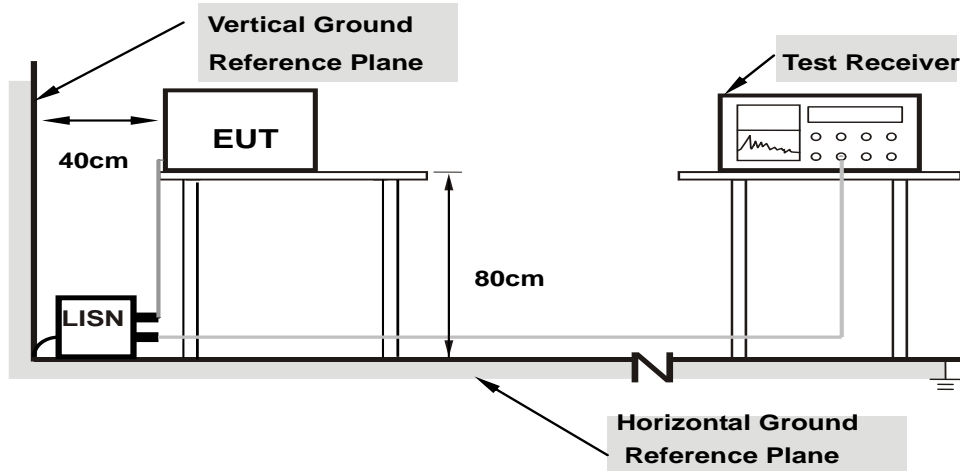

Note: 1.Support units were connected to second LISN.

For the actual test configuration, please refer to the Setup Configurations.

Underwriters Laboratories Taiwan Co., Ltd.

Building B and Building E, No. 372-7, Sec. 4, Zhongxing Rd., Zhudong Township, Hsinchu County, Taiwan

Telephone :+886-2-7737-3000

Facsimile (FAX) :+886-3-583-7948

Doc No: 17-EM-F0876 / 5.0



Test Data

GFSK

EUT Test Condition		Measurement Detail	
Channel	Channel 39	Frequency Range	150 kHz ~ 30 MHz

Phase of Power : Line (L)

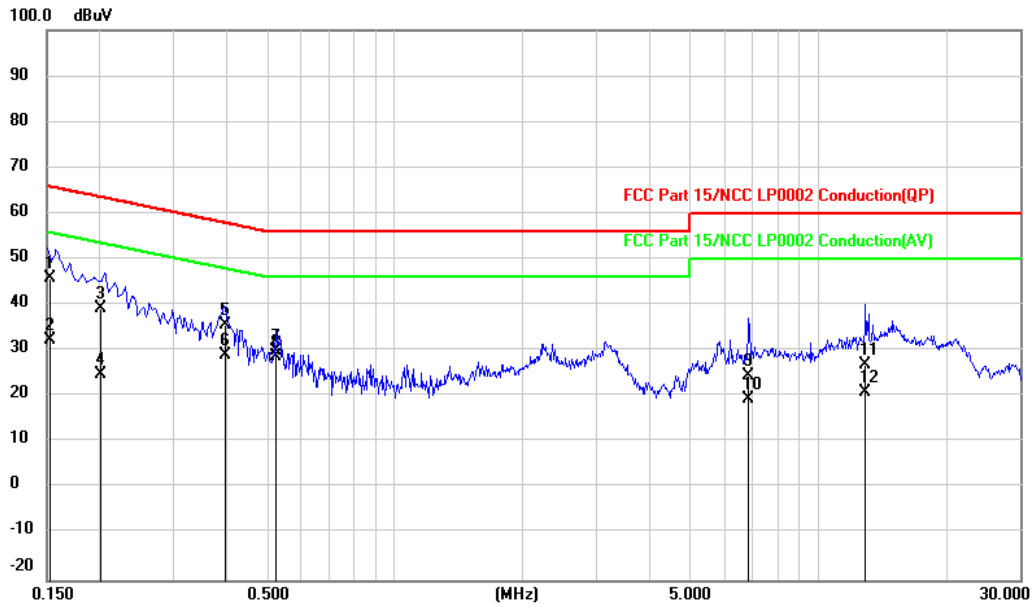

Underwriters Laboratories Taiwan Co., Ltd.

Building B and Building E, No. 372-7, Sec. 4, Zhongxing Rd., Zhudong Township, Hsinchu County, Taiwan

Telephone : +886-2-7737-3000

Facsimile (FAX) : +886-3-583-7948

Doc No: 17-EM-F0876 / 5.0



No.	Frequency (MHz)	Reading (dBuV)	Correct dB	Result (dBuV)	Limit (dBuV)	Margin (dB)	Remark
1	0.1531	26.50	19.47	45.97	65.83	-19.86	QP
2	0.1531	13.02	19.47	32.49	55.83	-23.34	AVG
3	0.2012	19.75	19.47	39.22	63.56	-24.34	QP
4	0.2012	5.39	19.47	24.86	53.56	-28.70	AVG
5	0.3964	16.19	19.47	35.66	57.93	-22.27	QP
6	0.3964	9.44	19.47	28.91	47.93	-19.02	AVG
7	0.5229	10.33	19.48	29.81	56.00	-26.19	QP
8	0.5229	9.38	19.48	28.86	46.00	-17.14	AVG
9	6.8812	4.85	19.63	24.48	60.00	-35.52	QP
10	6.8812	-0.22	19.63	19.41	50.00	-30.59	AVG
11	12.9873	7.30	19.71	27.01	60.00	-32.99	QP
12	12.9873	1.25	19.71	20.96	50.00	-29.04	AVG

Remarks:

1. Result value (dBuV) = Reading value (dBuV) + Correction Factor (dB)
2. Margin(dB) = Result value (dBuV) - Limit value (dBuV)
3. Correction Factor(dB) = Insertion loss(dB) + Cable loss(dB)
4. The other emission levels were very low against the limit.

Underwriters Laboratories Taiwan Co., Ltd.

Building B and Building E, No. 372-7, Sec. 4, Zhongxing Rd., Zhudong Township, Hsinchu County, Taiwan

Telephone :+886-2-7737-3000

Facsimile (FAX) :+886-3-583-7948

Doc No: 17-EM-F0876 / 5.0



Phase of Power : Neutral (N)

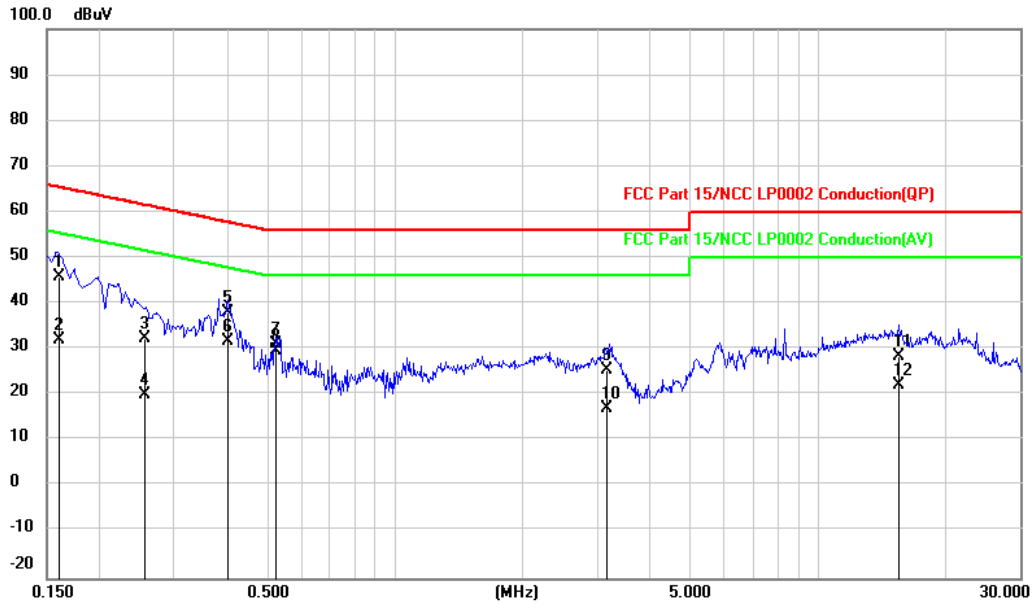

Underwriters Laboratories Taiwan Co., Ltd.

Building B and Building E, No. 372-7, Sec. 4, Zhongxing Rd., Zhudong Township, Hsinchu County, Taiwan

Telephone : +886-2-7737-3000

Facsimile (FAX) : +886-3-583-7948

Doc No: 17-EM-F0876 / 5.0



No.	Frequency (MHz)	Reading (dBuV)	Correct dB	Result (dBuV)	Limit (dBuV)	Margin (dB)	Remark
1	0.1616	26.27	19.47	45.74	65.38	-19.64	QP
2	0.1616	12.53	19.47	32.00	55.38	-23.38	AVG
3	0.2556	12.73	19.48	32.21	61.57	-29.36	QP
4	0.2556	0.46	19.48	19.94	51.57	-31.63	AVG
5	0.4016	18.67	19.49	38.16	57.82	-19.66	QP
6	0.4016	12.34	19.49	31.83	47.82	-15.99	AVG
7	0.5235	11.74	19.49	31.23	56.00	-24.77	QP
8	0.5235	10.27	19.49	29.76	46.00	-16.24	AVG
9	3.1796	5.92	19.57	25.49	56.00	-30.51	QP
10	3.1796	-2.60	19.57	16.97	46.00	-29.03	AVG
11	15.4248	8.67	19.80	28.47	60.00	-31.53	QP
12	15.4248	2.46	19.80	22.26	50.00	-27.74	AVG

Remarks:

1. Result value (dBuV) = Reading value (dBuV) + Correction Factor (dB)
2. Margin(dB) = Result value (dBuV) - Limit value (dBuV)
3. Correction Factor(dB) = Insertion loss(dB) + Cable loss(dB)
4. The other emission levels were very low against the limit.

Underwriters Laboratories Taiwan Co., Ltd.

Building B and Building E, No. 372-7, Sec. 4, Zhongxing Rd., Zhudong Township, Hsinchu County, Taiwan

Telephone :+886-2-7737-3000

Facsimile (FAX) :+886-3-583-7948

Doc No: 17-EM-F0876 / 5.0



Appendix I Radiated Band Edge Measurement

GFSK

Peak

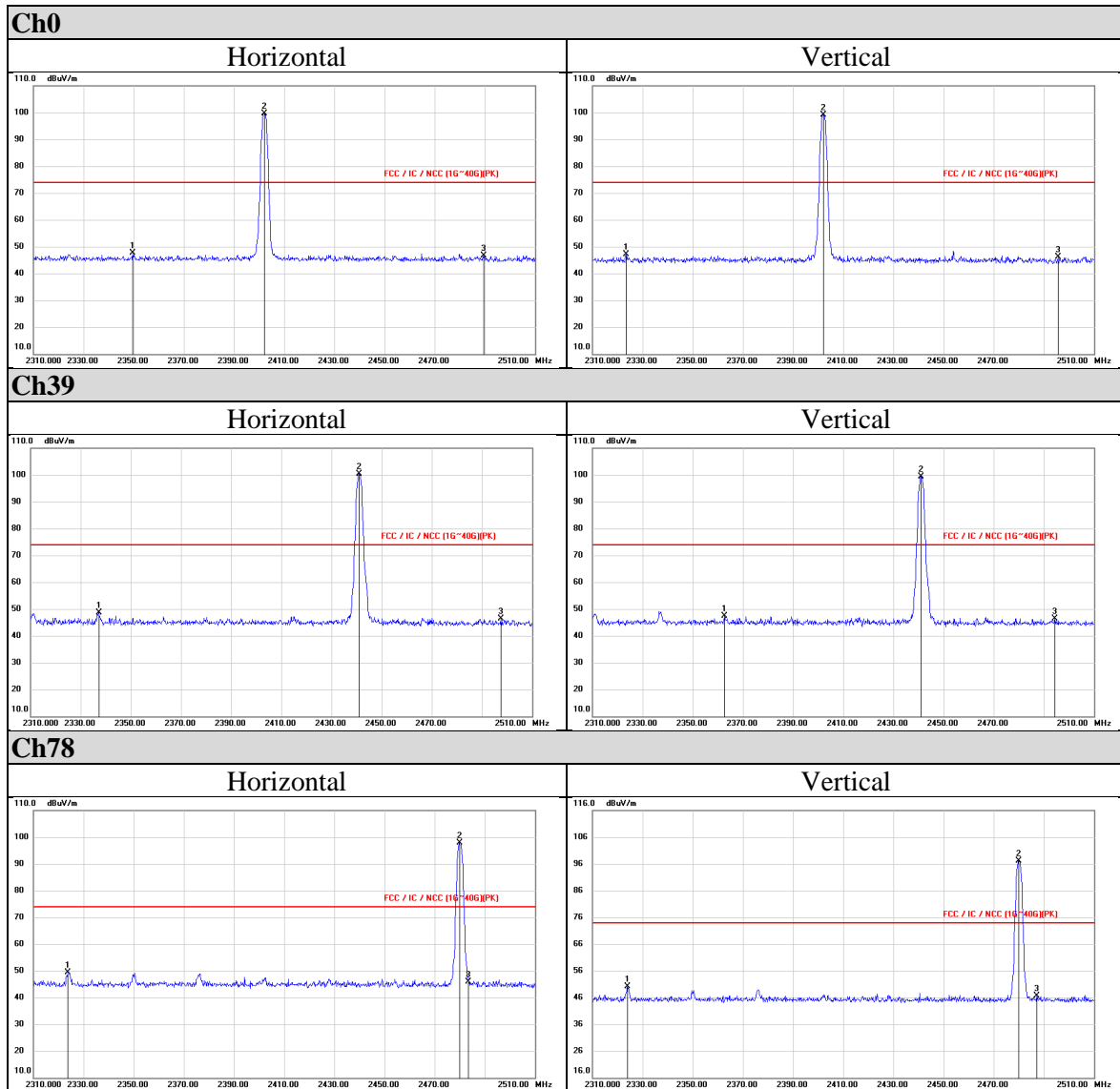

Underwriters Laboratories Taiwan Co., Ltd.

Building B and Building E, No. 372-7, Sec. 4, Zhongxing Rd., Zhudong Township, Hsinchu County, Taiwan

Telephone : +886-2-7737-3000

Facsimile (FAX) : +886-3-583-7948

Doc No: 17-EM-F0876 / 5.0



Average

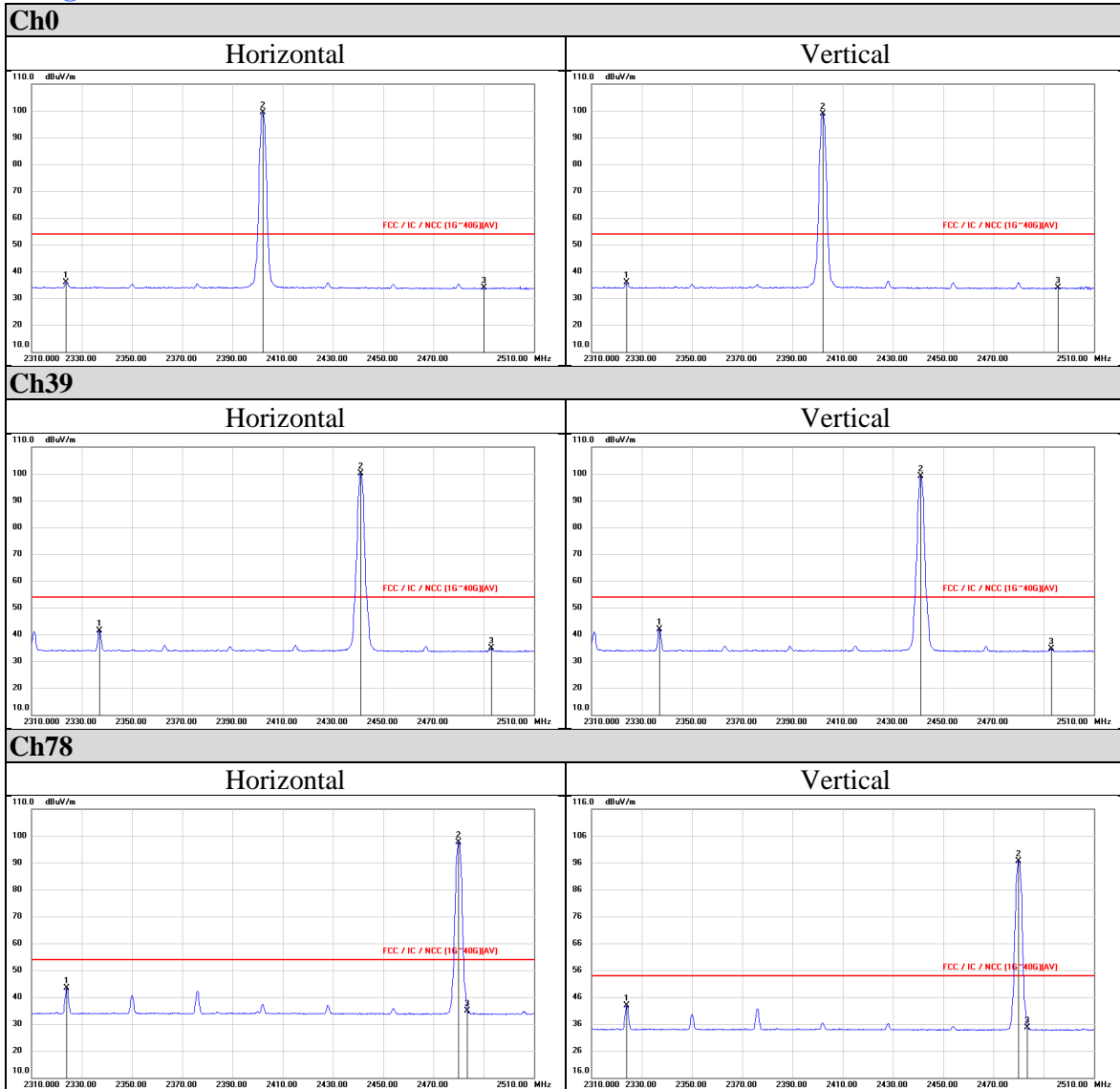

Underwriters Laboratories Taiwan Co., Ltd.

Building B and Building E, No. 372-7, Sec. 4, Zhongxing Rd., Zhudong Township, Hsinchu County, Taiwan

Telephone : +886-2-7737-3000

Facsimile (FAX) : +886-3-583-7948

Doc No: 17-EM-F0876 / 5.0



8DPSK

Peak

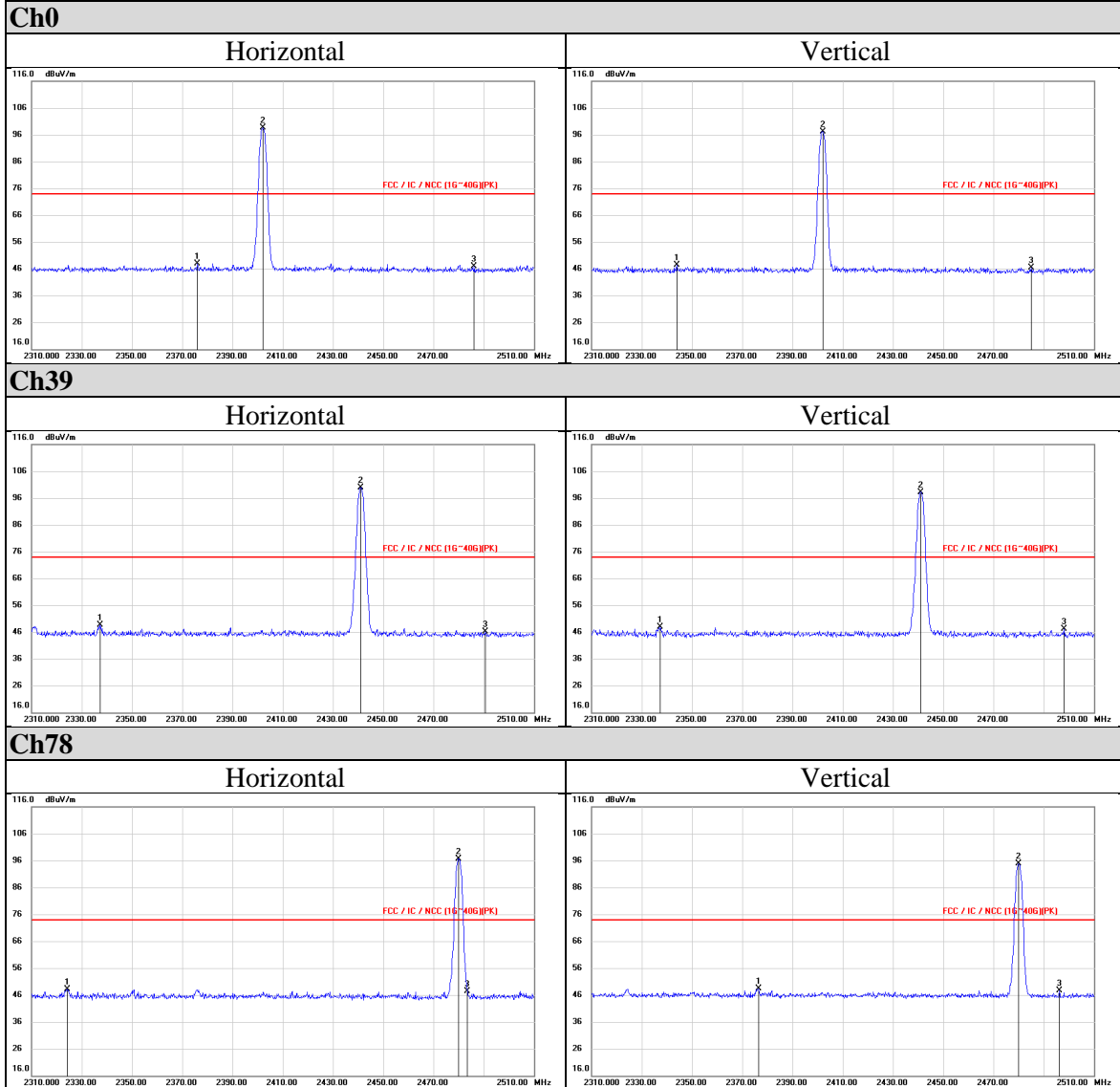

Underwriters Laboratories Taiwan Co., Ltd.

Building B and Building E, No. 372-7, Sec. 4, Zhongxing Rd., Zhudong Township, Hsinchu County, Taiwan

Telephone : +886-2-7737-3000

Facsimile (FAX) : +886-3-583-7948

Doc No: 17-EM-F0876 / 5.0



Average

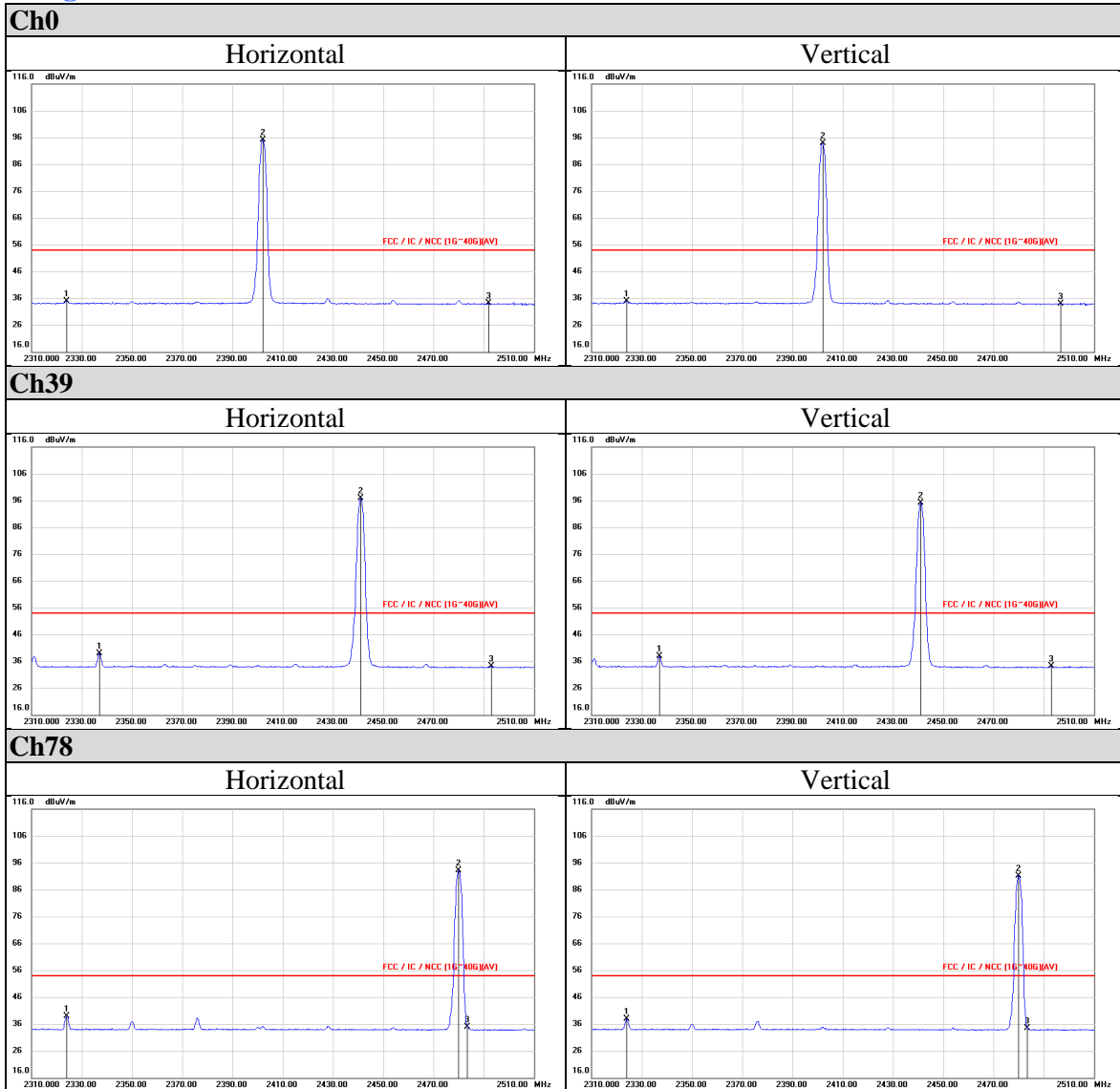

Underwriters Laboratories Taiwan Co., Ltd.

Building B and Building E, No. 372-7, Sec. 4, Zhongxing Rd., Zhudong Township, Hsinchu County, Taiwan

Telephone : +886-2-7737-3000

Facsimile (FAX) : +886-3-583-7948

Doc No: 17-EM-F0876 / 5.0



Appendix II Radiated Spurious Emission Measurement

GFSK

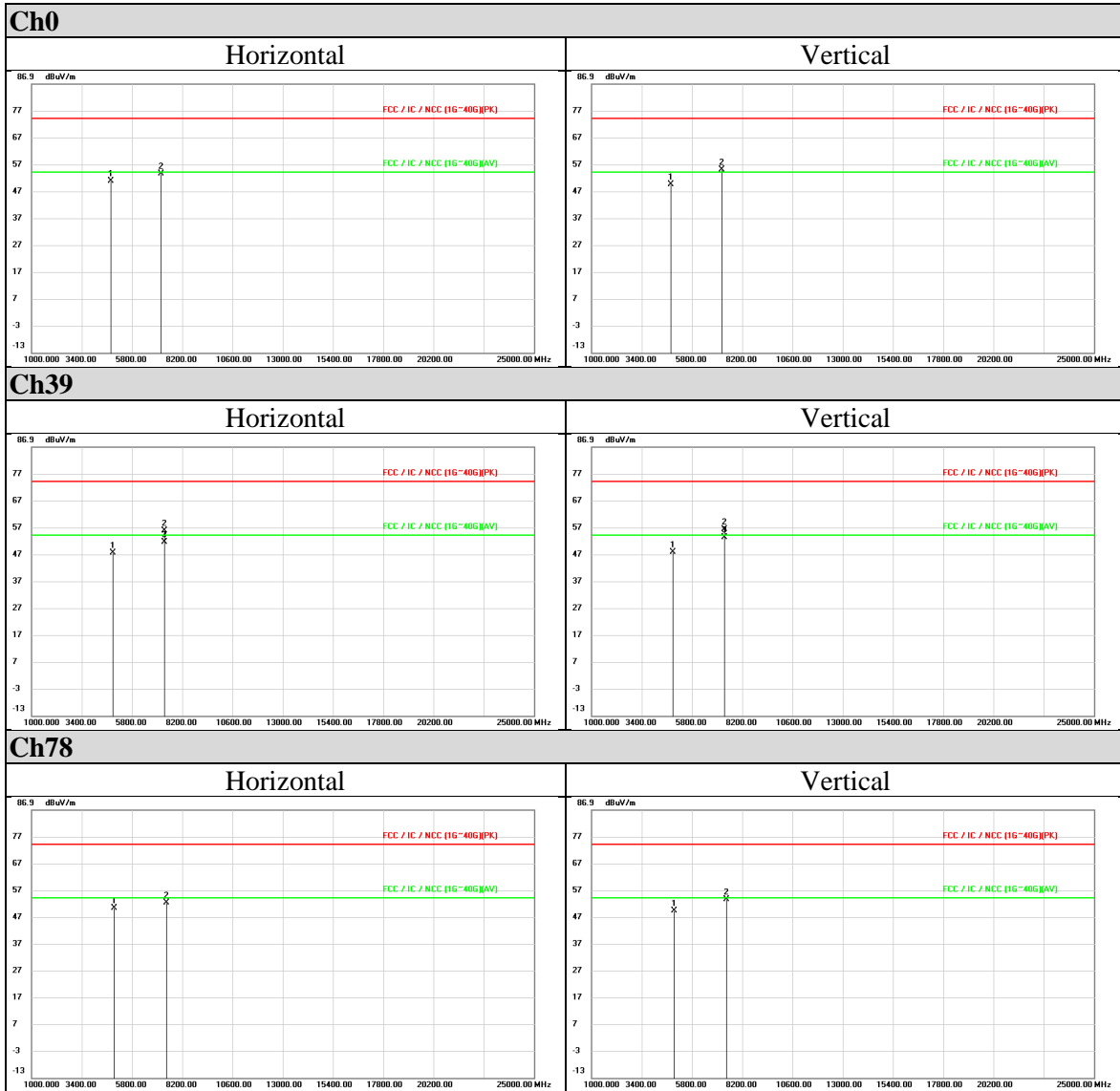

Underwriters Laboratories Taiwan Co., Ltd.

Building B and Building E, No. 372-7, Sec. 4, Zhongxing Rd., Zhudong Township, Hsinchu County, Taiwan

Telephone : +886-2-7737-3000

Facsimile (FAX) : +886-3-583-7948

Doc No: 17-EM-F0876 / 5.0



8DPSK

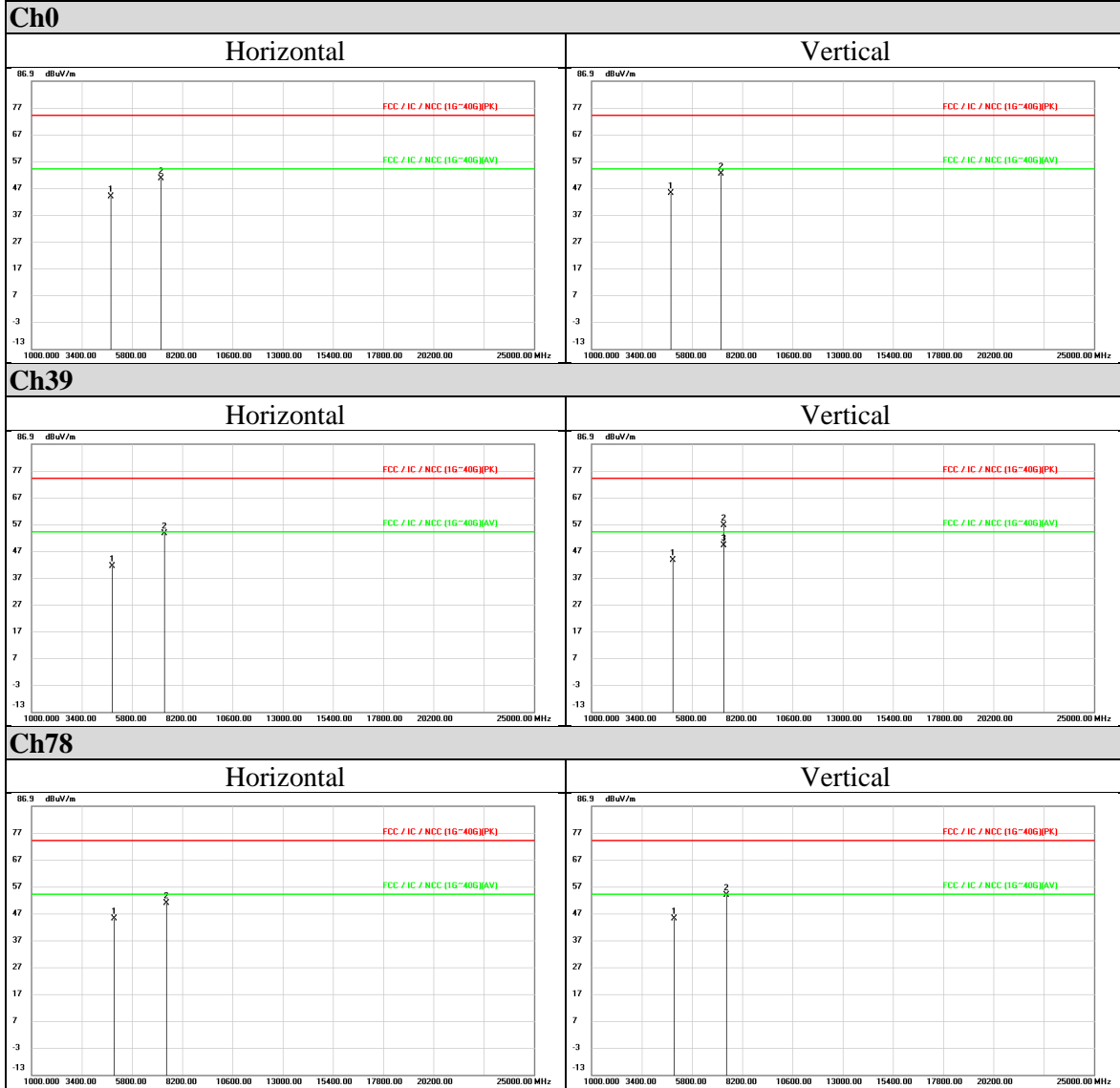

Underwriters Laboratories Taiwan Co., Ltd.

Building B and Building E, No. 372-7, Sec. 4, Zhongxing Rd., Zhudong Township, Hsinchu County, Taiwan

Telephone : +886-2-7737-3000

Facsimile (FAX) : +886-3-583-7948

Doc No: 17-EM-F0876 / 5.0