

FCC Test Report

Report No.: RF151210D05

FCC ID: 2AHDGCC30R15-2

Test Model: V8F1R

Received Date: Dec. 10, 2015

Test Date: Dec. 28, 2015 ~ Jan. 13, 2016

Issued Date: Jan. 14, 2016

Applicant: AVer Information Inc.

Address: No. 157, Da-An Rd., Tucheng Dist., New Taipei City 23673, Taiwan

Issued By: Bureau Veritas Consumer Products Services (H.K.) Ltd., Taoyuan Branch

Lab Address: No. 47-2, 14th Ling, Chia Pau Vil., Lin Kou Dist., New Taipei City, Taiwan (R.O.C.)



This report is for your exclusive use. Any copying or replication of this report to or for any other person or entity, or use of our name or trademark, is permitted only with our prior written permission. This report sets forth our findings solely with respect to the test samples identified herein. The results set forth in this report are not indicative or representative of the quality or characteristics of the lot from which a test sample was taken or any similar or identical product unless specifically and expressly noted. Our report includes all of the tests requested by you and the results thereof based upon the information that you provided to us. You have 60 days from date of issuance of this report to notify us of any material error or omission caused by our negligence, provided, however, that such notice shall be in writing and shall specifically address the issue you wish to raise. A failure to raise such issue within the prescribed time shall constitute your unqualified acceptance of the completeness of this report, the tests conducted and the correctness of the report contents. Unless specific mention, the uncertainty of measurement has been explicitly taken into account to declare the compliance or non-compliance to the specification. The report must not be used by the client to claim product certification, approval, or endorsement by TAF or any government agencies.

Table of Contents

Release Control Record	4
1 Certificate of Conformity	5
2 Summary of Test Results	6
2.1 Measurement Uncertainty.....	6
2.2 Modification Record.....	6
3 General Information	7
3.1 General Description of EUT	7
3.2 Description of Test Modes	8
3.2.1 Test Mode Applicability and Tested Channel Detail.....	9
3.3 Description of Support Units	11
3.3.1 Configuration of System under Test	12
3.4 General Description of Applied Standards.....	13
4 Test Types and Results	14
4.1 Radiated Emission and Bandedge Measurement.....	14
4.1.1 Limits of Radiated Emission and Bandedge Measurement	14
4.1.2 Test Instruments	15
4.1.3 Test Procedures	16
4.1.4 Deviation from Test Standard	16
4.1.5 Test Set Up.....	17
4.1.6 EUT Operating Conditions	17
4.1.7 Test Results.....	18
4.2 Conducted Emission Measurement	22
4.2.1 Limits of Conducted Emission Measurement.....	22
4.2.2 Test Instruments	22
4.2.3 Test Procedures	23
4.2.4 Deviation From Test Standard.....	23
4.2.5 Test Setup	23
4.2.6 EUT Operating Condition.....	23
4.2.7 Test Results.....	24
4.3 Number of Hopping Frequency Used.....	26
4.3.1 Limits of Hopping Frequency Used Measurement	26
4.3.2 Test Setup	26
4.3.3 Test Instruments	26
4.3.4 Test Procedure	26
4.3.5 Deviation from Test Standard	26
4.3.6 Test Results.....	27
4.4 Dwell Time on Each Channel.....	28
4.4.1 Limits of Dwell Time on Each Channel Measurement.....	28
4.4.2 Test Setup	28
4.4.3 Test Instruments	28
4.4.4 Test Procedures	28
4.4.5 Deviation from Test Standard	28
4.4.6 Test Results.....	29
4.5 Channel Bandwidth	30
4.5.1 Limits of Channel Bandwidth Measurement	30
4.5.2 Test Setup	30
4.5.3 Test Instruments	30
4.5.4 Test Procedure	30
4.5.5 Deviation from Test Standard	30
4.5.6 EUT Operating Condition.....	30
4.5.7 Test Results.....	31
4.6 Hopping Channel Separation.....	32

4.6.1	Limits of Hopping Channel Separation Measurement.....	32
4.6.2	Test Setup	32
4.6.3	Test Instruments	32
4.6.4	Test Procedure	32
4.6.5	Deviation From Test Standard.....	32
4.6.6	Test Results.....	33
4.7	Maximum Output Power	34
4.7.1	Limits of Maximum Output Power Measurement	34
4.7.2	Test Setup	34
4.7.3	Test Instruments	34
4.7.4	Test Procedure	34
4.7.5	Deviation from Test Standard.....	34
4.7.6	EUT Operating Condition.....	34
4.7.7	Test Results.....	35
4.8	Conducted Out of Band Emission Measurement.....	36
4.8.1	Limits Of Conducted Out Of Band Emission Measurement.....	36
4.8.2	Test Instruments	36
4.8.3	Test Procedure	36
4.8.4	Deviation From Test Standard.....	36
4.8.5	Eut Operating Condition	36
4.8.6	Test Results.....	36
5	Pictures of Test Arrangements.....	38
	Appendix – Information on the Testing Laboratories	39



A D T

Release Control Record

Issue No.	Description	Date Issued
RF151210D05	Original release.	Jan. 14, 2016

1 Certificate of Conformity

Product: Wireless Receiver

Brand: AVer

Test Model: V8F1R

Sample Status: Engineering sample

Applicant: AVer Information Inc.

Test Date: Dec. 28, 2015 ~ Jan. 13, 2016

Standards: 47 CFR FCC Part 15, Subpart C (Section 15.247)
ANSI C63.10:2013

The above equipment has been tested by **Bureau Veritas Consumer Products Services (H.K.) Ltd., Taoyuan Branch**, and found compliance with the requirement of the above standards. The test record, data evaluation & Equipment Under Test (EUT) configurations represented herein are true and accurate accounts of the measurements of the sample's EMC characteristics under the conditions specified in this report.

Prepared by : Celia Chen , **Date:** Jan. 14, 2016
(Celia Chen / Supervisor)

Approved by : Rex Lai , **Date:** Jan. 14, 2016
(Rex Lai / Assistant Manager)

2 Summary of Test Results

47 CFR FCC Part 15, Subpart C (SECTION 15.247)			
FCC Clause	Test Item	Result	Remarks
15.207	AC Power Conducted Emission	PASS	Meet the requirement of limit. Minimum passing margin is -16.02dB at 17.15846MHz.
15.247(a)(1)(iii)	Number of Hopping Frequency Used	PASS	Meet the requirement of limit.
15.247(a)(1)(iii)	Dwell Time on Each Channel	PASS	Meet the requirement of limit.
15.247(a)(1)	1. Hopping Channel Separation 2. Spectrum Bandwidth of a Frequency Hopping Sequence Spread Spectrum System	PASS	Meet the requirement of limit.
15.247(b)	Maximum Peak Output Power	PASS	Meet the requirement of limit.
15.205 & 209	Radiated Emissions	PASS	Meet the requirement of limit. Minimum passing margin is -4.1dB at 32.23MHz.
15.247(d)	Band Edge Measurement	PASS	Meet the requirement of limit. Minimum passing margin is -10.8dB at 2483.50MHz.
15.247(d)	Antenna Port Emission	PASS	Meet the requirement of limit.
15.203	Antenna Requirement	PASS	No antenna connector is used.

NOTE: If The Frequency Hopping System operating in 2400-2483.5MHz band and the output power less than 125mW. The hopping channel carrier frequencies separated by a minimum of 25kHz or two-thirds of the 20dB bandwidth of hopping channel whichever is greater.

2.1 Measurement Uncertainty

Where relevant, the following measurement uncertainty levels have been estimated for tests performed on the EUT as specified in CISPR 16-4-2:

Measurement	Frequency	Expanded Uncertainty (k=2) (±)
Conducted Emissions at mains ports	150kHz ~ 30MHz	2.78 dB
Radiated Emissions up to 1 GHz	30MHz ~ 1000MHz	4.00 dB
Radiated Emissions above 1 GHz	1GHz ~ 40GHz	3.36 dB

2.2 Modification Record

There were no modifications required for compliance.

3 General Information

3.1 General Description of EUT

Product	Wireless Receiver
Brand	AVer
Test Model	V8F1R
Status of EUT	Engineering sample
Power Supply Rating	5Vdc from Fixed Lens Classroom Camera
Modulation Type	GFSK
Modulation Technology	FHSS
Transfer Rate	4Mbps
Operating Frequency	2406 ~ 2474MHz
Number of Channel	18
Output Power	4.436mW
Antenna Type	PCB antenna with 1.28dBi gain
Antenna Connector	N/A
Accessory Device	N/A
Data Cable Supplied	N/A

Note:

1. The EUT is a Wireless Receiver.
2. The above EUT information is declared by manufacturer and for more detailed features description, please refer to the manufacturer's specifications or User's Manual.

3.2 Description of Test Modes

18 channels are provided for EUT:

Channel	Freq. (MHz)	Channel	Freq. (MHz)
4	2406	40	2442
8	2410	44	2446
12	2414	48	2450
16	2418	52	2454
20	2422	56	2458
24	2426	60	2462
28	2430	64	2466
32	2434	68	2470
36	2438	72	2474

3.2.1 Test Mode Applicability and Tested Channel Detail

EUT CONFIGURE MODE	APPLICABLE TO				DESCRIPTION
	RE \geq 1G	RE $<$ 1G	PLC	APCM	
-	√	√	√	√	-

Where **RE \geq 1G**: Radiated Emission above 1GHz **RE $<$ 1G**: Radiated Emission below 1GHz
PLC: Power Line Conducted Emission **APCM**: Antenna Port Conducted Measurement

Radiated Emission Test (Above 1GHz):

- Pre-Scan has been conducted to determine the worst-case mode from all possible combinations between available modulations, data rates and antenna ports (if EUT with antenna diversity architecture).
- Following channel(s) was (were) selected for the final test as listed below.

EUT CONFIGURE MODE	AVAILABLE CHANNEL	TESTED CHANNEL	MODULATION TECHNOLOGY	MODULATION TYPE
-	4 to 72	4, 36, 72	FHSS	GFSK

Radiated Emission Test (Below 1GHz):

- Pre-Scan has been conducted to determine the worst-case mode from all possible combinations between available modulations, data rates and antenna ports (if EUT with antenna diversity architecture).
- Following channel(s) was (were) selected for the final test as listed below.

EUT CONFIGURE MODE	AVAILABLE CHANNEL	TESTED CHANNEL	MODULATION TECHNOLOGY	MODULATION TYPE
-	4 to 72	4	FHSS	GFSK

Power Line Conducted Emission Test:

- Pre-Scan has been conducted to determine the worst-case mode from all possible combinations between available modulations, data rates and antenna ports (if EUT with antenna diversity architecture).
- Following channel(s) was (were) selected for the final test as listed below.

EUT CONFIGURE MODE	AVAILABLE CHANNEL	TESTED CHANNEL	MODULATION TECHNOLOGY	MODULATION TYPE
-	4 to 72	4	FHSS	GFSK

Antenna Port Conducted Measurement:

- This item includes all test value of each mode, but only includes spectrum plot of worst value of each mode.
- Pre-Scan has been conducted to determine the worst-case mode from all possible combinations between available modulations, data rates and antenna ports (if EUT with antenna diversity architecture).
- Following channel(s) was (were) selected for the final test as listed below.

EUT CONFIGURE MODE	AVAILABLE CHANNEL	TESTED CHANNEL	MODULATION TECHNOLOGY	MODULATION TYPE
-	4 to 72	4, 36, 72	FHSS	GFSK

Test Condition:

APPLICABLE TO	ENVIRONMENTAL CONDITIONS	INPUT POWER (System)	TESTED BY
RE\geq1G	18deg. C, 74%RH	120Vac, 60Hz	Aaron You
RE$<$1G	18deg. C, 74%RH	120Vac, 60Hz	Aaron You
PLC	20deg. C, 78%RH	120Vac, 60Hz	Aaron You
APCM	25deg. C, 60%RH	120Vac, 60Hz	Saxon Lee

3.3 Description of Support Units

The EUT has been tested as an independent unit together with other necessary accessories or support units. The following support units or accessories were used to form a representative test configuration during the tests.

ID	Product	Brand	Model No.	Serial No.	FCC ID	Remarks
A.	Fixed Lens Classroom Camera	AVer	CC30	N/A	N/A	Supplied by client
B.	AC Adapter	APD	WB-10E05R	N/A	N/A	Supplied by client
C.	Wireless Microphone	AVer	V8F1M	N/A	N/A	Supplied by client
D.	NOTEBOOK COMPUTER	DELL	PP27L	8SNZ12S	FCC DoC Approved	Provided by Lab
E.	24" LCD MONITOR	DELL	U2410	CN082WXD728720C C0KCL	FCC DoC Approved	Provided by Lab
F.	SPEAKER	KINYO	KSP-25	S5-010106	N/A	Provided by Lab

Note: All power cords of the above support units are non-shielded (1.8m).

ID	Descriptions	Qty.	Length (m)	Shielding (Yes/No)	Cores (Qty.)	Remarks
1.	DC cable	1	3.0	N	0	Supplied by client
2.	USB cable	1	5.0	Y	0	Supplied by client
3.	HDMI cable	1	2.0	Y	0	Provided by Lab
4.	Audio cable	1	1.0	N	0	Provided by Lab

Note: The core(s) is(are) originally attached to the cable(s).

3.3.1 Configuration of System under Test

TEST CONFIGURATION <For PLC & RE<1G Tests>

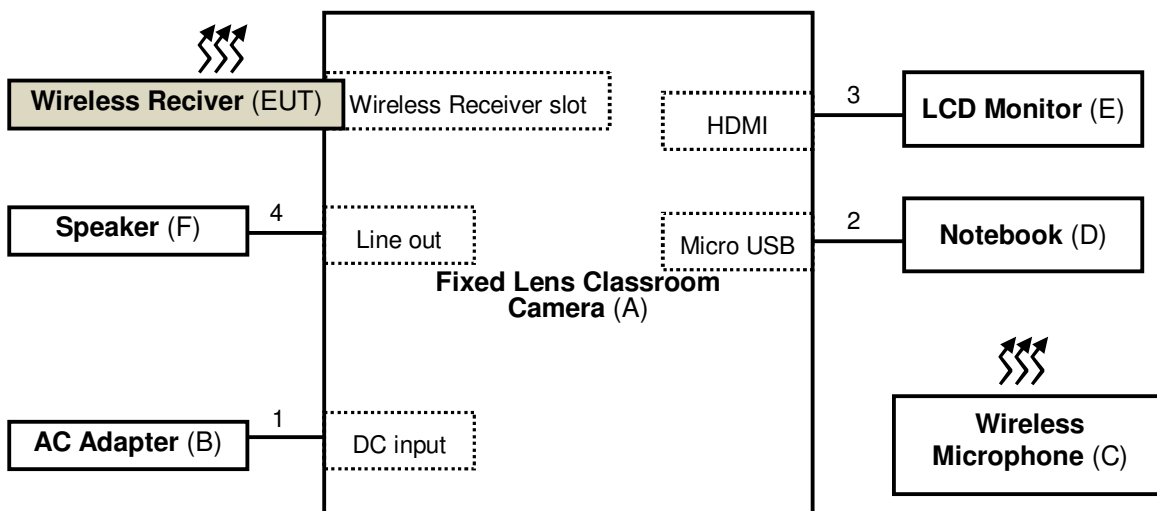

TEST CONFIGURATION <For RE≥1G Test>

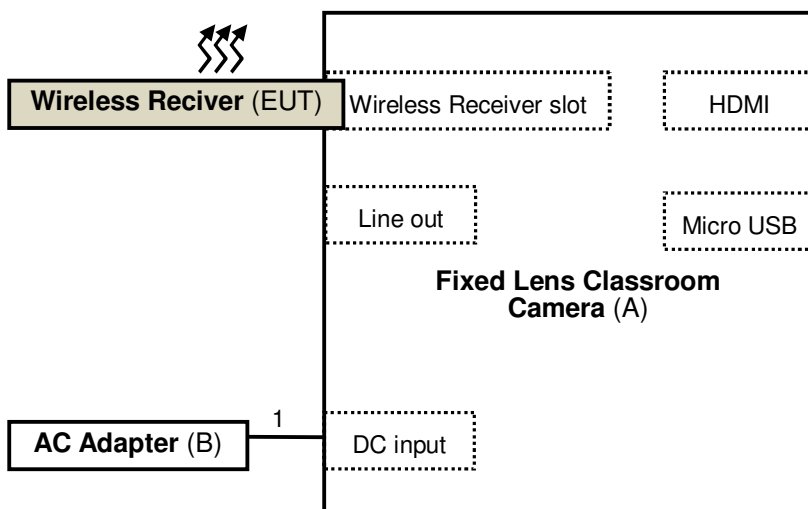

3.4 General Description of Applied Standards

The EUT is a RF Product. According to the specifications of the manufacturer, it must comply with the requirements of the following standards:

FCC Part 15, Subpart C (15.247)

ANSI C63.10-2013

All test items have been performed and recorded as per the above standards.

4 Test Types and Results

4.1 Radiated Emission and Bandedge Measurement

4.1.1 Limits of Radiated Emission and Bandedge Measurement

Radiated emissions which fall in the restricted bands must comply with the radiated emission limits specified as below table. Other emissions shall be at least 20dB below the highest level of the desired power:

Frequencies (MHz)	Field Strength (microvolts/meter)	Measurement Distance (meters)
0.009 ~ 0.490	2400/F(kHz)	300
0.490 ~ 1.705	24000/F(kHz)	30
1.705 ~ 30.0	30	30
30 ~ 88	100	3
88 ~ 216	150	3
216 ~ 960	200	3
Above 960	500	3

NOTE:

1. The lower limit shall apply at the transition frequencies.
2. Emission level (dBuV/m) = 20 log Emission level (uV/m).
3. For frequencies above 1000MHz, the field strength limits are based on average detector, however, the peak field strength of any emission shall not exceed the maximum permitted average limits, specified above by more than 20dB under any condition of modulation.



4.1.2 Test Instruments

DESCRIPTION & MANUFACTURER	MODEL NO.	SERIAL NO.	CALIBRATED DATE	CALIBRATED UNTIL
HP Preamplifier	8447D	2432A03504	Feb. 26, 2015	Feb. 25, 2016
HP Preamplifier	8449B	3008A01201	Feb. 26, 2015	Feb. 25, 2016
MITEQ Preamplifier	AMF-6F-260400-33-8P	892164	Mar. 01, 2015	Feb. 28, 2016
Agilent TEST RECEIVER	N9038A	MY51210129	Jan. 20, 2015	Jan. 19, 2016
Schwarzbeck Antenna	VULB 9168	139	Feb. 04, 2015	Feb. 03, 2016
Schwarzbeck Antenna	VHBA 9123	480	May 29, 2015	May 28, 2017
Schwarzbeck Horn Antenna	BBHA-9170	212	Feb. 09, 2015	Feb. 08, 2016
Schwarzbeck Horn Antenna	BBHA 9120-D1	D130	Feb. 10, 2015	Feb. 09, 2016
ADT. Turn Table	TT100	0306	NA	NA
ADT. Tower	AT100	0306	NA	NA
Software	Radiated_V7.6.15.9.4	NA	NA	NA
SUHNER RF cable With 4dB PAD	SF104	CABLE-CH6	Aug. 15, 2015	Aug. 14, 2016
SUHNER RF cable With 3dB PAD	SF102	Cable-CH8-3.6m	Aug. 15, 2015	Aug. 14, 2016
KEYSIGHT MIMO Powermeasurement Test set	U2021XA	U2021XA-001	May 04, 2015	May 03, 2016
KEYSIGHT Spectrum Analyzer	N9030A	MY54490260	Jul. 14, 2015	Jul. 13, 2016
EMCO Horn Antenna	3115	00028257	Feb. 05, 2015	Feb. 04, 2016
Highpass filter Wainwright Instruments	WHK 3.1/18G-10SS	SN 8	NA	NA
ROHDE & SCHWARZ Spectrum Analyzer	FSV40	101042	Sep. 23, 2015	Sep. 22, 2016
Anritsu Power Sensor	MA2411B	0738404	Apr. 21, 2015	Apr. 20, 2016
Anritsu Power Meter	ML2495A	0842014	Apr. 21, 2015	Apr. 20, 2016

- NOTE:** 1. The calibration interval of the above test instruments is 12/24 months. And the calibrations are traceable to NML/ROC and NIST/USA.
2. The horn antenna and HP preamplifier (model: 8449B) are used only for the measurement of emission frequency above 1GHz if tested.
3. The test was performed in Chamber No. 6.
4. The Industry Canada Reference No. IC 7450E-6.
5. The FCC Site Registration No. is 447212.

4.1.3 Test Procedures

- a. The EUT was placed on the top of a rotating table 0.8 meters (for below 1GHz) / 1.5 meters (for above 1GHz) above the ground at 3 meter chamber room for test. The table was rotated 360 degrees to determine the position of the highest radiation.
- b. The EUT was set 3 meters away from the interference-receiving antenna, which was mounted on the top of a variable-height antenna tower.
- c. The height of antenna is varied from one meter to four meters above the ground to determine the maximum value of the field strength. Both horizontal and vertical polarizations of the antenna are set to make the measurement.
- d. For each suspected emission, the EUT was arranged to its worst case and then the antenna was tuned to heights from 1 meter to 4 meters and the rotatable table was turned from 0 degrees to 360 degrees to find the maximum reading.
- e. The test-receiver system was set to quasi-peak detect function and specified bandwidth with maximum hold mode when the test frequency is below 1 GHz.
- f. The test-receiver system was set to peak detect function and specified bandwidth with maximum hold mode when the test frequency is above 1 GHz.

Note:

1. The resolution bandwidth and video bandwidth of test receiver/spectrum analyzer is 120kHz for Quasi-peak detection (QP) at frequency below 1GHz.
2. The resolution bandwidth of test receiver/spectrum analyzer is 1 MHz and the video bandwidth is 3 MHz for Peak detection (PK) at frequency above 1GHz.
3. All modes of operation were investigated and the worst-case emissions are reported.

4.1.4 Deviation from Test Standard

No deviation.

4.1.5 Test Set Up

<Frequency Range below 1GHz>

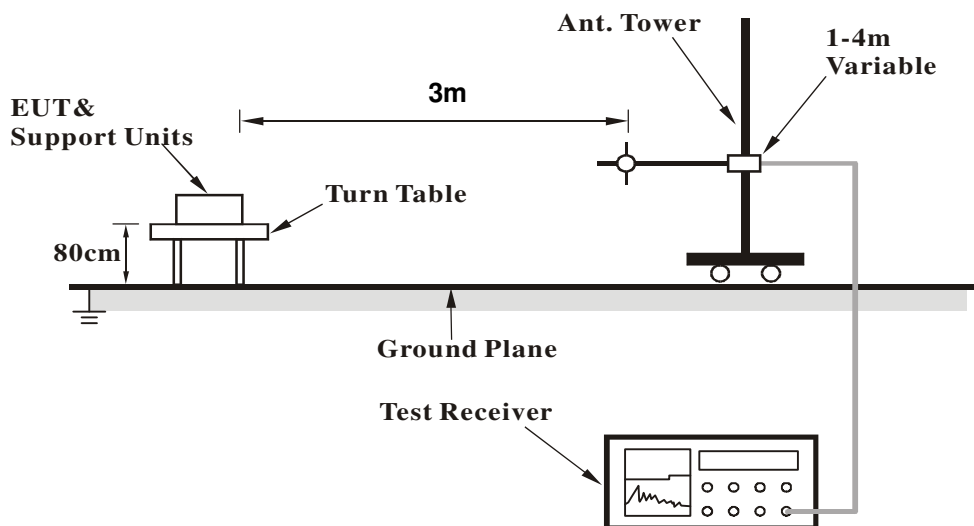

<Frequency Range above 1GHz>

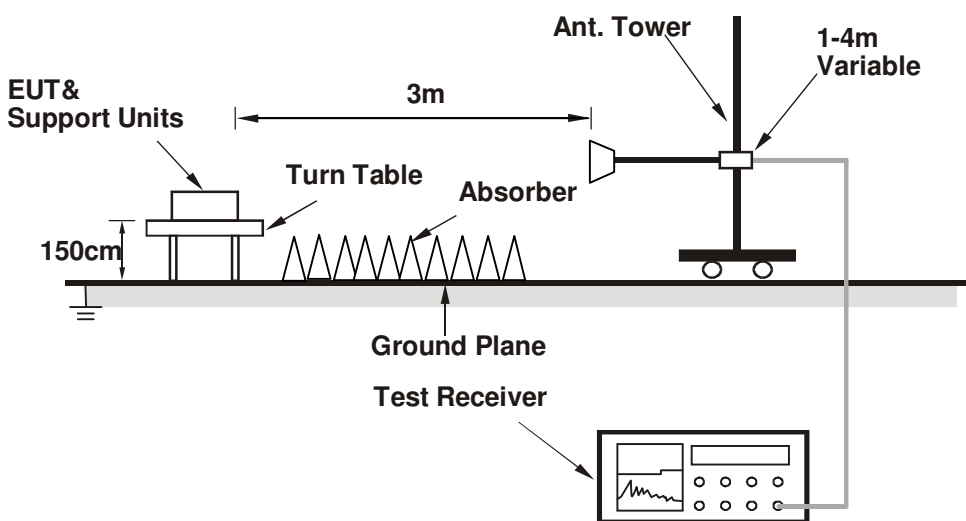

For the actual test configuration, please refer to the attached file (Test Setup Photo).

4.1.6 EUT Operating Conditions

Set the EUT under transmission condition continuously at specific channel frequency.

4.1.7 Test Results

BELOW 1GHz WORST-CASE DATA

CHANNEL	TX Channel 4	DETECTOR FUNCTION	Quasi-Peak (QP)
FREQUENCY RANGE	30MHz ~ 1GHz		

ANTENNA POLARITY & TEST DISTANCE: HORIZONTAL AT 3 M								
NO.	FREQ. (MHz)	EMISSION LEVEL (dBuV/m)	LIMIT (dBuV/m)	MARGIN (dB)	ANTENNA HEIGHT (m)	TABLE ANGLE (Degree)	RAW VALUE (dBuV)	CORRECTION FACTOR (dB/m)
1	75.64	28.5 QP	40.0	-11.5	4.00 H	206	40.33	-11.85
2	107.26	23.5 QP	43.5	-20.1	4.00 H	202	35.78	-12.33
3	159.40	25.0 QP	43.5	-18.5	3.81 H	194	33.48	-8.45
4	768.02	35.8 QP	46.0	-10.3	1.55 H	236	33.50	2.25
5	879.57	33.3 QP	46.0	-12.7	1.00 H	262	29.61	3.65
6	976.67	34.4 QP	54.0	-19.6	1.00 H	320	28.51	5.91

ANTENNA POLARITY & TEST DISTANCE: VERTICAL AT 3 M								
NO.	FREQ. (MHz)	EMISSION LEVEL (dBuV/m)	LIMIT (dBuV/m)	MARGIN (dB)	ANTENNA HEIGHT (m)	TABLE ANGLE (Degree)	RAW VALUE (dBuV)	CORRECTION FACTOR (dB/m)
1	32.23	35.9 QP	40.0	-4.1	1.53 V	144	46.60	-10.68
2	75.15	33.8 QP	40.0	-6.2	1.08 V	318	45.54	-11.74
3	106.05	26.4 QP	43.5	-17.1	1.00 V	39	38.78	-12.40
4	552.01	32.7 QP	46.0	-13.4	2.24 V	37	34.25	-1.60
5	768.02	36.0 QP	46.0	-10.0	2.89 V	272	33.75	2.25
6	884.76	35.1 QP	46.0	-10.9	2.37 V	240	31.47	3.62

REMARKS:

1. Emission Level(dBuV/m) = Raw Value(dBuV) + Correction Factor(dB/m)
2. Correction Factor(dB/m) = Antenna Factor(dB/m) + Cable Factor(dB) – Pre-Amplifier Factor(dB)
3. The other emission levels were very low against the limit.
4. Margin value = Emission Level – Limit value

ABOVE 1GHz DATA

CHANNEL	TX Channel 4	DETECTOR FUNCTION	Peak (PK)
FREQUENCY RANGE	1GHz ~ 25GHz		Average (AV)

ANTENNA POLARITY & TEST DISTANCE: HORIZONTAL AT 3 M

NO.	FREQ. (MHz)	EMISSION LEVEL (dBuV/m)	LIMIT (dBuV/m)	MARGIN (dB)	ANTENNA HEIGHT (m)	TABLE ANGLE (Degree)	RAW VALUE (dBuV)	CORRECTION FACTOR (dB/m)
1	2390.00	56.1 PK	74.0	-17.9	1.02 H	332	55.57	0.52
2	2390.00	42.0 AV	54.0	-12.0	1.02 H	332	41.46	0.52
3	*2406.00	97.5 PK			1.02 H	332	96.87	0.62
4	*2406.00	92.4 AV			1.02 H	332	91.73	0.62
5	4812.00	50.2 PK	74.0	-23.8	3.05 H	204	42.38	7.80
6	4812.00	36.5 AV	54.0	-17.5	3.05 H	204	28.73	7.80

ANTENNA POLARITY & TEST DISTANCE: VERTICAL AT 3 M

NO.	FREQ. (MHz)	EMISSION LEVEL (dBuV/m)	LIMIT (dBuV/m)	MARGIN (dB)	ANTENNA HEIGHT (m)	TABLE ANGLE (Degree)	RAW VALUE (dBuV)	CORRECTION FACTOR (dB/m)
1	2390.00	55.2 PK	74.0	-18.9	1.39 V	256	54.63	0.52
2	2390.00	41.3 AV	54.0	-12.7	1.39 V	256	40.82	0.52
3	*2406.00	91.9 PK			1.39 V	256	91.30	0.62
4	*2406.00	86.3 AV			1.39 V	256	85.69	0.62
5	4812.00	50.5 PK	74.0	-23.5	3.70 V	282	42.71	7.80
6	4812.00	37.1 AV	54.0	-16.9	3.70 V	282	29.27	7.80

REMARKS:

1. Emission Level(dBuV/m) = Raw Value(dBuV) + Correction Factor(dB/m)
2. Correction Factor(dB/m) = Antenna Factor(dB/m) + Cable Factor(dB) – Pre-Amplifier Factor(dB)
3. The other emission levels were very low against the limit.
4. Margin value = Emission Level – Limit value
5. " * ": Fundamental frequency.

CHANNEL	TX Channel 36	DETECTOR FUNCTION	Peak (PK)
FREQUENCY RANGE	1GHz ~ 25GHz		Average (AV)

ANTENNA POLARITY & TEST DISTANCE: HORIZONTAL AT 3 M

NO.	FREQ. (MHz)	EMISSION LEVEL (dBuV/m)	LIMIT (dBuV/m)	MARGIN (dB)	ANTENNA HEIGHT (m)	TABLE ANGLE (Degree)	RAW VALUE (dBuV)	CORRECTION FACTOR (dB/m)
1	*2438.00	97.1 PK			1.00 H	333	96.29	0.77
2	*2438.00	91.5 AV			1.00 H	333	90.75	0.77
3	4876.00	50.0 PK	74.0	-24.0	2.97 H	210	42.10	7.93
4	4876.00	36.7 AV	54.0	-17.3	2.97 H	210	28.73	7.93

ANTENNA POLARITY & TEST DISTANCE: VERTICAL AT 3 M

NO.	FREQ. (MHz)	EMISSION LEVEL (dBuV/m)	LIMIT (dBuV/m)	MARGIN (dB)	ANTENNA HEIGHT (m)	TABLE ANGLE (Degree)	RAW VALUE (dBuV)	CORRECTION FACTOR (dB/m)
1	*2438.00	93.4 PK			1.04 V	254	92.61	0.77
2	*2438.00	87.7 AV			1.04 V	254	86.91	0.77
3	4876.00	50.8 PK	74.0	-23.2	3.62 V	278	42.89	7.93
4	4876.00	37.0 AV	54.0	-17.0	3.62 V	278	29.11	7.93

REMARKS:

1. Emission Level(dBuV/m) = Raw Value(dBuV) + Correction Factor(dB/m)
2. Correction Factor(dB/m) = Antenna Factor(dB/m) + Cable Factor(dB) – Pre-Amplifier Factor(dB)
3. The other emission levels were very low against the limit.
4. Margin value = Emission Level – Limit value
5. " * ": Fundamental frequency.

CHANNEL	TX Channel 72	DETECTOR FUNCTION	Peak (PK)
FREQUENCY RANGE	1GHz ~ 25GHz		Average (AV)

ANTENNA POLARITY & TEST DISTANCE: HORIZONTAL AT 3 M								
NO.	FREQ. (MHz)	EMISSION LEVEL (dBuV/m)	LIMIT (dBuV/m)	MARGIN (dB)	ANTENNA HEIGHT (m)	TABLE ANGLE (Degree)	RAW VALUE (dBuV)	CORRECTION FACTOR (dB/m)
1	*2474.00	99.6 PK			1.42 H	344	98.63	0.93
2	*2474.00	93.0 AV			1.42 H	344	92.11	0.93
3	2483.50	56.5 PK	74.0	-17.5	1.42 H	344	55.49	0.98
4	2483.50	43.2 AV	54.0	-10.8	1.42 H	344	42.24	0.98
5	4948.00	50.3 PK	74.0	-23.7	3.00 H	208	42.09	8.17
6	4948.00	36.4 AV	54.0	-17.6	3.00 H	208	28.26	8.17
ANTENNA POLARITY & TEST DISTANCE: VERTICAL AT 3 M								
NO.	FREQ. (MHz)	EMISSION LEVEL (dBuV/m)	LIMIT (dBuV/m)	MARGIN (dB)	ANTENNA HEIGHT (m)	TABLE ANGLE (Degree)	RAW VALUE (dBuV)	CORRECTION FACTOR (dB/m)
1	*2474.00	96.7 PK			2.63 V	78	95.78	0.93
2	*2474.00	91.1 AV			2.63 V	78	90.18	0.93
3	2483.50	55.1 PK	74.0	-18.9	2.63 V	78	54.15	0.98
4	2483.50	42.5 AV	54.0	-11.5	2.63 V	78	41.50	0.98
5	4948.00	51.1 PK	74.0	-22.9	3.58 V	280	42.91	8.17
6	4948.00	37.7 AV	54.0	-16.3	3.58 V	280	29.55	8.17

REMARKS:

1. Emission Level(dBuV/m) = Raw Value(dBuV) + Correction Factor(dB/m)
2. Correction Factor(dB/m) = Antenna Factor(dB/m) + Cable Factor(dB) – Pre-Amplifier Factor(dB)
3. The other emission levels were very low against the limit.
4. Margin value = Emission Level – Limit value
5. " * ": Fundamental frequency.

4.2 Conducted Emission Measurement

4.2.1 Limits of Conducted Emission Measurement

Frequency (MHz)	Conducted Limit (dBuV)	
	Quasi-peak	Average
0.15 - 0.5	66 - 56	56 - 46
0.50 - 5.0	56	46
5.0 - 30.0	60	50

Note: 1. The lower limit shall apply at the transition frequencies.

2. The limit decreases in line with the logarithm of the frequency in the range of 0.15 to 0.50MHz.

4.2.2 Test Instruments

Description & Manufacturer	Model No.	Serial No.	Cal. Date	Cal. Due
ROHDE & SCHWARZ TEST RECEIVER	ESCS 30	100276	Apr. 01, 2015	Mar. 31, 2016
ROHDE & SCHWARZ Artificial Mains Network (for EUT)	ENV216	101197	Apr. 27, 2015	Apr. 26, 2016
LISN With Adapter (for EUT)	AD10	C10Ada-002	Apr. 27, 2015	Apr. 26, 2016
ROHDE & SCHWARZ Artificial Mains Network (for peripherals)	ESH3-Z5	100218	Nov. 25, 2015	Nov. 24, 2016
SCHWARZBECK Artificial Mains Network (For EUT)	NNLK8129	8129229	May 06, 2015	May 05, 2016
Software	Cond_V7.3.7	NA	NA	NA
RF cable (JYEBAO) With 10dB PAD	5D-FB	Cable-C10.01	Feb. 17, 2015	Feb. 16, 2016
SUHNER Terminator (For ROHDE & SCHWARZ LISN)	65BNC-5001	E1-011484	May 19, 2015	May 18, 2016
ROHDE & SCHWARZ Artificial Mains Network (For TV EUT)	ESH3-Z5	100220	Nov. 13, 2015	Nov. 12, 2016
LISN With Adapter (for TV EUT)	100220	N/A	Nov. 13, 2015	Nov. 12, 2016

Notes: 1. The calibration interval of the above test instruments is 12 months and the calibrations are traceable to NML/ROC and NIST/USA.

2. The test was performed in Shielded Room No. 10.

3. The VCCI Site Registration No. C-1852.

4.2.3 Test Procedures

- The EUT was placed 0.4 meters from the conducting wall of the shielded room with EUT being connected to the power mains through a line impedance stabilization network (LISN). Other support units were connected to the power mains through another LISN. The two LISNs provide 50 ohm/ 50uH of coupling impedance for the measuring instrument.
- Both lines of the power mains connected to the EUT were checked for maximum conducted interference.
- The frequency range from 150kHz to 30MHz was searched. Emission levels under (Limit - 20dB) was not recorded.

NOTE: The resolution bandwidth and video bandwidth of test receiver is 9kHz for quasi-peak detection (QP) and average detection (AV) at frequency 0.15MHz-30MHz.

4.2.4 Deviation From Test Standard

No deviation.

4.2.5 Test Setup

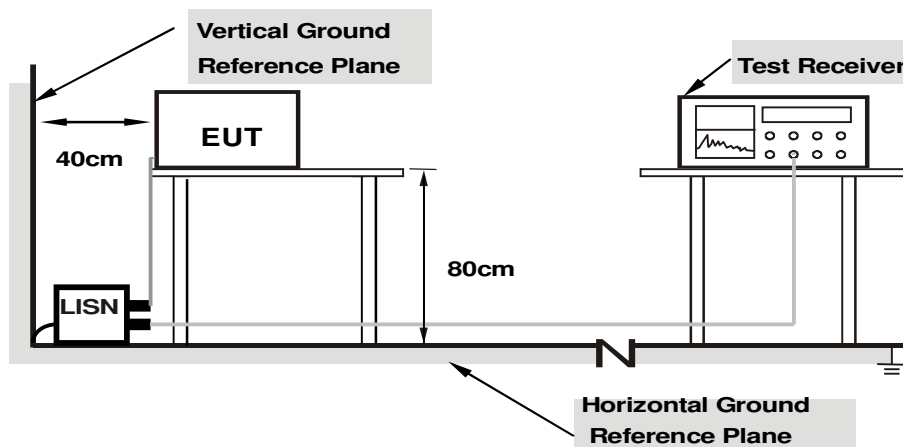

Note: 1.Support units were connected to second LISN.
 2.Both of LISNs (AMN) are 80 cm from EUT and at least 80 from other units and other metal planes

For the actual test configuration, please refer to the attached file (Test Setup Photo).

4.2.6 EUT Operating Condition

Same as item 4.1.6.

4.2.7 Test Results

Frequency Range	150kHz ~ 30MHz	Detector Function & Resolution Bandwidth	Quasi-Peak (QP) / Average (AV), 9kHz
------------------------	----------------	---	--------------------------------------

Phase Of Power : Line (L)										
No	Frequency (MHz)	Correction Factor (dB)	Reading Value (dBuV)		Emission Level (dBuV)		Limit (dBuV)		Margin (dB)	
			Q.P.	AV.	Q.P.	AV.	Q.P.	AV.	Q.P.	AV.
1	0.15391	9.67	33.09	19.31	42.76	28.98	65.79	55.79	-23.03	-26.81
2	0.20078	9.67	28.67	19.52	38.34	29.19	63.58	53.58	-25.24	-24.39
3	0.58359	9.68	17.96	10.13	27.64	19.81	56.00	46.00	-28.36	-26.19
4	1.76172	9.72	16.72	7.55	26.44	17.27	56.00	46.00	-29.56	-28.73
5	6.83203	9.82	16.59	9.49	26.41	19.31	60.00	50.00	-33.59	-30.69
6	17.14453	9.90	31.44	17.22	41.34	27.12	60.00	50.00	-18.66	-22.88

Remarks:

1. Q.P. and AV. are abbreviations of quasi-peak and average individually.
2. The emission levels of other frequencies were very low against the limit.
3. Margin value = Emission level – Limit value
4. Correction factor = Insertion loss + Cable loss
5. Emission Level = Correction Factor + Reading Value

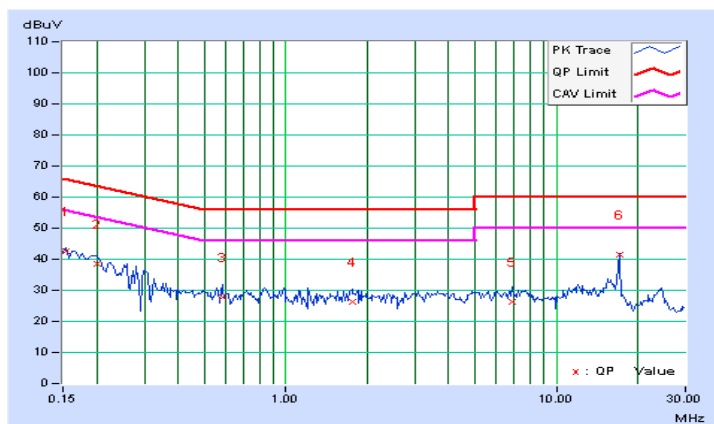

Frequency Range	150kHz ~ 30MHz	Detector Function & Resolution Bandwidth	Quasi-Peak (QP) / Average (AV), 9kHz
------------------------	----------------	---	--------------------------------------

Phase Of Power : Neutral (N)										
No	Frequency (MHz)	Correction Factor (dB)	Reading Value (dBuV)		Emission Level (dBuV)		Limit (dBuV)		Margin (dB)	
			Q.P.	AV.	Q.P.	AV.	Q.P.	AV.	Q.P.	AV.
1	0.15002	9.70	32.53	20.55	42.23	30.25	66.00	56.00	-23.77	-25.75
2	0.17734	9.71	30.41	18.93	40.12	28.64	64.61	54.61	-24.49	-25.97
3	0.98203	9.73	16.10	8.24	25.83	17.97	56.00	46.00	-30.17	-28.03
4	6.08984	9.84	17.39	9.09	27.23	18.93	60.00	50.00	-32.77	-31.07
5	11.96094	9.93	22.92	15.71	32.85	25.64	60.00	50.00	-27.15	-24.36
6	17.15846	9.98	32.02	24.00	42.00	33.98	60.00	50.00	-18.00	-16.02

Remarks:

1. Q.P. and AV. are abbreviations of quasi-peak and average individually.
2. The emission levels of other frequencies were very low against the limit.
3. Margin value = Emission level – Limit value
4. Correction factor = Insertion loss + Cable loss
5. Emission Level = Correction Factor + Reading Value

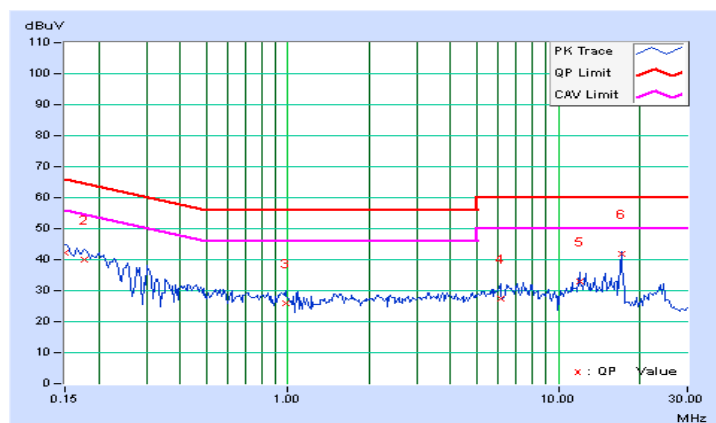

4.3 Number of Hopping Frequency Used

4.3.1 Limits of Hopping Frequency Used Measurement

At least 15 channels frequencies, and should be equally spaced.

4.3.2 Test Setup

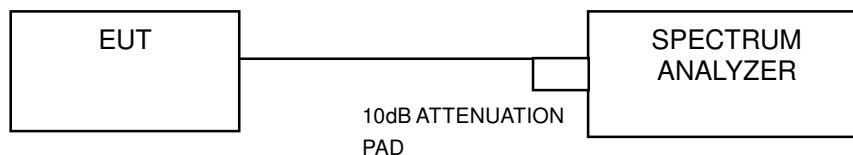

4.3.3 Test Instruments

Refer to section 4.1.2 to get information of above instrument.

4.3.4 Test Procedure

- a. Check the calibration of the measuring instrument (SA) using either an internal calibrator or a known signal from an external generator.
- b. Turn on the EUT and connect its antenna terminal to measurement via a low loss cable. Then set it to any one measured frequency within its operating range and make sure the instrument is operated in its linear range.
- c. Set the SA on MaxHold Mode, and then keep the EUT in hopping mode. Record all the signals from each channel until each one has been recorded.
- d. Set the SA on View mode and then plot the result on SA screen.
- e. Repeat above procedures until all frequencies measured were complete.

4.3.5 Deviation from Test Standard

No deviation.

4.3.6 Test Results

There are 18 hopping frequencies in the hopping mode. Please refer to next page for the test result. On the plots, it shows that the hopping frequencies are equally spaced.

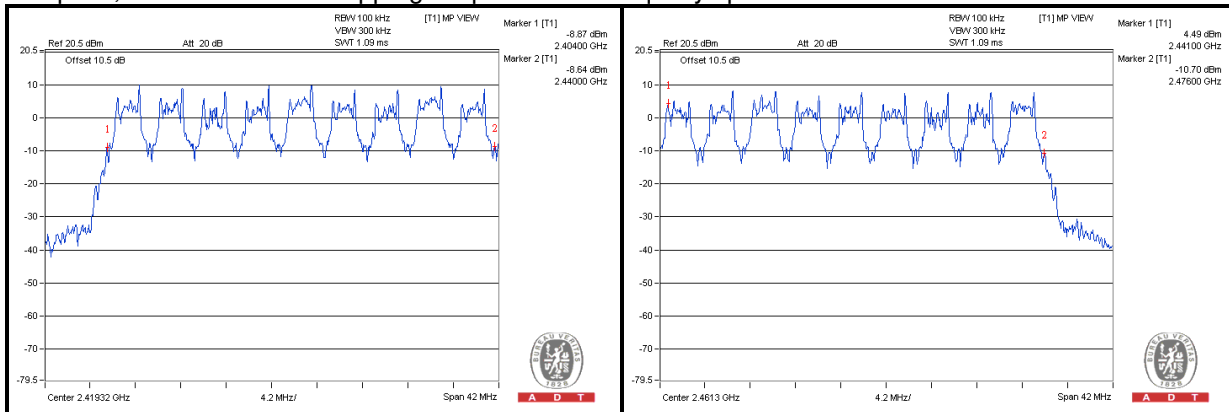

4.4 Dwell Time on Each Channel

4.4.1 Limits of Dwell Time on Each Channel Measurement

The average time of occupancy on any channel shall not be greater than 0.4 seconds within a period of 0.4 seconds multiplied by the number of hopping channels employed.

4.4.2 Test Setup

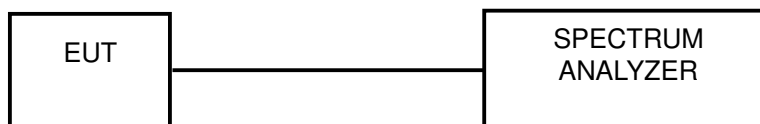

4.4.3 Test Instruments

Refer to section 4.1.2 to get information of above instrument.

4.4.4 Test Procedures

- a. Check the calibration of the measuring instrument (SA) using either an internal calibrator or a known signal from an external generator.
- b. Turn on the EUT and connect its antenna terminal to measurement via a low loss cable. Then set it to any one measured frequency within its operating range and make sure the instrument is operated in its linear range.
- c. Adjust the center frequency of SA on any frequency be measured and set SA to zero span mode. And then, set RBW and VBW of spectrum analyzer to proper value.
- d. Measure the time duration of one transmission on the measured frequency. And then plot the result with time difference of this time duration.
- e. Repeat above procedures until all different time-slot modes have been completed.

4.4.5 Deviation from Test Standard

No deviation.

4.4.6 Test Results

Number of transmission in a 7.2 (18Hopping*0.4)	Length of transmission time (msec)	Result (msec)	Limit (msec)
29 (times / 5 sec) * 1.44 = 41.76 times	0.2	8.352	400

NOTE: Test plots of the transmitting time slot are shown on as below.

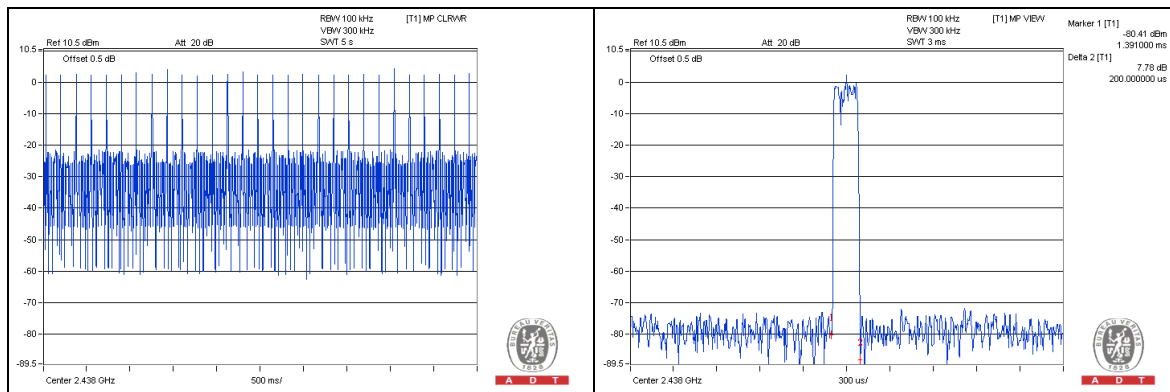

4.5 Channel Bandwidth

4.5.1 Limits of Channel Bandwidth Measurement

For frequency hopping system operating in the 2400-2483.5MHz, If the 20dB bandwidth of hopping channel is greater than 25kHz, two-thirds 20dB bandwidth of hopping channel shall be a minimum limit for the hopping channel separation.

4.5.2 Test Setup

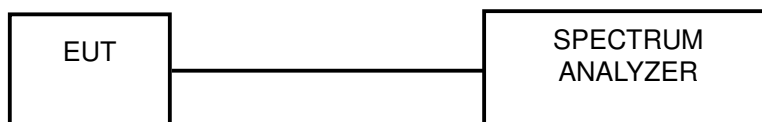

4.5.3 Test Instruments

Refer to section 4.1.2 to get information of above instrument.

4.5.4 Test Procedure

- Check the calibration of the measuring instrument using either an internal calibrator or a known signal from an external generator.
- Turn on the EUT and connect it to measurement instrument. Then set it to any one convenient frequency within its operating range. Set a reference level on the measuring instrument equal to the highest peak value.
- Measure the frequency difference of two frequencies that were attenuated 20dB from the reference level. Record the frequency difference as the emission bandwidth.
- Repeat above procedures until all frequencies measured were complete.

4.5.5 Deviation from Test Standard

No deviation.

4.5.6 EUT Operating Condition

The software provided by client enabled the EUT to transmit and receive data at lowest, middle and highest channel frequencies individually.

4.5.7 Test Results

Channel	Frequency (MHz)	20dB Bandwidth (MHz)
4	2406	4.25
36	2438	4.25
72	2474	4.13

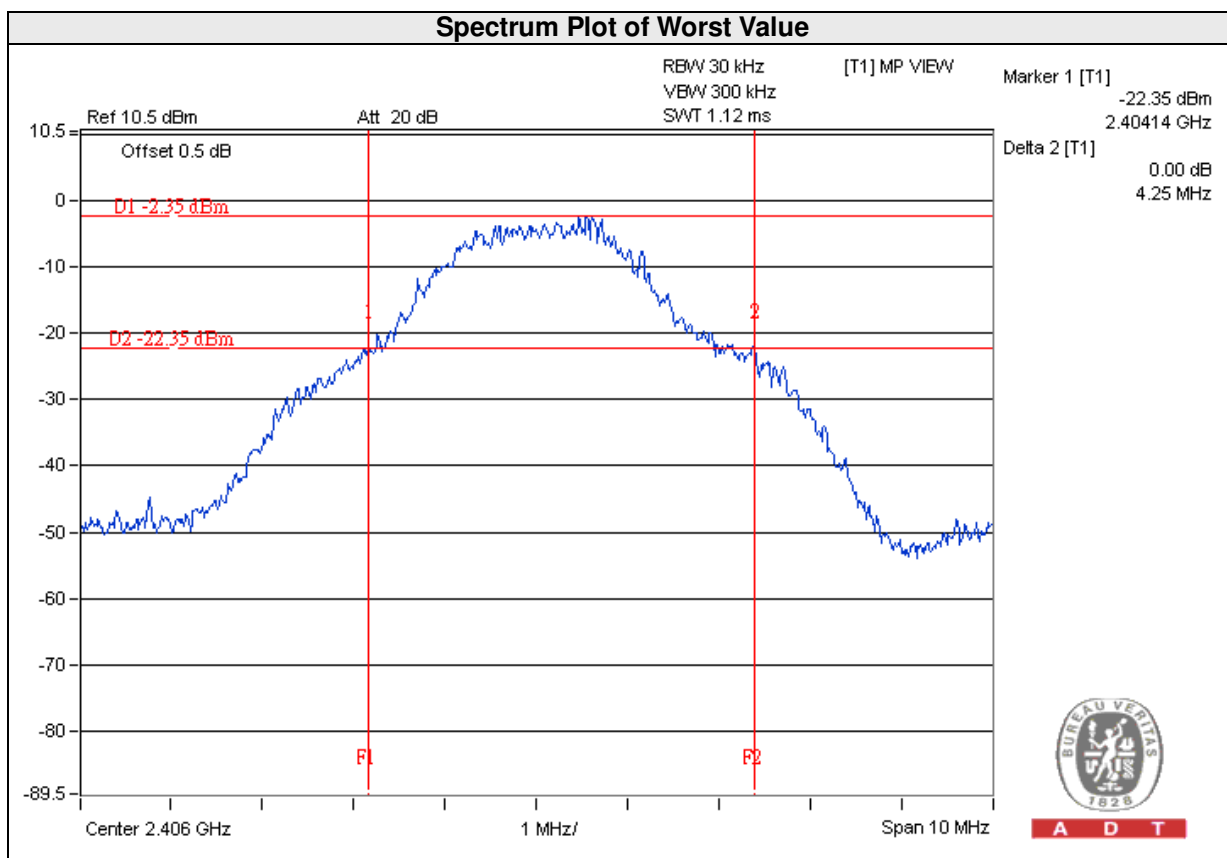

4.6 Hopping Channel Separation

4.6.1 Limits of Hopping Channel Separation Measurement

At least 25kHz or two-third of 20dB hopping channel bandwidth (whichever is greater).

4.6.2 Test Setup

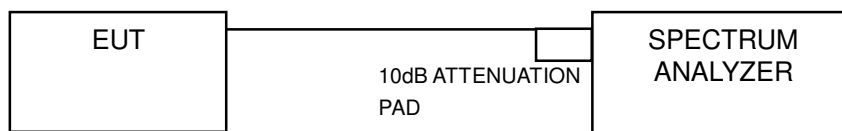

4.6.3 Test Instruments

Refer to section 4.1.2 to get information of above instrument.

4.6.4 Test Procedure

Measurement Procedure REF

- a. Check the calibration of the measuring instrument using either an internal calibrator or a known signal from an external generator.
- b. Turn on the EUT and connect it to measurement instrument. Then set it to any one convenient frequency within its operating range.
- c. By using the MaxHold function record the separation of two adjacent channels.
- d. Measure the frequency difference of these two adjacent channels by SA MARK function. And then plot the result on SA screen.
- e. Repeat above procedures until all frequencies measured were complete.

4.6.5 Deviation From Test Standard

No deviation.

4.6.6 Test Results

Channel	Frequency (MHz)	Adjacent Channel Separation (MHz)	20dB Bandwidth (MHz)	Minimum Limit (MHz)	Pass / Fail
4	2406	4.00	4.25	2.83	Pass
36	2438	4.01	4.25	2.83	Pass
72	2474	4.00	4.13	2.75	Pass

NOTE: The minimum limit is two-third 20dB bandwidth.

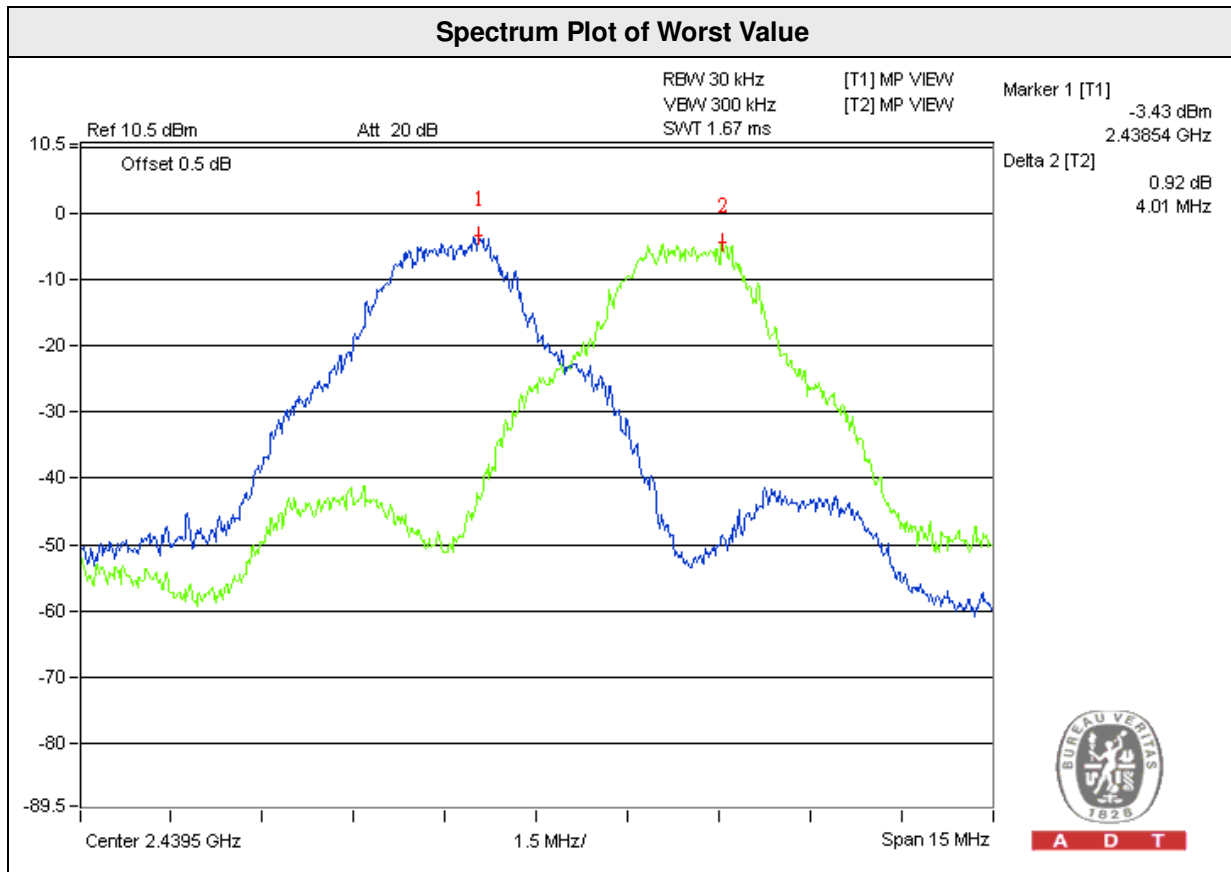

4.7 Maximum Output Power

4.7.1 Limits of Maximum Output Power Measurement

The Maximum Output Power Measurement is 125mW.

4.7.2 Test Setup

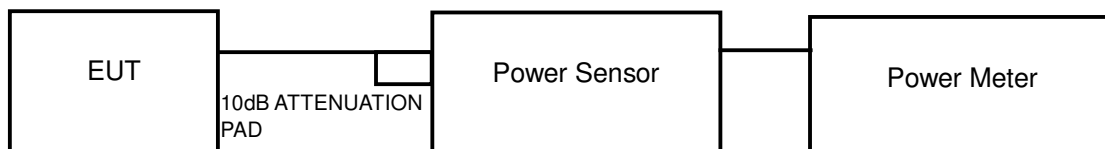

4.7.3 Test Instruments

Refer to section 4.1.2 to get information of above instrument.

4.7.4 Test Procedure

A peak / average power sensor was used on the output port of the EUT. A power meter was used to read the response of the peak / average power sensor. Record the peak power level.

4.7.5 Deviation from Test Standard

No deviation.

4.7.6 EUT Operating Condition

The software provided by client enabled the EUT to transmit and receive data at lowest, middle and highest channel frequencies individually.

4.7.7 Test Results

Channel	Frequency (MHZ)	Output Power (mW)	Output Power (dBm)	Power Limit (mW)	Pass / Fail
4	2406	4.436	6.47	125	Pass
36	2438	3.664	5.64	125	Pass
72	2474	3.062	4.86	125	Pass

4.8 Conducted Out of Band Emission Measurement

4.8.1 Limits Of Conducted Out Of Band Emission Measurement

Below -20dB of the highest emission level of operating band (in 100kHz RBW).

4.8.2 Test Instruments

Refer to section 4.1.2 to get information of above instrument.

4.8.3 Test Procedure

The transmitter output was connected to the spectrum analyzer via a low loss cable. Set both RBW and VBW of spectrum analyzer to 100 kHz and 300 kHz with suitable frequency span including 100 MHz bandwidth from band edge. The band edges was measured and recorded.

4.8.4 Deviation From Test Standard

No deviation.

4.8.5 Eut Operating Condition

The software provided by client enabled the EUT to transmit and receive data at lowest, middle and highest channel frequencies individually.

4.8.6 Test Results

The spectrum plots are attached on the following images. D1 line indicates the highest level, D2 line indicates the 20dB offset below D1. It shows compliance with the requirement.

Hopping disabled_Low Channel

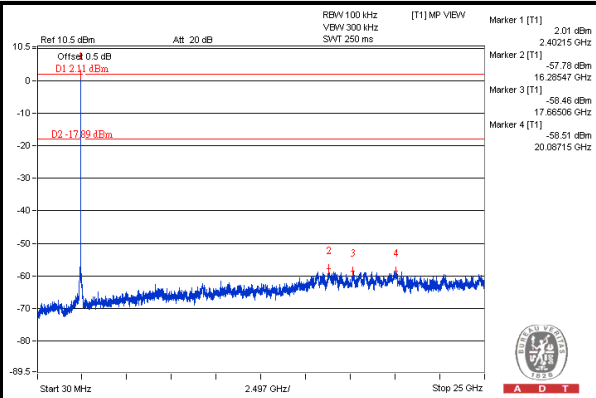
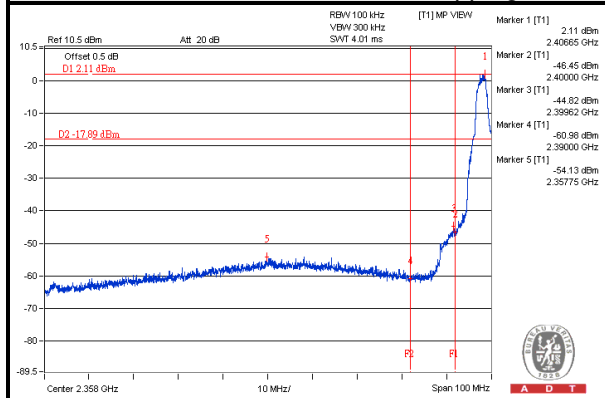

Hopping disabled_High Channel

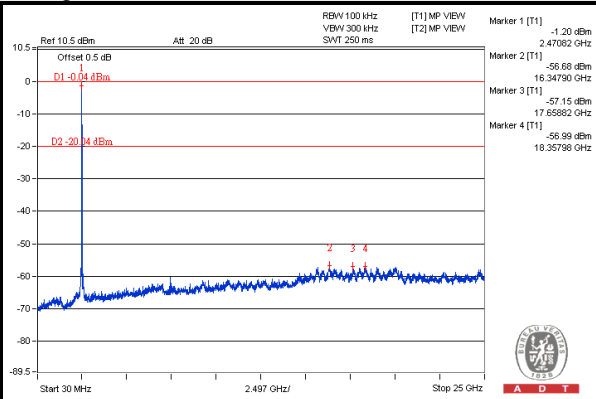
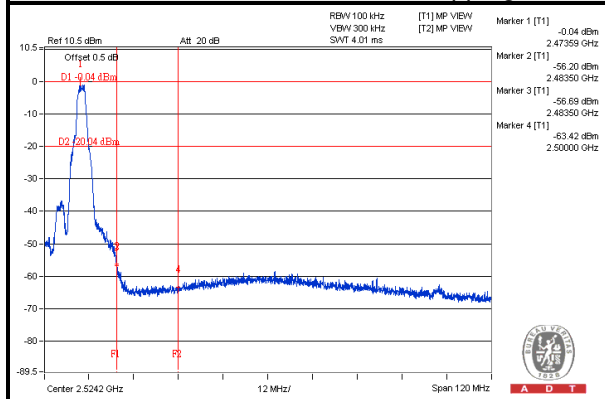

Hopping enabled_Low Channel

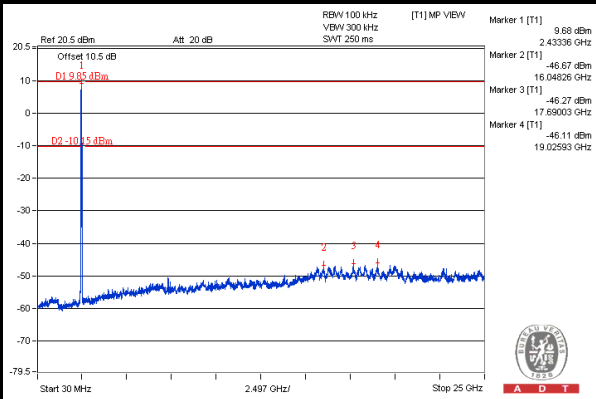
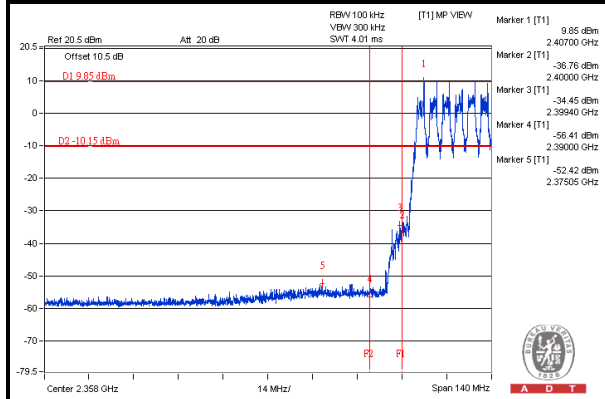

Hopping enabled_High Channel

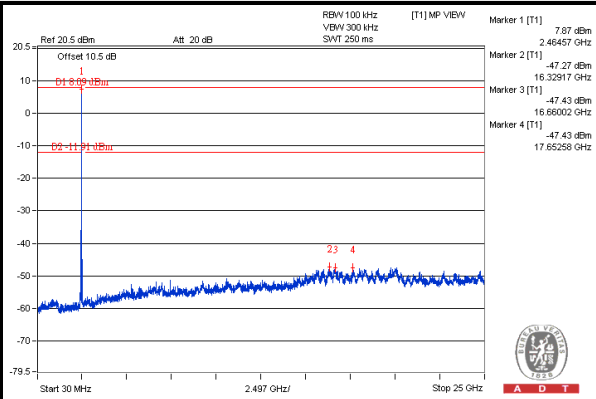
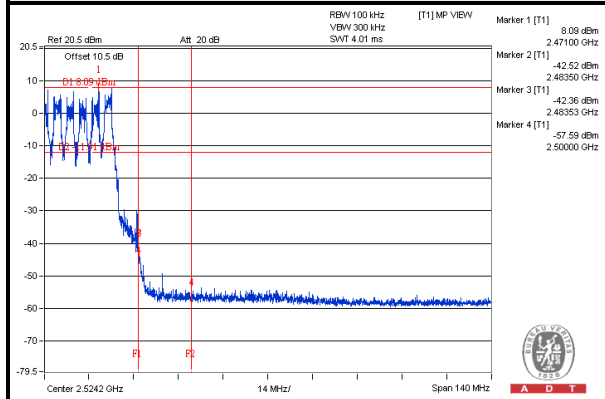

5 Pictures of Test Arrangements

Please refer to the attached file (Test Setup Photo).



Appendix – Information on the Testing Laboratories

We, Bureau Veritas Consumer Products Services (H.K.) Ltd., Taoyuan Branch, were founded in 1988 to provide our best service in EMC, Radio, Telecom and Safety consultation. Our laboratories are accredited and approved according to ISO/IEC 17025.

If you have any comments, please feel free to contact us at the following:

Linko EMC/RF Lab

Tel: 886-2-26052180

Fax: 886-2-26051924

Hsin Chu EMC/RF/Telecom Lab

Tel: 886-3-6668565

Fax: 886-3-6668323

Hwa Ya EMC/RF/Safety

Tel: 886-3-3183232

Fax: 886-3-3270892

Email: service.adt@tw.bureauveritas.com

Web Site: www.bureauveritas-adt.com

The address and road map of all our labs can be found in our web site also.

--- END ---