

**Akuvox** Smart  
Intercom



## **R48G(433) Android Video Phone User Manual**

## About this manual

Thank you for choosing Akuvox's R48G(433) Android Video Phone. This manual is intended for end users, who need to use and configure the door phone. It provides an overview of the most essential functions and features of the product.

## Contact us

For more information about the product, please visit us at [www.akuvox.com](http://www.akuvox.com) or feel free to contact us by

Sales email: [sales@akuvox.com](mailto:sales@akuvox.com)

Technical support email: [techsupport@akuvox.com](mailto:techsupport@akuvox.com)

Telephone: +86-592-2133061 ext.7694/8162

**We highly appreciate your feedback about our products**

 **FCC Caution:**

Any Changes or modifications not expressly approved by the party responsible for compliance could void the user's authority to operate the equipment. This device complies with part 15 of the FCC Rules. Operation is subject to the following two conditions: (1) This device may not cause harmful interference, and (2) this device must accept any interference received, including interference that may cause undesired operation.

**Note:** This equipment has been tested and found to comply with the limits for a Class B digital device, pursuant to part 15 of the FCC Rules. These limits are designed to provide reasonable protection against harmful interference in a residential installation. This equipment generates uses and can radiate radio frequency energy and, if not installed and used in accordance with the instructions, may cause harmful interference to radio communications. However, there is no guarantee that interference will not occur in a particular installation. If this equipment does cause harmful interference to radio or television reception, which can be determined by turning the equipment off and on, the user is encouraged to try to correct the interference by one or more of the following measures:

- Reorient or relocate the receiving antenna.
- Increase the separation between the equipment and receiver.
- Connect the equipment into an outlet on a circuit different from that to which the receiver is connected.
- Consult the dealer or an experienced radio/TV technician for help.

FCC Radiation Exposure Statement:

This equipment complies with FCC radiation exposure limits set forth for an uncontrolled environment .

This transmitter must not be co - located or operating in conjunction with any other antenna or transmitter.

This equipment should be installed and operated with minimum distance 20cm between the radiator &you body.

---

# Content

<b>1. Product Overview</b> .....	1
1.1. Instruction.....	1
1.2. Equipment Appearance And Interface Description.....	2
1.2.1. Interface Description.....	4
1.2.2. Keypad Description.....	5
1.3. Pendant.....	6
1.4. Indicator.....	7
1.4.1. Indicator of R48G(433).....	7
1.4.2. Indicator of Pendant.....	7
<b>2. Installation</b> .....	9
2.1. Equipment Packaging.....	9
2.2. Connecting Video Phone.....	10
2.3. Installation Considerations.....	12
<b>3. Daily Use</b> .....	13
3.1. Call.....	13
3.1.1. Make A Call.....	13

3.1.2. Dial Out Directly..... 14

3.1.3. Dialing Out From Contact List..... 15

3.1.4. Receive A Call..... 16

3.1.5. Call Options..... 17

3.1.6. Multiple Calls..... 19

3.1.7. RF Number..... 20

# 1. Product Overview

## 1.1. Instruction

VP-R48G(433) is an Android-based multimedia terminal with a 7 inch touch screen and a 1.3M CMOS sensor camera. It supports H.264/H.263 codecs with adaptive bandwidth adjustment. The 7 inch touch screen offers excellent user experiences such as high quality videophone, smooth internet surfing, various Android Apps and daily information.

VP-R48G(433) provides 2 Ethernet ports, 1USB, 1HDMI, and one 3.5mm headset/audio port.



## 1.2. Equipment Appearance And Interface Description

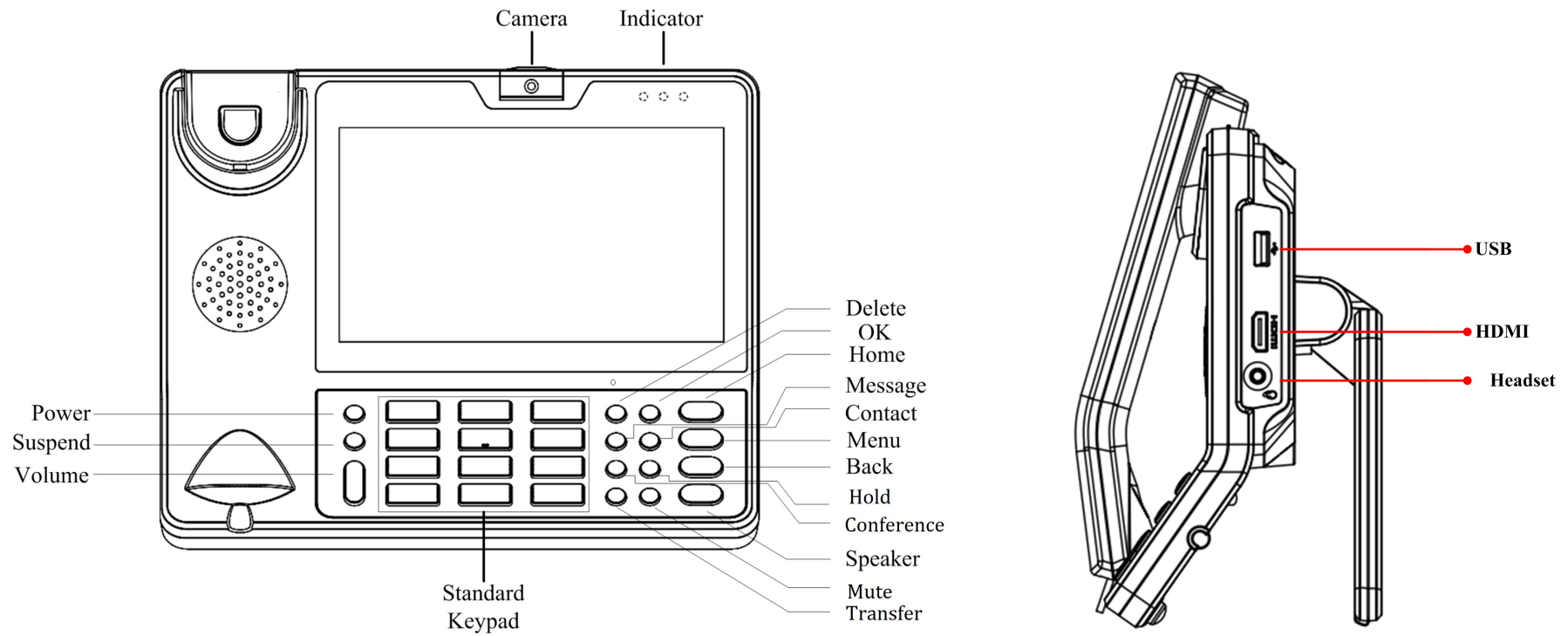



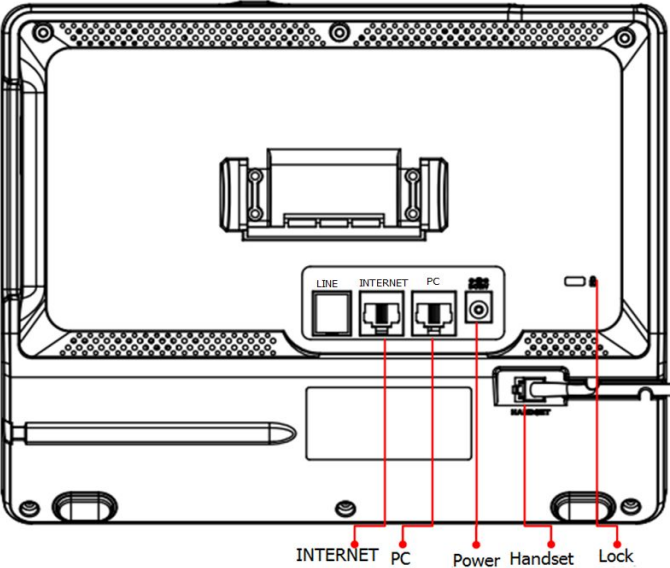





### 1.2.1. Interface Description

Interface	Description
Camera	Adjustable camera shooting angle, rotate down the camera to "off" angle.
USB interface	External USB storage device
Headset	Connect to 3.5mm stereo headphone, headset device
HDMI	Use HDMI cable to output the video to a TV screen
LAN	Network interface can be connected to a hub, switch or other network access devices. It also supports POE(Power over Ethernet) .
PC	Share the network access from LAN port, and for PC and other equipment connection
Power	Connect to 12V adapter, Power supply
Handset	Connect to handset
Lock	Lock the video phone with a Laptop lock

**Note:** If Power over Ethernet is being used, do not plug in the AC adapter.

## 1.2.2. Keypad Description

Interface	Description	
Power	Turn on/off the LCD, Reboot, Silent mode	
Suspend	Turn on/off the LCD, Reboot, Silent mode	
Volume	Press + or – for the phone volume adjustment	
Standard Keypad	Input the number or symbol	
Function Key	Delete	Delete a character before the cursor
	OK	Same function with soft keyboard "Enter" key
	Message	Optional
	Contact	Enter Into the contacts list, you can view the local contact
	Conferenc e	The first party is held in the case, according to a conference key, the first party can be combined to achieve a tripartite meeting
	Hold	To hold a call during the call



	Transfer	To transfer the current call to the third party
	Mute	The other party cannot heard the voice during the call
Home		Return to the main screen, and long press, it will display recently used applications
Menu		To call up the System or program setup menu
Back		Return to the previous menu
Speaker		Speaker

### 1.3. Pendant

R48G(433) pendant is used to call out the emergence number when you need help. However, users can choose whether the pendant is needed, based on your own needs.

## 1.4. Indicator

### 1.4.1. Indicator of R48G(433)

Indicator Name	Icon	Status	Description
Power		ON	System is under working
		OFF	System is not working
Network Connection		ON	Network (LAN Port) is connected
		OFF	Network (LAN Port) is disconnected
Information		Flashing	Contains Miss Calls or Unread Message
		OFF	Normal status

### 1.4.2. Indicator of Pendant

Indicator Status	Description	Notes
Flashing Yellow	The pendant is in low battery power status. The pendant powers on again.	User need to replace the battery.

<p>Alternate Flashing Green and Red</p>	<p>(1)The pendant in factory-test mode.</p>	<p>(1)If user long press the pendant button meanwhile install the battery, it will enter testing mode. User need to install the battery again and do not press the push button during the installation.</p>
<p>Flashing Red</p>	<p>Before the pendant matches with the phone, press pendant button. Press the pendant to make a call over 200 meters after it matched with the phone.</p>	<p>(1)User need to match the pendant with the phone. (2)The maximum distance between the matched phone with the pendant is about 200 meters. User need to use it in this range.</p>

Flashing Green	(1)In the process of the RF Learning. press the pendant button. The phone will prompt RF Key Learned.  (2)Press pendant button to make a call after it matched with the phone.	
Light off	The battery runs out of power. Idle status.	(1)User need to replace a new battery.

## 2. Installation

### 2.1. Equipment Packaging

Name	Quantity
Main Case	1
Handset	1

Phone Cord	1
Power Adapter	1
Ethernet Cable	1
Quick Start Guide	1

## 2.2. Connecting Video Phone

- **Connection diagram**



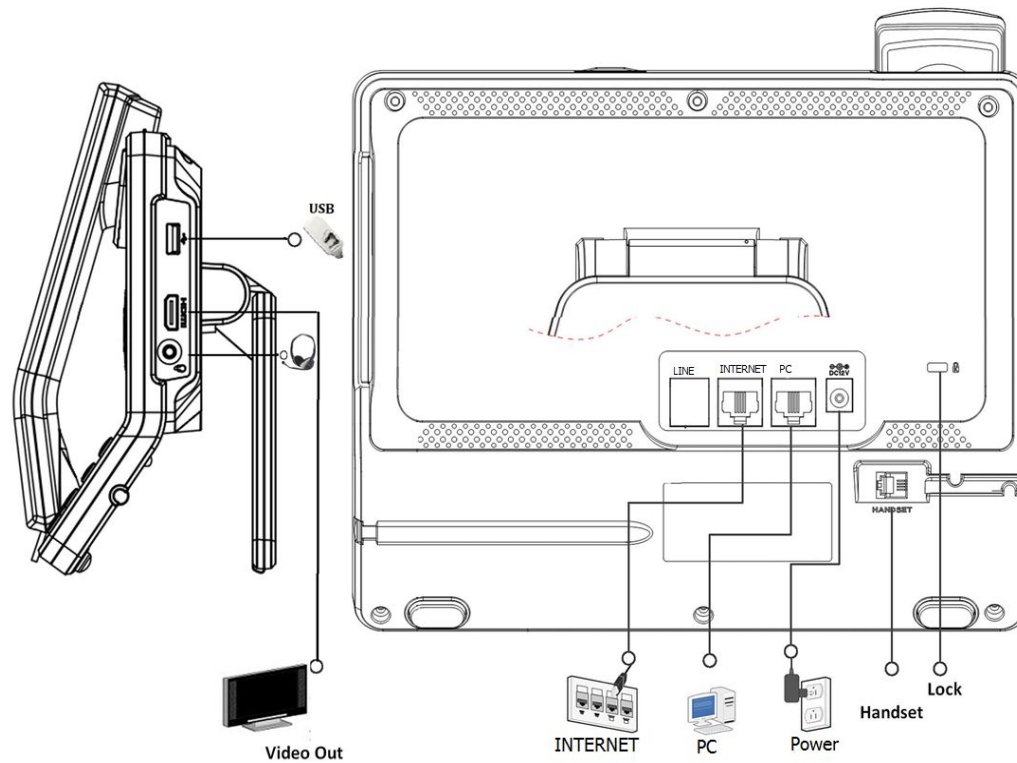

## ● Connecting to Network

Use the matched network cable to connect the LAN Port of the video phone to the Router or Switch. Viewing the top right corner of

the screen, if the indicator light  is on, network cable is connected properly.

- **Connecting to PC**

Use the matched network cable to connect the PC Port of the video phone to the PC. The PC can access to the internet network via PC Port of the video phone.

## **2.3. Installation Considerations**

This product is a desktop product, and here are some safety recommendations about the installation and the usage:

- Do not use this product near water, such as: bath, washbasin, kitchen sink and other damp places, and so on;
- Place the device in a place away from heat;
- Place the device away from traffic areas to prevent collisions;
- Please use the equipment with the matching power adapter or POE;

## 3. Daily Use

### 3.1. Call



#### 3.1.1. Make A Call

Users can directly dial from the keypad, select from the contact list or from call records to call out the number. Users can choose one of the following steps to enter into the dialing interface.

Mode 1: Directly pick up the handset.

Mode 2: Press Speaker button on the keypad.

Mode 3: In the main screen, click icon .



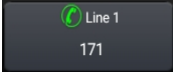

Mode 4: In the main screen, select icon  -> tap icon .

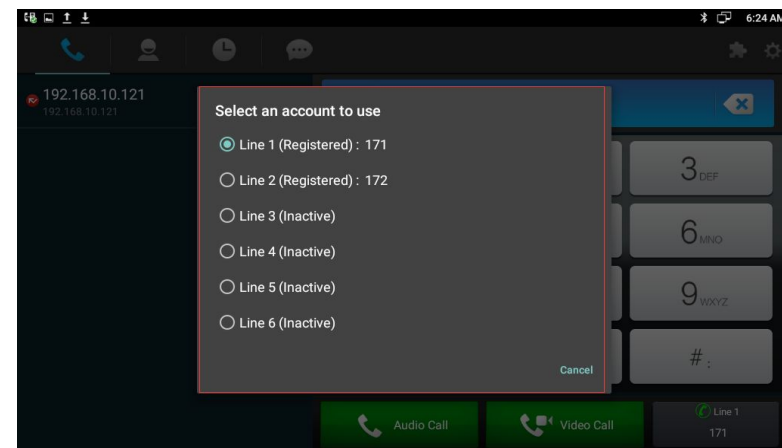
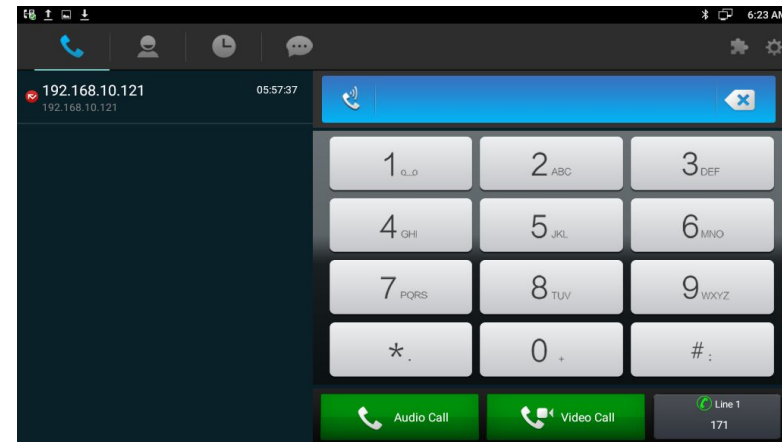
### 3.1.2. Dial Out Directly

- 1) By pressing the number keys on the dial interface or directly pressing the number on keypad. To delete a number, press the icon  on the dial interface, or press Delete button on the keypad.
- 2) If you want to make an audio call, click Audio Call label. If users want to make a video call, click Video Call label.
- 3) If multiple available SIP accounts are registered, when finishing dialing, users can click line  label to choose the outgoing account for the number, as shown below.



### 3.1.3. Dialing Out From Contact List

- 1) Tap icon  ->Click the icon  -> Label Phone Book->All Contacts.
- 2) Click  label to make an audio call, click  label to make a video call, or click  label to send the message.

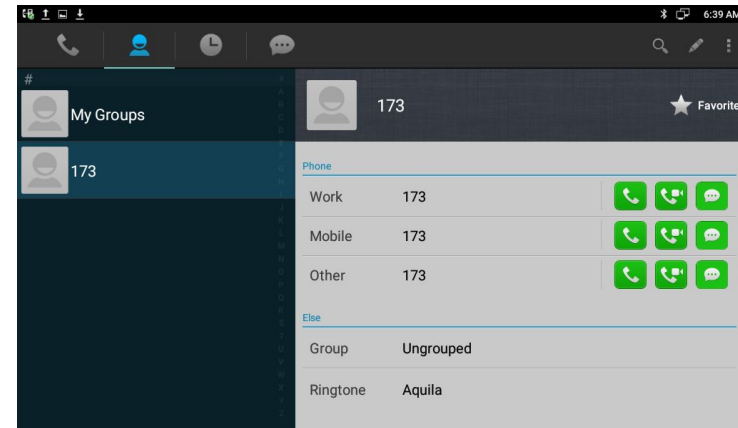

#### 3.1.3.1. Contacts Fuzzy Matching Query

Phone supports contacts fuzzy matching queried, intuitive, concise dialing interface for the intelligent input, greatly reducing the number of buttons, achieves rapid, effective positioning search, and avoids duplication of invalid operation, Tap search icon  to enter the search interface. Enter the key symbol or number to search the contact. The result will be displayed on the left list.

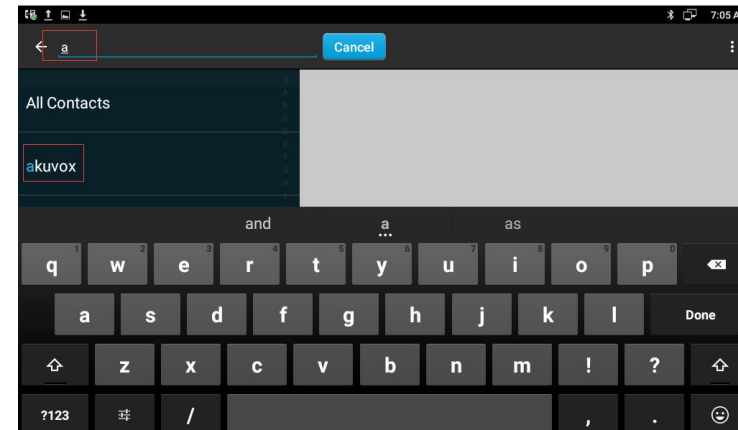

### 3.1.4. Receive A Call

Incoming calls include audio and video calls. If the caller has been stored in the contacts, it will show the contact name, otherwise the caller number will be displayed.

#### 3.1.4.1. Answer A Call

##### 1) Answer an audio call

When receiving an audio call, click Audio label or pick up the handset or press speaker button on the keypad to answer.

##### 2) Answer a video call

When receiving an video call, click Audio label to establish the audio call,click Video label to establish.

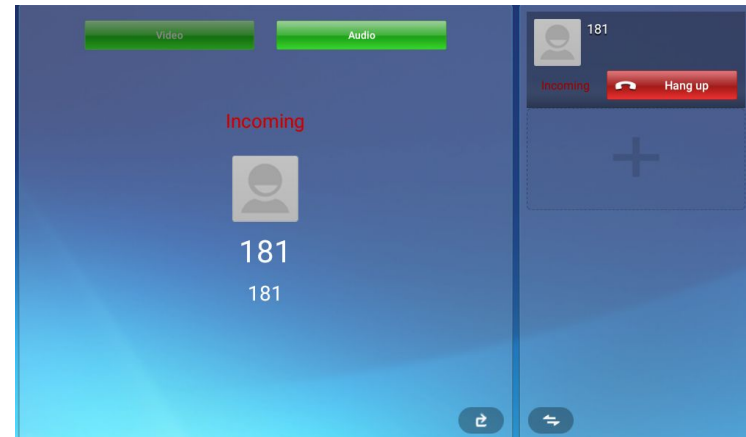

### 3.1.4.2. Reject A Call

If users want to reject a call, click  label in calling interface.

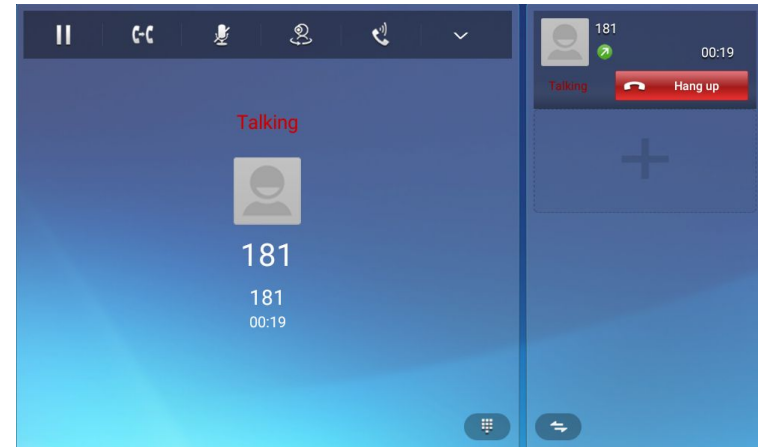

If users want to reject a call from a number, you can add the number to the blacklist.



### 3.1.5. Call Options

During the audio conversation

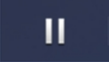
Call options are described as below.



**Hold:** Click the button  to hold the current call, press  to resume

**Transfer :** Click the button  to enter the establish transfer interface

**Mute:** Click the button  to mute,  to resume.

**Video call :** Click the button  to send a video request/close the video

**Answer mode:** to switch handset , handfree  or headset  mode

**Extend key :** Click the button  to open the extended icons,  to close.

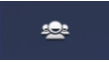
**Conference :** Click the button  to enter the establish conference interface

**Record :** Click the button  to start record,  to stops

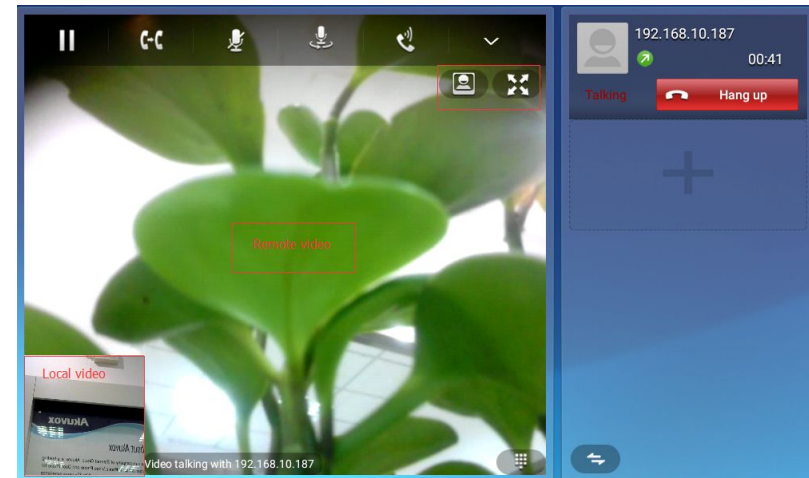



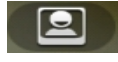

Video options are described as below.

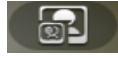
 : Support local and remote video displayed;

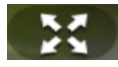
 : Support remote video displayed;

 : Click to open full screen/ exit full screen.

### 3.1.6. Multiple Calls

- The Phone supports more than 3 line calls. The line information is on the right side of call interface.
- During a call, users can click on the icon  to add a new call. And when click on this button, the current call will be hold.
- During a call, users can click on any line in the list to resume the call.

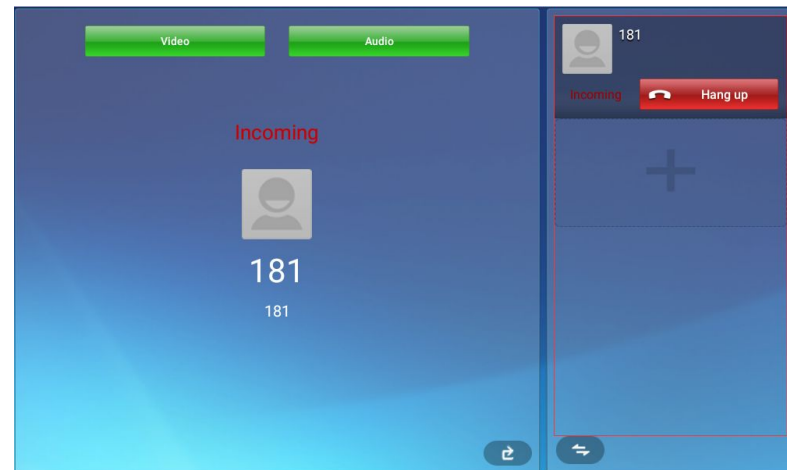

### 3.1.7. RF Number

This feature is specially designed for the elders. When the user needs help, he/she can press the pendant to dial out for emergency help.

#### Setup RF number:

- Go to the path: Phone Setting- RF Setting.
- Choose one RF KEY.
- Click Learn, and press the pendant at the same time.
- Then the RF KEY light will be green, it means learning successfully.
- Then click Edit to setup the RF number.
- Click Save.

