



FCC PART 15 B TEST REPORT

For

AKUVOX (XIAMEN) NETWORKS CO., LTD.

10/F, No. 56, Software Park II, Xiamen, China

FCC ID: 2AHCR-VPR48G

Report Type: Original Report	Product Name: Video Phone
Test Engineer: <i>Kevin Hu</i>	<i>Kevin hu</i>
Report Number: RXM161109054A	
Report Date: 2016-12-26	
Reviewed By: Henry Ding EMC Leader	<i>Henry Ding</i>
Test Laboratory: Bay Area Compliance Laboratories Corp. (Chengdu) 5040, HuiLongWan Plaza, No. 1, ShaWan Road, JinNiu District, ChengDu, China Tel: 028-65523123, Fax: 028-65525125 www.baclcorp.com	

Note: This test report was prepared for the customer shown above and for the device described herein. It may not be duplicated or used in part without prior written consent from Bay Area Compliance Laboratories Corp. (Chengdu). Any unauthorized alteration, forgery or falsification of the content or appearance of this document is unlawful and offenders may be prosecuted to the fullest extent of the law. This report was valid only with a valid digital signature.

TABLE OF CONTENTS

GENERAL INFORMATION	3
PRODUCT DESCRIPTION FOR EQUIPMENT UNDER TEST (EUT).....	3
OBJECTIVE	3
RELATED SUBMITTAL(S)/GRANT(S).....	3
TEST METHODOLOGY	4
TEST FACILITY.....	4
SYSTEM TEST CONFIGURATION.....	5
DESCRIPTION OF TEST CONFIGURATION	5
EUT EXERCISE SOFTWARE.....	5
EQUIPMENT MODIFICATIONS	5
LOCAL SUPPORT EQUIPMENT LIST AND DETAILS	5
SUPPORT CABLE LIST AND DETAILS.....	5
CONFIGURATION OF TEST SETUP.....	6
SUMMARY OF TEST RESULTS	7
FCC§15.107 - CONDUCTED EMISSIONS	8
MEASUREMENT UNCERTAINTY	8
EUT SETUP.....	8
EMI TEST RECEIVER SETUP	9
TEST EQUIPMENT LIST AND DETAILS	9
TEST PROCEDURE	9
CORRECTED AMPLITUDE & MARGIN CALCULATION	9
TEST DATA	10
FCC §15.109 - RADIATED SPURIOUS EMISSIONS	15
MEASUREMENT UNCERTAINTY	15
EUT SETUP.....	15
EMI TEST RECEIVER SETUP	16
TEST PROCEDURE	16
TEST EQUIPMENT LIST AND DETAILS	17
CORRECTED AMPLITUDE & MARGIN CALCULATION	17
TEST DATA	18

GENERAL INFORMATION

Product Description for Equipment Under Test (EUT)

The **AKUVOX (XIAMEN) NETWORKS CO., LTD.** 's product, model number: **VP-R48G (FCC ID: 2AHCR-VPR48G)** (the "EUT") in this report was a **Video Phone**, which was measured approximately: 24 cm (L) × 11 cm (W) × 19 cm (H), rated input voltage: DC12V from adapter or DC48V from POE adapter. The highest operation frequency is 2462 MHz.

Adapter information:

MODEL: RD1201000-C55-26MG

INPUT: AC 100-240V , 50/60Hz ,0.6A

OUTPUT: DC 12V, 1A

**All measurement and test data in this report was gathered from final production sample, serial number: 161109054 (assigned by the BAACL, Chengdu). It may have deviation from any other sample. The EUT supplied by the applicant was received on 2016-11-11, and EUT conformed to test requirement.*

Objective

This test report is prepared on behalf of **AKUVOX (XIAMEN) NETWORKS CO., LTD.** in accordance with Part 2, Subpart J, and Part 15-Subparts A and B of the Federal Communications Commission's rules.

The objective of the manufacturer is to determine the compliance of EUT with FCC Part 15 B Class B.

Related Submittal(s)/Grant(s)

FCC Part 15C DTS submissions with FCC ID: 2AHCR-VPR48G.

FCC Part 15C DSS submissions with FCC ID: 2AHCR-VPR48G.

Test Methodology

All measurements contained in this report were conducted with ANSI C63.4-2014, American National Standard for Methods of Measurement of Radio-Noise Emissions from Low-Voltage Electrical and Electronic Equipment in the range of 9 kHz to 40 GHz.

The uncertainty of any RF tests which use conducted method measurement is ± 3.17 dB, the uncertainty of any radiation on emissions measurement is:

30M~200MHz: ± 4.7 dB;
200M~1GHz: ± 6.0 dB;
1G-6GHz: ± 5.13 dB;
6G~25GHz: ± 5.47 dB;

And the uncertainty will not be taken into consideration for all test data recorded in the report.

Test Facility

The test site used by BACL to collect test data is located in the 5040, HuiLongWan Plaza, No. 1, ShaWan Road, JinNiu District, ChengDu, China

Test site at BACL has been fully described in reports submitted to the Federal Communication Commission (FCC). The details of these reports have been found to be in compliance with the requirements of Section 2.948 of the FCC Rules on April 24, 2015. The facility also complies with the radiated and AC line conducted test site criteria set forth in ANSI C63.4-2014.

The Federal Communications Commission has the reports on file and is listed under FCC Registration No.: 560332. The test site has been approved by the FCC for public use and is listed in the FCC Public Access Link (PAL) database.

SYSTEM TEST CONFIGURATION

Description of Test Configuration

The system was configured for testing in a typical fashion (as normally used by a typical user).

EUT Exercise Software

The software “winthrax.exe” was used during test.

Equipment Modifications

No modification was made to the EUT tested.

Local Support Equipment List and Details

Manufacturer	Description	Model	Serial Number
PHILIPS	Monitor	227E3L	AU3A1140001077
Kinston	Flash Disk	4GB	482788
ipod	Headset	N/A	N/A
DLL	Laptop	PP11L	Q324516553455
Tenda	Router	T311R	478925
TOSHIBA	HDD	DTP105	247BSYV2SRE8
Lenovo	Keyboard	KB-US19EB	IMHYX011071016460

Support Cable List and Details

Cable Description	Shielding Type	Ferrite Core	Length (m)	From Port	To
DC Cable	no	yes	1.2	Adapter	EUT
HDMI Cable	yes	yes	1.5	HDMI Port of EUT	Monitor
RJ45 Cable	yes	no	1.0	EUT	Laptop
RJ45 Cable	yes	no	10	EUT	Router
RJ45 Cable	yes	no	1.0	POE adapter	EUT
Earphone cable	no	no	1.2	EUT	earphone
USB Cable	yes	yes	0.6	USB Port of Laptop	HDD
USB Cable	yes	no	1.5	USB Port of Laptop	Keyboard

Configuration of Test Setup

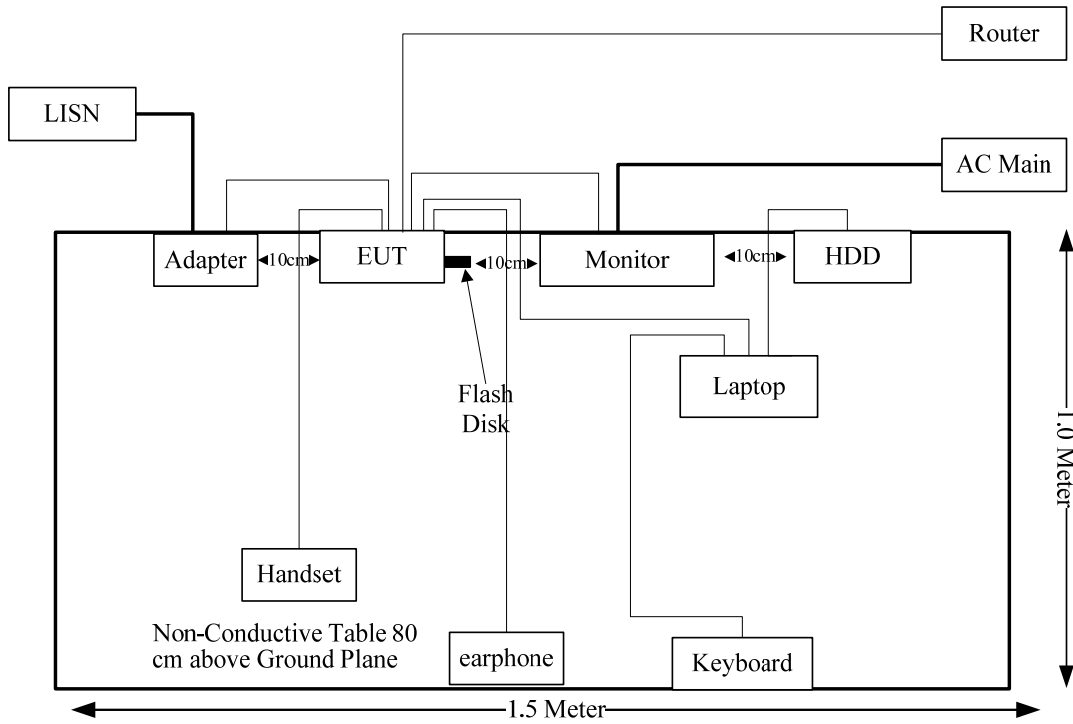

SUMMARY OF TEST RESULTS

FCC Rules	Description of Test	Results
§15.107	Conducted Emissions	Compliance
§15.109	Radiated Emissions	Compliance

FCC§15.107 - CONDUCTED EMISSIONS

Measurement Uncertainty

All measurements involve certain levels of uncertainties, especially in field of EMC. The factors contributing to uncertainties are Receiver, cable loss, and LISN.

Compliance or non-compliance with a disturbance limit shall be determined in the following manner:

If U_{lab} is less than or equal to U_{cispr} of Table 1, then:

- compliance is deemed to occur if no measured disturbance level exceeds the disturbance limit;
- non-compliance is deemed to occur if any measured disturbance level exceeds the disturbance limit.

If U_{lab} is greater than U_{cispr} of Table 1, then:

- compliance is deemed to occur if no measured disturbance level, increased by $(U_{lab} - U_{cispr})$, exceeds the disturbance limit;
- non-compliance is deemed to occur if any measured disturbance level, increased by $(U_{lab} - U_{cispr})$, exceeds the disturbance limit.

Based on CISPR 16-4-2:2011, measurement uncertainty of conducted disturbance at mains port using AMN at Bay Area Compliance Laboratories Corp. (Chengdu) is ± 3.17 dB (150 kHz to 30 MHz).

Table 1 – Values of U_{cispr}

Measurement	U_{cispr}
Conducted disturbance at mains port using AMN (150 kHz to 30 MHz)	3.4 dB

EUT Setup

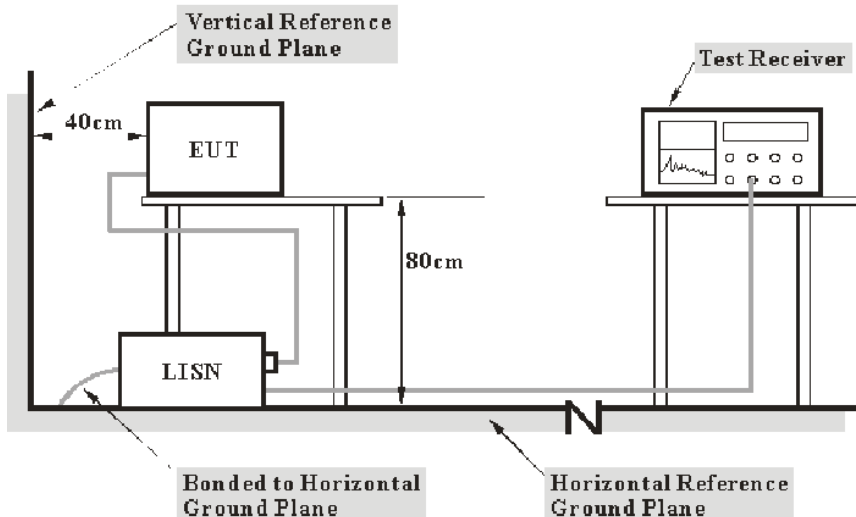

- Note: 1. Support units were connected to second LISN.
 2. Both of LISNs (AMN) 80 cm from EUT and at the least 80 cm from other units and other metal planes support units.

The setup of EUT is according with per ANSI C63.4-2014 measurement procedure. The specification used was with the FCC Part 15 B Class B limits.

The external I/O cables were draped along the test table and formed a bundle 30 to 40 cm long in the middle.

EMI Test Receiver Setup

The EMI test receiver was set to investigate the spectrum from 150 kHz to 30 MHz.

During the conducted emission test, the EMI test receiver was set with the following configurations:

Frequency Range	IF B/W
150 kHz – 30 MHz	9 kHz

Test Equipment List and Details

Manufacturer	Description	Model	Serial Number	Calibration Date	Calibration Due Date
Rohde & Schwarz	EMI Test Receiver	ESCS 30	836858/0016	2016-12-02	2017-12-01
Rohde & Schwarz	L.I.S.N.	ENV216	3560.6550.06	2016-12-02	2017-12-01
N/A	Conducted Cable	NO.5	N/A	2016-11-10	2017-11-09
Rohde & Schwarz	PULSE LIMITER	ESH3Z2	357.8810.52	2016-10-31	2017-10-30
R&S	Test Software	EMC32	Version8.53.0	N/A	N/A

* **Statement of Traceability:** BAACL (Chengdu) attested that all calibrations have been performed, traceable to National Primary Standards and International System of Units (SI).

Test Procedure

During the conducted emission test, the adapter of laptop was connected to the outlet of the first LISN and the other support equipments were connected to the outlet of the second LISN.

Maximizing procedure was performed on the six (6) highest emissions of the EUT.

All data was recorded in the Quasi-peak and average detection mode.

Corrected Amplitude & Margin Calculation

The basic equation is as follows:

$$V_C = V_R + A_C + VDF$$

Herein,

V_C : corrected voltage amplitude

V_R : reading voltage amplitude

A_C : attenuation caused by cable loss

VDF: voltage division factor of AMN or ISN

The “**Margin**” column of the following data tables indicates the degree of compliance within the applicable limit. For example, a margin of 7dB means the emission is 7dB below the maximum limit. The equation for margin calculation is as follows:

$$\text{Margin} = \text{Limit} - \text{Corrected Amplitude}$$

Test Data

Environmental Conditions

Temperature:	26.7 °C
Relative Humidity:	48 %
ATM Pressure:	101kPa

The testing was performed by Kevin Hu on 2016-12-13.

Test Mode: Operation (Adapter Mode)

AC120V, 60Hz, Line:

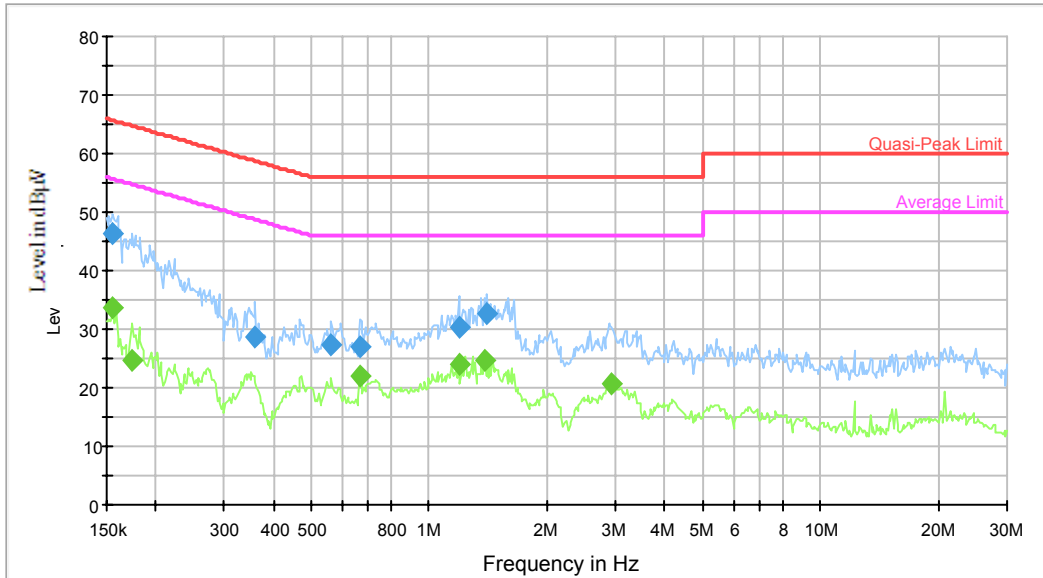

Frequency (MHz)	QuasiPeak (dBµV)	Bandwidth (kHz)	Line	Corr. (dB)	Margin (dB)	Limit (dBµV)	Comment
0.156097	46.4	9.000	L1	19.7	19.3	65.7	Compliance
0.360371	28.8	9.000	L1	19.7	29.9	58.7	Compliance
0.563041	27.5	9.000	L1	19.7	28.5	56.0	Compliance
0.665597	26.8	9.000	L1	19.7	29.2	56.0	Compliance
1.190776	30.2	9.000	L1	19.7	25.8	56.0	Compliance
1.407671	32.7	9.000	L1	19.7	23.3	56.0	Compliance

Frequency (MHz)	Average (dBµV)	Bandwidth (kHz)	Line	Corr. (dB)	Margin (dB)	Limit (dBµV)	Comment
0.156097	33.7	9.000	L1	19.7	22.0	55.7	Compliance
0.174519	24.7	9.000	L1	19.7	30.0	54.7	Compliance
0.665597	21.9	9.000	L1	19.7	24.1	46.0	Compliance
1.190776	24.1	9.000	L1	19.7	21.9	46.0	Compliance
1.385415	24.5	9.000	L1	19.7	21.5	46.0	Compliance
2.930016	20.6	9.000	L1	19.7	25.4	46.0	Compliance

AC120V, 60Hz, Neutral:

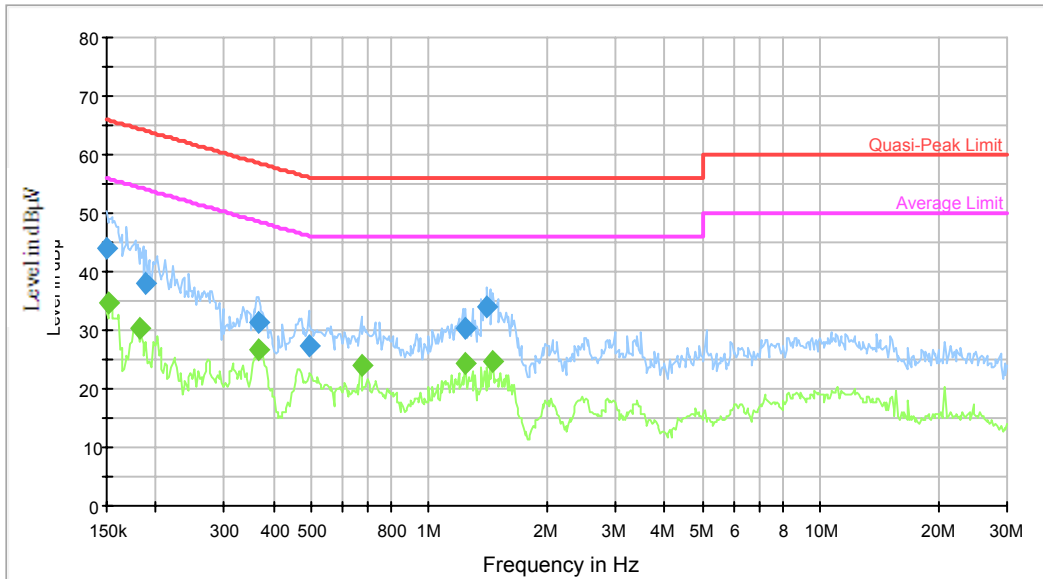

Frequency (MHz)	QuasiPeak (dBµV)	Bandwidth (kHz)	Line	Corr. (dB)	Margin (dB)	Limit (dBµV)	Comment
0.150000	43.8	9.000	N	19.7	22.2	66.0	Compliance
0.188994	38.1	9.000	N	19.6	26.0	64.1	Compliance
0.366160	31.3	9.000	N	19.6	27.3	58.6	Compliance
0.491712	27.3	9.000	N	19.6	28.8	56.1	Compliance
1.239175	30.3	9.000	N	19.6	25.7	56.0	Compliance
1.407671	33.9	9.000	N	19.7	22.1	56.0	Compliance

Frequency (MHz)	Average (dBµV)	Bandwidth (kHz)	Line	Corr. (dB)	Margin (dB)	Limit (dBµV)	Comment
0.152410	34.8	9.000	N	19.7	21.1	55.9	Compliance
0.183065	30.3	9.000	N	19.6	24.0	54.3	Compliance
0.366160	26.7	9.000	N	19.6	21.9	48.6	Compliance
0.670921	24.1	9.000	N	19.6	21.9	46.0	Compliance
1.239175	24.3	9.000	N	19.6	21.7	46.0	Compliance
1.453260	24.6	9.000	N	19.7	21.4	46.0	Compliance

Test Mode: Operation (POE Mode)

AC120V, 60Hz, Line:

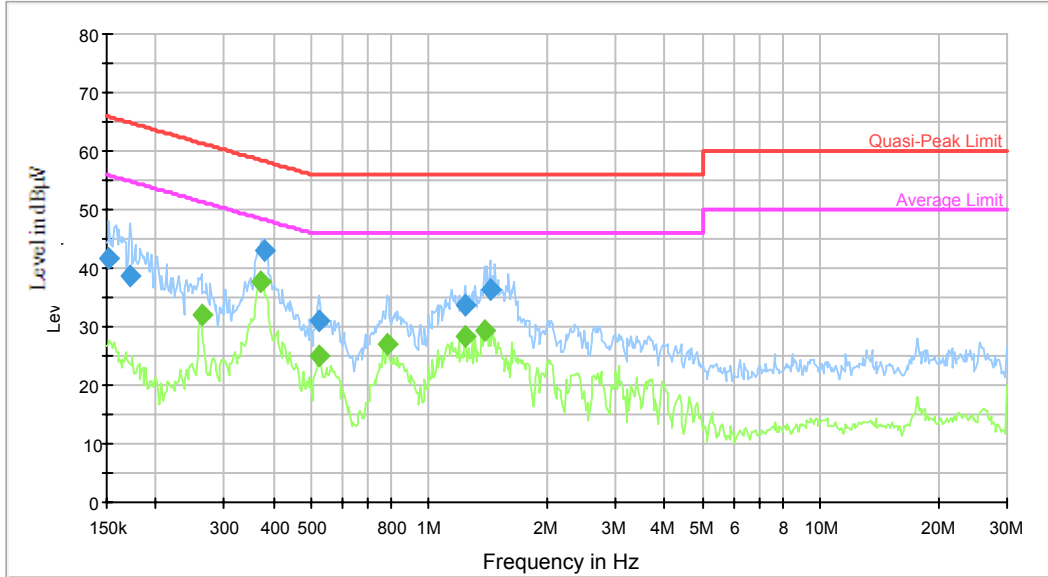

Frequency (MHz)	QuasiPeak (dBµV)	Bandwidth (kHz)	Line	Corr. (dB)	Margin (dB)	Limit (dBµV)	Comment
0.152410	41.5	9.000	L1	19.7	24.4	65.9	Compliance
0.171759	38.6	9.000	L1	19.7	26.3	64.9	Compliance
0.378019	43.2	9.000	L1	19.8	15.1	58.3	Compliance
0.524077	31.0	9.000	L1	19.7	25.0	56.0	Compliance
1.239175	33.6	9.000	L1	19.7	22.4	56.0	Compliance
1.430284	36.4	9.000	L1	19.7	19.6	56.0	Compliance

Frequency (MHz)	Average (dBµV)	Bandwidth (kHz)	Line	Corr. (dB)	Margin (dB)	Limit (dBµV)	Comment
0.262017	32.1	9.000	L1	19.7	19.3	51.4	Compliance
0.369089	37.8	9.000	L1	19.7	10.7	48.5	Compliance
0.524077	24.9	9.000	L1	19.7	21.1	46.0	Compliance
0.780588	26.9	9.000	L1	19.7	19.1	46.0	Compliance
1.239175	28.5	9.000	L1	19.7	17.5	46.0	Compliance
1.385415	29.3	9.000	L1	19.7	16.7	46.0	Compliance

AC120V, 60Hz, Neutral:

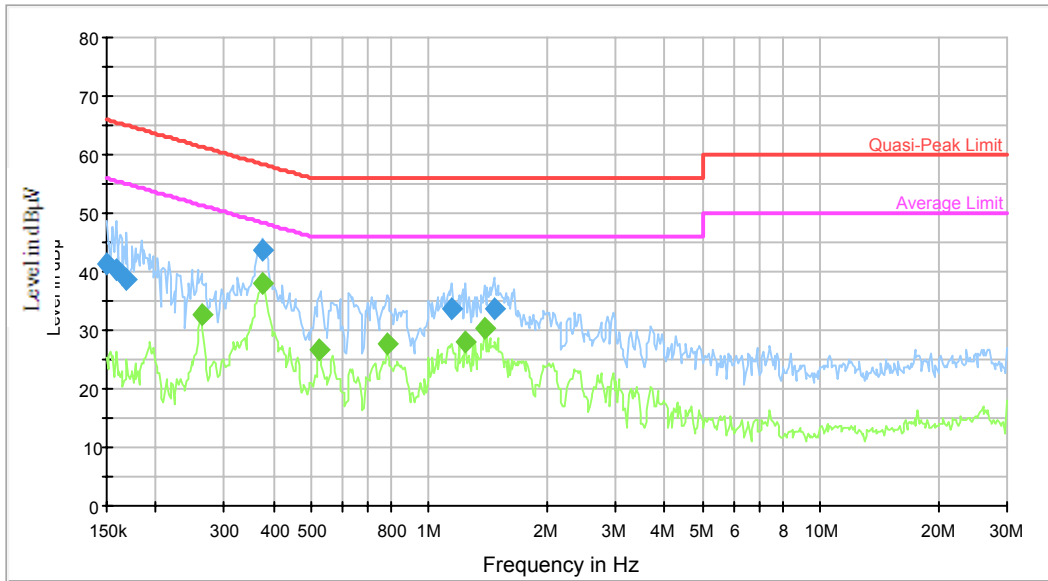

Frequency (MHz)	QuasiPeak (dBµV)	Bandwidth (kHz)	Line	Corr. (dB)	Margin (dB)	Limit (dBµV)	Comment
0.150000	41.3	9.000	N	19.7	24.7	66.0	Compliance
0.158604	40.4	9.000	N	19.7	25.1	65.5	Compliance
0.169044	38.8	9.000	N	19.7	26.2	65.0	Compliance
0.375019	43.6	9.000	N	19.6	14.8	58.4	Compliance
1.144267	33.8	9.000	N	19.7	22.2	56.0	Compliance
1.464886	33.7	9.000	N	19.7	22.3	56.0	Compliance

Frequency (MHz)	Average (dBµV)	Bandwidth (kHz)	Line	Corr. (dB)	Margin (dB)	Limit (dBµV)	Comment
0.262017	32.7	9.000	N	19.6	18.7	51.4	Compliance
0.375019	38.1	9.000	N	19.6	10.3	48.4	Compliance
0.524077	26.6	9.000	N	19.6	19.4	46.0	Compliance
0.780588	27.7	9.000	N	19.6	18.3	46.0	Compliance
1.239175	27.9	9.000	N	19.6	18.1	46.0	Compliance
1.385415	30.5	9.000	N	19.7	15.5	46.0	Compliance

FCC §15.109 - RADIATED SPURIOUS EMISSIONS

Measurement Uncertainty

Compliance or non-compliance with a disturbance limit shall be determined in the following manner:

If U_{lab} is less than or equal to U_{cispr} of Table 1, then:

- compliance is deemed to occur if no measured disturbance level exceeds the disturbance limit;
- non-compliance is deemed to occur if any measured disturbance level exceeds the disturbance limit.

If U_{lab} is greater than U_{cispr} of Table 1, then:

- compliance is deemed to occur if no measured disturbance level, increased by $(U_{lab} - U_{cispr})$, exceeds the disturbance limit;
- non-compliance is deemed to occur if any measured disturbance level, increased by $(U_{lab} - U_{cispr})$, exceeds the disturbance limit.

Based on CISPR 16-4-2-2011, measurement uncertainty of radiated emission at a distance of 3m at Bay Area Compliance Laboratories Corp. (Chengdu) is:

- 30M~200MHz: ± 4.7 dB ;
- 200M~1GHz: ± 6.0 dB ;
- 1G-6GHz: ± 5.13 dB;
- 6G~25GHz: ± 5.47 dB;

Table 1 – Values of U_{cispr}

Measurement		U_{cispr}
Radiated disturbance (electric field strength at an OATS or in a SAC)	(30 MHz to 1000 MHz)	6.3 dB
Radiated disturbance (electric field strength in a FAR)	(1 GHz to 6 GHz)	5.2 dB
Radiated disturbance (electric field strength in a FAR)	(6 GHz to 18 GHz)	5.5 dB

EUT Setup

Below 1GHz:

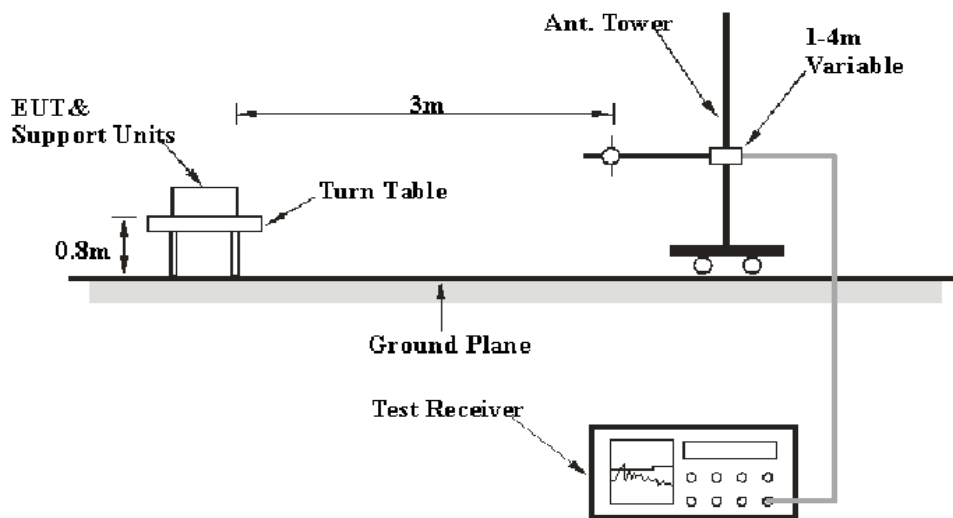

Above 1GHz:

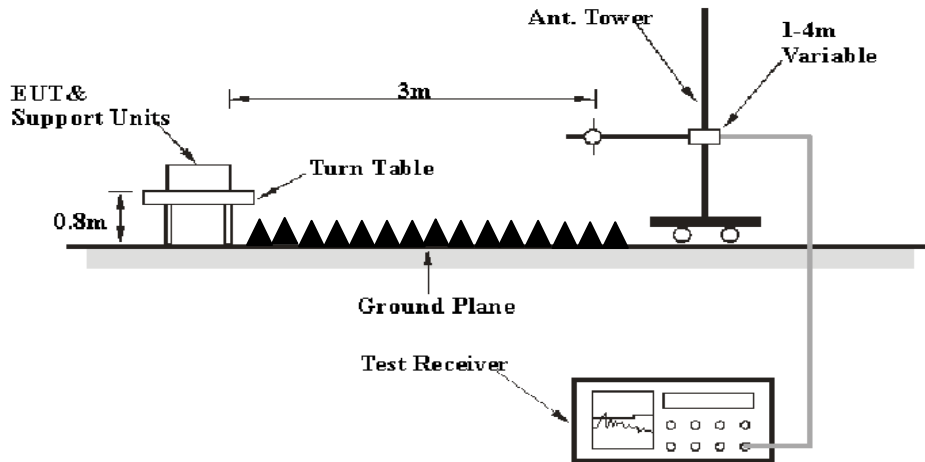

The radiated emission tests were performed at the 3 meters distance in chamber, using the setup accordance with the ANSI C63.4-2014. The specification used was the FCC Part 15.109 Class B limits.

EMI Test Receiver Setup

The system was investigated from 30 MHz to 13.0 GHz.

During the radiated emission test, the EMI test receiver was set with the following configurations:

Frequency Range	RBW	Video B/W	IF B/W	Detector
30 MHz – 1000 MHz	120 kHz	300 kHz	120 kHz	QP
Above 1 GHz	1 MHz	3 MHz	/	Peak
	1 MHz	10 Hz	/	AVG

Test Procedure

During the radiated emissions, the adapter of laptop was connected to the first AC floor outlet and the other support equipments were connected to the second AC floor outlet.

Maximizing procedure was performed on the highest emissions to ensure that the EUT complied with all installation combinations.

The data was recorded in the Quasi-peak detection mode for below 1 GHz, peak and average detection mode above 1 GHz.

Test Equipment List and Details

Manufacturer	Description	Model	Serial Number	Calibration Date	Calibration Due Date
Agilent	Amplifier	8447D	2944A10442	2016-12-02	2017-12-01
Rohde & Schwarz	EMI Test Receiver	ESCI	100028	2016-12-02	2017-12-01
Sunol Sciences	Broadband Antenna	JB3	A101808	2016-04-10	2019-04-09
Rohde & Schwarz	Spectrum Analyzer	FSEM30	100018	2016-12-02	2017-12-01
ETS	Horn Antenna	3115	003-6076	2016-12-02	2017-12-01
Ducommun Technologies	Horn Antenna	ARH-4223-02	1007726-0113 024	2014-06-16	2017-06-15
Mini-circuits	Amplifier	ZVA-183-S+	771001215	2016-05-20	2017-05-19
EMCT	Semi-Anechoic Chamber	966	N/A	2015-04-24	2018-04-23
N/A	RF Cable (below 1GHz)	NO.1	N/A	2016-11-10	2017-11-09
N/A	RF Cable (below 1GHz)	NO.4	N/A	2016-11-10	2017-11-09
N/A	RF Cable (above 1GHz)	NO.2	N/A	2016-11-10	2017-11-09

* **Statement of Traceability:** BACL (Chengdu) attested that all calibrations have been performed, traceable to National Primary Standards and International System of Units (SI).

Corrected Amplitude & Margin Calculation

The Corrected Amplitude is calculated by adding the Antenna Loss and Cable Loss, and subtracting the Amplifier Gain from the Meter Reading. The basic equation is as follows:

$$\text{Corrected Amplitude} = \text{Meter Reading} + \text{Antenna Loss} + \text{Cable Loss} - \text{Amplifier Gain}$$

The “**Margin**” column of the following data tables indicates the degree of compliance with the applicable limit. For example, a margin of 7 dB means the emission is 7 dB below the limit. The equation for margin calculation is as follows:

$$\text{Margin} = \text{Limit} - \text{Corrected Amplitude}$$

Test Data

Environmental Conditions

Temperature:	23.6 °C
Relative Humidity:	38%
ATM Pressure:	101.2kPa

** The testing was performed by Kevin Hu on 2016-12-20.*

Test Result: Compliance

Test Mode: Operation

Adapter:

1) Below 1GHz:

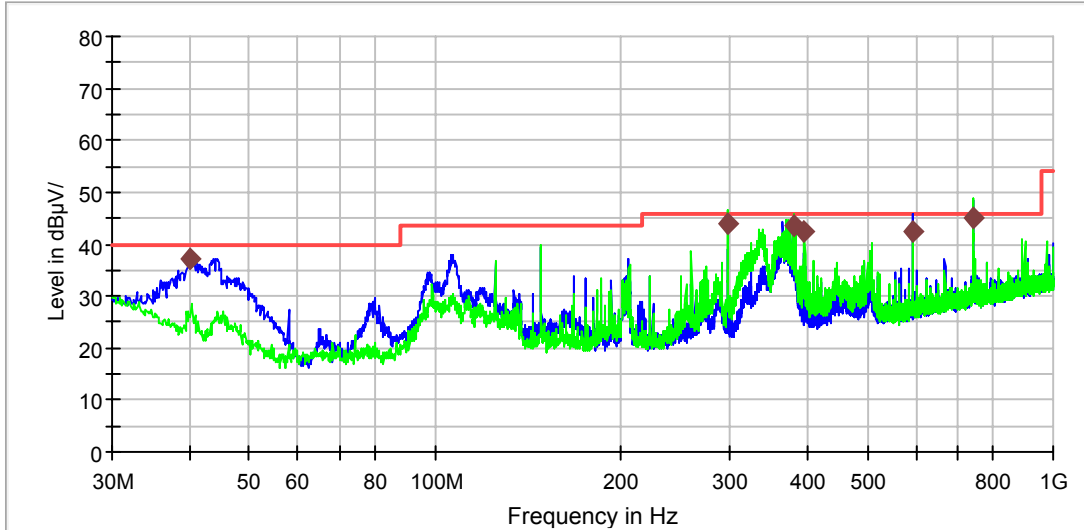

Frequency (MHz)	QuasiPeak (dBµV/m)	Height (cm)	Polarization	Azimuth (deg)	Corr. (dB)	Margin (dB)	Limit (dBµV/m)
40.185000	37.2	100.0	V	0.0	-4.7	2.8	40.0
296.992500	43.8	100.0	H	0.0	-3.7	2.2	46.0
379.563750	43.7	100.0	H	175.0	-2.4	2.3	46.0
395.932500	42.5	100.0	H	158.0	-2.2	3.5	46.0
594.055000	42.6	100.0	V	21.0	1.1	3.4	46.0
742.586250	44.9	100.0	H	38.0	3.8	1.1	46.0

2) Above 1GHz:

Horizontal:

Frequency (MHz)	Receiver		Rx Antenna		Cable loss (dB)	Amplifier Gain (dB)	Corrected Amplitude (dBµV/m)	Limit (dBµV/m)	Margin (dB)
	Reading (dBµV)	Detector	Polar (H/V)	Factor (dB)					
1141	37.46	PK	H	23.17	2.17	26.67	36.13	74.00	37.87
1141	30.35	AV	H	23.17	2.17	26.67	29.02	54.00	24.98
1399.5	39.3	PK	H	23.84	2.53	26.43	39.24	74.00	34.76
1399.5	30.58	AV	H	23.84	2.53	26.43	30.52	54.00	23.48
2985.75	31.81	PK	H	24.17	3.42	26.42	32.98	74.00	41.02
2985.75	22.95	AV	H	24.17	3.42	26.42	24.12	54.00	29.88
1188	50.43	PK	V	23.29	2.24	26.63	49.33	74.00	24.67
1188	29.65	AV	V	23.29	2.24	26.63	28.55	54.00	25.45
1352.5	39.7	PK	V	23.72	2.47	26.47	39.42	74.00	34.58
1352.5	30.47	AV	V	23.72	2.47	26.47	30.19	54.00	23.81
2774.25	39.35	PK	V	23.75	3.23	26.63	39.70	74.00	34.30
2774.25	31.79	AV	V	23.75	3.23	26.63	32.14	54.00	21.86

POE:

1) Below 1GHz:

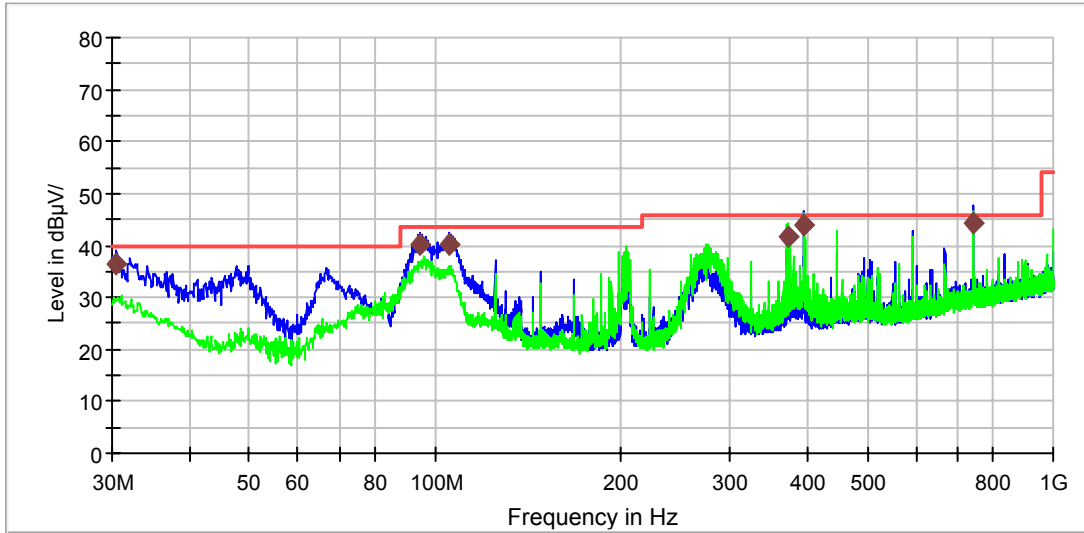

Frequency (MHz)	QuasiPeak (dBµV/m)	Height (cm)	Polarization	Azimuth (deg)	Corr. (dB)	Margin (dB)	Limit (dBµV/m)
40.185000	37.2	100.0	V	0.0	-4.7	2.8	40.0
296.992500	43.8	100.0	H	0.0	-3.7	2.2	46.0
379.563750	43.7	100.0	H	175.0	-2.4	2.3	46.0
395.932500	42.5	100.0	H	158.0	-2.2	3.5	46.0
594.055000	42.6	100.0	V	21.0	1.1	3.4	46.0
742.586250	44.9	100.0	H	38.0	3.8	1.1	46.0

2) Above 1GHz:

Frequency (MHz)	Receiver		Rx Antenna		Cable loss (dB)	Amplifier Gain (dB)	Corrected Amplitude (dBµV/m)	Limit (dBµV/m)	Margin (dB)
	Reading (dBµV)	Detector	Polar (H/V)	Factor (dB)					
1216.433	41.43	PK	H	23.36	2.28	26.60	40.47	74.00	33.53
1216.433	28.37	AV	H	23.36	2.28	26.60	27.41	54.00	26.59
1625.251	45	PK	H	24.30	2.77	26.45	45.62	74.00	28.38
1625.251	32.07	AV	H	24.30	2.77	26.45	32.69	54.00	21.31
2226.453	42.01	PK	H	24.13	3.02	26.85	42.31	74.00	31.69
2226.453	29.08	AV	H	24.13	3.02	26.85	29.38	54.00	24.62
1216.433	43.75	PK	V	23.36	2.28	26.60	42.79	74.00	31.21
1216.433	31.88	AV	V	23.36	2.28	26.60	30.92	54.00	23.08
1625.251	47.58	PK	V	24.30	2.77	26.45	48.20	74.00	25.80
1625.251	34.94	AV	V	24.30	2.77	26.45	35.56	54.00	18.44
2226.453	41.96	PK	V	24.13	3.02	26.85	42.26	74.00	31.74
2226.453	29.06	AV	V	24.13	3.02	26.85	29.36	54.00	24.64

******* END OF REPORT *******