



中认信通
CHINA CERTIFICATION ICT CO., LTD (DONGGUAN)



TEST REPORT

Applicant: AKUVOX (XIAMEN) NETWORKS CO., LTD.

Address: 10/F, No.56 Guanri Road, Software Park II, Xiamen 361009, China

FCC ID: 2AHCR-S563W

Product Name: Indoor Monitor

Standard(s): 47 CFR Part 15, Subpart C(15.247)

ANSI C63.10-2013

KDB 558074 D01 15.247 Meas Guidance v05r02

The above device has been tested and found compliant with the requirement of the relative standards by China Certification ICT Co., Ltd (Dongguan)

Report Number: CR231167748-00C

Date Of Issue: 2024/2/22

Reviewed By: Calvin Chen

Title: RF Engineer

Approved By: Sun Zhong

Title: Manager

Test Laboratory: China Certification ICT Co., Ltd (Dongguan)

No. 113, Pingkang Road, Dalang Town, Dongguan,
Guangdong, China

Tel: +86-769-82016888

Test Facility

The Test site used by China Certification ICT Co., Ltd (Dongguan) to collect test data is located on the No. 113, Pingkang Road, Dalang Town, Dongguan, Guangdong, China.

The lab has been recognized as the FCC accredited lab under the KDB 974614 D01 and is listed in the FCC Public Access Link (PAL) database, FCC Registration No. : 442868, the FCC Designation No. : CN1314.

Declarations

China Certification ICT Co., Ltd (Dongguan) is not responsible for the authenticity of any test data provided by the applicant. Data included from the applicant that may affect test results are marked with a triangle symbol “▲”. Customer model name, addresses, names, trademarks etc. are not considered data.

Unless otherwise stated the results shown in this test report refer only to the sample(s) tested.

This report cannot be reproduced except in full, without prior written approval of the Company.

This report is valid only with a valid digital signature. The digital signature may be available only under the Adobe software above version 7.0.

This report may contain data that are not covered by the accreditation scope and shall be marked with an asterisk “★”.

CONTENTS

DOCUMENT REVISION HISTORY	5
1. GENERAL INFORMATION	6
1.1 PRODUCT DESCRIPTION FOR EQUIPMENT UNDER TEST (EUT)	6
1.2 DESCRIPTION OF TEST CONFIGURATION.....	8
1.2.1 EUT Operation Condition:.....	8
1.2.2 Support Equipment List and Details	9
1.2.3 Support Cable List and Details	9
1.2.4 Block Diagram of Test Setup.....	10
1.3 MEASUREMENT UNCERTAINTY	11
2. SUMMARY OF TEST RESULTS	12
3. REQUIREMENTS AND TEST PROCEDURES	13
3.1 AC LINE CONDUCTED EMISSIONS.....	13
3.1.1 Applicable Standard.....	13
3.1.2 EUT Setup.....	14
3.1.3 EMI Test Receiver Setup	14
3.1.4 Test Procedure	15
3.1.5 Corrected Amplitude & Margin Calculation.....	15
3.2 RADIATION SPURIOUS EMISSIONS.....	16
3.2.1 Applicable Standard.....	16
3.2.2 EUT Setup.....	16
3.2.3 EMI Test Receiver & Spectrum Analyzer Setup	17
3.2.4 Test Procedure	18
3.2.5 Corrected Amplitude & Margin Calculation.....	18
3.3 MINIMUM 6 DB BANDWIDTH:	19
3.3.1 Applicable Standard.....	19
3.3.2 EUT Setup.....	19
3.3.3 Test Procedure	19
3.4 99% OCCUPIED BANDWIDTH:	20
3.4.1 EUT Setup.....	20
3.4.2 Test Procedure	20
3.5 MAXIMUM CONDUCTED OUTPUT POWER:	21
3.5.1 Applicable Standard.....	21
3.5.2 EUT Setup.....	21
3.5.3 Test Procedure	21
3.6 MAXIMUM POWER SPECTRAL DENSITY:	22
3.6.1 Applicable Standard.....	22
3.6.2 EUT Setup.....	22
3.6.3 Test Procedure	22
3.7 100 KHZ BANDWIDTH OF FREQUENCY BAND EDGE:	23
3.7.1 Applicable Standard.....	23
3.7.2 EUT Setup.....	23
3.7.3 Test Procedure	23

3.8 DUTY CYCLE:.....24
 3.8.1 EUT Setup.....24
 3.8.2 Test Procedure24
3.9 ANTENNA REQUIREMENT.....24
 3.9.1 Applicable Standard.....24
 3.9.2 Judgment.....24
4. Test DATA AND RESULTS 25
 4.1 AC LINE CONDUCTED EMISSIONS.....25
 4.2 RADIATION SPURIOUS EMISSIONS28
 4.3 MINIMUM 6 DB EMISSION BANDWIDTH46
 4.4 99% OCCUPIED BANDWIDTH.....51
 4.5 MAXIMUM CONDUCTED OUTPUT POWER.....56
 4.6 MAXIMUM POWER SPECTRAL DENSITY57
 4.7 100 KHZ BANDWIDTH OF FREQUENCY BAND EDGE.....62
 4.8 DUTY CYCLE67
5. EUT PHOTOGRAPHS 69
6. TEST SETUP PHOTOGRAPHS 70

DOCUMENT REVISION HISTORY

Revision Number	Report Number	Description of Revision	Date of Revision
1.0	CR231167748-00C	Original Report	2024/2/22

1. GENERAL INFORMATION

1.1 Product Description for Equipment under Test (EUT)

EUT Name:	Indoor Monitor
EUT Model:	S563W
Operation Frequency:	2412-2462 MHz (802.11b/g/n ht20) 2422-2452 MHz (802.11n ht40)
Maximum Peak Output Power (Conducted):	23.73 dBm
Modulation Type:	802.11b: DSSS-DBPSK, DQPSK, CCK 802.11g/n: OFDM-BPSK, QPSK, 16QAM, 64QAM
Rated Input Voltage:	DC 12V From Adapter DC 48V From POE
Serial Number:	2DS2-1(For RF Conducted Test) 2DS2-2(For RE/CE Test)
EUT Received Date:	2023/11/16
EUT Received Status:	Good

Operation Frequency Detail: For 802.11b/g/n ht20:

Channel	Frequency (MHz)	Channel	Frequency (MHz)
1	2412	7	2442
2	2417	8	2447
3	2422	9	2452
4	2427	10	2457
5	2432	11	2462
6	2437	/	/

Per section 15.31(m), the below frequencies were performed to test:

Test Channel	Frequency (MHz)
Lowest	2412
Middle	2437
Highest	2462

For 802.11n ht40:

Channel	Frequency (MHz)	Channel	Frequency (MHz)
3	2422	7	2442
4	2427	8	2447
5	2432	9	2452
6	2437	/	/

Per section 15.31(m), the below frequencies were performed to test:

Test Channel	Frequency (MHz)
Lowest	2422
Middle	2437
Highest	2452

Antenna Information Detail ▲:

Antenna Type	input impedance (Ohm)	Frequency Range	Antenna Gain
FPC	50	2.4~2.5GHz	3.1 dBi

The Method of §15.203 Compliance:

- Antenna was permanently attached to the unit.
 Antenna use a unique type of connector to attach to the EUT.
 Unit was professionally installed, and installer shall be responsible for verifying that the correct antenna is employed with the unit.

Accessory Information:

Accessory Description	Manufacturer	Model	Parameters
/	/	/	/

1.2 Description of Test Configuration

1.2.1 EUT Operation Condition:

EUT Operation Mode:	The system was configured for testing in Engineering Mode, which was provided by the manufacturer. Per BT report test, test with Powered by POE was the worst.
Equipment Modifications:	No
EUT Exercise Software:	Engineering mode

The software was provided by manufacturer. The maximum power was configured as below, that was provided by the manufacturer▲:

Mode	Channel	Frequency (MHz)	Data Rate	Power Level Setting
802.11b	Lowest	2412	1Mbps	47
	Middle	2437	1Mbps	47
	Highest	2462	1Mbps	47
802.11g	Lowest	2412	6Mbps	44
	Middle	2437	6Mbps	44
	Highest	2462	6Mbps	44
802.11n ht20	Lowest	2412	MCS0	47
	Middle	2437	MCS0	47
	Highest	2462	MCS0	47
802.11n ht40	Lowest	2422	MCS0	47
	Middle	2437	MCS0	47
	Highest	2452	MCS0	47

Note:

1. The above are the worst-case data rates, which are determined for each mode based upon investigations by measuring the power and PSD across all data rates, bandwidths, and modulations.

1.2.2 Support Equipment List and Details

Manufacturer	Description	Model	Serial Number
TOTO Link	Router	LR1200	190924004S1
Nexhome	Door Phone	DH-I66S(P)	EMZBIU20113001
/	RS485 Load	RS485-X1	F-EM-PHRJ45X8011
DELL	Laptop	E6410	GMLGPM1
/	Relay Load	Relay-C1	EMRLLD20221010EN
Metke Skycom	POE	S213M-5	MT21090063
GWT	Bell	A-24	unknown
GWT	Alarm	unknown	unknown

1.2.3 Support Cable List and Details

Cable Description	Shielding Type	Ferrite Core	Length (m)	From Port	To
RJ45 Cable	No	No	2	Router	Door Phone
RJ45 Cable	No	No	10	Router	POE
AC Cable	No	No	1	POE	LISN
RJ45 Cable	No	No	0.3	POE	EUT
RS485 Cable	No	No	3	RS485 Load	EUT
DC Cable	No	No	3	Relay Load	EUT
RJ45 Cable	No	No	10	Laptop	EUT
DC Cable	No	No	3	Bell	EUT
DC Cable	No	No	3	Alarm	EUT

1.2.4 Block Diagram of Test Setup

AC Line Conducted Emissions:

POE:

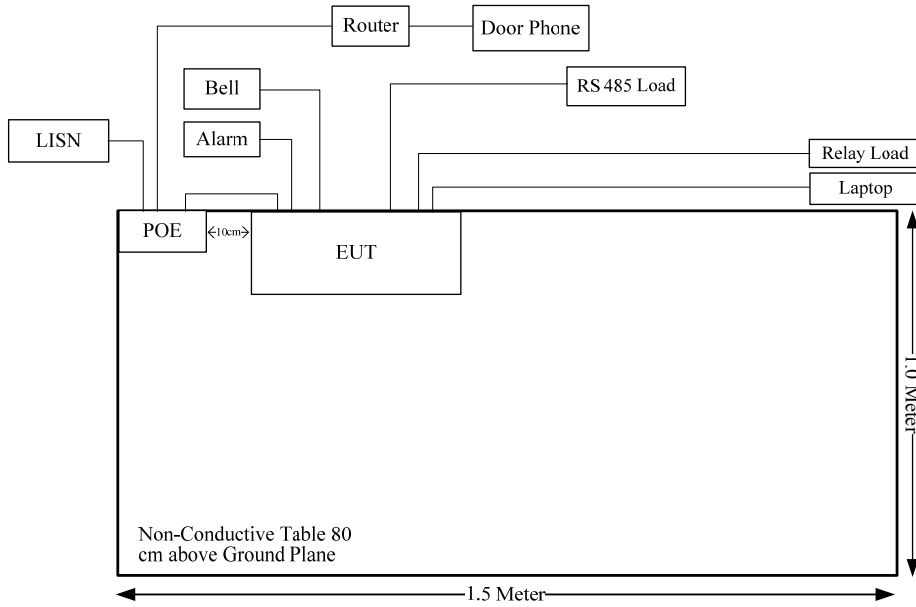

Radiation Spurious Emissions:

POE:

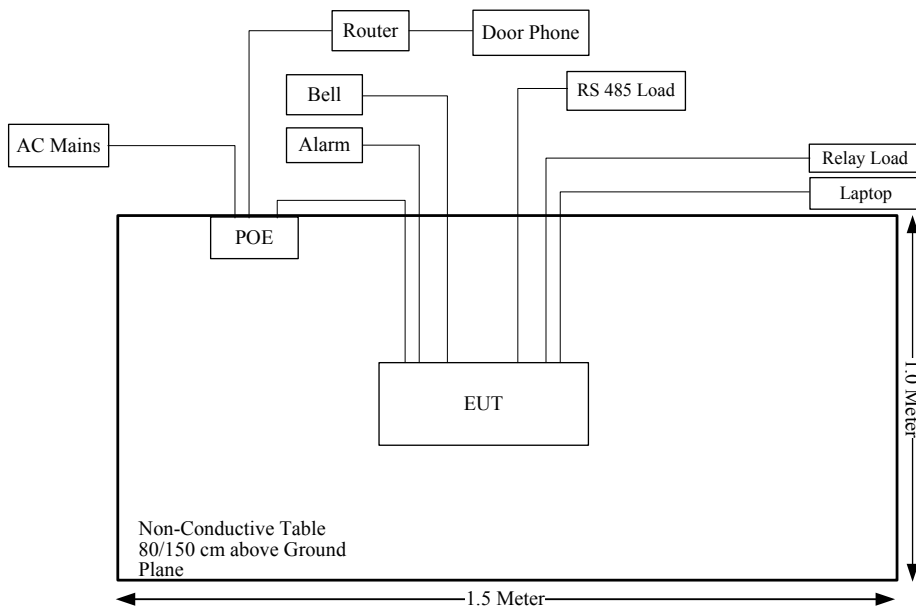

1.3 Measurement Uncertainty

Otherwise required by the applicant or Product Regulations, Decision Rule in this report did not consider the uncertainty. The extended uncertainty given in this report is obtained by combining the standard uncertainty times the coverage factor K with the 95% confidence interval.

Parameter	Measurement Uncertainty
Occupied Channel Bandwidth	±5 %
RF output power, conducted	±0.61dB
Power Spectral Density, conducted	±0.61 dB
Unwanted Emissions, radiated	9kHz~30MHz: 4.12dB, 30M~200MHz: 4.15 dB, 200M~1GHz: 5.61 dB,1G~6GHz: 5.14 dB, 6G~18GHz: 5.93 dB, 18G~26.5G:5.47 dB,26.5G~40G:5.63 dB
Unwanted Emissions, conducted	±1.26 dB
Temperature	±1 °C
Humidity	±5%
DC and low frequency voltages	±0.4%
Duty Cycle	1%
AC Power Lines Conducted Emission	2.8 dB (150 kHz to 30 MHz)

2. SUMMARY OF TEST RESULTS

Standard(s) Section	Test Items	Result
§15.207(a)	AC line conducted emissions	Compliant
§15.205, §15.209, §15.247(d)	Radiated Spurious Emissions	Compliant
§15.247 (a)(2)	Minimum 6 dB Bandwidth	Compliant
§15.247(b)(3)	Maximum Conducted Output Power	Compliant
§15.247(e)	Power Spectral Density	Compliant
§15.247(d)	100 kHz Bandwidth of Frequency Band Edge	Compliant
§15.203	Antenna Requirement	Compliant

3. REQUIREMENTS AND TEST PROCEDURES

3.1 AC Line Conducted Emissions

3.1.1 Applicable Standard

FCC§15.207(a).

(a) Except as shown in paragraphs (b) and (c) of this section, for an intentional radiator that is designed to be connected to the public utility (AC) power line, the radio frequency voltage that is conducted back onto the AC power line on any frequency or frequencies, within the band 150 kHz to 30 MHz, shall not exceed the limits in the following table, as measured using a 50 μ H/50 ohms line impedance stabilization network (LISN). Compliance with the provisions of this paragraph shall be based on the measurement of the radio frequency voltage between each power line and ground at the power terminal. The lower limit applies at the boundary between the frequency ranges.

Frequency of emission (MHz)	Conducted limit (dB μ V)	
	Quasi-peak	Average
0.15-0.5	66 to 56*	56 to 46*
0.5-5	56	46
5-30	60	50

*Decreases with the logarithm of the frequency.

(b) The limit shown in paragraph (a) of this section shall not apply to carrier current systems operating as intentional radiators on frequencies below 30 MHz. In lieu thereof, these carrier current systems shall be subject to the following standards:

(1) For carrier current system containing their fundamental emission within the frequency band 535-1705 kHz and intended to be received using a standard AM broadcast receiver: no limit on conducted emissions.

(2) For all other carrier current systems: 1000 μ V within the frequency band 535-1705 kHz, as measured using a 50 μ H/50 ohms LISN.

(3) Carrier current systems operating below 30 MHz are also subject to the radiated emission limits in §15.205, §15.209, §15.221, §15.223, or §15.227, as appropriate.

(c) Measurements to demonstrate compliance with the conducted limits are not required for devices which only employ battery power for operation and which do not operate from the AC power lines or contain provisions for operation while connected to the AC power lines. Devices that include, or make provisions for, the use of battery chargers which permit operating while charging, AC adapters or battery eliminators or that connect to the AC power lines indirectly, obtaining their power through another device which is connected to the AC power lines, shall be tested to demonstrate compliance with the conducted limits.

3.1.2 EUT Setup

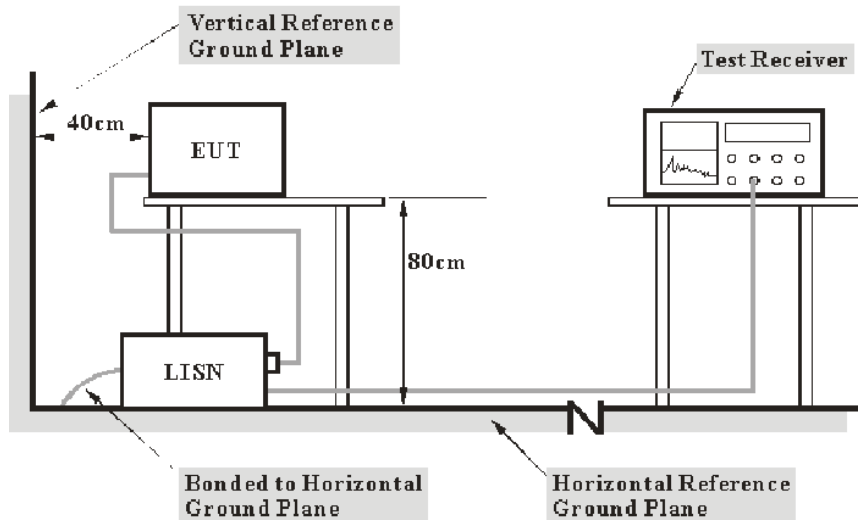

- Note: 1. Support units were connected to second LISN.
 2. Both of LISNs (AMN) 80 cm from EUT and at the least 80 cm from other units and other metal planes support units.

The setup of EUT is according with per ANSI C63.10-2013 measurement procedure. The specification used was with the FCC Part 15.207 limits.

The spacing between the peripherals was 10 cm.

3.1.3 EMI Test Receiver Setup

The EMI test receiver was set to investigate the spectrum from 150 kHz to 30 MHz.

During the conducted emission test, the EMI test receiver was set with the following configurations:

Frequency Range	IF B/W
150 kHz – 30 MHz	9 kHz

3.1.4 Test Procedure

The frequency and amplitude of the six highest ac power-line conducted emissions relative to the limit, measured over all the current-carrying conductors of the EUT power cords, and the operating frequency or frequency to which the EUT is tuned (if appropriate), should be reported, unless such emissions are more than 20 dB below the limit. AC power-line conducted emissions measurements are to be separately carried out only on each of the phase (“hot”) line(s) and (if used) on the neutral line(s), but not on the ground [protective earth] line(s). If less than six emission frequencies are within 20 dB of the limit, then the noise level of the measuring instrument at representative frequencies should be reported. The specific conductor of the power-line cord for each of the reported emissions should be identified. Measure the six highest emissions with respect to the limit on each current-carrying conductor of each power cord associated with the EUT (but not the power cords of associated or peripheral equipment that are part of the test configuration). Then, report the six highest emissions with respect to the limit from among all the measurements identifying the frequency and specific current-carrying conductor identified with the emission. The six highest emissions should be reported for each of the current-carrying conductors, or the six highest emissions may be reported over all the current-carrying conductors.

3.1.5 Corrected Amplitude & Margin Calculation

The basic equation is as follows:

Result = Reading + Factor

Factor = attenuation caused by cable loss + voltage division factor of AMN

The “**Margin**” column of the following data tables indicates the degree of compliance within the applicable limit. The equation for margin calculation is as follows:

Margin = Limit – Result

3.2 Radiation Spurious Emissions

3.2.1 Applicable Standard

FCC §15.247 (d)

In any 100 kHz bandwidth outside the frequency band in which the spread spectrum or digitally modulated intentional radiator is operating, the radio frequency power that is produced by the intentional radiator shall be at least 20 dB below that in the 100 kHz bandwidth within the band that contains the highest level of the desired power, based on either an RF conducted or a radiated measurement, provided the transmitter demonstrates compliance with the peak conducted power limits. If the transmitter complies with the conducted power limits based on the use of RMS averaging over a time interval, as permitted under paragraph (b)(3) of this section, the attenuation required under this paragraph shall be 30 dB instead of 20 dB. Attenuation below the general limits specified in §15.209(a) is not required. In addition, radiated emissions which fall in the restricted bands, as defined in §15.205(a), must also comply with the radiated emission limits specified in §15.209(a) (see §15.205(c)).

3.2.2 EUT Setup

9kHz~30MHz:

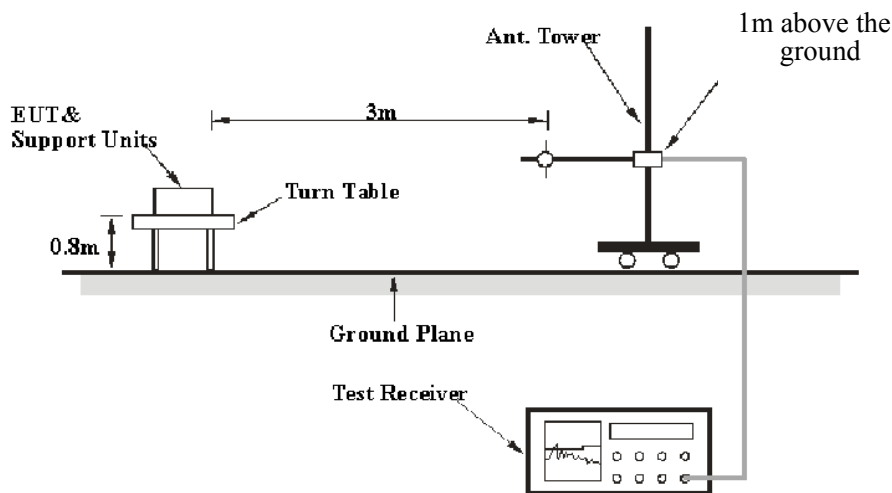

30MHz~1GHz:

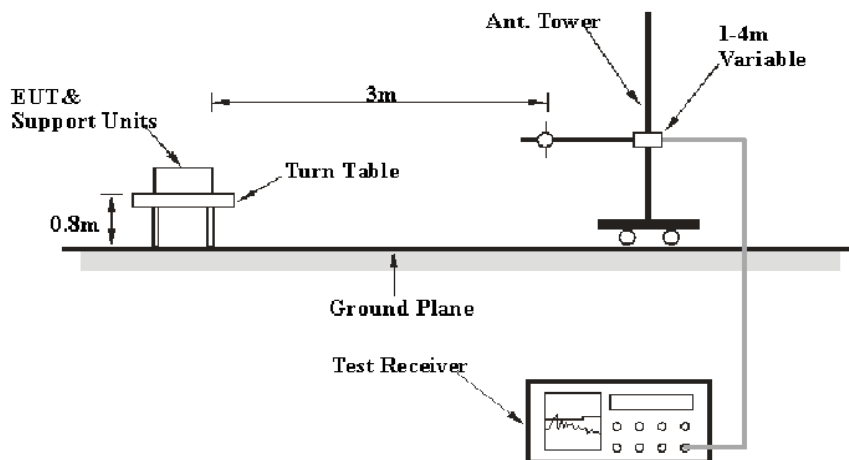

Above 1GHz:

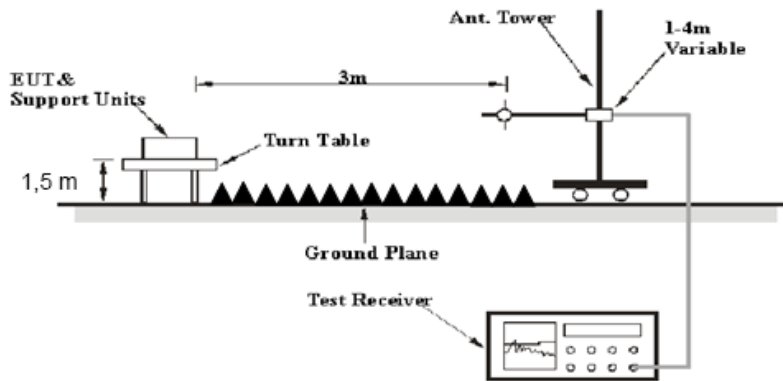

The radiated emissions were performed in the 3 meters distance, using the setup accordance with the ANSI C63.10-2013. The specification used was the FCC 15.209, and FCC 15.247 limits.

The external I/O cables were draped along the test table and formed a bundle 30 to 40 cm long in the middle.

The spacing between the peripherals was 10 cm.

For 9kHz-30MHz test, the lowest height of the magnetic antenna shall be 1 m above the ground and three antenna orientations (parallel, perpendicular, and ground-parallel) shall be measured.

3.2.3 EMI Test Receiver & Spectrum Analyzer Setup

The system was investigated from 9kHz to 25 GHz.

During the radiated emission test, the EMI test receiver & Spectrum Analyzer Setup were set with the following configurations:

9kHz-1000MHz:

Frequency Range	RBW	Video B/W	IF B/W	Measurement
9 kHz – 150 kHz	200 Hz	1 kHz	/	PK
	/	/	200 Hz	QP/AV
150 kHz – 30 MHz	9 kHz	30 kHz	/	PK
	/	/	9 kHz	QP/AV
30 MHz – 1000 MHz	100 kHz	300 kHz	/	PK
	/	/	120 kHz	QP

1GHz- 25GHz:

Measurement	Duty cycle	RBW	Video B/W
PK	Any	1MHz	3 MHz
AV	>98%	1MHz	10 Hz
	<98%	1MHz	≥1/T

Note: T is minimum transmission duration

If the maximized peak measured value complies with under the QP/Average limit more than 6dB, then it is unnecessary to perform an QP/Average measurement.

3.2.4 Test Procedure

Maximizing procedure was performed on the highest emissions to ensure that the EUT complied with all installation combinations.

Data was recorded in Quasi-peak detection mode for frequency range of 9 kHz-1 GHz except 9 - 90 kHz, 110 - 490 kHz, employing an average detector, peak and Average detection modes for frequencies above 1 GHz.

All emissions under the average limit and under the noise floor have not recorded in the report.

3.2.5 Corrected Amplitude & Margin Calculation

The basic equation is as follows:

Result = Reading + Factor

Factor = Antenna Factor + Cable Loss- Amplifier Gain

The “**Margin**” column of the following data tables indicates the degree of compliance within the applicable limit. The equation for margin calculation is as follows:

Margin = Limit – Result

3.3 Minimum 6 dB Bandwidth:

3.3.1 Applicable Standard

FCC §15.247 (a)(2)

Systems using digital modulation techniques may operate in the 902-928 MHz, 2400-2483.5 MHz, and 5725-5850 MHz bands. The minimum 6 dB bandwidth shall be at least 500 kHz.

3.3.2 EUT Setup

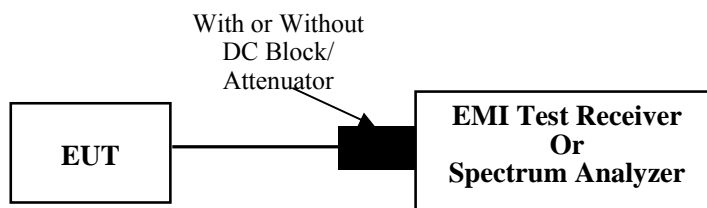

3.3.3 Test Procedure

According to ANSI C63.10-2013 Section 11.8

- a) Set RBW = 100 kHz.
- b) Set the video bandwidth (VBW) $\geq 3 \times$ RBW.
- c) Detector = Peak.
- d) Trace mode = max hold.
- e) Sweep = auto couple.
- f) Allow the trace to stabilize.
- g) Measure the maximum width of the emission that is constrained by the frequencies associated with the two outermost amplitude points (upper and lower frequencies) that are attenuated by 6 dB relative to the maximum level measured in the fundamental emission.

3.4 99% Occupied Bandwidth:

3.4.1 EUT Setup

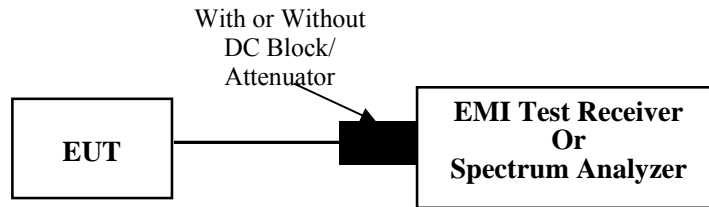

3.4.2 Test Procedure

According to ANSI C63.10-2013 Section 6.9.3

The occupied bandwidth is the frequency bandwidth such that, below its lower and above its upper frequency limits, the mean powers are each equal to 0.5% of the total mean power of the given emission. The following procedure shall be used for measuring 99% power bandwidth:

- a) The instrument center frequency is set to the nominal EUT channel center frequency. The frequency span for the spectrum analyzer shall be between 1.5 times and 5.0 times the OBW.
- b) The nominal IF filter bandwidth (3 dB RBW) shall be in the range of 1% to 5% of the OBW, and VBW shall be approximately three times the RBW, unless otherwise specified by the applicable requirement.
- c) Set the reference level of the instrument as required, keeping the signal from exceeding the maximum input mixer level for linear operation. In general, the peak of the spectral envelope shall be more than $[10 \log (OBW/RBW)]$ below the reference level. Specific guidance is given in 4.1.5.2.
- d) Step a) through step c) might require iteration to adjust within the specified range.
- e) Video averaging is not permitted. Where practical, a sample detection and single sweep mode shall be used. Otherwise, peak detection and max hold mode (until the trace stabilizes) shall be used.
- f) Use the 99% power bandwidth function of the instrument (if available) and report the measured bandwidth.
- g) If the instrument does not have a 99% power bandwidth function, then the trace data points are recovered and directly summed in linear power terms. The recovered amplitude data points, beginning at the lowest frequency, are placed in a running sum until 0.5% of the total is reached; that frequency is recorded as the lower frequency. The process is repeated until 99.5% of the total is reached; that frequency is recorded as the upper frequency. The 99% power bandwidth is the difference between these two frequencies.
- h) The occupied bandwidth shall be reported by providing plot(s) of the measuring instrument display; the plot axes and the scale units per division shall be clearly labeled. Tabular data may be reported in addition to the plot(s).

3.5 Maximum Conducted Output Power:

3.5.1 Applicable Standard

FCC §15.247 (b)(3)

For systems using digital modulation in the 902-928 MHz, 2400-2483.5 MHz, and 5725-5850 MHz bands: 1 Watt. As an alternative to a peak power measurement, compliance with the one Watt limit can be based on a measurement of the maximum conducted output power. Maximum Conducted Output Power is defined as the total transmit power delivered to all antennas and antenna elements averaged across all symbols in the signaling alphabet when the transmitter is operating at its maximum power control level. Power must be summed across all antennas and antenna elements. The average must not include any time intervals during which the transmitter is off or is transmitting at a reduced power level. If multiple modes of operation are possible (e.g., alternative modulation methods), the maximum conducted output power is the highest total transmit power occurring in any mode.

3.5.2 EUT Setup

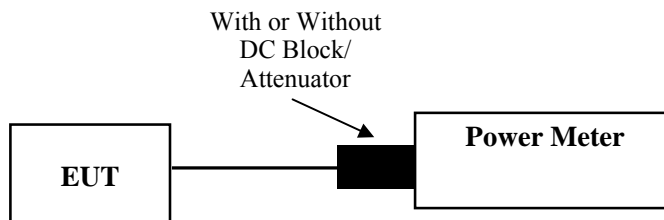

3.5.3 Test Procedure

According to ANSI C63.10-2013 Section 11.9.2.3.2

Method AVGPM-G is a measurement using a gated RF average power meter.

Alternatively, measurements may be performed using a wideband gated RF power meter provided that the gate parameters are adjusted such that the power is measured only when the EUT is transmitting at its maximum power control level. Because the measurement is made only during the ON time of the transmitter, no duty cycle correction factor is required.

According to ANSI C63.10-2013 Section 11.9.1.3

The maximum peak conducted output power may be measured using a broadband peak RF power meter. The power meter shall have a video bandwidth that is greater than or equal to the DTS bandwidth and shall use a fast-responding diode detector.

- a) Set the EUT in transmitting mode.
- b) Remove the antenna from the EUT and then connect a low loss RF cable from the antenna port to test equipment.
- c) Add a correction factor to the display.
- d) Set the power meter to test peak output power, record the result.

3.6 Maximum Power Spectral Density:

3.6.1 Applicable Standard

FCC §15.247 (e)

For digitally modulated systems, the power spectral density conducted from the intentional radiator to the antenna shall not be greater than 8 dBm in any 3 kHz band during any time interval of continuous transmission. This power spectral density shall be determined in accordance with the provisions of paragraph (b) of this section. The same method of determining the conducted output power shall be used to determine the power spectral density.

3.6.2 EUT Setup

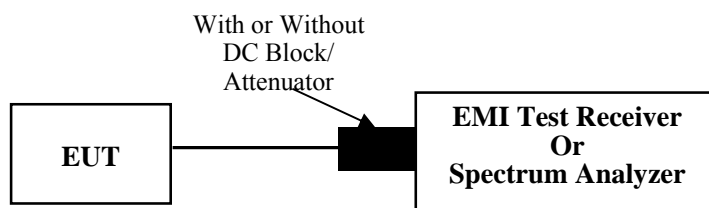

3.6.3 Test Procedure

According to ANSI C63.10-2013 Section 11.10.2

- a) Set analyzer center frequency to DTS channel center frequency.
- b) Set the span to 1.5 times the DTS bandwidth.
- c) Set the RBW to $3 \text{ kHz} \leq \text{RBW} \leq 100 \text{ kHz}$.
- d) Set the VBW $\geq [3 \cdot \text{RBW}]$.
- e) Detector = peak.
- f) Sweep time = auto couple.
- g) Trace mode = max hold.
- h) Allow trace to fully stabilize.
- i) Use the peak marker function to determine the maximum amplitude level within the RBW.
- j) If measured value exceeds requirement, then reduce RBW (but no less than 3 kHz) and repeat.

3.7 100 kHz Bandwidth of Frequency Band Edge:

3.7.1 Applicable Standard

FCC §15.247 (d);

In any 100 kHz bandwidth outside the frequency band in which the spread spectrum or digitally modulated intentional radiator is operating, the radio frequency power that is produced by the intentional radiator shall be at least 20 dB below that in the 100 kHz bandwidth within the band that contains the highest level of the desired power, based on either an RF conducted or a radiated measurement, provided the transmitter demonstrates compliance with the peak conducted power limits. If the transmitter complies with the conducted power limits based on the use of RMS averaging over a time interval, as permitted under paragraph (b)(3) of this section, the attenuation required under this paragraph shall be 30 dB instead of 20 dB. Attenuation below the general limits specified in §15.209(a) is not required. In addition, radiated emissions which fall in the restricted bands, as defined in §15.205(a), must also comply with the radiated emission limits specified in §15.209(a) (see §15.205(c)).

3.7.2 EUT Setup

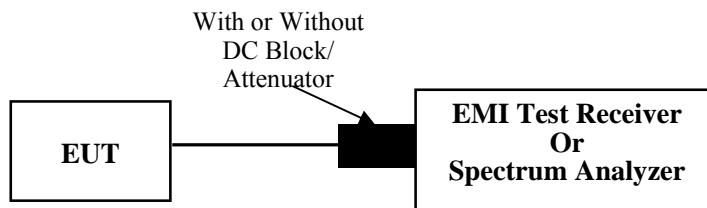

3.7.3 Test Procedure

According to ANSI C63.10-2013 Section 11.11

- a) Set the center frequency and span to encompass frequency range to be measured.
- b) Set the RBW = 100 kHz.
- c) Set the VBW $\geq [3 \times \text{RBW}]$.
- d) Detector = peak.
- e) Sweep time = auto couple.
- f) Trace mode = max hold.
- g) Allow trace to fully stabilize.
- h) Use the peak marker function to determine the maximum amplitude level.

Ensure that the amplitude of all unwanted emissions outside of the authorized frequency band (excluding restricted frequency bands) is attenuated by at least the minimum requirements specified in 11.11. Report the three highest emissions relative to the limit.

3.8 Duty Cycle:

3.8.1 EUT Setup

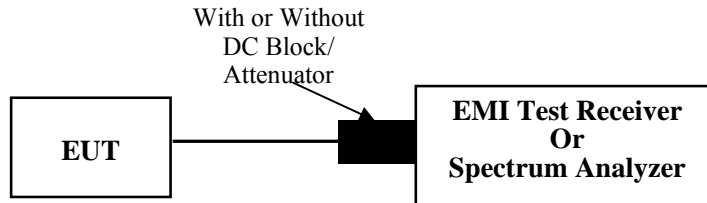

3.8.2 Test Procedure

According to ANSI C63.10-2013 Section 11.6

The zero-span mode on a spectrum analyzer or EMI receiver if the response time and spacing between bins on the sweep are sufficient to permit accurate measurements of the ON and OFF times of the transmitted signal:

- 1) Set the center frequency of the instrument to the center frequency of the transmission.
- 2) Set $RBW \geq OBW$ if possible; otherwise, set RBW to the largest available value.
- 3) Set $VBW \geq RBW$. Set detector = peak or average.
- 4) The zero-span measurement method shall not be used unless both RBW and VBW are $> 50/T$ and the number of sweep points across duration T exceeds 100. (For example, if VBW and/or RBW are limited to 3 MHz, then the zero-span method of measuring the duty cycle shall not be used if $T \leq 16.7 \mu s$.)

3.9 Antenna Requirement

3.9.1 Applicable Standard

FCC §15.203

An intentional radiator shall be designed to ensure that no antenna other than that furnished by the responsible party shall be used with the device. The use of a permanently attached antenna or of an antenna that uses a unique coupling to the intentional radiator shall be considered sufficient to comply with the provisions of this section. The manufacturer may design the unit so that a broken antenna can be replaced by the user, but the use of a standard antenna jack or electrical connector is prohibited. This requirement does not apply to carrier current devices or to devices operated under the provisions of §§15.211, 15.213, 15.217, 15.219, 15.221, or §15.236. Further, this requirement does not apply to intentional radiators that must be professionally installed, such as perimeter protection systems and some field disturbance sensors, or to other intentional radiators which, in accordance with §15.31(d), must be measured at the installation site. However, the installer shall be responsible for ensuring that the proper antenna is employed so that the limits in this part are not exceeded.

3.9.2 Judgment

Compliant. Please refer to the Antenna Information detail in Section 1.

4. Test DATA AND RESULTS

4.1 AC Line Conducted Emissions

Serial Number:	2DS2-2	Test Date:	2023/12/14
Test Site:	CE	Test Mode:	Transmitting(maximum output power mode, 802.11g middle channel)
Tester:	David Huang	Test Result:	Pass

Environmental Conditions:

Temperature: (°C)	27.7	Relative Humidity: (%)	49	ATM Pressure: (kPa)	101.4
----------------------	------	---------------------------	----	------------------------	-------

Test Equipment List and Details:

Manufacturer	Description	Model	Serial Number	Calibration Date	Calibration Due Date
R&S	LISN	ENV216	101134	2023/3/31	2024/3/30
R&S	EMI Test Receiver	ESR3	102726	2023/3/31	2024/3/30
MICRO-COAX	Coaxial Cable	UTIFLEX	C-0200-01	2023/8/6	2024/8/5
Audix	Test Software	E3	190306 (V9)	N/A	N/A

* Statement of Traceability: China Certification ICT Co., Ltd (Dongguan) attests that all calibrations have been performed, traceable to National Primary Standards and International System of Units (SI).

Project No.: CR231167748-RF
 Tester: David Huang
 Port: Line
 Note: POE 2.4G WIFI

Date: 2023-12-14

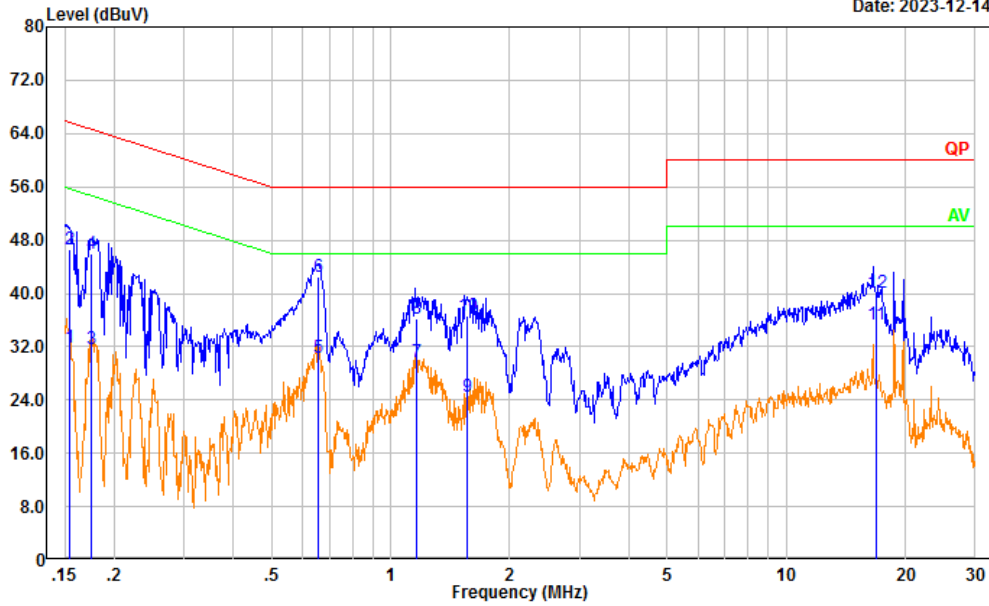

No.	Frequency (MHz)	Reading (dBμV)	Factor (dB)	Result (dBμV)	Limit (dBμV)	Margin (dB)	Detector
1	0.155	22.21	9.61	31.82	55.75	23.93	Average
2	0.155	36.91	9.61	46.52	65.75	19.23	QP
3	0.175	21.98	9.61	31.59	54.70	23.11	Average
4	0.175	36.30	9.61	45.91	64.70	18.79	QP
5	0.654	20.76	9.62	30.38	46.00	15.62	Average
6	0.654	32.87	9.62	42.49	56.00	13.51	QP
7	1.165	20.05	9.62	29.67	46.00	16.33	Average
8	1.165	26.64	9.62	36.26	56.00	19.74	QP
9	1.564	14.80	9.63	24.43	46.00	21.57	Average
10	1.564	27.06	9.63	36.69	56.00	19.31	QP
11	16.894	25.66	9.73	35.39	50.00	14.61	Average
12	16.894	30.42	9.73	40.15	60.00	19.85	QP

Project No.: CR231167748-RF
 Tester: David Huang
 Port: neutral
 Note: POE 2.4G WIFI

Date: 2023-12-14

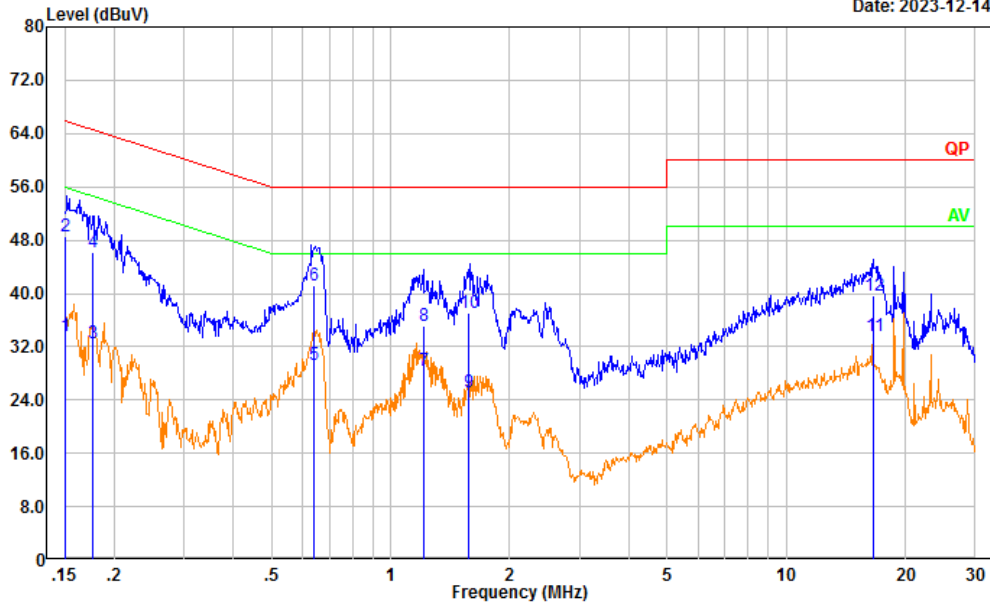

No.	Frequency (MHz)	Reading (dBμV)	Factor (dB)	Result (dBμV)	Limit (dBμV)	Margin (dB)	Detector
1	0.150	23.95	9.61	33.56	55.98	22.42	Average
2	0.150	38.88	9.61	48.49	65.98	17.49	QP
3	0.176	22.93	9.61	32.54	54.67	22.13	Average
4	0.176	36.48	9.61	46.09	64.67	18.58	QP
5	0.638	19.61	9.62	29.23	46.00	16.77	Average
6	0.638	31.65	9.62	41.27	56.00	14.73	QP
7	1.210	18.77	9.62	28.39	46.00	17.61	Average
8	1.210	25.40	9.62	35.02	56.00	20.98	QP
9	1.577	15.50	9.63	25.13	46.00	20.87	Average
10	1.577	27.34	9.63	36.97	56.00	19.03	QP
11	16.633	23.94	9.69	33.63	50.00	16.37	Average
12	16.633	30.00	9.69	39.69	60.00	20.31	QP

4.2 Radiation Spurious Emissions

Serial Number:	2DS2-2	Test Date:	2023/12/21~2024/1/5
Test Site:	966-2,966-1	Test Mode:	Transmitting
Tester:	Jeff Luo, Tao Zhu	Test Result:	Pass

Environmental Conditions:

Temperature: (°C)	24~26.1	Relative Humidity: (%)	35~63	ATM Pressure: (kPa)	101.4~102.1
-------------------	---------	------------------------	-------	---------------------	-------------

Test Equipment List and Details:

Manufacturer	Description	Model	Serial Number	Calibration Date	Calibration Due Date
Radiation Spurious Emissions Below 1GHz					
Sunol Sciences	Antenna	JB6	A082520-6	2023/9/18	2026/9/17
BACL	Loop Antenna	1313-1P	3092721	2023/10/20	2026/10/19
R&S	EMI Test Receiver	ESR3	102724	2023/3/31	2024/3/30
TIMES MICROWAVE	Coaxial Cable	LMR-600-UltraFlex	C-0470-02	2023/7/16	2024/7/15
TIMES MICROWAVE	Coaxial Cable	LMR-600-UltraFlex	C-0780-01	2023/7/16	2024/7/15
Sonoma	Amplifier	310N	186165	2023/7/16	2024/7/15
Audix	Test Software	E3	201021 (V9)	N/A	N/A
Radiation Spurious Emissions Above 1GHz					
AH	Double Ridge Guide Horn Antenna	SAS-571	1394	2023/2/22	2026/2/21
R&S	Spectrum Analyzer	FSV40	101591	2023/3/31	2024/3/30
MICRO-COAX	Coaxial Cable	UFA210A-1-1200-70U300	217423-008	2023/8/6	2024/8/5
MICRO-COAX	Coaxial Cable	UFA210A-1-2362-300300	235780-001	2023/8/6	2024/8/5
Mini	Pre-amplifier	ZVA-183-S+	5969001149	2023/11/8	2024/11/7
Audix	Test Software	E3	201021 (V9)	N/A	N/A
PASTERNAK	Horn Antenna	PE9852/2F-20	112002	2024/2/4	2025/2/5
Quinstar	Preamplifier	QLW-18405536-JO	15964001005	2023/9/15	2024/9/14
MICRO-COAX	Coaxial Cable	UFB142A-1-2362-200200	235772-001	2023/8/6	2024/8/5
E-Microwave	Band Rejection Filter	2400-2483.5MHz	OE01902424	2023/8/6	2024/8/5
Mini Circuits	High Pass Filter	VHF-6010+	31119	2023/8/6	2024/8/5

* Statement of Traceability: China Certification ICT Co., Ltd (Dongguan) attests that all calibrations have been performed, traceable to National Primary Standards and International System of Units (SI).

Test Data:

Please refer to the below table and plots.

After pre-scan in the X, Y and Z axes of orientation, the worst case is below:

1) 9kHz~30MHz

The amplitude of spurious emissions attenuated more than 20 dB below the permissible value is not required to be report.

2) 30MHz-1GHz (Tested at Maximum Output Power Mode: 802.11g)

POE:

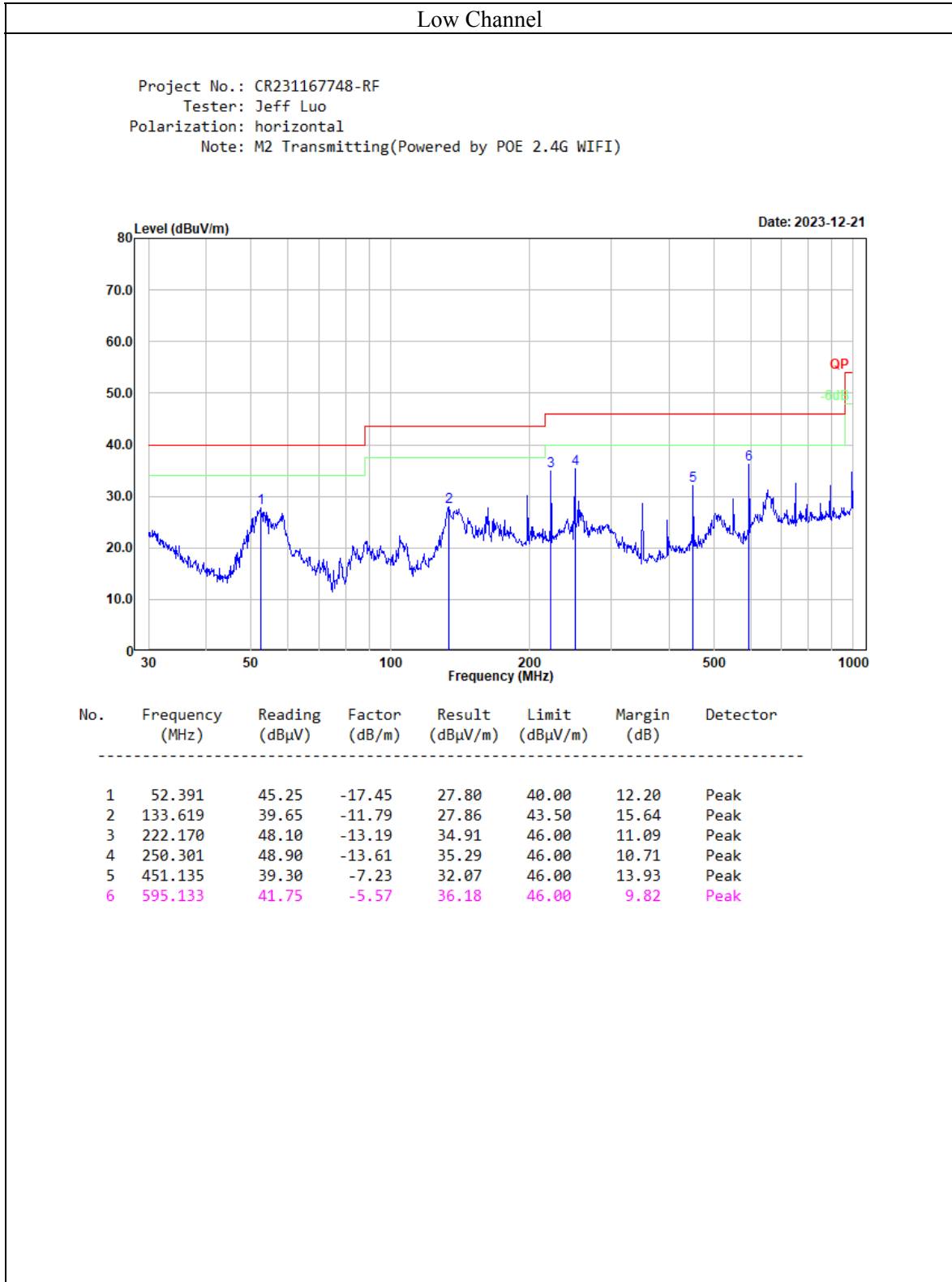

Project No.: CR231167748-RF
 Tester: Jeff Luo
 Polarization: vertical
 Note: M2 Transmitting(Powered by POE 2.4G WIFI)

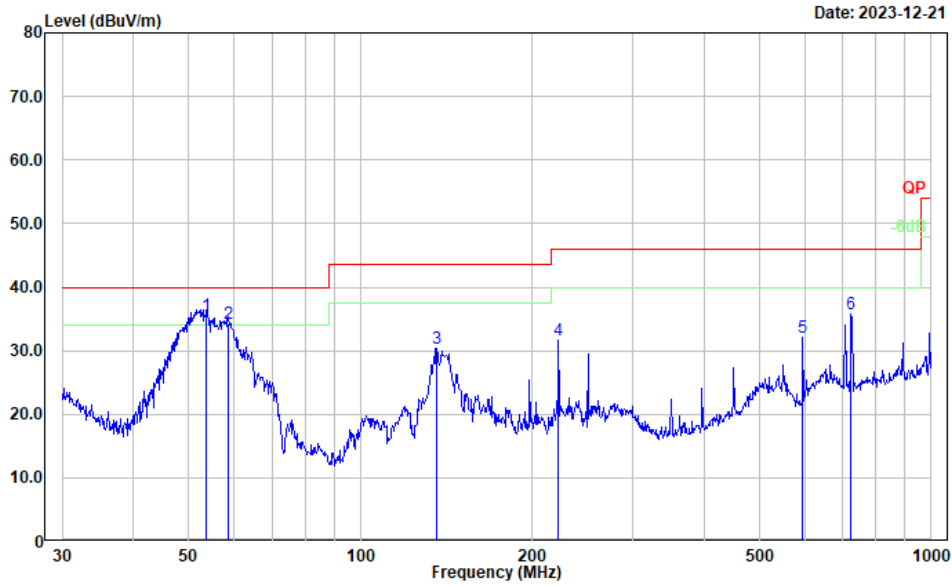

No.	Frequency (MHz)	Reading (dBμV)	Factor (dB/m)	Result (dBμV/m)	Limit (dBμV/m)	Margin (dB)	Detector
1	53.693	52.99	-17.48	35.51	40.00	4.49	QP
2	58.613	51.88	-17.61	34.27	40.00	5.73	QP
3	135.982	42.27	-11.87	30.40	43.50	13.10	Peak
4	222.170	44.76	-13.19	31.57	46.00	14.43	Peak
5	595.133	37.65	-5.57	32.08	46.00	13.92	Peak
6	724.261	39.37	-3.62	35.75	46.00	10.25	Peak

Middle Channel

Project No.: CR231167748-RF
 Tester: Jeff Luo
 Polarization: horizontal
 Note: M2 Transmitting(Powered by POE 2.4G WIFI)

Date: 2023-12-21

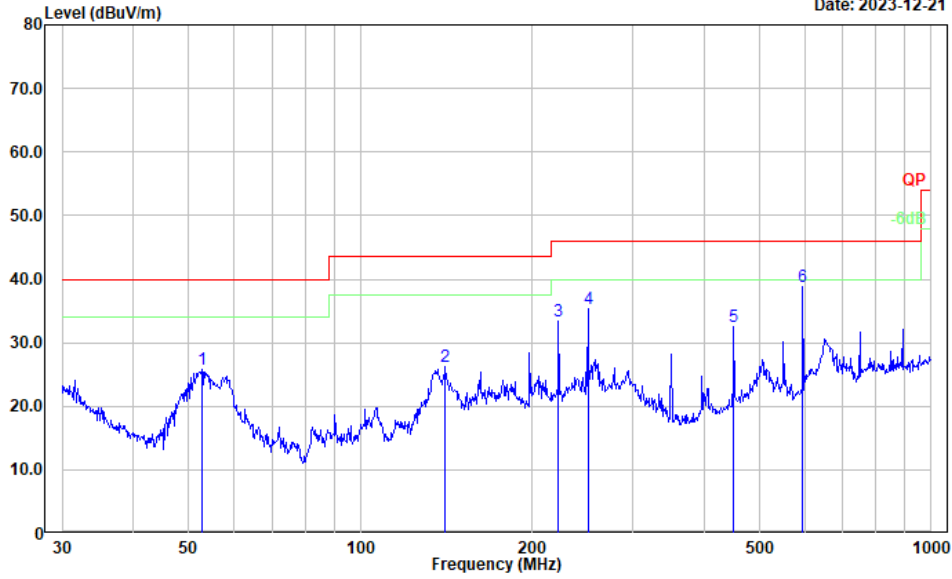

No.	Frequency (MHz)	Reading (dBμV)	Factor (dB/m)	Result (dBμV/m)	Limit (dBμV/m)	Margin (dB)	Detector
1	52.760	43.16	-17.45	25.71	40.00	14.29	Peak
2	140.835	38.29	-12.12	26.17	43.50	17.33	Peak
3	222.170	46.60	-13.19	33.41	46.00	12.59	Peak
4	250.301	48.91	-13.61	35.30	46.00	10.70	Peak
5	451.135	39.83	-7.23	32.60	46.00	13.40	Peak
6	595.133	44.31	-5.57	38.74	46.00	7.26	Peak

Project No.: CR231167748-RF
 Tester: Jeff Luo
 Polarization: vertical
 Note: M2 Transmitting(Powered by POE 2.4G WIFI)

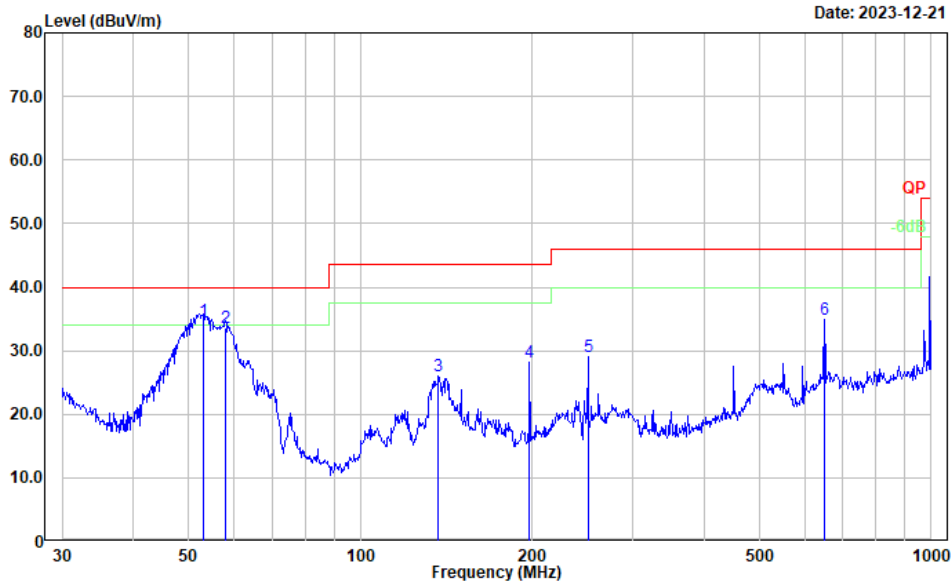

No.	Frequency (MHz)	Reading (dBμV)	Factor (dB/m)	Result (dBμV/m)	Limit (dBμV/m)	Margin (dB)	Detector
1	52.945	52.23	-17.46	34.77	40.00	5.23	QP
2	57.999	51.25	-17.57	33.68	40.00	6.32	QP
3	136.939	37.90	-11.92	25.98	43.50	17.52	Peak
4	197.893	41.05	-12.82	28.23	43.50	15.27	Peak
5	250.301	42.58	-13.61	28.97	46.00	17.03	Peak
6	649.660	39.69	-4.80	34.89	46.00	11.11	Peak

High Channel

Project No.: CR231167748-RF
 Tester: Jeff Luo
 Polarization: horizontal
 Note: M2 Transmitting(Powered by POE 2.4G WIFI)

Date: 2023-12-21

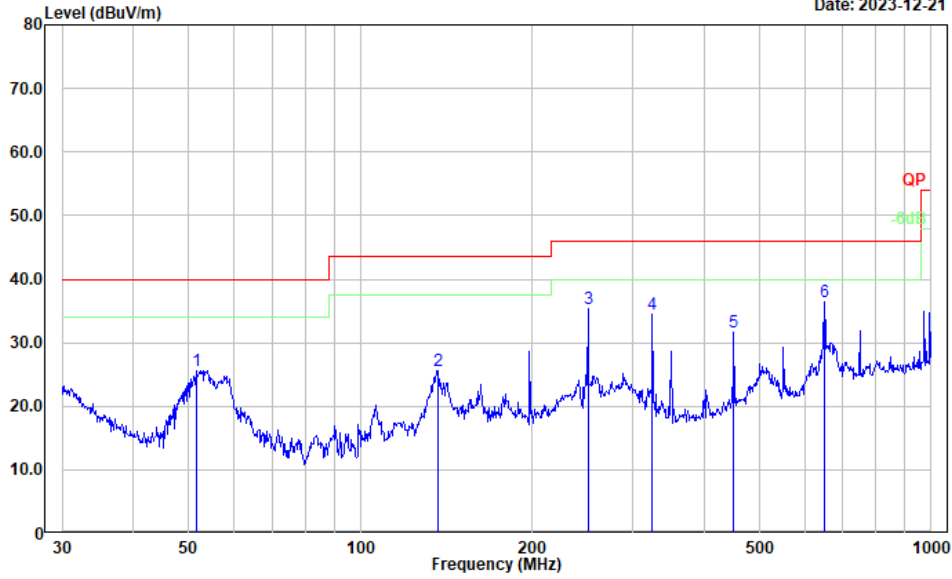

No.	Frequency (MHz)	Reading (dBuV)	Factor (dB/m)	Result (dBuV/m)	Limit (dBuV/m)	Margin (dB)	Detector
1	51.481	43.07	-17.44	25.63	40.00	14.37	Peak
2	136.939	37.60	-11.92	25.68	43.50	17.82	Peak
3	250.301	49.03	-13.61	35.42	46.00	10.58	Peak
4	324.456	45.21	-10.73	34.48	46.00	11.52	Peak
5	451.135	38.93	-7.23	31.70	46.00	14.30	Peak
6	649.660	41.30	-4.80	36.50	46.00	9.50	Peak

Project No.: CR231167748-RF
 Tester: Jeff Luo
 Polarization: vertical
 Note: M2 Transmitting(Powered by POE 2.4G WIFI)

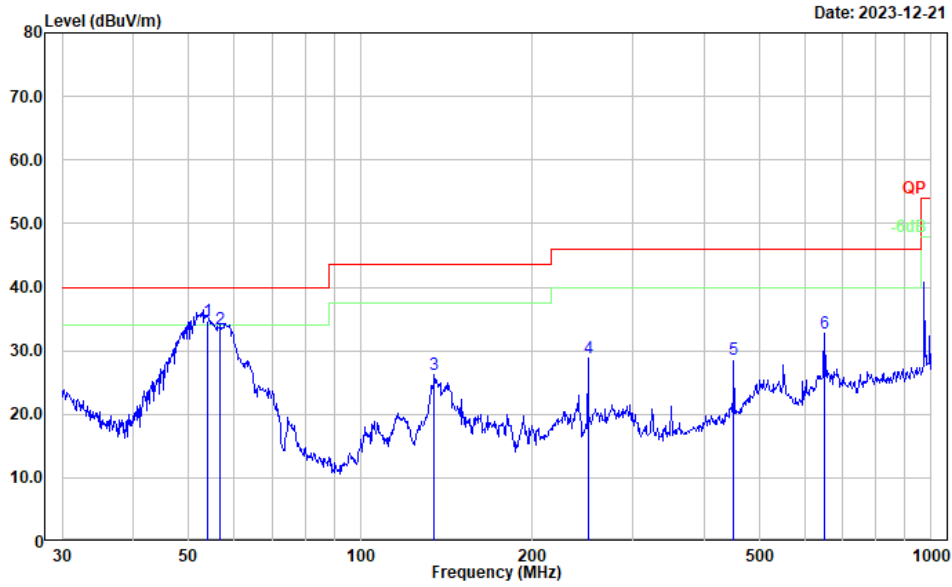

No.	Frequency (MHz)	Reading (dBμV)	Factor (dB/m)	Result (dBμV/m)	Limit (dBμV/m)	Margin (dB)	Detector
1	53.859	52.18	-17.49	34.69	40.00	5.31	QP
2	56.792	50.85	-17.54	33.31	40.00	6.69	QP
3	134.559	38.09	-11.81	26.28	43.50	17.22	Peak
4	250.301	42.40	-13.61	28.79	46.00	17.21	Peak
5	451.135	35.74	-7.23	28.51	46.00	17.49	Peak
6	649.660	37.50	-4.80	32.70	46.00	13.30	Peak

3) 1-25GHz:
802.11b Mode

Frequency (MHz)	Receiver		Polar (H/V)	Factor (dB/m)	Result (dB μ V/m)	Limit (dB μ V/m)	Margin (dB)
	Reading (dB μ V)	Detector					
Low Channel: 2412 MHz							
2390.000	27.77	PK	H	31.71	59.48	74.00	14.52
2390.000	14.72	AV	H	31.71	46.43	54.00	7.57
2390.000	28.94	PK	V	31.71	60.65	74.00	13.35
2390.000	15.98	AV	V	31.71	47.69	54.00	6.31
4824.000	38.66	PK	H	11.26	49.92	74.00	24.08
4824.000	25.74	AV	H	11.26	37.00	54.00	17.00
4824.000	40.14	PK	V	11.26	51.40	74.00	22.60
4824.000	27.69	AV	V	11.26	38.95	54.00	15.05
7236.000	34.28	PK	H	15.24	49.52	74.00	24.48
7236.000	21.47	AV	H	15.24	36.71	54.00	17.29
7236.000	35.38	PK	V	15.24	50.62	74.00	23.38
7236.000	22.57	AV	V	15.24	37.81	54.00	16.19
Middle Channel: 2437 MHz							
4874.000	37.74	PK	H	11.45	49.19	74.00	24.81
4874.000	24.53	AV	H	11.45	35.98	54.00	18.02
4874.000	39.85	PK	V	11.45	51.30	74.00	22.70
4874.000	26.64	AV	V	11.45	38.09	54.00	15.91
7311.000	34.22	PK	H	15.58	49.80	74.00	24.20
7311.000	21.26	AV	H	15.58	36.84	54.00	17.16
7311.000	35.66	PK	V	15.58	51.24	74.00	22.76
7311.000	22.42	AV	V	15.58	38.00	54.00	16.00
High Channel: 2462 MHz							
2483.500	28.66	PK	H	32.19	60.85	74.00	13.15
2483.500	14.76	AV	H	32.19	46.95	54.00	7.05
2483.500	29.12	PK	V	32.19	61.31	74.00	12.69
2483.500	16.20	AV	V	32.19	48.39	54.00	5.61
4924.000	37.82	PK	H	11.67	49.49	74.00	24.51
4924.000	24.59	AV	H	11.67	36.26	54.00	17.74
4924.000	39.88	PK	V	11.67	51.55	74.00	22.45
4924.000	26.68	AV	V	11.67	38.35	54.00	15.65
7386.000	34.15	PK	H	15.63	49.78	74.00	24.22
7386.000	21.20	AV	H	15.63	36.83	54.00	17.17
7386.000	35.71	PK	V	15.63	51.34	74.00	22.66
7386.000	22.32	AV	V	15.63	37.95	54.00	16.05

802.11g Mode

Frequency (MHz)	Receiver		Polar (H/V)	Factor (dB/m)	Result (dB μ V/m)	Limit (dB μ V/m)	Margin (dB)
	Reading (dB μ V)	Detector					
Low Channel: 2412 MHz							
2390.000	35.88	PK	H	31.71	67.59	74.00	6.41
2390.000	19.69	AV	H	31.71	51.40	54.00	2.60
2390.000	36.88	PK	V	31.71	68.59	74.00	5.41
2390.000	21.32	AV	V	31.71	53.03	54.00	0.97
4824.000	35.69	PK	H	11.26	46.95	74.00	27.05
4824.000	22.17	AV	H	11.26	33.43	54.00	20.57
4824.000	36.20	PK	V	11.26	47.46	74.00	26.54
4824.000	23.25	AV	V	11.26	34.51	54.00	19.49
7236.000	34.69	PK	H	15.24	49.93	74.00	24.07
7236.000	21.57	AV	H	15.24	36.81	54.00	17.19
7236.000	35.87	PK	V	15.24	51.11	74.00	22.89
7236.000	22.69	AV	V	15.24	37.93	54.00	16.07
Middle Channel: 2437 MHz							
4874.000	35.36	PK	H	11.45	46.81	74.00	27.19
4874.000	22.12	AV	H	11.45	33.57	54.00	20.43
4874.000	36.33	PK	V	11.45	47.78	74.00	26.22
4874.000	23.35	AV	V	11.45	34.80	54.00	19.20
7311.000	34.28	PK	H	15.58	49.86	74.00	24.14
7311.000	21.49	AV	H	15.58	37.07	54.00	16.93
7311.000	35.69	PK	V	15.58	51.27	74.00	22.73
7311.000	22.51	AV	V	15.58	38.09	54.00	15.91
High Channel: 2462 MHz							
2483.500	36.11	PK	H	32.19	68.30	74.00	5.70
2483.500	20.41	AV	H	32.19	52.60	54.00	1.40
2483.500	36.82	PK	V	32.19	69.01	74.00	4.99
2483.500	21.08	AV	V	32.19	53.27	54.00	0.73
4924.000	35.33	PK	H	11.67	47.00	74.00	27.00
4924.000	22.24	AV	H	11.67	33.91	54.00	20.09
4924.000	36.69	PK	V	11.67	48.36	74.00	25.64
4924.000	23.47	AV	V	11.67	35.14	54.00	18.86
7386.000	34.25	PK	H	15.63	49.88	74.00	24.12
7386.000	21.36	AV	H	15.63	36.99	54.00	17.01
7386.000	35.32	PK	V	15.63	50.95	74.00	23.05
7386.000	22.53	AV	V	15.63	38.16	54.00	15.84

802.11n ht20 Mode:

Frequency (MHz)	Receiver		Polar (H/V)	Factor (dB/m)	Result (dB μ V/m)	Limit (dB μ V/m)	Margin (dB)
	Reading (dB μ V)	Detector					
Low Channel: 2412 MHz							
2390.000	36.86	PK	H	31.71	68.57	74.00	5.43
2390.000	20.87	AV	H	31.71	52.58	54.00	1.42
2390.000	37.66	PK	V	31.71	69.37	74.00	4.63
2390.000	21.33	AV	V	31.71	53.04	54.00	0.96
4824.000	35.63	PK	H	11.26	46.89	74.00	27.11
4824.000	22.20	AV	H	11.26	33.46	54.00	20.54
4824.000	36.68	PK	V	11.26	47.94	74.00	26.06
4824.000	23.64	AV	V	11.26	34.90	54.00	19.10
7236.000	35.20	PK	H	15.24	50.44	74.00	23.56
7236.000	22.17	AV	H	15.24	37.41	54.00	16.59
7236.000	36.18	PK	V	15.24	51.42	74.00	22.58
7236.000	23.33	AV	V	15.24	38.57	54.00	15.43
Middle Channel: 2437 MHz							
4874.000	35.50	PK	H	11.45	46.95	74.00	27.05
4874.000	22.18	AV	H	11.45	33.63	54.00	20.37
4874.000	36.64	PK	V	11.45	48.09	74.00	25.91
4874.000	23.61	AV	V	11.45	35.06	54.00	18.94
7311.000	35.32	PK	H	15.58	50.90	74.00	23.10
7311.000	22.22	AV	H	15.58	37.80	54.00	16.20
7311.000	36.57	PK	V	15.58	52.15	74.00	21.85
7311.000	23.41	AV	V	15.58	38.99	54.00	15.01
High Channel: 2462 MHz							
2483.500	36.88	PK	H	32.19	69.07	74.00	4.93
2483.500	20.98	AV	H	32.19	53.17	54.00	0.83
2483.500	37.71	PK	V	32.19	69.90	74.00	4.10
2483.500	21.21	AV	V	32.19	53.40	54.00	0.60
4924.000	35.55	PK	H	11.67	47.22	74.00	26.78
4924.000	22.41	AV	H	11.67	34.08	54.00	19.92
4924.000	36.49	PK	V	11.67	48.16	74.00	25.84
4924.000	23.58	AV	V	11.67	35.25	54.00	18.75
7386.000	35.32	PK	H	15.63	50.95	74.00	23.05
7386.000	22.29	AV	H	15.63	37.92	54.00	16.08
7386.000	36.38	PK	V	15.63	52.01	74.00	21.99
7386.000	23.41	AV	V	15.63	39.04	54.00	14.96

802.11n ht40 Mode:

Frequency (MHz)	Receiver		Polar (H/V)	Factor (dB/m)	Result (dB μ V/m)	Limit (dB μ V/m)	Margin (dB)
	Reading (dB μ V)	Detector					
Low Channel:				2422	MHz		
2390.000	32.69	PK	H	31.71	64.40	74.00	9.60
2390.000	17.69	AV	H	31.71	49.40	54.00	4.60
2390.000	35.35	PK	V	31.71	67.06	74.00	6.94
2390.000	20.44	AV	V	31.71	52.15	54.00	1.85
4844.000	35.69	PK	H	11.31	47.00	74.00	27.00
4844.000	22.87	AV	H	11.31	34.18	54.00	19.82
4844.000	35.92	PK	V	11.31	47.23	74.00	26.77
4844.000	22.74	AV	V	11.31	34.05	54.00	19.95
7266.000	35.62	PK	H	15.43	51.05	74.00	22.95
7266.000	22.48	AV	H	15.43	37.91	54.00	16.09
7266.000	36.32	PK	V	15.43	51.75	74.00	22.25
7266.000	23.87	AV	V	15.43	39.30	54.00	14.70
Middle Channel:				2437	MHz		
4874.000	35.66	PK	H	11.45	47.11	74.00	26.89
4874.000	22.74	AV	H	11.45	34.19	54.00	19.81
4874.000	35.82	PK	V	11.45	47.27	74.00	26.73
4874.000	22.87	AV	V	11.45	34.32	54.00	19.68
7311.000	35.63	PK	H	15.58	51.21	74.00	22.79
7311.000	22.80	AV	H	15.58	38.38	54.00	15.62
7311.000	36.60	PK	V	15.58	52.18	74.00	21.82
7311.000	23.67	AV	V	15.58	39.25	54.00	14.75
				2452	MHz		
2483.500	30.52	PK	H	32.19	62.71	74.00	11.29
2483.500	15.39	AV	H	32.19	47.58	54.00	6.42
2483.500	33.53	PK	V	32.19	65.72	74.00	8.28
2483.500	16.25	AV	V	32.19	48.44	54.00	5.56
4904.000	35.84	PK	H	11.58	47.42	74.00	26.58
4904.000	22.52	AV	H	11.58	34.10	54.00	19.90
4904.000	36.20	PK	V	11.58	47.78	74.00	26.22
4904.000	22.92	AV	V	11.58	34.50	54.00	19.50
7356.000	35.45	PK	H	15.55	51.00	74.00	23.00
7356.000	22.51	AV	H	15.55	38.06	54.00	15.94
7356.000	36.58	PK	V	15.55	52.13	74.00	21.87
7356.000	23.28	AV	V	15.55	38.83	54.00	15.17

Worst Radiation Spurious Emissions Margin Test plots (802.11n ht40 low channel):

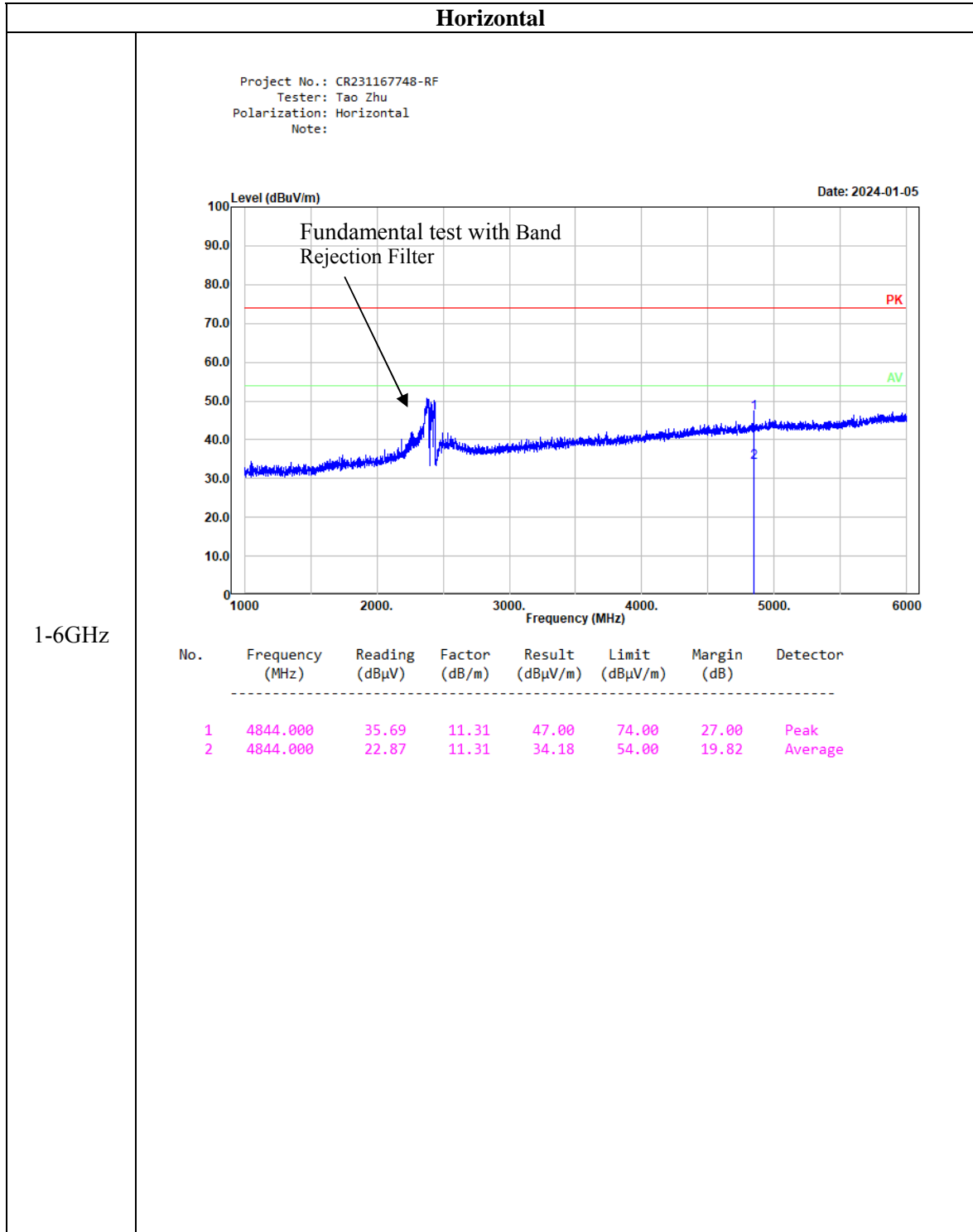

Horizontal

Project No.: CR231167748-RF
 Tester: Tao Zhu
 Polarization: Horizontal
 Note:

Date: 2024-01-05

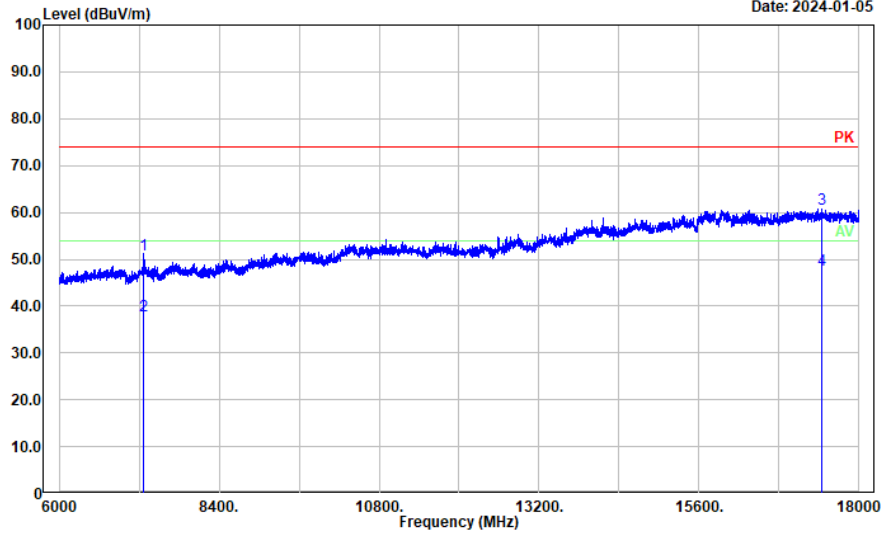

6-18GHz

No.	Frequency (MHz)	Reading (dBμV)	Factor (dB/m)	Result (dBμV/m)	Limit (dBμV/m)	Margin (dB)	Detector
1	7266.000	35.62	15.43	51.05	74.00	22.95	Peak
2	7266.000	22.48	15.43	37.91	54.00	16.09	Average
3	17436.000	30.98	29.80	60.78	74.00	13.22	Peak
4	17436.000	17.88	29.80	47.68	54.00	6.32	Average

Horizontal

Project No.: CR231167748-RF
 Tester: Tao Zhu
 Polarization: Horizontal
 Note:

Date: 2024-01-05

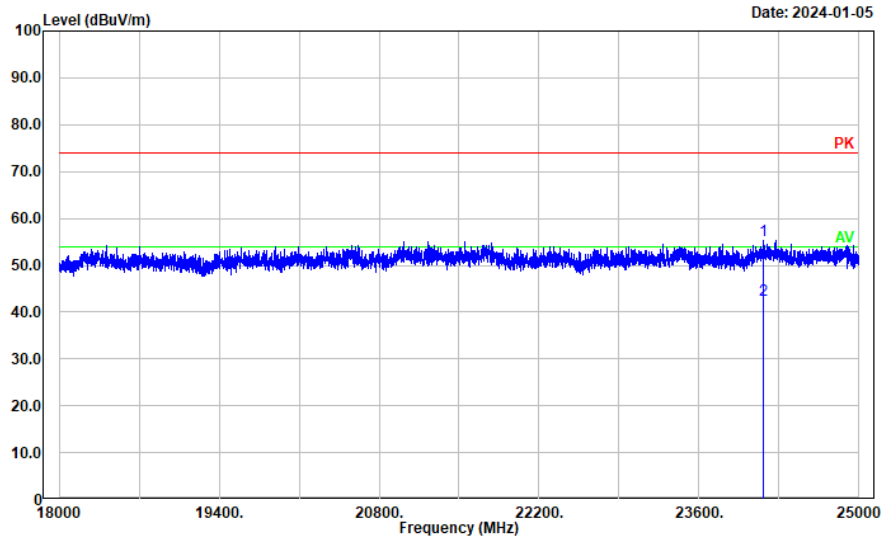

18-25GHz

No.	Frequency (MHz)	Reading (dBμV)	Factor (dB/m)	Result (dBμV/m)	Limit (dBμV/m)	Margin (dB)	Detector
1	24161.230	50.40	4.91	55.31	74.00	18.69	Peak
2	24161.230	37.74	4.91	42.65	54.00	11.35	Average

Vertical

Project No.: CR231167748-RF
 Tester: Tao Zhu
 Polarization: Vertical
 Note:

Date: 2024-01-05

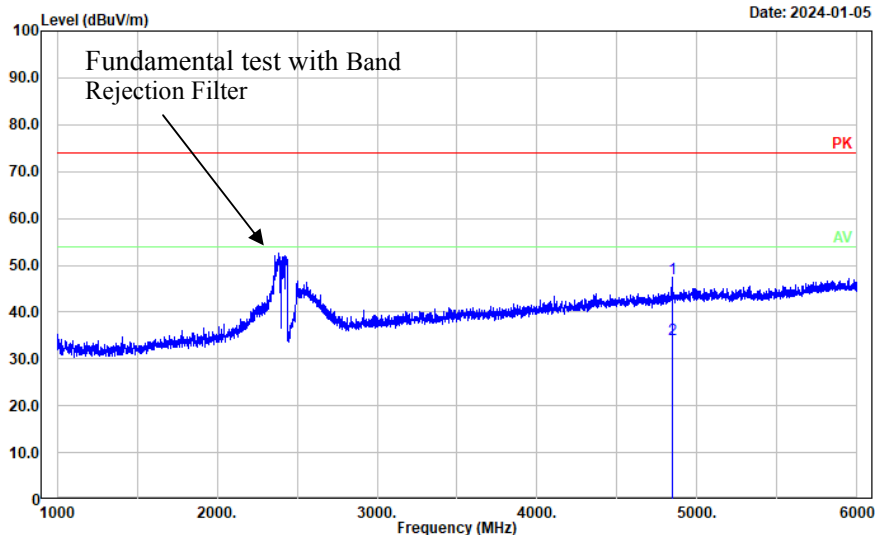

1-6GHz

No.	Frequency (MHz)	Reading (dBμV)	Factor (dB/m)	Result (dBμV/m)	Limit (dBμV/m)	Margin (dB)	Detector
1	4844.000	35.92	11.31	47.23	74.00	26.77	Peak
2	4844.000	22.74	11.31	34.05	54.00	19.95	Average

Vertical

Project No.: CR231167748-RF
 Tester: Tao Zhu
 Polarization: Vertical
 Note:

Date: 2024-01-05

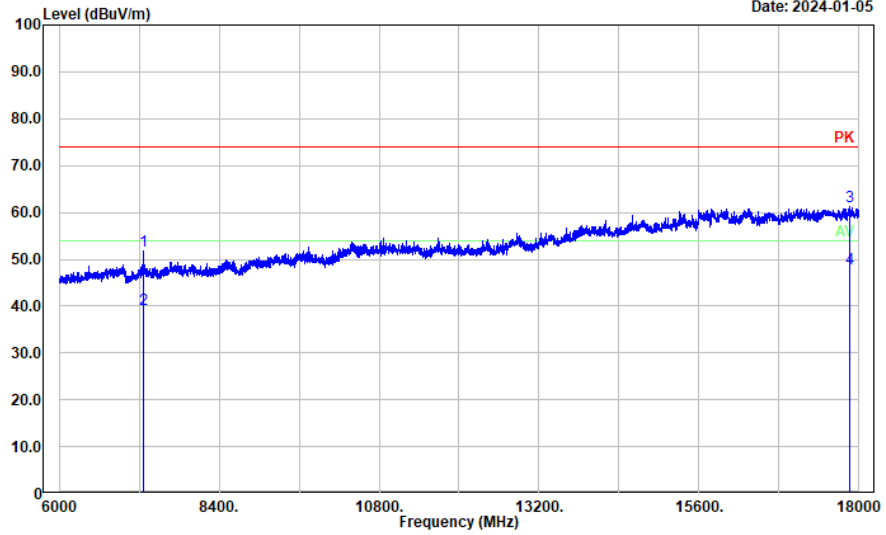

6-18GHz

No.	Frequency (MHz)	Reading (dBμV)	Factor (dB/m)	Result (dBμV/m)	Limit (dBμV/m)	Margin (dB)	Detector
1	7266.000	36.32	15.43	51.75	74.00	22.25	Peak
2	7266.000	23.87	15.43	39.30	54.00	14.70	Average
3	17863.200	29.16	31.98	61.14	74.00	12.86	Peak
4	17863.200	15.90	31.98	47.88	54.00	6.12	Average

Vertical

Project No.: CR231167748-RF
 Tester: Tao Zhu
 Polarization: Vertical
 Note:

Date: 2024-01-05

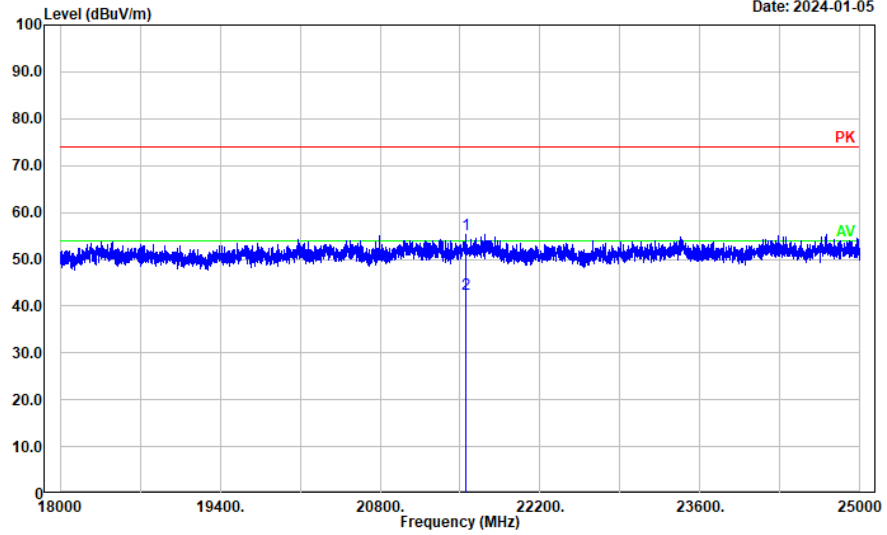

18-25GHz

No.	Frequency (MHz)	Reading (dBμV)	Factor (dB/m)	Result (dBμV/m)	Limit (dBμV/m)	Margin (dB)	Detector
1	21548.310	50.79	4.51	55.30	74.00	18.70	Peak
2	21548.310	38.17	4.51	42.68	54.00	11.32	Average

4.3 Minimum 6 dB Emission Bandwidth

Serial Number:	2DS2-1	Test Date:	2023/12/20
Test Site:	RF	Test Mode:	Transmitting
Tester:	Jou Zhou	Test Result:	Pass

Environmental Conditions:					
Temperature: (°C)	23.1	Relative Humidity: (%)	31	ATM Pressure: (kPa)	101.8

Test Equipment List and Details:

Manufacturer	Description	Model	Serial Number	Calibration Date	Calibration Due Date
R&S	Spectrum Analyzer	FSV40	101943	2023/3/31	2024/3/30
zhuoxiang	Coaxial Cable	SMA-178	211001	Each time	N/A
Mini-Circuits	DC Block	BLK-18-S+	1554403	Each time	N/A

* Statement of Traceability: China Certification ICT Co., Ltd (Dongguan) attests that all calibrations have been performed, traceable to National Primary Standards and International System of Units (SI).

Test Data:

Test Modes	Test Frequency (MHz)	6 dB Bandwidth (MHz)	Limit (MHz)
802.11b	2412	9.60	0.5
	2437	10.00	0.5
	2462	10.08	0.5
802.11g	2412	16.43	0.5
	2437	16.47	0.5
	2462	16.46	0.5
802.11n ht20	2412	17.59	0.5
	2437	17.52	0.5
	2462	17.60	0.5
802.11n ht40	2422	35.68	0.5
	2437	35.52	0.5
	2452	35.84	0.5

6dB Emission Bandwidth

802.11b
Lowest Channel

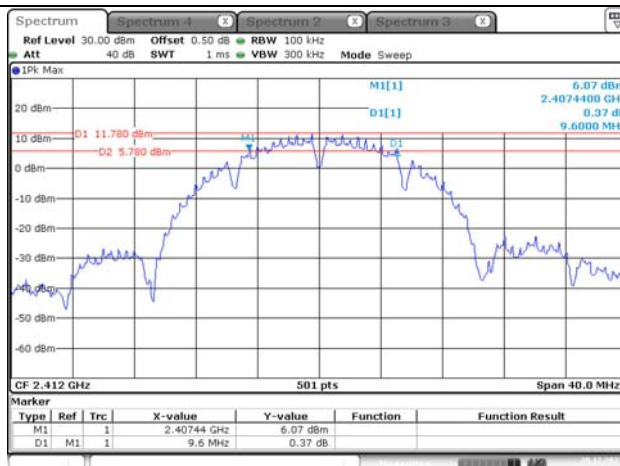

ProjectNo.:CR231167748 Testers:Jou Zhou
Date: 20.DEC.2023 13:54:40

802.11b
Middle Channel



ProjectNo.:CR231167748 Testers:Jou Zhou
Date: 20.DEC.2023 13:58:42

802.11b
Highest Channel

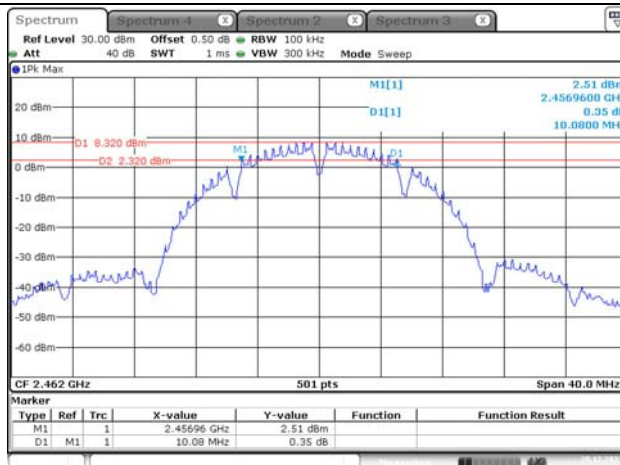

ProjectNo.:CR231167748 Testers:Jou Zhou
Date: 20.DEC.2023 14:09:40

6dB Emission Bandwidth

802.11g
Lowest Channel

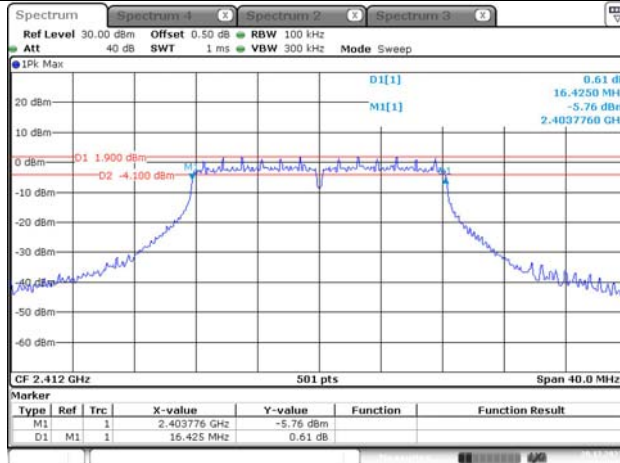

ProjectNo.:CR231167748 Testeri:Jou Zhou
Date: 20.DEC.2023 14:11:35

802.11g
Middle Channel

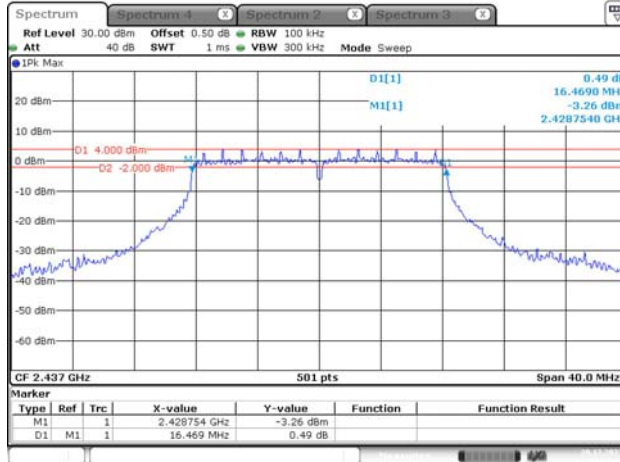

ProjectNo.:CR231167748 Testeri:Jou Zhou
Date: 20.DEC.2023 14:19:12

802.11g
Highest Channel

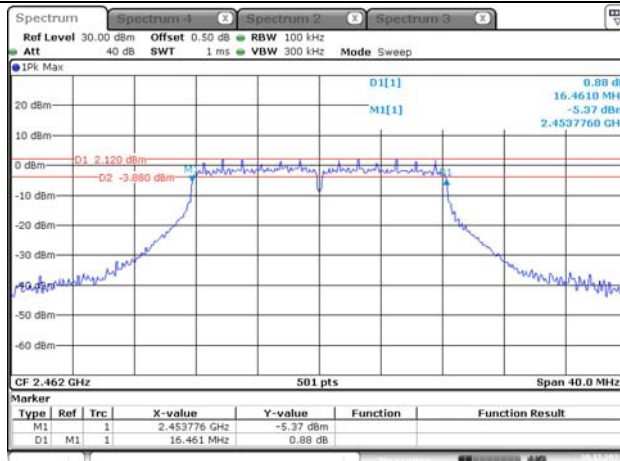

ProjectNo.:CR231167748 Testeri:Jou Zhou
Date: 20.DEC.2023 14:21:07

6dB Emission Bandwidth

802.11n ht20
Lowest Channel

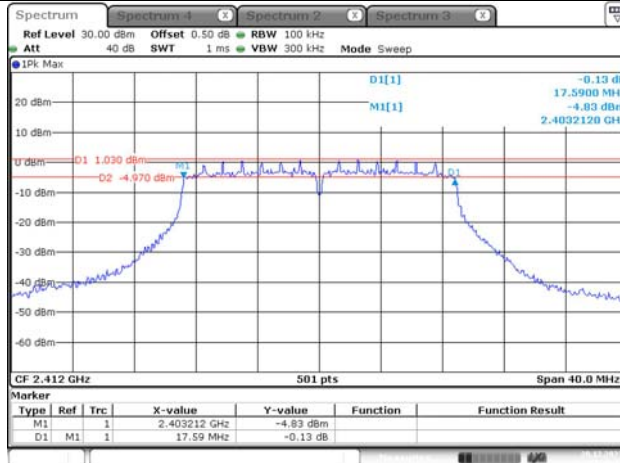

ProjectNo.:CR231167748 Testeri:Jou Zhou
Date: 20.DEC.2023 14:28:35

802.11n ht20
Middle Channel

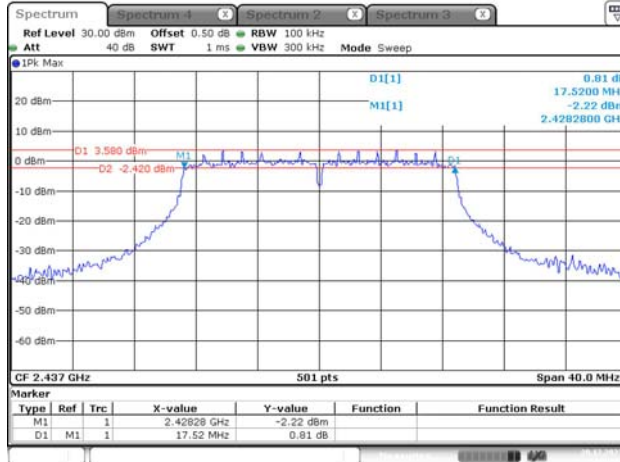

ProjectNo.:CR231167748 Testeri:Jou Zhou
Date: 20.DEC.2023 14:32:38

802.11n ht20
Highest Channel

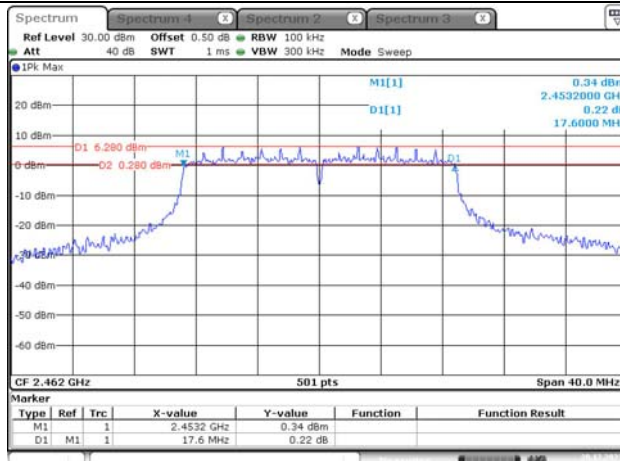

ProjectNo.:CR231167748 Testeri:Jou Zhou
Date: 20.DEC.2023 14:33:35

6dB Emission Bandwidth

802.11n ht40
Lowest Channel

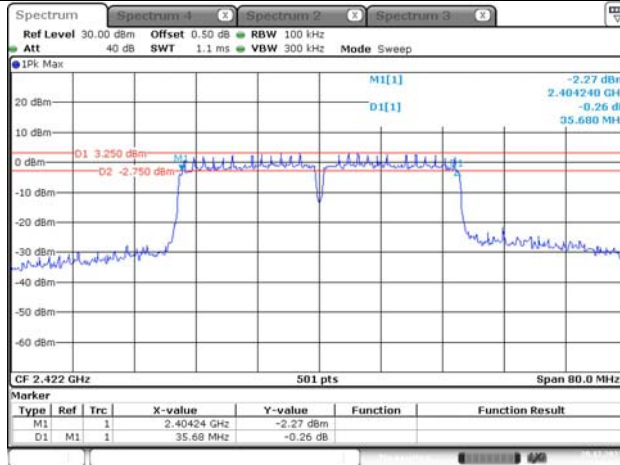

ProjectNo.:CR231167748 Testeri:Jou Zhou
Date: 20.DEC.2023 14:34:21

802.11n ht40
Middle Channel

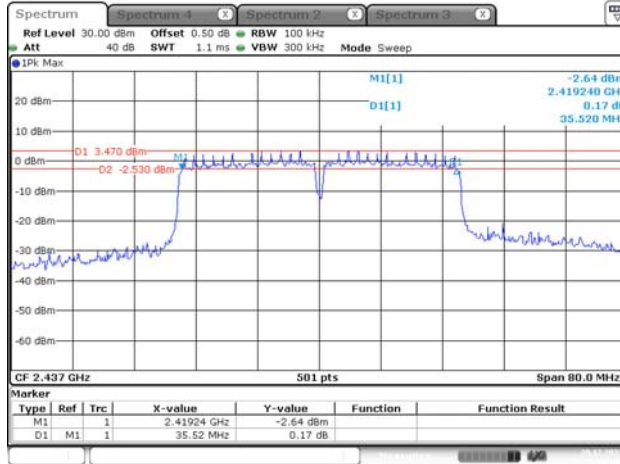

ProjectNo.:CR231167748 Testeri:Jou Zhou
Date: 20.DEC.2023 14:35:03

802.11n ht40
Highest Channel

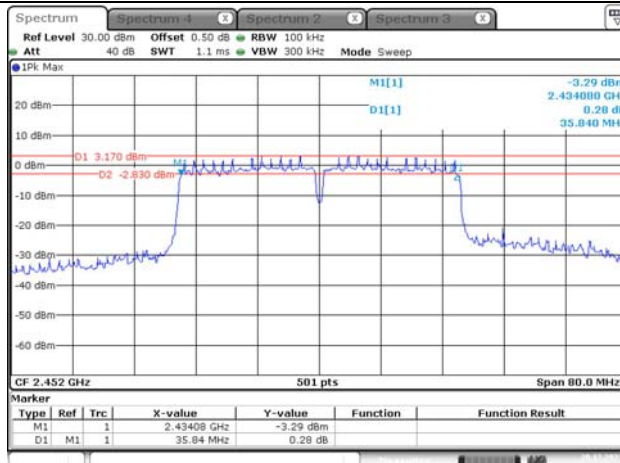

ProjectNo.:CR231167748 Testeri:Jou Zhou
Date: 20.DEC.2023 14:35:48

4.4 99% Occupied Bandwidth

Serial Number:	2DS2-1	Test Date:	2023/12/20
Test Site:	RF	Test Mode:	Transmitting
Tester:	Jou Zhou	Test Result:	N/A

Environmental Conditions:

Temperature: (°C)	23.1	Relative Humidity: (%)	31	ATM Pressure: (kPa)	101.8
----------------------	------	---------------------------	----	------------------------	-------

Test Equipment List and Details:

Manufacturer	Description	Model	Serial Number	Calibration Date	Calibration Due Date
R&S	Spectrum Analyzer	FSV40	101943	2023/3/31	2024/3/30
zhuoxiang	Coaxial Cable	SMA-178	211001	Each time	N/A
Mini-Circuits	DC Block	BLK-18-S+	1554403	Each time	N/A

* Statement of Traceability: China Certification ICT Co., Ltd (Dongguan) attests that all calibrations have been performed, traceable to National Primary Standards and International System of Units (SI).

Test Data:

Test Modes	Test Channel	Test Frequency (MHz)	99% Occupied Bandwidth (MHz)
802.11b	Lowest	2412	14.85
	Middle	2437	14.85
	Highest	2462	14.85
802.11g	Lowest	2412	17.01
	Middle	2437	17.09
	Highest	2462	17.09
802.11n ht20	Lowest	2412	18.28
	Middle	2437	18.04
	Highest	2462	18.12
802.11n ht40	Lowest	2422	36.09
	Middle	2437	36.09
	Highest	2452	36.41

99% Occupied Bandwidth

802.11b
Lowest Channel

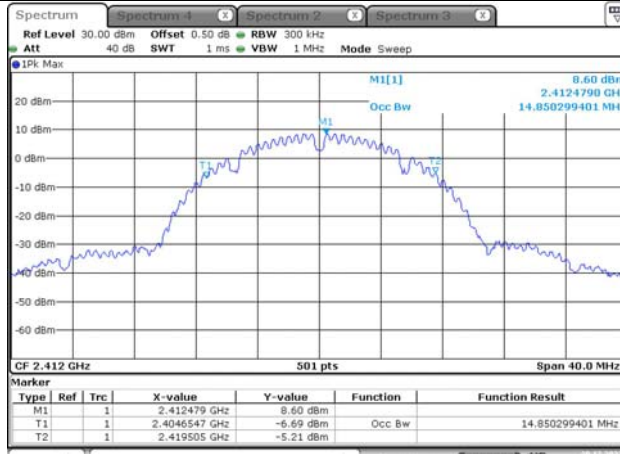

ProjectNo.:CR231167748 Testeri:Jou Zhou
Date: 20.DEC.2023 14:55:17

802.11b
Middle Channel

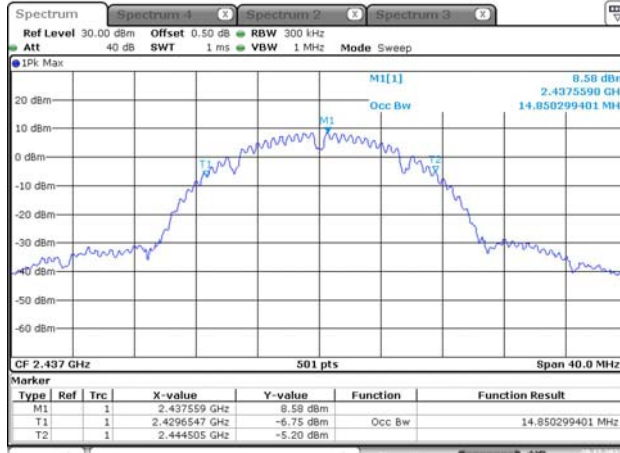

ProjectNo.:CR231167748 Testeri:Jou Zhou
Date: 20.DEC.2023 14:57:07

802.11b
Highest Channel

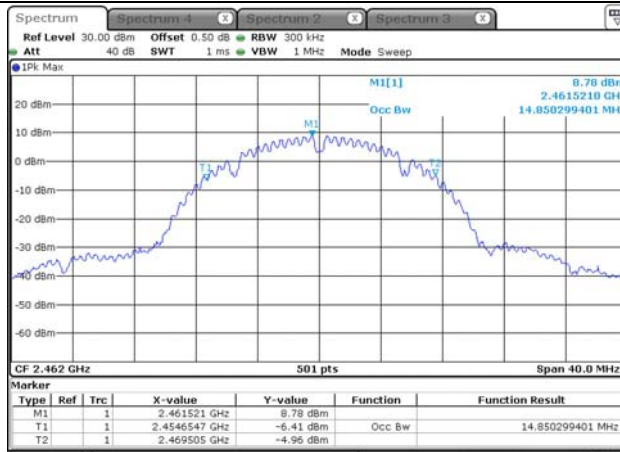

ProjectNo.:CR231167748 Testeri:Jou Zhou
Date: 20.DEC.2023 14:58:32

99% Occupied Bandwidth

802.11g
Lowest Channel

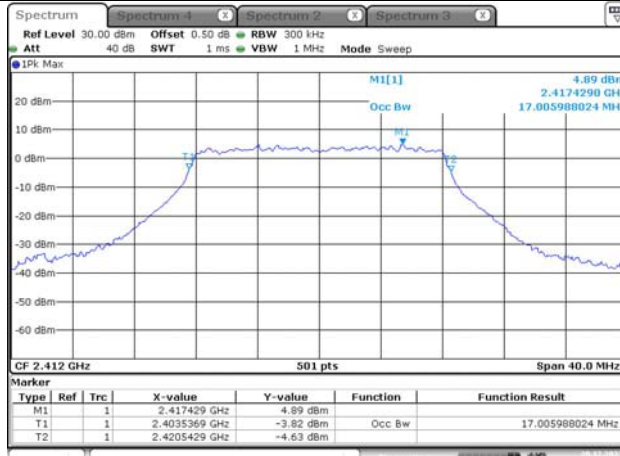

ProjectNo.:CR231167748 Tester:Jou Zhou
Date: 20.DEC.2023 15:00:33

802.11g
Middle Channel

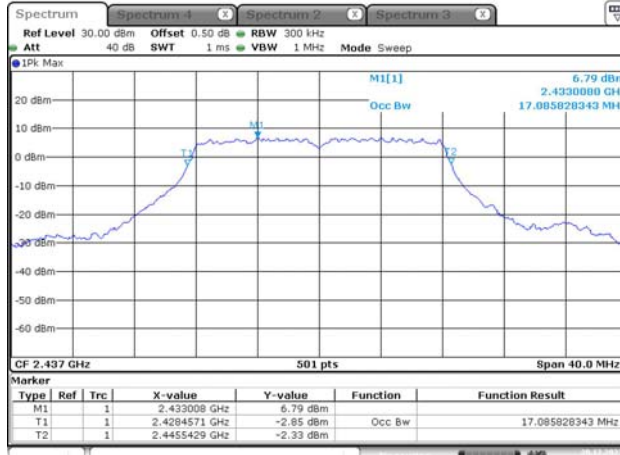

ProjectNo.:CR231167748 Tester:Jou Zhou
Date: 20.DEC.2023 15:41:04

802.11g
Highest Channel

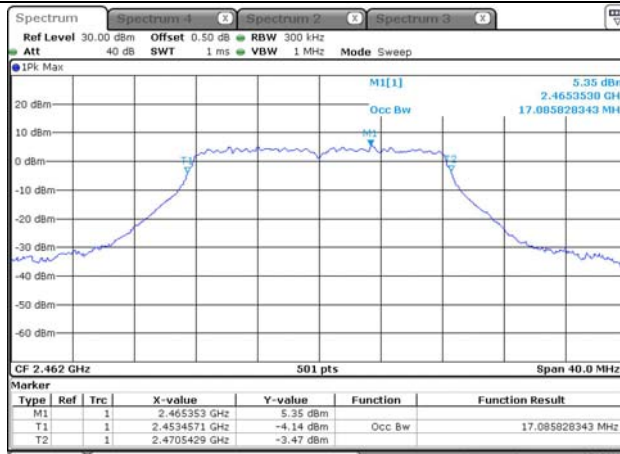

ProjectNo.:CR231167748 Tester:Jou Zhou
Date: 20.DEC.2023 15:07:11

99% Occupied Bandwidth

802.11n ht20
Lowest Channel

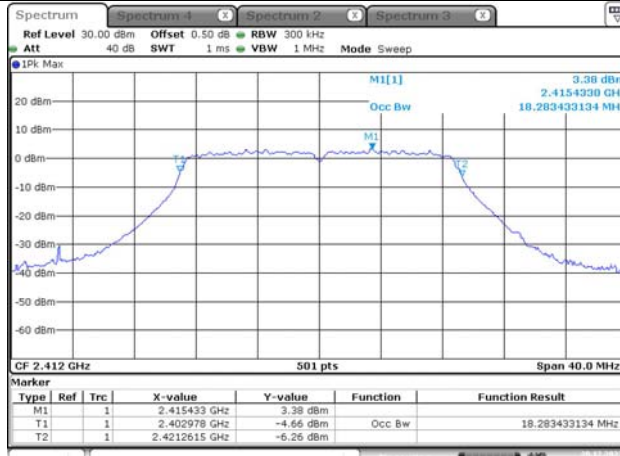

ProjectNo.:CR231167748 Testers:Jou Zhou
Date: 20.DEC.2023 15:08:38

802.11n ht20
Middle Channel

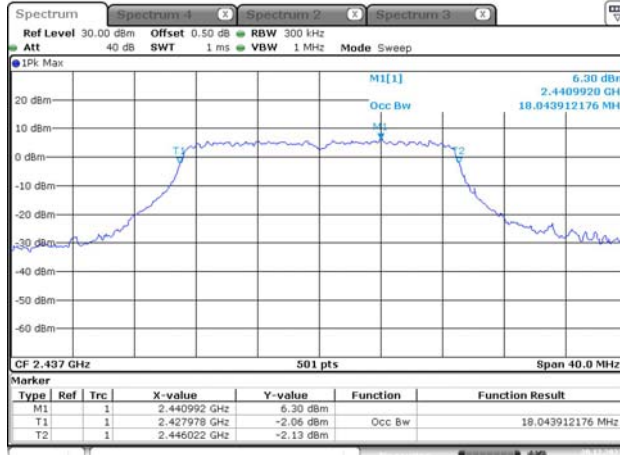

ProjectNo.:CR231167748 Testers:Jou Zhou
Date: 20.DEC.2023 15:10:08

802.11n ht20
Highest Channel

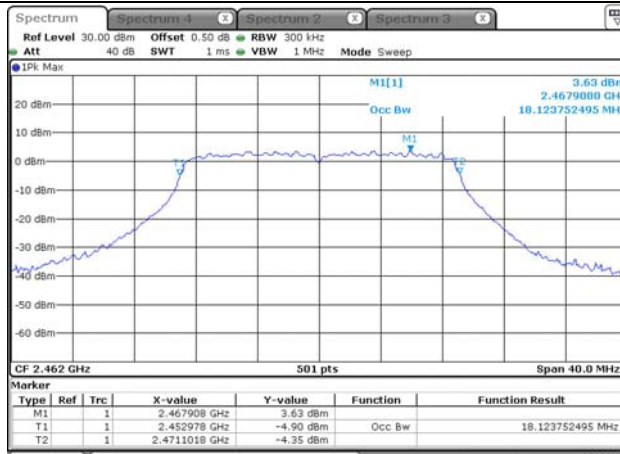

ProjectNo.:CR231167748 Testers:Jou Zhou
Date: 20.DEC.2023 15:11:15

99% Occupied Bandwidth

802.11n ht40
Lowest Channel



ProjectNo.:CR231167748 Testeri:Jou Zhou
Date: 20.DEC.2023 15:13:22

802.11n ht40
Middle Channel

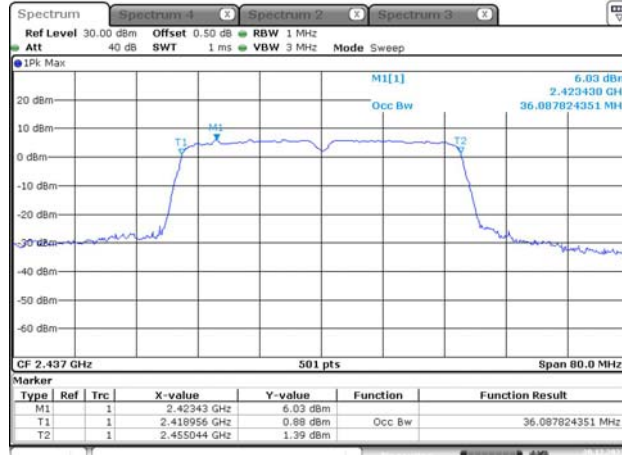

ProjectNo.:CR231167748 Testeri:Jou Zhou
Date: 20.DEC.2023 15:15:00

802.11n ht40
Highest Channel

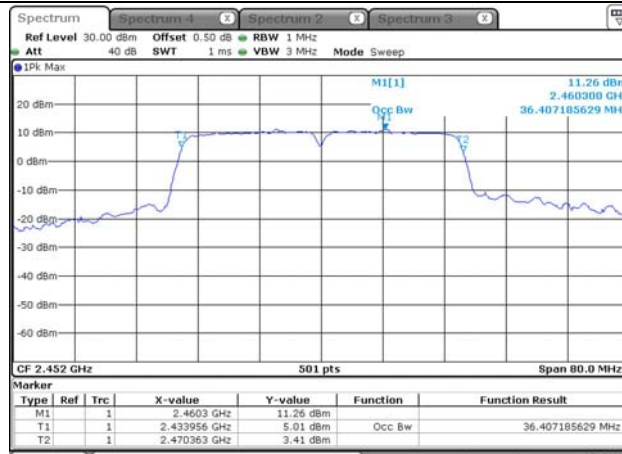

ProjectNo.:CR231167748 Testeri:Jou Zhou
Date: 20.DEC.2023 15:16:24

4.5 Maximum Conducted Output Power

Serial Number:	2DS2-1	Test Date:	2023/12/20
Test Site:	RF	Test Mode:	Transmitting
Tester:	Jou Zhou	Test Result:	Pass

Environmental Conditions:

Temperature: (°C)	23.1	Relative Humidity: (%)	31	ATM Pressure: (kPa)	101.8
----------------------	------	---------------------------	----	------------------------	-------

Test Equipment List and Details:

Manufacturer	Description	Model	Serial Number	Calibration Date	Calibration Due Date
Anritsu	Power Meter	ML2495A	1106009	2023/8/4	2024/8/3
Anritsu	Pulse Power Sensor	MA2411A	10780	2023/8/4	2024/8/3
zhuoxiang	Coaxial Cable	SMA-178	211001	Each time	N/A
Mini-Circuits	DC Block	BLK-18-S+	1554403	Each time	N/A

* Statement of Traceability: China Certification ICT Co., Ltd (Dongguan) attests that all calibrations have been performed, traceable to National Primary Standards and International System of Units (SI).

Test Data:

Test Modes	Test Frequency (MHz)	Maximum Conducted Peak Output Power (dBm)	Limit (dBm)
802.11b	2412	18.68	30
	2437	18.63	30
	2462	18.91	30
802.11g	2412	22.75	30
	2437	23.73	30
	2462	22.51	30
802.11n ht20	2412	21.15	30
	2437	20.46	30
	2462	22.07	30
802.11n ht40	2422	22.08	30
	2437	21.82	30
	2452	22.22	30

4.6 Maximum Power Spectral Density

Serial Number:	2DS2-1	Test Date:	2023/12/20
Test Site:	RF	Test Mode:	Transmitting
Tester:	Jou Zhou	Test Result:	Pass

Environmental Conditions:

Temperature: (°C)	23.1	Relative Humidity: (%)	31	ATM Pressure: (kPa)	101.8
----------------------	------	---------------------------	----	------------------------	-------

Test Equipment List and Details:

Manufacturer	Description	Model	Serial Number	Calibration Date	Calibration Due Date
R&S	Spectrum Analyzer	FSV40	101943	2023/3/31	2024/3/30
zhuoxiang	Coaxial Cable	SMA-178	211001	Each time	N/A
Mini-Circuits	DC Block	BLK-18-S+	1554403	Each time	N/A

* Statement of Traceability: China Certification ICT Co., Ltd (Dongguan) attests that all calibrations have been performed, traceable to National Primary Standards and International System of Units (SI).

Test Data:

Test Modes	Test Frequency (MHz)	Power Spectral Density (dBm/3kHz)	Limit (dBm/3kHz)
802.11b	2412	-4.78	8.00
	2437	-4.94	8.00
	2462	-5.67	8.00
802.11g	2412	-11.91	8.00
	2437	-10.07	8.00
	2462	-11.65	8.00
802.11n ht20	2412	-13.23	8.00
	2437	-9.95	8.00
	2462	-11.85	8.00
802.11n ht40	2422	-16.19	8.00
	2437	-15.99	8.00
	2452	-15.84	8.00

Maximum Power Spectral Density

802.11b
Lowest Channel

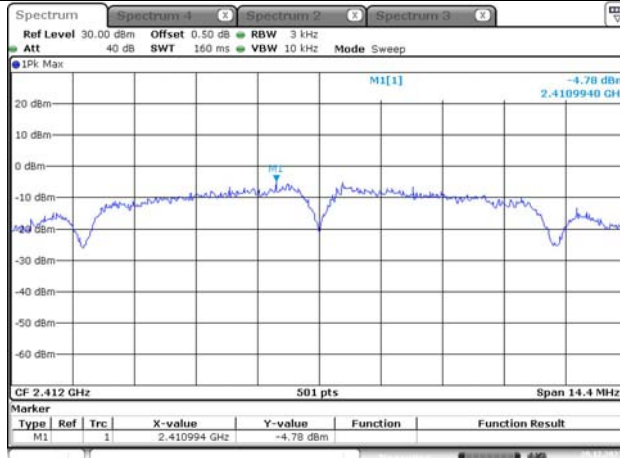

ProjectNo.:CR231167748 Testeri:Jou Zhou
Date: 20.DEC.2023 14:55:39

802.11b
Middle Channel

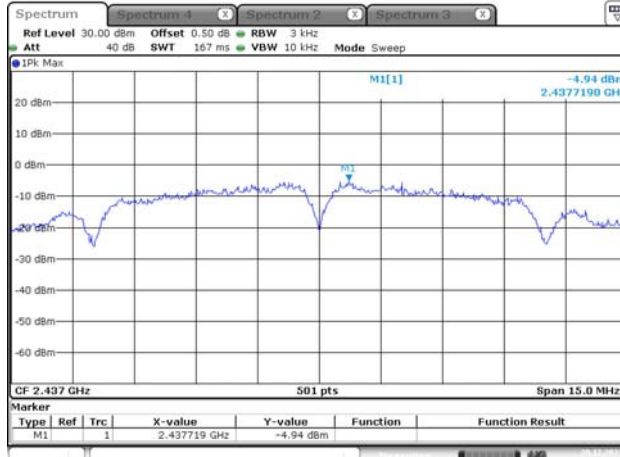

ProjectNo.:CR231167748 Testeri:Jou Zhou
Date: 20.DEC.2023 14:57:35

802.11b
Highest Channel

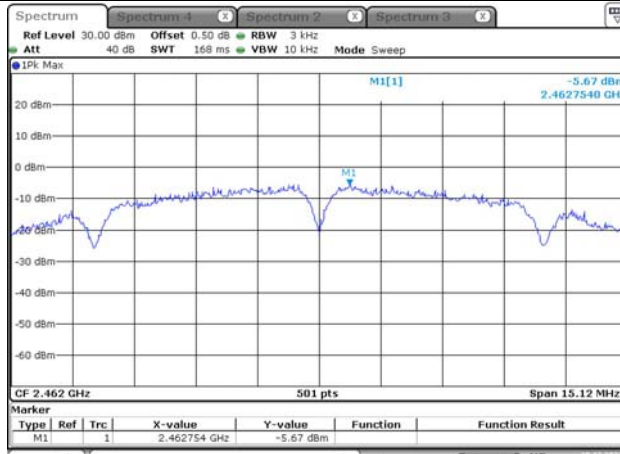

ProjectNo.:CR231167748 Testeri:Jou Zhou
Date: 20.DEC.2023 14:58:57

Maximum Power Spectral Density

802.11g
Lowest Channel

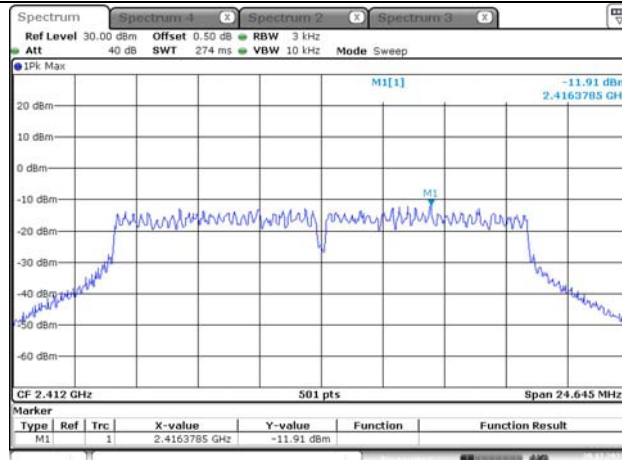

ProjectNo.:CR231167748 Tester:Jou Zhou
Date: 20.DEC.2023 15:00:53

802.11g
Middle Channel

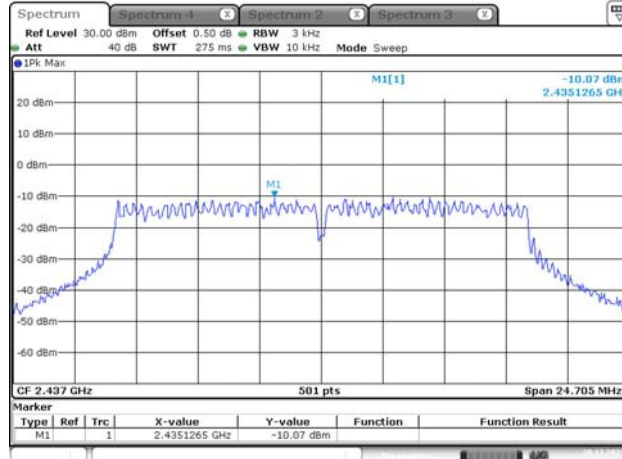

ProjectNo.:CR231167748 Tester:Jou Zhou
Date: 20.DEC.2023 15:41:26

802.11g
Highest Channel

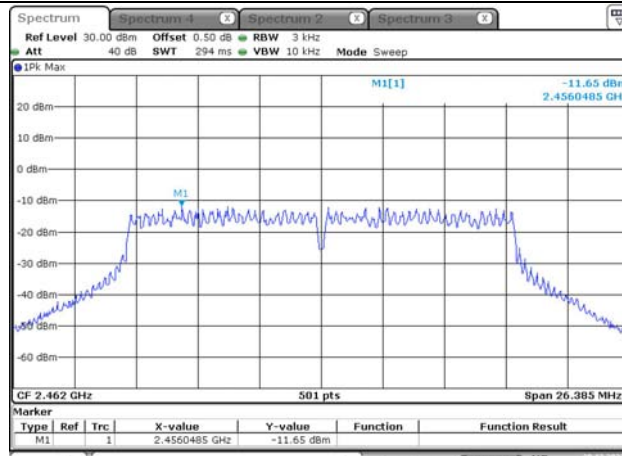

ProjectNo.:CR231167748 Tester:Jou Zhou
Date: 20.DEC.2023 15:07:30

Maximum Power Spectral Density

802.11n ht20
Lowest Channel

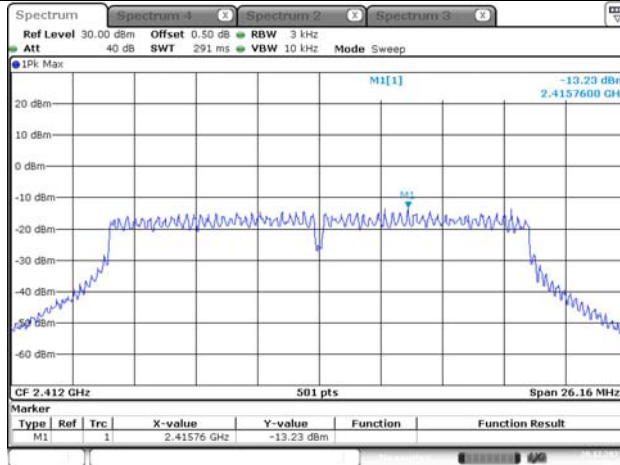

802.11n ht20
Middle Channel

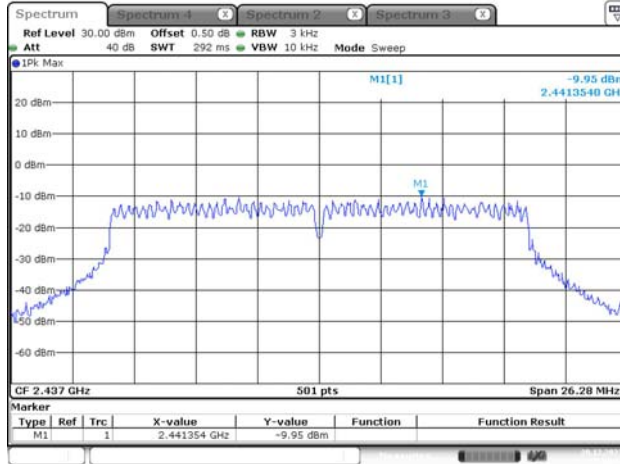

802.11n ht20
Highest Channel

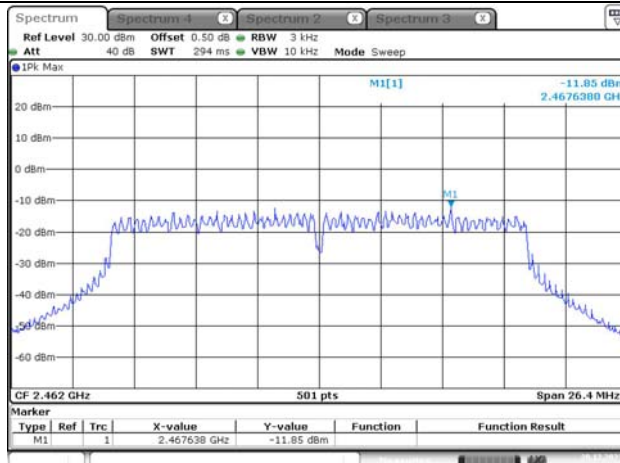

Maximum Power Spectral Density

802.11n ht40
Lowest Channel

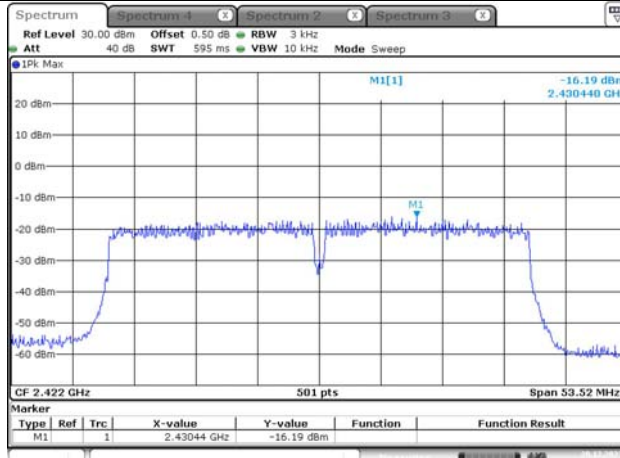

ProjectNo.:CR231167748 Tester:Jou Zhou
Date: 20.DEC.2023 15:13:44

802.11n ht40
Middle Channel

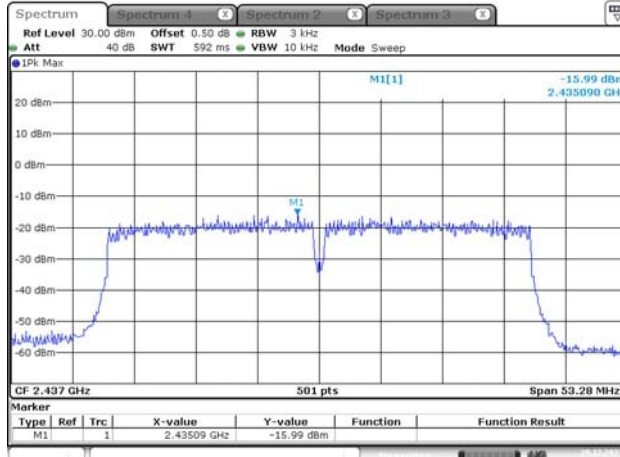

ProjectNo.:CR231167748 Tester:Jou Zhou
Date: 20.DEC.2023 15:15:26

802.11n ht40
Highest Channel

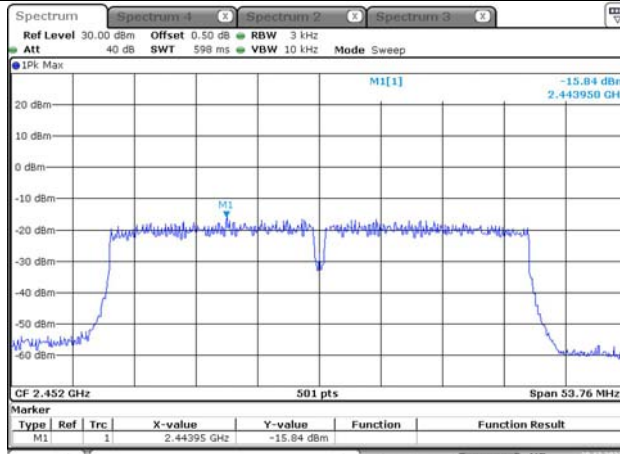

ProjectNo.:CR231167748 Tester:Jou Zhou
Date: 20.DEC.2023 15:16:46

4.7 100 kHz Bandwidth of Frequency Band Edge

Serial Number:	2DS2-1	Test Date:	2023/12/20
Test Site:	RF	Test Mode:	Transmitting
Tester:	Jou Zhou	Test Result:	Pass

Environmental Conditions:

Temperature: (°C)	23.1	Relative Humidity: (%)	31	ATM Pressure: (kPa)	101.8
----------------------	------	---------------------------	----	------------------------	-------

Test Equipment List and Details:

Manufacturer	Description	Model	Serial Number	Calibration Date	Calibration Due Date
R&S	Spectrum Analyzer	FSV40	101943	2023/3/31	2024/3/30
zhuoxiang	Coaxial Cable	SMA-178	211001	Each time	N/A
Mini-Circuits	DC Block	BLK-18-S+	1554403	Each time	N/A

* Statement of Traceability: China Certification ICT Co., Ltd (Dongguan) attests that all calibrations have been performed, traceable to National Primary Standards and International System of Units (SI).

Test Data:

100 kHz Bandwidth of Frequency Band Edge

802.11b
Lowest Band edge

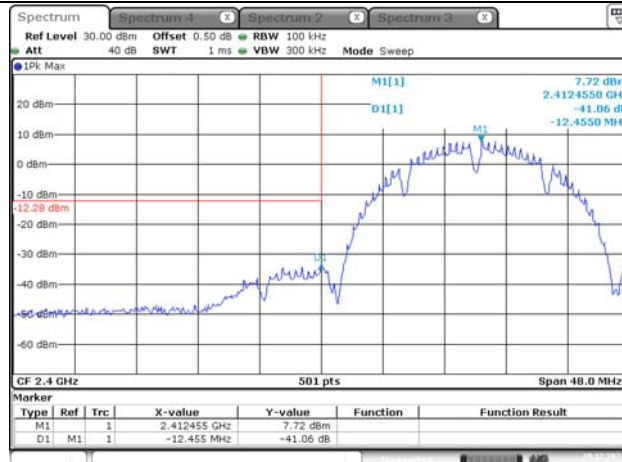

ProjectNo.:CR231167748 Tester:Jou Zhou
Date: 20.DEC.2023 14:55:59

802.11b
Highest Band edge

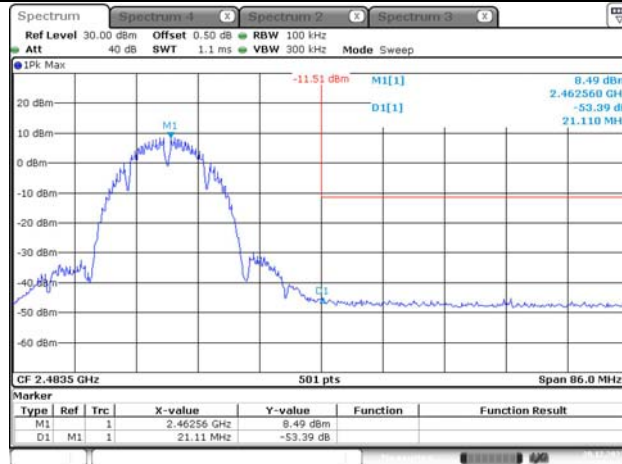

ProjectNo.:CR231167748 Tester:Jou Zhou
Date: 20.DEC.2023 14:59:17

100 kHz Bandwidth of Frequency Band Edge

802.11g
Lowest Band edge

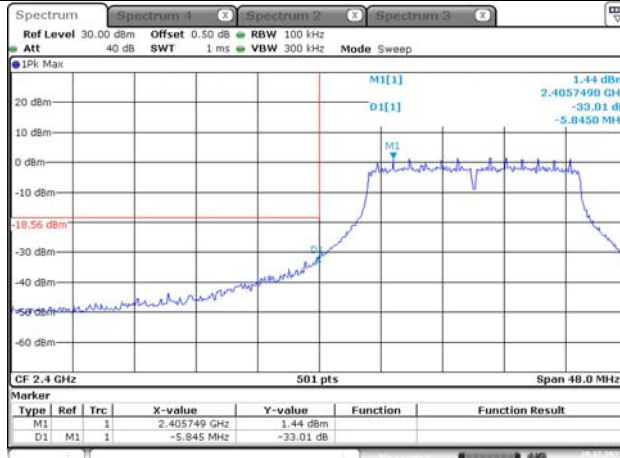

ProjectNo.:CR231167748 Tester:Jou Zhou
Date: 20.DEC.2023 15:01:22

802.11g
Highest Band edge

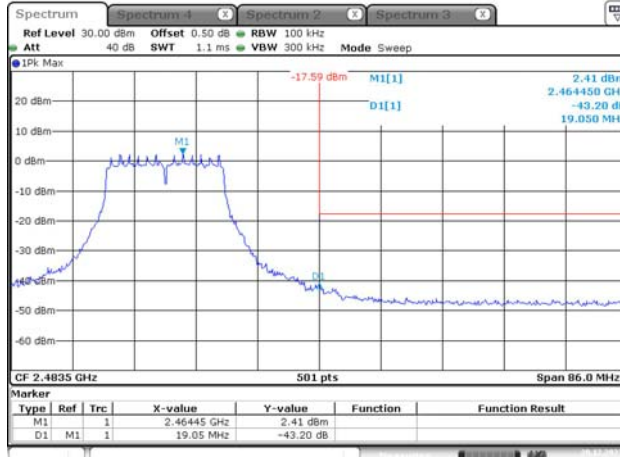

ProjectNo.:CR231167748 Tester:Jou Zhou
Date: 20.DEC.2023 15:07:50

100 kHz Bandwidth of Frequency Band Edge

802.11n ht20
Lowest Band edge

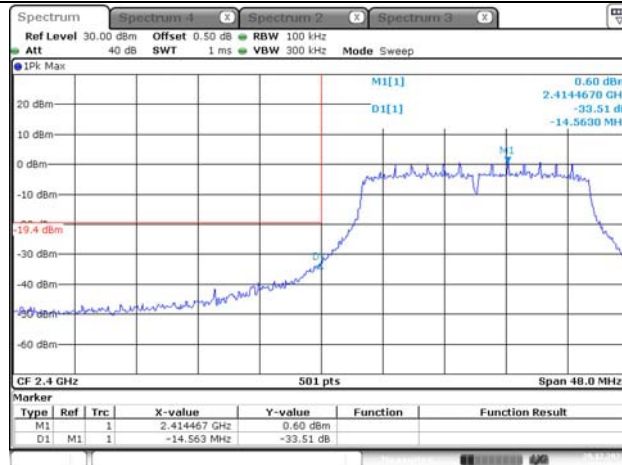

ProjectNo.:CR231167748 Testers:Jou Zhou
Date: 20.DEC.2023 15:09:20

802.11n ht20
Highest Band edge

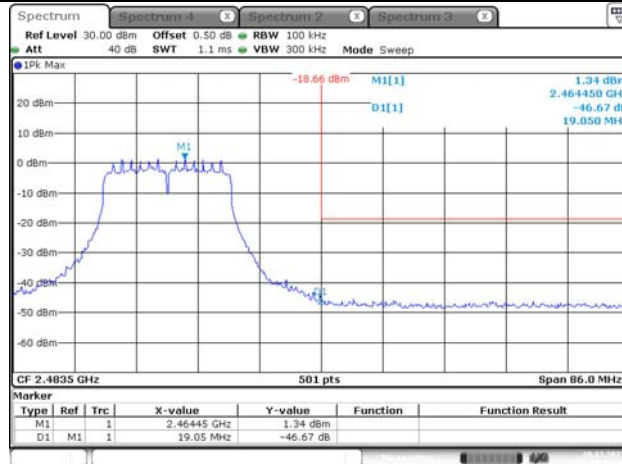

ProjectNo.:CR231167748 Testers:Jou Zhou
Date: 20.DEC.2023 15:11:48

100 kHz Bandwidth of Frequency Band Edge

802.11n ht40
Lowest Band edge

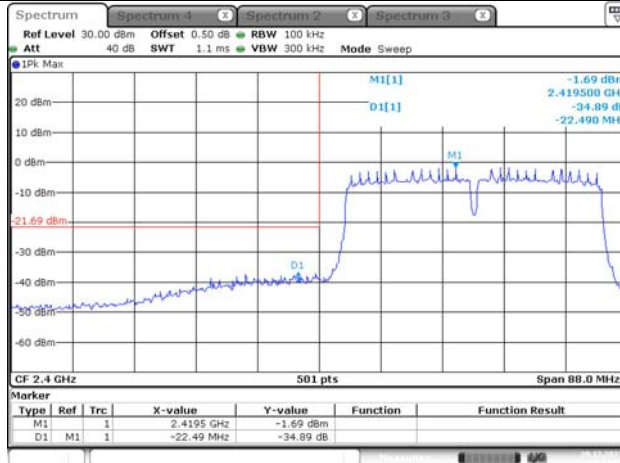

ProjectNo.:CR231167748 Tester:Jou Zhou
Date: 20.DEC.2023 15:14:04

802.11n ht40
Highest Band edge

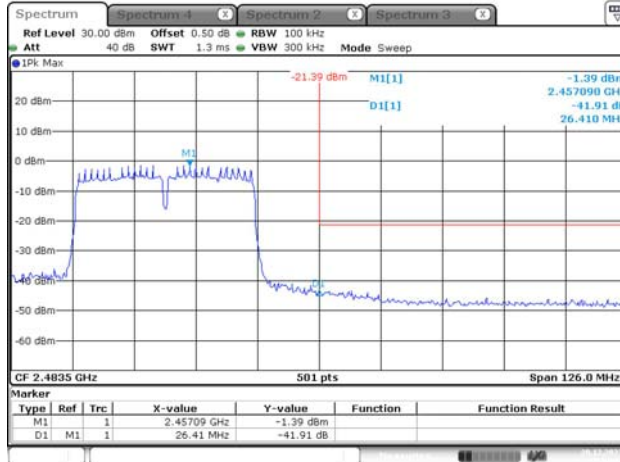

ProjectNo.:CR231167748 Tester:Jou Zhou
Date: 20.DEC.2023 15:17:09

4.8 Duty Cycle

Serial Number:	2DS2-1	Test Date:	2023/12/20
Test Site:	RF	Test Mode:	Transmitting
Tester:	Jou Zhou	Test Result:	N/A

Environmental Conditions:					
Temperature: (°C)	23.1	Relative Humidity: (%)	31	ATM Pressure: (kPa)	101.8

Test Equipment List and Details:

Manufacturer	Description	Model	Serial Number	Calibration Date	Calibration Due Date
R&S	Spectrum Analyzer	FSV40	101943	2023/3/31	2024/3/30
zhuoxiang	Coaxial Cable	SMA-178	211001	Each time	N/A
Mini-Circuits	DC Block	BLK-18-S+	1554403	Each time	N/A

* Statement of Traceability: China Certification ICT Co., Ltd (Dongguan) attests that all calibrations have been performed, traceable to National Primary Standards and International System of Units (SI).

Test Modes	Ton (ms)	Ton+off (ms)	Duty cycle (%)	1/T (Hz)	VBW Setting (kHz)
802.11b	12.39	12.54	98.80	/	0.01
802.11g	2.1	/	Not constant	476	0.5
802.11n ht20	1.95	/	Not constant	513	1
802.11n ht40	0.96	/	Not constant	1042	2

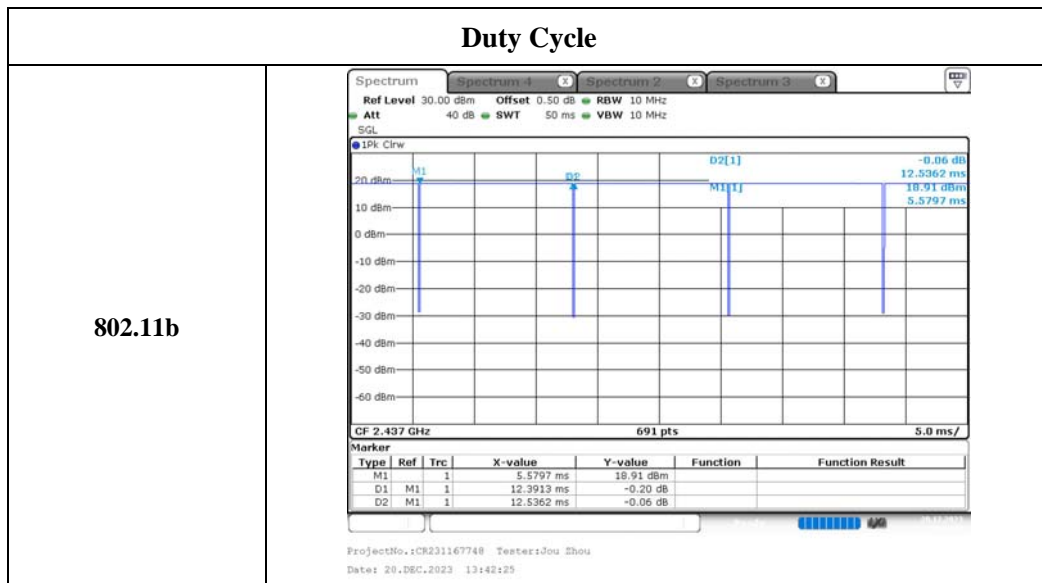

802.11g

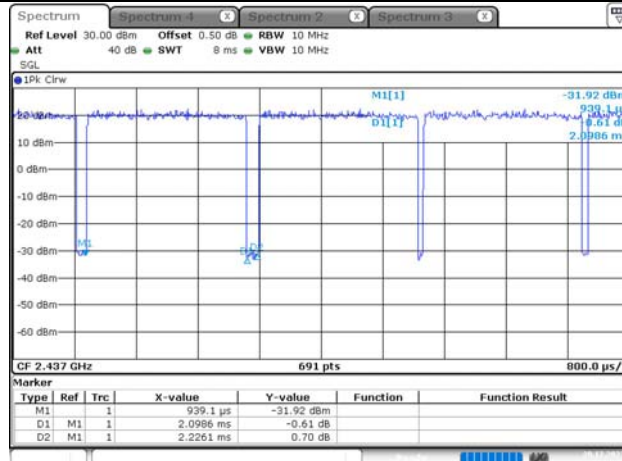

ProjectNo.:CR231167748 Tester:Jou Zhou
Date: 20.DEC.2023 13:44:03

802.11n ht20

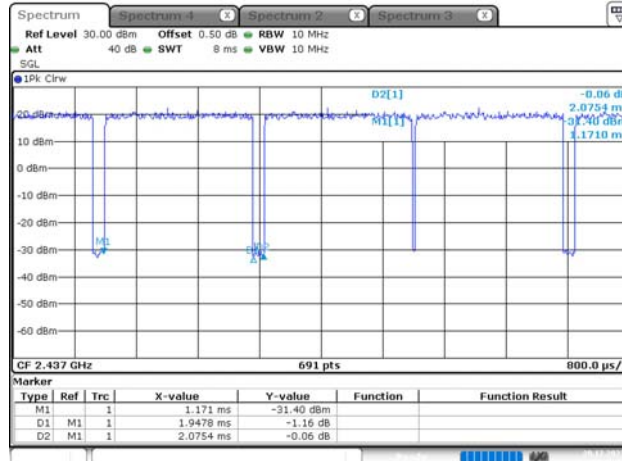

ProjectNo.:CR231167748 Tester:Jou Zhou
Date: 20.DEC.2023 13:45:00

802.11n ht40

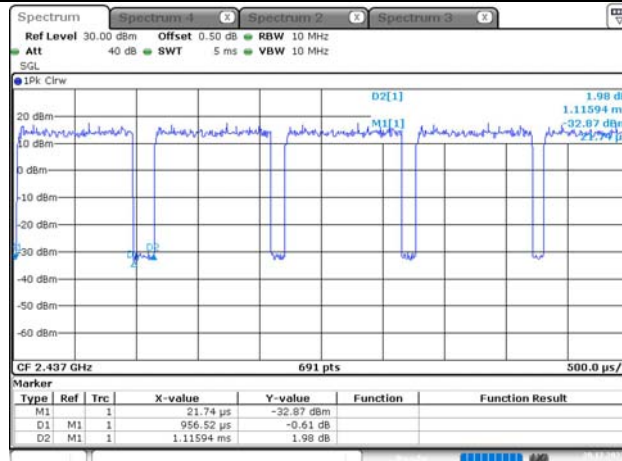

ProjectNo.:CR231167748 Tester:Jou Zhou
Date: 20.DEC.2023 13:48:31

5. EUT PHOTOGRAPHS

Please refer to the attachment CR231167748-EXP EUT EXTERNAL PHOTOGRAPHS and CR231167748-INP EUT INTERNAL PHOTOGRAPHS.

6. TEST SETUP PHOTOGRAPHS

Please refer to the attachment CR231167748-00C-TSP TEST SETUP PHOTOGRAPHS.

===== END OF REPORT =====