



**中认信通**  
CHINA CERTIFICATION ICT CO., LTD (DONGGUAN)



## TEST REPORT

**Applicant: AKUVOX (XIAMEN) NETWORKS CO., LTD.**

Address: 10/F, No.56 Guanri Road, Software Park II, Xiamen 361009, China

**FCC ID: 2AHCR-S563W**

**Product Name: Indoor Monitor**

**Standard(s): 47 CFR Part 15, Subpart C (15.247)**

**ANSI C63.10-2013**

**KDB 558074 D01 15.247 Meas Guidance v05r02**

The above device has been tested and found compliant with the requirement of the relative standards by China Certification ICT Co., Ltd (Dongguan)

**Report Number: CR231167748-00A**

**Date Of Issue: 2024/2/22**

**Reviewed By: Calvin Chen**

Title: RF Engineer

**Approved By: Sun Zhong**

Title: Manager

**Test Laboratory: China Certification ICT Co., Ltd (Dongguan)**

No. 113, Pingkang Road, Dalang Town, Dongguan,

Guangdong, China

Tel: +86-769-82016888

## **Test Facility**

The Test site used by China Certification ICT Co., Ltd (Dongguan) to collect test data is located on the No. 113, Pingkang Road, Dalang Town, Dongguan, Guangdong, China.

The lab has been recognized as the FCC accredited lab under the KDB 974614 D01 and is listed in the FCC Public Access Link (PAL) database, FCC Registration No.: 442868, the FCC Designation No.: CN1314.

## **Declarations**

China Certification ICT Co., Ltd (Dongguan) is not responsible for the authenticity of any test data provided by the applicant. Data included from the applicant that may affect test results are marked with a triangle symbol “▲”. Customer model name, addresses, names, trademarks etc. are not considered data.

Unless otherwise stated the results shown in this test report refer only to the sample(s) tested.

This report cannot be reproduced except in full, without prior written approval of the Company.

This report is valid only with a valid digital signature. The digital signature may be available only under the Adobe software above version 7.0.

This report may contain data that are not covered by the accreditation scope and shall be marked with an asterisk “★”.

## CONTENTS

<b>DOCUMENT REVISION HISTORY .....</b>	<b>5</b>
<b>1. GENERAL INFORMATION .....</b>	<b>6</b>
<b>1.1 PRODUCT DESCRIPTION FOR EQUIPMENT UNDER TEST (EUT) .....</b>	<b>6</b>
<b>1.2 DESCRIPTION OF TEST CONFIGURATION.....</b>	<b>7</b>
1.2.1 EUT Operation Condition:.....	7
1.2.2 Support Equipment List and Details .....	7
1.2.3 Support Cable List and Details .....	7
1.2.4 Block Diagram of Test Setup.....	8
<b>1.3 MEASUREMENT UNCERTAINTY .....</b>	<b>9</b>
<b>2. SUMMARY OF TEST RESULTS .....</b>	<b>10</b>
<b>3. REQUIREMENTS AND TEST PROCEDURES .....</b>	<b>11</b>
<b>3.1 AC LINE CONDUCTED EMISSIONS.....</b>	<b>11</b>
3.1.1 Applicable Standard.....	11
3.1.2 EUT Setup.....	12
3.1.3 EMI Test Receiver Setup .....	12
3.1.4 Test Procedure .....	13
3.1.5 Corrected Amplitude & Margin Calculation.....	13
<b>3.2 RADIATION SPURIOUS EMISSIONS.....</b>	<b>14</b>
3.2.1 Applicable Standard.....	14
3.2.2 EUT Setup.....	14
3.2.3 EMI Test Receiver & Spectrum Analyzer Setup .....	15
3.2.4 Test Procedure .....	16
3.2.5 Corrected Amplitude & Margin Calculation.....	16
<b>3.3 MINIMUM 6 DB BANDWIDTH.....</b>	<b>17</b>
3.3.1 Applicable Standard.....	17
3.3.2 EUT Setup.....	17
3.3.3 Test Procedure .....	17
<b>3.4 MAXIMUM CONDUCTED OUTPUT POWER.....</b>	<b>18</b>
3.4.1 Applicable Standard.....	18
3.4.2 EUT Setup.....	18
3.4.3 Test Procedure .....	18
<b>3.5 MAXIMUM POWER SPECTRAL DENSITY .....</b>	<b>19</b>
3.5.1 Applicable Standard.....	19
3.5.2 EUT Setup.....	19
3.5.3 Test Procedure .....	19
<b>3.6 100 KHZ BANDWIDTH OF FREQUENCY BAND EDGE.....</b>	<b>20</b>
3.6.1 Applicable Standard.....	20
3.6.2 EUT Setup.....	20
3.6.3 Test Procedure .....	20
<b>3.7 DUTY CYCLE .....</b>	<b>21</b>
3.7.1 EUT Setup.....	21
3.7.2 Test Procedure .....	21

**3.8 ANTENNA REQUIREMENT.....21**  
    3.8.1 Applicable Standard.....21  
    3.8.2 Judgment.....21

**4. Test DATA AND RESULTS ..... 22**  
    **4.1 AC LINE CONDUCTED EMISSIONS.....22**  
    **4.2 RADIATION SPURIOUS EMISSIONS .....25**  
    **4.3 6 dB EMISSION BANDWIDTH .....40**  
    **4.4 MAXIMUM CONDUCTED OUTPUT POWER.....42**  
    **4.5 MAXIMUM POWER SPECTRAL DENSITY .....44**  
    **4.6 100 kHz BANDWIDTH OF FREQUENCY BAND EDGE.....46**  
    **4.7 DUTY CYCLE .....48**

**5. EUT PHOTOGRAPHS ..... 49**

**6. TEST SETUP PHOTOGRAPHS ..... 50**

## DOCUMENT REVISION HISTORY

Revision Number	Report Number	Description of Revision	Date of Revision
1.0	CR231167748-00A	Original Report	2024/2/22

## 1. GENERAL INFORMATION

### 1.1 Product Description for Equipment under Test (EUT)

<b>EUT Name:</b>	Indoor Monitor
<b>EUT Model:</b>	S563W
<b>Operation Frequency:</b>	2402-2480 MHz
<b>Maximum Peak Output Power (Conducted):</b>	4.09dBm
<b>Modulation Type:</b>	GFSK
<b>Rated Input Voltage:</b>	DC 12V From Adapter DC 48V From POE
<b>Serial Number:</b>	2DS2-1(For RF Conducted Test) 2DS2-2(For RE/CE Test)
<b>EUT Received Date:</b>	2023/11/16
<b>EUT Received Status:</b>	Good

#### Operation Frequency Detail:

Channel	Frequency (MHz)	Channel	Frequency (MHz)
0	2402	20	2442
1	2404	...	...
...	...	...	...
...	...	...	...
..	...	38	2478
19	2440	39	2480

Per section 15.31(m), the below frequencies were performed to test:

Test Channel	Frequency (MHz)
Lowest	2402
Middle	2440
Highest	2480

#### Antenna Information Detail ▲ :

Antenna Type	input impedance (Ohm)	Frequency Range	Antenna Gain
FPC	50	2.4~2.5GHz	3.1 dBi

The Method of §15.203 Compliance:

- Antenna was permanently attached to the unit.  
 Antenna use a unique type of connector to attach to the EUT.  
 Unit was professionally installed, and installer shall be responsible for verifying that the correct antenna is employed with the unit.

#### Accessory Information:

Accessory Description	Manufacturer	Model	Parameters
/	/	/	/

## 1.2 Description of Test Configuration

### 1.2.1 EUT Operation Condition:

<b>EUT Operation Mode:</b>	The system was configured for testing in Engineering Mode, which was provided by the manufacturer. Per BT report test, test with Powered by POE was the worst.		
<b>Equipment Modifications:</b>	No		
<b>EUT Exercise Software:</b>	CMD		
The software was provided by manufacturer. The maximum power was configured as below, that was provided by the manufacturer▲:			
Test Modes	Power Level Setting		
	Lowest Channel	Middle Channel	Highest Channel
BLE 1Mbps	default	default	default

### 1.2.2 Support Equipment List and Details

Manufacturer	Description	Model	Serial Number
TOTO Link	Router	LR1200	190924004S1
Nexhome	Door Phone	DH-I66S(P)	EMZBIU20113001
/	RS485 Load	RS485-X1	F-EM-PHRJ45X8011
DELL	Laptop	E6410	GMLGPM1
/	Relay Load	Relay-C1	EMRLLD20221010EN
Metke Skycom	POE	S213M-5	MT21090063
GWT	Bell	A-24	unknown
GWT	Alarm	unknown	unknown

### 1.2.3 Support Cable List and Details

Cable Description	Shielding Type	Ferrite Core	Length (m)	From Port	To
RJ45 Cable	No	No	2	Router	Door Phone
RJ45 Cable	No	No	10	Router	POE
AC Cable	No	No	1	POE	LISN
RJ45 Cable	No	No	0.3	POE	EUT
RS485 Cable	No	No	3	RS485 Load	EUT
DC Cable	No	No	3	Relay Load	EUT
RJ45 Cable	No	No	10	Laptop	EUT
DC Cable	No	No	3	Bell	EUT
DC Cable	No	No	3	Alarm	EUT

**1.2.4 Block Diagram of Test Setup**

AC Line Conducted Emissions:

POE:

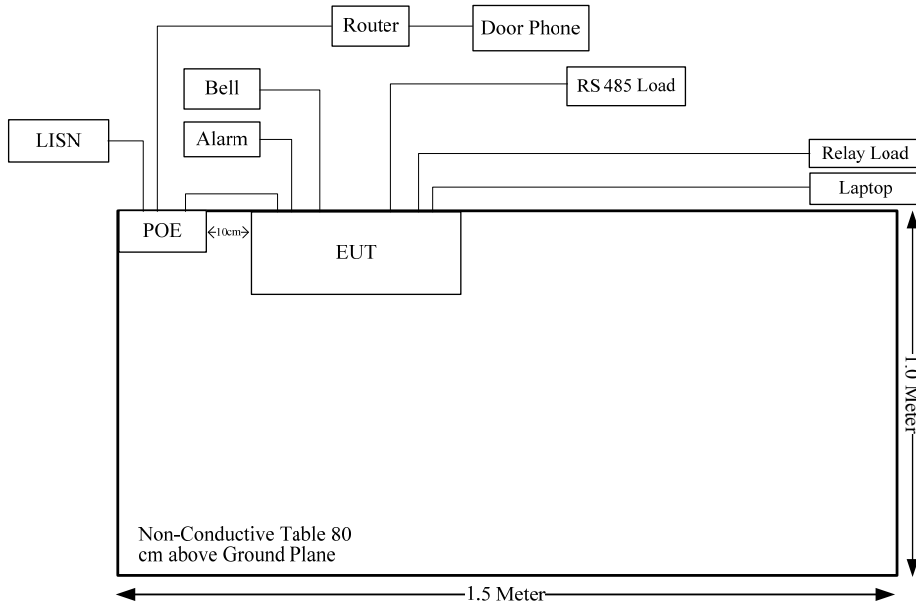

Radiation Spurious Emissions:

POE:

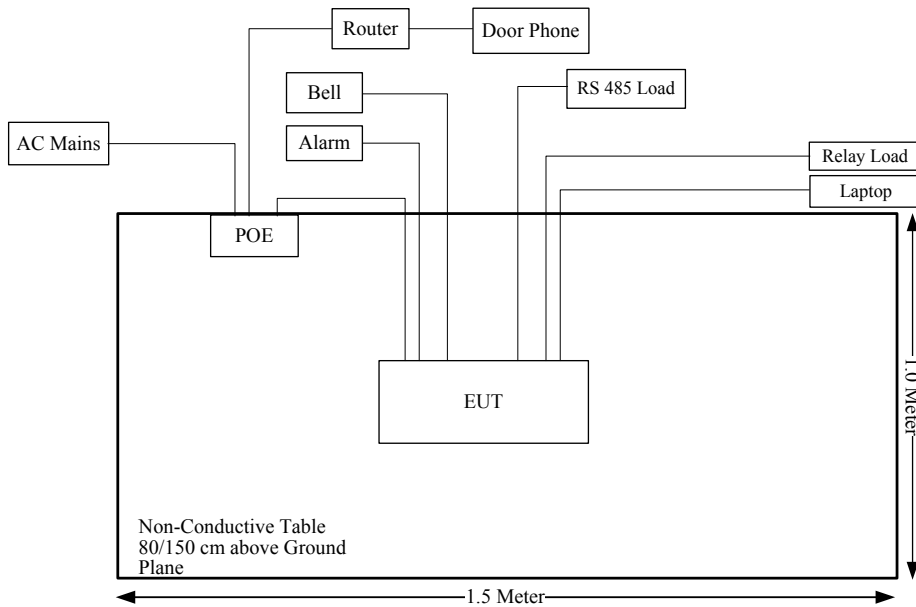



### 1.3 Measurement Uncertainty

Otherwise required by the applicant or Product Regulations, Decision Rule in this report did not consider the uncertainty. The extended uncertainty given in this report is obtained by combining the standard uncertainty times the coverage factor K with the 95% confidence interval.

Parameter	Measurement Uncertainty
Occupied Channel Bandwidth	±5 %
RF output power, conducted	±0.61dB
Power Spectral Density, conducted	±0.61 dB
Unwanted Emissions, radiated	9kHz~30MHz: 4.12dB, 30MHz~200MHz: 4.15 dB, 200MHz~1GHz: 5.61 dB, 1GHz~6GHz: 5.14 dB, 6GHz~18GHz: 5.93 dB, 18GHz~26.5GHz: 5.47 dB, 26.5GHz~40GHz: 5.63 dB
Unwanted Emissions, conducted	±1.26 dB
Temperature	±1 °C
Humidity	±5%
DC and low frequency voltages	±0.4%
Duty Cycle	1%
AC Power Lines Conducted Emission	2.8 dB (150 kHz to 30 MHz)

## 2. SUMMARY OF TEST RESULTS

Standard(s) Section	Test Items	Result
§15.207(a)	AC line conducted emissions	Compliant
§15.205, §15.209, §15.247(d)	Radiated Spurious Emissions	Compliant
§15.247 (a)(2)	Minimum 6 dB Bandwidth	Compliant
§15.247(b)(3)	Maximum Conducted Output Power	Compliant
§15.247(e)	Power Spectral Density	Compliant
§15.247(d)	100 kHz Bandwidth of Frequency Band Edge	Compliant
§15.203	Antenna Requirement	Compliant

### 3. REQUIREMENTS AND TEST PROCEDURES

#### 3.1 AC Line Conducted Emissions

##### 3.1.1 Applicable Standard

FCC§15.207(a).

(a) Except as shown in paragraphs (b) and (c) of this section, for an intentional radiator that is designed to be connected to the public utility (AC) power line, the radio frequency voltage that is conducted back onto the AC power line on any frequency or frequencies, within the band 150 kHz to 30 MHz, shall not exceed the limits in the following table, as measured using a 50  $\mu$ H/50 ohms line impedance stabilization network (LISN). Compliance with the provisions of this paragraph shall be based on the measurement of the radio frequency voltage between each power line and ground at the power terminal. The lower limit applies at the boundary between the frequency ranges.

Frequency of emission (MHz)	Conducted limit (dB $\mu$ V)	
	Quasi-peak	Average
0.15-0.5	66 to 56*	56 to 46*
0.5-5	56	46
5-30	60	50

\*Decreases with the logarithm of the frequency.

(b) The limit shown in paragraph (a) of this section shall not apply to carrier current systems operating as intentional radiators on frequencies below 30 MHz. In lieu thereof, these carrier current systems shall be subject to the following standards:

(1) For carrier current system containing their fundamental emission within the frequency band 535-1705 kHz and intended to be received using a standard AM broadcast receiver: no limit on conducted emissions.

(2) For all other carrier current systems: 1000  $\mu$ V within the frequency band 535-1705 kHz, as measured using a 50  $\mu$ H/50 ohms LISN.

(3) Carrier current systems operating below 30 MHz are also subject to the radiated emission limits in §15.205, §15.209, §15.221, §15.223, or §15.227, as appropriate.

(c) Measurements to demonstrate compliance with the conducted limits are not required for devices which only employ battery power for operation and which do not operate from the AC power lines or contain provisions for operation while connected to the AC power lines. Devices that include, or make provisions for, the use of battery chargers which permit operating while charging, AC adapters or battery eliminators or that connect to the AC power lines indirectly, obtaining their power through another device which is connected to the AC power lines, shall be tested to demonstrate compliance with the conducted limits.

### 3.1.2 EUT Setup



- Note: 1. Support units were connected to second LISN.  
 2. Both of LISNs (AMN) 80 cm from EUT and at the least 80 cm from other units and other metal planes support units.

The setup of EUT is according with per ANSI C63.10-2013 measurement procedure. The specification used was with the FCC Part 15.207 limits.

The spacing between the peripherals was 10 cm.

### 3.1.3 EMI Test Receiver Setup

The EMI test receiver was set to investigate the spectrum from 150 kHz to 30 MHz.

During the conducted emission test, the EMI test receiver was set with the following configurations:

Frequency Range	IF B/W
150 kHz – 30 MHz	9 kHz

### 3.1.4 Test Procedure

The frequency and amplitude of the six highest ac power-line conducted emissions relative to the limit, measured over all the current-carrying conductors of the EUT power cords, and the operating frequency or frequency to which the EUT is tuned (if appropriate), should be reported, unless such emissions are more than 20 dB below the limit. AC power-line conducted emissions measurements are to be separately carried out only on each of the phase (“hot”) line(s) and (if used) on the neutral line(s), but not on the ground [protective earth] line(s). If less than six emission frequencies are within 20 dB of the limit, then the noise level of the measuring instrument at representative frequencies should be reported. The specific conductor of the power-line cord for each of the reported emissions should be identified. Measure the six highest emissions with respect to the limit on each current-carrying conductor of each power cord associated with the EUT (but not the power cords of associated or peripheral equipment that are part of the test configuration). Then, report the six highest emissions with respect to the limit from among all the measurements identifying the frequency and specific current-carrying conductor identified with the emission. The six highest emissions should be reported for each of the current-carrying conductors, or the six highest emissions may be reported over all the current-carrying conductors.

### 3.1.5 Corrected Amplitude & Margin Calculation

The basic equation is as follows:

Result = Reading + Factor

Factor = attenuation caused by cable loss + voltage division factor of AMN

The “**Margin**” column of the following data tables indicates the degree of compliance within the applicable limit. The equation for margin calculation is as follows:

Margin = Limit – Result

## 3.2 Radiation Spurious Emissions

### 3.2.1 Applicable Standard

FCC §15.247 (d);

In any 100 kHz bandwidth outside the frequency band in which the spread spectrum or digitally modulated intentional radiator is operating, the radio frequency power that is produced by the intentional radiator shall be at least 20 dB below that in the 100 kHz bandwidth within the band that contains the highest level of the desired power, based on either an RF conducted or a radiated measurement, provided the transmitter demonstrates compliance with the peak conducted power limits. If the transmitter complies with the conducted power limits based on the use of RMS averaging over a time interval, as permitted under paragraph (b)(3) of this section, the attenuation required under this paragraph shall be 30 dB instead of 20 dB. Attenuation below the general limits specified in §15.209(a) is not required. In addition, radiated emissions which fall in the restricted bands, as defined in §15.205(a), must also comply with the radiated emission limits specified in §15.209(a) (see §15.205(c)).

### 3.2.2 EUT Setup

9kHz~30MHz:

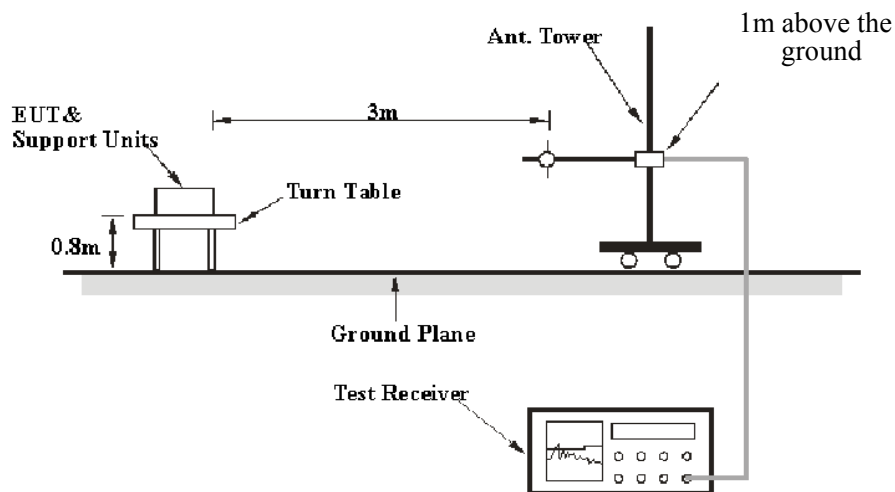

30MHz~1GHz:

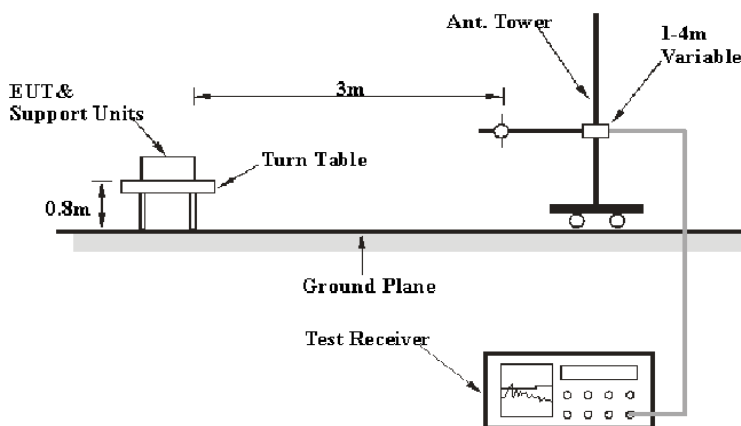

**Above 1GHz:**

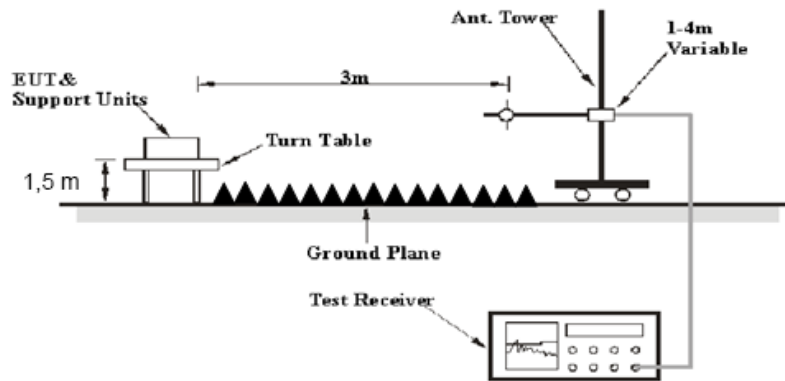

The radiated emissions were performed in the 3 meters distance, using the setup accordance with the ANSI C63.10-2013. The specification used was the FCC 15.209, and FCC 15.247 limits.

The external I/O cables were draped along the test table and formed a bundle 30 to 40 cm long in the middle.

The spacing between the peripherals was 10 cm.

For 9kHz-30MHz test, the lowest height of the magnetic antenna shall be 1 m above the ground and three antenna orientations (parallel, perpendicular, and ground-parallel) shall be measured.

**3.2.3 EMI Test Receiver & Spectrum Analyzer Setup**

The system was investigated from 9kHz to 25 GHz.

During the radiated emission test, the EMI test receiver & Spectrum Analyzer Setup were set with the following configurations:

9kHz-1000MHz:

Frequency Range	RBW	Video B/W	IF B/W	Measurement
9 kHz – 150 kHz	200 Hz	1 kHz	/	PK
	/	/	200 Hz	QP/AV
150 kHz – 30 MHz	9 kHz	30 kHz	/	PK
	/	/	9 kHz	QP/AV
30 MHz – 1000 MHz	100 kHz	300 kHz	/	PK
	/	/	120 kHz	QP

1GHz- 25GHz:

Measurement	Duty cycle	RBW	Video B/W
PK	Any	1MHz	3 MHz
Ave.	>98%	1MHz	10 Hz
	<98%	1MHz	≥1/T

Note: T is minimum transmission duration

If the maximized peak measured value complies with under the QP/Average limit more than 6dB, then it is unnecessary to perform an QP/Average measurement.

### 3.2.4 Test Procedure

Maximizing procedure was performed on the highest emissions to ensure that the EUT complied with all installation combinations.

Data was recorded in Quasi-peak detection mode for frequency range of 9 kHz-1 GHz except 9 – 90 kHz, 110 – 490 kHz, employing an average detector, peak and Average detection modes for frequencies above 1 GHz.

All emissions under the average limit and under the noise floor have not recorded in the report.

### 3.2.5 Corrected Amplitude & Margin Calculation

The basic equation is as follows:

Result = Reading + Factor

Factor = Antenna Factor + Cable Loss- Amplifier Gain

The “**Margin**” column of the following data tables indicates the degree of compliance within the applicable limit. The equation for margin calculation is as follows:

Margin = Limit – Result



### 3.3 Minimum 6 dB Bandwidth

#### 3.3.1 Applicable Standard

FCC §15.247 (a)(2)

Systems using digital modulation techniques may operate in the 902-928 MHz, 2400-2483.5 MHz, and 5725-5850 MHz bands. The minimum 6 dB bandwidth shall be at least 500 kHz.

#### 3.3.2 EUT Setup

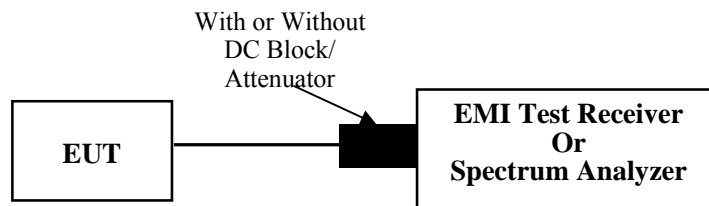

#### 3.3.3 Test Procedure

According to ANSI C63.10-2013 Section 11.8

- a) Set RBW = 100 kHz.
- b) Set the video bandwidth (VBW)  $\geq 3 \times$  RBW.
- c) Detector = Peak.
- d) Trace mode = max hold.
- e) Sweep = auto couple.
- f) Allow the trace to stabilize.
- g) Measure the maximum width of the emission that is constrained by the frequencies associated with the two outermost amplitude points (upper and lower frequencies) that are attenuated by 6 dB relative to the maximum level measured in the fundamental emission.

### 3.4 Maximum Conducted Output Power

#### 3.4.1 Applicable Standard

FCC §15.247 (b)(3)

For systems using digital modulation in the 902-928 MHz, 2400-2483.5 MHz, and 5725-5850 MHz bands: 1 Watt. As an alternative to a peak power measurement, compliance with the one Watt limit can be based on a measurement of the maximum conducted output power. Maximum Conducted Output Power is defined as the total transmit power delivered to all antennas and antenna elements averaged across all symbols in the signaling alphabet when the transmitter is operating at its maximum power control level. Power must be summed across all antennas and antenna elements. The average must not include any time intervals during which the transmitter is off or is transmitting at a reduced power level. If multiple modes of operation are possible (e.g., alternative modulation methods), the maximum conducted output power is the highest total transmit power occurring in any mode.

#### 3.4.2 EUT Setup

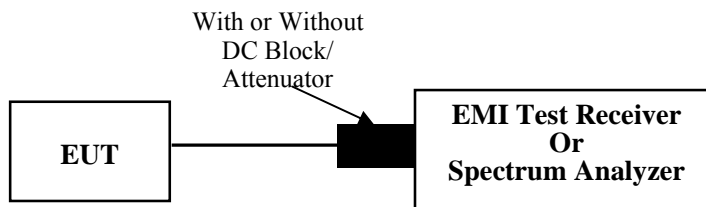

#### 3.4.3 Test Procedure

According to ANSI C63.10-2013 Section 11.9.1.1

The following procedure shall be used when an instrument with a resolution bandwidth that is greater than the DTS bandwidth is available to perform the measurement:

- a) Set the RBW  $\geq$  DTS bandwidth.
- b) Set VBW  $\geq$   $[3 \times \text{RBW}]$ .
- c) Set span  $\geq$   $[3 \times \text{RBW}]$ .
- d) Sweep time = auto couple.
- e) Detector = peak.
- f) Trace mode = max hold.
- g) Allow trace to fully stabilize.
- h) Use peak marker function to determine the peak amplitude level.

### 3.5 Maximum Power Spectral Density

#### 3.5.1 Applicable Standard

FCC §15.247 (e)

For digitally modulated systems, the power spectral density conducted from the intentional radiator to the antenna shall not be greater than 8 dBm in any 3 kHz band during any time interval of continuous transmission. This power spectral density shall be determined in accordance with the provisions of paragraph (b) of this section. The same method of determining the conducted output power shall be used to determine the power spectral density.

#### 3.5.2 EUT Setup

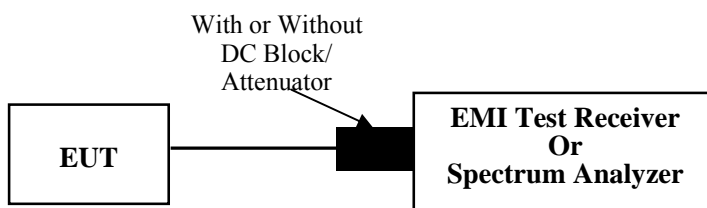

#### 3.5.3 Test Procedure

According to ANSI C63.10-2013 Section 11.10.2

- a) Set analyzer center frequency to DTS channel center frequency.
- b) Set the span to 1.5 times the DTS bandwidth.
- c) Set the RBW to  $3 \text{ kHz} \leq \text{RBW} \leq 100 \text{ kHz}$ .
- d) Set the VBW  $\geq [3 \times \text{RBW}]$ .
- e) Detector = peak.
- f) Sweep time = auto couple.
- g) Trace mode = max hold.
- h) Allow trace to fully stabilize.
- i) Use the peak marker function to determine the maximum amplitude level within the RBW.
- j) If measured value exceeds requirement, then reduce RBW (but no less than 3 kHz) and repeat.

### 3.6 100 kHz Bandwidth of Frequency Band Edge

#### 3.6.1 Applicable Standard

FCC §15.247 (d);

In any 100 kHz bandwidth outside the frequency band in which the spread spectrum or digitally modulated intentional radiator is operating, the radio frequency power that is produced by the intentional radiator shall be at least 20 dB below that in the 100 kHz bandwidth within the band that contains the highest level of the desired power, based on either an RF conducted or a radiated measurement, provided the transmitter demonstrates compliance with the peak conducted power limits. If the transmitter complies with the conducted power limits based on the use of RMS averaging over a time interval, as permitted under paragraph (b)(3) of this section, the attenuation required under this paragraph shall be 30 dB instead of 20 dB. Attenuation below the general limits specified in §15.209(a) is not required. In addition, radiated emissions which fall in the restricted bands, as defined in §15.205(a), must also comply with the radiated emission limits specified in §15.209(a) (see §15.205(c)).

#### 3.6.2 EUT Setup

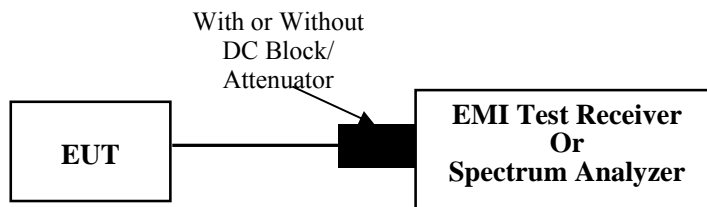

#### 3.6.3 Test Procedure

According to ANSI C63.10-2013 Section 11.11

- a) Set the center frequency and span to encompass frequency range to be measured.
- b) Set the RBW = 100 kHz.
- c) Set the VBW  $\geq [3 \times \text{RBW}]$ .
- d) Detector = peak.
- e) Sweep time = auto couple.
- f) Trace mode = max hold.
- g) Allow trace to fully stabilize.
- h) Use the peak marker function to determine the maximum amplitude level.

Ensure that the amplitude of all unwanted emissions outside of the authorized frequency band (excluding restricted frequency bands) is attenuated by at least the minimum requirements specified in 11.11. Report the three highest emissions relative to the limit.

### 3.7 Duty Cycle

#### 3.7.1 EUT Setup

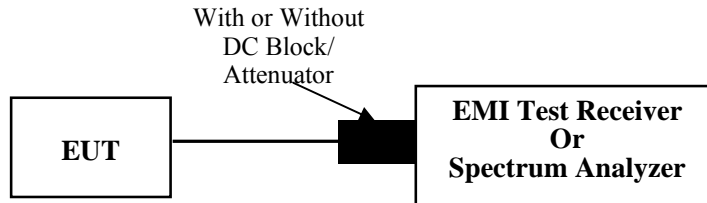

#### 3.7.2 Test Procedure

According to ANSI C63.10-2013 Section 11.6

The zero-span mode on a spectrum analyzer or EMI receiver if the response time and spacing between bins on the sweep are sufficient to permit accurate measurements of the ON and OFF times of the transmitted signal:

- 1) Set the center frequency of the instrument to the center frequency of the transmission.
- 2) Set  $RBW \geq OBW$  if possible; otherwise, set RBW to the largest available value.
- 3) Set  $VBW \geq RBW$ . Set detector = peak or average.
- 4) The zero-span measurement method shall not be used unless both RBW and VBW are  $> 50/T$  and the number of sweep points across duration T exceeds 100. (For example, if VBW and/or RBW are limited to 3 MHz, then the zero-span method of measuring the duty cycle shall not be used if  $T \leq 16.7 \mu s$ .)

### 3.8 Antenna Requirement

#### 3.8.1 Applicable Standard

FCC §15.203

An intentional radiator shall be designed to ensure that no antenna other than that furnished by the responsible party shall be used with the device. The use of a permanently attached antenna or of an antenna that uses a unique coupling to the intentional radiator shall be considered sufficient to comply with the provisions of this section. The manufacturer may design the unit so that a broken antenna can be replaced by the user, but the use of a standard antenna jack or electrical connector is prohibited. This requirement does not apply to carrier current devices or to devices operated under the provisions of §§15.211, 15.213, 15.217, 15.219, 15.221, or §15.236. Further, this requirement does not apply to intentional radiators that must be professionally installed, such as perimeter protection systems and some field disturbance sensors, or to other intentional radiators which, in accordance with §15.31(d), must be measured at the installation site. However, the installer shall be responsible for ensuring that the proper antenna is employed so that the limits in this part are not exceeded.

#### 3.8.2 Judgment

**Compliant.** Please refer to the Antenna Information detail in Section 1.

## 4. Test DATA AND RESULTS

### 4.1 AC Line Conducted Emissions

Serial Number:	2DS2-2	Test Date:	2023/12/14
Test Site:	CE	Test Mode:	Transmitting(maximum output power mode, low channel)
Tester:	David Huang	Test Result:	Pass

#### Environmental Conditions:

Temperature: (°C)	27.7	Relative Humidity: (%)	49	ATM Pressure: (kPa)	101.4
----------------------	------	---------------------------	----	------------------------	-------

#### Test Equipment List and Details:

Manufacturer	Description	Model	Serial Number	Calibration Date	Calibration Due Date
R&S	LISN	ENV216	101134	2023/3/31	2024/3/30
R&S	EMI Test Receiver	ESR3	102726	2023/3/31	2024/3/30
MICRO-COAX	Coaxial Cable	UTIFLEX	C-0200-01	2023/8/6	2024/8/5
Audix	Test Software	E3	190306 (V9)	N/A	N/A

*\* Statement of Traceability: China Certification ICT Co., Ltd (Dongguan) attests that all calibrations have been performed, traceable to National Primary Standards and International System of Units (SI).*

Project No.: CR231167748-RF  
 Tester: David Huang  
 Port: Line  
 Note: POE BLE

Date: 2023-12-14

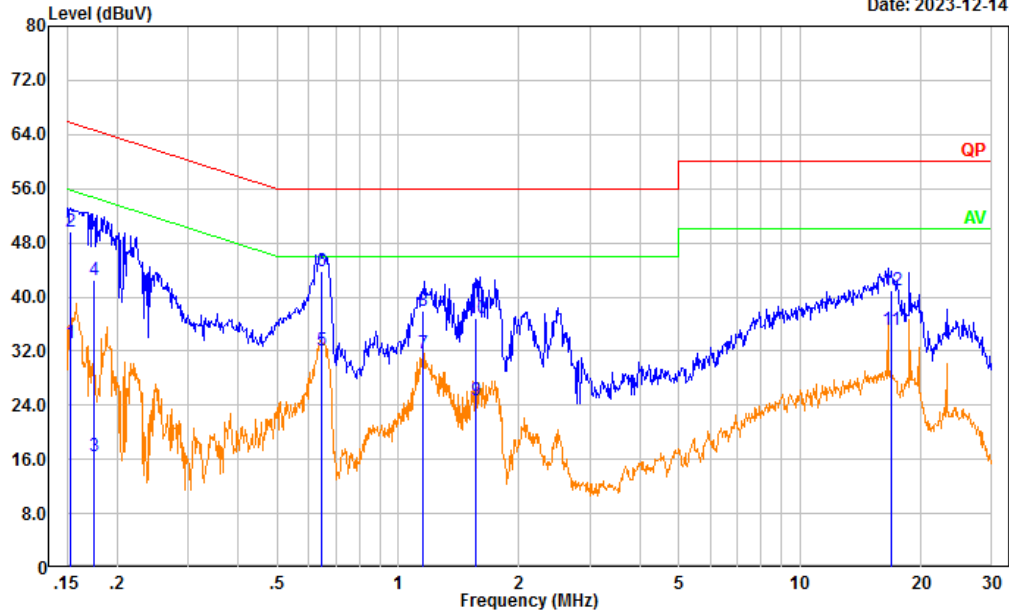

No.	Frequency (MHz)	Reading (dBuV)	Factor (dB)	Result (dBuV)	Limit (dBuV)	Margin (dB)	Detector
1	0.154	23.55	9.61	33.16	55.80	22.64	Average
2	0.154	40.12	9.61	49.73	65.80	16.07	QP
3	0.176	6.95	9.61	16.56	54.68	38.12	Average
4	0.176	32.84	9.61	42.45	64.68	22.23	QP
5	0.646	22.41	9.62	32.03	46.00	13.97	Average
6	0.646	34.12	9.62	43.74	56.00	12.26	QP
7	1.156	22.07	9.62	31.69	46.00	14.31	Average
8	1.156	28.38	9.62	38.00	56.00	18.00	QP
9	1.561	15.09	9.63	24.72	46.00	21.28	Average
10	1.561	27.33	9.63	36.96	56.00	19.04	QP
11	16.894	25.43	9.73	35.16	50.00	14.84	Average
12	16.894	31.27	9.73	41.00	60.00	19.00	QP

Project No.: CR231167748-RF  
 Tester: David Huang  
 Port: neutral  
 Note: POE BLE

Date: 2023-12-14

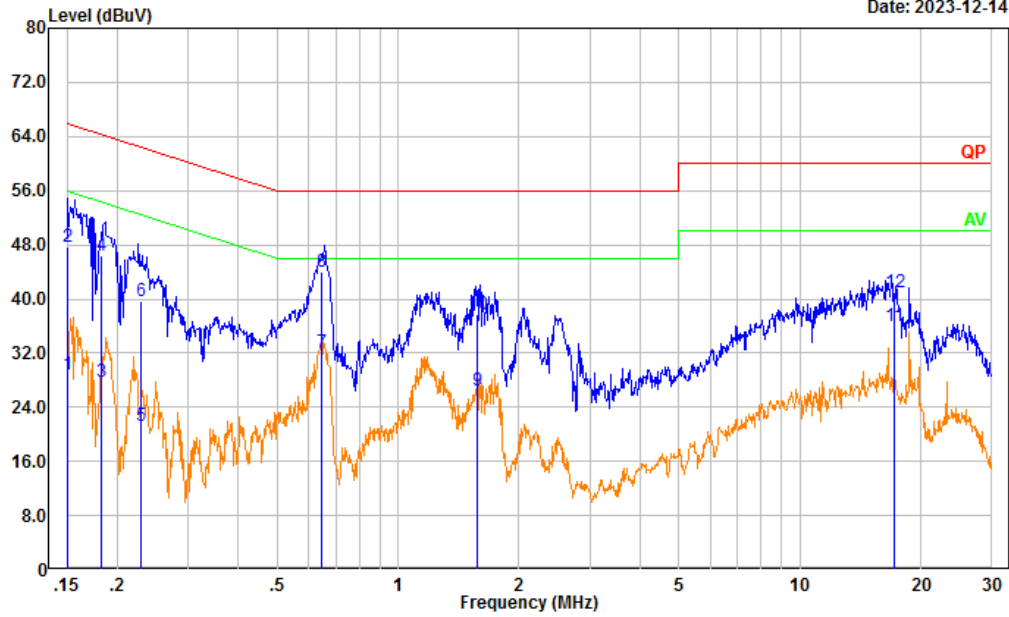

No.	Frequency (MHz)	Reading (dBμV)	Factor (dB)	Result (dBμV)	Limit (dBμV)	Margin (dB)	Detector
1	0.150	19.25	9.61	28.86	55.98	27.12	Average
2	0.150	38.11	9.61	47.72	65.98	18.26	QP
3	0.183	18.23	9.61	27.84	54.34	26.50	Average
4	0.183	36.72	9.61	46.33	64.34	18.01	QP
5	0.229	11.72	9.61	21.33	52.47	31.14	Average
6	0.229	29.98	9.61	39.59	62.47	22.88	QP
7	0.645	22.56	9.62	32.18	46.00	13.82	Average
8	0.645	34.33	9.62	43.95	56.00	12.05	QP
9	1.577	16.85	9.63	26.48	46.00	19.52	Average
10	1.577	28.09	9.63	37.72	56.00	18.28	QP
11	17.158	26.21	9.69	35.90	50.00	14.10	Average
12	17.158	31.39	9.69	41.08	60.00	18.92	QP



## 4.2 Radiation Spurious Emissions

Serial Number:	2DS2-2	Test Date:	2023/12/21~2024/1/4
Test Site:	966-2,966-1	Test Mode:	Transmitting
Tester:	Jeff Luo, Tao Zhu	Test Result:	Pass

### Environmental Conditions:

Temperature: (°C)	24~25.7	Relative Humidity: (%)	35~59	ATM Pressure: (kPa)	101.5~102.1
----------------------	---------	---------------------------	-------	------------------------	-------------

### Test Equipment List and Details:

Manufacturer	Description	Model	Serial Number	Calibration Date	Calibration Due Date
<b>Radiation Spurious Emissions Below 1GHz</b>					
Sunol Sciences	Antenna	JB6	A082520-6	2023/9/18	2026/9/17
BACL	Loop Antenna	1313-1P	3092721	2023/10/20	2026/10/19
R&S	EMI Test Receiver	ESR3	102724	2023/3/31	2024/3/30
TIMES MICROWAVE	Coaxial Cable	LMR-600-UltraFlex	C-0470-02	2023/7/16	2024/7/15
TIMES MICROWAVE	Coaxial Cable	LMR-600-UltraFlex	C-0780-01	2023/7/16	2024/7/15
Sonoma	Amplifier	310N	186165	2023/7/16	2024/7/15
Audix	Test Software	E3	201021 (V9)	N/A	N/A
<b>Radiation Spurious Emissions Above 1GHz</b>					
AH	Double Ridge Guide Horn Antenna	SAS-571	1394	2023/2/22	2026/2/21
R&S	Spectrum Analyzer	FSV40	101591	2023/3/31	2024/3/30
MICRO-COAX	Coaxial Cable	UFA210A-1-1200-70U300	217423-008	2023/8/6	2024/8/5
MICRO-COAX	Coaxial Cable	UFA210A-1-2362-300300	235780-001	2023/8/6	2024/8/5
Mini	Pre-amplifier	ZVA-183-S+	5969001149	2023/11/8	2024/11/7
Audix	Test Software	E3	201021 (V9)	N/A	N/A
PASTERNAK	Horn Antenna	PE9852/2F-20	112002	2021/2/5	2024/2/4
Quinstar	Preamplifier	QLW-18405536-JO	15964001005	2023/9/15	2024/9/14
MICRO-COAX	Coaxial Cable	UFB142A-1-2362-200200	235772-001	2023/8/6	2024/8/5
E-Microwave	Band Rejection Filter	2400-2483.5MHz	OE01902424	2023/8/6	2024/8/5
Mini Circuits	High Pass Filter	VHF-6010+	31119	2023/8/6	2024/8/5

\* Statement of Traceability: China Certification ICT Co., Ltd (Dongguan) attests that all calibrations have been performed, traceable to National Primary Standards and International System of Units (SI).

### Test Data:

Please refer to the below table and plots.  
After pre-scan in the X, Y and Z axes of orientation, the worst case is below:

**1) 9kHz~30MHz**

The amplitude of spurious emissions attenuated more than 20 dB below the permissible value is not required to be report.

2) 30MHz-1GHz

POE:

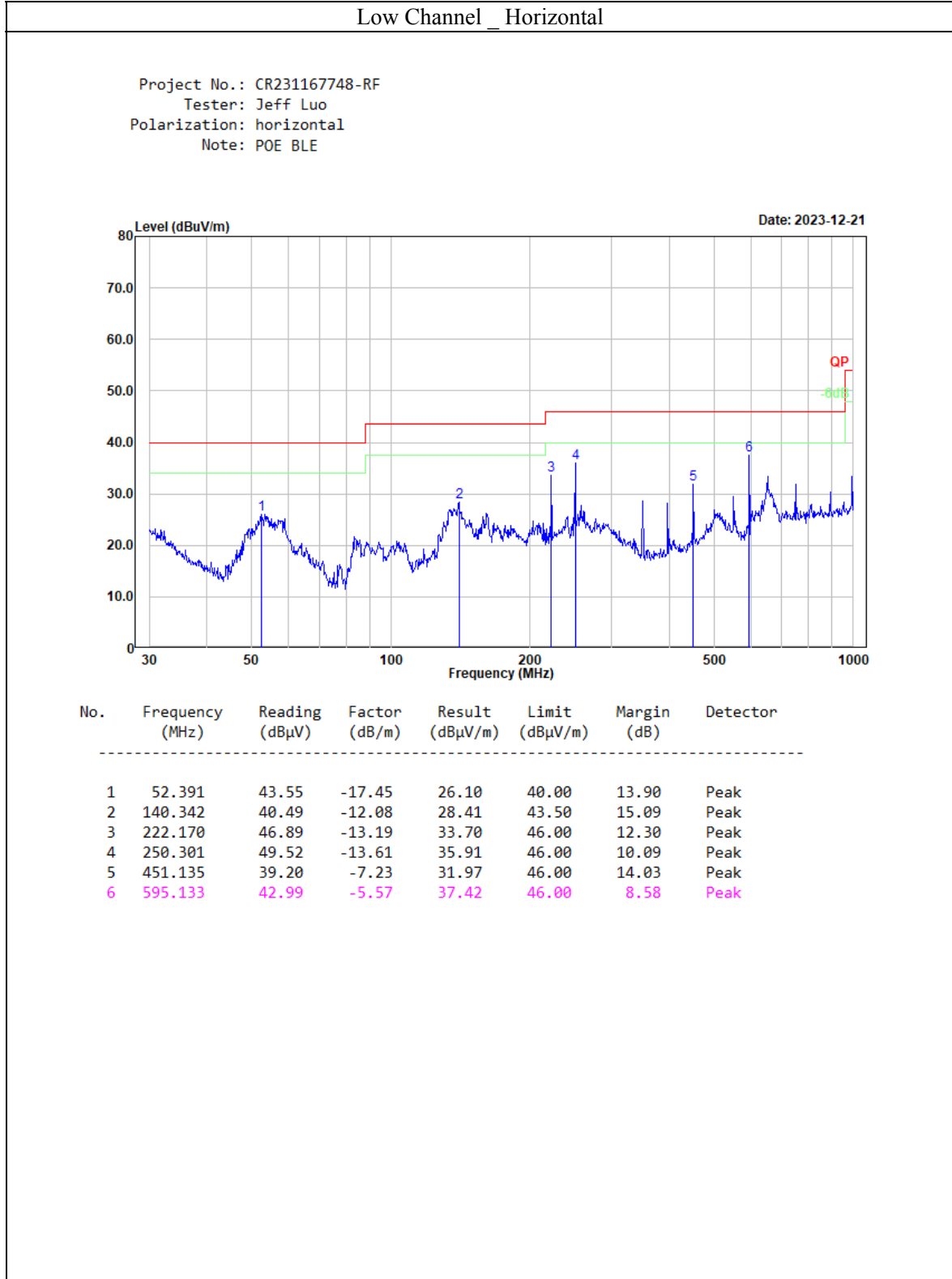

Low Channel \_ Vertical

Project No.: CR231167748-RF  
 Tester: Jeff Luo  
 Polarization: vertical  
 Note: POE BLE

Date: 2023-12-21

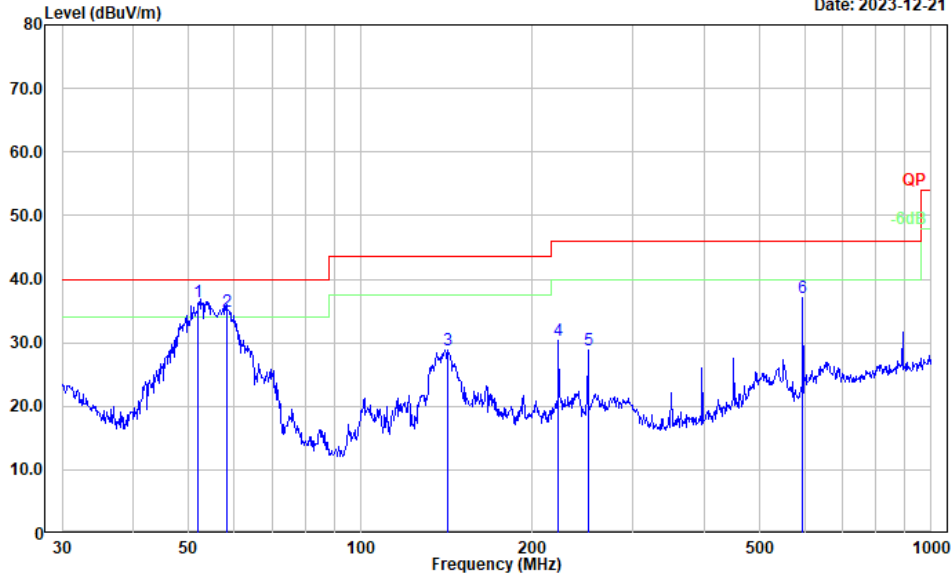

No.	Frequency (MHz)	Reading (dBμV)	Factor (dB/m)	Result (dBμV/m)	Limit (dBμV/m)	Margin (dB)	Detector
1	52.000	53.78	-17.44	36.34	40.00	3.66	QP
2	58.203	52.47	-17.59	34.88	40.00	5.12	QP
3	142.324	40.97	-12.11	28.86	43.50	14.64	Peak
4	222.170	43.59	-13.19	30.40	46.00	15.60	Peak
5	250.301	42.49	-13.61	28.88	46.00	17.12	Peak
6	595.133	42.69	-5.57	37.12	46.00	8.88	Peak

Middle Channel \_ Horizontal

Project No.: CR231167748-RF  
 Tester: Jeff Luo  
 Polarization: horizontal  
 Note: POE BLE

Date: 2023-12-21

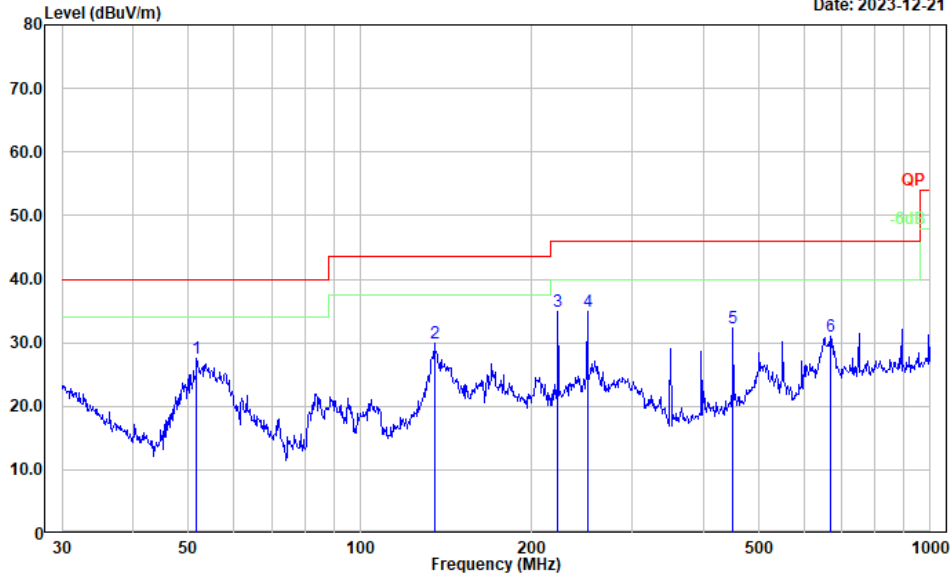

No.	Frequency (MHz)	Reading (dBμV)	Factor (dB/m)	Result (dBμV/m)	Limit (dBμV/m)	Margin (dB)	Detector
1	51.662	45.00	-17.44	27.56	40.00	12.44	Peak
2	135.032	41.73	-11.83	29.90	43.50	13.60	Peak
3	222.170	48.17	-13.19	34.98	46.00	11.02	Peak
4	250.301	48.54	-13.61	34.93	46.00	11.07	Peak
5	451.135	39.62	-7.23	32.39	46.00	13.61	Peak
6	668.142	35.44	-4.43	31.01	46.00	14.99	Peak

Middle Channel \_ Vertical

Project No.: CR231167748-RF  
 Tester: Jeff Luo  
 Polarization: vertical  
 Note: POE BLE

Date: 2023-12-21

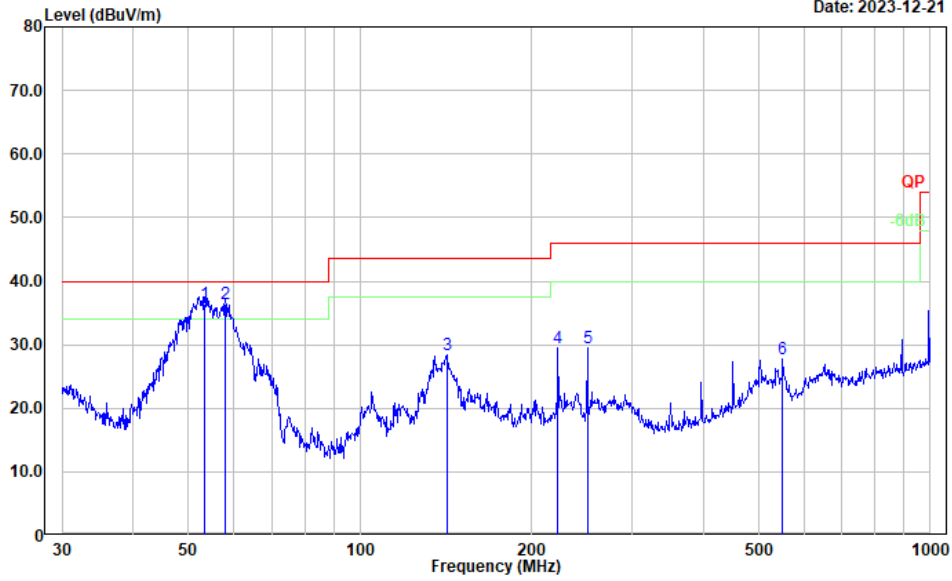

No.	Frequency (MHz)	Reading (dBμV)	Factor (dB/m)	Result (dBμV/m)	Limit (dBμV/m)	Margin (dB)	Detector
1	53.318	54.00	-17.47	36.53	40.00	3.47	QP
2	57.999	53.96	-17.57	36.39	40.00	3.61	QP
3	141.826	40.45	-12.11	28.34	43.50	15.16	Peak
4	222.170	42.71	-13.19	29.52	46.00	16.48	Peak
5	250.301	43.17	-13.61	29.56	46.00	16.44	Peak
6	550.948	33.99	-6.17	27.82	46.00	18.18	Peak

High Channel Horizontal

Project No.: CR231167748-RF  
 Tester: Jeff Luo  
 Polarization: horizontal  
 Note: POE BLE

Date: 2023-12-21

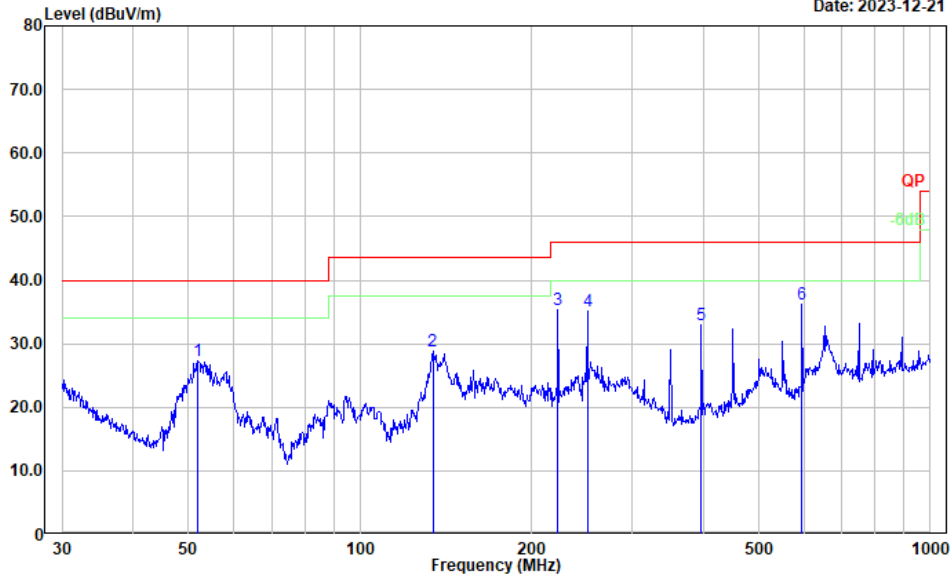

No.	Frequency (MHz)	Reading (dBμV)	Factor (dB/m)	Result (dBμV/m)	Limit (dBμV/m)	Margin (dB)	Detector
1	52.025	44.72	-17.44	27.28	40.00	12.72	Peak
2	134.088	40.62	-11.79	28.83	43.50	14.67	Peak
3	222.170	48.56	-13.19	35.37	46.00	10.63	Peak
4	250.301	48.73	-13.61	35.12	46.00	10.88	Peak
5	396.242	42.07	-9.20	32.87	46.00	13.13	Peak
6	595.133	41.80	-5.57	36.23	46.00	9.77	Peak

High Channel\_Vertical

Project No.: CR231167748-RF  
 Tester: Jeff Luo  
 Polarization: vertical  
 Note: POE BLE

Date: 2023-12-21

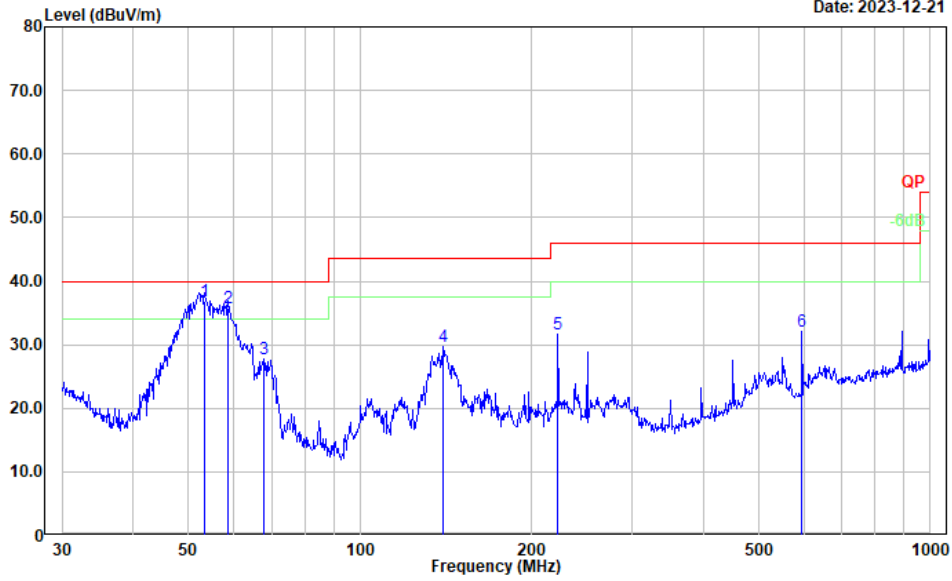

No.	Frequency (MHz)	Reading (dBμV)	Factor (dB/m)	Result (dBμV/m)	Limit (dBμV/m)	Margin (dB)	Detector
1	53.318	54.23	-17.47	36.76	40.00	3.24	QP
2	58.613	53.38	-17.61	35.77	40.00	4.23	QP
3	67.913	44.93	-17.11	27.82	40.00	12.18	Peak
4	139.851	41.65	-12.04	29.61	43.50	13.89	Peak
5	222.170	44.88	-13.19	31.69	46.00	14.31	Peak
6	595.133	37.76	-5.57	32.19	46.00	13.81	Peak



**3) 1-25GHz:****BLE 1Mbps:**

Frequency (MHz)	Receiver		Polar (H/V)	Factor (dB/m)	Result (dB $\mu$ V/m)	Limit (dB $\mu$ V/m)	Margin (dB)
	Reading (dB $\mu$ V)	Detector					
Low Channel:				2402	MHz		
2390.000	26.71	PK	H	31.71	58.42	74.00	15.58
2390.000	13.70	AV	H	31.71	45.41	54.00	8.59
2390.000	26.76	PK	V	31.71	58.47	74.00	15.53
2390.000	13.78	AV	V	31.71	45.49	54.00	8.51
4804.000	37.66	PK	H	11.19	48.85	74.00	25.15
4804.000	24.25	AV	H	11.19	35.44	54.00	18.56
4804.000	38.62	PK	V	11.19	49.81	74.00	24.19
4804.000	25.65	AV	V	11.19	36.84	54.00	17.16
7206.000	33.69	PK	H	15.03	48.72	74.00	25.28
7206.000	20.55	AV	H	15.03	35.58	54.00	18.42
7206.000	33.47	PK	V	15.03	48.50	74.00	25.50
7206.000	20.68	AV	V	15.03	35.71	54.00	18.29
Middle Channel:				2440	MHz		
4880.000	37.56	PK	H	11.48	49.04	74.00	24.96
4880.000	24.25	AV	H	11.48	35.73	54.00	18.27
4880.000	38.63	PK	V	11.48	50.11	74.00	23.89
4880.000	25.69	AV	V	11.48	37.17	54.00	16.83
7320.000	33.55	PK	H	15.58	49.13	74.00	24.87
7320.000	20.52	AV	H	15.58	36.10	54.00	17.90
7320.000	33.69	PK	V	15.58	49.27	74.00	24.73
7320.000	20.58	AV	V	15.58	36.16	54.00	17.84
High Channel:				2480	MHz		
2483.500	26.68	PK	H	32.19	58.87	74.00	15.13
2483.500	13.82	AV	H	32.19	46.01	54.00	7.99
2483.500	26.73	PK	V	32.19	58.92	74.00	15.08
2483.500	13.86	AV	V	32.19	46.05	54.00	7.95
4960.000	37.46	PK	H	11.77	49.23	74.00	24.77
4960.000	21.40	AV	H	11.77	33.17	54.00	20.83
4960.000	38.68	PK	V	11.77	50.45	74.00	23.55
4960.000	25.56	AV	V	11.77	37.33	54.00	16.67
7440.000	33.20	PK	H	15.98	49.18	74.00	24.82
7440.000	20.36	AV	H	15.98	36.34	54.00	17.66
7440.000	33.53	PK	V	15.98	49.51	74.00	24.49
7440.000	20.60	AV	V	15.98	36.58	54.00	17.42

**Worst Radiation Spurious Emissions Margin Test plots (High Channel)**

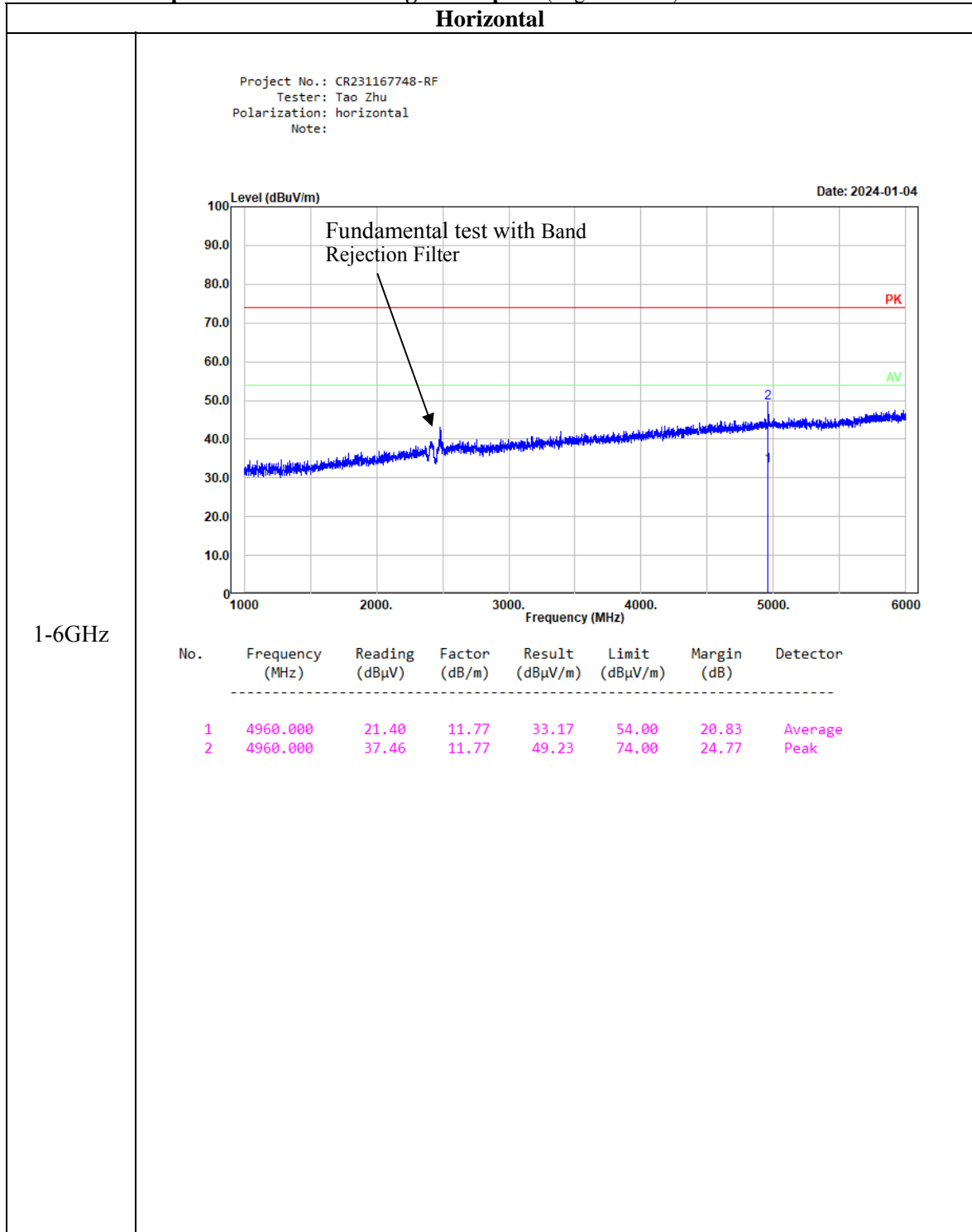

**Horizontal**

Project No.: CR231167748-RF  
 Tester: Tao Zhu  
 Polarization: horizontal  
 Note:

Date: 2024-01-04

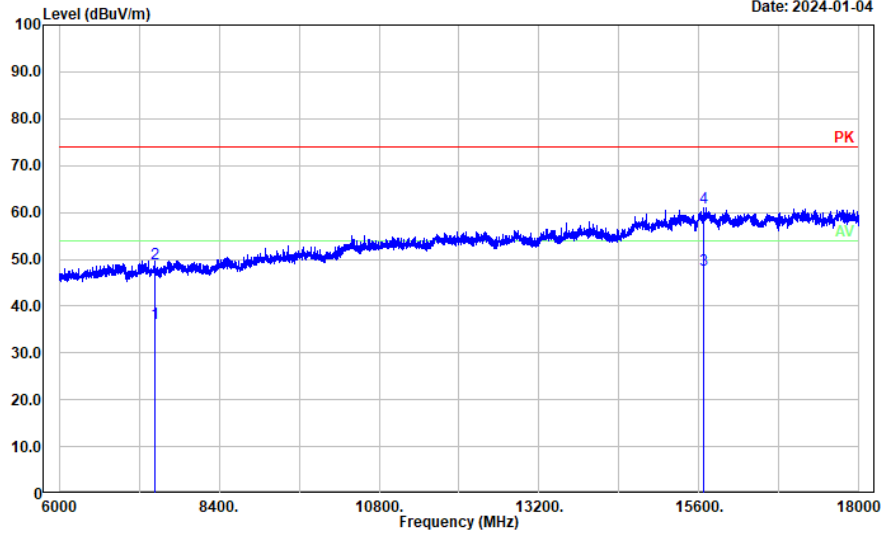

6-18GHz

No.	Frequency (MHz)	Reading (dBμV)	Factor (dB/m)	Result (dBμV/m)	Limit (dBμV/m)	Margin (dB)	Detector
1	7440.000	20.36	15.98	36.34	54.00	17.66	Average
2	7440.000	33.20	15.98	49.18	74.00	24.82	Peak
3	15676.800	22.90	24.76	47.66	54.00	6.34	Average
4	15676.800	36.19	24.76	60.95	74.00	13.05	Peak

**Horizontal**

Project No.: CR231167748-RF  
 Tester: Tao Zhu  
 Polarization: Horizontal  
 Note:

Date: 2024-01-04

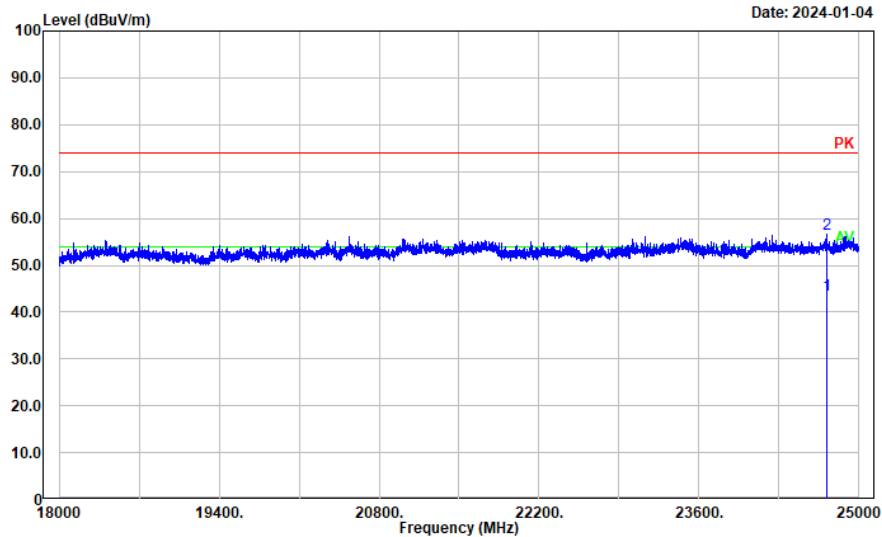

18-25GHz

No.	Frequency (MHz)	Reading (dBμV)	Factor (dB/m)	Result (dBμV/m)	Limit (dBμV/m)	Margin (dB)	Detector
1	24721.400	38.17	5.40	43.57	54.00	10.43	Average
2	24721.400	51.14	5.40	56.54	74.00	17.46	Peak

**Vertical**

Project No.: CR231167748-RF  
 Tester: Tao Zhu  
 Polarization: vertical  
 Note:

Date: 2024-01-04

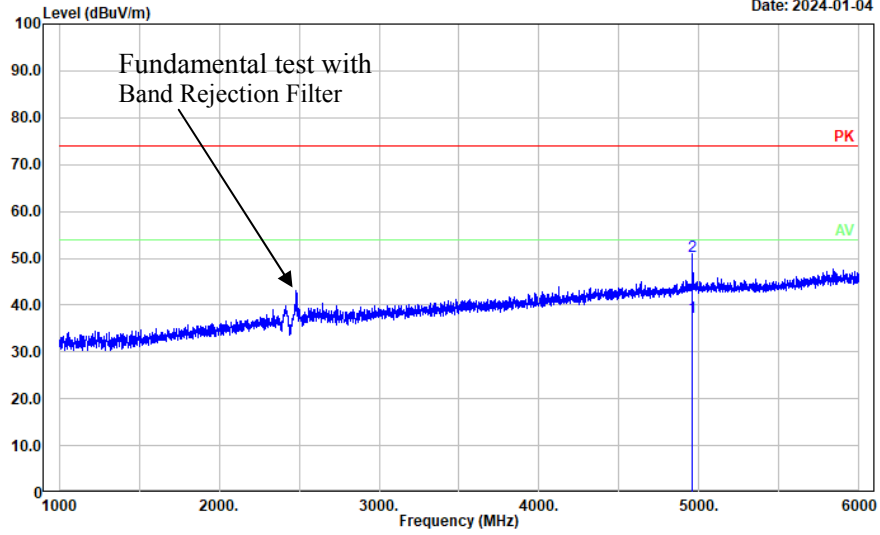

1-6GHz

No.	Frequency (MHz)	Reading (dBμV)	Factor (dB/m)	Result (dBμV/m)	Limit (dBμV/m)	Margin (dB)	Detector
1	4960.000	25.56	11.77	37.33	54.00	16.67	Average
2	4960.000	38.68	11.77	50.45	74.00	23.55	Peak

**Vertical**

Project No.: CR231167748-RF  
 Tester: Tao Zhu  
 Polarization: vertical  
 Note:

Date: 2024-01-04

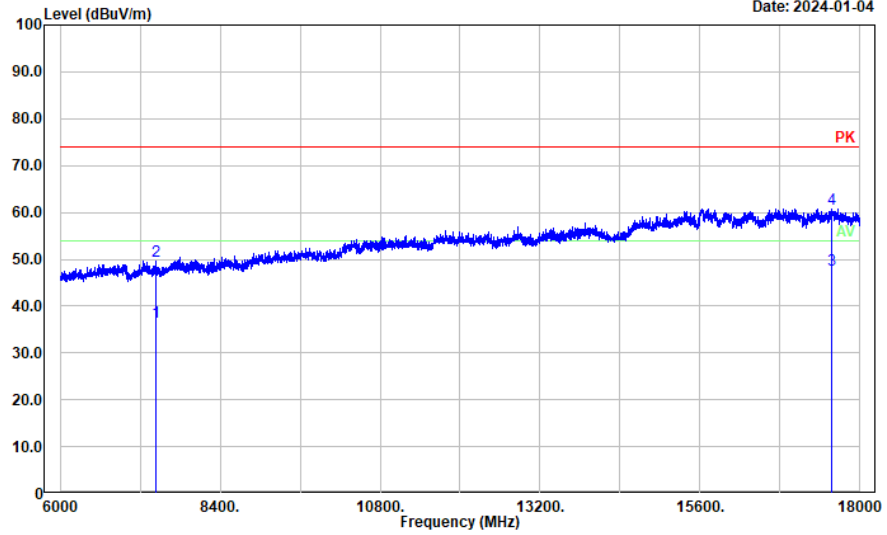

6-18GHz

No.	Frequency (MHz)	Reading (dBμV)	Factor (dB/m)	Result (dBμV/m)	Limit (dBμV/m)	Margin (dB)	Detector
1	7440.000	20.60	15.98	36.58	54.00	17.42	Average
2	7440.000	33.53	15.98	49.51	74.00	24.49	Peak
3	17580.000	17.17	30.48	47.65	54.00	6.35	Average
4	17580.000	30.35	30.48	60.83	74.00	13.17	Peak

**Vertical**

Project No.: CR231167748-RF  
 Tester: Tao Zhu  
 Polarization: Vertical  
 Note:

Date: 2024-01-04

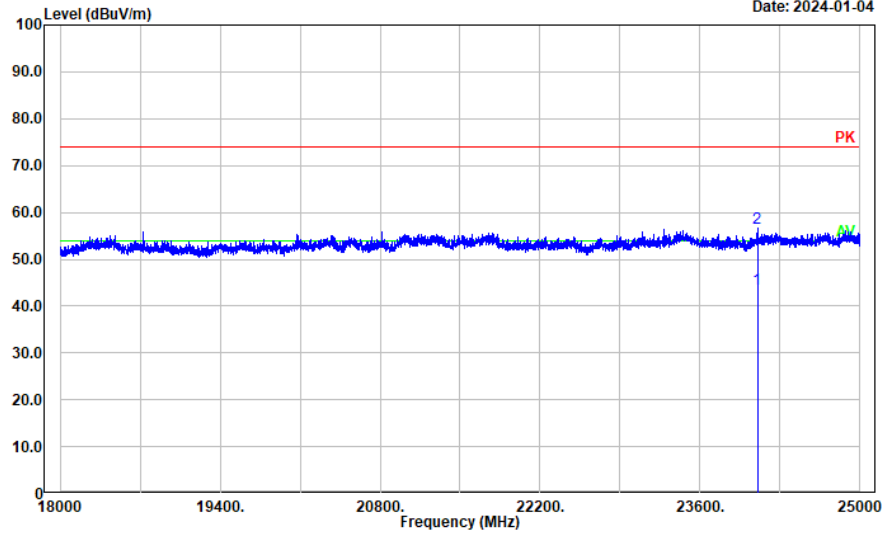

18-25GHz

No.	Frequency (MHz)	Reading (dBμV)	Factor (dB/m)	Result (dBμV/m)	Limit (dBμV/m)	Margin (dB)	Detector
1	24101.200	38.75	4.83	43.58	54.00	10.42	Average
2	24101.200	51.69	4.83	56.52	74.00	17.48	Peak

**4.3 6 dB Emission Bandwidth**

Serial Number:	2DS2-1	Test Date:	2023/12/29
Test Site:	RF	Test Mode:	Transmitting
Tester:	Morpheus Shi	Test Result:	Pass

**Environmental Conditions:**

Temperature: (°C)	23.7	Relative Humidity: (%)	45	ATM Pressure: (kPa)	101.5
----------------------	------	---------------------------	----	------------------------	-------

**Test Equipment List and Details:**

Manufacturer	Description	Model	Serial Number	Calibration Date	Calibration Due Date
R&S	Spectrum Analyzer	FSU26	200445	2023/3/31	2024/3/30
zhuoxiang	Coaxial Cable	SMA-178	211001	Each time	N/A
Mini-Circuits	DC Block	BLK-18-S+	1554403	Each time	N/A

\* Statement of Traceability: China Certification ICT Co., Ltd (Dongguan) attests that all calibrations have been performed, traceable to National Primary Standards and International System of Units (SI).

**Test Data:**

Test Modes	Test Frequency (MHz)	6 dB Bandwidth (MHz)	Limit (MHz)
BLE 1Mbps	2402	0.504	$\geq 0.5$
	2440	0.504	$\geq 0.5$
	2480	0.504	$\geq 0.5$



<b>6dB Emission Bandwidth</b>	
BLE 1Mbps Lowest Channel	<p>ProjectNo.:CR231167748-RF Tester:Morpheus Shi Date: 29.DEC.2023 23:10:10</p>
BLE 1Mbps Middle Channel	<p>ProjectNo.:CR231167748-RF Tester:Morpheus Shi Date: 29.DEC.2023 23:11:45</p>
BLE 1Mbps Highest Channel	<p>ProjectNo.:CR231167748-RF Tester:Morpheus Shi Date: 29.DEC.2023 23:13:33</p>

**4.4 Maximum Conducted Output Power**

Serial Number:	2DS2-1	Test Date:	2023/12/29
Test Site:	RF	Test Mode:	Transmitting
Tester:	Morpheus Shi	Test Result:	Pass

**Environmental Conditions:**

Temperature: (°C)	23.7	Relative Humidity: (%)	45	ATM Pressure: (kPa)	101.5
----------------------	------	---------------------------	----	------------------------	-------

**Test Equipment List and Details:**

Manufacturer	Description	Model	Serial Number	Calibration Date	Calibration Due Date
R&S	Spectrum Analyzer	FSU26	200445	2023/3/31	2024/3/30
zhuoxiang	Coaxial Cable	SMA-178	211001	Each time	N/A
Mini-Circuits	DC Block	BLK-18-S+	1554403	Each time	N/A

\* Statement of Traceability: China Certification ICT Co., Ltd (Dongguan) attests that all calibrations have been performed, traceable to National Primary Standards and International System of Units (SI).

**Test Data:**

Test Modes	Test Frequency (MHz)	Maximum Peak Conducted Output Power (dBm)	Limit (dBm)
BLE 1Mbps	2402	4.09	≤30
	2440	3.98	≤30
	2480	4.01	≤30

### Maximum Conducted Peak Output Power

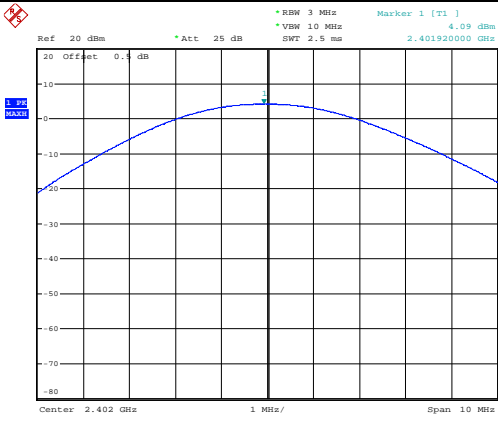
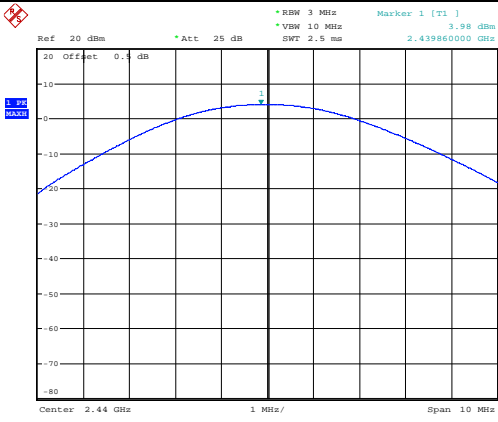
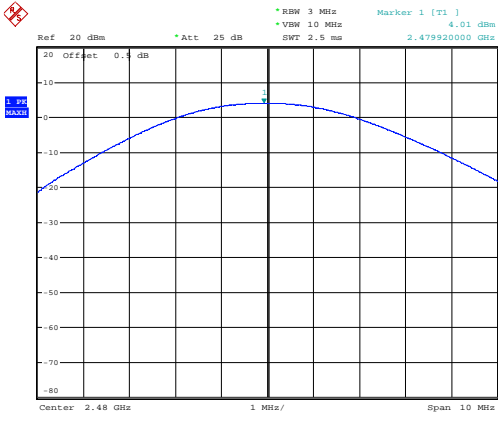
<p>BLE 1Mbps Lowest Channel</p>	 <p>ProjectNo.:CR231167748-RF Tester:Morpheus Shi Date: 29.DEC.2023 23:18:25</p>
<p>BLE 1Mbps Middle Channel</p>	 <p>ProjectNo.:CR231167748-RF Tester:Morpheus Shi Date: 29.DEC.2023 23:17:51</p>
<p>BLE 1Mbps Highest Channel</p>	 <p>ProjectNo.:CR231167748-RF Tester:Morpheus Shi Date: 29.DEC.2023 23:17:04</p>

#### 4.5 Maximum Power Spectral Density

Serial Number:	2DS2-1	Test Date:	2023/12/29
Test Site:	RF	Test Mode:	Transmitting
Tester:	Morpheus Shi	Test Result:	Pass

#### Environmental Conditions:

Temperature: (°C)	23.7	Relative Humidity: (%)	45	ATM Pressure: (kPa)	101.5
----------------------	------	---------------------------	----	------------------------	-------

#### Test Equipment List and Details:

Manufacturer	Description	Model	Serial Number	Calibration Date	Calibration Due Date
R&S	Spectrum Analyzer	FSU26	200445	2023/3/31	2024/3/30
zhuoxiang	Coaxial Cable	SMA-178	211001	Each time	N/A
Mini-Circuits	DC Block	BLK-18-S+	1554403	Each time	N/A

\* Statement of Traceability: China Certification ICT Co., Ltd (Dongguan) attests that all calibrations have been performed, traceable to National Primary Standards and International System of Units (SI).

#### Test Data:

Test Modes	Test Frequency (MHz)	Power Spectral Density (dBm/3kHz)	Limit (dBm/3kHz)
BLE 1Mbps	2402	-6.43	≤8.00
	2440	-6.50	≤8.00
	2480	-6.49	≤8.00

### Maximum Power Spectral Density

BLE 1Mbps  
Lowest Channel

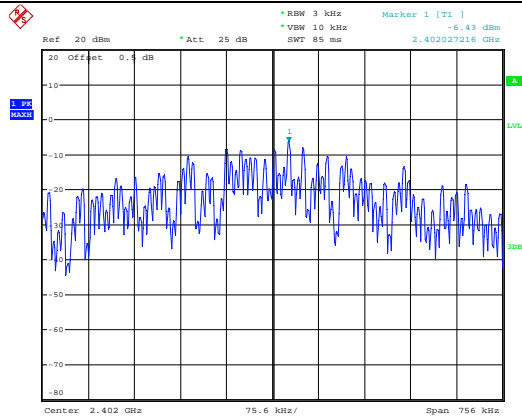

ProjectNo.:CR231167748-RF    Tester:Morpheus Shi  
 Date: 29.DEC.2023 23:19:38

BLE 1Mbps  
Middle Channel

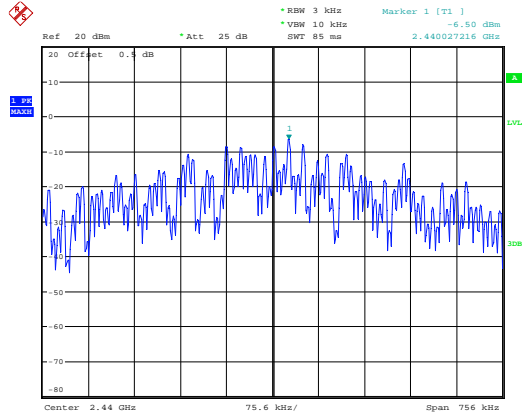

ProjectNo.:CR231167748-RF    Tester:Morpheus Shi  
 Date: 29.DEC.2023 23:20:27

BLE 1Mbps  
Highest Channel

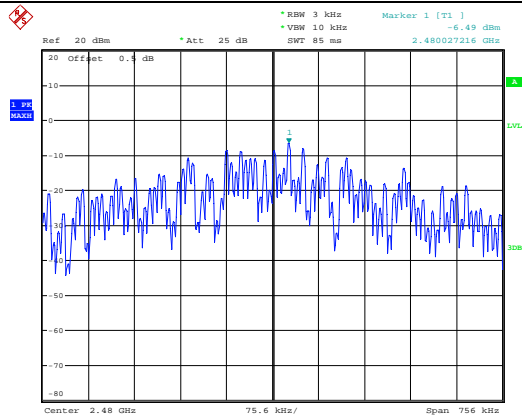

ProjectNo.:CR231167748-RF    Tester:Morpheus Shi  
 Date: 29.DEC.2023 23:20:57

**4.6 100 kHz Bandwidth of Frequency Band Edge**

Serial Number:	2DS2-1	Test Date:	2023/12/29
Test Site:	RF	Test Mode:	Transmitting
Tester:	Morpheus Shi	Test Result:	Pass

**Environmental Conditions:**

Temperature: (°C)	23.7	Relative Humidity: (%)	45	ATM Pressure: (kPa)	101.5
----------------------	------	---------------------------	----	------------------------	-------

**Test Equipment List and Details:**

Manufacturer	Description	Model	Serial Number	Calibration Date	Calibration Due Date
R&S	Spectrum Analyzer	FSU26	200445	2023/3/31	2024/3/30
zhuoxiang	Coaxial Cable	SMA-178	211001	Each time	N/A
Mini-Circuits	DC Block	BLK-18-S+	1554403	Each time	N/A

\* Statement of Traceability: China Certification ICT Co., Ltd (Dongguan) attests that all calibrations have been performed, traceable to National Primary Standards and International System of Units (SI).

**Test Data:**

### 100 kHz Bandwidth of Frequency Band Edge

BLE 1Mbps  
Lowest Band edge

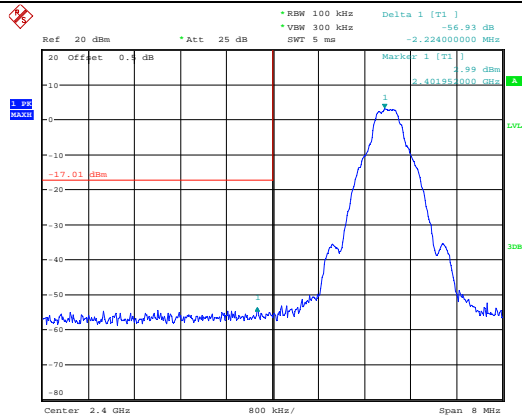

ProjectNo.:CR231167748-RF    Tester:Morpheus Shi  
 Date: 29.DEC.2023 23:15:56

BLE 1Mbps  
Highest Band edge

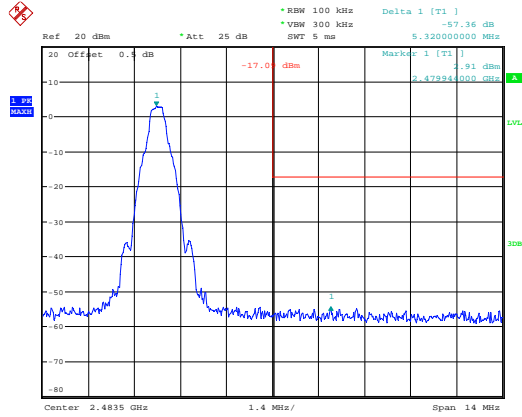

ProjectNo.:CR231167748-RF    Tester:Morpheus Shi  
 Date: 29.DEC.2023 23:16:32

**4.7 Duty Cycle**

Serial Number:	2DS2-1	Test Date:	2023/12/29
Test Site:	RF	Test Mode:	Transmitting
Tester:	Morpheus Shi	Test Result:	N/A

**Environmental Conditions:**

Temperature: (°C)	23.7	Relative Humidity: (%)	45	ATM Pressure: (kPa)	101.5
----------------------	------	---------------------------	----	------------------------	-------

**Test Equipment List and Details:**

Manufacturer	Description	Model	Serial Number	Calibration Date	Calibration Due Date
R&S	Spectrum Analyzer	FSU26	200445	2023/3/31	2024/3/30
zhuoxiang	Coaxial Cable	SMA-178	211001	Each time	N/A
Mini-Circuits	DC Block	BLK-18-S+	1554403	Each time	N/A

\* Statement of Traceability: China Certification ICT Co., Ltd (Dongguan) attests that all calibrations have been performed, traceable to National Primary Standards and International System of Units (SI).

**Test Data:**

Test Channel	Ton (ms)	Ton+off (ms)	Duty cycle (%)	1/T (Hz)	VBW Setting (kHz)
Middle	100	100	100.00	/	0.01

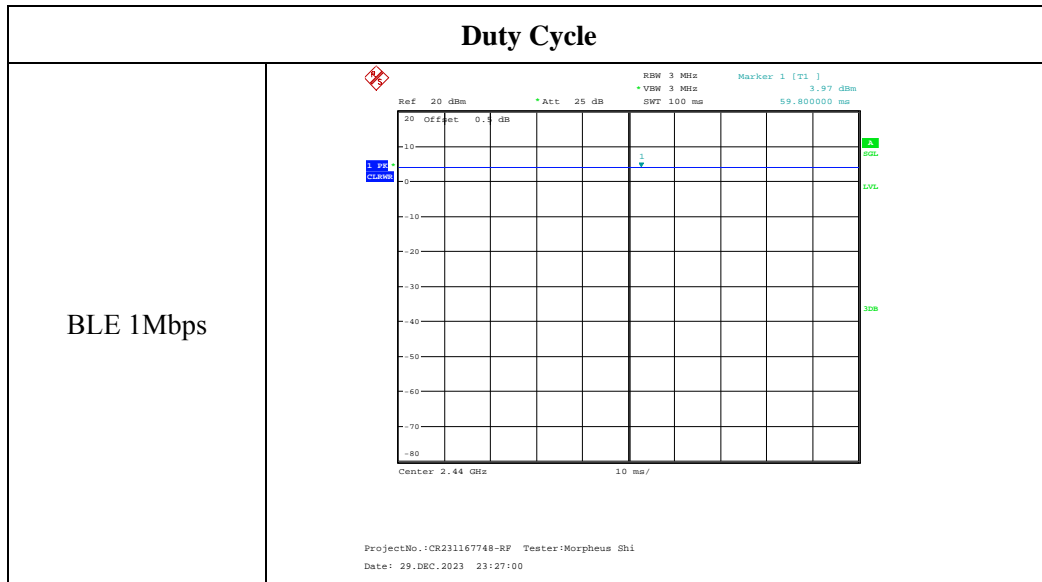



## **5. EUT PHOTOGRAPHS**

---

Please refer to the attachment CR231167748-EXP EUT EXTERNAL PHOTOGRAPHS and CR231167748-INP EUT INTERNAL PHOTOGRAPHS

## **6. TEST SETUP PHOTOGRAPHS**

---

Please refer to the attachment CR231167748-00A-TSP TEST SETUP PHOTOGRAPHS.

**===== END OF REPORT =====**